



**ALLIED MACHINE
& ENGINEERING**

WOHLHAUPTER®

Holemaking Solutions for Today's Manufacturing



Boring



Reaming



Burnishing



Threading



Specials



4TEX™ Drill

▶ *DRILLING*

Indexable Insert Drilling System

4TEX™ Drill

Indexable Carbide Insert Drilling System

► **Diameter Range:** (12.00mm - 47.00mm (0.472" - 1.850"))



Don't Let Your Machine Slow You Down

The 4TEX indexable carbide drill provides increased penetration rates on light duty machines due to the single effective design. With twisted coolant outlets and increased core strength, the design provides improved hole size and finish.

The 4 sided 4TEX inserts are designed to use 2 sides in the centre pocket and 2 sides in the periphery pocket for an improved cost-per-hole. With insert geometries available for all ISO material classes and a robust body design, the 4TEX is suited for your difficult applications.

Improved hole size and finish	Superior chip evacuation	Increased penetration rates
-------------------------------	--------------------------	-----------------------------

Applicable Industries



Aerospace



Agriculture



Automotive



Firearms



General Machining



Oil & Gas



Renewable Energy

Your safety and the safety of others is very important. This catalogue contains important safety messages. Always read and follow all safety precautions.



This triangle is a safety hazard symbol. It alerts you to potential safety hazards that can cause tool failure and serious injury.

When you see this symbol in the catalogue, look for a related safety message that may be near this triangle or referred to in the nearby text.

There are safety signal words also used in the catalogue. Safety messages follow these words.

WARNING

WARNING (shown above) means that failure to follow the precautions in this message could result in tool failure and serious injury.

NOTICE means that failure to follow the precautions in this message could result in damage to the tool or machine but not result in personal injury.

NOTE and **IMPORTANT** are also used. These are important that you read and follow but are not safety-related.

Visit www.alliedmachine.com for the most up-to-date information and procedures.

Reference Icons

The following icons will appear throughout the catalogue to help you navigate between products.



Setup / Assembly Information

Detailed instructions and information regarding the corresponding part(s)

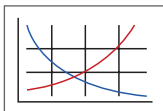

Recommended Cutting Data

Speed and feed recommendations for optimum and safe drilling

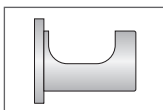

Eccentric Sleeves

Refers to the corresponding eccentric sleeve for the holder

Series	Diameter Range	
	Metric (mm)	Imperial (inch)
03	12.00 - 13.49	0.472 - 0.531
04	13.50 - 15.49	0.532 - 0.610
05	15.50 - 18.49	0.611 - 0.728
06	18.50 - 21.99	0.729 - 0.866
07	22.00 - 26.49	0.867 - 1.043
09	26.50 - 31.99	1.044 - 1.259
11	32.00 - 38.99	1.260 - 1.535
14	39.00 - 47.00	1.536 - 1.850

Introduction Information

Product Overview	2 - 3
Insert Information	4
Product Nomenclature	5

Drill Series

03 Series	6 - 7
04 Series	8 - 9
05 Series	10 - 11
06 Series	12 - 13
07 Series	14 - 15
09 Series	16 - 17
11 Series	18 - 19
14 Series	20 - 21

Adjustment Sleeves	22
------------------------------	----

Technical Information

Diameter Adjustment	23
Centre Height Alignment	24 - 25

Recommended Cutting Data

Metric (mm)	26
Imperial (inch)	27

Insert Geometry Recommendations	28
---	----

Troubleshooting Guide	29
---------------------------------	----



Product Overview

A
DRILLING
B
BORING
C
REAMING
D
BURNISHING
E
THREADING
X
SPECIALS

4TEX Drill *Advantages*

- ✓ **Improved tool holder rigidity and increased reliability**
provided by the stronger core
- ✓ **Superior chip evacuation**
provided by the 2 twisted coolant holes
- ✓ **Improved hole size**
from the stronger core and increased coolant volume
- ✓ **Longer tool life**
provided by the 4-sided insert design
- ✓ **Simplified tooling selection**
with ISO-specific insert geometry/coating combinations
- ✓ **Increased penetration rates**
due to single effective cutting on light duty machines

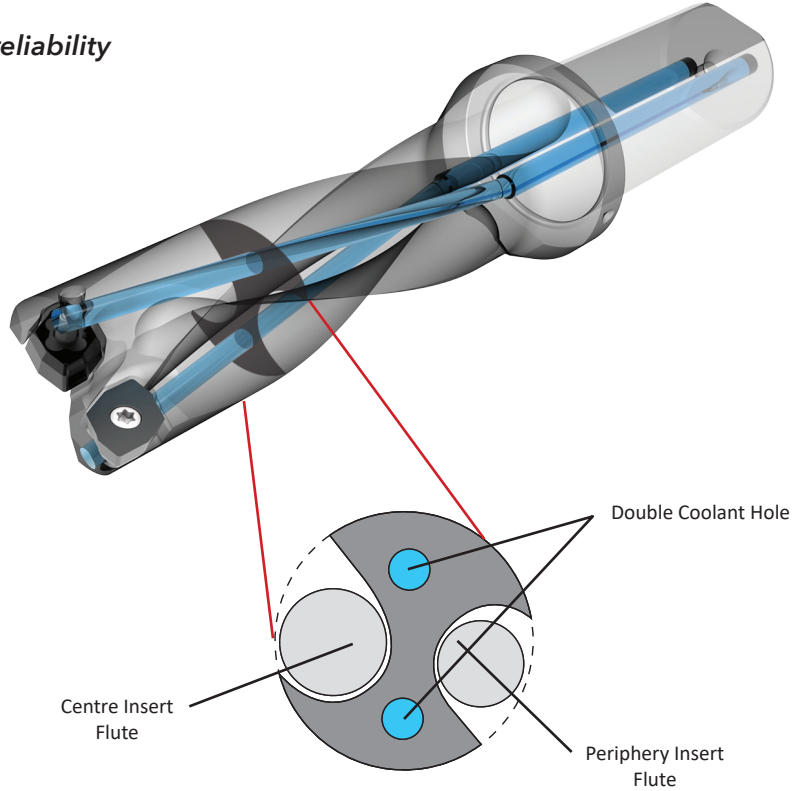

STABLE & EFFICIENT

- The 2 twisted coolant holes allow the core to remain intact, making the core thicker and stronger.
- The dual coolant outlets increase the coolant volume, which improves the chip evacuation and improves the hole size.
- The flute space of the internal cutting edge side (where chips get stuck most often) is 1.6x larger than typical IC drills.

LONGER TOOL LIFE

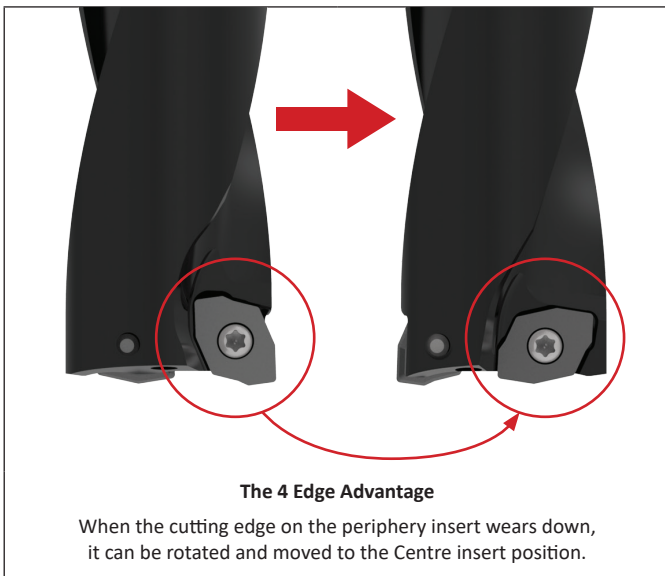

AVAILABLE LENGTHS

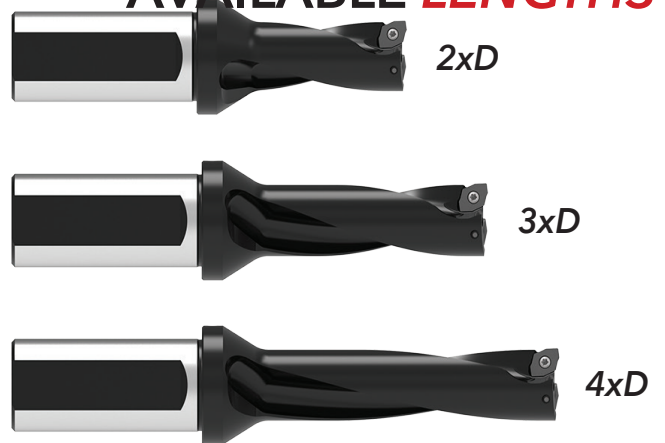

Insert Information

4 CUTTING EDGES

- Each insert has 2 inner cutting edges and 2 outer cutting edges
- Economical solution that increases tool life because of the rotation ability of the inserts
- Available in ISO material-specific geometry/coating combinations

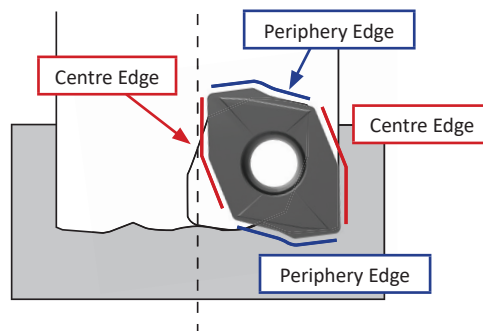

Periphery Insert



Periphery edge chip formation:



Centre Insert

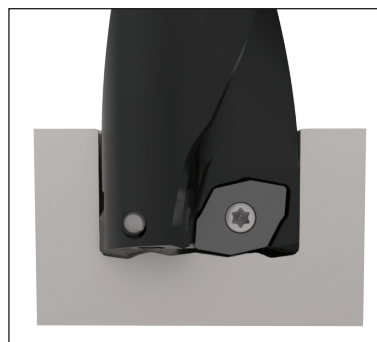

Centre edge chip formation:





180°

ISO Material	Geometry	Coating	Description
P	General Rake	AM480	A general purpose geometry that provides excellent chip formation in most steels including free machining, medium and high carbon steels. A P30 carbide substrate for improved toughness and AM480 coating, a proprietary wear resistant multi-layer PVD coating to improve tool life.
S M	High Rake	AM485	A higher rake geometry that provides excellent chip formation in both stainless steels and high temperature alloys. A tough M25 carbide substrate coated with AM485, a high heat resistance proprietary multi-layer PVD coating.
K	General Rake	AM480	With a general purpose geometry, the K inserts can be used in grey cast irons as well as ductile irons. A high wear resistant K10 carbide substrate to improve tool life and coated with AM480, a proprietary multi-layer PVD coating to improve resistance against tool wear.
H	Low Rake	AM480	A low rake geometry to improve edge strength in both hardened tool steels and high strength alloys. With a P30 carbide substrate for improved toughness and coated with AM480, a proprietary multi-layer PVD coating to improve resistance against tool wear.
N	High Rake	TiCN	A higher rake cutting geometry provides excellent chip formation in non-ferrous materials. An M15/K15 carbide substrate paired with TiCN coating for improved lubricity to resist build-up-material, increasing tool life and maintaining chip formation.

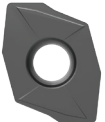

Insert Information

Series	Insert Prefix	Dimension (mm)					Angle		Shape
		L_1	L_2	T	D_1	R	A_1	A_2	
03	4T-030203C-x	5.9	4.8	2.30	2.4	0.3	7°	10°	 Style 1
	4T-030203P-x	6.5	4.8	2.30	2.4	0.3	7°	10°	 Style 2
04	4T-040203-x	6.2	5.1	2.60	2.4	0.3	13°	10°	 Style 3
05	4T-05T203-x	7.3	5.5	2.74	2.5	0.3	13°	7°	
06	4T-06T204-x	8.6	6.4	2.89	2.8	0.4	13°	7°	
07	4T-070305-x	10.2	8.0	3.24	3.0	0.5	13°	7°	
09	4T-09T306-x	12.2	9.6	4.03	3.6	0.6	13°	7°	
11	4T-11T306-x	14.5	11.6	4.06	4.6	0.6	13°	7°	
14	4T-140408-x	18.0	14.4	4.88	5.7	0.8	13°	7°	

Style 1

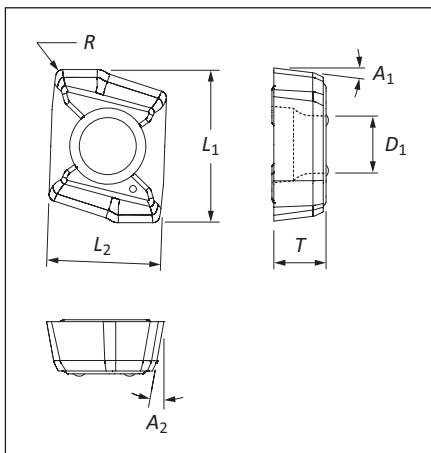

Style 2

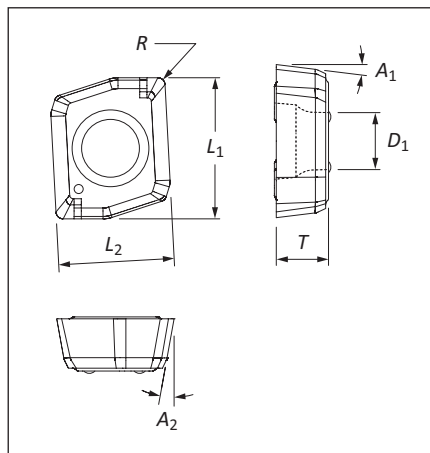

Style 3

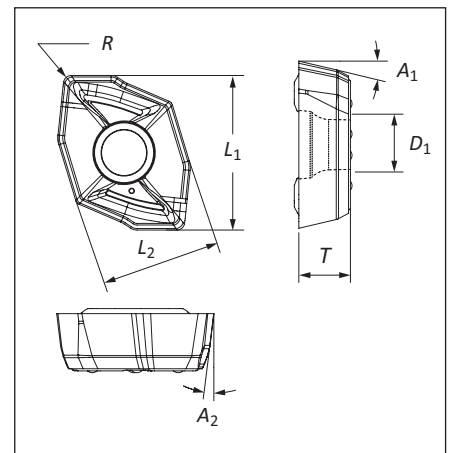

Product Nomenclature

4TEX Drill Holders

D4	03	1200	M	-	20	FM
1	2	3	4		5	6

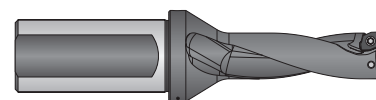

1. Length to Diameter Ratio
D2 = 2xD
D3 = 3xD
D4 = 4xD

2. Series	
03 = 03 series	07 = 07 series
04 = 04 series	09 = 09 series
05 = 05 series	11 = 11 series
06 = 06 series	14 = 14 series

3. Diameter
1200 = 12mm
0750 = .075"

4. Diameter Style
M = Metric
I = Imperial

5. Shank Diameter	
Metric	Imperial
20 = 20mm	075 = .075"
25 = 25mm	100 = 1.000"
32 = 32mm	125 = 1.250"
40 = 40mm	150 = 1.500"

6. Shank Style
FM = Metric flanged shank
F = Imperial flanged shank

Reference Key

Symbol	Attribute
D_1	Drill diameter
D_2	Shank diameter
D_3	Flange diameter
L_1	Assembled overall length
L_2	Drill depth
L_3	Reference length

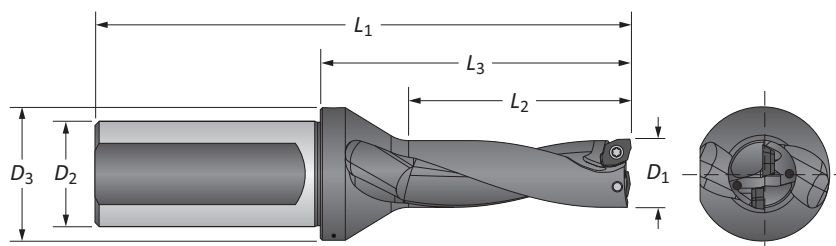

A

DRILLING

B

BORING

C

REAMING

D

BURNISHING

F

THREADING

X

SPECIALS

03

 DRILLING | 4TEX™ Drill: Indexable Insert Drilling System

4TEX Drill Holders | Metric Shank

03 Series | Diameter Range: 12.00mm - 13.49mm (0.472" - 0.531")

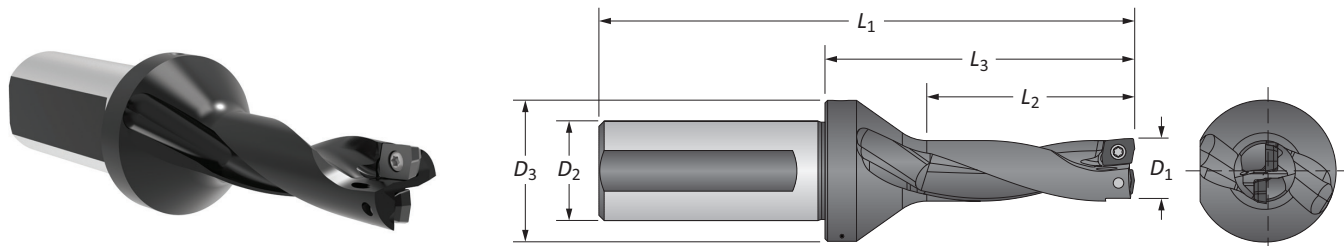

Metric Shank

Length	D ₁	Body			Shank		Max Offset	Part No.
		L ₂	L ₃	L ₁	D ₂	D ₃		
2xD	12.00	24.00	45.40	88.40	20.00	27.00	0.50	D2031200M-20FM
	12.50	25.00	46.40	89.40	20.00	27.00	0.40	D2031250M-20FM
	12.70	25.40	46.40	89.40	20.00	27.00	0.35	D2030500I-20FM
	13.00	26.00	47.40	90.40	20.00	27.00	0.30	D2031300M-20FM
3xD	12.00	36.00	57.40	100.40	20.00	27.00	0.50	D3031200M-20FM
	12.50	37.50	58.90	101.90	20.00	27.00	0.40	D3031250M-20FM
	12.70	38.10	58.90	101.90	20.00	27.00	0.35	D3030500I-20FM
	13.00	39.00	60.40	103.40	20.00	27.00	0.30	D3031300M-20FM
4xD	12.00	48.00	69.40	112.40	20.00	27.00	0.50	D4031200M-20FM
	12.50	50.00	71.40	114.40	20.00	27.00	0.40	D4031250M-20FM
	12.70	50.80	71.40	114.40	20.00	27.00	0.35	D4030500I-20FM
	13.00	52.00	73.40	116.40	20.00	27.00	0.30	D4031300M-20FM

IC Inserts

ISO Material	Style	Part No.	Insert Screw	Torx® Driver	Admissible Tightening Torque
P	Centre	4T-030203C-P	7241-T6-1	8T-6	0.5 N-cm (4.4 in-lbs)
	Periphery	4T-030203P-P			
S M	Centre	4T-030203C-M			
	Periphery	4T-030203P-M			
H	Centre	4T-030203C-H			
	Periphery	4T-030203P-H			
K	Centre	4T-030203C-K			
	Periphery	4T-030203P-K			
N	Centre	4T-030203C-N			
	Periphery	4T-030203P-N			

A55: 26 - 27

A55: 23 - 25

A55: 24

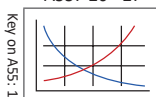

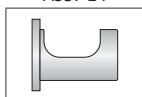

 m = Metric (mm)
 i = Imperial (in)

 IC Inserts sold in quantities of 10
 Insert screws sold in quantities of 10

A55: 6

www.alliedmachine.com | +44 (0) 1384 400 900 | enquiries.eu@alliedmachine.com

A DRILLING

B BORING

C REAMING

D BURNISHING

E THREADING

X SPECIALS

4TEX Drill Holders | Imperial Shank

03 Series | Diameter Range: 12.00mm - 13.49mm (0.472" - 0.531")

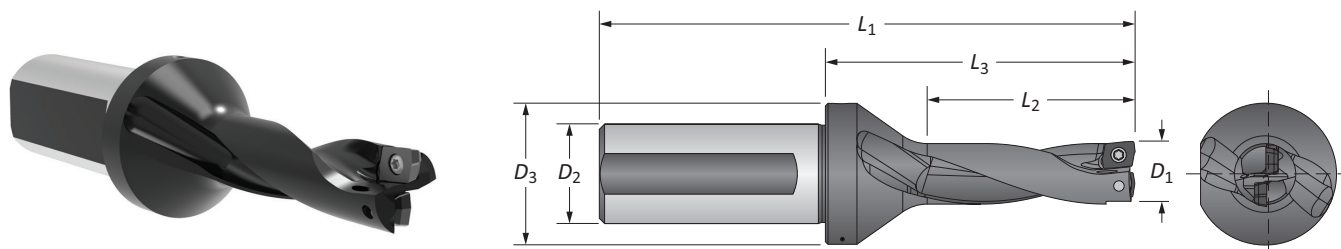

Imperial Shank

Length	D ₁	Body			Shank		Max Offset	Part No.
		L ₂	L ₃	L ₁	D ₂	D ₃		
2xD	0.472	0.945	1.787	3.480	0.750	1.063	0.020	D2031200M-075F
	0.492	0.984	1.827	3.520	0.750	1.063	0.016	D2031250M-075F
	0.500	1.000	1.827	3.520	0.750	1.063	0.014	D2030500I-075F
	0.512	1.024	1.866	3.559	0.750	1.063	0.012	D2031300M-075F
3xD	0.472	1.417	2.260	3.953	0.750	1.063	0.020	D3031200M-075F
	0.492	1.476	2.319	4.012	0.750	1.063	0.016	D3031250M-075F
	0.500	1.500	2.319	4.012	0.750	1.063	0.014	D3030500I-075F
	0.512	1.535	2.378	4.071	0.750	1.063	0.012	D3031300M-075F
4xD	0.472	1.890	2.732	4.425	0.750	1.063	0.020	D4031200M-075F
	0.492	1.969	2.811	4.504	0.750	1.063	0.016	D4031250M-075F
	0.500	2.000	2.811	4.504	0.750	1.063	0.014	D4030500I-075F
	0.512	2.047	2.890	4.583	0.750	1.063	0.012	D4031300M-075F

IC Inserts

ISO Material	Style	Part No.	Insert Screw	Torx® Driver	Admissible Tightening Torque
P	Centre	4T-030203C-P	7241-T6-1	8T-6	0.5 N-cm (4.4 in-lbs)
	Periphery	4T-030203P-P			
S M	Centre	4T-030203C-M			
	Periphery	4T-030203P-M			
H	Centre	4T-030203C-H			
	Periphery	4T-030203P-H			
K	Centre	4T-030203C-K			
	Periphery	4T-030203P-K			
N	Centre	4T-030203C-N			
	Periphery	4T-030203P-N			

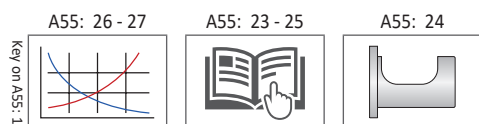

Ⓜ = Metric (mm)
Ⓢ = Imperial (in)

IC Inserts sold in quantities of 10
Insert screws sold in quantities of 10

4TEX Drill Holders | Metric Shank

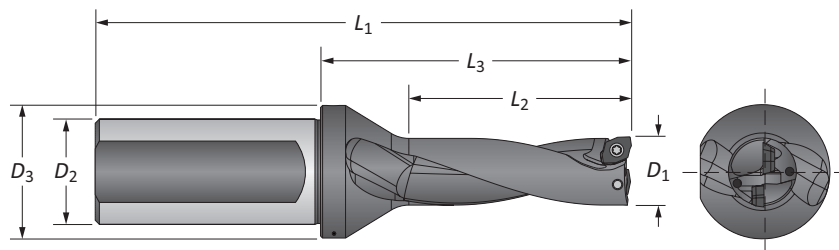
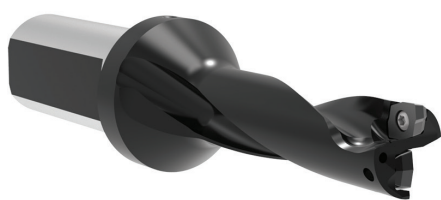

04 Series | Diameter Range: 13.50mm - 15.49mm (0.532" - 0.610")



Metric Shank

Length	D_1	Body			Shank		Max Offset	Part No.
		L_2	L_3	L_1	D_2	D_3		
2xD	13.50	27.00	48.40	91.40	20.00	27.00	0.50	D2041350M-20FM
	14.00	28.00	49.40	92.40	20.00	27.00	0.40	D2041400M-20FM
	14.27	28.55	49.40	92.40	20.00	27.00	0.30	D2040562I-20FM
	14.50	29.00	50.40	93.40	20.00	27.00	0.30	D2041450M-20FM
	15.00	30.00	51.40	94.40	20.00	27.00	0.20	D2041500M-20FM
3xD	13.50	40.50	61.90	104.90	20.00	27.00	0.50	D3041350M-20FM
	14.00	42.00	63.40	106.40	20.00	27.00	0.40	D3041400M-20FM
	14.27	42.82	63.40	106.40	20.00	27.00	0.30	D3040562I-20FM
	14.50	43.50	64.90	107.90	20.00	27.00	0.30	D3041450M-20FM
	15.00	45.00	66.40	109.40	20.00	27.00	0.20	D3041500M-20FM
4xD	13.50	54.00	75.40	118.40	20.00	27.00	0.50	D4041350M-20FM
	14.00	56.00	77.40	120.40	20.00	27.00	0.40	D4041400M-20FM
	14.27	57.10	77.40	120.40	20.00	27.00	0.30	D4040562I-20FM
	14.50	58.00	79.40	122.40	20.00	27.00	0.30	D4041450M-20FM
	15.00	60.00	81.40	124.40	20.00	27.00	0.20	D4041500M-20FM

IC Inserts

ISO Material	Part No.	 Insert Screw	 Torx® Driver	Admissible Tightening Torque
P	4T-040203-P	7241-T6-1	8T-6	0.5 N-cm (4.4 in-lbs)
S M	4T-040203-M			
H	4T-040203-H			
K	4T-040203-K			
N	4T-040203-N			

A55: 26 - 27

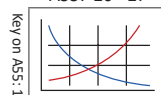

A55: 23 - 25



A55: 24

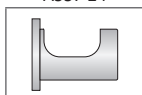

Key on A55: 1

 = Metric (mm)
 = Imperial (in)

IC Inserts sold in quantities of 10
Insert screws sold in quantities of 10

4TEX Drill Holders | Imperial Shank

04 Series | Diameter Range: 13.50mm - 15.49mm (0.532" - 0.610")

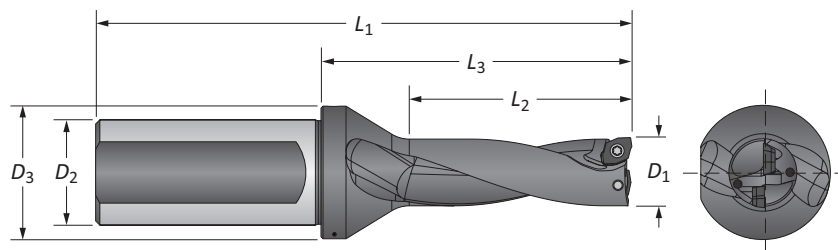

Imperial Shank

Length	D ₁	Body			Shank		Max Offset	Part No.
		L ₂	L ₃	L ₁	D ₂	D ₃		
2xD	0.531	1.063	1.906	3.598	0.750	1.063	0.020	D2041350M-075F
	0.551	1.102	1.945	3.638	0.750	1.063	0.016	D2041400M-075F
	0.562	1.124	1.945	3.638	0.750	1.063	0.013	D2040562I-075F
	0.571	1.142	1.984	3.677	0.750	1.063	0.012	D2041450M-075F
	0.591	1.181	2.024	3.717	0.750	1.063	0.008	D2041500M-075F
3xD	0.531	1.594	2.437	4.130	0.750	1.063	0.020	D3041350M-075F
	0.551	1.654	2.496	4.189	0.750	1.063	0.016	D3041400M-075F
	0.562	1.686	2.496	4.189	0.750	1.063	0.013	D3040562I-075F
	0.571	1.713	2.555	4.248	0.750	1.063	0.012	D3041450M-075F
	0.591	1.772	2.614	4.307	0.750	1.063	0.008	D3041500M-075F
4xD	0.531	2.126	2.969	4.661	0.750	1.063	0.020	D4041350M-075F
	0.551	2.205	3.047	4.740	0.750	1.063	0.016	D4041400M-075F
	0.562	2.248	3.047	4.740	0.750	1.063	0.013	D4040562I-075F
	0.571	2.283	3.126	4.819	0.750	1.063	0.012	D4041450M-075F
	0.591	2.362	3.205	4.898	0.750	1.063	0.008	D4041500M-075F

IC Inserts

ISO Material	Part No.	Insert Screw	Torx® Driver	Admissible Tightening Torque
P	4T-040203-P	7241-T6-1	8T-6	0.5 N-cm (4.4 in-lbs)
S M	4T-040203-M			
H	4T-040203-H			
K	4T-040203-K			
N	4T-040203-N			

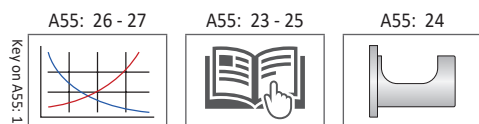

Ⓜ = Metric (mm)
Ⓜ = Imperial (in)

IC Inserts sold in quantities of 10
Insert screws sold in quantities of 10

4TEX Drill Holders | Metric Shank

05 Series | Diameter Range: 15.50mm - 18.49mm (0.611" - 0.728")

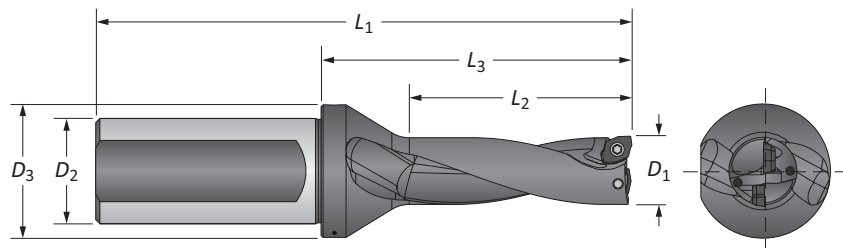
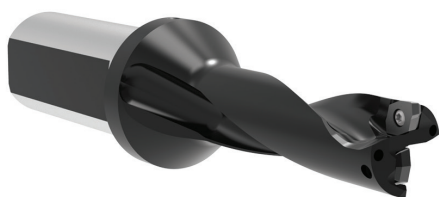

Metric Shank

Length	Body				Shank		Max Offset	Part No.
	D ₁	L ₂	L ₃	L ₁	D ₂	D ₃		
2xD	15.50	31.00	54.50	108.50	25.00	32.00	0.80	D2051550M-25FM
	15.87	31.75	54.50	108.50	25.00	32.00	0.70	D2050625I-25FM
	16.00	32.00	55.50	109.50	25.00	32.00	0.70	D2051600M-25FM
	16.50	33.00	56.50	110.50	25.00	32.00	0.50	D2051650M-25FM
	17.00	34.00	57.50	111.50	25.00	32.00	0.40	D2051700M-25FM
	17.45	34.90	57.50	111.50	25.00	32.00	0.30	D2050687I-25FM
	17.50	35.00	58.50	112.50	25.00	32.00	0.30	D2051750M-25FM
	18.00	36.00	59.50	113.50	25.00	32.00	0.20	D2051800M-25FM
3xD	18.24	36.47	59.51	113.51	25.00	32.00	0.15	D2050718I-25FM
	15.50	46.50	70.00	124.00	25.00	32.00	0.80	D3051550M-25FM
	15.87	47.63	70.00	124.00	25.00	32.00	0.70	D3050625I-25FM
	16.00	48.00	71.50	125.50	25.00	32.00	0.70	D3051600M-25FM
	16.50	49.50	73.00	127.00	25.00	32.00	0.50	D3051650M-25FM
	17.00	51.00	74.50	128.50	25.00	32.00	0.40	D3051700M-25FM
	17.45	52.35	74.50	128.50	25.00	32.00	0.30	D3050687I-25FM
	17.50	52.50	76.00	130.00	25.00	32.00	0.30	D3051750M-25FM
4xD	18.00	54.00	77.50	131.50	25.00	32.00	0.20	D3051800M-25FM
	18.24	54.71	77.50	131.50	58.00	32.00	0.15	D3050718I-25FM
	15.50	62.00	85.50	139.50	25.00	32.00	0.80	D4051550M-25FM
	15.87	63.50	85.50	139.50	25.00	32.00	0.70	D4050625I-25FM
	16.00	64.00	87.50	141.50	25.00	32.00	0.70	D4051600M-25FM
	16.50	66.00	89.50	143.50	25.00	32.00	0.50	D4051650M-25FM
	17.00	68.00	91.50	145.50	25.00	32.00	0.40	D4051700M-25FM
	17.45	69.80	91.50	145.50	25.00	32.00	0.30	D4050687I-25FM
4xD	17.50	70.00	93.50	147.50	25.00	32.00	0.30	D4051750M-25FM
	18.00	72.00	95.50	149.50	25.00	32.00	0.20	D4051800M-25FM
	18.24	72.95	95.50	149.50	25.00	32.00	0.15	D4050718I-25FM

IC Inserts

ISO Material	Part No.	Insert Screw	Torx® Driver	Admissible Tightening Torque
P	4T-05T203-P	7243-T6-1	8T-6	0.5 N-cm (4.4 in-lbs)
S M	4T-05T203-M			
H	4T-05T203-H			
K	4T-05T203-K			
N	4T-05T203-N			

A55: 26 - 27

A55: 23 - 25

A55: 24

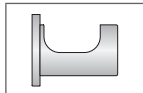
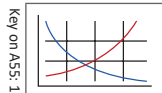

Ⓜ = Metric (mm)

Ⓢ = Imperial (in)

IC Inserts sold in quantities of 10
Insert screws sold in quantities of 10

4TEX Drill Holders | Imperial Shank

05 Series | Diameter Range: 15.50mm - 18.49mm (0.611" - 0.728")

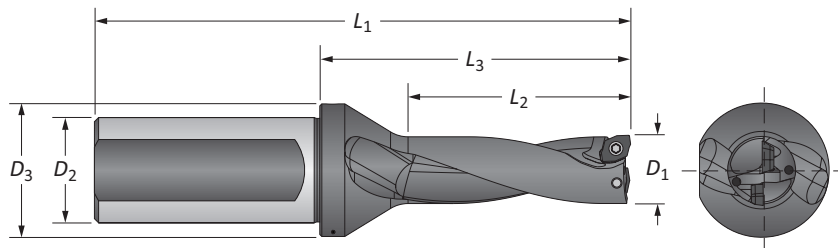
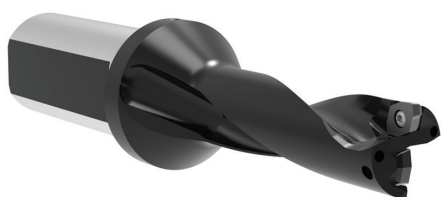

Imperial Shank

Length	Body				Shank		Max Offset	Part No.
	D ₁	L ₂	L ₃	L ₁	D ₂	D ₃		
2xD	0.610	1.220	2.146	4.272	1.000	1.260	0.031	D2051550M-100F
	0.625	1.250	2.146	4.272	1.000	1.260	0.029	D2050625I-100F
	0.630	1.260	2.185	4.311	1.000	1.260	0.028	D2051600M-100F
	0.650	1.299	2.224	4.350	1.000	1.260	0.020	D2051650M-100F
	0.669	1.339	2.264	4.390	1.000	1.260	0.016	D2051700M-100F
	0.687	1.374	2.264	4.390	1.000	1.260	0.012	D2050687I-100F
	0.689	1.378	2.303	4.429	1.000	1.260	0.012	D2051750M-100F
	0.709	1.417	2.343	4.469	1.000	1.260	0.008	D2051800M-100F
3xD	0.718	1.436	2.343	4.469	1.000	1.260	0.006	D2050718I-100F
	0.610	1.831	2.756	4.882	1.000	1.260	0.031	D3051550M-100F
	0.625	1.875	2.756	4.882	1.000	1.260	0.029	D3050625I-100F
	0.630	1.890	2.815	4.941	1.000	1.260	0.028	D3051600M-100F
	0.650	1.949	2.874	5.000	1.000	1.260	0.020	D3051650M-100F
	0.669	2.008	2.933	5.059	1.000	1.260	0.016	D3051700M-100F
	0.687	2.061	2.933	5.059	1.000	1.260	0.012	D3050687I-100F
	0.689	2.067	2.992	5.118	1.000	1.260	0.012	D3051750M-100F
4xD	0.709	2.126	3.051	5.177	1.000	1.260	0.008	D3051800M-100F
	0.718	2.154	3.051	5.177	1.000	1.260	0.006	D3050718I-100F
	0.610	2.441	3.366	5.492	1.000	1.260	0.031	D4051550M-100F
	0.625	2.500	3.366	5.492	1.000	1.260	0.029	D4050625I-100F
	0.630	2.520	3.445	5.571	1.000	1.260	0.028	D4051600M-100F
	0.650	2.598	3.524	5.650	1.000	1.260	0.020	D4051650M-100F
	0.669	2.677	3.602	5.728	1.000	1.260	0.016	D4051700M-100F
	0.687	2.748	3.602	5.728	1.000	1.260	0.012	D4050687I-100F
	0.689	2.756	3.681	5.807	1.000	1.260	0.012	D4051750M-100F
	0.709	2.835	3.760	5.886	1.000	1.260	0.008	D4051800M-100F
	0.718	2.872	3.760	5.886	1.000	1.260	0.006	D4050718I-100F

IC Inserts

ISO Material	Part No.	Insert Screw	Torx® Driver	Admissible Tightening Torque
P	4T-05T203-P	7243-T6-1	8T-6	0.5 N-cm (4.4 in-lbs)
S	4T-05T203-M			
H	4T-05T203-H			
K	4T-05T203-K			
N	4T-05T203-N			

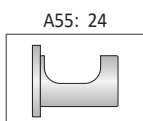
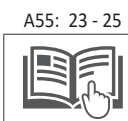
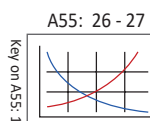

Ⓜ = Metric (mm)
 ⓘ = Imperial (in)

IC Inserts sold in quantities of 10
 Insert screws sold in quantities of 10

A DRILLING
 B BORING
 C REAMING
 D BURNISHING
 E THREADING
 X SPECIALS

06

 DRILLING | 4TEX™ Drill: Indexable Insert Drilling System

4TEX Drill Holders | Metric Shank

06 Series | Diameter Range: 18.50mm - 21.99mm (0.729" - 0.866")

Metric Shank

Length	D_1	Body			Shank		Max Offset	Part No.
		L_2	L_3	L_1	D_2	D_3		
2xD	18.50	37.00	58.40	112.40	25.00	32.00	0.90	D2061850M-25FM
	19.00	38.00	59.40	113.40	25.00	32.00	0.80	D2061900M-25FM
	19.05	38.10	59.40	113.40	25.00	32.00	0.80	D2060750I-25FM
	19.50	39.00	60.40	114.40	25.00	32.00	0.70	D2061950M-25FM
	20.00	40.00	61.40	115.40	25.00	32.00	0.50	D2062000M-25FM
	20.50	41.00	62.40	116.40	25.00	32.00	0.40	D2062050M-25FM
	20.62	41.25	62.40	116.40	25.00	32.00	0.40	D2060812I-25FM
	21.00	42.00	63.40	117.40	25.00	32.00	0.30	D2062100M-25FM
3xD	21.50	43.00	64.40	118.40	25.00	32.00	0.20	D2062150M-25FM
	18.50	55.00	76.90	130.90	25.00	32.00	0.90	D3061850M-25FM
	19.00	57.00	78.40	132.40	25.00	32.00	0.80	D3061900M-25FM
	19.05	57.15	78.40	132.40	25.00	32.00	0.80	D3060750I-25FM
	19.50	58.50	79.90	133.90	25.00	32.00	0.70	D3061950M-25FM
	20.00	60.00	81.40	135.40	25.00	32.00	0.50	D3062000M-25FM
	20.50	61.50	82.90	136.90	25.00	32.00	0.40	D3062050M-25FM
	20.62	61.87	82.90	136.90	25.00	32.00	0.40	D3060812I-25FM
4xD	21.00	63.00	84.40	138.40	25.00	32.00	0.30	D3062100M-25FM
	21.50	64.50	85.90	139.90	25.00	32.00	0.20	D3062150M-25FM
	18.50	74.00	95.40	149.40	25.00	32.00	0.90	D4061850M-25FM
	19.00	76.00	97.40	151.40	25.00	32.00	0.80	D4061900M-25FM
	19.05	76.20	97.40	151.40	25.00	32.00	0.80	D4060750I-25FM
	19.50	78.00	99.40	153.40	25.00	32.00	0.70	D4061950M-25FM
	20.00	80.00	101.40	155.40	25.00	32.00	0.50	D4062000M-25FM
	20.50	82.00	103.40	157.40	25.00	32.00	0.40	D4062050M-25FM
4xD	20.62	82.49	103.40	157.40	25.00	32.00	0.40	D4060812I-25FM
	21.00	84.00	105.40	159.40	25.00	32.00	0.30	D4062100M-25FM
	21.50	86.00	107.40	161.40	25.00	32.00	0.20	D4062150M-25FM

IC Inserts

ISO Material	Part No.	Insert Screw	Torx® Driver	Admissible Tightening Torque
P	4T-06T204-P	72251-T7-1	8T-7	0.8 N-cm (7.1 in-lbs)
S	4T-06T204-M			
H	4T-06T204-H			
K	4T-06T204-K			
N	4T-06T204-N			

 A55: 26 - 27

 A55: 23 - 25

 A55: 24

 m = Metric (mm)
 i = Imperial (in)

 IC Inserts sold in quantities of 10
 Insert screws sold in quantities of 10

A55: 12

www.alliedmachine.com | +44 (0) 1384 400 900 | enquiries.eu@alliedmachine.com

A

DRILLING

B

BORING

C

REAMING

D

BURNISHING

E

THREADING

X

SPECIALS

4TEX Drill Holders | Imperial Shank

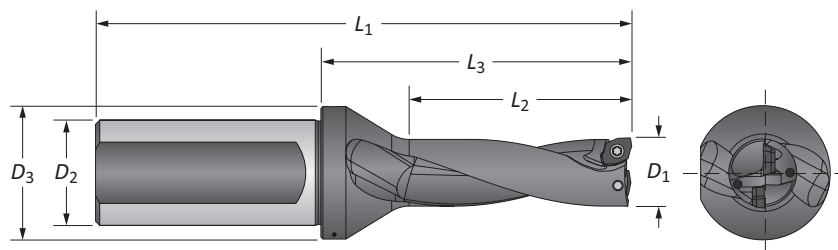
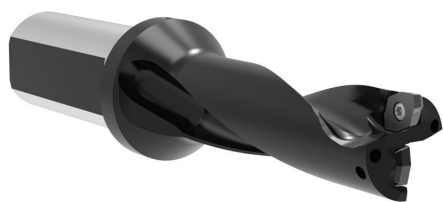

06 Series | Diameter Range: 18.50mm - 21.99mm (0.729" - 0.866")



Imperial Shank

Length	D ₁	Body			Shank		Max Offset	Part No.
		L ₂	L ₃	L ₁	D ₂	D ₃		
2xD	0.728	1.457	2.299	4.425	1.000	1.260	0.035	D2061850M-100F
	0.748	1.496	2.339	4.465	1.000	1.260	0.031	D2061900M-100F
	0.750	1.500	2.339	4.465	1.000	1.260	0.031	D2060750I-100F
	0.768	1.535	2.378	4.504	1.000	1.260	0.028	D2061950M-100F
	0.787	1.575	2.417	4.543	1.000	1.260	0.020	D2062000M-100F
	0.807	1.614	2.457	4.583	1.000	1.260	0.016	D2062050M-100F
	0.812	1.624	2.457	4.583	1.000	1.260	0.015	D2060812I-100F
	0.827	1.654	2.496	4.622	1.000	1.260	0.012	D2062100M-100F
3xD	0.846	1.693	2.535	4.661	1.000	1.260	0.008	D2062150M-100F
	0.728	2.165	3.028	5.154	1.000	1.260	0.035	D3061850M-100F
	0.748	2.244	3.087	5.213	1.000	1.260	0.031	D3061900M-100F
	0.750	2.250	3.087	5.213	1.000	1.260	0.031	D3060750I-100F
	0.768	2.303	3.146	5.272	1.000	1.260	0.028	D3061950M-100F
	0.787	2.362	3.205	5.331	1.000	1.260	0.020	D3062000M-100F
	0.807	2.421	3.264	5.390	1.000	1.260	0.016	D3062050M-100F
	0.812	2.436	3.264	5.390	1.000	1.260	0.015	D3060812I-100F
4xD	0.827	2.480	3.323	5.449	1.000	1.260	0.012	D3062100M-100F
	0.846	2.539	3.382	5.508	1.000	1.260	0.008	D3062150M-100F
	0.728	2.913	3.756	5.882	1.000	1.260	0.035	D4061850M-100F
	0.748	2.992	3.835	5.961	1.000	1.260	0.031	D4061900M-100F
	0.750	3.000	3.835	5.961	1.000	1.260	0.031	D4060750I-100F
	0.768	3.071	3.913	6.039	1.000	1.260	0.028	D4061950M-100F
	0.787	3.150	3.992	6.118	1.000	1.260	0.020	D4062000M-100F
	0.807	3.228	4.071	6.197	1.000	1.260	0.016	D4062050M-100F
	0.812	3.248	4.071	6.197	1.000	1.260	0.015	D4060812I-100F
	0.827	3.307	4.150	6.276	1.000	1.260	0.012	D4062100M-100F
	0.846	3.386	4.228	6.354	1.000	1.260	0.008	D4062150M-100F

IC Inserts

ISO Material	Part No.	 Insert Screw	 Torx® Driver	Admissible Tightening Torque
P	4T-06T204-P	72251-T7-1	8T-7	0.8 N-cm (7.1 in-lbs)
S M	4T-06T204-M			
H	4T-06T204-H			
K	4T-06T204-K			
N	4T-06T204-N			

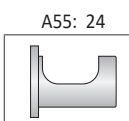
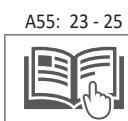
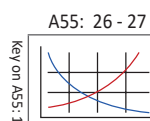

 = Metric (mm)
 = Imperial (in)

IC Inserts sold in quantities of 10
 Insert screws sold in quantities of 10

07

 DRILLING | 4TEX™ Drill: Indexable Insert Drilling System



4TEX Drill Holders | Metric Shank

07 Series | Diameter Range: 22.00mm - 26.49mm (0.867" - 1.043")

Metric Shank

Length	Body				Shank		Max Offset	Part No.
	D_1	L_2	L_3	L_1	D_2	D_3		
2xD	22.00	44.00	64.90	118.90	25.00	33.00	1.20	D2072200M-25FM
	22.23	44.45	64.90	118.90	25.00	33.00	1.10	D2070875I-25FM
	22.50	45.00	65.90	119.90	25.00	33.00	1.00	D2072250M-25FM
	23.00	46.00	66.90	120.90	25.00	33.00	0.90	D2072300M-25FM
	23.50	47.00	67.90	121.90	25.00	33.00	0.80	D2072350M-25FM
	23.80	47.60	67.90	121.90	25.00	33.00	7.40	D2070937I-25FM
	24.00	48.00	68.90	122.90	25.00	33.00	0.70	D2072400M-25FM
	24.50	49.00	69.90	123.90	25.00	33.00	0.50	D2072450M-25FM
	25.00	50.00	70.90	124.90	25.00	33.00	0.40	D2072500M-25FM
	25.40	50.80	70.90	124.90	25.00	33.00	0.30	D2071000I-25FM
25.50	51.00	71.90	125.90	25.00	33.00	0.30	D2072550M-25FM	
26.00	52.00	72.90	126.90	25.00	33.00	0.20	D2072600M-25FM	
3xD	22.00	66.00	86.90	140.90	25.00	33.00	1.20	D3072200M-25FM
	22.23	66.68	86.90	140.90	25.00	33.00	1.10	D3070875I-25FM
	22.50	67.50	88.40	142.40	25.00	33.00	1.00	D3072250M-25FM
	23.00	69.00	89.90	143.90	25.00	33.00	0.90	D3072300M-25FM
	23.50	70.50	91.40	145.40	25.00	33.00	0.80	D3072350M-25FM
	23.80	71.40	91.40	145.40	25.00	33.00	7.40	D3070937I-25FM
	24.00	72.00	92.90	146.90	25.00	33.00	0.70	D3072400M-25FM
	24.50	73.50	94.40	148.40	25.00	33.00	0.50	D3072450M-25FM
	25.00	75.00	95.90	149.90	25.00	33.00	0.40	D3072500M-25FM
	25.40	76.20	95.90	149.90	25.00	33.00	0.30	D3071000I-25FM
25.50	76.50	97.00	151.00	25.00	33.00	0.30	D3072550M-25FM	
26.00	78.00	99.00	153.00	25.00	33.00	0.20	D3072600M-25FM	
4xD	22.00	88.00	109.00	163.00	25.00	33.00	1.20	D4072200M-25FM
	22.23	88.90	108.90	162.90	25.00	33.00	1.10	D4070875I-25FM
	22.50	90.00	111.00	165.00	25.00	33.00	1.00	D4072250M-25FM
	23.00	92.00	113.00	167.00	25.00	33.00	0.90	D4072300M-25FM
	23.50	94.00	115.00	169.00	25.00	33.00	0.80	D4072350M-25FM
	23.80	95.20	114.90	168.90	25.00	33.00	7.40	D4070937I-25FM
	24.00	96.00	117.00	171.00	25.00	33.00	0.70	D4072400M-25FM
	24.50	98.00	119.00	173.00	25.00	33.00	0.50	D4072450M-25FM
	25.00	100.00	121.00	175.00	25.00	33.00	0.40	D4072500M-25FM
	25.40	101.60	120.90	174.90	25.00	33.00	0.30	D4071000I-25FM
25.50	102.00	123.00	177.00	25.00	33.00	0.30	D4072550M-25FM	
26.00	104.00	125.00	179.00	25.00	33.00	0.20	D4072600M-25FM	

IC Inserts

ISO Material	Part No.	 Insert Screw	 Torx® Driver	Admissible Tightening Torque
P	4T-070305-P	72568-T8-1	8T-8	1.2 N-cm (10.6 in-lbs)
S M	4T-070305-M			
H	4T-070305-H			
K	4T-070305-K			
N	4T-070305-N			

A55: 26 - 27

A55: 23 - 25

A55: 24

 = Metric (mm)

 = Imperial (in)

IC Inserts sold in quantities of 10
Insert screws sold in quantities of 10

A55: 14

www.alliedmachine.com | +44 (0) 1384 400 900 | enquiries.eu@alliedmachine.com

A

DRILLING

B

BORING

C

REAMING

D

BURNISHING

E

THREADING

X

SPECIALS

4TEX Drill Holders | Imperial Shank

07 Series | Diameter Range: 22.00mm - 26.49mm (0.867" - 1.043")

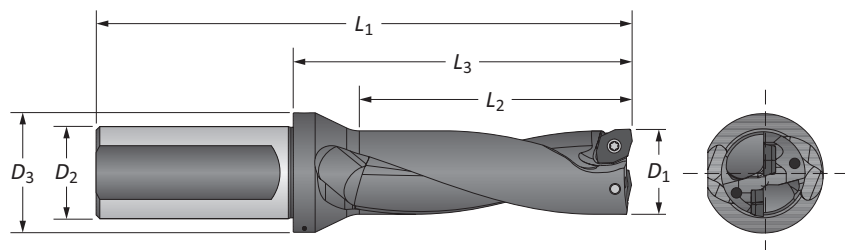
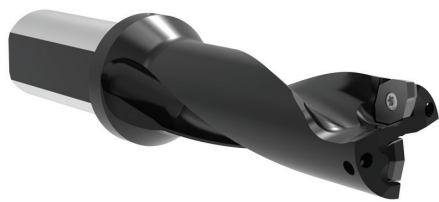

Imperial Shank

Length	Body				Shank		Max Offset	Part No.
	D ₁	L ₂	L ₃	L ₁	D ₂	D ₃		
2xD	0.866	1.732	2.555	4.681	1.000	1.299	0.047	D2072200M-100F
	0.875	1.750	2.555	4.681	1.000	1.299	0.043	D2070875I-100F
	0.886	1.772	2.594	4.720	1.000	1.299	0.039	D2072250M-100F
	0.906	1.811	2.634	4.760	1.000	1.299	0.035	D2072300M-100F
	0.925	1.850	2.673	4.799	1.000	1.299	0.031	D2072350M-100F
	0.937	1.874	2.673	4.799	1.000	1.299	0.292	D2070937I-100F
	0.945	1.890	2.713	4.839	1.000	1.299	0.028	D2072400M-100F
	0.965	1.929	2.752	4.878	1.000	1.299	0.020	D2072450M-100F
	0.984	1.969	2.791	4.917	1.000	1.299	0.016	D2072500M-100F
	1.000	2.000	2.791	4.917	1.000	1.299	0.013	D2071000I-100F
1.004	2.008	2.831	4.957	1.000	1.299	0.012	D2072550M-100F	
1.024	2.047	2.870	4.996	1.000	1.299	0.008	D2072600M-100F	
3xD	0.866	2.598	3.421	5.547	1.000	1.299	0.047	D3072200M-100F
	0.875	2.625	3.421	5.547	1.000	1.299	0.043	D3070875I-100F
	0.886	2.657	3.480	5.606	1.000	1.299	0.039	D3072250M-100F
	0.906	2.717	3.539	5.665	1.000	1.299	0.035	D3072300M-100F
	0.925	2.776	3.598	5.724	1.000	1.299	0.031	D3072350M-100F
	0.937	2.811	3.598	5.724	1.000	1.299	0.292	D3070937I-100F
	0.945	2.835	3.657	5.783	1.000	1.299	0.028	D3072400M-100F
	0.965	2.894	3.717	5.843	1.000	1.299	0.020	D3072450M-100F
	0.984	2.953	3.776	5.902	1.000	1.299	0.016	D3072500M-100F
	1.000	3.000	3.776	5.902	1.000	1.299	0.013	D3071000I-100F
1.004	3.012	3.835	5.961	1.000	1.299	0.012	D3072550M-100F	
1.024	3.071	3.894	6.020	1.000	1.299	0.008	D3072600M-100F	
4xD	0.866	3.465	4.287	6.413	1.000	1.299	0.047	D4072200M-100F
	0.875	3.500	4.287	6.413	1.000	1.299	0.043	D4070875I-100F
	0.886	3.543	4.366	6.492	1.000	1.299	0.039	D4072250M-100F
	0.906	3.622	4.445	6.571	1.000	1.299	0.035	D4072300M-100F
	0.925	3.701	4.524	6.650	1.000	1.299	0.031	D4072350M-100F
	0.937	3.748	4.524	6.650	1.000	1.299	0.292	D4070937I-100F
	0.945	3.780	4.602	6.728	1.000	1.299	0.028	D4072400M-100F
	0.965	3.858	4.681	6.807	1.000	1.299	0.020	D4072450M-100F
	0.984	3.937	4.760	6.886	1.000	1.299	0.016	D4072500M-100F
	1.000	4.000	4.760	6.886	1.000	1.299	0.013	D4071000I-100F
1.004	4.016	4.839	6.965	1.000	1.299	0.012	D4072550M-100F	
1.024	4.094	4.917	7.043	1.000	1.299	0.008	D4072600M-100F	

IC Inserts

ISO Material	Part No.	Insert Screw	Torx® Driver	Admissible Tightening Torque
P	4T-070305-P	72568-T8-1	8T-8	1.2 N-cm (10.6 in-lbs)
S	4T-070305-M			
H	4T-070305-H			
K	4T-070305-K			
N	4T-070305-N			

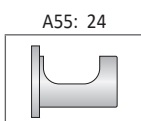
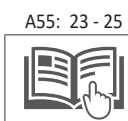
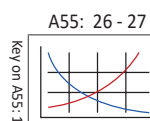

Ⓜ = Metric (mm)
Ⓢ = Imperial (in)

IC Inserts sold in quantities of 10
Insert screws sold in quantities of 10

4TEX Drill Holders | Metric Shank

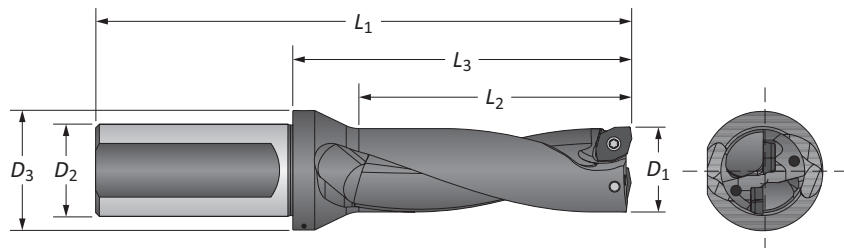
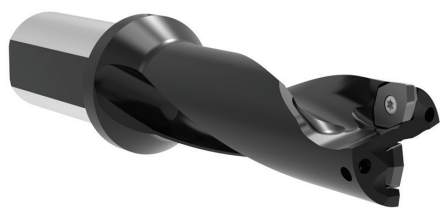

09 Series | Diameter Range: 26.50mm - 31.99mm (1.044" - 1.259")



Metric Shank

Length	D_1	Body			Shank		Max Offset	Part No.
		L_2	L_3	L_1	D_2	D_3		
2xD	27.00	54.00	76.70	135.70	32.00	41.00	1.60	D2092700M-32FM
	28.00	56.00	78.70	137.70	32.00	41.00	1.30	D2092800M-32FM
	28.56	57.15	79.70	138.70	32.00	41.00	1.20	D2091125I-32FM
	29.00	58.00	80.70	139.70	32.00	41.00	1.10	D2092900M-32FM
	30.00	60.00	82.70	141.70	32.00	43.00	0.80	D2093000M-32FM
	31.00	62.00	84.70	143.70	32.00	43.00	0.60	D2093100M-32FM
	31.75	63.50	85.70	144.70	32.00	43.00	0.50	D2091250I-32FM
3xD	27.00	81.00	103.70	162.70	32.00	41.00	1.60	D3092700M-32FM
	28.00	84.00	106.70	165.70	32.00	41.00	1.30	D3092800M-32FM
	28.56	85.73	108.20	167.20	32.00	41.00	1.20	D3091125I-32FM
	29.00	87.00	109.70	168.70	32.00	41.00	1.10	D3092900M-32FM
	30.00	90.00	112.70	171.70	32.00	43.00	0.80	D3093000M-32FM
	31.00	93.00	115.70	174.70	32.00	43.00	0.60	D3093100M-32FM
	31.75	95.25	117.20	176.20	32.00	43.00	0.50	D3091250I-32FM
4xD	27.00	108.00	130.70	189.70	32.00	41.00	1.60	D4092700M-32FM
	28.00	112.00	134.70	193.70	32.00	41.00	1.30	D4092800M-32FM
	28.56	114.30	136.70	195.70	32.00	41.00	1.20	D4091125I-32FM
	29.00	116.00	138.70	197.70	32.00	41.00	1.10	D4092900M-32FM
	30.00	120.00	142.70	201.70	32.00	43.00	0.80	D4093000M-32FM
	31.00	124.00	146.70	205.70	32.00	43.00	0.60	D4093100M-32FM
	31.75	127.00	148.70	207.70	32.00	43.00	0.50	D4091250I-32FM

IC Inserts

ISO Material	Part No.	 Insert Screw	 Torx® Driver	Admissible Tightening Torque
P	4T-09T306-P	738-T10-1	8T-10	2.0 N-cm (17.7 in-lbs)
S	4T-09T306-M			
H	4T-09T306-H			
K	4T-09T306-K			
N	4T-09T306-N			

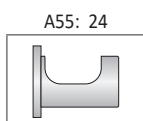
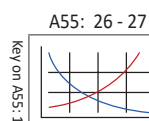

 = Metric (mm)
 = Imperial (in)

IC Inserts sold in quantities of 10
 Insert screws sold in quantities of 10

4TEX Drill Holders | Imperial Shank

09 Series | Diameter Range: 26.50mm - 31.99mm (1.044" - 1.259")

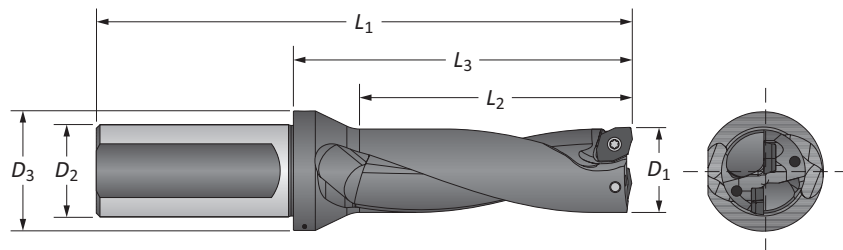
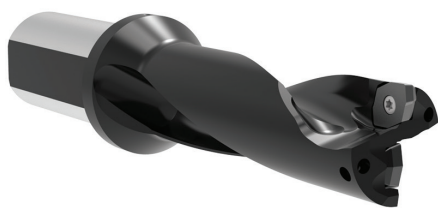

Imperial Shank

Length	D ₁	Body			Shank		Max Offset	Part No.
		L ₂	L ₃	L ₁	D ₂	D ₃		
2xD	1.063	2.126	3.020	5.343	1.250	1.614	0.063	D2092700M-125F
	1.102	2.205	3.098	5.421	1.250	1.614	0.051	D2092800M-125F
	1.125	2.250	3.138	5.461	1.250	1.614	0.046	D2091125I-125F
	1.142	2.283	3.177	5.500	1.250	1.614	0.043	D2092900M-125F
	1.181	2.362	3.256	5.579	1.250	1.693	0.031	D2093000M-125F
	1.220	2.441	3.335	5.657	1.250	1.693	0.024	D2093100M-125F
	1.250	2.500	3.374	5.697	1.250	1.693	0.019	D2091250I-125F
3xD	1.063	3.189	4.083	6.406	1.250	1.614	0.063	D3092700M-125F
	1.102	3.307	4.201	6.524	1.250	1.614	0.051	D3092800M-125F
	1.125	3.375	4.260	6.583	1.250	1.614	0.046	D3091125I-125F
	1.142	3.425	4.319	6.642	1.250	1.614	0.043	D3092900M-125F
	1.181	3.543	4.437	6.760	1.250	1.693	0.031	D3093000M-125F
	1.220	3.661	4.555	6.878	1.250	1.693	0.024	D3093100M-125F
	1.250	3.750	4.614	6.937	1.250	1.693	0.019	D3091250I-125F
4xD	1.063	4.252	5.146	7.469	1.250	1.614	0.063	D4092700M-125F
	1.102	4.409	5.303	7.626	1.250	1.614	0.051	D4092800M-125F
	1.125	4.500	5.382	7.705	1.250	1.614	0.046	D4091125I-125F
	1.142	4.567	5.461	7.783	1.250	1.614	0.043	D4092900M-125F
	1.181	4.724	5.618	7.941	1.250	1.693	0.031	D4093000M-125F
	1.220	4.882	5.776	8.098	1.250	1.693	0.024	D4093100M-125F
	1.250	5.000	5.854	8.177	1.250	1.693	0.019	D4091250I-125F

IC Inserts

ISO Material	Part No.	Insert Screw	Torx® Driver	Admissible Tightening Torque
P	4T-09T306-P	738-T10-1	8T-10	2.0 N-cm h(17.7 in-lbs)
S M	4T-09T306-M			
H	4T-09T306-H			
K	4T-09T306-K			
N	4T-09T306-N			

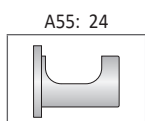
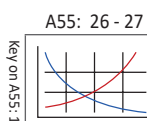

Ⓜ = Metric (mm)
Ⓢ = Imperial (in)

IC Inserts sold in quantities of 10
Insert screws sold in quantities of 10

11

 DRILLING | 4TEX™ Drill: Indexable Insert Drilling System

4TEX Drill Holders | Metric Shank

11 Series | Diameter Range: 32.00mm - 38.99mm (1.260" - 1.535")

Metric Shank

Length	Body				Shank		Max Offset	Part No.
	D_1	L_2	L_3	L_1	D_2	D_3		
2xD	32.00	64.00	100.40	169.40	40.00	54.00	2.20	D2113200M-40FM
	33.00	66.00	102.40	171.40	40.00	54.00	1.90	D2113300M-40FM
	34.00	68.00	104.40	173.40	40.00	54.00	1.70	D2113400M-40FM
	34.93	69.85	104.40	173.40	40.00	54.00	1.42	D2111375I-40FM
	35.00	70.00	106.40	175.40	40.00	54.00	1.40	D2113500M-40FM
	36.00	72.00	108.40	177.40	40.00	54.00	1.20	D2113600M-40FM
	37.00	74.00	110.40	179.40	40.00	54.00	0.90	D2113700M-40FM
	38.00	76.00	112.40	181.40	40.00	54.00	0.70	D2113800M-40FM
3xD	38.10	76.20	112.40	181.40	40.00	54.00	0.69	D2111500I-40FM
	32.00	96.00	132.40	201.40	40.00	54.00	2.20	D3113200M-40FM
	33.00	99.00	135.40	204.40	40.00	54.00	1.90	D3113300M-40FM
	34.00	102.00	138.40	207.40	40.00	54.00	1.70	D3113400M-40FM
	34.93	104.78	138.40	207.40	40.00	54.00	1.42	D3111375I-40FM
	35.00	105.00	141.40	210.40	40.00	54.00	1.40	D3113500M-40FM
	36.00	108.00	144.40	213.40	40.00	54.00	1.20	D3113600M-40FM
	37.00	111.00	147.40	216.40	40.00	54.00	0.90	D3113700M-40FM
4xD	38.00	114.00	150.40	219.40	40.00	54.00	0.70	D3113800M-40FM
	38.10	114.30	150.40	219.40	40.00	54.00	0.69	D3111500I-40FM
	32.00	128.00	154.40	223.40	40.00	54.00	2.20	D4113200M-40FM
	33.00	132.00	158.40	227.40	40.00	54.00	1.90	D4113300M-40FM
	34.00	136.00	162.40	231.40	40.00	54.00	1.70	D4113400M-40FM
	34.93	139.70	162.40	231.40	40.00	54.00	1.42	D4111375I-40FM
	35.00	140.00	166.40	235.40	40.00	54.00	1.40	D4113500M-40FM
	36.00	144.00	170.40	239.40	40.00	54.00	1.20	D4113600M-40FM
37.00	148.00	174.40	243.40	40.00	54.00	0.90	D4113700M-40FM	
38.00	152.00	178.40	247.40	40.00	54.00	0.70	D4113800M-40FM	
38.10	152.40	178.40	247.40	40.00	54.00	0.69	D4111500I-40FM	

IC Inserts

ISO Material	Part No.	Insert Screw	Torx® Driver	Admissible Tightening Torque
P	4T-11T306-P	7488-T15-1	8T-15	3.5 N-cm (30.9 in-lbs)
S	4T-11T306-M			
H	4T-11T306-H			
K	4T-11T306-K			
N	4T-11T306-N			

 A55: 26 - 27

 A55: 23 - 25

 A55: 24

 Ⓜ = Metric (mm)
 ⓘ = Imperial (in)

 IC Inserts sold in quantities of 10
 Insert screws sold in quantities of 10

A55: 18

www.alliedmachine.com | +44 (0) 1384 400 900 | enquiries.eu@alliedmachine.com

A

DRILLING

B

BORING

C

REAMING

D

BURNISHING

E

THREADING

X

SPECIALS

4TEX Drill Holders | Imperial Shank

11 Series | Diameter Range: 32.00mm - 38.99mm (1.260" - 1.535")

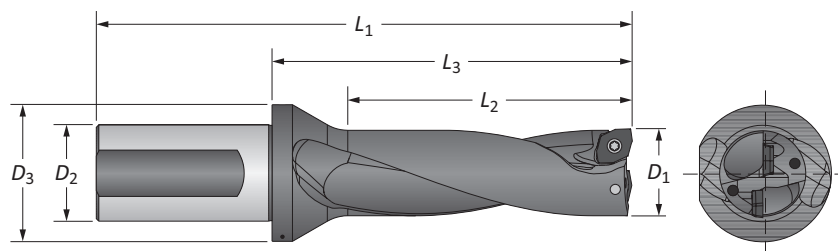
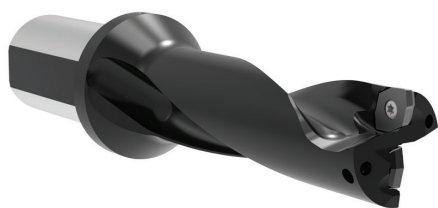

Imperial Shank

Length	Body				Shank		Max Offset	Part No.
	D ₁	L ₂	L ₃	L ₁	D ₂	D ₃		
2xD	1.126	2.520	3.953	6.669	1.500	2.126	0.087	D2113200M-150F
	1.299	2.598	4.031	6.748	1.500	2.126	0.075	D2113300M-150F
	1.339	2.677	4.110	6.827	1.500	2.126	0.067	D2113400M-150F
	1.375	2.750	4.110	6.827	1.500	2.126	0.056	D2111375I-150F
	1.378	2.756	4.189	6.906	1.500	2.126	0.055	D2113500M-150F
	1.417	2.835	4.268	6.984	1.500	2.126	0.047	D2113600M-150F
	1.457	2.913	4.346	7.063	1.500	2.126	0.035	D2113700M-150F
	1.496	2.992	4.425	7.142	1.500	2.126	0.028	D2113800M-150F
1.500	3.000	4.425	7.142	1.500	2.126	0.027	D2111500I-150F	
3xD	1.126	3.780	5.213	7.929	1.500	2.126	0.087	D3113200M-150F
	1.299	3.898	5.331	8.047	1.500	2.126	0.075	D3113300M-150F
	1.339	4.016	5.449	8.165	1.500	2.126	0.067	D3113400M-150F
	1.375	4.125	5.449	8.165	1.500	2.126	0.056	D3111375I-150F
	1.378	4.134	5.567	8.283	1.500	2.126	0.055	D3113500M-150F
	1.417	4.252	5.685	8.402	1.500	2.126	0.047	D3113600M-150F
	1.457	4.370	5.803	8.520	1.500	2.126	0.035	D3113700M-150F
	1.496	4.488	5.921	8.638	1.500	2.126	0.028	D3113800M-150F
1.500	4.500	5.921	8.638	1.500	2.126	0.027	D3111500I-150F	
4xD	1.126	5.039	6.079	8.795	1.500	2.126	0.087	D4113200M-150F
	1.299	5.197	6.236	8.953	1.500	2.126	0.075	D4113300M-150F
	1.339	5.354	6.394	9.110	1.500	2.126	0.067	D4113400M-150F
	1.375	5.500	6.394	9.110	1.500	2.126	0.056	D4111375I-150F
	1.378	5.512	6.551	9.268	1.500	2.126	0.055	D4113500M-150F
	1.417	5.669	6.709	9.425	1.500	2.126	0.047	D4113600M-150F
	1.457	5.827	6.866	9.583	1.500	2.126	0.035	D4113700M-150F
	1.496	5.984	7.024	9.740	1.500	2.126	0.028	D4113800M-150F
1.500	6.000	7.024	9.740	1.500	2.126	0.027	D4111500I-150F	

IC Inserts

ISO Material	Part No.	Insert Screw	Torx® Driver	Admissible Tightening Torque
P	4T-11T306-P	7488-T15-1	8T-15	3.5 N-cm (30.9 in-lbs)
S	4T-11T306-M			
H	4T-11T306-H			
K	4T-11T306-K			
N	4T-11T306-N			

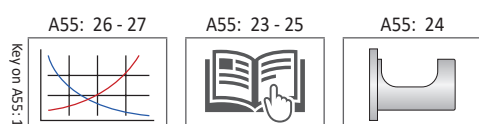

Ⓜ = Metric (mm)
 ⓘ = Imperial (in)

IC Inserts sold in quantities of 10
 Insert screws sold in quantities of 10

4TEX Drill Holders | Metric Shank

14 Series | Diameter Range: 39.00mm - 47.00mm (1.536" - 1.850")

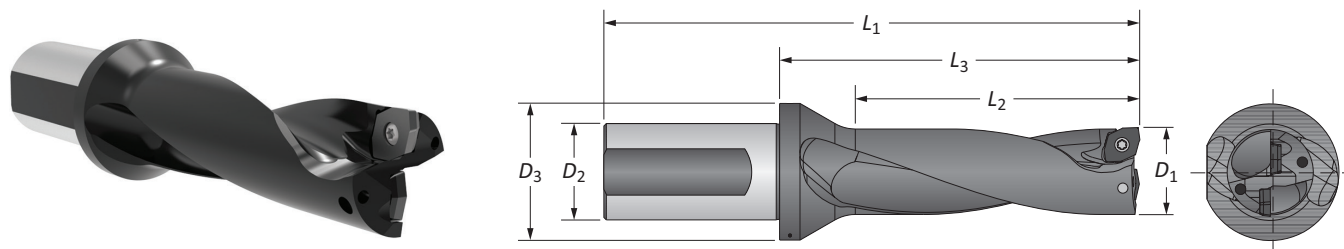

Metric Shank

Length	Body				Shank		Max Offset	Part No.
	D ₁	L ₂	L ₃	L ₁	D ₂	D ₃		
2xD	39.00	78.00	110.40	179.40	40.00	54.00	2.80	D2143900M-40FM
	40.00	80.00	112.40	181.40	40.00	54.00	2.50	D2144000M-40FM
	41.00	82.00	114.40	183.40	40.00	54.00	2.30	D2144100M-40FM
	41.28	82.55	114.40	183.40	40.00	54.00	2.23	D2141625I-40FM
	42.00	84.00	116.40	185.40	40.00	54.00	2.00	D2144200M-40FM
	43.00	86.00	118.40	187.40	40.00	59.00	1.80	D2144300M-40FM
	44.00	88.00	120.40	189.40	40.00	59.00	1.50	D2144400M-40FM
	44.45	88.90	120.40	189.40	40.00	59.00	1.41	D2141750I-40FM
	45.00	90.00	122.40	191.40	40.00	59.00	1.30	D2144500M-40FM
3xD	46.00	92.00	124.40	193.40	40.00	59.00	1.00	D2144600M-40FM
	47.00	94.00	126.40	195.40	40.00	59.00	0.80	D2144700M-40FM
	39.00	117.00	149.40	218.40	40.00	54.00	2.80	D3143900M-40FM
	40.00	120.00	152.40	221.40	40.00	54.00	2.50	D3144000M-40FM
	41.00	123.00	155.40	224.40	40.00	54.00	2.30	D3144100M-40FM
	41.28	123.83	155.40	224.40	40.00	54.00	2.23	D3141625I-40FM
	42.00	126.00	158.40	227.40	40.00	54.00	2.00	D3144200M-40FM
	43.00	129.00	161.40	230.40	40.00	59.00	1.80	D3144300M-40FM
	44.00	132.00	164.40	233.40	40.00	59.00	1.50	D3144400M-40FM
4xD	44.45	133.35	164.40	233.40	40.00	59.00	1.41	D3141750I-40FM
	45.00	135.00	167.40	236.40	40.00	59.00	1.30	D3144500M-40FM
	46.00	138.00	170.40	239.40	40.00	59.00	1.00	D3144600M-40FM
	47.00	141.00	173.40	242.40	40.00	59.00	0.80	D3144700M-40FM
	39.00	156.00	188.40	257.40	40.00	54.00	2.80	D4143900M-40FM
	40.00	160.00	192.40	261.40	40.00	54.00	2.50	D4144000M-40FM
	41.00	164.00	196.40	265.40	40.00	54.00	2.30	D4144100M-40FM
	41.28	165.10	196.40	265.40	40.00	54.00	2.23	D4141625I-40FM
	42.00	168.00	200.40	269.40	40.00	54.00	2.00	D4144200M-40FM
4xD	43.00	172.00	204.40	273.40	40.00	59.00	1.80	D4144300M-40FM
	44.00	176.00	208.40	277.40	40.00	59.00	1.50	D4144400M-40FM
	44.45	177.80	208.40	277.40	40.00	59.00	1.41	D4141750I-40FM
	45.00	180.00	212.40	281.40	40.00	59.00	1.30	D4144500M-40FM
	46.00	184.00	216.40	285.40	40.00	59.00	1.00	D4144600M-40FM
	47.00	188.00	220.40	289.40	40.00	59.00	0.80	D4144700M-40FM

IC Inserts

ISO Material	Part No.	Insert Screw	Torx® Driver	Admissible Tightening Torque
P	4T-140408-P	7595-T20-1	8T-20	4.5 N-cm (39.8 in-lbs)
S M	4T-140408-M			
H	4T-140408-H			
K	4T-140408-K			
N	4T-140408-N			

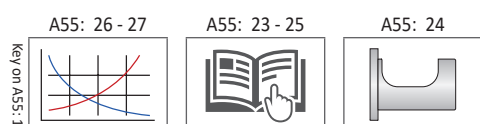

= Metric (mm)
 = Imperial (in)
 IC Inserts sold in quantities of 10
 Insert screws sold in quantities of 10

4TEX Drill Holders | Imperial Shank

14 Series | Diameter Range: 39.00mm - 47.00mm (1.536" - 1.850")

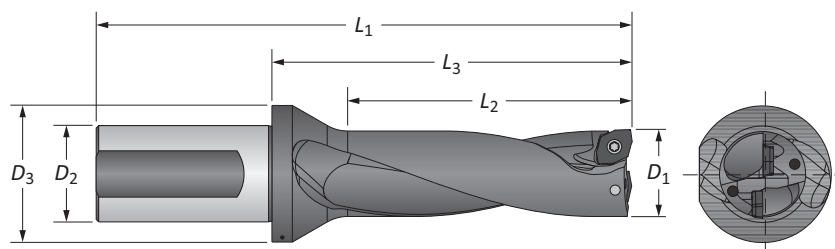
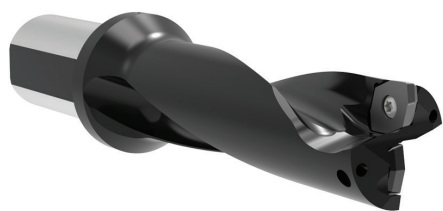

Imperial Shank

Length	Body				Shank		Max Offset	Part No.
	D ₁	L ₂	L ₃	L ₁	D ₂	D ₃		
2xD	1.535	3.071	4.346	7.063	1.500	2.126	0.110	D2143900M-150F
	1.575	3.150	4.425	7.142	1.500	2.126	0.098	D2144000M-150F
	1.614	3.228	4.504	7.220	1.500	2.126	0.091	D2144100M-150F
	1.625	3.250	4.504	7.220	1.500	2.126	0.088	D2141625I-150F
	1.654	3.307	4.583	7.299	1.500	2.126	0.079	D2144200M-150F
	1.693	3.386	4.661	7.378	1.500	2.323	0.071	D2144300M-150F
	1.732	3.465	4.740	7.457	1.500	2.323	0.059	D2144400M-150F
	1.750	3.500	4.740	7.457	1.500	2.323	0.055	D2141750I-150F
	1.772	3.543	4.819	7.535	1.500	2.323	0.051	D2144500M-150F
3xD	1.811	3.622	4.898	7.614	1.500	2.323	0.039	D2144600M-150F
	1.850	3.701	4.976	7.693	1.500	2.323	0.031	D2144700M-150F
	1.535	4.606	5.882	8.598	1.500	2.126	0.110	D3143900M-150F
	1.575	4.724	6.000	8.717	1.500	2.126	0.098	D3144000M-150F
	1.614	4.843	6.118	8.835	1.500	2.126	0.091	D3144100M-150F
	1.625	4.875	6.118	8.835	1.500	2.126	0.088	D3141625I-150F
	1.654	4.961	6.236	8.953	1.500	2.126	0.079	D3144200M-150F
	1.693	5.079	6.354	9.071	1.500	2.323	0.071	D3144300M-150F
	1.732	5.197	6.472	9.189	1.500	2.323	0.059	D3144400M-150F
4xD	1.750	5.250	6.472	9.189	1.500	2.323	0.055	D3141750I-150F
	1.772	5.315	6.591	9.307	1.500	2.323	0.051	D3144500M-150F
	1.811	5.433	6.709	9.425	1.500	2.323	0.039	D3144600M-150F
	1.850	5.551	6.827	9.543	1.500	2.323	0.031	D3144700M-150F
	1.535	6.142	7.417	10.134	1.500	2.126	0.110	D4143900M-150F
	1.575	6.299	7.575	10.291	1.500	2.126	0.098	D4144000M-150F
	1.614	6.457	7.732	10.449	1.500	2.126	0.091	D4144100M-150F
	1.625	6.500	7.732	10.449	1.500	2.126	0.088	D4141625I-150F
	1.654	6.614	7.890	10.606	1.500	2.126	0.079	D4144200M-150F
5xD	1.693	6.772	8.047	10.764	1.500	2.323	0.071	D4144300M-150F
	1.732	6.929	8.205	10.921	1.500	2.323	0.059	D4144400M-150F
	1.750	7.000	8.205	10.921	1.500	2.323	0.055	D4141750I-150F
	1.772	7.087	8.362	11.079	1.500	2.323	0.051	D4144500M-150F
	1.811	7.244	8.520	11.236	1.500	2.323	0.039	D4144600M-150F
	1.850	7.402	8.677	11.394	1.500	2.323	0.031	D4144700M-150F

IC Inserts

ISO Material	Part No.	Insert Screw	Torx® Driver	Admissible Tightening Torque
P	4T-140408-P	7595-T20-1	8T-20	4.5 N-cm (39.8 in-lbs)
S M	4T-140408-M			
H	4T-140408-H			
K	4T-140408-K			
N	4T-140408-N			

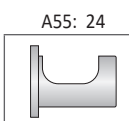
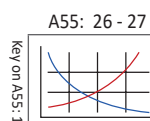

M = Metric (mm)
I = Imperial (in)

IC Inserts sold in quantities of 10
Insert screws sold in quantities of 10

A
DRILLING
B
BORING
C
REAMING
D
BURNISHING
E
THREADING
X
SPECIALS



Adjustment Sleeves

For Cutting Diameter / Centre Height Adjustment

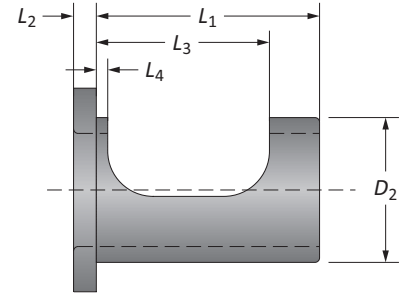
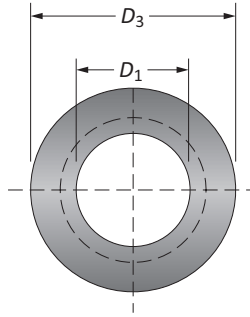

Sleeve Dimensions								Adjustment Range		
	D_1	D_2	D_3	L_2	L_3	L_4	L_1	Part No.	Diameter*	Centre Height
Ⓜ	20.00	25.00	41.00	4.00	36.00	3.00	43.00	SLEEVE-20FM	+0.40 to -0.20	+0.20 to -0.15
	25.00	32.00	49.00	6.00	38.00	2.50	48.00	SLEEVE-25FM	+0.40 to -0.20	+0.20 to -0.15
	32.00	40.00	58.00	6.00	43.00	2.50	53.00	SLEEVE-32FM	+0.40 to -0.20	+0.20 to -0.15
	40.00	50.00	74.00	6.00	49.00	3.00	63.00	SLEEVE-40FM	+0.40 to -0.20	+0.20 to -0.20
Ⓢ	0.750	1.000	1.614	0.157	1.417	0.118	1.536	SLEEVE-075F	+0.0157 to -0.0079	+0.0079 to -0.0059
	1.000	1.250	1.929	0.236	1.496	0.098	1.890	SLEEVE-100F	+0.0157 to -0.0079	+0.0079 to -0.0059
	1.250	1.500	2.283	0.236	1.693	0.098	2.087	SLEEVE-125F	+0.0157 to -0.0079	+0.0079 to -0.0059
	1.500	2.000	2.913	0.236	1.929	0.118	2.481	SLEEVE-150F	+0.0236 to -0.0079	+0.0079 to -0.0079

*Diameter adjustment range refers to the cutting diameter.

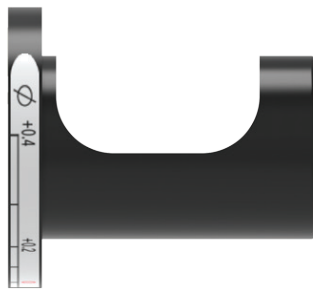

Milling Applications
Peripheral Adjustment Position

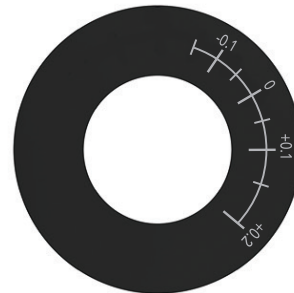

Lathe Applications
Front Adjustment Position

Ⓜ = Metric (mm)
Ⓢ = Imperial (in)

Technical Information

Diameter Adjustment

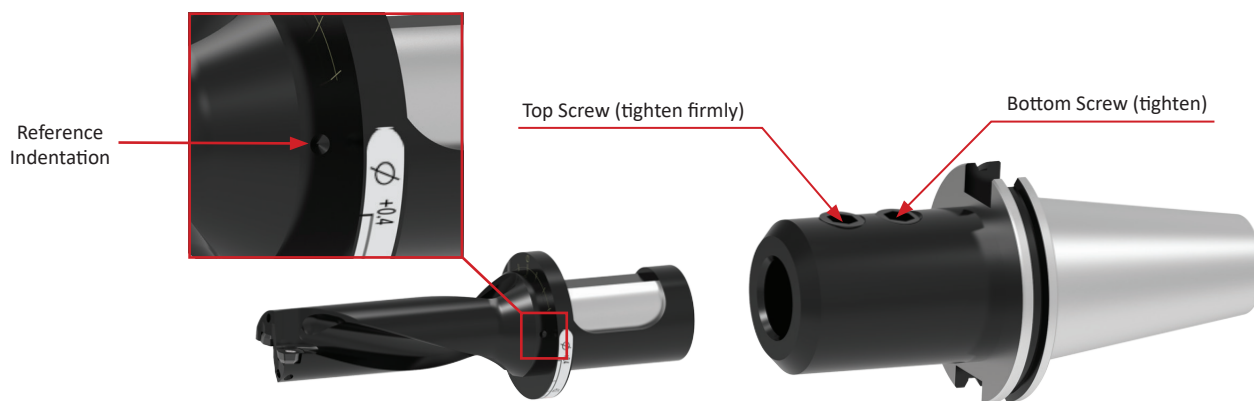

For Milling Applications

1. Assemble the 4TEX Drill, eccentric sleeve, and tool holder. Do not tighten the tool holder set screws.
2. Using the peripheral marks for milling machines, align the reference indentation on the holder with the 0 (zero) mark on the eccentric sleeve to have no offset.
3. Rotate the sleeve in the (+) or (-) direction to increase or decrease the nominal diameter.
4. Once the drill has arrived at the desired diameter, firmly tighten the top set screw first and then tighten the bottom set screw.

NOTICE: Eccentric sleeves are to be used with side-locking tool holders only. Damage may result with other styles of tool holders.

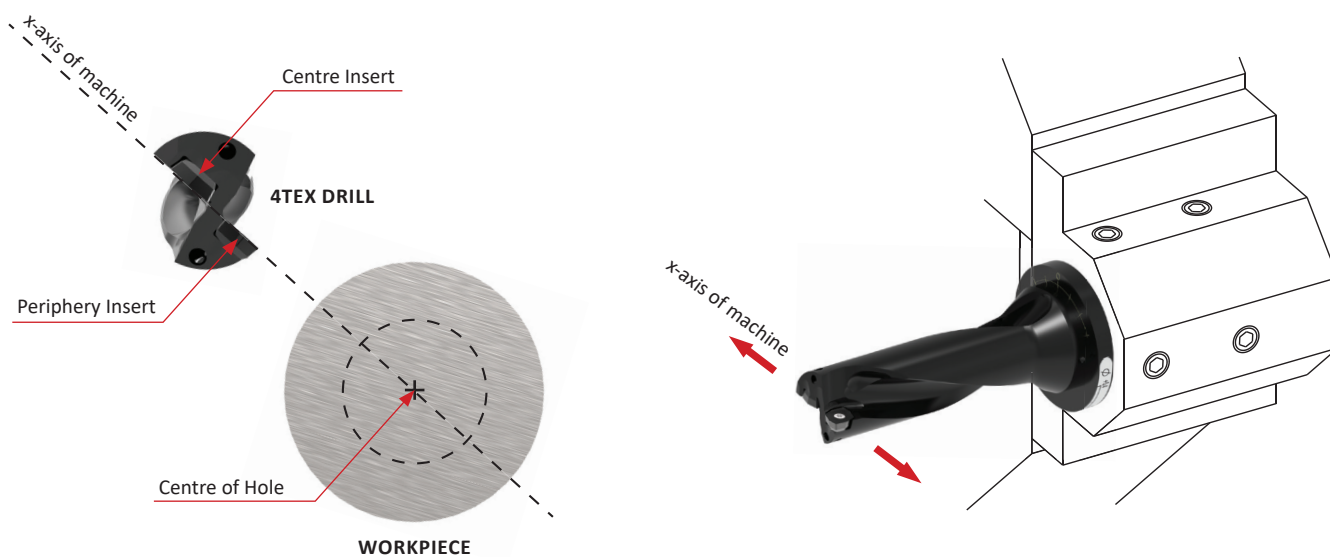

For Lathe Applications

1. Assemble the 4TEX Drill into the lathe turret with the top face of the inserts parallel to the x-axis of the machine. This will allow for the diameter offsets to be made using the lathe's x-axis.
2. To increase the nominal diameter, offset the x-axis so the periphery insert moves away from the Centre of the hole.
3. To decrease the nominal diameter, offset the x-axis so the periphery insert moves toward the Centre of the hole.



Technical Information

Centre Height Alignment - Proper Centre Line Position

A
DRILLING
B
BORING
C
REAMING
D
BURNISHING
E
THREADING
X
SPECIALS

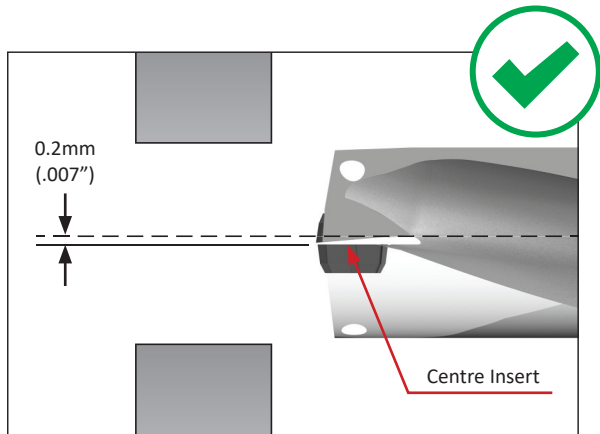
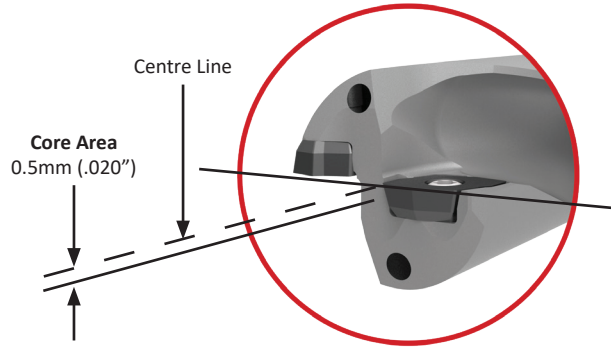
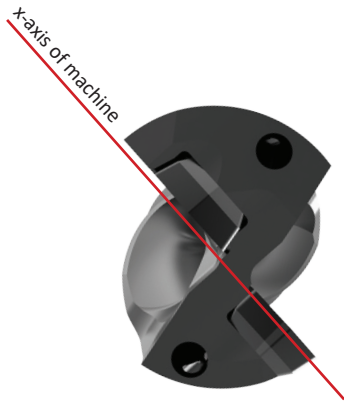

Proper Centre Height Alignment

- The correct Centre height alignment will position the Centre insert .007" (0.2mm) below the Centre line.

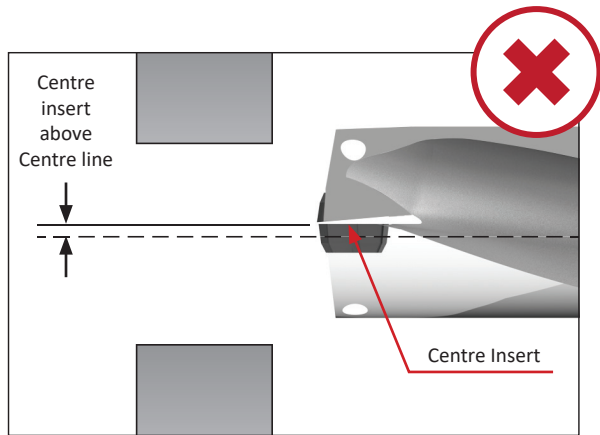
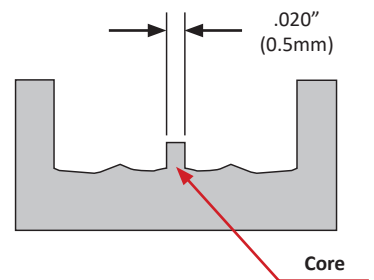

Centre Insert Above the Centre Line

- This will cause fracturing of the Centre insert
- Requires Centre height adjustment

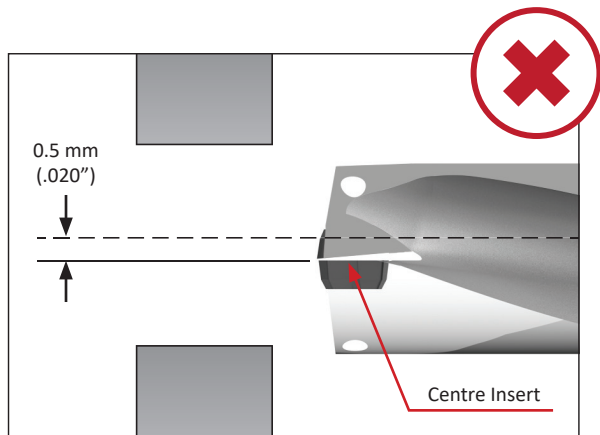
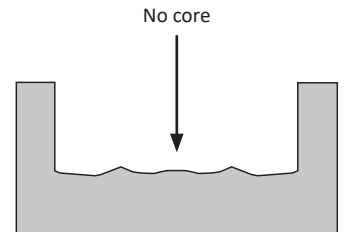

Centre Insert Too Far Below Centre Line

- This will cause the drill to interfere with the drilled hole
- This will impede chip evacuation on the periphery insert
- Requires Centre height adjustment

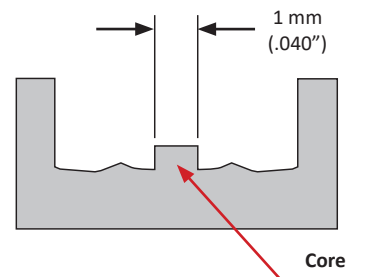

Technical Information

Centre Height Alignment - How to Correct Issues

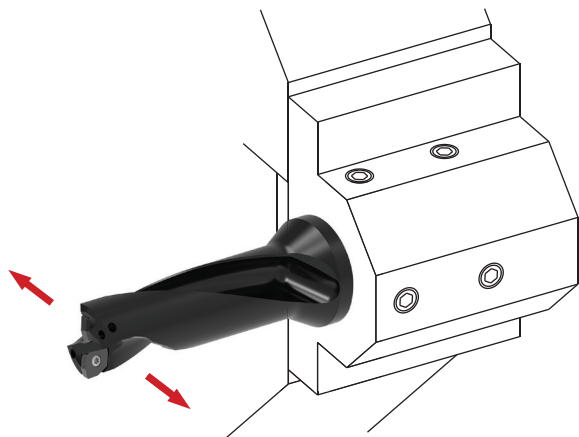

Method 1: Adjustment with X-Axis

1. Rotate the drill body so the position of the Centre line of the inserts is perpendicular to the lathe's x-axis.
2. Use the x-axis to offset the position of the Centre line in a (+) or (-) direction to increase or decrease the Centre core diameter at the bottom of the hole.

NOTE: This method does not allow diameter adjustments using the x-axis.

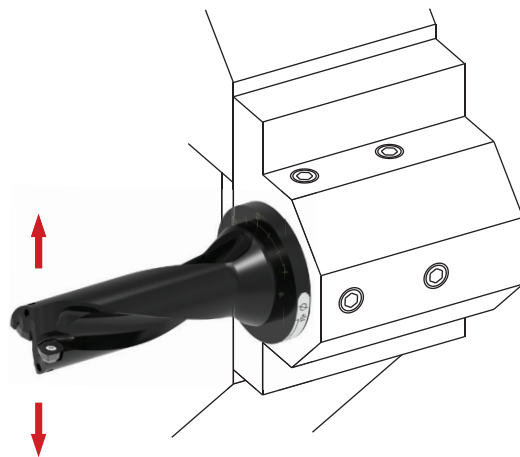

Method 2: Adjustment with Eccentric Sleeve

1. Assemble the drill to the turret using the eccentric sleeve, positioning the Centre line of the inserts parallel to the x-axis.
2. Align the reference indentation on the drill to the "0" setting on the flange face.
2. Rotate the sleeve (+) or (-) to increase or decrease the Centre height of the inserts in order to increase or decrease the core diameter at the bottom of the hole.

NOTE: This method still allows diameter adjustments using the x-axis.

NOTE (applies to both methods): Adjusting the Centre line of the inserts may affect the hole diameter produced. Method 2 is preferred to make Centre height adjustments and compensate for hole diameter with the x-axis.

A

DRILLING

B

BORING

C

REAMING

D

BURNISHING

E

THREADING

X

SPECIALS



Recommended Drilling Data | Metric (mm)

ISO	Material	Hardness (BHN)	Speed (M/min)			Feed Rate (mm/rev) by Diameter - 2xD, 3xD**			
			P	K	H	M	N	12.00 - 15.00	15.50 - 18.00
			AM480	AM485	TiCN				
P	Free Machining Steel 1118, 1215, 12L14, etc.	100 - 150	-	122 - 365	-	0.07 - 0.10	0.07 - 0.12	0.08 - 0.14	0.08 - 0.14
		150 - 200	-	122 - 305	-	0.07 - 0.10	0.07 - 0.12	0.08 - 0.14	0.08 - 0.14
		200 - 250	122 - 245	122 - 245	-	0.07 - 0.10	0.07 - 0.12	0.08 - 0.14	0.08 - 0.14
	Low Carbon Steel 1010, 1020, 1025, 1522, 1144, etc.	85 - 125	-	122 - 305	-	0.07 - 0.10	0.07 - 0.12	0.08 - 0.14	0.08 - 0.14
		125 - 175	-	122 - 305	-	0.07 - 0.10	0.07 - 0.12	0.08 - 0.14	0.08 - 0.14
		175 - 225	-	122 - 245	-	0.07 - 0.10	0.07 - 0.12	0.08 - 0.14	0.08 - 0.14
		225 - 275	122 - 245	122 - 245	-	0.07 - 0.10	0.07 - 0.12	0.08 - 0.14	0.08 - 0.14
	Medium Carbon Steel 1030, 1040, 1050, 1527, 1140, 1151, etc.	125 - 175	-	100 - 245	-	0.05 - 0.14	0.07 - 0.17	0.08 - 0.21	0.08 - 0.21
		175 - 225	-	100 - 245	-	0.05 - 0.14	0.07 - 0.17	0.08 - 0.21	0.08 - 0.21
		225 - 275	-	100 - 245	-	0.05 - 0.14	0.07 - 0.17	0.08 - 0.21	0.08 - 0.21
		275 - 325	100 - 245	100 - 183	-	0.05 - 0.14	0.07 - 0.17	0.08 - 0.21	0.08 - 0.21
	Alloy Steel 4140, 5140, 8640, etc.	125 - 175	100 - 245	-	-	0.05 - 0.14	0.07 - 0.17	0.08 - 0.21	0.08 - 0.21
		175 - 225	100 - 245	-	-	0.05 - 0.14	0.07 - 0.17	0.08 - 0.21	0.08 - 0.21
		225 - 275	100 - 245	-	-	0.05 - 0.14	0.07 - 0.17	0.08 - 0.21	0.08 - 0.21
		275 - 325	100 - 245	-	-	0.05 - 0.14	0.07 - 0.17	0.08 - 0.21	0.08 - 0.21
		325 - 375	100 - 245	-	-	0.05 - 0.14	0.07 - 0.17	0.08 - 0.21	0.08 - 0.21
	High Strength Alloy 4340, 4330V, 300M, etc.	225 - 300	100 - 163	-	-	0.05 - 0.14	0.07 - 0.17	0.08 - 0.21	0.08 - 0.21
		300 - 350	101 - 183	-	-	0.05 - 0.14	0.07 - 0.17	0.08 - 0.21	0.08 - 0.21
350 - 400		101 - 183	-	-	0.05 - 0.14	0.07 - 0.17	0.08 - 0.21	0.08 - 0.21	
Structural Steel A36, A285, A516, etc.	100 - 150	101 - 183	-	-	0.05 - 0.13	0.07 - 0.13	0.08 - 0.13	0.08 - 0.13	
	150 - 250	101 - 183	-	-	0.05 - 0.13	0.07 - 0.13	0.08 - 0.13	0.08 - 0.13	
	250 - 350	101 - 183	-	-	0.05 - 0.13	0.07 - 0.13	0.08 - 0.13	0.08 - 0.13	
Tool Steel H-13, H-21, A-4, O-2, S-3, etc.	150 - 200	83 - 183	-	-	0.05 - 0.08	0.07 - 0.12	0.08 - 0.15	0.08 - 0.15	
	200 - 250	83 - 183	-	-	0.05 - 0.08	0.07 - 0.12	0.08 - 0.15	0.08 - 0.15	
S	High Temp Alloy* Hastelloy B, Inconel 600, etc.	140 - 220	-	31 - 77	-	0.06 - 0.08	0.06 - 0.08	0.07 - 0.10	0.07 - 0.10
		220 - 310	-	31 - 61	-	0.06 - 0.08	0.06 - 0.08	0.07 - 0.10	0.07 - 0.10
	Titanium Alloy*	140 - 220	-	43 - 153	-	0.06 - 0.08	0.06 - 0.08	0.07 - 0.10	0.07 - 0.10
		220 - 310	-	43 - 92	-	0.06 - 0.08	0.06 - 0.08	0.07 - 0.10	0.07 - 0.10
	Aerospace Alloy* S82	185 - 275	-	31 - 77	-	0.06 - 0.08	0.06 - 0.08	0.07 - 0.10	0.07 - 0.10
275 - 350		-	31 - 61	-	0.06 - 0.08	0.06 - 0.08	0.07 - 0.10	0.07 - 0.10	
M	Stainless Steel 400 Series 416, 420, etc.	185 - 275	74 - 183	74 - 214	-	0.05 - 0.10	0.07 - 0.12	0.07 - 0.14	0.07 - 0.14
		275 - 350	74 - 144	74 - 153	-	0.05 - 0.10	0.07 - 0.12	0.07 - 0.14	0.07 - 0.14
	Stainless Steel 300 Series 304, 316, 17-4PH, etc.	135 - 185	74 - 183	74 - 214	-	0.05 - 0.10	0.07 - 0.12	0.07 - 0.14	0.07 - 0.14
		185 - 275	74 - 144	74 - 153	-	0.05 - 0.10	0.07 - 0.12	0.07 - 0.14	0.07 - 0.14
	Super Duplex Stainless Steel	135 - 275	74 - 183	74 - 214	-	0.05 - 0.10	0.07 - 0.12	0.07 - 0.14	0.07 - 0.14
H	Wear Plate Hardox, AR400, T-1, etc.	400	31 - 61	-	-	0.05 - 0.08	0.07 - 0.12	0.08 - 0.15	0.08 - 0.15
		500	31 - 61	-	-	0.05 - 0.08	0.07 - 0.12	0.08 - 0.15	0.08 - 0.15
		600	31 - 61	-	-	0.05 - 0.08	0.07 - 0.12	0.08 - 0.15	0.08 - 0.15
	Hardened Steel	300 - 400	31 - 92	-	-	0.05 - 0.08	0.07 - 0.12	0.08 - 0.15	0.08 - 0.15
		400 - 500	31 - 61	-	-	0.05 - 0.08	0.07 - 0.12	0.08 - 0.15	0.08 - 0.15
K	Nodular, Grey, Ductile Cast Iron	120 - 150	92 - 244	-	-	0.08 - 0.14	0.08 - 0.19	0.08 - 0.21	0.08 - 0.21
		150 - 200	92 - 244	-	-	0.08 - 0.14	0.08 - 0.19	0.08 - 0.21	0.08 - 0.21
		200 - 220	92 - 153	-	-	0.08 - 0.14	0.08 - 0.19	0.08 - 0.21	0.08 - 0.21
		220 - 260	83 - 122	-	-	0.08 - 0.14	0.08 - 0.19	0.08 - 0.21	0.08 - 0.21
		260 - 320	83 - 122	-	-	0.08 - 0.14	0.08 - 0.19	0.08 - 0.21	0.08 - 0.21
N	Cast Aluminium	30	-	-	244 - 610	0.07 - 0.12	0.08 - 0.14	0.08 - 0.17	0.08 - 0.21
		180	-	-	244 - 610	0.07 - 0.12	0.08 - 0.14	0.08 - 0.17	0.08 - 0.21
	Wrought Aluminium	30	-	-	244 - 610	0.07 - 0.12	0.08 - 0.14	0.08 - 0.17	0.08 - 0.21
		180	-	-	244 - 610	0.07 - 0.12	0.08 - 0.14	0.08 - 0.17	0.08 - 0.21
	Aluminium Bronze	100 - 200	-	-	153 - 305	0.07 - 0.12	0.08 - 0.14	0.08 - 0.17	0.08 - 0.21
		200 - 250	-	-	153 - 305	0.07 - 0.12	0.08 - 0.14	0.08 - 0.17	0.08 - 0.21
	Brass	100	-	-	153 - 305	0.07 - 0.12	0.08 - 0.14	0.08 - 0.17	0.08 - 0.21
Copper	60	-	-	153 - 305	0.07 - 0.12	0.08 - 0.14	0.08 - 0.17	0.08 - 0.21	

*For high temp materials, 68.95 bar is recommended as well as a quality synthetic coolant at approximately 10% emulsion.

**For 4xD tools, begin at low end of feed recommendation.

IMPORTANT: The speeds and feeds listed above are a general starting point for all applications. Refer to the Coolant Recommendation charts for coolant requirements to run at the recommended speeds and feeds. Factory technical assistance is also available through our Application Engineering Team.

Recommended Drilling Data | Imperial (inch)

ISO	Material	Hardness (BHN)	Speed (SFM)			Feed Rate (IPR) by Diameter - 2xD, 3xD**			
			P	K	H	M	N	.432 - .591	.630 - .709
P	Free Machining Steel 1118, 1215, 12L14, etc.	100 - 150	-	400 - 1200	-	.0024 - .0039	.0024 - .0047	.0031 - .0055	.0031 - .0055
		150 - 200	-	400 - 1000	-	.0024 - .0039	.0024 - .0047	.0031 - .0055	.0031 - .0055
		200 - 250	400 - 800	400 - 800	-	.0024 - .0039	.0024 - .0047	.0031 - .0055	.0031 - .0055
	Low Carbon Steel 1010, 1020, 1025, 1522, 1144, etc.	85 - 125	-	400 - 1000	-	.0024 - .0039	.0024 - .0047	.0031 - .0055	.0031 - .0055
		125 - 175	-	400 - 1000	-	.0024 - .0039	.0024 - .0047	.0031 - .0055	.0031 - .0055
		175 - 225	-	400 - 800	-	.0024 - .0039	.0024 - .0047	.0031 - .0055	.0031 - .0055
		225 - 275	400 - 800	400 - 800	-	.0024 - .0039	.0024 - .0047	.0031 - .0055	.0031 - .0055
	Medium Carbon Steel 1030, 1040, 1050, 1527, 1140, 1151, etc.	125 - 175	-	330 - 800	-	.0016 - .0055	.0024 - .0063	.0031 - .008	.0031 - .008
		175 - 225	-	330 - 800	-	.0016 - .0055	.0024 - .0063	.0031 - .008	.0031 - .008
		225 - 275	-	330 - 800	-	.0016 - .0055	.0024 - .0063	.0031 - .008	.0031 - .008
		275 - 325	330 - 600	330 - 600	-	.0016 - .0055	.0024 - .0063	.0031 - .008	.0031 - .008
	Alloy Steel 4140, 5140, 8640, etc.	125 - 175	330 - 800	-	-	.0016 - .0055	.0024 - .0063	.0031 - .008	.0031 - .008
		175 - 225	330 - 800	-	-	.0016 - .0055	.0024 - .0063	.0031 - .008	.0031 - .008
		225 - 275	330 - 800	-	-	.0016 - .0055	.0024 - .0063	.0031 - .008	.0031 - .008
		275 - 325	330 - 800	-	-	.0016 - .0055	.0024 - .0063	.0031 - .008	.0031 - .008
	High Strength Alloy 4340, 4330V, 300M, etc.	225 - 300	330 - 600	-	-	.0016 - .0055	.0024 - .0063	.0031 - .008	.0031 - .008
		300 - 350	330 - 600	-	-	.0016 - .0055	.0024 - .0063	.0031 - .008	.0031 - .008
		350 - 400	330 - 600	-	-	.0016 - .0055	.0024 - .0063	.0031 - .008	.0031 - .008
Structural Steel A36, A285, A516, etc.	100 - 150	330 - 600	-	-	.0016 - .005	.0024 - .005	.0031 - .005	.0031 - .005	
	150 - 250	330 - 600	-	-	.0016 - .005	.0024 - .005	.0031 - .005	.0031 - .005	
	250 - 350	330 - 600	-	-	.0016 - .005	.0024 - .005	.0031 - .005	.0031 - .005	
Tool Steel H-13, H-21, A-4, O-2, S-3, etc.	150 - 200	270 - 600	-	-	.0016 - .0031	.0024 - .0047	.0031 - .0059	.0031 - .0059	
	200 - 250	270 - 600	-	-	.0016 - .0031	.0024 - .0047	.0031 - .0059	.0031 - .0059	
S	High Temp Alloy* Hastelloy B, Inconel 600, etc.	140 - 220	-	100 - 250	-	.0020 - .0031	.0020 - .0031	.0024 - .0039	.0024 - .0039
		220 - 310	-	100 - 200	-	.0020 - .0031	.0020 - .0031	.0024 - .0039	.0024 - .0039
	Titanium Alloy*	140 - 220	-	140 - 500	-	.0020 - .0031	.0020 - .0031	.0024 - .0039	.0024 - .0039
		220 - 310	-	140 - 300	-	.0020 - .0031	.0020 - .0031	.0024 - .0039	.0024 - .0039
	Aerospace Alloy* S82	185 - 275	-	100 - 250	-	.0020 - .0031	.0020 - .0031	.0024 - .0039	.0024 - .0039
		275 - 350	-	100 - 200	-	.0020 - .0031	.0020 - .0031	.0024 - .0039	.0024 - .0039
M	Stainless Steel 400 Series 416, 420, etc.	185 - 275	240 - 600	240 - 700	-	.0016 - .0039	.0024 - .0047	.0024 - .0055	.0024 - .0055
		275 - 350	240 - 470	240 - 500	-	.0016 - .0039	.0024 - .0047	.0024 - .0055	.0024 - .0055
	Stainless Steel 300 Series 304, 316, 17-4PH, etc.	135 - 185	240 - 600	240 - 700	-	.0016 - .0039	.0024 - .0047	.0024 - .0055	.0024 - .0055
		185 - 275	240 - 470	240 - 500	-	.0016 - .0039	.0024 - .0047	.0024 - .0055	.0024 - .0055
	Super Duplex Stainless Steel		240 - 600	240 - 700	-	.0016 - .0039	.0024 - .0047	.0024 - .0055	.0024 - .0055
H	Wear Plate Hardox, AR400, T-1, etc.	400	100 - 200	-	-	.0016 - .0031	.0024 - .0047	.0031 - .0059	.0031 - .0059
		500	100 - 200	-	-	.0016 - .0031	.0024 - .0047	.0031 - .0059	.0031 - .0059
		600	100 - 200	-	-	.0016 - .0031	.0024 - .0047	.0031 - .0059	.0031 - .0059
	Hardened Steel	300 - 400	100 - 300	-	-	.0016 - .0031	.0024 - .0047	.0031 - .0059	.0031 - .0059
400 - 500		100 - 200	-	-	.0016 - .0031	.0024 - .0047	.0031 - .0059	.0031 - .0059	
K	Nodular, Grey, Ductile Cast Iron	120 - 150	300 - 800	-	-	.0031 - .0055	.0031 - .0071	.0031 - .0079	.0031 - .008
		150 - 200	300 - 800	-	-	.0031 - .0055	.0031 - .0071	.0031 - .0079	.0031 - .008
		200 - 220	300 - 500	-	-	.0031 - .0055	.0031 - .0071	.0031 - .0079	.0031 - .008
		220 - 260	270 - 400	-	-	.0031 - .0055	.0031 - .0071	.0031 - .0079	.0031 - .008
		260 - 320	270 - 400	-	-	.0031 - .0055	.0031 - .0071	.0031 - .0079	.0031 - .008
N	Cast Aluminium	30	-	-	800 - 2000	.0024 - .0047	.0031 - .0055	.0031 - .0063	.0031 - .008
		180	-	-	800 - 2000	.0024 - .0047	.0031 - .0055	.0031 - .0063	.0031 - .008
	Wrought Aluminium	30	-	-	800 - 2000	.0024 - .0047	.0031 - .0055	.0031 - .0063	.0031 - .008
		180	-	-	800 - 2000	.0024 - .0047	.0031 - .0055	.0031 - .0063	.0031 - .008
	Aluminium Bronze	100 - 200	-	-	500 - 1000	.0024 - .0047	.0031 - .0055	.0031 - .0063	.0031 - .008
		200 - 250	-	-	500 - 1000	.0024 - .0047	.0031 - .0055	.0031 - .0063	.0031 - .008
	Brass	100	-	-	500 - 1000	.0024 - .0047	.0031 - .0055	.0031 - .0063	.0031 - .008
Copper	60	-	-	500 - 1000	.0024 - .0047	.0031 - .0055	.0031 - .0063	.0031 - .008	

*For high temp materials, 1000 PSI is recommended as well as a quality synthetic coolant at approximately 10% emulsion.

**For 4xD tools, begin at low end of feed recommendation.

IMPORTANT: The speeds and feeds listed above are a general starting point for all applications. Refer to the Coolant Recommendation charts for coolant requirements to run at the recommended speeds and feeds. Factory technical assistance is also available through our Application Engineering Team.



A
DRILLING
B
BORING
C
REAMING
D
BURNISHING
E
THREADING
X
SPECIALS



Insert Geometry Recommendations

A DRILLING	ISO	Material	Hardness (BHN)	Geometry				
				P	M	K	N	H
B BORING	P	Free Machining Steel 1118, 1215, 12L14, etc.	100 - 150	○	●			
			150 - 200	●	○			
			200 - 250	●	○			
		Low Carbon Steel 1010, 1020, 1025, 1522, 1144, etc.	85 - 125	○	●			
			125 - 175	○	●			
			175 - 225	○	●			
			225 - 275	●	○			
		Medium Carbon Steel 1030, 1040, 1050, 1527, 1140, 1151, etc.	125 - 175	○	●			
			175 - 225	○	●			
			225 - 275	●	○			
			275 - 325	●	○			○
		Alloy Steel 4140, 5140, 8640, etc.	125 - 175	○	●			
			175 - 225	●	○			
			225 - 275	●				○
			275 - 325	●				○
325 - 375			○				●	
	High Strength Alloy 4340, 4330V, 300M, etc.	225 - 300	●					
		300 - 350	○				●	
		350 - 400	○				●	
	Structural Steel A36, A285, A516, etc.	100 - 150	○	●				
		150 - 250	○	●				
		250 - 350	●				○	
	Tool Steel H-13, H-21, A-4, O-2, S-3, etc.	150 - 200	●	○				
		200 - 250	●				○	
C REAMING	S	High Temp Alloy* Hastelloy B, Inconel 600, etc.	140 - 220	○	●			
			220 - 310	○	●			
		Titanium Alloy*	140 - 220	○	●			
			220 - 310	○	●			
		Aerospace Alloy* S82	185 - 275	○	●			
275 - 350	○	●						
D URNISHING	M	Stainless Steel 400 Series 416, 420, etc.	185 - 275	○	●			
			275 - 350	○	●			
		Stainless Steel 300 Series 304, 316, 17-4PH, etc.	135 - 185	○	●			
			185 - 275	○	●			
		Super Duplex Stainless Steel		○	●			
135 - 275	○	●						
E HREADING	H	Wear Plate Hardox, AR400, T-1, etc.	400	○				●
			500	○				●
			600	○				●
		Hardened Steel	300 - 400	○				●
			400 - 500	○				●
F HREADING	K	Nodular, Ductile Cast Iron	120 - 150	●	○			
			150 - 200	●	○			
			200 - 220	●	○			
			220 - 260			●		○
			260 - 320			●		○
		Grey / White Iron	120 - 150			●		○
			150 - 200			●		○
			200 - 220			●		
			220 - 260			●		
			260 - 320			●		
X PECIALS	N	Cast Aluminium	30				●	
			180				●	
		Wrought Aluminium	30				●	
			180				●	
		Aluminium Bronze	100 - 200	○			●	
			200 - 250	○			●	
		Brass	100	○			●	
Copper	60				●			

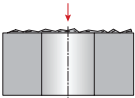
Troubleshooting

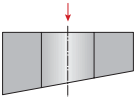
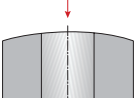
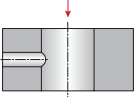
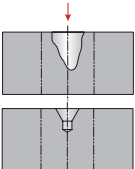
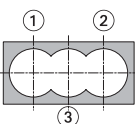
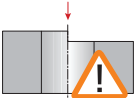
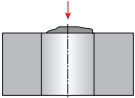
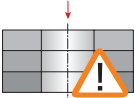
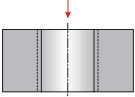
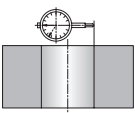
1.		<p>Starting on Uneven Surfaces</p> <ul style="list-style-type: none"> • Reduce entry feed by 50% if necessary
2.		<p>Starting on Angled Surfaces</p> <ul style="list-style-type: none"> • Reduce entry feed by 20 - 50% • Use lower rake geometry if insert chipping occurs
3.		<p>Angled Bore Exit</p> <ul style="list-style-type: none"> • Reduce entry feed by 50% on breakout • Use tough insert and stable corner radius
4.		<p>Starting on Convex Surfaces</p> <ul style="list-style-type: none"> • Reduce entry feed by 50% • Use lower rake geometry if insert chipping occurs
5.		<p>Drilling through a Cross Hole</p> <ul style="list-style-type: none"> • Reduce feed rate 50% if necessary • Use good coolant flow and monitor chip packing • Use lower rake geometry if insert chipping occurs
6.		<p>Drilling on a Groove or Large Centreing Box</p> <ul style="list-style-type: none"> • Reduce entry feed • Use lower rake geometry for Centre insert
7.		<p>Chain Drilling</p> <ul style="list-style-type: none"> • Use good coolant flow • Reduce feed rate by 50% for interrupted cut • Use lower rake geometry if insert chipping occurs
8.		<p>Starting on an Edge</p> <ul style="list-style-type: none"> • Reduce entry feed rate by 50% • Use lower rake geometry if insert chipping occurs
9.		<p>Starting on a Welded Seam</p> <ul style="list-style-type: none"> • Reduce entry feed rate by 50% • Use lower rake geometry if insert chipping occurs
10.		<p>Drilling through Stacked Plates</p> <ul style="list-style-type: none"> • Not recommended
11.		<p>Opening an Existing Hole</p> <ul style="list-style-type: none"> • Use flood coolant
12.		<p>Adjustable</p> <ul style="list-style-type: none"> • For mills, use eccentric sleeve with end mill holder • For lathes, use x-axis to adjust offset \emptyset <p>NOTE: Refer to maximum offset \emptyset in data tables</p>

A

DRILLING

B

BORING

C

REAMING

D

BURNISHING

E

THREADING

X

SPECIALS

Europe

Allied Machine & Engineering Co. (Europe) Ltd.

93 Vantage Point
Pensnett Estate
Kingswinford
West Midlands
DY6 7FR England

Phone:

+44 (0)1384 400900

Email:

enquiries.eu@alliedmachine.com

Web:

www.alliedmachine.com

Wohlhaupter GmbH

Maybachstraße 4
72636 Frickenhausen
Germany

Phone:

+49 (0)7022 408 0

Email:

info@wohlhaupter.de

Web:

www.wohlhaupter.com

United States

Allied Machine & Engineering

120 Deeds Drive
Dover OH 44622
United States

Phone:

+1 330 343 4283

Fax:

+1 330 602 3400

Toll Free USA and Canada:

800 321 5537

Toll Free USA and Canada:

800 223 5140

Allied Machine & Engineering

485 W Third Street
Dover OH 44622
United States

Phone:

+1 330 343 4283

Fax:

+1 330 364 7666
(Engineering Dept.)

Toll Free USA and Canada:

800 321 5537

Asia

Wohlhaupter India Pvt. Ltd.

B-23, 3rd Floor
B Block Community Centre
Janakpuri, New Delhi - 110058
India

Phone:

+91 11 41827044

Your local Allied Machine representative:



**ALLIED MACHINE
& ENGINEERING**

WOHLHAUPTER®

Holemaking Solutions for Today's Manufacturing