

THE NEW VALUE FRONTIER



High-Performance
Cut-Off solutions

KPK series

KPK series



Unique design for superior performance in cut-off operations

Easy insert replacement

Strong clamping mechanism for added safety and security

Long tool life and stable machining with unique chipbreaker designs

Jet coolant-through styles available (JCT)



High-performance cut-off solutions

KPK series

Easy insert replacement reduces downtime. High performance, long tool life and stable machining with strong clamping mechanism.

CUT-OFF SOLUTION

During cut-off operations, insert cutting widths of only a few millimeters are used to cut to the center of the workpiece.

Cut-off process is typically a bottleneck process or final process, requiring a trouble-free machining environment.

Challenges

The shape of the workpiece can be difficult to secure, thus creating rigidity and chattering issues. Big load due to low/zero cutting speed at the workpiece rotation center. Tool tend to be broken easily by chip troubles.

SOLUTION

The KPK Series features new insert, blade, and tool block designs for rigid, safe, and secure cut-off operations.

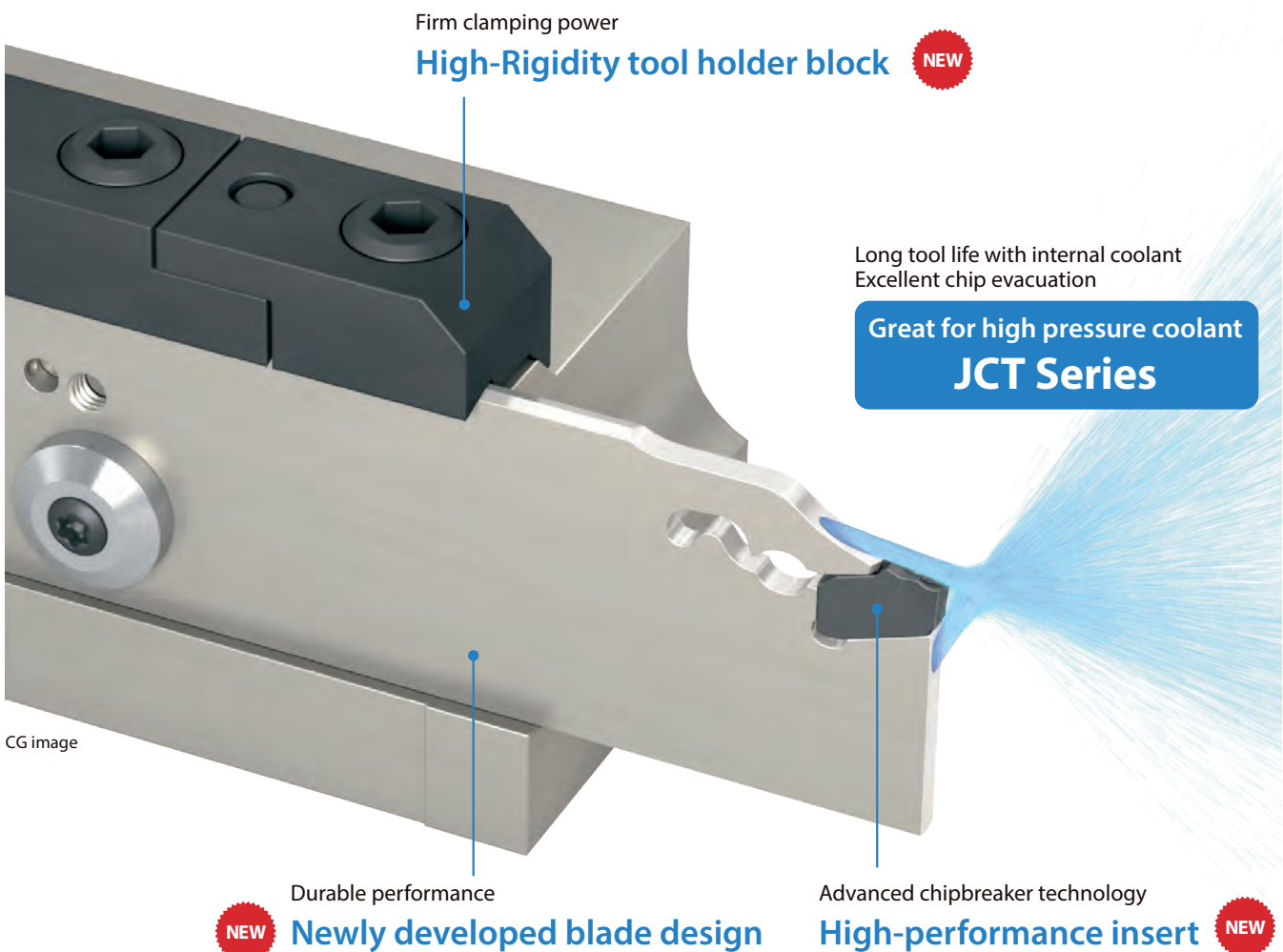

1 Easy insert replacement

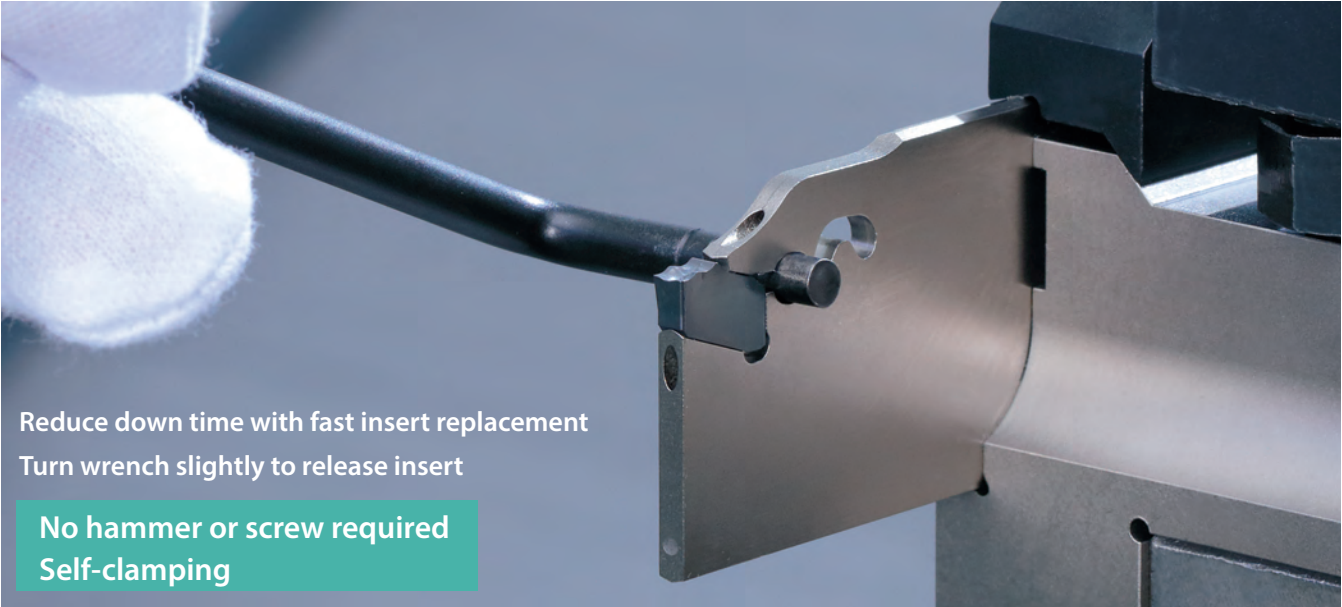

Reduce down time with fast insert replacement
 Turn wrench slightly to release insert
No hammer or screw required
Self-clamping

2 Firm insert clamp ensures added safety and security

The firmly secured insert uses three contact surfaces to eliminate sliding or chattering

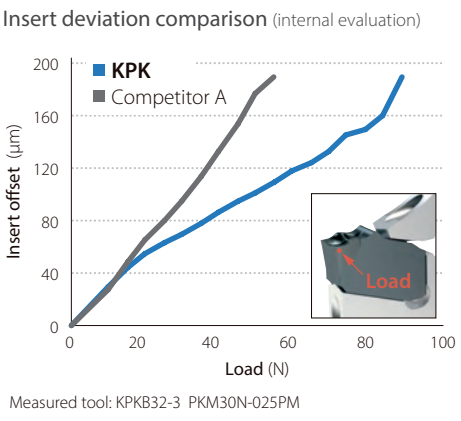
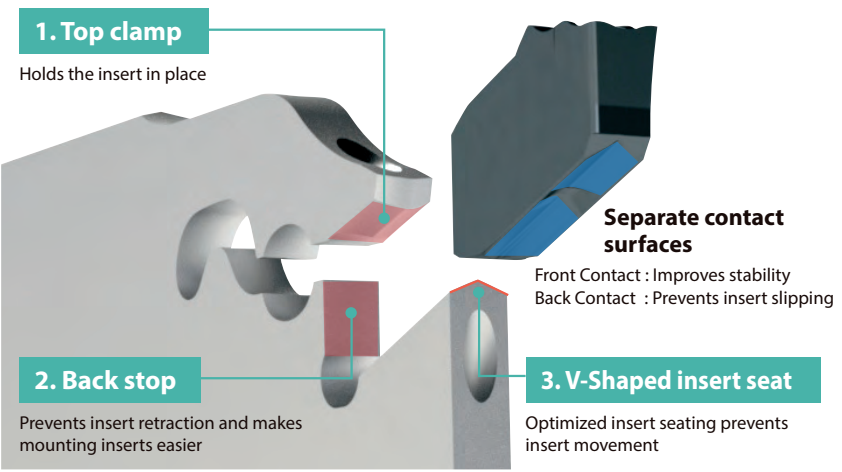

Cutting performance comparison (Internal evaluation)

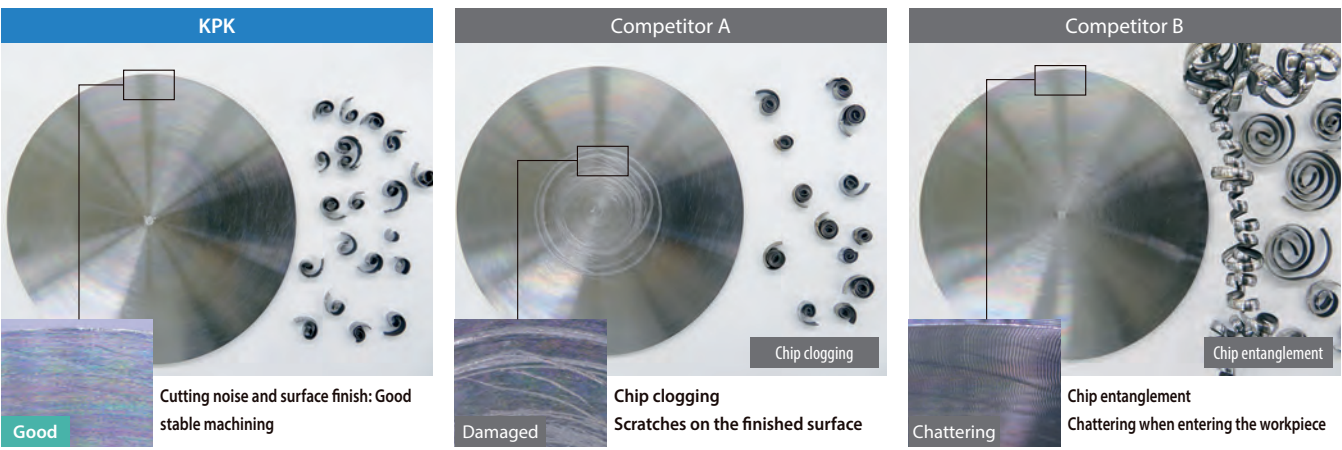

Cutting conditions : n = 320 min⁻¹(constant) , Vc = ~ 100 m/min , f = 0.12 mm/rev , Wet (External coolant) Workpiece: 34CrMo4 (ø 100) Cutting width: 3 mm (PM chipbreaker)

3 Unique chipbreaker for long tool life and stable machining

Advanced chipbreaker technology inherited from KGD lineup provides excellent chip control



General use
PM chipbreaker

Insert grade

For steel: PR1625
For stainless steel: PR1535
For cast iron and aluminum: GW15



For tough edge and High-feed machining
PH chipbreaker

Insert grade

For steel: PR1625
For stainless steel: PR1535

Wear resistance comparison (internal evaluation)

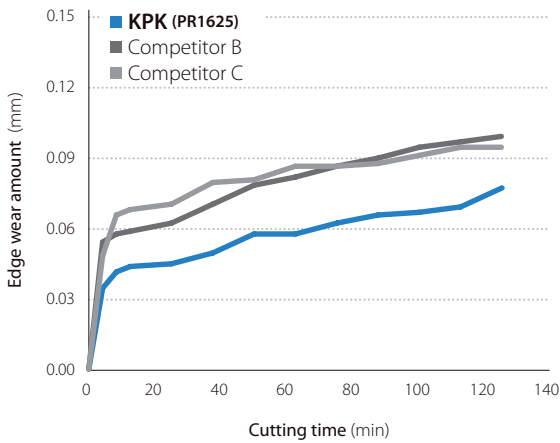

Cutting conditions : $n = 955 \text{ min}^{-1}$ (constant), $V_c \sim 150 \text{ m/min}$
 $f = 0.12 \text{ mm/rev}$ (~ $\phi 10 : f = 0.05 \text{ mm/rev}$) Wet (External coolant)
 Workpiece : 15CrMo4 ($\phi 50$) cutting width: 3 mm (PM chipbreaker)

Chip control comparison (internal evaluation)

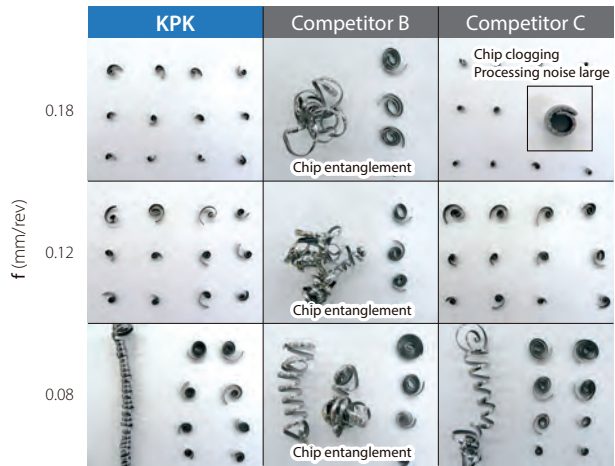

Cutting conditions : $n = 780 \text{ min}^{-1}$ (constant), $V_c \sim 120 \text{ m/min}$, wet (External coolant)
 Workpiece : 15CrMo4 ($\phi 50$) cutting width: 3 mm (PM chipbreaker)

SOLUTION 1

Tool life x1.3
Stable chip curl

Rings
100Cr6

External coolant

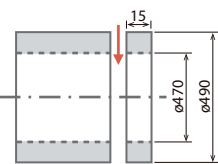

KPK

34 pcs/corner



Competitor D

25 pcs/corner



Cutting Conditions : $n = 90 \text{ min}^{-1}$ (Constant), $V_c \sim 140 \text{ m/min}$, $f = 0.06 \text{ mm/rev}$,
 Wet (External Coolant) KPKB32-3 PKM30N-025PM PR1625

(User evaluation)

SOLUTION 2

Machining efficiency double in stainless steel
Achievement of stable machining

Adaptor
X5CrNiMo17-12-2

External coolant

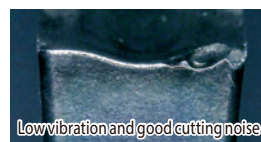
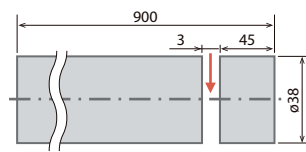

KPK

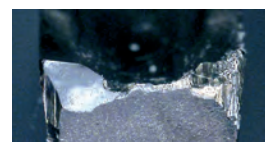

Competitor E

Cutting Conditions : $n = 1,450 \text{ min}^{-1}$ (Constant), $V_c \sim 173 \text{ m/min}$, $f = 0.05 \text{ mm/rev}$
 (Pecking: 1 mm pitch), Wet (External coolant) KPKB32-3 PKM30N-025PM PR1535

(User evaluation)

4 Rigid tool holder block prevents chattering and provides internal coolant

KPKTB-JCT

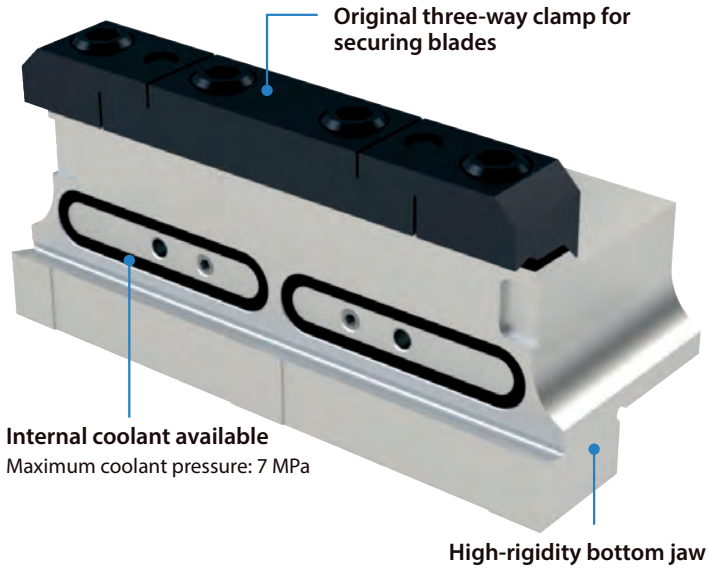

Chatter resistance comparison (internal evaluation)

Comparison of areas where stable machining is possible by changing the overhang amount of blade by 1 mm

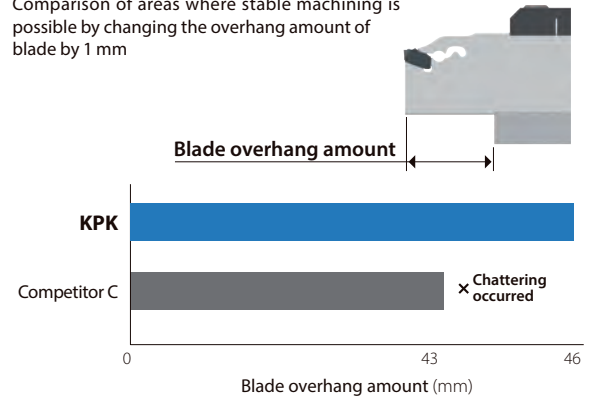

Cutting Conditions : $n = 650 \text{ min}^{-1}$ (Constant), $V_c \sim 100 \text{ m/min}$, $f = 0.12 \text{ mm/rev}$
 Wet (Internal Coolant : Normal pressure) Workpiece : SCM 435 ($\phi 50$),
 cutting width: 3 mm (PM chipbreaker)

Note KTKTB type is compatible with internal coolant with an optional internal connector. (~ 1 MPa)

*Refer to page 9 for the supply method (Type C).

JCT series supports internal coolant. Improved tool life even under normal pressure

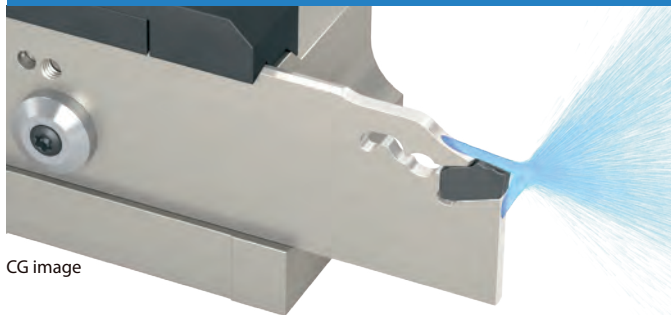

CG image

KPKB-JCT maximum overhang length while using internal coolant is as follows:
 Size 26: 40 mm Size 32: 59 mm

Coolant is supplied directly to the rake and the flank face of the cutting edge for increased tool life and improved chip control

Wear resistance comparison (internal evaluation)

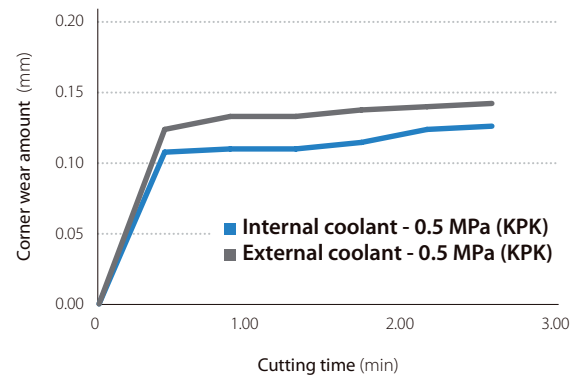

Cutting Conditions : $V_c = 30 \text{ m/min}$ (Constant), $f = 0.1 \text{ mm/rev}$,
 Machining depth : 10 mm, wet, workpiece : Inconel 718 ($\phi 100$) Cutting width: 3 mm
 (PM chipbreaker)

SOLUTION 3 Double tool life
 Reduce fracturing

Machine part
 X5CrNi1810

Internal coolant

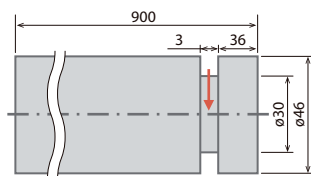

KPK 60 pcs/corner (Stable)

Competitor F 30 pcs/corner (Unstable)

Cutting conditions : $V_c = 65 \text{ m/min}$ (Constant), $f = 0.06 \text{ mm/rev}$,
 Wet (Internal coolant 3.5MPa) KPKB32-3JCT PKM30N-025PM PR1535



(User evaluation)

Chip Control Comparison (Internal evaluation)

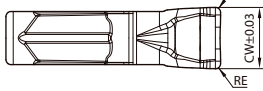

Cutting conditions : $n = 780 \text{ min}^{-1}$ (Constant), $V_c = 120 \text{ m/min}$, $f = 0.08 \text{ mm/rev}$,
 Wet, workpiece: 15CrMo4 ($\phi 50$) cutting width: 3 mm (PM chipbreaker)

Applicable inserts

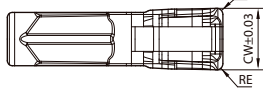
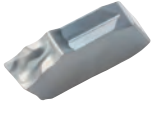
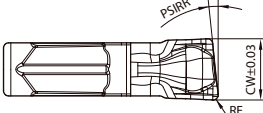
Shape Right-hand (R) shown		Description	Dimensions (mm)		Angle PSIR R/L	MEGACOAT NANO				Carbide		
			CW	RE		PR1625	PR1535	GW15	GW15			
Without lead angle	General use 		PKM 20N-020PM	2.0	0.20	-	●	●	●	●	●	●
			30N-025PM	3.0	0.25		●	●	●	●	●	●
			40N-030PM	4.0	0.30		●	●	●	●	●	●
Without lead angle	Tough Edge 		PKM 20N-020PH	2.0	0.20	-	●	●	-	-	-	-
			30N-030PH	3.0	0.30		●	●	-	-	-	-
			40N-030PH	4.0	0.30		●	●	-	-	-	-
						R	L	R	L	R	L	
With lead angle			PKM 20 R/L -020PM-6D	2.0	0.20	6°	●	●	●	●	●	●
			30 R/L -025PM-6D	3.0	0.25		●	●	●	●	●	●
			40 R/L -030PM-6D	4.0	0.30		●	●	●	●	●	●

●: Available

Recommended cutting conditions ★1st recommendation ☆2nd recommendation

Workpiece	Cutting speed Vc (m/min)			Feed f (mm/rev)			Remarks
	MEGACOAT NANO		Carbide	PM	PH		
	PR1625	PR1535	GW15	Cutting width CW (mm)	Cutting width CW (mm)		
Carbon steel	★ 80 - 220	☆ 80 - 220	-	0.08 - 0.18	0.10 - 0.22	0.15 - 0.28	Wet
Alloy steel	★ 70 - 200	☆ 70 - 200	-				
Stainless steel	☆ 60 - 150	★ 60 - 150	-	0.06 - 0.12	0.05 - 0.12	0.08 - 0.15	
Cast iron	-	-	★ 50 - 100	0.08 - 0.18	-	-	
Aluminum alloy	-	-	★ 200 - 450	0.08 - 0.18	-	-	
Brass	-	-	★ 100 - 200	0.08 - 0.18	-	-	

Reduce feed to 1/2 ~ 1/3 at the center of the workpiece.

Case studies

Rings Forging

Vc = 90 m/min
f = 0.18 mm/rev
Wet (External coolant)
Overhang amount : 70 mm
KPKB32-3 PKM30N-025PM PR1535

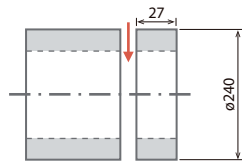

Machining efficiency

KPK

f = 0.18 mm/rev



Good

Comp. G

f = 0.09 mm/rev

x2.0

KPK showed good chip control and finished surface with increased feed rates.
The machining efficiency ratio was doubled. KPK improves insert mounting speeds.
(User evaluation)

Machine part Structural alloy steel

n = 1,530 min⁻¹ (Constant)
Vc = ~100 m/min
f = 0.09 mm/rev
Wet (External coolant)
Extrusion : 22 mm
KPKB26-3 PKM30N-025PM PR1625

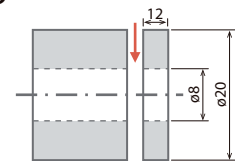

Tool life

KPK

1,500 pcs/corner (Stable)

x1.8

Comp. H

800 pcs/corner (Unstable)

Competitor H was unstable with a sudden fracture. KPK increased tool life by 1.8 times that of competitor. Stable machining with good cutting edge
(User evaluation)

Blades

KPKB - JCT with coolant holes

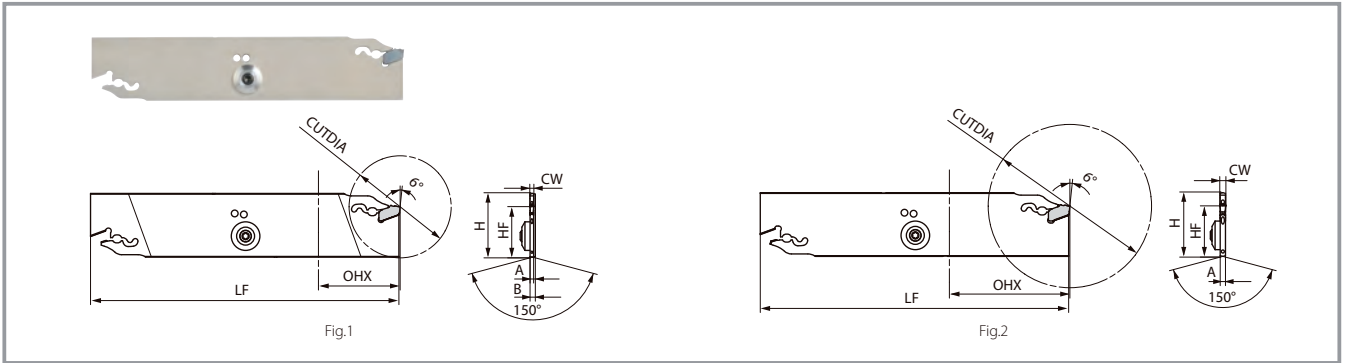

Blade dimension

Max. coolant pressure: 7 MPa

Description	Availability	CUTDIA	Dimensions (mm)							Shape	Parts				Applicable inserts	Applicable tool holder block						
			OHX ^{*1}	H ²	HF	B	LF	A	CW		Insert wrench	Coolant plug	Screw	Wrench								
KPKB 26-2JCT	●	50	40	26	21.4	2.6	110	1.8	2.0	Fig.1	LPW-5	CCP-4	SB-4065TR	FT-15	PKM20...	KPKTB○○-26JCT						
26-3JCT	●	75				2.6		3.0	Fig.2													
26-4JCT	●	80				-		3.4									4.0					
KPKB 32-2JCT	●	50	59	32	25.0	2.6	150	1.8	2.0	Fig.1							Coolant plug screw tightening torque 3.0 Nm				PKM20...	KPKTB○○-32JCT
32-3JCT	●	100				2.6		3.0	Fig.2													
32-4JCT	●	100				-		3.4														

See page 8 for insert mounting and removal instructions.

When using internal coolant with KTKTB, KTKTBF type tool holder blocks, coolant supply piping (CCN-5) sold separately.

*1 OHX: Maximum overhang length while using internal coolant *2 H: Length between virtual vertices

● : Available

KPKB without coolant hole

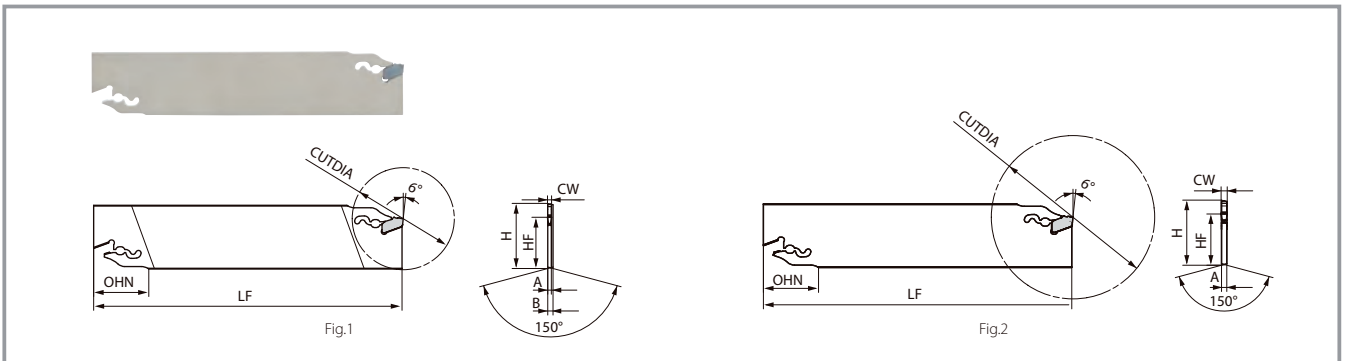

Blade dimension

Description	Availability	CUTDIA	Dimensions (mm)							CW	Shape	Parts	Applicable inserts	Applicable tool holder block	
			OHN	H ²	HF	B	LF	A	Detachable wrench						
KPKB 26-2	●	50	25	26	21.4	-	110	1.8	2.0	Fig.2	LPW-5	PKM20...	KPKTB○○-26JCT		
26-3	●	75				2.6		3.0	Fig.2						
26-4	●	80				24		3.4						4.0	
KPKB 32-2	●	50	27	32	25.0	2.6	150	1.8	2.0	Fig.1				PKM20...	KPKTB○○-32JCT
32-3	●	100				2.6		3.0	Fig.2						
32-4	●	100				-		3.4							

See page 8 for insert mounting and removal instructions.

*2 H: Length between virtual vertices

● : Available

Tool holder block

KPKTB-JCT Coolant with holes

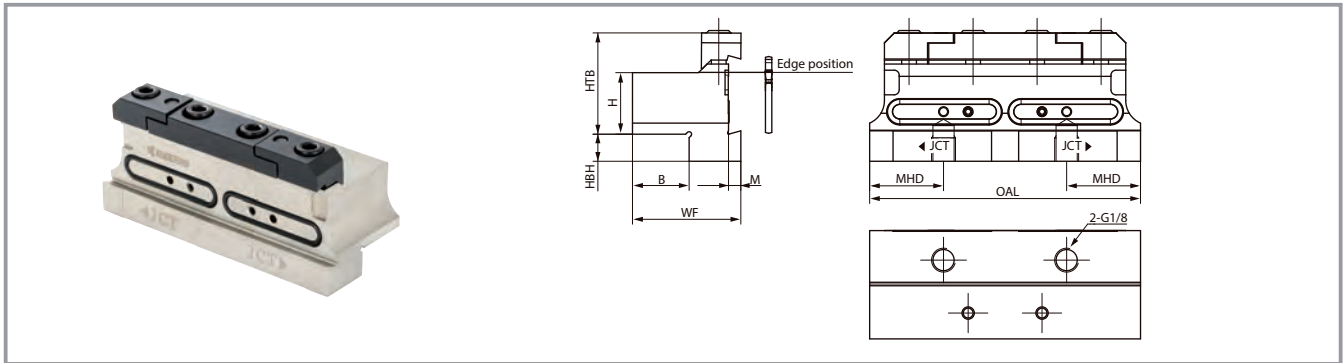

Tool holder block dimensions

Pressure: 7 MPa

Description	Availability	Dimensions (mm)								Parts						Applicable blade	
		H	HTB	HBH	B	WF	M	MHD	OAL	Clamp set Switchblade type	Screw	Wrench	O-ring	Plug 1	Plug 2		
KPKTB	20-26JCT	●	20	33	12.4	19	39	4	23.5	86	BCS-2	HH6x16	LW-5	GR-020	HS3x4	HSG1/8X8.0	KPKB26-○JCT KTKB26-○
	20-32JCT	●	20		16		40		25	100	BCS-3			GR-026	HS4x4		
	25-32JCT	●	25	41	11	23	44	5	30	110	BCS-4			GR-029			
	32-32JCT	●	32		5	29	50										

Includes only one **HSG1/8X8.0** plug.

KPKTB-JCT type block is also compatible with conventional KTKB type blades.

See page 10 for coolant piping parts.

When using internal coolant, the coolant may appear to leak slightly, but this should not affect machining performance. (If the O-ring is damaged, order separately.)

● : Available

KTKTB/KTKTBF without coolant holes

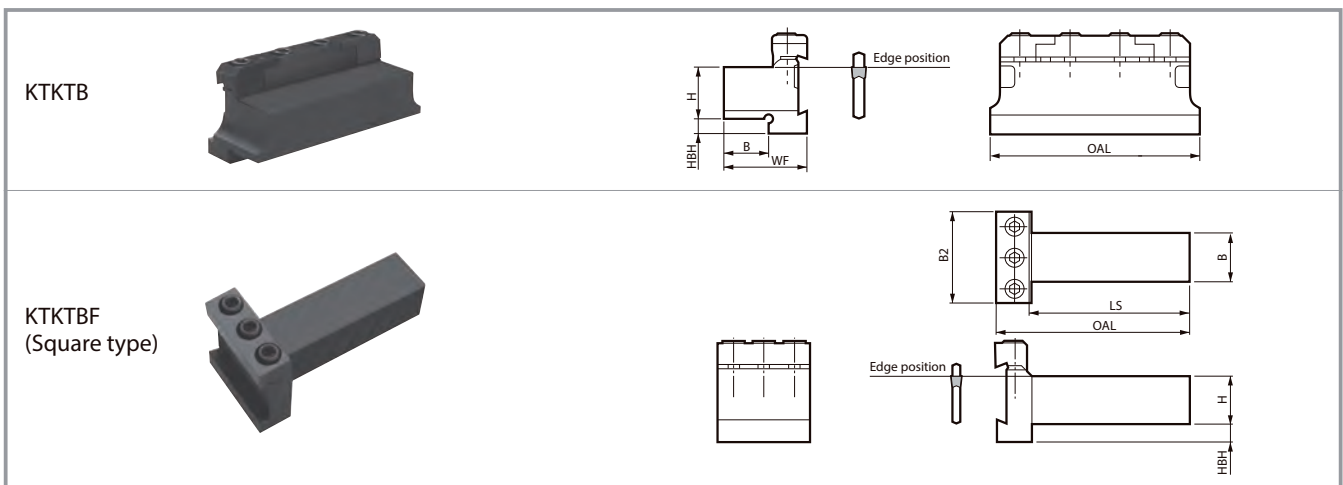

Tool holder block dimensions

Description	Availability	Dimensions (mm)								Parts				Applicable blade
		H	HBH	B	WF	B2	OAL	LS	Clamp set Switchblade type	Integral type	Screw	wrench		
KTKTB	16-26	●	16	13	15.5	31.5	31.5	86	-	BCS-2	-	HH6x30	LW-5	KPKB26-○ KPKB26-○JCT
	20-26	●	20	9	19	36	36							
	20-32	●	20	13	19	38	38	100	-	BCS-3	-	HH6x30	LW-5	KPKB32-○ KPKB32-○JCT
	25-32	●	25	8	23	42	42							
	32-32	●	32	5	29	48	48	110	BCS-4					
KTKTBF	25-32	●	25	9.5	25	48	48	102	84.5	-	BCS-5	HH6x30	LW-5	KPKB32-○ KPKB32-○JCT
	32-32	●	32	2.5	32			117	99.5					

Can be used with internal coolant by utilizing compatible coolant piping (**CCN-5**).

● : Available

How to mount and remove the insert

1. Insert provide wrench and turn in turning direction as shown in (Fig. 1)
2. Slide insert into the blade's insert pocket from the front and push in until the back of the insert contacts the blade's back stop surface. (Fig. 2)
Completely eliminate chips from the insert pocket and the wrench insertion area by using compressed air.
Check to make sure the insert is straight and not tilted.
When removing the insert, follow the same procedure as shown in Fig. 2.



Fig. 1 wrench usage

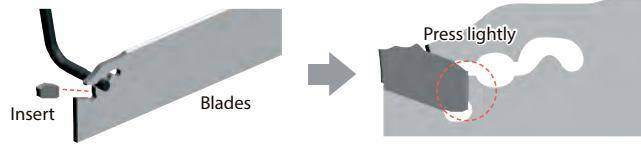
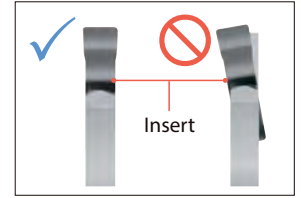
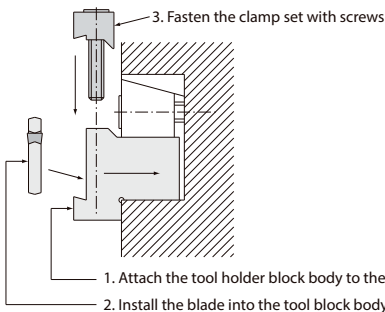

Fig. 2 mounting method



Installation guide



When mounting the tool holder block, use a wrench or spanner as shown below for a small lathe. Please note that the space for fastening may be small.

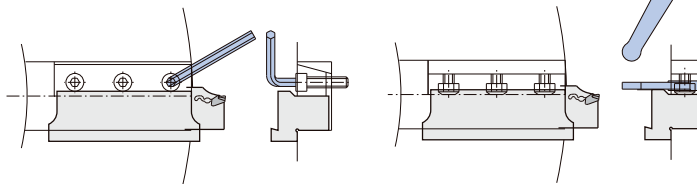

How to install the tool holder block and blade

Correct blade installation

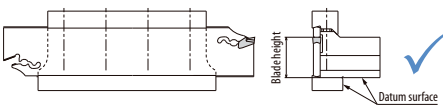

Incorrect blade installation

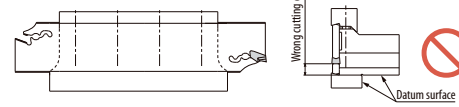

Incorrect Clamp Set Orientation

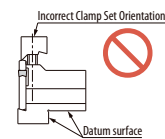

If the clamp set is mounted in the reverse direction, a large gap is created between the tool holder block main body and the clamp set as shown in the left figure. If you continue to use the product, the blade may break off. Reinstall in the correct orientation.

Lead angle direction and usage

1. If there is no restriction on the finished shape, use an insert without lead angle.
2. Insert with lead angle is recommended to prevent remaining boss.
3. If you want to make the remaining boss smaller when machining small or thin parts, use insert with lead angle.

	N (Neutral)	R (Right hand)	L (Left hand)
Handed insert with lead angle			
	<ul style="list-style-type: none"> · Inserts with lead angle (PSIR R/L) reduce burrs at cut-off machining. · The larger the lead angle (PSIR R/L), the smaller the cutting force. The feed also needs to be smaller. 		

	Right hand (R) Lead	Neutral		Right hand (R) Lead	Neutral
Solid Workpiece			Hollow Workpiece (Pipe)		

Machining precautions

1. Set cutting edge height 0.1mm above core height.
2. Machining with ample supply of coolant is recommended
3. Machine at constant speeds to gain stable tool life
4. Make the cut-off as close as possible to the chuck
5. To prevent impacts, reduce feed rate by 1/2 ~ 1/3 when nearing the center of the workpiece

Excessive use of the insert may cause chipping or damage to the holder

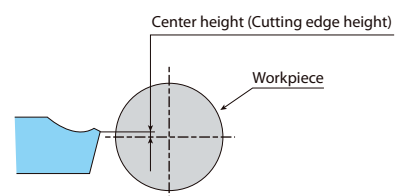

Internal coolant supply method Supplies according to machine specifications and requirements

A : Coolant hose assembly

See page 10

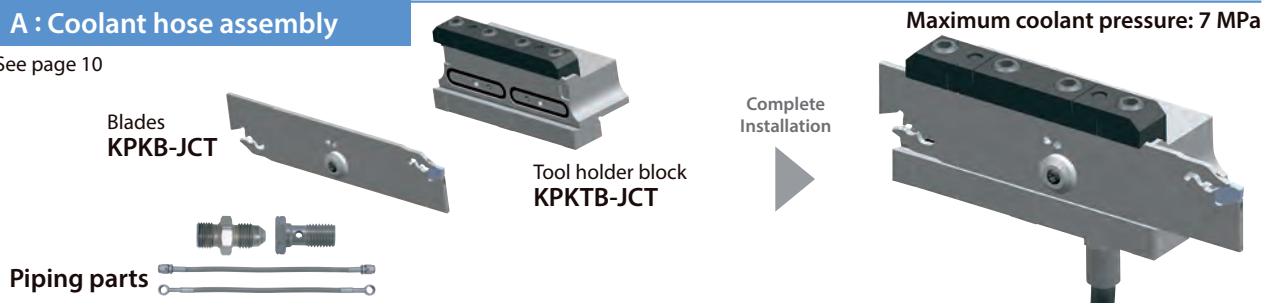

B : VDI holder assembly

(Internal coolant type)

Maximum coolant pressure: 7 MPa



C : Coolant pipe assembly

See page 10

Maximum coolant pressure: 1 MPa

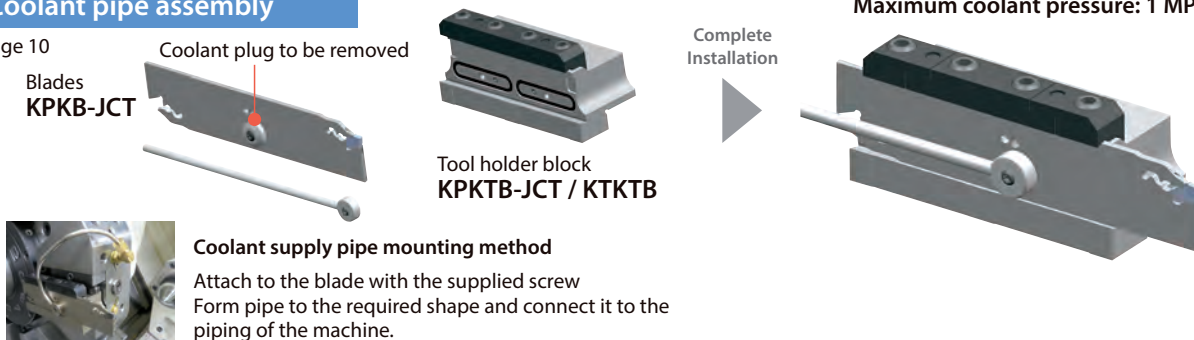

Precautions

When mounting KPKB-JCT blade

When using internal coolant, keep the arrow (▼) on the blade within the range marked on the tool holder block.

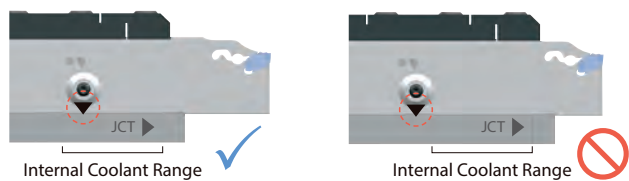

When the coolant plug and coolant supply pipe are mounted

Coolant cannot be supplied correctly if it is mounted in the wrong position.

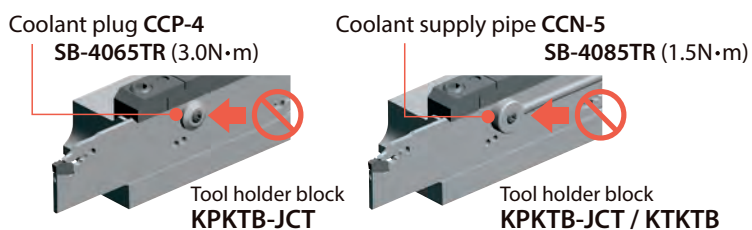

When using a tool holder block

When using the discharge port B1 (B2), use a sealant for the filler cap (HSG 1/8 X 8.0) of the accessory part of the coolant supply port A1 (A2).

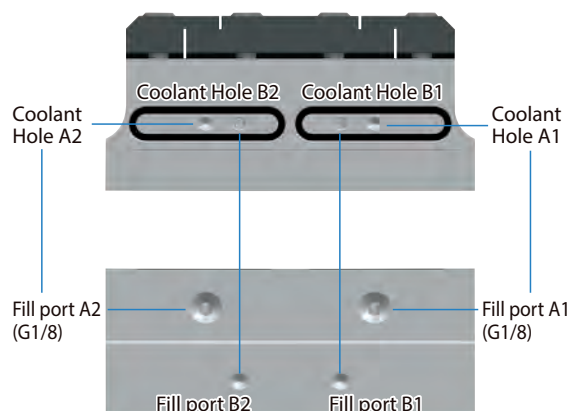

A : Coolant hose assembly

Connection method and piping parts

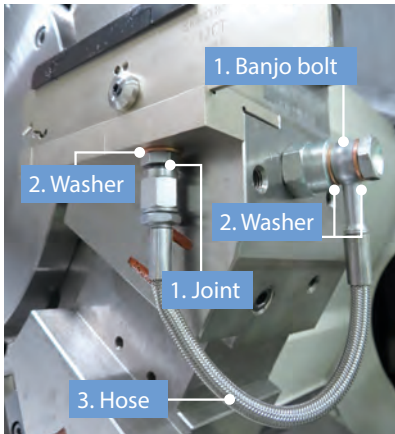

Easy to use with high-pressure hose and joint

Can be used for internal coolant at normal pressure without a high pressure pump unit
Banjo bolts (for angled hoses) are also available.

<Piping Installation Guide>

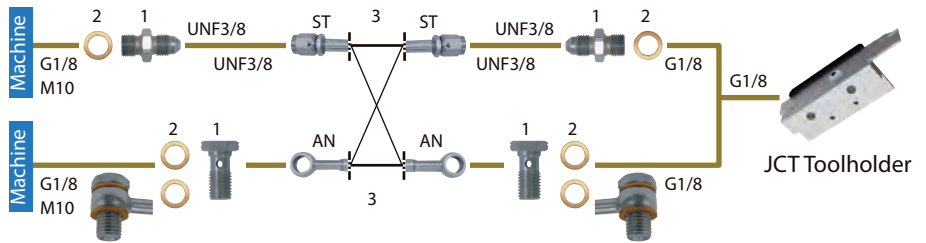

Depending on machine specifications and piping methods, **1. Joint/Banjo bolt x2** **2. Washer x2-4** **3. Hose x1**

1. Joint/banjo bolt (Sold separately)

Pressure resistance: ~ 30 MPa

Shape	Description	Stock	Thread standard	
			Toolholder machine connection side	
	J-G1/8-UNF3/8	●	G1/8	
	J-M10X1.5-UNF3/8	●	M10X1.5	
Banjo bolt (for angled hoses)	BB-G1/8	●	G1/8	
	BB-M10X1.5	●	M10X1.5	

● : Available

2. Washer (Sold separately)

Pressure resistance: ~ 30 MPa

Shape	Description	Stock
	WS-10	●

*If you are using a banjo bolt, two washers are needed.

● : Available

3. Hose (Sold separately)

Pressure resistance: ~ 30 MPa

Shape	Description	Stock	Thread standard		Dimensions (mm)	
					L	
Straight/Straight	HS-ST-ST-200	●	UNF3/8	UNF3/8	200	
	HS-ST-ST-250	●			250	
Straight/Angled	HS-ST-AN-200	●	UNF3/8	-	200	
	HS-ST-AN-250	●			250	
Angled/Angled	HS-AN-AN-200	●	-	-	200	
	HS-AN-AN-250	●			250	

● : Available

Precautions

1. Make sure machine door is completely closed before use of these parts.
2. Use appropriate seal for the male thread of the piping parts and make sure the connection is secure. Use plugs to seal off unused coolant holes.
3. Connect and fasten the coolant hose firmly.
4. The use of copper washers may cause leakage but will have no effect on the performance.
5. Commercial piping parts can be used if the thread standards are same. Check the pressure resistance before use.
6. Regularly changing the coolant filter is recommended.

C: Coolant pipe assembly

Piping parts

Coolant supply pipe (Sold separately)

Pressure resistance: 1 MPa

Shape	Description	Stock	Dimension				Parts (Screw)
			A	B	C	D	
	CCN-5	●	190	16	5	6	SB-4085TR

Use wrench (FT-15) supplied with the blade when connecting.

● : Available

Learn more about Kyocera's JCT series

Great for high pressure coolant

JCT series

- Large holder lineup for turning, external grooving, cut-off and threading
- Easy connection with high pressure hose and joint
- Internal coolant provides longer tool life and excellent chip control

Turning:

Double clamp-JCT

External grooving / cut-off:

KGD-JCT

Threading:

KTN-JCT

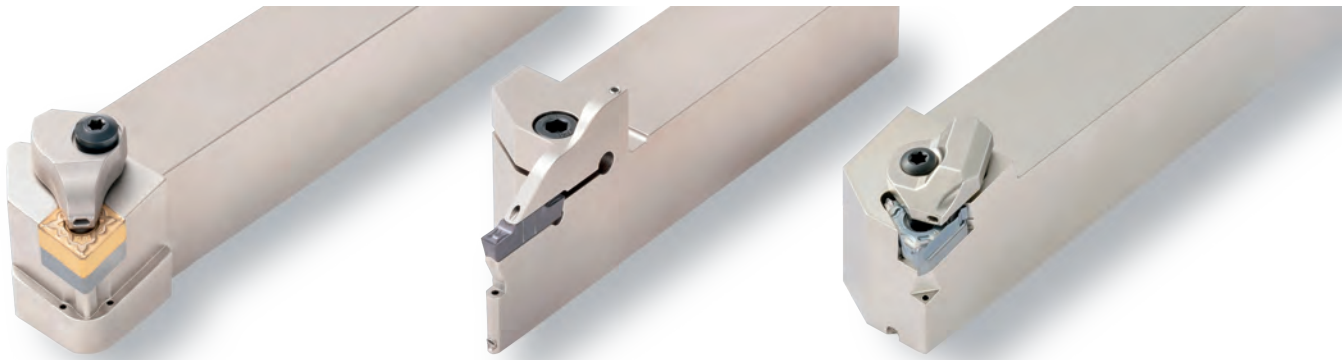

Small tools with internal coolant supply

JCT series

for small parts machining

- Great for high pressure coolant; up to 20 MPa
- Large holder lineup for turning, external grooving and cut-off

