

Cutting Tools

2020-21



Aerospace Industry



Automotive Industry



Medical Industry



Railway Industry



2020 ▶ 2021 KORLOY CUTTING TOOLS

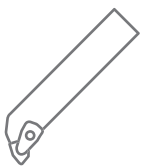

Turning



Milling



Holemaking



Endmilling

CONTENTS

GRADES & CHIP BREAKERS

A Grades

A02 KORLOY grades system

Turning Grades

A04 Turning grade selections

A05 CVD coated grades

A15 PVD coated grades

A18 Uncoated Carbide grades

A20 Cermet grades

A23 Coated Cermet grades

Milling Grades

A26 Milling grade selections/CVD coated grades

A29 PVD coated grades

A37 Uncoated Carbide grades/Cermet grades

A Solid Endmills & Solid Drills

A39 Solid Endmills grade selections

A41 Solid Drills grade selections

Others (Turning/Milling/Endmills)

A43 Diamond coated grades

A44 DLC coated grades

A46 cBN inserts grades

A51 PCD inserts grades

Chip Breakers

A52 Chip Breaker for Turning

A56 Chip Breaker for Milling

A61 Chip Breaker for Drilling

TURNING

B Turning Chip Breakers

B02 Application range of KORLOY main Chip Breakers

B04 Recommended Chip Breakers for workpiece

B12 Feature of Chip Breakers

Inserts

B26 Turning Insert Code System (ISO)

B28 Turning Insert (Negative)

B66 Turning Insert (Positive)

B90 Aluminum Insert (Positive)

B98 cBN Inserts

B102 PCD Inserts

Save Turn

B104 Technical Information for Save Turn

B105 Save Turn

Auto Tools

B111 Technical Information for Auto tools

B112 ISO/KHP/Blade/Multi Utility type

B127 KGT/MGT type

B130 MSB Tool

B136 Sleeve

Multi Turn

B137 Multi Turn

Bearing Solutions

B140 Technical Information for Bearing Solutions

B External Tool Holder

B148 External tool Holder

B153 Features of Double Clamp/Lever Lock system

B154 Double Clamp system

B159 Lever Lock System

B167 Wedge Clamp System

B169 Clamp on System

B171 Multi Lock System

B178 Screw on System

B185 Ceramic Holder

High Pressure Coolant

B187 KHP

Boring Bar

B191 Boring Bar

B195 Double Clamp System

B197 Lever Lock System

B201 Clamp on System

B202 Multi Lock System

B204 Screw on System

B214 Compact Mini

HSK/KM Tooling system

B217 Technical Information for HSK/KM Tooling System

B220 HSK Tooling system

B226 KM Tooling system

Cartridges

B230 Cartridges

B232 Clamp on System

B234 Screw on System

MULTI FUNCTIONAL TOOLS

C Application Example

- C02** Application Example
- C04** Technical Information for Multi Functional tools

KGT

- C07** KGT
- C24** KGT Blade for Parting off

KGT/MGT

- C25** MGT Series
- C38** KGT/MGT Cartridge

MGT Aluminum Wheel Series

- C42** MGT Aluminum Wheel

TB/TB-M

- C46** TB/TB-M

K Notch

- C54** K Notch

C Saw Man

- C59** Saw Man

Saw Man-X

- C62** Saw Man-X

Fine Tools

- C65** Technical Information for Fine Tools
- C66** Fine Tools Insert/Holder

Grooving/Parting off

- C68** IGH/DBH
- C69** GFIP
- C70** GH/GFIK
- C71** EH/PH

Special Order Form

- C72** Special Order Form for MGT
- C73** Special Order Form for V-Pulley Insert

THREADING

D Threading Code System

- D02** Threading Holder/Insert Code System

Technical Information for Threading

- D03** Technical Information for Threading
- D09** Threading Insert with Chip Breaker

Thread Inserts

- D10** Partial profile 60°/Partial profile 55°
- D12** ISO Metric
- D16** American UN
- D18** Whit Worth
- D22** British Standard Pipe Thread
- D22** National Pipe Thread
- D23** National Pipe Thread-Dry seal
- D23** Round DIN405
- D24** Trapez DIN103
- D24** American ACME
- D25** Stub ACME
- D26** UNJ (Unified Constant Thread)
- D28** American Buttress (ABUT)
- D28** British Buttress (BBUT)
- D29** Metric Buttress (SAGE)/API
- D30** API Buttress Casing (BUT)
- D30** API Round Casing & Tubing (APIRD)
- D30** Extreme Line Casing (EL)

D Thread Holders

- D31** External/Internal Holder
- D33** Vertical Type Holder

Thread Milling

- D34** Technical Information for Thread Milling
- D44** Thread Milling Insert
- D49** Thread Milling Holder

Solid Threading Endmills

- D50** Solid Threading Endmills

Tap

- D61** Technical Information for Tap
- D65** Carbide Tap
- D69** HSS Tap

CONTENTS

MILLING

E Insert

- E02** Milling Insert Code System (ISO)
- E04** Milling Inserts
- E32** KORLOY Cutters
- E38** KORLOY Shanks
- E42** KORLOY Modular Adaptors

Face Milling Cutters

- E44** Mill-max/Mill-max Plus (E45, E51)
- E54** Mill-max Heavy
- E56** Turbo Mill
- E59** Double Mill
- E61** Power Buster
- E68** Rich Mill
- E132** Technical Information for Aero Mill/
Aero Mill-Plus/Aero Mill-Mini
- E141** PCD face cutter

Cutters for Molds

- E142** Alpha Mill-X
- E147** Alpha Mill
- E183** BT/HSK Tooling System
- E184** BT Tooling System (Single-edge)
- E189** HSK Tooling System (Single-edge)
- E194** BT Tooling System (Multi-edge)
- E200** HSK Tooling System (Multi-edge)
- E205** BT Tooling System (Modular)
- E206** HSK Tooling System (Modular)
- E207** Technical Information for
Future Mill/FMR P-Positive
- E222** Future Mill
- E248** Future Mill P-Positive
- E260** HFMD
- E268** HFM
- E276** HRMDouble
- E292** HRM
- E299** Tank Mill
- E300** TP2P
- E309** Laser Mill/GBE/BRE

E Cutters for Molds

- E329** Technical Information for HAVE
- E331** HAVE (Single-edge/Multi-edge)
- E333** O-ring Cutter
- E335** Chamfer Tool (Multi-functional, Solid)

Milling Cutter for Aluminum

- E344** Technical Information for Pro-A Mill/
Pro-X Mill/Pro-L Mill/Pro-XL Mill/Pro-V Mill
- E354** Pro-A Mill
- E357** Pro-X Mill
- E363** Pro-L Mill
- E367** Pro-XL Mill
- E368** Pro-V Mill
- E371** Modular Adaptor (MAT)

Side Milling Cutters

- E373** Technical Information for Side Milling Cutters
- E375** Side Milling Cutters
- E379** Side Cutter
- E382** Wind Mill

Milling Cutter for Cast iron at high feed

- E386** Technical information for High feed Cutter
- E388** Technical information for Cube Mill/Couple Mill
- E391** Technical information for Storm Mill
- E392** Technical information for Shave Mill/Shave Mill-Ultra
- E395** High feed Cutter
- E397** Shave Mill/Shave Mill-Ultra

Detail Information of Milling Cutter and Arbor

- E400** Actual Designation of Milling Cutter and Arbor

Gear Tools

- E403** Gear Cutter
- E413** Gear Cutter Order Form
- E415** Indexable Hob Order Form
- E416** Special Boring Tool Order Form

ENDMILLS

F Technical Information for Endmills

- F02** Endmill Code System
- F04** KORLOY Endmills

Solild Endmills

- F09** H Endmill
- F14** V Endmill
- F17** Z Endmill
- F24** F Endmill

F Solild Endmills

- F27** T Endmill
- F30** D Endmill
- F37** Solid Endmills for Aluminum
- F40** C-Max
- F44** Super Endmill
- F51** Composite Router Endmill
- F57** I⁺ Endmill
- F72** Z⁺ Endmill

ENDMILLS

F Solid Endmills

- F89** S⁺ Endmill
- F92** R⁺ Endmill
- F103** A⁺ Endmill
- F114** PCD Endmill

F Brazed Endmills

- F116** Brazed Endmill

Special Endmill Order Form

- F123** Special Endmill Order Form

DRILL

G Technical Information for Drills

- G02** KORLOY Drills
- G04** Available Insert

Indexable Drills

- G06** King Drill
- G21** King Drill (for through coolant system with a lathe)
- G25** King Drill (for large diameter drilling)
- G27** TPDC
- G34** TPDB Plus
- G44** TPDB-H
- G51** Technical information for WPDC
- G54** Center Drill
- G55** WPDC

Solid Drills

- G57** Mach Solid Drill Plus
- G64** Mach Solid Drill Plus-S
- G70** Mach Solid Drill Plus CFRP

G Solid Drills

- G73** Mach Solid Flat Drill
- G82** Mach long Drill Plus
- G87** Mach step Drills Order Form
- G88** Vulcan Drill
- G91** ESD Plus
- G98** Carbide Drill (SSDP)
- G101** Burnishing Drill
- G102** Top solid Drill
- G103** PCD Drill
- G104** Gun Drill

Reamer

- G110** Indexable Reamer
- G116** Chucking/Machine Reamer
- G119** PCD Reamer
- G120** Cermet Reamer
- G121** Broach Reamer

BRAZED TOOLS

H Technical Information for Brazed Tools

- H02** KORLOY Ultra-Fine Grades: F-Series
- H03** Corrosion & Magnetism Proof Grade: IN-Series

General Cutting tools

- H04** Cemented Carbide, Cermet Blank
- H07** Round bar Blank/Ring Blank
- H08** Helix Blank/Square Bits
- H10** Auto Tool Bits
- H11** Chuck Jaw

H Technical Information for Brazed Tools

- H12** Cemented carbide blank for taper bits
- H13** Cemented carbide blank for cross bits
- H13** Taper bits
- H13** Boring Crown Blank/Bit for Construction

Rotating Brazing Tools

- H14** Rotating Brazing Tool
- H15** Special Rotating Brazing Tool Order Form

TOOLING SYSTEM

I Tooling System

- I 02** DBT Series
- I 03** HSK Tooling System
- I 04** Balancing System
- I 05** Tooling System Index
- I 06** DHE Series
- I 09** DSC Series
- I 17** CPM Series

I Tooling System

- I 19** NPM Series
- I 21** DCS/DC/TC
- I 22** Collet Chuck Series
- I 24** SDC Series
- I 29** GSK Series
- I 31** DSK Series

CONTENTS

TOOLING SYSTEM

I Tooling System

- I 34 GERC
- I 37 DST Series
- I 39 NPU
- I 40 DTN Series
- I 42 TCA/TER
- I 44 Side Lock Arbor Series
- I 46 Face Mill Arbor Series
- I 49 Angular Head Series

I Tooling System

- I 57 FBH Series
- I 61 TBC/FBC Series
- I 65 DBC/KMB
- I 67 SMB/SMH
- I 69 Modular System/Modular Arbor
- I 72 EXT Bar/RDC Bar
- I 74 DAMPING PRO
- I 81 Others

TOOLING EXAMPLES

J Industrial Tooling Example

- J02 Gear Machining Solution
- J04 Ship Building Industrial Solution
- J07 Role Machining Solution
- J08 Railway Industrial Solution
- J10 Pipe Industrial Solution
- J12 Bearing Working Solution
- J13 Development Industrial Solution
- J14 Aviation Industrial Solution
- J18 Slitter Knife

J Automobile Tooling Examples

- J19 Crankshaft
- J20 Knuckle
- J22 Brake
- J24 Connecting Rod
- J26 Block
- J28 Head

PARTS

K Parts

- K02 Shim
- K03 Cartridge/Chip Breaker
- K03 Chip Cover/Clamp
- K04 Coolant Bolt/Wrench Bolt
- K04 Lever
- K05 Locator/Nut

K Parts

- K05 Pin/Screw
- K06 Shim Pin
- K07 Spring/Wrench
- K07 Stop Ring/Washer
- K07 Stopper/Nozzle

TECHNICAL INFORMATION

L General Information I

- L02 Workpiece material grades
- L06 Steel, Non-ferrous metal symbol list
- L07 SI unit conversion table
- L08 Hardness calculating table
- L09 Properties of Korloy grades

L Technical Information

- L20 Technical Information for Milling
- L24 Technical Information for Tapers
- L27 Technical Information for Endmills
- L30 Technical Information for Drills

Technical Information

- L10 Technical Information for Turning

General Information II

- L36 The comparison of chip breakers
- L37 KORLOY Grades
- L40 The comparison of grades for Turning/Milling

OLD-FASHIONED PRODUCT INFORMATION

M Old-fashioned product information

- M02 Grade
- M02 External Holder
- M03 Fine Tool
- M03 Threading Tool

M Old-fashioned product information

- M02 Mill-Max
- M02 Cen-Mill
- M03 Jip Drill
- M03 LPD/SPD/NPD

INDEX

N Index

SAFETY GUIDE OF CARBIDE PRODUCTS

KORLOY Inc. is continuously trying to develop safer and higher quality products
Please be aware of the safety guidelines below prior to using KORLOY Inc. products

- It is generally accepted that the proper handling of cemented carbide tools requires awareness of safety as noted above. For more information, please contact us.
- KORLOY does not accept any responsibility for any accident caused by inappropriate use, abuse of tools, or changes to the products.

1. PL (Product Liability)

In accordance with the PL (Product Liability) law, we have attached a WARNING label on the case of KORLOY products. There is no warning on the surface of the tools. Please read this safety guidelines before using carbide tools and provide safety education to all users.

2. Basic characteristics of CEMENTED CARBIDE tools

Cemented carbide tools are made of carbides, nitrides, carbonitrides, oxides of Tungsten (W), Titanium (Ti), Alluninyum (Al), Silicon (Si), Tantalum (Ta), Boron (B) etc and metal omponent like Cobalt (Co), Nickel (Ni), Chrom (Cr), Molybdenum (Mo) as binder. Cemented carbides tools have high hardness and specific gravity. Generally there's no smell but according to usage and treatment, appreance and color could be changed

3. Precaution for CEMENTED CARBIDE tools

- 1) Cemented carbides are extremely hard and brittle at the same time. Impact shock or excessive clamping power could cause fracture or breaking of the tool.
- 2) Cemented carbides have large sepcific gravity, thus they require special attention as a heavy material when you handle big sizes or large quantities.
- 3) Cemented carbides have different thermal expansion coefficient with steel and ferrous materials. Shrink fit or swell fit products may cause trouble if they are used at undesirale conditions like extremly high or low temperatures.
- 4) There are several cemented carbide products having sharp cutting edges.Be careful not to handle the tools with bare hands which may cause cuts or injury, especially when removing the tools from the case, do not touch the cutting edge and be careful not to drop it.
- 5) Storing carbide tools in a corrosive atmosphere may cause erosion which can reduce toughness.
- 6) Please refer to the catalouge safety guidance prior to handling the tools.
- 7) Do not absue tools under inappropriate conditions.

4. Precaution for machining (grinding, welding, EDM) of CEMENTED CARBIDE tools

- 1) Surface condition can affect the toughness of the tool, so it is recommended to use a diamond grinding wheel.
- 2) Grinding of cemented carbide creates mist and dust. It contains harmful compositions like Cobalt (Co), thus it is recommended to use a mask, mist collection, and other protective facilities. If the dust gets in your skin or eye, rinse immeditely with continuously running water.
- 3) In case of grinding with coolant, coolant contains harmful metal components which cause environmental problems. Handle the coolant according to the manufacturer's recommendations.
- 4) Check for cracks after re-grinding carbide tool and reuse.
- 5) Marking with laser or electric pen may cause cracks on the carbide tool. The crack can shortened tool life.
- 6) EDM of carbide may cause residual cracks on the carbide tool, so if necessary , remove the crack with a grinding process.
- 7) Brazing of carbide tools at extremely high or low temperatures compare with the melting point of brazing materials may cause loosening or breakage.
- 8) Overheating a oil base coolant may cause a fire or flames, thus be prepared for fire prevention.

5. METALCUTTING SAFETY

	DAINGEROUS FACTOR	SAFETY COUNTERPLAN
Cutting tools	· Sharp cutting edge of cutting tools may cut your bare-hand	· Use gloves when pulling out the insert from the case or mounting it on the machine
	· Inappropriate conditions or usage may cause fragmentation and expel parts of tools which may cause injury	· Use glasses or safety cover for your safety · Use the tools within the recommended range · Please refer to catalogue and safety guidelines first
	· Severe load on tool and premature wear of cutting edge may bring excessive cutting force on tool, causing fracture of the tool and may cause injury	· Use glasses or safety cover for your safety · Change the tool as required before excessive wear or fracture
	· Chips evacuated during cutting are hot and sharp and may cause burns and cuts	· Use glasses or safety cover for your safety · Stop machining and put safety glove on and use a hook tool to remove chips
	· Touching the workpiece immediately after cutting may cause burns	· Use gloves or safety cover for your safety
	· Be aware of sparks, fire, or explosion of hot chips generated during the cutting operation	· Do not use at the place where having explosive materials · Prepare for fire extinguishments
	· In case of high RPM machining, vibration and chattering may occur due to the improper balance of the machine	· Use glasses or safety cover for your safety · Check first if there's any chattering, vibration or strange noises prior to your main cutting operation
	· Touching a burr remaining on the workpiece with a bare-hand may cause a cut	· Do not touch the burr with bare-hand · Use gloves or safety cover for your safety
	· Loose clamping of the workpiece may cause the tool to fracture and result in damage to the cutter body and possible injury	· Clamp the workpiece tightly
	· Tools are operated to right-hand direction normally · Left-hand direction operation can cause fracture of tool and body damage	· Do not use left-hand direction without notice · Check the package of product to check the availability of left-hand operation
Indexable tools	· Loose clamping of inserts and parts may result in ejection of the tool during cutting and may cause serious injury	· Check the clamping of inserts and parts prior to machining, and use original parts only
	· Over loaded clamping of inserts by a lever (such as a pipe) may cause dangerous fracturing of parts and inserts	· Do not use lever inappropriately
	· In case of high speed machining, parts and inserts can be forced out by centrifugal force	· Use within recommended condition · Use glasses or safety cover for your safety
Rotating tools	· Since cutter has sharp cutting edges touching with a bare-hand may cause a cut	· Use gloves or safety cover for your safety
	· It is dangerous to use glove with rotating machine · Contact with body or clothes is dangerous with rotating parts	· Do not wear gloves when you work with rotating machine · Keep your body and clothes away from rotating machine
	· Vibration generated by balancing trouble may cause a fracture and ejection of the tool which may cause serious injury	· RPM should be controled within recommended condition · Check the balance of rotating part periodically
	· In case of drilling, the uncut bottom core can fly out of the part with high speed and cause serious injury	· Use gloves or safety cover for your safety
	· The edges of small diameter drill are sharp and easy to break	· Use gloves or safety cover for your safety
Brazed tools	· Fragmentation and ejection of brazed carbide tip may cause injury	· Check the brazed tip before using · Do not use at high temperature cutting condition
ETC	· There's a possibility of breaking the carbide tip after several brazing · Abusing may cause fragmentation of tool and is very dangerous	· Do not use brazing a tip that has been brazed several times · Stick to safety regulations and guidelines

KORLOY Inc. Code System

Grade name for coated carbide

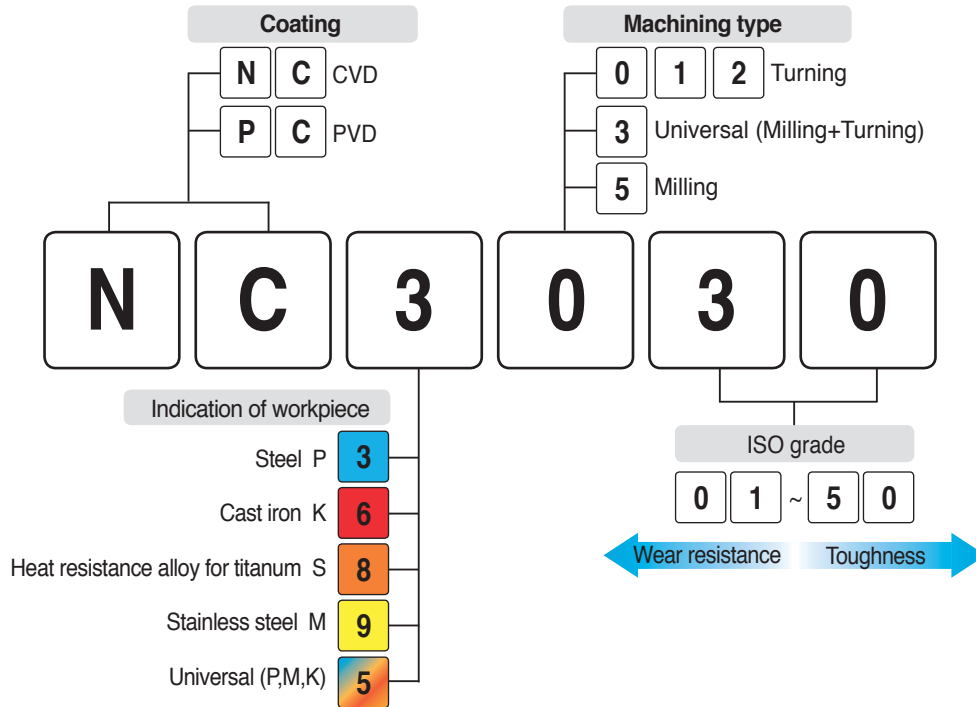

Chip breaker

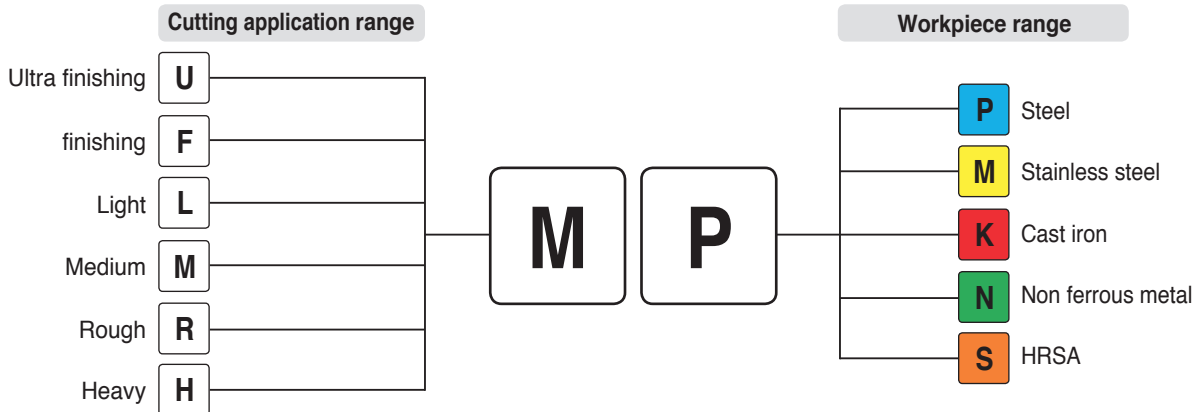

The same chip breaker code is used for both negative type and positive type.

Terminology of tool formula

TERM	CODE	UNIT
Tool diameter	D	mm
Cutting speed	vc	m/min
Revolution per minute	n	min ⁻¹
Feed per minute	vf	mm/min
Feed per revolution	fn	mm/rev
Feed per tooth	fz	mm/t
Tooth	z	
Axial depth of cut	ap	mm
Radial depth of cut	ae	mm
Peak feed	pf	mm

TERM	CODE	UNIT
Horse power requirement	Pc	kW
Specific cutting resistance	kc	MPa
Torque	Mc	N.m
Thrust	Tc	N
Cycle time	tc	min
Tool life	T	min
Flank wear	V _B	mm
Crater wear	Kt	mm
Nose radius	r	mm

How to use Tool4U (Web quotation requirement)

1. Contact with Korloy Homepage

<http://www.korloy.com> (Korloy Homepage)

2. Click Tool4U banner-icon on the web site

3. Main page

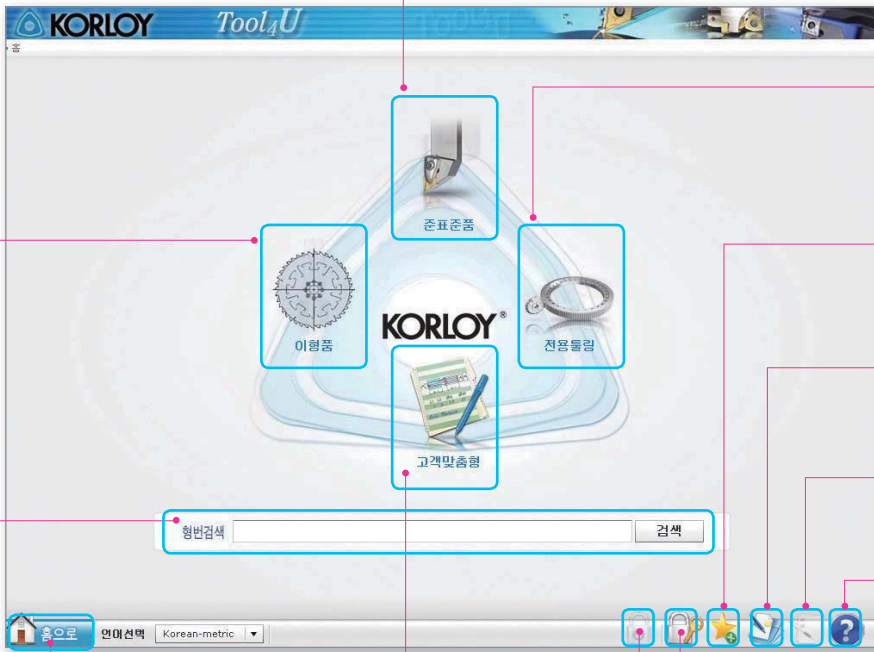

1 Semi standard
Standard but different in size

2 Tailor-made
Standard no korloy item

3 Special tooling
For special tooling such as gear, edge miller, railway, non-standard indexable & facemill

4 Custom-tailored
Customized item by special request

5 Search
You can search by designation

6 Home
Click here to go on to the mail page

7 Administrator
Only administrators may access this menu

8 Login/Logout
Login, Logout & Register as a member here

9 My favorite
You can organize shortcuts on your favorite items (registered member only)

10 Memo
You can save short text here

11 My quotation
You can check your quotation list here

12 Help
Functional description of each menu

4. Screen shot

Screen shot 1: Step3. Product detail

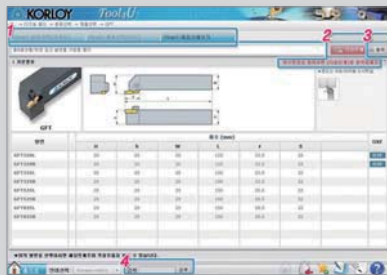

- 1. Step:** Select category, product and check product detail
- 2. Next step:** Open new window for changing dimension
- 3. Print:** Print current page
- 4. Search:** Search product by designation

Screen shot 2: Size input page



Enter essential information needed to quote and click "Quote" button to send e-mail

A

GRADES & CHIP BREAKERS

KORLOY's new grades are designed with optimal substrates for each application and are PVD coated for high temperature, high hardness and oxidation resistance, or CVD coated for high temperature and wear resistance. Additionally, the improved post-coating treatment provides superior surface finishes to ensure the highest levels of quality and productivity.





Grades

A02 Grades System

Turning Grades

A04 Turning Grade Selections
A05 CVD Coated Grades
A15 PVD Coated Grades
A18 Uncoated Carbide Grades
A20 Cermet Grades
A23 Coated Cermet Grades

Milling Grades

A26 Milling Grade Selections
A27 CVD Coated Grades
A29 PVD Coated Grades
A37 Uncoated Carbide Grades
A38 Cermet Grades

Solid Endmills & Solid Drills Grades

A39 Solid Endmills Grade Selections
A41 Solid Drills Grade Selections

Others (Turning/Milling/Endmills)

A43 Diamond Coated Grades
A44 DLC Coated Grades
A46 cBN Inserts Grades
A51 PCD Inserts Grades

Chip Breakers

A52 Chip Breaker for Turning
A56 Chip Breaker for Milling
A61 Chip Breaker for Drilling

Grades system

➤ Cutting tool

Uncoated carbide	P	Steel	ST10	ST20	ST30A
	M	Stainless steel	U20		
	K	Cast iron	H01	H05	G10
	S	Heat resistant alloy	H01	H05	
	N	Non-ferrous metal	H01	H05	
	H	Hardened steel	H01		

Coated carbide for turning	P	Steel	NC3215	NC3225	NC3120	NC3030	NC5330	PC5300	PC5400			
	M	Stainless steel	PC8105	PC8110	PC8115	NC9115	NC9125	NC5330	NC9135	PC5300	PC9030	PC5400
	K	Cast iron	NC6310	NC6315	NC5330	PC5300	PC5400					
	S	Heat resistant alloy	PC8105	PC8110	PC8115	NC9125	NC9135	PC5300	PC5400			
	N	Non-ferrous metal	ND3000	PD1005	PD1010							
	H	Hardened steel	PC8105	PC8110	PC8115							

Coated carbide for milling	P	Steel	NC5330	NCM535	PC3600	PC3700	PC5300	PC5400	NCM545
	M	Stainless steel	NC5330	PC5300	PC9530	PC5400	PC9540		
	K	Cast iron	PC6510	NC5330	NCM535	PC5300	PC5400	NCM545	
	S	Heat resistant alloy	PC5300	PC5400	PC9540				
	N	Non-ferrous metal	ND3000	PD1005	PD1010				
	H	Hardened steel	PC2005	PC2010	PC2015	PC210F	PC2505	PC2510	

Coated carbide for drills, endmills	P	Steel	PC3700	PC5300	PC5335	PC5400	NC5330	NCM535
	M	Stainless steel	PC5300	PC5335	PC5400			
	K	Cast iron	PC6510	PC5300				
	S	Heat resistant alloy	PC5300	PC5400				
	N	Non-ferrous metal	H01					

Turning cermet	P	Steel	CN1500	CN2000	CN2500
	K	Cast iron	CN1500	CN2500	

Coated cermet	P	Steel	CC1500	CC2500
	K	Cast iron	CC1500	CC2500

Milling cermet	P	Steel	CN2000	CN30
----------------	----------	-------	--------	------

➤ Application range

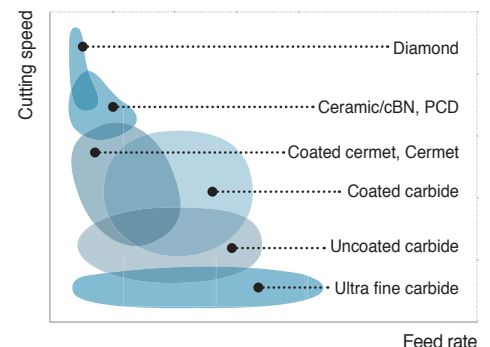

Grades system

➤ Cutting tool

Solid endmills	P M K	General	PC203F	PC215F	PC303S	PC310U	PC315E	PC320	PC320S
	S	Heat resistant alloy	PC320	PC320S					
	H	Hardened steel	PC203F	PC303S	PC310U				
	N	Non-ferrous metal	ND3000	ND2100	PD1005	PD1010	PC210C	H01	H05S

Solid drills	P M K	General	PC325U	PC215G	PC315G	PC230F
	S	Heat resistant alloy	PC325T			
	N	Non-ferrous metal	FG2	FA1	ND2100	

cBN	K	Cast iron	DBN500	DBN700A				
	S	Heat resistant alloy	DB7000					
	H	Hardened steel	DB1000	DB2000	DBNX20	DBN250	DBN350	DBN400

Coated cBN	H	Hardened steel	DNC100	DNC250	DNC400	DNC350
------------	---	----------------	--------	--------	--------	--------

PCD	N	Non-ferrous metal	DP90	DP150	DP200
-----	---	-------------------	------	-------	-------

➤ Wear resistance tool

Ultra fine grain cemented carbide	Z	Ultra fine grain cemented carbide	FS1	FA1	FCC
-----------------------------------	---	-----------------------------------	-----	-----	-----

Uncoated carbide	V	Wear parts	D1	D2	D3	G5
	I	Corrosion resistance	IN10	IN20	IN40	

➤ Mining tool

Uncoated carbide	E	General	GR10	GR20	GR30	GR35	GR40
------------------	---	---------	------	------	------	------	------



Turning grade selections

Selection system

Workpiece	P Steel					M Stainless steel				K Cast iron				S HRSA				N Nonferrous				H Hardened							
	ISO	P01	P10	P20	P30	P40	P50	M10	M20	M30	M40	K01	K10	K20	K30	S01	S10	S20	S30	N01	N10	N20	N30	H01	H10	H20	H30		
Coated carbide			NC3215					PC8105				NC6310 <i>new</i>			PC8105					ND3000 <i>new</i>							PC8105		
			NC3225					PC8110					NC6315		PC8110						PD1005 <i>new</i>						PC8110		
			NC3120					PC8115							PC8115													PC8115	
			NC3030					NC9115 <i>new</i>						NC5330		NC9125 <i>new</i>						PD1010 <i>new</i>						PC8115	
			NC5330					NC9125 <i>new</i>						NC5330		NC9125 <i>new</i>												PC8115	
			NC5330					NC9135 <i>new</i>						PC5300		NC9135 <i>new</i>													PC8115
			PC5300					PC5300						PC5300		PC5300													
			PC5400					PC9030							PC5400		PC5400												
			PC5400					PC5400																					
			PC5400					PC5400																					
Cermets		CC1500 <i>new</i>											CC1500 <i>new</i>																
		CC2500 <i>new</i>											CC2500 <i>new</i>																
		CN1500											CN1500																
		CN2000											CN2500																
		CN2500											CN2500																
cBN / PCD												DBN700			DB7000						DP90						DNC100		
												DBN800									DP150						DNC250		
												DBN500									DP200						DNC400		
																											DNC350		
Uncoated carbide		ST10						U20				H01			H01						H01						H01		
			ST20									H05			H05							H05							
			ST30A									G10																	

Application range of turning grades

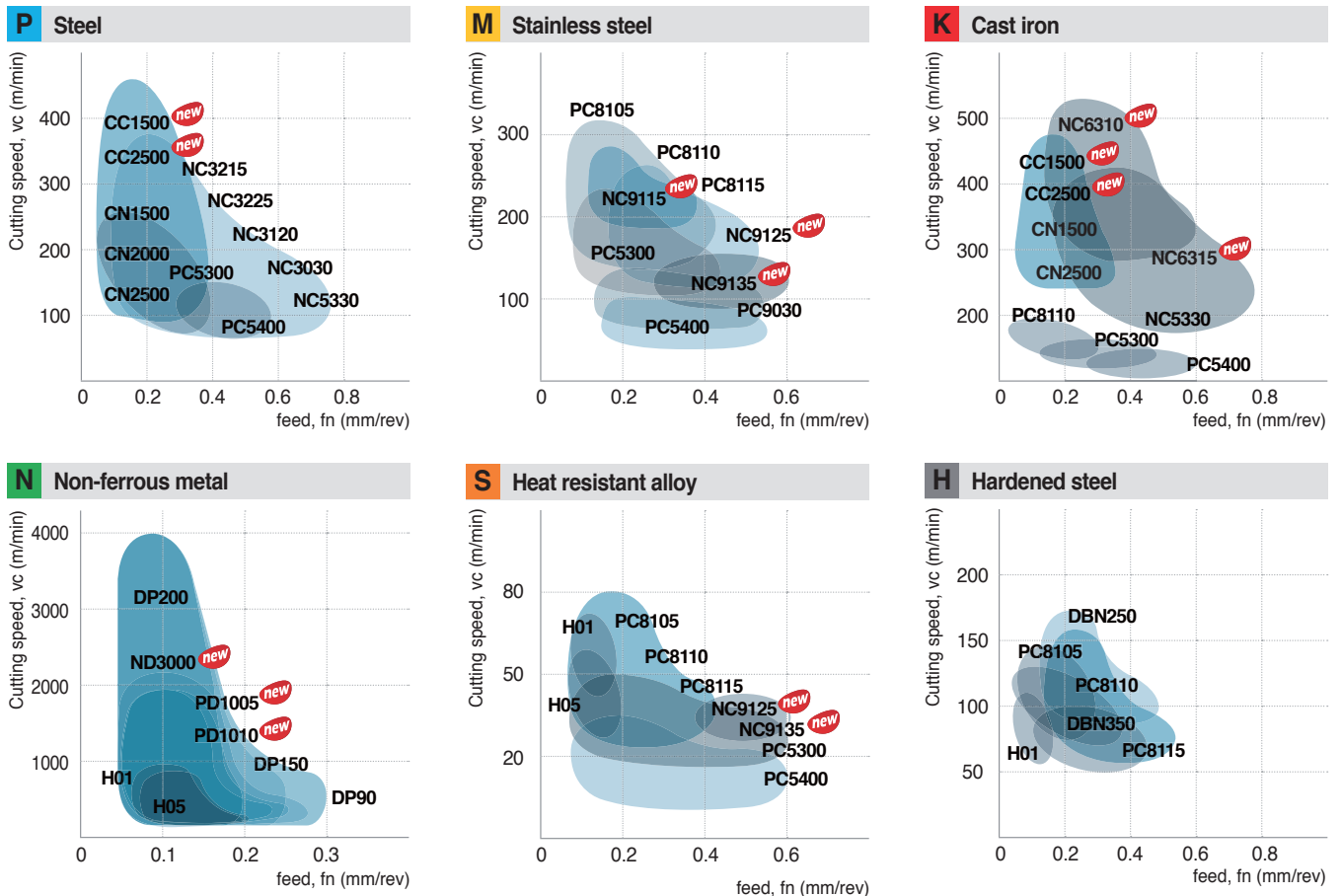

CVD coated grades

NC3215/NC3225

- Universal grade especially for machining forged automobile components and bearing steel both in continuous and interrupted cutting
- Available for all kinds of steels - carbon steel, alloy steel, rolled steel, tool steel, mild steel, bearing steel and other special kinds of steel
- New coating technology increases welding resistance and chipping resistance, which leads to longer tool life.

Features

- Stable tool life → Higher production stability
- Longer tool life & Higher removal rate → High cutting conditions and shorter cutting time available
- Ideal combination of a grade and chip breakers → Prolongs tool life → Wide applications ranging from roughing to finishing

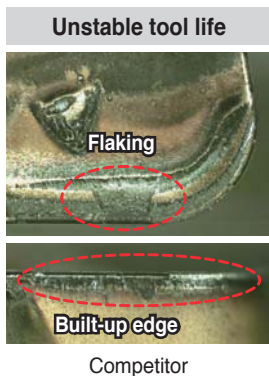
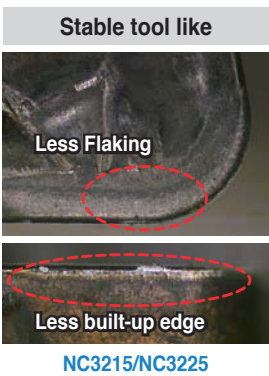

• Disperse cutting force → Reduce chipping → Increase tool life → Improved productivity

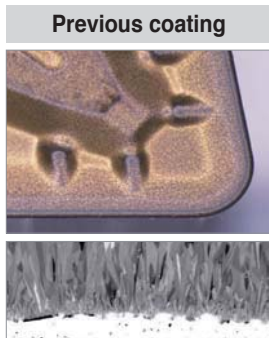

Application range

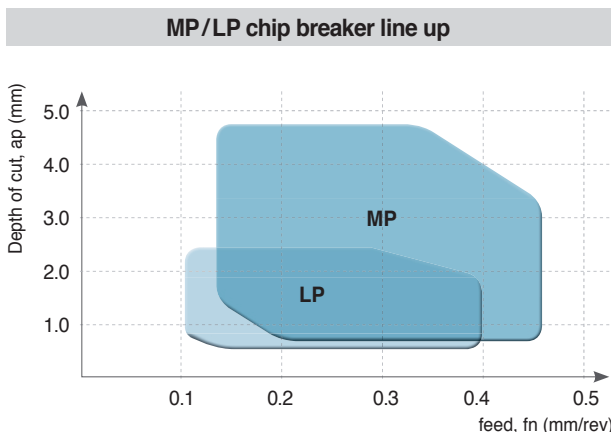
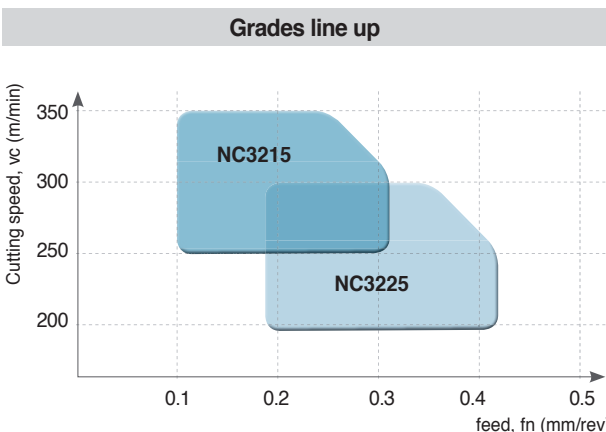

CVD coated grades

CVD coated grade for high efficiency and quality turning of cast iron

NC6310 ^{new} / NC6315

- CVD coating with improved wear resistance and chipping resistance.
- Solutions for the most common issues in cast iron machining: Preventing excessive wear on rake and flank surfaces of insert, chipping and burr

Features of NC6310

Normal wear on rake surface and nose radius

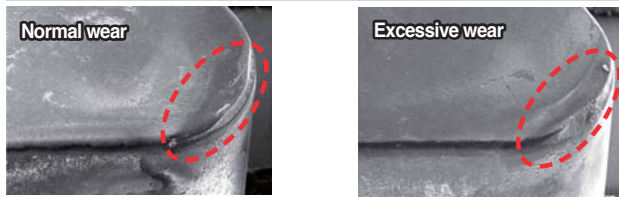

NC6310

Existing grade (K10)

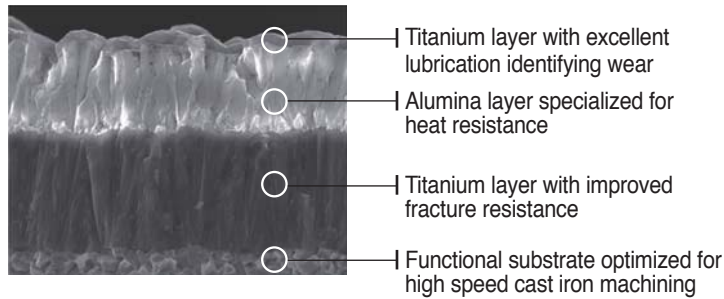

Recommended machining range for each grade

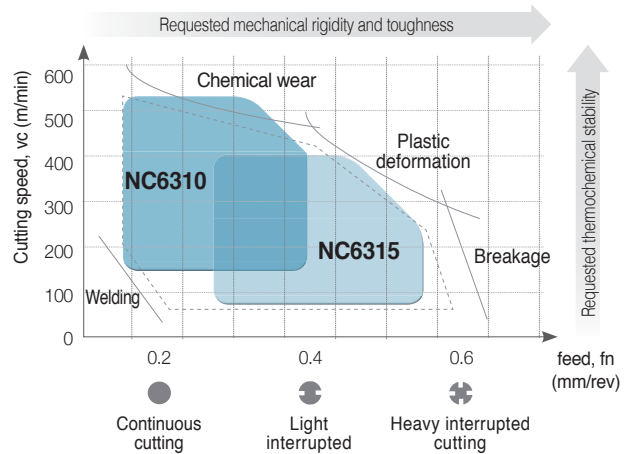

Features of NC6315

Improved flaking resistance and wear resistance on rake surface



NC6315

Existing grade (K15)

Normal wear on flank surface

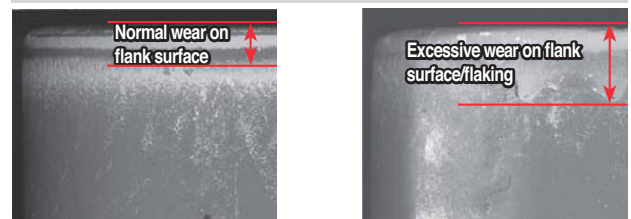

NC6315

Existing grade (K15)

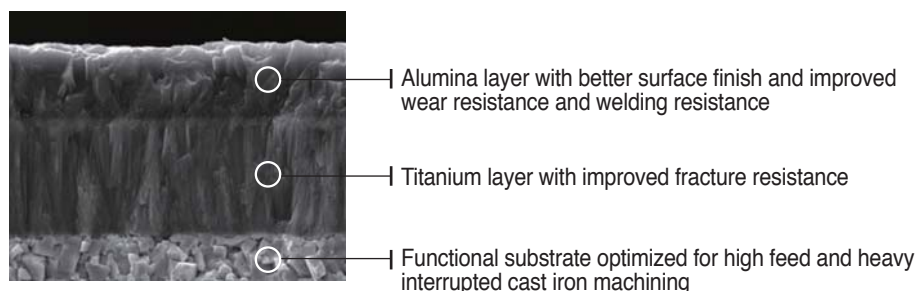

CVD coated grades

Turning grades for stainless steel

NC9115 **new** / NC9125 **new** / NC9135 **new**

- Optimized for reducing built-up edges, notch wear, plastic deformation and burrs, and for machining stainless steel
- Ideal combination of a grade and MM/RM chip breakers for stable tool life and wide applications ranging from roughing to finishing
- Stable tool life even at high speeds, feeds and depth of cuts (for STS316, vc over 150m/min available), shortening cutting time
- Excellent versatility responding to workpiece change, covering the austenite, the martensite and the ferrite
- NC9115 is for P20 class, mild steel and forged steel machining.

Features

- Improved surface finish thanks to the new lubricative CVD coating

Lubricative coating layer to prevent built-up edge

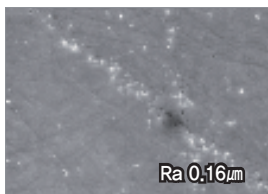

NC9100 Series

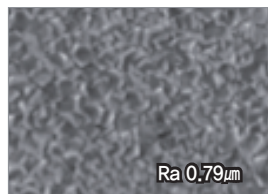

Existing coating



- Top coat with improved welding resistance
- Alumina coating layer for high speed cutting
- Titanium coating layer with stronger resistance to chipping
- Tough substrate optimized for continuous cutting and both light & heavy interruption

- Lubricative coating layers → Improves welding resistance

- Coated layers of stronger chipping resistance and the substrate of high toughness → Inhibits notch wear creation

Inhibited built-up edge and blade damage

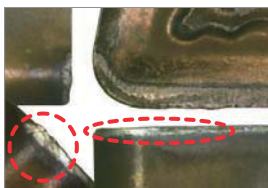

NC9125 (M25)

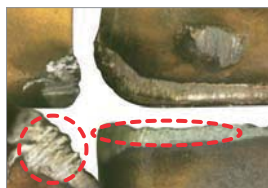

Competitor (M25)

Inhibited wear on notch and relief surface

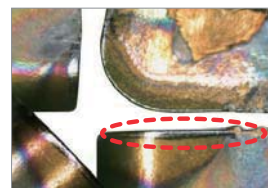

NC9135 (M35)

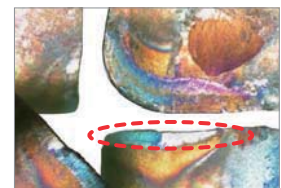

Competitor (M35)



A Turning Grades

CVD coated grades

Grades line up

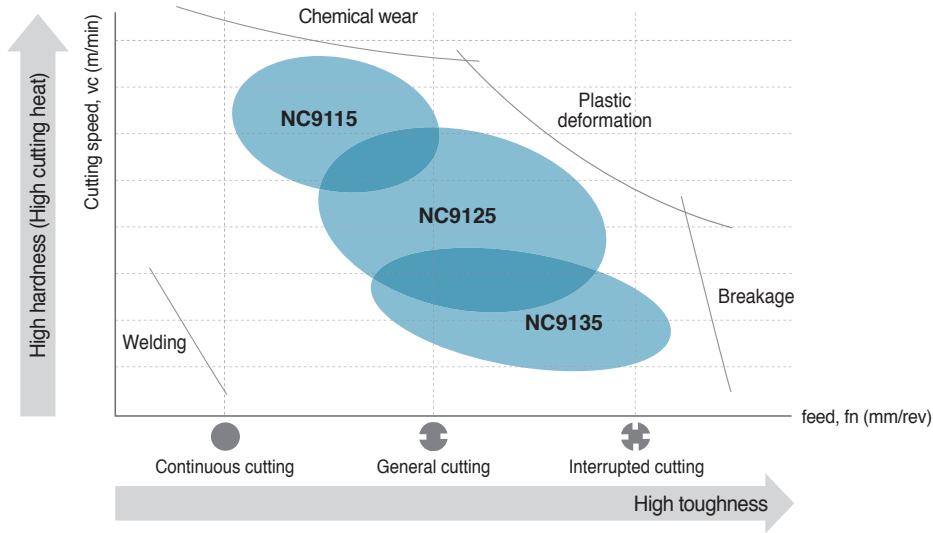

Recommended grade and chip breaker per stainless steel type

[Austenitic stainless steel]

Grade	Cutting speed (m/min)				
	50	100	150	200	250
NC9115				160	220
NC9125			150	200	
NC9135		100	150		

[Duplex stainless steel]

Grade	Cutting speed (m/min)				
	50	100	150	200	250
NC9115			120	160	
NC9125			100	140	
NC9135		60	100		

[Ferritic / Martensitic stainless steel]

Grade	Cutting speed (m/min)				
	50	100	150	200	250
NC9115			150		250
NC9125			120	220	
NC9135		100	150		

[Precipitation hardened (PH) stainless steel]

Grade	Cutting speed (m/min)				
	50	100	150	200	250
NC9115	50	110			
NC9125	40	110			
NC9135	30	100			



Selection system of CVD coated grade

Workpiece	Machining types	Recommended grade	Recommended cutting speed (m/min)	ISO	Application range
P Steel	Continuous cutting	NC3215	295 (170 ~ 420)	P10	
		NC3225	260 (150 ~ 370)	P15	← NC3215
	Interrupted cutting	NC3120	260 (120 ~ 370)	P20	
		NC3030	205 (120 ~ 290)	P25	← NC3225
		NC5330	205 (120 ~ 290)	P30	← NC3120
M Stainless steel	Continuous cutting	NC9115 ^{new}	240 (220 ~ 260)	M10	
		NC9125 ^{new}	210 (190 ~ 230)	M20	← NC9115 ^{new}
	Interrupted cutting	NC9135 ^{new}	180 (160 ~ 200)	M30	
				M40	← NC9125 ^{new}
K Cast iron	Continuous cutting	NC6310 ^{new}	380 (300 ~ 500)	K10	
		NC6315	280 (200 ~ 400)	K20	← NC6310 ^{new}
	Interrupted cutting	NC5330	190 (110 ~ 270)	K30	← NC6315
S HRSA	Continuous cutting	NC9125 ^{new}	40 (20 ~ 60)	S10	
	Interrupted cutting	NC9135 ^{new}		S20	← NC9125 ^{new}

The features of CVD coated grades

CVD Coated grades	ISO	Features
NC3215	P10 ~ P15	<ul style="list-style-type: none"> Continuous machining of general steel and forged steel at high speed Substrate with excellent thermal crack/plastic deformation resistance, coating with improved chipping resistance for continuous machining • MT-TiCN + Al₂O₃ + TiN
NC3225	P20 ~ P25	<ul style="list-style-type: none"> Universal grade for general steel and forged steel 1st recommended grade for general machining with the use of high toughness substrate and coating layer with improved welding/chipping resistance • MT-TiCN + Al₂O₃ + TiN
NC3120	P20 ~ P25	<ul style="list-style-type: none"> Medium to roughing for steel Combining excellent fracture resistance substrate with chipping resistance and heat resistance Al₂O₃ increased stability • MT-TiCN + TiC + Al₂O₃
NC3030	P25 ~ P35	<ul style="list-style-type: none"> Medium to low speed machining of steel and interrupted roughing Harmony between substrate with excellent wear/fracture resistance and Al₂O₃ film with excellent thermal/chipping resistance Increased stability in wide ranges of cutting conditions • MT-TiCN + TiC + Al₂O₃ + TiN
NC5330	P30 ~ P35 M25 ~ M35 K15 ~ K25 S15 ~ S25	<ul style="list-style-type: none"> Stainless Steel - General cutting for mild steel & forging steel Excellent cutting performance in hard to cut materials which are vulnerable to built up edge, due to the high tough substrate with improved fracture resistance and the coated layers • MT-TiCN + Al₂O₃ + TiN
NC9115 ^{new}	M10 ~ M20	<ul style="list-style-type: none"> High speed cutting for ferritic and martensitic stainless steels • MT-TiCN + Al₂O₃ + TiN
NC9125 ^{new}	M20 ~ M30	<ul style="list-style-type: none"> General cutting of stainless steel and heat resistant alloys • MT-TiCN + Al₂O₃ + TiN
NC9135 ^{new}	M30 ~ M40	<ul style="list-style-type: none"> Interrupted cutting of stainless steel and heat resistant alloys • MT-TiCN + Al₂O₃ + TiN
NC6310 ^{new}	K01 ~ K10	<ul style="list-style-type: none"> High speed and continuous cutting of grey cast iron Increased tool life due to coating layer with high wear resistance • MT-TiCN + Al₂O₃ + TiN
NC6315	K10 ~ K20	<ul style="list-style-type: none"> Universal grade for ductile and gray cast iron Excellent performance thanks to the alumina (Al₂O₃) coating's improved grip on the tough substrate • MT-TiCN + Al₂O₃



Application examples (NC3215/NC3225)

P Carbon steel (SM20C)

- Workpiece** Part for fuel system
- Cutting condition** vc (m/min) = 250~380, fn (mm/rev) = 0.2~0.3
 ap (mm) = 1.5~2.0, wet
- Designation** Insert : CNMG120412-MP (NC3215)
Holder : PCLNL2525-M12
- Test result**

Tool	Cutting pass/Corner
NC3215	180
Competitor	150

P Alloy steel (SNCM, cast)

- Workpiece** Part for engine
- Cutting condition** vc (m/min) = 100, fn (mm/rev) = 0.15
 ap (mm) = 3.0, wet
- Designation** Insert : CNMG120408-MP (NC3225)
Holder : PCLNR2525-M12
- Test result**

Tool	Cutting pass/Corner
NC3225	60
Competitor	45

P Carbon steel (SM40C, cold forging)

- Workpiece** Part for steering
- Cutting condition** vc (m/min) = 170, fn (mm/rev) = 0.3
 ap (mm) = 2.7~3.0, wet
- Designation** Insert : DNMG150408-MP (NC3215)
Holder : DDJNL2525-M15
- Test result**

Tool	Cutting pass/Corner
NC3215	180
Competitor	150

P Carbon steel (S55CR, hot forging)

- Workpiece** Part for steering
- Cutting condition** vc (m/min) = 230, fn (mm/rev) = 0.3
 ap (mm) = 0.5~1.5, wet
- Designation** Insert : CNMG120408-MP (NC3225)
Holder : PCLNL2525-M12
- Test result**

Tool	Cutting pass/Corner
NC3225	100
Competitor	80

P Carbon steel (SM45C, cold forging)

- Workpiece** Part for steering
- Cutting condition** vc (m/min) = 200~250, fn (mm/rev) = 0.25~0.35
 ap (mm) = 1.0~2.0, wet
- Designation** Insert : DNMG150612-LP (NC3215)
Holder : DDJNL2525-M15
- Test result**

Tool	Cutting pass/Corner
NC3215	120
Competitor	90

P Alloy steel (SCR420, cold forging)

- Workpiece** Part for mission
- Cutting condition** vc (m/min) = 160, fn (mm/rev) = 0.13
 ap (mm) = 1.0, wet
- Designation** Insert : DNMG150608-LP (NC3225)
Holder : DDJNL2525-M15
- Test result**

Tool	Cutting pass/Corner
NC3225	110
Competitor	80



Application examples (NC3225)

P Alloy steel (SCR420H, hot forging)

- **Cutting condition** vc (m/min) = 360~430, fn (mm/rev) = 0.2
 ap (mm) = 1.2~1.5 (external machining/facing), wet

- **Designation** Insert : CNMG120408-VB (NC3225)
Holder : PCLNR2225-M12

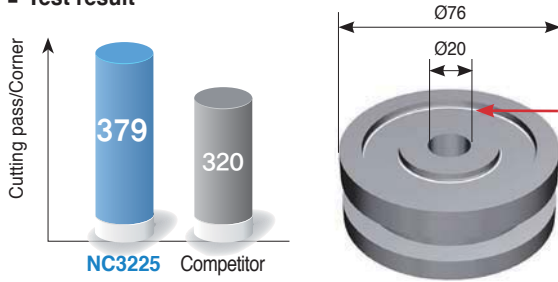
■ **Test result****P Carbon steel (SM48C, cold forging)**

- **Cutting condition** vc (m/min) = 280, fn (mm/rev) = 0.2~0.25
 ap (mm) = 1, dry

- **Designation** Insert : CNMG120412-VB (NC3225)
Holder : PCLNR2525-M12

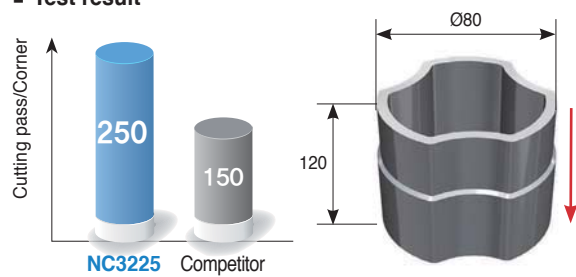
■ **Test result****P Alloy steel (SCM420H, hot forging)**

- **Cutting condition** vc (m/min) = 80~500
 fn (mm/rev) = 0.15~0.3 (External machining/facing/grooving/tapping), ap (mm) = 0.7~1.5, wet

- **Designation** Insert : DNMG150608-VB (NC3225)
Holder : PDJNR2525-M15

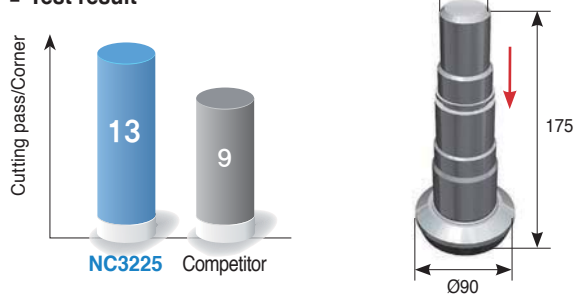
■ **Test result****P Carbon steel (SM53C, cold forging)**

- **Cutting condition** vc (m/min) = 280
 fn (mm/rev) = 0.2~0.25 (External machining/internal machining), ap (mm) = 1, dry

- **Designation** Insert : DNMG150608-VB (NC3225)
Holder : PDJNR2525-M15

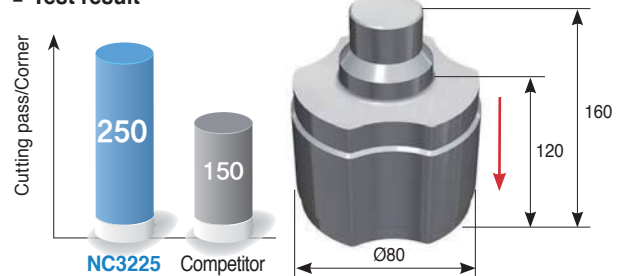
■ **Test result****P Alloy steel (SCR series, cold forging)**

- **Cutting condition** vc (m/min) = 314
 fn (mm/rev) = 0.25 (external machining/facing)
 ap (mm) = 1, wet

- **Designation** Insert : CNMG120408-VM (NC3225)
Holder : PCLNR2525-M12

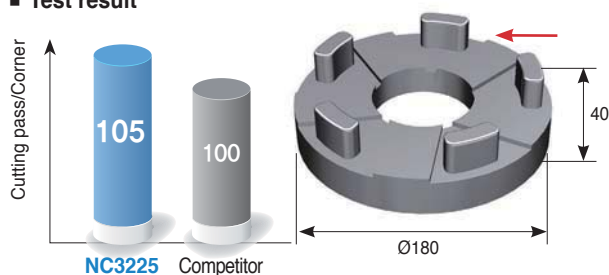
■ **Test result**

Application examples (NC6310)

K Ductile cast iron (GCD500)

- **Workpiece** Fly wheel
- **Cutting condition** vc (m/min) = 450, n (rpm) = 550, fn (mm/rev) = 0.3, ap (mm) = 2, dry
- **Designation** Insert : CNMG120408-MK (NC6310)
Holder : DCLNR2525

■ Test result

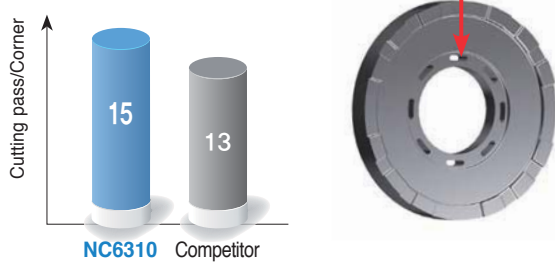

K Gray cast iron (GC250D)

- **Workpiece** Break disc
- **Cutting condition** vc (m/min) = 550, n (rpm) = 547, fn (mm/rev) = 0.3, ap (mm) = 1, wet
- **Designation** Insert : CNMA120412 (NC6310)
Holder : DCLNR2525

■ Test result

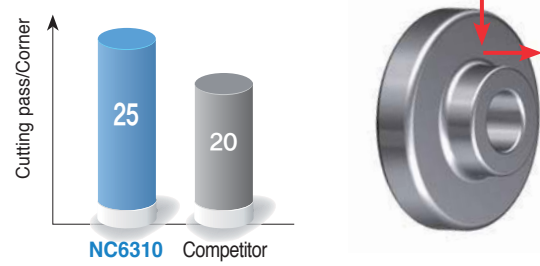

K Gray cast iron (GC250D)

- **Workpiece** Cylinder Liner
- **Cutting condition** vc (m/min) = 450, n (rpm) = 1100, fn (mm/rev) = 0.25, ap (mm) = 1.5, dry
- **Designation** Insert : CNMA120408 (NC6310)
Holder : DCLNR2525

■ Test result

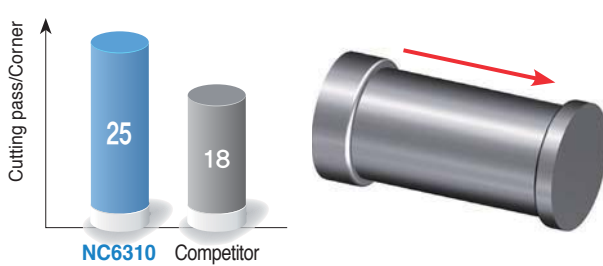

K Gray cast iron (GC300D)

- **Workpiece** Fly wheel housing
- **Cutting condition** vc (m/min) = 560, n (rpm) = 298, fn (mm/rev) = 0.3, ap (mm) = 1, wet
- **Designation** Insert : CNMG120412-RK (NC6310)
Holder : DCLNR2525

■ Test result

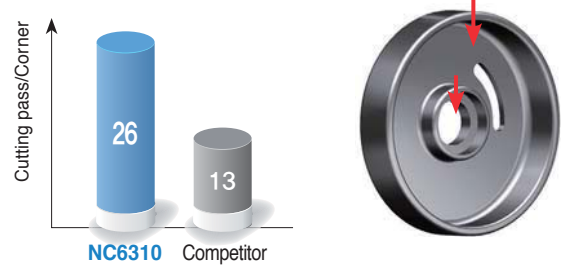

Application examples (NC6315)

K Ductile cast iron (GCD500)

- **Workpiece** Hub
- **Cutting condition** vc (m/min) = 320, n (rpm) = 318, fn (mm/rev) = 0.4, ap (mm) = 2, wet
- **Designation** **Insert** : WNMG080412-RK (NC6315)
Holder : DCLNR2525

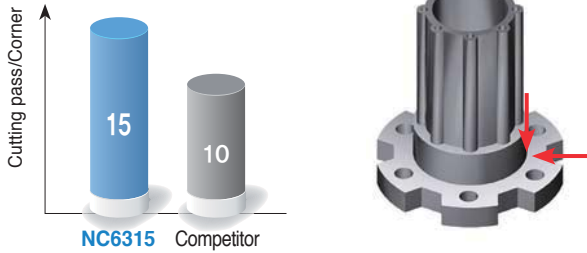
■ **Test result****K Ductile cast iron (GCD500)**

- **Workpiece** Fly wheel
- **Cutting condition** vc (m/min) = 400, n (rpm) = 398, fn (mm/rev) = 0.3, ap (mm) = 2, wet
- **Designation** **Insert** : CNMA120408 (NC6315)
Holder : DCLNR2525

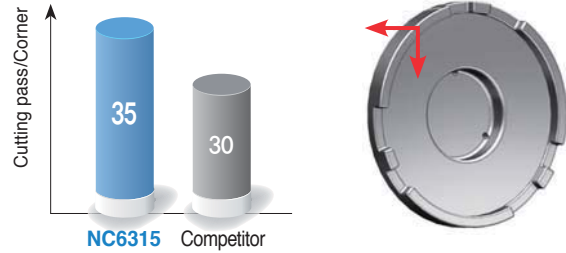
■ **Test result****K Ductile cast iron (GCD700)**

- **Workpiece** Diff. case mission
- **Cutting condition** vc (m/min) = 360, n (rpm) = 716, fn (mm/rev) = 0.25, ap (mm) = 1.5, wet
- **Designation** **Insert** : CNMG120408-MK (NC6315)
Holder : DCLNR2525

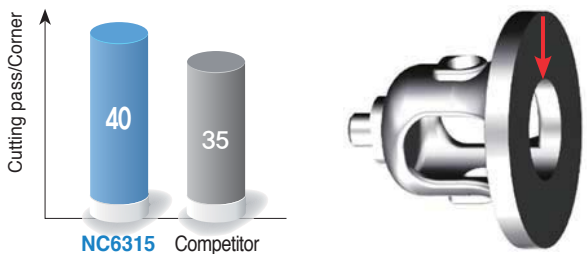
■ **Test result****K Ductile cast iron (GCD500)**

- **Workpiece** Knuckle
- **Cutting condition** vc (m/min) = 200, n (rpm) = 1100, fn (mm/rev) = 0.25, ap (mm) = 2, wet
- **Designation** **Insert** : DNMG150608-MK (NC6315)
Holder : DDJLNR2525

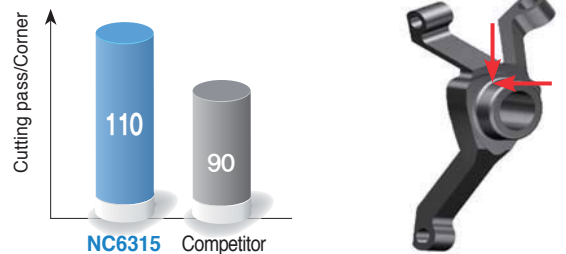
■ **Test result**

Application examples (NC9100 Series)

M Stainless steel (STS304)

- **Workpiece** Hydraulics part (Mechanical seal)
- **Cutting condition** vc (m/min) = 140, fn (mm/rev) = 0.28, ap (mm) = 3.0, wet
- **Designation** Insert : CNMG120408-MM (NC9125)
Holder : S32S-PCLCR-12

■ Test result

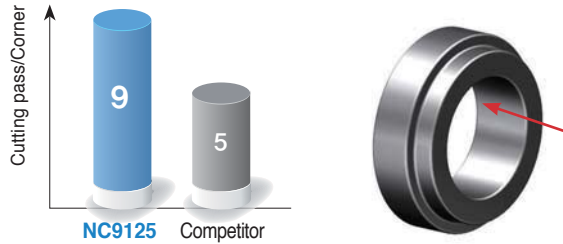

M Stainless steel (STS304)

- **Workpiece** Valve part (Piston valve)
- **Cutting condition** vc (m/min) = 140, fn (mm/rev) = 0.28, ap (mm) = 3.0, wet
- **Designation** Insert : CNMG120408-MM (NC9125)
Holder : DCLNL2525-M12

■ Test result

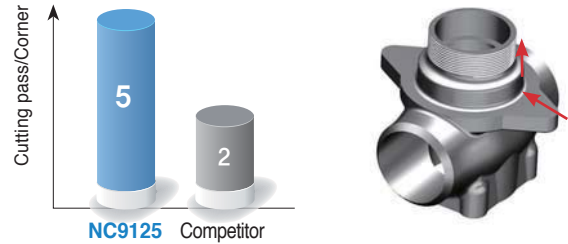

M Stainless steel (STS317L)

- **Workpiece** Wind power/offshore plant part (Flange)
- **Cutting condition** vc (m/min) = 150, fn (mm/rev) = 0.3~0.5, ap (mm) = 4.0~6.0, wet
- **Designation** Insert : CNMG160616-MM (NC9125)
Holder : PCLNR3232-P16

■ Test result

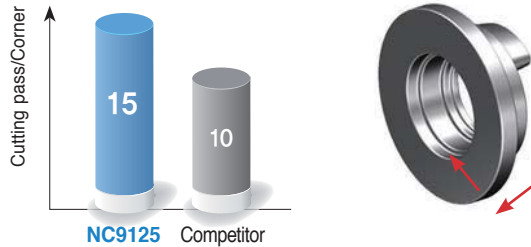

M Stainless steel (STS316)

- **Workpiece** Wind power plant part (Flange)
- **Cutting condition** vc (m/min) = 175, fn (mm/rev) = 0.3~0.8, ap (mm) = 0.5, wet
- **Designation** Insert : TNMG220416-RM (NC9135)
Holder : PTFNR3232-P22

■ Test result



M Stainless steel (Super duplex)

- **Workpiece** Plant part (Flange)
- **Cutting condition** vc (m/min) = 100, fn (mm/rev) = 0.5, ap (mm) = 3, wet
- **Designation** Insert : CNMG160616-MM (NC9125)
Holder : PCLNR323-P16

■ Test result

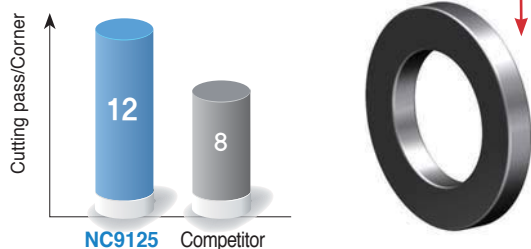

M Stainless steel (Duplex)

- **Workpiece** Hydraulics part
- **Cutting condition** vc (m/min) = 120, fn (mm/rev) = 0.4, ap (mm) = 6, wet
- **Designation** Insert : CNMG160616-RM (NC9125)
Holder : DCLNR3232-P16

■ Test result

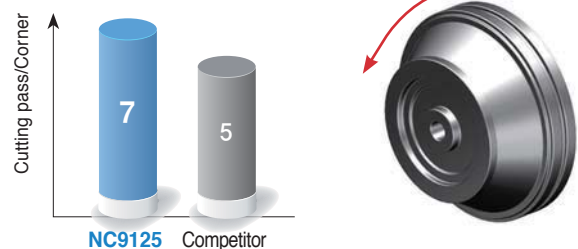

PVD coated grades

Turning grade for heat resistant alloy and stainless steel

PC8105

- Micro grain carbide minimizes chipping of cutting edge due to enhanced edge strength
- Latest PVD coating technology with high hardness and high temperature oxidation resistance
- Excellent tool life when finishing heat resistant alloys and stainless steels at high speeds

PC8110

- Substrate with superior wear resistance and plastic deformation resistance at high temperature
- PVD coating technology with high hardness and oxidation resistance at high temperature
- Long tool life when machining heat resistant alloy and stainless steel at high speed

PC8115

- Ultra fine matrix technology increases wear resistance and chipping resistance.
- PVD coating technology with high hardness and oxidation resistance at high temperature
- Strong cutting edge and excellent chipping resistance guarantees stable machining
- Long tool life when machining heat resistant alloy and stainless steel at middle to low speed and medium cutting to roughing

Grades line up

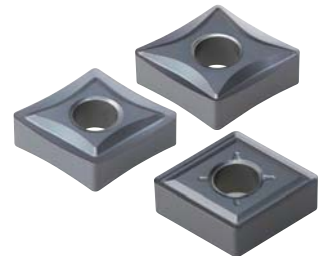
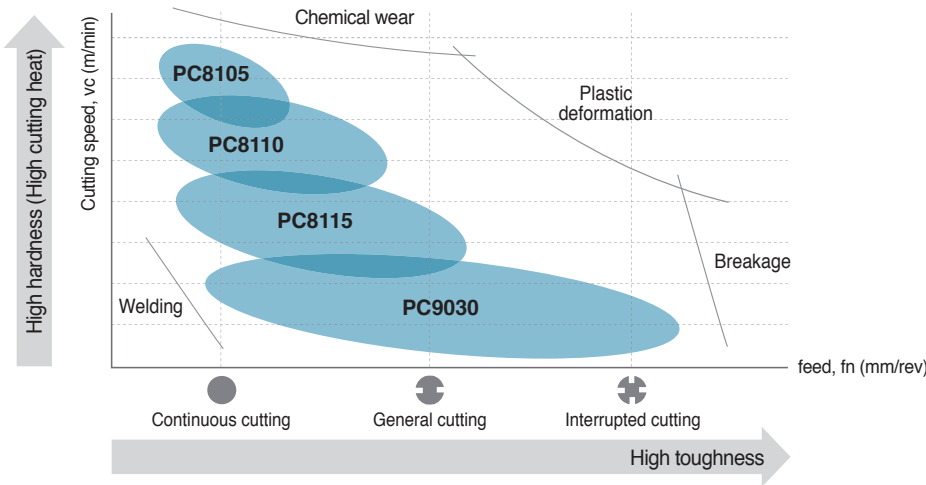

Features of PC8100 series

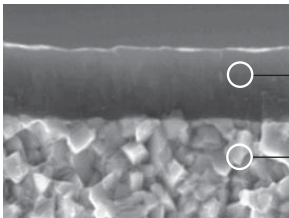

- It prevents wear at a high temperature to apply excellent surface roughness and coating with oxidation resistance and high hardness
- It improves wear resistance to equalize submicron matrix, secure stability between corners and improve chipping- and wear resistance

Coating surface treatment technology (Pictures of coating layer)

Soft coating surface

PC8100 Series

Rough coating surface

Conventional coating

Oxidation resistant coating technology (Pictures of coating layer heat-treated at 900°C)

Oxidized layer easily happens

PC8100 Series

Oxidized layer is prevented

Competitor



A Turning Grades

Selection system of PVD coated grade

Workpiece	Machining types	Recommended grade	Recommended cutting speed (m/min)	ISO	Application range	
P	Steel	PC5300	175 (100 ~ 250)	P30	PC5300	
			145 (80 ~ 120)	P40		PC5400
	Interrupted cutting	PC5400	125 (80 ~ 160)	P50		
M	Continuous cutting	PC8105	175 (120 ~ 230)	M01	PC8105	
		PC8110	160 (110 ~ 210)	M10		PC8110
		PC8115	150 (100 ~ 200)	M20		PC8115
	Interrupted cutting	PC5300	135 (80 ~ 190)	M30	PC5300	
		PC9030	130 (80 ~ 180)	M40	PC9030	
		PC5400	110 (80 ~ 140)	M50	PC5400	
K	Continuous cutting	PC8110	135 (95 ~ 180)	K10	PC8110	
				K20	PC5300	
	Interrupted cutting	PC5300	105 (75 ~ 140)	K30	PC5400	
		PC5400	90 (65 ~ 120)	K40		
S	Continuous cutting	PC8105	55 (40 ~ 70)	S01	PC8105	
		PC8110	50 (35 ~ 65)	S10	PC8110	
		PC8115	45 (30 ~ 60)	S20	PC8115	
	Interrupted cutting	PC5300	40 (20 ~ 60)	S30	PC5300	
		PC5400	35 (20 ~ 50)	S40	PC5400	
H	Interrupted cutting	PC8105	110 (80 ~ 140)	H01	PC8105	
		PC8110	100 (70 ~ 130)	H05	PC8110	
		PC8115	90 (65 ~ 115)	H10	PC8115	

The features of PVD coated grades

PVD Coated grades	ISO	Features
PC8105	M05 ~ M15 S01 ~ S10 H01 ~ H05	<ul style="list-style-type: none"> For high speed and continuous finishing of hard-to-cut materials and STS Excellent cutting performance with high wear resistance and oxidation resistance Ultra fine substrate and the new TiAlN coating layer
PC8110	M10 ~ M20 K10 ~ K20 S05 ~ S15 H05 ~ H10	<ul style="list-style-type: none"> For high speed and continuous medium cutting of hard-to-cut materials and STS Excellent tool life with high wear/plastic deformation resistance at high temperature New TiAlN coating layer and substrate with excellent thermal resistance
PC8115	M15 ~ M25 S10 ~ S20 H10 ~ H15	<ul style="list-style-type: none"> For medium to low speed and medium to rough cutting of hard-to-cut materials and STS Excellent tool life with high wear resistance and chipping resistance Ultra fine substrate and the new TiAlN coating layer
PC5300	P30 ~ P40 M20 ~ M30 K20 ~ K25 S15 ~ S25	<ul style="list-style-type: none"> Universal grade for stainless, HRSA, steel and interrupted cast iron machining High chipping and welding resistance for longer tool life New TiAlN coating and ultra fine grain substrate adopted
PC9030	M25 ~ M35	<ul style="list-style-type: none"> Medium, roughing and heavy interrupted cutting for stainless steel TiAlN coating and ultra fine grain substrate adopted High chipping and welding resistance for stable machining
PC5400	P35 ~ P45 M30 ~ M40 K30 ~ K35 S25 ~ S35	<ul style="list-style-type: none"> For medium cutting for hard-to-cut materials, stainless steel, steel, and cast iron at medium or low speed Stable machinability with chipping resistance, fracture resistance and welding resistance Ultra fine substrate with high toughness and new AlCrN layer



Application examples (PC8105/PC8110/PC8115)

S Inconel 718

- **Cutting condition** vc (m/min) = 50
 fn (mm/rev) = 0.15
 ap (mm) = 0.5, wet

- **Designation** **Insert** : CNMG120408-VP3 (PC8105)
Holder : PCLNR2525-M12

- **Test result**



PC8105

Competitor A

Competitor B

S Inconel 718

- **Cutting condition** vc (m/min) = 50
 fn (mm/rev) = 0.15
 ap (mm) = 1.5, wet

- **Designation** **Insert** : CNMG120408-VP3 (PC8115)
Holder : PCLNR2525-M12

- **Test result**



PC8115

Competitor

Conventional grade

M Stainless steel (STS316L)

- **Cutting condition** vc (m/min) = 80
 fn (mm/rev) = 0.2
 ap (mm) = 7.0, wet

- **Designation** **Insert** : CNMG120408-VP3 (PC8115)
Holder : PCLNR2525-M12

- **Test result**

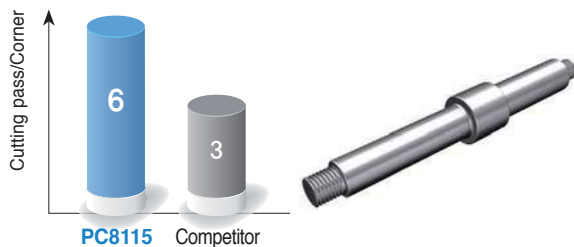

PC8115

Competitor

S Inconel 625

- **Cutting condition** vc (m/min) = 60
 fn (mm/rev) = 0.2
 ap (mm) = 2, wet

- **Designation** **Insert** : DNMG150608-MM (PC8110)
Holder : DDLNL2525-MS15

- **Test result**

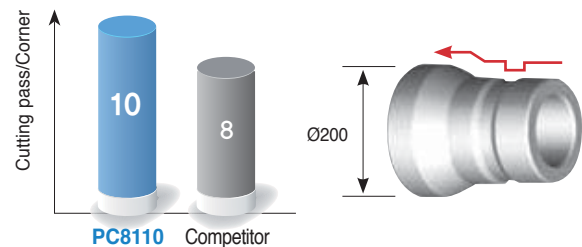

PC8110

Competitor

Ø200

A Turning Grades

Uncoated carbide grades

Uncoated carbide grades for turning application of titanium

H01

- Increased wear resistance and chipping resistance with the use of ultra fine substrate
- Improved welding resistance and chipping resistance with the use of special surface treatment and sharp cutting edge of VP chip breaker
- Excellent tool life when finishing titanium alloy at high speed

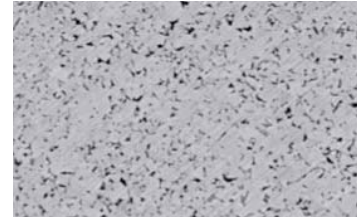

H05

- The 1st recommended grade for machining titanium alloy in a variety of cutting conditions
- Improved welding resistance and chipping resistance with the use of special surface treatment and sharp cutting edge of VP chip breaker
- Ideal for medium cutting of titanium alloy

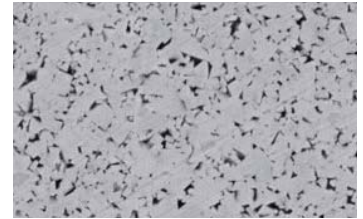

Grades line up

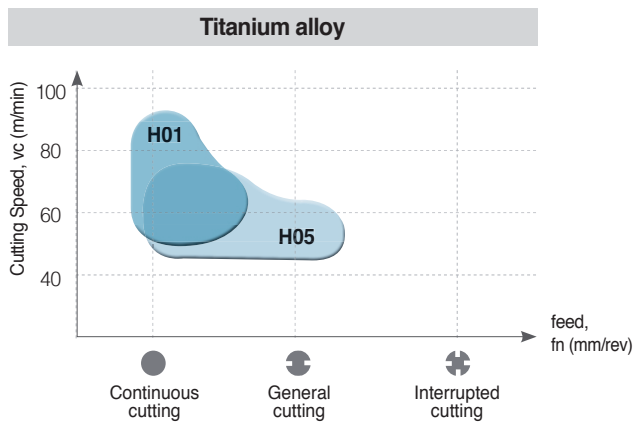

Selection system of uncoated carbide grades

Workpiece	Recommended grade	Recommended cutting speed (m/min)	ISO	Application range
P Steel	ST10	110 (70 ~ 140)	P10	← ST10
	ST20	80 (50 ~ 110)	P20	← ST20
	ST30A	70 (40 ~ 90)	P30	← ST30A
M Stainless steel	U20	70 (40 ~ 90)	M25	← U20
K Cast iron	H01	105 (60 ~ 140)	K01	← H01
	H05	105 (60 ~ 140)	K10	← H05
	G10	90 (50 ~ 120)	K20	← G10
N Aluminum alloy	H01	600 (450 ~ 750)	N10	← H01
N Copper alloys	H05	425 (320 ~ 530)	N20	← H05
S Titanium alloy	H01	55 (40 ~ 70)	S01	← H01
	H05	50 (35 ~ 65)	S10	← H05
H High hardness steel	H01	80 (55 ~ 105)	H10	← H01

Main composition and application range

Workpiece	Composition	Features	Workpiece
P	WC-TiC-TaC-Co	Heat resistance, excellent plastic deformation resistance	Carbon steel, Alloy steel, Stainless steel
M	WC-TiC-TaC-Co	General tools stable heat resistance with strength	Carbon steel, Alloy steel, Stainless steel, Cast steel
K	WC-Co	High strength and superior wear resistance	Cast iron, Non-ferrous metal, Plastic, etc
S	WC-Co	Excellent wear resistance and chipping resistance	Titanium alloy



➤ The physical properties of uncoated carbide grades

Workpiece	Grade	Hardness (HRA)	TRS (kgf/mm ²)	Young's modulus (10 ³ kgf/mm ²)	Thermal expansion coefficient (10 ⁻⁶ /°C)	Thermal conductivity (cal/cm · sec·°C)
P	ST10	92.1	175	48	6.2	25
	ST20	91.9	200	56	5.2	45
	ST30A	91.3	230	53	5.2	-
M	U20	91.1	210	-	-	88
	ST30A	91.3	230	53	5.2	-
K	H01	92.9	210	66	4.7	109
	G10	90.9	250	63	-	105
S	H01	92.9	210	66	4.7	109
	H05	91.8	250	-	-	-

1KPa = 102kgf/m², 1w/mk = 2.39×10⁻³cal/cm·sec·°C

Application examples (H01/H05)

S Titanium alloy (Ti-6Al-4V)

- **Cutting condition** vc (m/min) = 100
fn (mm/rev) = 0.1
ap (mm) = 0.5, wet
- **Designation** Insert : CNMG120408-VP1 (H01)
Holder : PCLNR2525-M12
- **Test result**

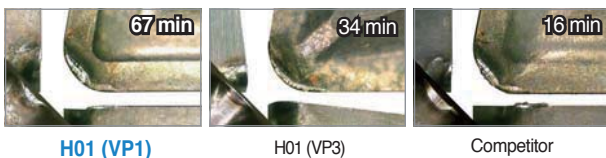

S Titanium alloy (Ti-6Al-4V)

- **Cutting condition** vc (m/min) = 80
fn (mm/rev) = 0.2
ap (mm) = 2.0, wet
- **Designation** Insert : CNMG120408-VP3 (H05)
Holder : PCLNR2525-M12
- **Test result**

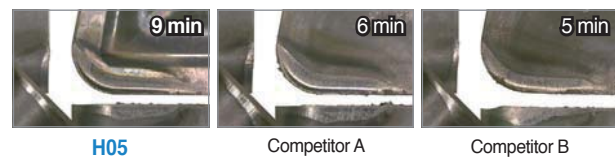

S Titanium alloy (Ti-6Al-4V)

- **Workpiece** Part of an industrial machine
- **Cutting condition** vc (m/min) = 60, fn (mm/rev) = 0.2
ap (mm) = 0.8, wet
- **Designation** Insert : CNMG120408-VP3 (H01)
Holder : PCLNR2525-M12
- **Test result**

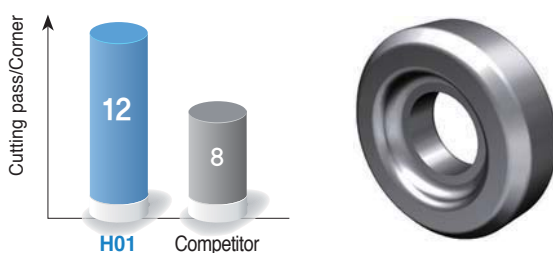

S Titanium alloy (Ti-6Al-4V)

- **Workpiece** Part of an industrial machine
- **Cutting condition** vc (m/min) = 50, fn (mm/rev) = 0.15
ap (mm) = 2.0, wet
- **Designation** Insert : CNMG120408-VP3 (H05)
Holder : PCLNL2525-M12
- **Test result**

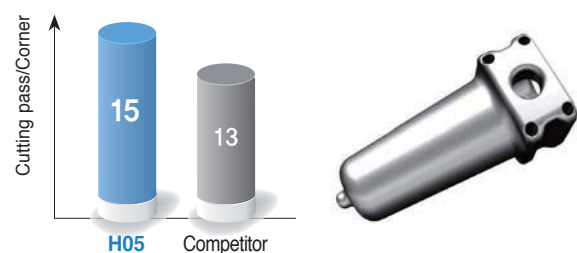

A Turning Grades

Cermet grades

Solution for turning application of steel

CN1500

- For continuous machining of cold/hot forged steel and Sintered ferrous alloy at high speed and low depth of cut
- Excellent wear resistance and crater resistance
- Improved surface roughness acquired by optimized cutting edges

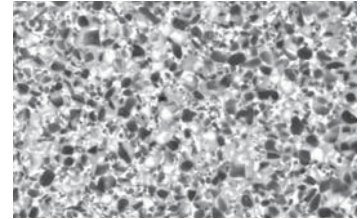

CN2500

- For high interrupted machining of cold/hot forged steel and Sintered ferrous alloy at high feed and high depth of cut
- Excellent resistance against chipping, fracture and thermal crack
- Improved surface roughness acquired by optimized cutting edges

Recommended cutting condition

Division	Workpiece	Grade	Recommended cutting speed (m/min)		
			Minimum	Recommended	Maximum
Turning	SM10C, SS440	CN1500	150	270	400
		CN2500	130	240	350
	SM45C	CN1500	150	250	350
		CN2500	130	220	300
	SCM440, Sintered fe ferrous alloy	CN1500	120	220	300
		CN2500	100	200	250

Grades line up

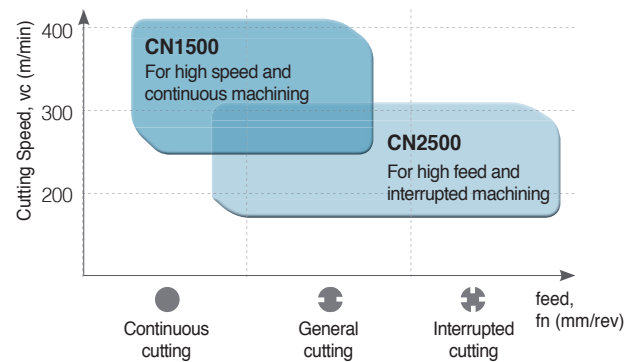

Chip breakers line up

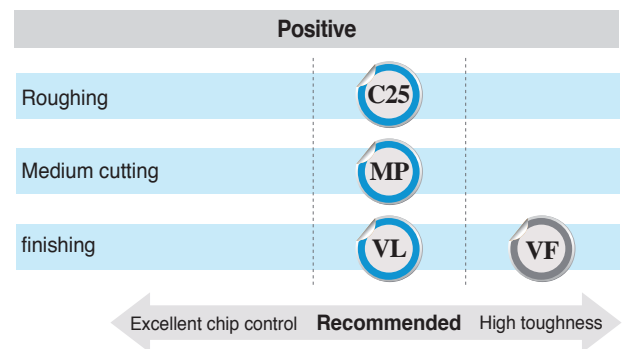
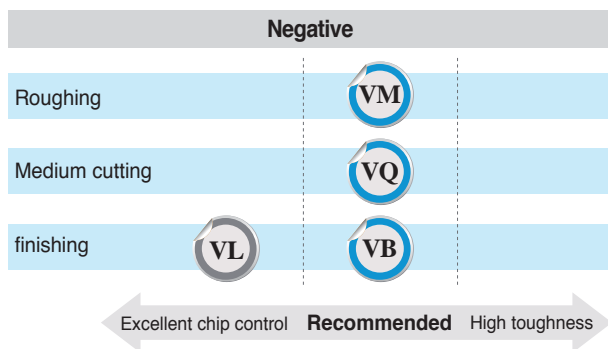

Selection system of cermet grades

Workpiece	Machining types	Recommended grade	Recommended cutting speed (m/min)	ISO	Application range
P Steel	Continuous cutting	CN1500	250 (150 ~ 350)	P10	
	Interrupted cutting	CN2500	220 (130 ~ 300)	P20	
				P30	



Comparison of chip breakers

Insert types	Machining types	Application range	Chip breakers				
			KORLOY	CompetitorA	CompetitorB	CompetitorC	CompetitorD
Nega type	Continuous cutting	For machining mild steel with enhanced chip control	VL	FA	GP	TF	FA
	General cutting	For low interrupted cutting with stronger cutting edges than VG chip breaker	VB	FG	XP CQ	TSF TS	LU SE
	General cutting	For medium cutting to finishing at low interruption	VQ	MC	HQ	AS, ZM	SU
	Interrupted cutting	For medium cutting to roughing at high interruption	VM	MT	HS	TM	GU
Posi type	Continuous cutting	For machining mild steel with enhanced chip control	VL	FA	GP	PF	FP
	Continuous cutting	Enhanced chip control when machining internal diameter with stronger cutting edges than VL chip breaker	VF	FG-PC	HQ	PS	LU
	General cutting	For medium cutting to finishing at low interruption	MP	FG	HQ	PS	LU
	Interrupted cutting	For medium cutting to roughing at high interruption	C25	MT	GK	24	SC

Application examples (CN1500)

P Carbon steel (SM45C)

- Cutting condition** vc (m/min) = 200, n (rpm) = 1,800
fn (mm/rev) = 0.1, ap (mm) = 0.3
wet
- Designation** Insert : CCMT09T304-MP (CN1500)
Holder : SCLCR2020-K09
- Test result**

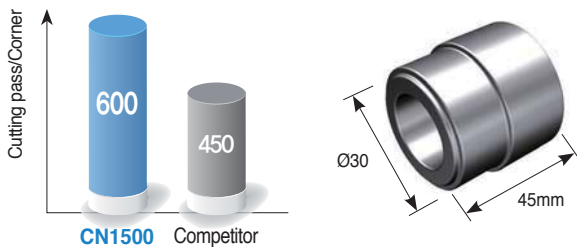

P Alloy steel (SCM430)

- Cutting condition** vc (m/min) = 230, n (rpm) = 2,000
fn (mm/rev) = 0.12, ap (mm) = 0.8
wet
- Designation** Insert : TNMG160404-VQ (CN1500)
Holder : DTGNR3232-P16
- Test result**

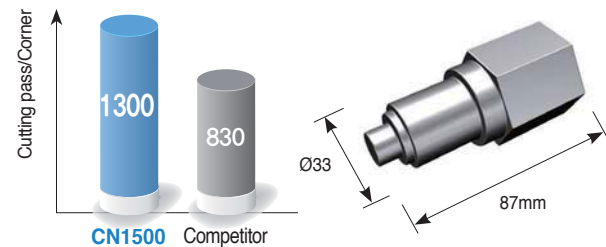

P Bearing steel (STB2)

- Cutting condition** vc (m/min) = 200, n (rpm) = 2,500
fn (mm/rev) = 0.1, ap (mm) = 0.3
wet
- Designation** Insert : DCMT11T302-VF (CN1500)
Holder : SDJCR2525-M11
- Test result**

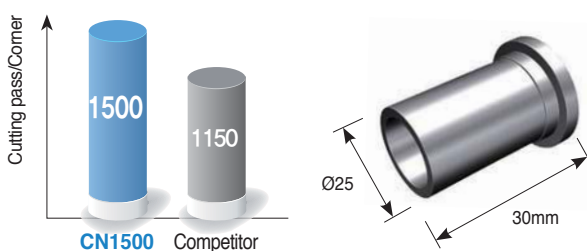

P Sintered ferrous alloy

- Cutting condition** vc (m/min) = 160, n (rpm) = 1,200
fn (mm/rev) = 0.17, ap (mm) = 0.2
wet
- Designation** Insert : SNMG120408-VM (CN1500)
Holder : MSRRR2525-M12
- Test result**

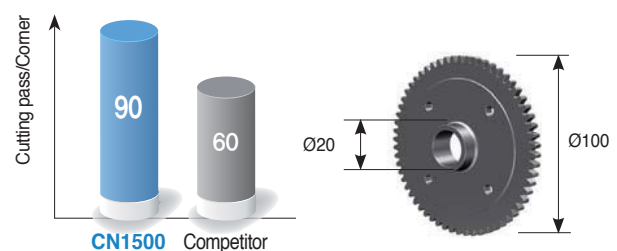

Application examples (CN2500)

P Carbon steel (SM45C)

■ **Cutting condition** vc (m/min) = 185, n (rpm) = 2,300
 fn (mm/rev) = 0.15, ap (mm) = 0.4
 wet

■ **Designation** Insert : CCMT09T304-MP (CN2500)
 Holder : SCLCR2020-K09

■ **Test result**

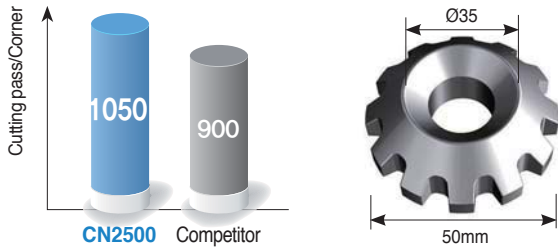

P Alloy steel (SCR420H)

■ **Cutting condition** vc (m/min) = 200, n (rpm) = 2,000
 fn (mm/rev) = 0.15, ap (mm) = 0.2
 wet

■ **Designation** Insert : DCMT11T304-MP (CN2500)
 Holder : SDJCR2525-M11

■ **Test result**

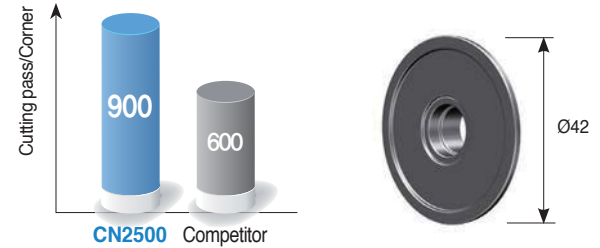

P Sintered ferrous alloy

■ **Cutting condition** vc (m/min) = 280, n (rpm) = 2,000
 fn (mm/rev) = 0.2, ap (mm) = 0.2
 wet

■ **Designation** Insert : VBMT160404-MP (CN2500)
 Holder : SVABL-2020-K16

■ **Test result**

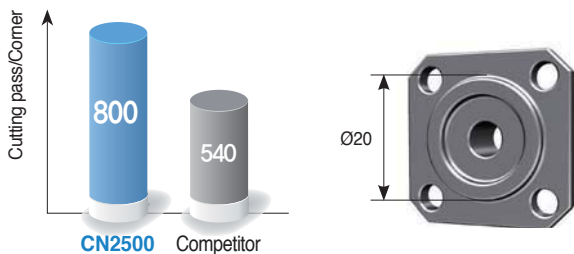

P Alloy steel (SCM415)

■ **Cutting condition** vc (m/min) = 300, n (rpm) = 2,200
 fn (mm/rev) = 0.25, ap (mm) = 0.3
 wet

■ **Designation** Insert : CNMG120408-VM (CN2500)
 Holder : PCLNR2525-M12

■ **Test result**

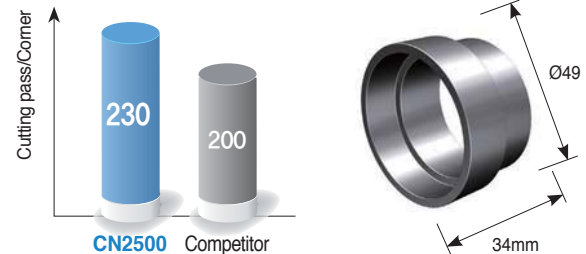

P Carbon steel (SM45C)

■ **Cutting condition** vc (m/min) = 300, n (rpm) = 2,800
 fn (mm/rev) = 0.25, ap (mm) = 0.4
 wet

■ **Designation** Insert : CNMG120404-VB (CN2500)
 Holder : PCLNR3232P-16

■ **Test result**

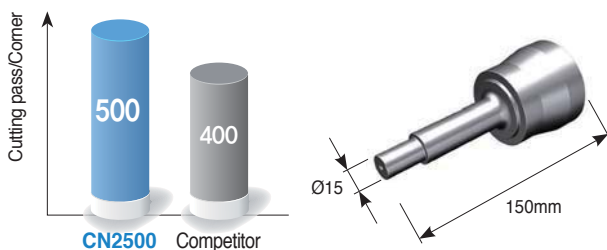

P Alloy steel (SCR420)

■ **Cutting condition** vc (m/min) = 200, n (rpm) = 2,300
 fn (mm/rev) = 0.2, ap (mm) = 0.3
 wet

■ **Designation** Insert : CCMT09T304-MP (CN2500)
 Holder : SCLCR2020-K09

■ **Test result**

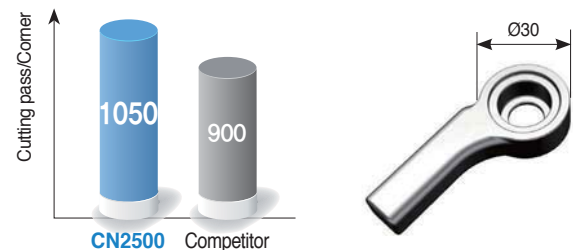

Coated cermet grades

Coated cermet for machining carbon steel, alloy steel and sintered ferrous components

CC1500 **new**

- Maximized resistance to built-up edge and oxidation in continuous cutting at high speeds and low depth of cuts
- Superior wear resistance vs. existing tools in continuous cutting of carbon steel and alloy steel

CC2500 **new**

- Maximized resistance to built-up edge and oxidation in interrupted cutting at high feeds and high depth of cuts
- Superior impact resistance vs. existing tools in interrupted cutting of carbon steel and alloy steel

Features

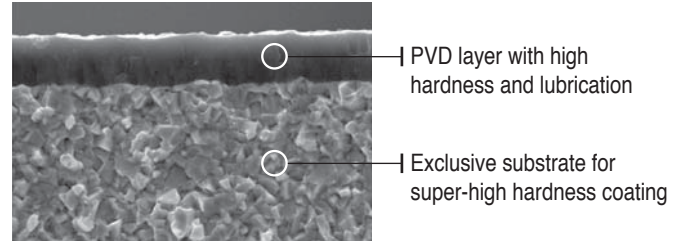

Recommended cutting condition

Division	Workpiece	Grade	Recommended cutting speed (m/min)		
			Minimum	Recommended	Maximum
Turning	SM10C, SS440	CN1500	200	350	450
		CN2500	180	290	400
	SM45C	CN1500	200	300	400
		CN2500	180	270	350
	SCM440, Sintered fe ferrous alloy	CN1500	180	270	350
		CN2500	150	250	300

Grades line up

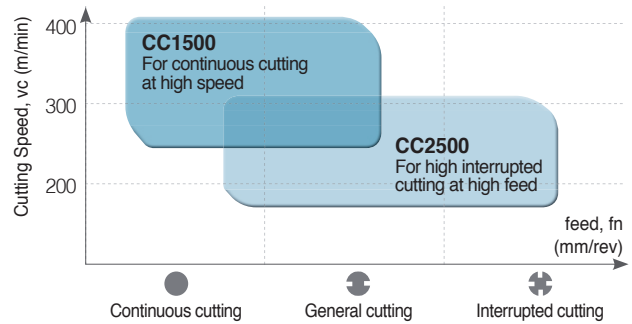

Chip breakers line up

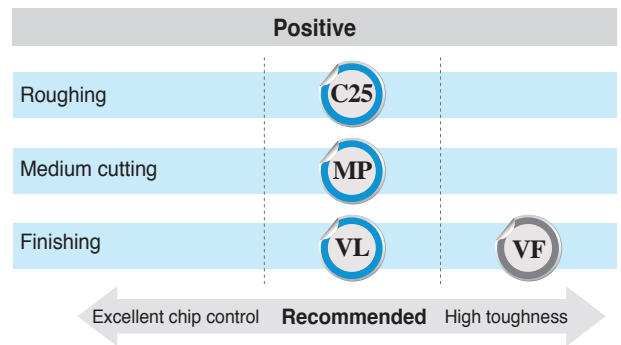
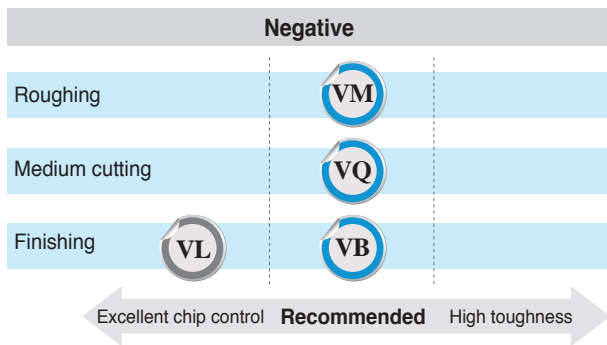

Selection system of coated cermet grades

Workpiece	Machining types	Recommended grade	Recommended cutting speed (m/min)	ISO	Application range
P Steel	Continuous cutting	CC1500	325 (200 ~ 450)	P10	← CC1500
	Interrupted cutting	CC2500	265 (180 ~ 350)	P20, P30	← CC2500
K Cast iron	Continuous cutting	CC1500	270 (180 ~ 350)	K10	← CC1500
	Interrupted cutting	CC2500	250 (150 ~ 300)	K20	← CC2500

The features of coated cermet grade

Coated cermet	ISO	Features
CC1500	P10 ~ P20 / K05 ~ K15	• PVD coated Cermet • Light cutting for steel and cast iron in high speed machining • Optimized for precision boring
CC2500	P20 ~ P30 / K10 ~ K20	• PVD coated Cermet • Light cutting for steel and cast iron in medium or high speed machining • Dry and wet cutting are available



Application examples (CC1500)

P Carbon steel (SM20C)

- **Workpiece** Nipple
- **Cutting condition** vc (m/min) = 170, n (rpm) = 2,000
 fn (mm/rev) = 0.12, ap (mm) = 0.12, wet
- **Designation** **Insert** : TPMT110304-MP (CC1500)
Holder : S20R-STWPR-11

■ Test result

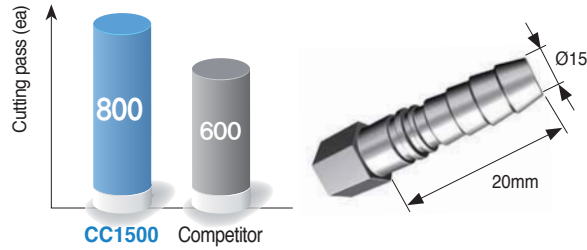

P Alloy steel (SCM440)

- **Workpiece** Plate carrier
- **Cutting condition** vc (m/min) = 450, n (rpm) = 2,500
 fn (mm/rev) = 0.2, ap (mm) = 0.2, wet
- **Designation** **Insert** : DCMT11T304-MP (CC1500)
Holder : SDJCR2525M11

■ Test result

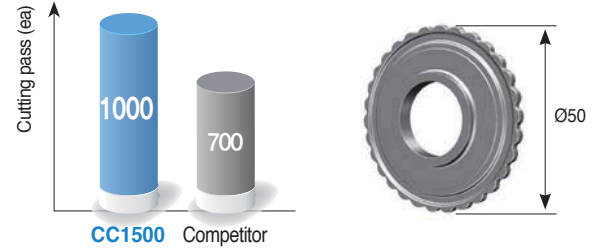

P Carbon steel (SM45C)

- **Workpiece** Cut plate carrier
- **Cutting condition** vc (m/min) = 300, n (rpm) = 2,500
 fn (mm/rev) = 0.3, ap (mm) = 0.4, wet
- **Designation** **Insert** : CCMT09T304-C25 (CC1500)
Holder : SCACR1212-F09

■ Test result

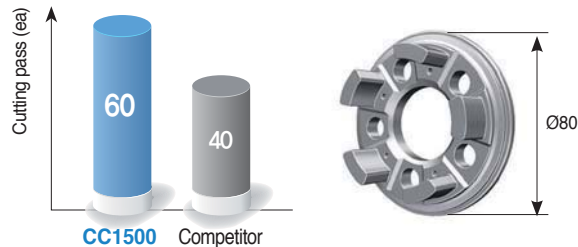

P Alloy steel (SCM420)

- **Workpiece** Pinion
- **Cutting condition** vc (m/min) = 250, n (rpm) = 2,500
 fn (mm/rev) = 0.2, ap (mm) = 0.5, wet
- **Designation** **Insert** : DNMG150604-VL (CC1500)
Holder : PDJNR2525-M15

■ Test result

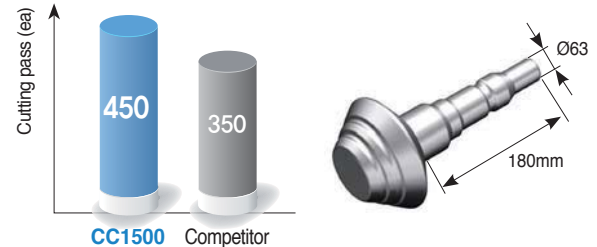

P Hot forging (SCM430)

- **Workpiece** Valve
- **Cutting condition** vc (m/min) = 230, fn (mm/rev) = 0.8
 ap (mm) = 0.12, wet
- **Designation** **Insert** : TNMG160404-VQ (CC1500)
Holder : PTTNR1616-H16

■ Test result

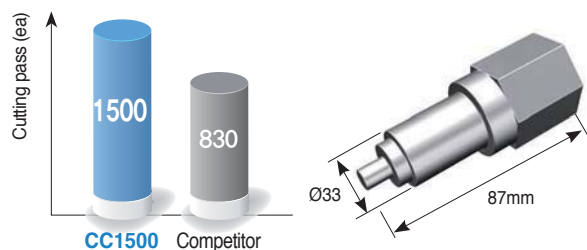

P Sintered ferrous alloy

- **Workpiece** Sprocket
- **Cutting condition** vc (m/min) = 160, fn (mm/rev) = 0.17
 ap (mm) = 0.2, wet
- **Designation** **Insert** : SNMG120408-VM (CC1500)
Holder : MSKNR3232-P12

■ Test result

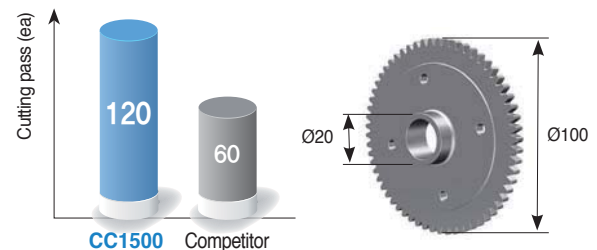

Application examples (CC2500)

P Carbon steel (SM45C)

- **Workpiece** Swash-Plate
- **Cutting condition** vc (m/min) = 250, n (rpm) = 890
 fn (mm/rev) = 0.06, ap (mm) = 0.1, wet
- **Designation** **Insert** : DNMG110404-VQ (CC2500)
Holder : SDJCR2525-M11

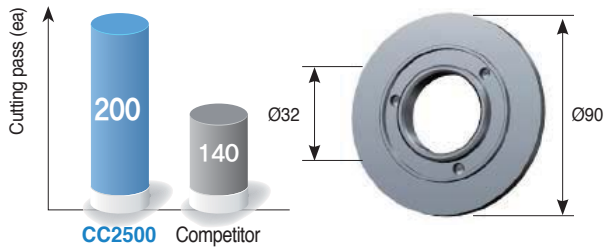
■ **Test result****K** Ductile cast iron (FCD400)

- **Workpiece** Diff. case
- **Cutting condition** vc (m/min) = 150, n (rpm) = 600
 fn (mm/rev) = 0.15, ap (mm) = 0.3, wet
- **Designation** **Insert** : VBMT160404-MP (CC2500)
Holder : SVJBR2525-M16

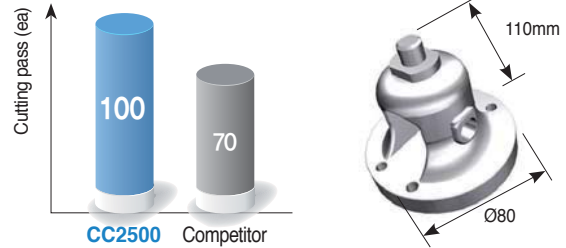
■ **Test result****P** Carbon steel (SM35C)

- **Workpiece** Piston Rod
- **Cutting condition** vc (m/min) = 122, n (rpm) = 4,800
 fn (mm/rev) = 0.15, ap (mm) = 2.0, wet
- **Designation** **Insert** : DNMG150604-VM (CC2500)
Holder : MDQNR2525-M15

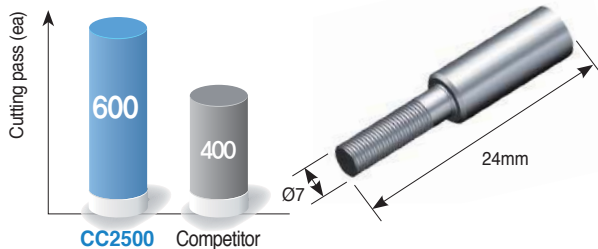
■ **Test result****P** Alloy steel (SCM420)

- **Workpiece** Connecting Rod
- **Cutting condition** vc (m/min) = 340, n (rpm) = 2,100
 fn (mm/rev) = 0.15, ap (mm) = 0.07, wet
- **Designation** **Insert** : TPMT110304-MP (CC2500)
Holder : S10M-STFPR-11

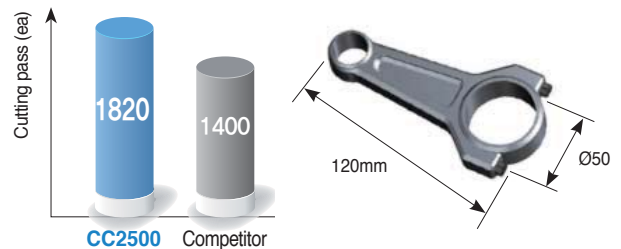
■ **Test result****P** Alloy steel (SCM415)

- **Workpiece** Bush
- **Cutting condition** vc (m/min) = 314, n (rpm) = 3,500
 fn (mm/rev) = 1, ap (mm) = 0.2, wet
- **Designation** **Insert** : CNMG120408-VQ (CC2500)
Holder : MCLNR2525-M12

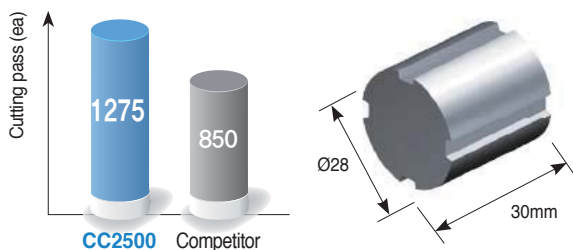
■ **Test result****P** Alloy steel (SWCH18A)

- **Workpiece** Shaft
- **Cutting condition** vc (m/min) = 367, n (rpm) = 5,800
 fn (mm/rev) = 0.02, ap (mm) = 1.55, wet
- **Designation** **Insert** : TBT4405R-D38-R0.25 (CC2500)
Holder : TBH425-45R

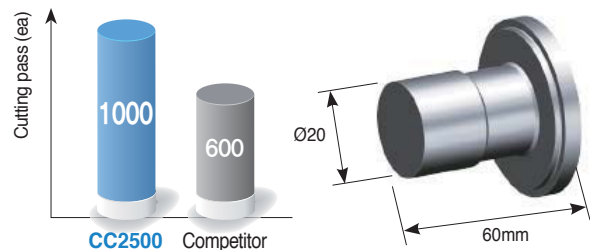
■ **Test result**

Milling grade selections

Selection system

Workpiece	P	Steel	M	Stainless steel	K	Cast iron	S	HRSA	N	Nonferrous	H	Hardened
ISO	P10	P20 P30 P40 P50	M10	M20 M30 M40	K01 K10	K20 K30 K40	S10	S20 S30 S40	N01	N10 N20 N30	H01	H10 H20 H30
Coated carbide		NC5330 PC3600 PC3700 <i>new</i> NCM535 <i>new</i> PC5300 NCM545 <i>new</i> PC5400		NC5330 PC5300 PC9530 PC5400 PC9540 <i>new</i>		PC6510 NC5330 PC5300 NCM535 <i>new</i> PC5400 NCM545 <i>new</i>			PC5300 PC5400 PC9540 <i>new</i>	ND3000 <i>new</i> PD1005 <i>new</i> PD1010 <i>new</i>		PC2005 PC2505 <i>new</i> PC2010 PC2510 <i>new</i> PC2015 PC210F
Cermet		CN2000 CN30										
cBN / PCD										DP90 DP150 DP200		DBN500
Uncoated carbide		ST20 ST30A		U20		H01 H05 G10				H01 H05		

Application range of milling grades

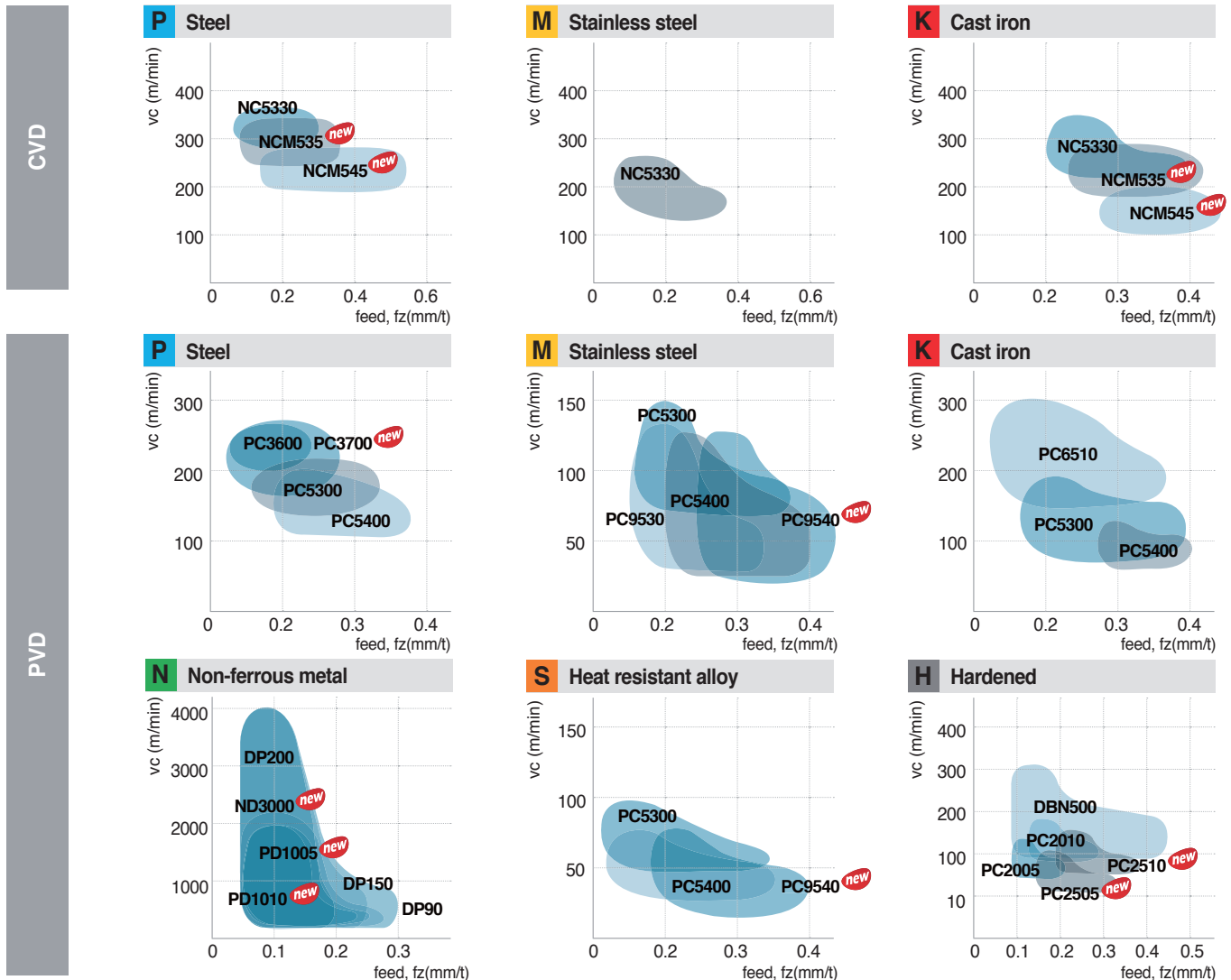

CVD coated grades

Milling Solutions for Steel and Cast Iron

NCM535 ^{new} / NCM545 ^{new}

- Improved chipping resistance / heat and crack resistance: Applied after treatment with good chipping resistance and heat and crack resistance
- Improved wear and heat resistance: Applied high toughness substrate and high functional CVD alumina

Features

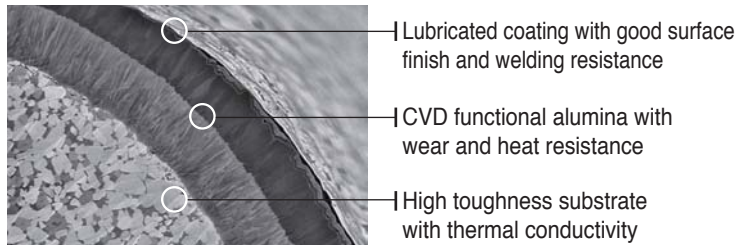

Guideline for grade application

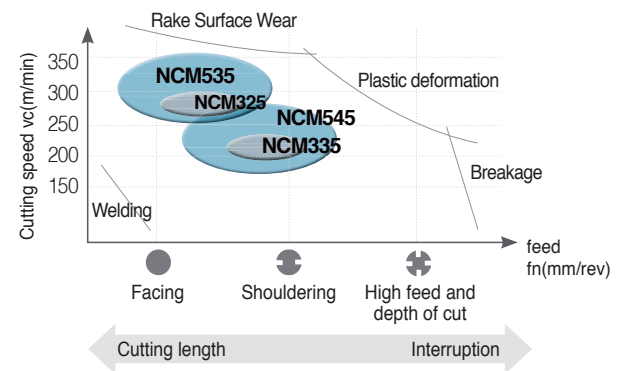

Selection system of CVD coated grades

Workpiece	Machining types	Recommended grade	Recommended cutting speed (m/min)	ISO	Application range
P Steel	Continuous cutting	NC5330	200 (150 ~ 250)	P20 P25	NC5330
	Continuous cutting	NCM535 ^{new}	300 (200 ~ 400)	P30 P35	NCM535
	Interrupted cutting	NCM545 ^{new}	200 (150 ~ 250)	P40 P45	NCM545
M Stainless steel	Continuous cutting	NC5330	150 (120 ~ 180)	M10 M20	NC5330
	Continuous cutting	NCM535 ^{new}	130 (100 ~ 150)	M25 M30	
	Interrupted cutting	NCM545 ^{new}	110 (90 ~ 130)	M35 M40	
K Cast iron	Continuous cutting	NC5330	200 (150 ~ 250)	K10 K20	NC5330
		NCM535 ^{new}	250 (200 ~ 300)	K30	NCM535
					NCM545 ^{new}

The features of CVD milling grades

CVD Coated grades	ISO	Features
NC5330	P20 ~ P30 M20 ~ M30 K15 ~ K25	<ul style="list-style-type: none"> • For high speed milling of steel and stainless steel • Superior wear resistance and chipping resistance grade for steel and stainless steel • MT-TiCN + Al₂O₃ + TiN
NCM535 ^{new}	P30 ~ P40 K20 ~ K30	<ul style="list-style-type: none"> • Rising CVD milling grade for high productivity in large steel and cast iron machining at high speed • High toughness and thermal conductivity substrate and high functional CVD coating layer with heat resistance • High chipping resistance and heat and crack resistance from excellent after treatment • MT-TiCN + Al₂O₃
NCM545 ^{new}	P40 ~ P50 K30 ~ K40	<ul style="list-style-type: none"> • For steel and cast iron milling with high toughness • High toughness substrate and high functional CVD coating layer • High chipping resistance and heat and crack resistance from excellent after treatment • MT-TiCN + Al₂O₃



Application examples (NCM535/NCM545)

P SS41(SS400)

- **Workpiece** Excavator
- **Cutting condition** $vc(m/min) = 350$, $fz(mm/t) = 0.12$, $ap(mm) = 2.0$, Cutter: $\varnothing 250$
- **Designation** Insert : SNMX1507ENN-MM

■ Test result

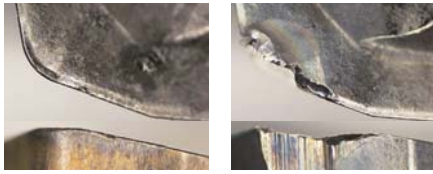

NCM535

PC5300

P API X83

- **Workpiece** Steel pipe, pipe t:12.5
- **Cutting condition** $f(m/min) = 3$, $ap(mm) = 6\sim 12$ ($\varnothing 850$, 65t)
- **Designation** Insert : TPEW3106ZS-IN

■ Test result

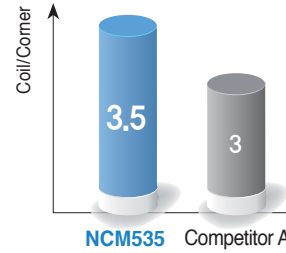

P API X55

- **Workpiece** Steel pipe, $\varnothing 60.3$, 4.7t
- **Cutting condition** $n(rpm) = 350\sim 450$, $fn(mm/rev) = 0.6$, $ap(mm) = 2\sim 4$
- **Designation** Insert : TPKR2204PDR-MX

■ Test result

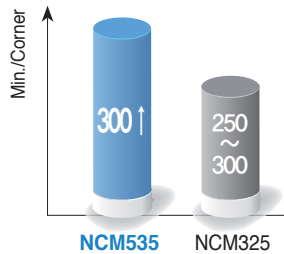

NCM535



NCM325

P SCM440

- **Workpiece** Large vessel parts
- **Cutting condition** $vc(m/min) = 73.4$, $fn(mm/rev) = 1.5$, $ap(mm) = 1\sim 40$
- **Designation** Insert : SDMT090308-MM

■ Test result

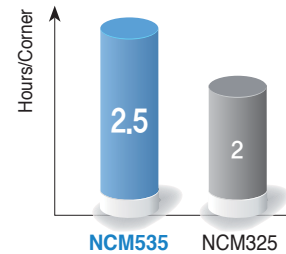

NCM535



NCM325

P Steel

- **Workpiece** Pipe
- **Cutting condition** $vc(m/min) = 150$, Private plane
- **Designation** Insert : WNMX251220-X373

■ Test result

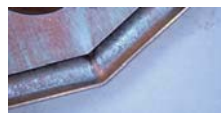
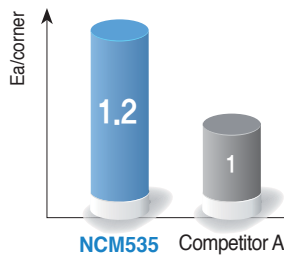

NCM535



Competitor A

P PL-52-LHRE 145660

- **Workpiece** Oil pipeline, Pipe t: 9.15
- **Cutting condition** $n(rpm) = 280$, $f(m/min) = 24$, $ap(mm) = 3.2\sim 5.9$
- **Designation** Insert : LNMN500604

■ Test result

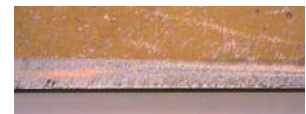
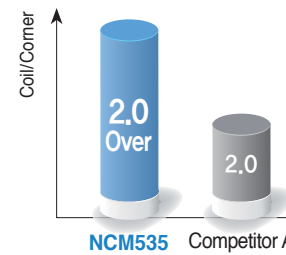

NCM535



Competitor A



PVD coated grades

PVD coated grades for finishing high hardened steel

PC2005 / PC2010 / PC2015

- Finishing grade lineup for tool steel and plastic die steel
- PC2005 with extremely hard substrate and coatings
- PC2010 with high hardened cutting edges, ideally suited for pre-hardened steel and interrupted cutting
- PC2015 for carbon steel and casting machining, demonstrating excellent performance in hard-to-cut materials

Application guideline per workpiece

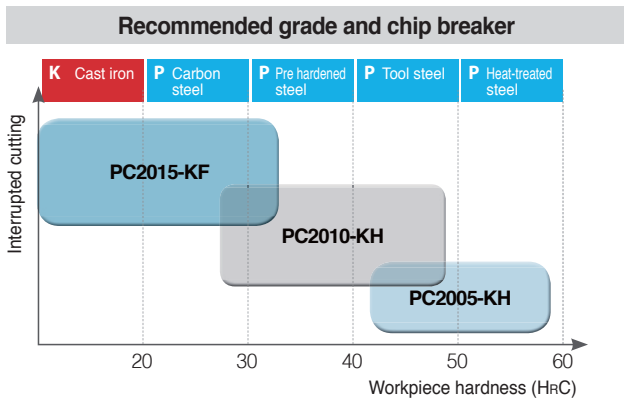

Features

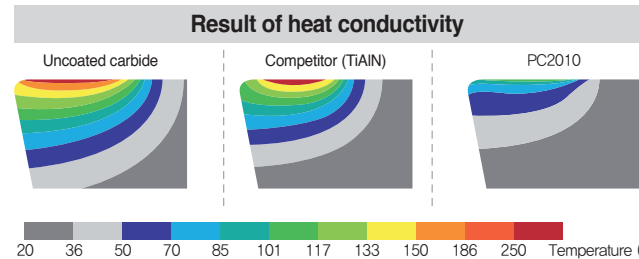

- Heat shield coating was applied to prevent thermal crack.
- Ultra fine WC was combined with high contents cobalt to be optimized for machining pre hardened steel.

PVD coated grades for roughing high hardened steel

PC2505 **new** / PC2510 **new**

- Roughing grade series for high hardened steel
- PC2505 with excellent wear resistance, ideal for machining die steel and high hardened steels over HrC50
- PC2510 with stabilized toughness, ideal for interrupted cutting of high hardened steel and wet cutting accompanied by massive thermal shock

Application guideline per workpiece

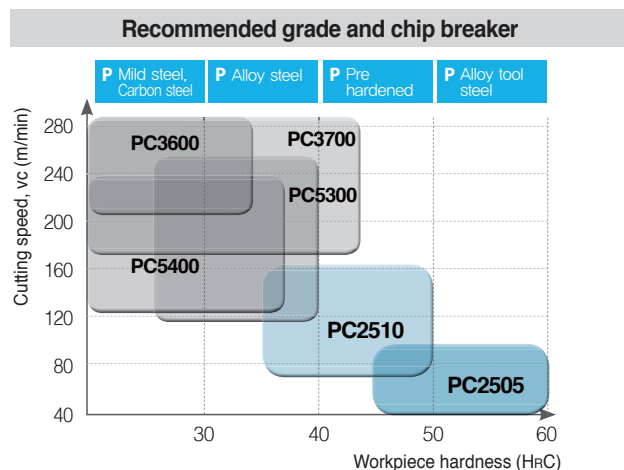

Features

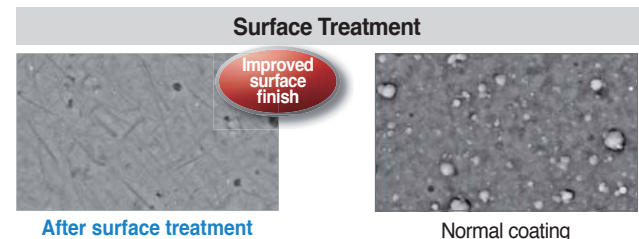
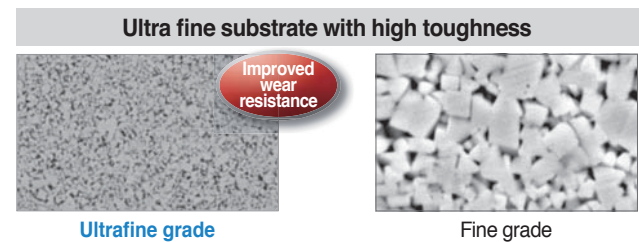

Application examples (PC2005/PC2010/PC2015)

H Alloy tool steel (SKD11, heat treated)

- **Workpiece** Automobile press mold
- **Cutting condition** vc (m/min) = 377, fz (mm/t) = 0.5
 ap (mm) = 0.5, ae (mm) = 0.2, dry
- **Designation** **Insert** : LBH250-KH (PC2005)
Holder : LBE250140S-S25C
- **Test result**

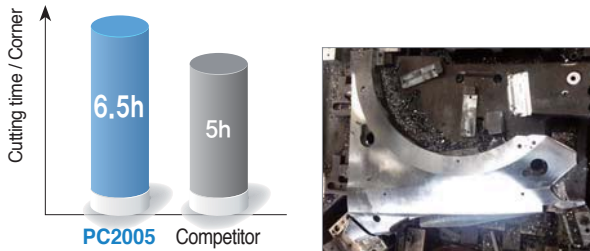

P Mold steel (KP4M)

- **Workpiece** Automobile press mold
- **Cutting condition** vc (m/min) = 200, fz (mm/t) = 0.1
 ap (mm) = 0.1~0.5, ae (mm) = 0.1~0.5, wet
- **Designation** **Insert** : LBH160-KH (PC2010)
Holder : LBE160100S-S16C
- **Test result**

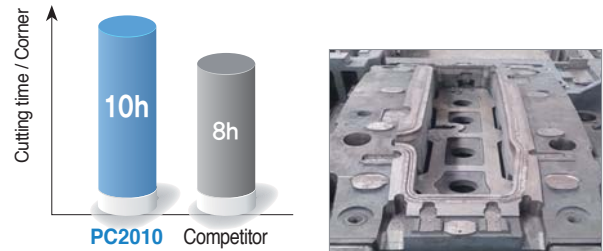

P Carbon steel (SM53C)

- **Workpiece** CV Joint
- **Cutting condition** vc (m/min) = 200, fz (mm/t) = 0.25
 ap (mm) = 0.5~2.0, ae (mm) = 0.5~1.0, dry
- **Designation** **Insert** : LBH230-KF (PC2015)
Holder : LBE230-HSKC63
- **Test result**

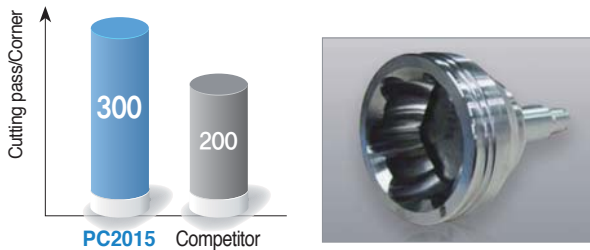

Application examples (PC2505/PC2510)

H Alloy tool steel (SKD11, heat treated)

- **Cutting condition** vc (m/min) = 80, fz (mm/t) = 0.5
 ap (mm) = 0.3, ae (mm) = 10, dry
- **Designation** **Insert** : LPEW040210R-C (PC2505)
Holder : HFMS1010HR-2S10
- **Test result**

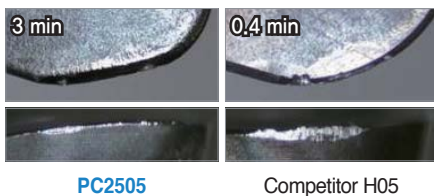

H Alloy tool steel (SKD11, heat treated)

- **Cutting condition** vc (m/min) = 30, fz (mm/t) = 0.4
 ap (mm) = 0.7, ae (mm) = 40, dry
- **Designation** **Insert** : RPMW1204M0S1 (PC2510)
Holder : FMRPS4050HRP-4M40
- **Test result**

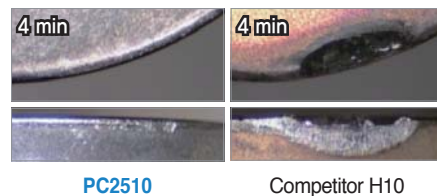

PVD coated grades

Milling grade specialized for steel.

PC3700 **new**

- Excellent chip removal rate due to a tough substrate specialized for steel, and lubricative PVD coating of high-hardness
- A highly chipping-resistant grade for minimized deviation and extended tool life under various cutting conditions

Features

- Smooth surface due to special surface treatment
 → Smooth chip evacuation, improved chipping resistance and surface finish of the workpiece

Special coating surface treatment

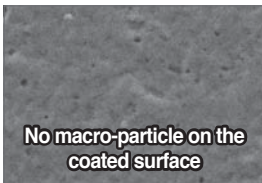

No macro-particle on the coated surface

PC3700

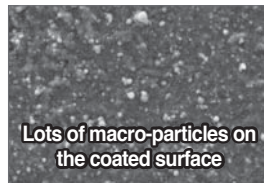

Lots of macro-particles on the coated surface

Existing products

- Substrate for general milling applications of steel and PVC coating treatment

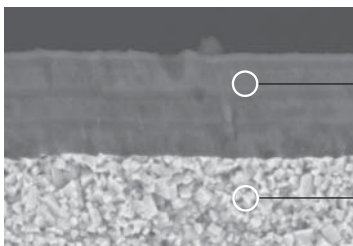

Stronger resistance to welding and chipping due to the multi-layer coating technology with high hardness and lubricating treatment

Ensuring general machinability due to wear and breakage resistant materials optimized for milling applications of steel

Application range

Recommended grades and cutting conditions for p-type milling application

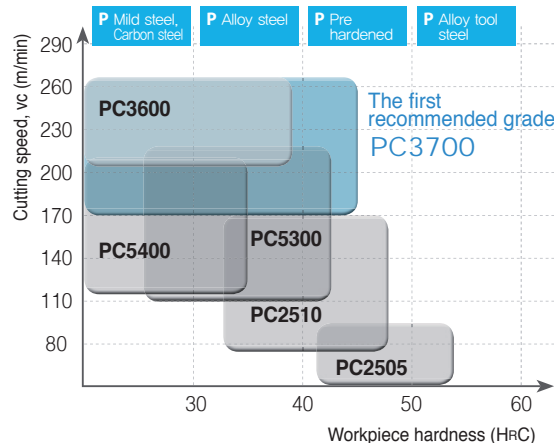
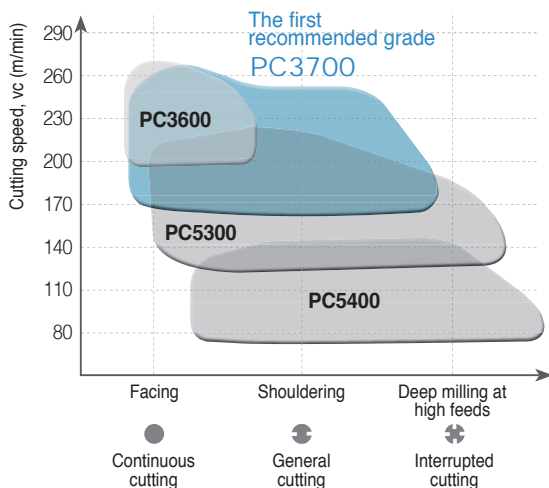

PVD coated grades

Universal PVD grade

PC5300

- Advanced PVD coating with high hardness and high temp stability
- High tough substrate and coating films produce excellent surface finish
- Universal tooling capability covering P, M, K, S with this single grade, PC5300
- Stable machining resulting from excellent edge hardness and chipping resistance

Features

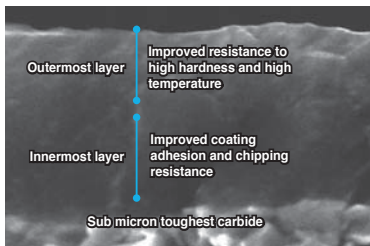

- Latest PVD coating technology developed by KORLOY
- New concept of coating equipped with high temperature oxidation resistance and high hardness

High temp properties

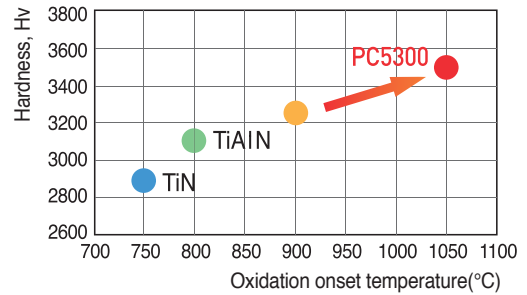

PC5400

- New PVD coating layer with high toughness and lubrication
- High adhesive strength and toughness between the substrate and coating layer
- Excellent cutting edge strength and chipping resistance ensure stable machinability for P, M, K, S.

Features

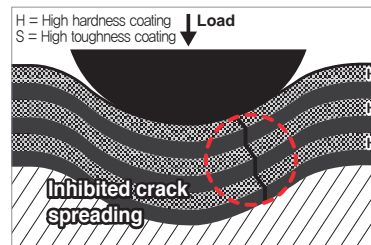
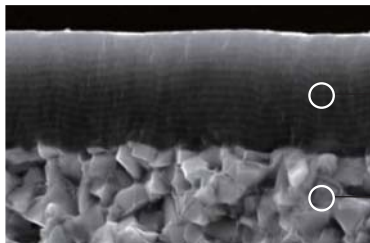

Crack creation on the coating surface after leaving an indentation by 60kg



Normal coating



High toughness coating



PVD coated grades

Optimal PVD grade for medium to rough cutting and highly interrupted milling in stainless steel

PC9540 **new**

- Longer tool life due to higher breakage resistance applying high toughness substrate controlling crack growth
- Excellent and new PVD dioxide film with oxidation and heat resistance overcoming the limit of hard-to-cut materials machining
- Stable machinability by preventing welding and chipping due to applying special coating surface treatment

Features

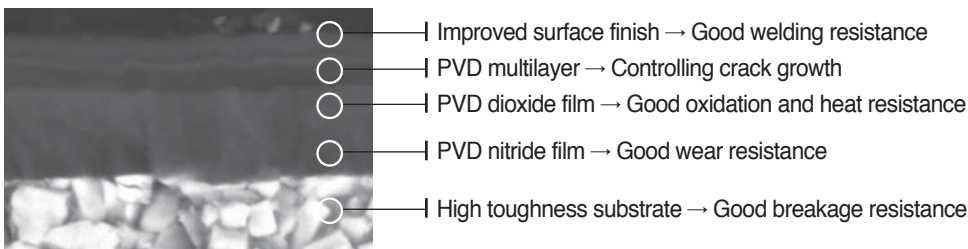

New PVD dioxide film (comparison of thermal conductivity)

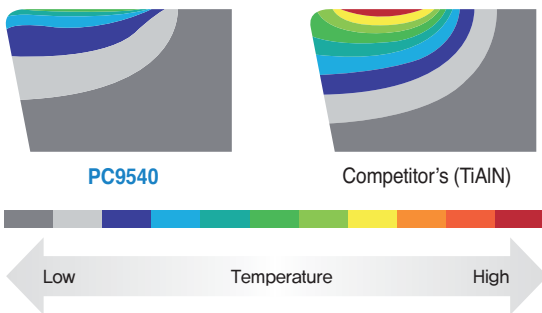

Special coating surface treatment technology

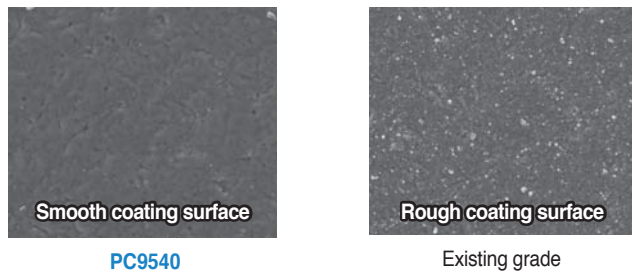

Application range

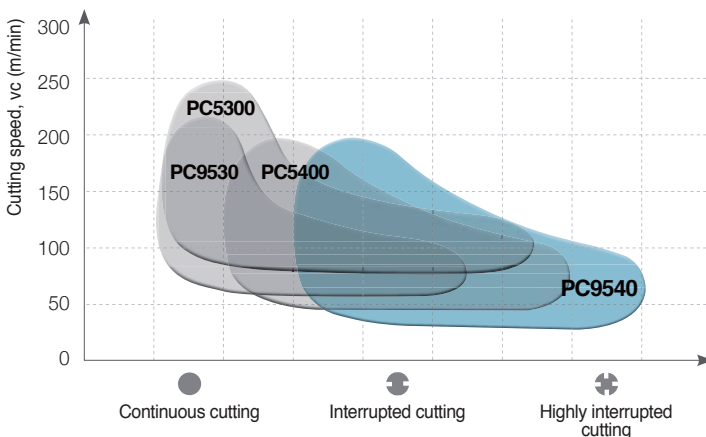

Selection system of CVD coated grades

Workpiece	Machining types	Recommended grade	Recommended cutting speed (m/min)	ISO	Application range
P Steel	Continuous cutting	PC3600	235 (180 ~ 290)	P20	PC3600
		PC3700	235 (180 ~ 290)	P30	PC3700 ^{new}
	Interrupted cutting	PC5300	195 (150 ~ 240)	P40	PC5300
		PC5400	145 (80 ~ 210)		PC5400
M Stainless steel	Continuous cutting	PC5300	130 (100 ~ 160)	M20	PC5300
		PC9530	130 (100 ~ 160)	M30	PC9530
	Interrupted cutting	PC5400	120 (95 ~ 155)	M40	PC5400
		PC9540	110 (80 ~ 140)	M50	PC9540 ^{new}
K Cast iron	Continuous cutting	PC6510	180 (140 ~ 230)	K05 K10	PC6510
		PC5300	145 (110 ~ 180)	K20	PC5300
	Interrupted cutting	PC5400	125 (85 ~ 160)	K30	PC5400
S HRSA	Continuous cutting	PC5300	55 (40 ~ 70)	S10 S20	PC5300
		PC5400	40 (30 ~ 50)	S30	PC5400
	Interrupted cutting	PC9540	40 (30 ~ 50)	S40	PC9540 ^{new}
H High hardness steel	Continuous cutting	PC2005	60 (40 ~ 80)	H01	PC2005
		PC2010	55 (40 ~ 70)	H10	PC2010
		PC2015	50 (35 ~ 65)	H20	PC2015
		PC210F	50 (35 ~ 65)	H30	PC210F

The features of PVD coated grades

PVD Coated grades	ISO	Features
PC3600	P25 ~ P35	<ul style="list-style-type: none"> Milling grade for medium and roughing of steel New coating layer with superior wear resistance and oxidation resistance with high toughness substrate
PC3700 ^{new}	P25 ~ P35	<ul style="list-style-type: none"> Exclusive grade for milling grade Lubricated and high hardness multi-layered coating
PC5300	P30 ~ P40 K20 ~ K30 M20 ~ M30 S15 ~ S25	<ul style="list-style-type: none"> Superior universal grade for steel, cast iron, hard to cut material, stainless steel New coating and ultra fine grain provide wear resistance and oxidation resistance TiAlN Series new coating
PC5400	P35 ~ P45 K25 ~ K35 M30 ~ M40 S25 ~ S35	<ul style="list-style-type: none"> Universal grade for interrupted machining of steel, cast iron, hard-to-cut materials and stainless steel with stable machinability New coating layer with high toughness and lubrication on ultra fine grain substrate with high toughness AlCrN series new coating
PC6510	K05 ~ K15	<ul style="list-style-type: none"> High speed milling grade for cast iron and aluminum K-Gold coating
PC9530	M25 ~ M35 S20 ~ S30	<ul style="list-style-type: none"> Medium to rough cutting of hard to cut materials such as stainless steel, Cr-Ni steel, etc. The toughest sub-micron substrate provides excellent cutting performance at high feed TiAlN coating
PC9540 ^{new}	M35 ~ M45 S30 ~ S40	<ul style="list-style-type: none"> Exclusive high toughness grade for stainless steel milling PVD dioxide film with good heat resistance
PC2005	P01 ~ P10 K01 ~ K10 H01 ~ H10	<ul style="list-style-type: none"> Exclusive for Laser Mill in milling of high hardness workpieces and press mold steel Utmost wear resistance due to high hardness substrate and coating Ultra high hardness K-Brown coating
PC2010	H05 ~ H15	<ul style="list-style-type: none"> Exclusive for Laser Mill in milling of pre hardened steel and plastic mold steel High hardness enhanced cutting edges due to ultra fine WC and high contents binder for expanding application range to high hardness steel and pre hardened steel Ultra high hardness K-Brown coating
PC2015	H10 ~ H20	<ul style="list-style-type: none"> Exclusive for Laser Mill in milling of carbon steel and cast Highly lubricative K-SILVER coating Lubricative coating layer and high contents substrate for machining mild steel and hard-to-cut cast materials
PC210F	H10 ~ H20 P25 ~ P35 K15 ~ K25 M15 ~ M25 S10 ~ S20	<ul style="list-style-type: none"> High speed milling grade for hardened steel, cast iron, and stainless steel(Laser Mill) New coating and ultra fine grain provide wear resistance and oxidation resistance TiAlN Series new coating
PC2505 ^{new}	H01 ~ H10	<ul style="list-style-type: none"> Roughing grade for high hardened steel and pressed die steel Excellent wear resistance ideal for machining die steel and high hardened steel over HRC50
PC2510 ^{new}	H05 ~ H15	<ul style="list-style-type: none"> Roughing grade for pre-hardened steel and plastic die steel Stabilized toughness ideal for interrupted cutting of high hardened steel and wet cutting accompanied by massive thermal shock



Application examples (PC5300)

P Mold steel (KP4M)

- **Cutting condition** vc (m/min) = 250, fz (mm/t) = 1.0
 ap (mm) = 1.0, dry
- **Designation** Insert : WNMX130520ZNN-MM (PC5300)
Cutter : HRMDCM13050HR-3

■ **Test result**

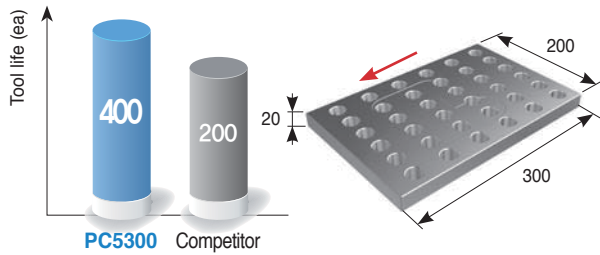

M Stainless steel (STS316)

- **Cutting condition** vc (m/min) = 65, fz (mm/t) = 0.14
 ap (mm) = 3.0, wet
- **Designation** Insert : SEET14M4AGSN-MM (PC5300)
Cutter : FMACM4100HR

■ **Test result**

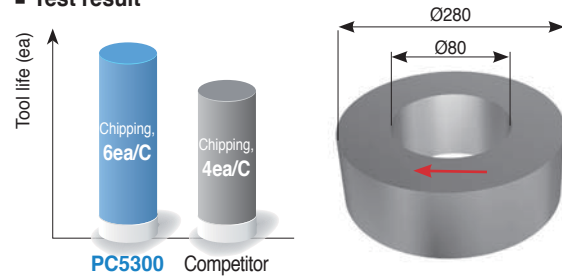

Application examples (PC5400)

P Carbon steel (SM45C)

- **Cutting condition** vc (m/min) = 250, fz (mm/t) = 1.2
 ap (mm) = 1.0, dry
- **Designation** Insert : WNMX130520ZNN-MM (PC5400)
Cutter : HRMDCM13050HR-4

■ **Test result**

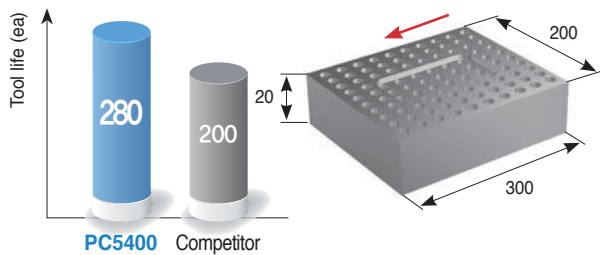

P Alloy steel (SCR440)

- **Cutting condition** vc (m/min) = 180, fz (mm/t) = 0.2
 ap (mm) = 2.0, dry
- **Designation** Insert : PDKT1605M0-MM (PC5400)
Cutter : FMRC5063HRD-H

■ **Test result**

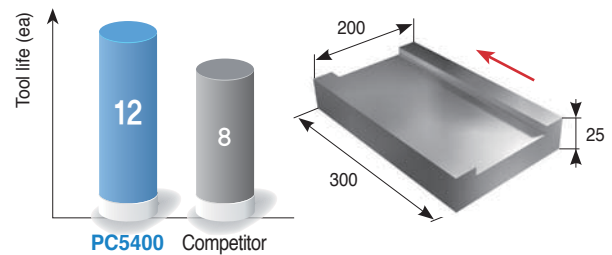

M Stainless steel (STS316)

- **Cutting condition** vc (m/min) = 50, fz (mm/t) = 0.1
 ap (mm) = 4.0, ae (mm) = 15.0, dry
- **Designation** Insert : APMT1604PDSR-MM (PC5400)
Cutter : AMC3063HS

■ **Test result**

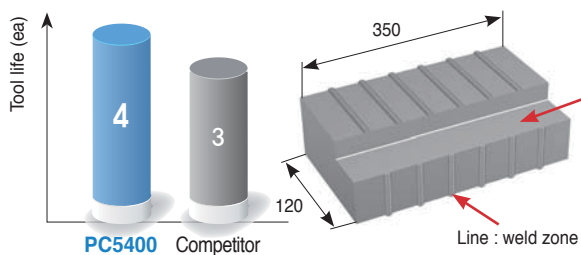

S Heat-resistant alloy (Inconel 718)

- **Cutting condition** vc (m/min) = 60, fz (mm/t) = 0.1
 ap (mm) = 2.5, wet
- **Designation** Insert : SNMX1206ANN-MM (PC5400)
Cutter : RM8AC4080HR

■ **Test result**

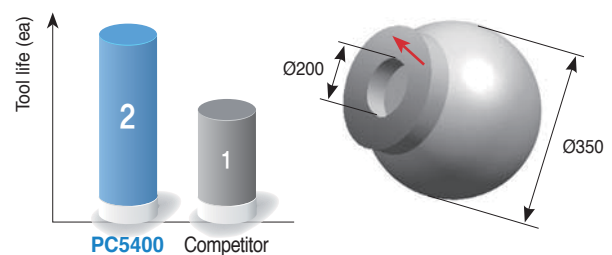

Application examples (PC9540)

M Austenitic stainless steel (STS304, HB200)

- **Workpiece** Square bar (300×200×100)
- **Cutting condition** vc (m/min) = 120, fz (mm/t) = 0.1
ap (mm) = 1.5, ae (mm) = 20, wet
- **Designation** Insert : XNKT080508PNER-ML
Holder : RM3PCM4063HR

■ Test result

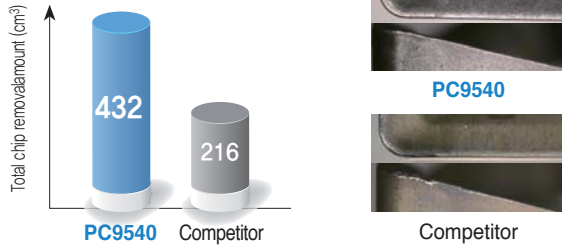

M Heat resistance stainless steel (DIN 1.4837)

- **Workpiece** Turbo charger turbine housing
- **Cutting condition** vc (m/min) = 100, fz (mm/t) = 0.16
ap (mm) = 2.2, dry
- **Designation** Insert : SNMX1206ANN-MF
Holder : RM8AC4100HR

■ Test result

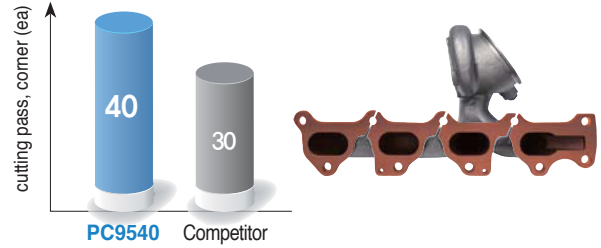

M Austenitic stainless steel (STS316, HB200)

- **Workpiece** Square bar (300×200×100)
- **Cutting condition** vc (m/min) = 120, fz (mm/t) = 0.15
ap (mm) = 5.0, ae (mm) = 10, dry
- **Designation** Insert : ADKT170608PESR-ML
Holder : KMS3032HR

■ Test result

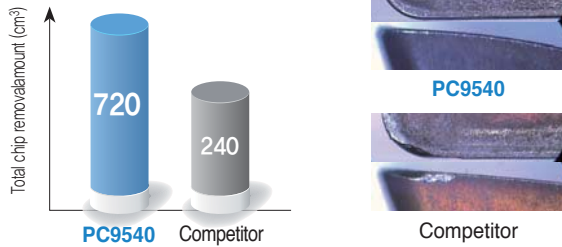

M Heat resistance stainless steel (DIN 1.4848)

- **Workpiece** Turbo charger turbine housing
- **Cutting condition** vc (m/min) = 80, fz (mm/t) = 0.2
ap (mm) = 1.2, dry
- **Designation** Insert : ONMX060608-MM
Holder : RM16AC6100HR-M

■ Test result

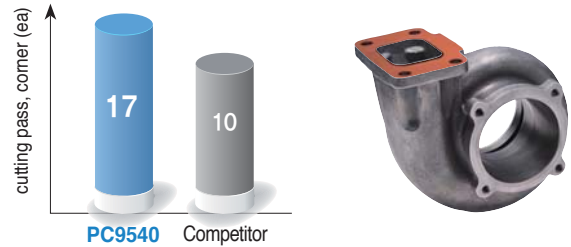

M Heat resistance stainless steel (DIN 1.4848, HB160)

- **Workpiece** Square bar (300×200×100)
- **Cutting condition** vc (m/min) = 90, fz (mm/t) = 0.2
ap (mm) = 2.0, ae (mm) = 25, wet
- **Designation** Insert : SNMX1206ANN-MF
Holder : RM8ACM4063HR-H

■ Test result

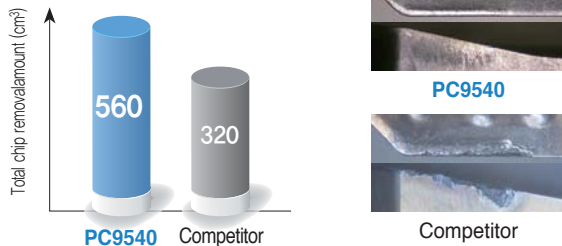

M Heat resistance stainless steel (DIN 1.4848)

- **Workpiece** Turbo charger turbine housing
- **Cutting condition** vc (m/min) = 100, fz (mm/t) = 0.15
ap (mm) = 1.5, wet
- **Designation** Insert : XNKT060405PNSR-MM
Holder : RM3PS3025HR-3L20

■ Test result

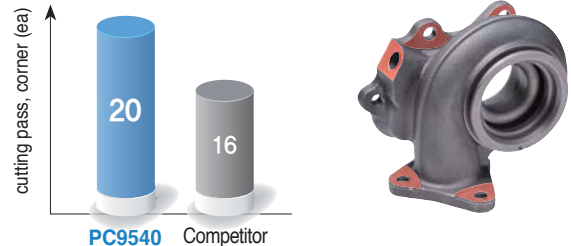

Uncoated carbide grades

- Features**
- Due to KORLOY's advanced sintering technology, our uncoated carbide grades have a fine alloy structure which is necessary to get superior quality from a uncoated cutting tool

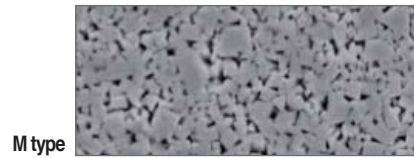
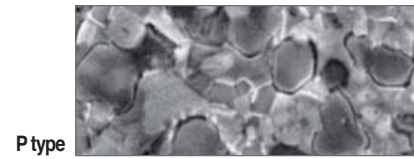

- Advantages**
- Consist of P,M,K carbide grades and can be used in all kinds of workpiece
 - Excellent quality at machining with coolant, due to the superior thermal crack resistance of the carbide
 - Due to the special design of carbides, it has fine micro structure and low affinity with workpiece
 - It has excellent toughness and produces lower cutting loads

Selection system of uncoated carbide grade

Workpiece	Grade	Recommended cutting speed (m/min)	ISO	Application range
P	Steel	ST20	90 (70 ~ 110)	P20
		ST30A	80 (60 ~ 100)	P30
M	Stainless steel	U20	90 (70 ~ 110)	M20
				M30
K	Cast iron	H01, H05	150 (110 ~ 190)	K10
		G10	120 (90 ~ 150)	K20
N	Aluminum alloy	H01	600 (450 ~ 750)	N10
	Copper alloys	H05	425 (320 ~ 530)	N20

Main composition and application range

Workpiece	Composition	Features	Workpiece
P	WC-TiC-TaC-Co	Excellent thermal shock resistance and plastic deformation resistance	Carbon steel, Alloy steel, Stainless steel
M	WC-TiC-TaC-Co	General grades with thermal shock resistance and hardness	Carbon steel, Alloy steel, Stainless steel, Cast steel
K	WC-Co	High hardness and superior wear resistance	Cast iron, Non-ferrous metal, Non metal

The physical properties of uncoated carbide grades

Workpiece	Grade	Hardness (HRA)	TRS (kgf/mm ²)	Young's modulus (10 ³ kgf/mm ²)	Thermal expansion coefficient(10 ⁻⁶ /°C)	Thermal conductivity (cal/cm·sec·°C)
P	ST10	92.1	175	48	6.2	25
	ST20	91.9	200	56	5.2	45
	ST30A	91.3	230	53	5.2	-
M	U20	91.1	210	-	-	88
K	H01	92.9	210	66	4.7	109
	G10E	90.9	250	63	-	105

1KPa = 102kgf/m², 1w/mk = 2.39×10⁻³cal/cm·sec·°C



Cermet grades

- Features**
- High hardness substrate ensures long tool life in high speed milling
 - High toughness cutting edge ensures long tool life even in high impact machining
 - Chemically stable substrate provides excellent surface finish of the workpiece

Selection system of cermet grades

Workpiece	Machining types	Grade	Recommended cutting speed (m/min)	ISO	Application range	
P	Steel	Continuous cutting	CN2000	250 (200 ~ 300)	P20	
	Interrupted cutting	CN30	150 (100 ~ 200)	P30		

The features of cermet grades

Cermet Grade	ISO	Features
CN2000	P20 ~ P30	<ul style="list-style-type: none"> • Universal grade from finishing to roughing of steel • Functionally Gradient Material
CN30	P25 ~ P35	<ul style="list-style-type: none"> • For milling of steel • Cermet with high toughness

The physical properties of cermet grades

Workpiece	Grade	Hardness(Hv)	TRS(kg/mm ²)	SG(g·cm ⁻³)
P	CN2000	< 1800	210 <	6.8~7.0
	CN30	< 1500	240 <	7.0~7.3

Application examples (CN30)

P	Carbon steel (SM45C)	P	Mold steel (KP4M)
<p>■ Cutting condition</p> <p>vc (m/min) = 120~150, fz (mm/t) = 0.07~0.13 ap (mm) = 2.0, dry</p>	<p>■ Designation</p> <p>Insert : SDCN42MT (CN30) Cutter : ADN4315R</p>	<p>■ Cutting condition</p> <p>vc (m/min) = 230, fz (mm/t) = 0.1~0.15 ap (mm) = 1.0, dry</p>	<p>■ Designation</p> <p>Insert : SDCN42MT (CN30) Cutter : ADN4315R</p>
<p>■ Test result</p> <p>Tool life (%)</p> <p>120% (CN30) vs 100% (Competitor)</p>	<p>■ Test result</p> <p>Tool life (%)</p> <p>140% (CN30) vs 100% (Competitor)</p>		

Solid endmills grade selection

Grades for H Endmill

PC303S/PC310U

- Ultrafine substrate & high hardness coatings for excellent wear resistance
- Special surface treatment provides higher chipping resistance

Features

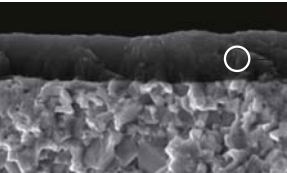

Exceptional wear resistance resulting from extremely hard coating layers

Grades for Z Endmill

PC315E

- Fine substrate & lubricative coatings for stable machinability

Features

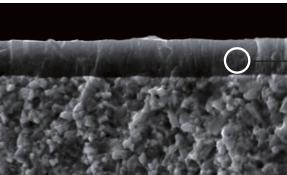

Lubricative coatings for excellent machinability

Selection system

Workpiece	Grade	ISO	Application range
P Steel	PC303S	P01	
	PC310U	P10	◀ PC303S ▶ PC203F
		P20	◀ PC310U
	PC315F	P30	◀ PC315E ▶ PC320 ▶ PC215F
	PC320	P40	
M Stainless steel	PC303S	M01	
	PC310U	M10	◀ PC303S ▶ PC203F ▶ PC310U
		M20	◀ PC320S ▶ PC315E ▶ PC320 ▶ PC215F
	PC315E	M30	
K Cast iron	PC303S	K01	
	PC310U	K10	◀ PC303S ▶ PC203F ▶ PC310U
		K20	◀ PC315E ▶ PC320 ▶ PC215F
	PC315E	K30	
		K40	
S HRSA	PC320S	S20	◀ PC320S ▶ PC315E ▶ PC320 ▶ PC215F
	PC315E	S30	
	N Nonferrous	ND3000 ^{new}	N01
ND2100 ^{new}		N05	◀ ND3000 ^{new} ▶ ND2100 ^{new} ▶ PD1005 ^{new} ▶ PD1010 ^{new} ▶ H01 ▶ H05S ▶ PC210C
PD3000		N10	
H01		N20	
H High hardness steel	PC303S	H01	
	PC203F	H10	◀ PC303S ▶ PC203F
		H20	◀ PC310U





Solid endmills grade selection

Grade information for each product

Item	Grade	
	Coated	Uncoated
H Endmill	PC303S, PC310U	-
V Endmill	PC215F	-
Z Endmill	PC315E	-
F Endmill	PC203F	-
T Endmill	PC2510, ND3000	H01
I ⁺ Endmill	PC320	-
Z ⁺ Endmill	PC320U	-
S ⁺ Endmill	PC320S	-

Item	Carbide		HSS	
	Coated	Uncoated	Coated	Uncoated
R ⁺ Endmill	PC10T, PC20T PC30T, PC40T	FN30T	HC10T, HC20T, HC30T	HN20T, HN30T
Aluminum Solid Endmill	PD1005, PD1010	H01	-	-
A ⁺ Endmill	-	H05S	-	-
C-Max	PC210C	-	-	-
Super Endmill	SL	-	-	-
D Endmill	ND3000	-	-	-
Composite Router Endmill	ND2100	-	-	-
Brazed Endmill	PC221F	FCC	-	-

The features of Coated grades

Workpiece	ISO	Features
PC303S	P05 ~ P15 K05 ~ K15 H05 ~ H15	<ul style="list-style-type: none"> Excellent wear/chipping resistance in high speed machining due to the combination of ultra fine substrate and PVD coating For high speed machining of high hardness steel New film applied with excellent oxidation resistance and hardness at high temperature
PC310U	P10 ~ P20 K10 ~ K20 H10 ~ H20	<ul style="list-style-type: none"> Excellent wear/chipping resistance in high speed machining due to the combination of ultra fine substrate and PVD coating For high speed machining of high hardness steel New film applied with excellent oxidation resistance and hardness at high temperature
PC315E PC320	P20 ~ P35 K20 ~ K35	<ul style="list-style-type: none"> Excellent wear/welding resistance in high speed machining due to the combination of ultra fine substrate and PVD coating For low/medium speed machining of general steel New film applied with excellent chipping/wear resistance
PC320S	M20 ~ M30 S20 ~ S30	<ul style="list-style-type: none"> Low to medium speed cutting of stainless steel and heat resistant alloys Advanced coating layers with increased resistance to built-up edge and oxidation Excellent resistance to wear and built-up edge at high speeds due to the ultrafine substrate and dedicated coating layers
PC210C	N10 ~ N20	<ul style="list-style-type: none"> Medium to high speed cutting of copper and copper electrode Medium to high speed cutting of acrylic materials K-Silver coating with excellent lubrication and wear and chipping resistant substrate
ND3000* 	N01 ~ N05	<ul style="list-style-type: none"> For electrode machining of graphite at medium to high speeds Dia. coating layer with high wear resistance and lubrication
ND2100* 	N03 ~ N08	<ul style="list-style-type: none"> For composite materials Diamond-coated layers with excellent adhesion
PD1005	N05 ~ N10	<ul style="list-style-type: none"> For Non-ferrous metals(Aluminum alloy) machining DLC(Diamond Like Carbon) coating layer with high wear resistance and lubrication

* : CVD

Features of KORLOY endmills

Index	Features
H Endmill (Endmill for high hardness steel)	<ul style="list-style-type: none"> Negative cutting edges proper to machine high hardness heat-treated workpiece under HRC70 Longer tool life with the use of ultra fine substrate and high hardness film
Z Endmill / I⁺ Endmill (Endmill for general cutting)	<ul style="list-style-type: none"> Excellent in machining various workpieces such as carbon steel, alloy steel, cast iron, pre hardened steel, etc. under HRC45 Longer tool life with the use of ultra fine substrate and new coating technology
T Endmill (For dental purpose)	<ul style="list-style-type: none"> Endmill for dental prostheses made of zirconia, titanium, Co-Cr, wax, PMMA, and glass ceramic Custom-made tools for each type of milling machines for dental purpose
Z⁺ Endmill	<ul style="list-style-type: none"> Universal endmill applicable to a variety of workpiece materials under HRC47 Roughing and finishing availability Improved tool life thanks to the new substrate and the most advanced coating Inhibited chipping and longer cutting time due to the optimized blade design
SSEA / A⁺ Endmill (Endmill for aluminum)	<ul style="list-style-type: none"> Suitable for high speed machining in aluminum and other Non-ferrous materials Can accomplish excellent surface finishing, superior chip removal in high feed rate
S⁺ Endmill (Endmill for hard-to-cut materials)	<ul style="list-style-type: none"> Sharp cutting edge and high rake angle with streamline chip pocket shows good cutting performance in stainless steel machining where work hardening is a problem
R⁺ Endmill	<ul style="list-style-type: none"> High efficient roughing endmill for medium to rough cutting Excellent machining efficiency thanks to the high efficient roughing edge design Reduced cutting force thanks to specifically designed corners, and irregular flute spacing and lead angle
D Endmill	<ul style="list-style-type: none"> Diamond-coated endmill for graphite and ceramic Excellent wear resistance thanks to the diamond coating of high hardness and high purity Optimized for high speed and heavy duty cutting thanks to the strong grip of coating Excellent cutting performance and finish thanks to the optimized blade design of high rake
Composite Router Endmill	<ul style="list-style-type: none"> Router endmill for machining composite materials (CFRP & GFRP) Minimized machining defects thanks to its design to prevent flaking, peeling off and burrs Excellent resistance to wear and flaking thanks to the nano-crystalline diamond coating of high hardness and high purity
C-Max	<ul style="list-style-type: none"> Ideally suited for machining copper, brass, bronze, and Non-ferrous materials thanks to the optimized combination between K-Silver coating with excellent lubrication and resistance to wear and chipping, and the dedicated substrate
Super Endmill	<ul style="list-style-type: none"> High lubricated coating and special surface treatment Improved welding and chipping resistance and machining stability due to surface treatment technology



Solid drills grades selection

Grades for Mach Solid Drill (MSD)

PC325U

- Special surface treatment provides improved lubrication and reduced cutting loads
- Stable tool life thanks to increased welding resistance

Features

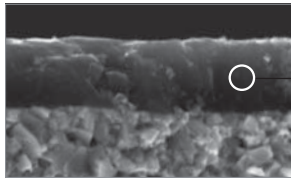

Increased welding resistance in medium to high speed cutting due to highly lubricative coating layers Increased wear resistance in carbon steel machining

Grades for Mach Solid Drill (MSD)

PC325T **new**

- Good wear resistance in HRSA machining at high temperature
- Good surface finish reduces friction resistance and increases chip evacuation

Features

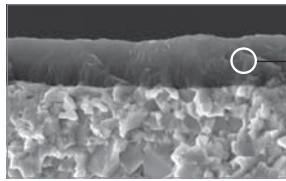

High heat and oxide resistance increase tool life Increased wear. Good surface finish coating layer ensures lubrication and high quality in machining.

Grades for Mach Long Drill (MLD)

PC215G/PC315G

- Improved wear resistance due to the ultrafine substrate
- Reduced friction resistance and smooth chip flow due to improved coating lubrication

Features

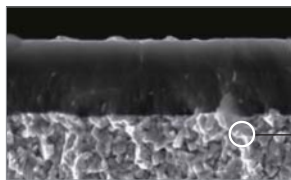

Exceptional wear resistance due to the ultrafine substrate

Selection system

Workpiece	Grade	ISO	Application range			
P Steel	PC215G	P01				
	PC315G	P10				
	PC325U	P20	PC215G	PC315G	PC325U	
	PC230F	P30				PC230F
M Stainless steel	PC215G	M01				
	PC315G	M10				
	PC205F	M20	PC215G	PC315G	PC325U	
	PC325U	M30			PC325U	
K Cast iron	PC215G	K01				
	PC315G	K10				
	PC205F	K20	PC215G	PC315G	PC325U	
	PC325U	K30			PC325U	
N Nonferrous	ND2100 new	N05	ND2100 new			
	FG2	N10		FG2	FA1	
		N20				
S HRSA	PC325T new	S20	PC325T new			
		S30				



Solid drills grades selection

Grade information for each product

Item	Grade	
	Coated	Uncoated
MSD Plus	PC325U	FG2
MSD Plus-S	PC325T	-
MSD Plus CFRP	ND2100	-
MSFD	PC325U	-
MLD Plus	PC215G, PC315G	FG2
VZD	PC230F	-
ESDP	PC325U	FG2
SSD Plus	-	FA1, FG2

The features of PVD coated grades

Workpiece	ISO	Features
PC325U	P20 ~ P35 M20 ~ M30 K20 ~ K35	<ul style="list-style-type: none"> • Universal grade for machining steel, cast iron, stainless steel, etc. • Stable cutting performance with excellent wear/chipping resistance • Increased welding resistance due to lubricative new coating at medium to high speed
PC325T <small>new</small>	M20 ~ M30 S20 ~ S30	<ul style="list-style-type: none"> • Good wear resistance realizes HRSA machining at high temperature • Good wear and chipping resistance ensure stable machinability
PC215G	P15 ~ P30 M15 ~ M25 K15 ~ K30	<ul style="list-style-type: none"> • Universal grade for machining steel, cast iron, etc. • Stable cutting performance with excellent wear/chipping resistance
PC315G	P15 ~ P30 M15 ~ M25 K15 ~ K30	<ul style="list-style-type: none"> • Universal grade for machining steel, cast iron, stainless steel, etc. • Stable cutting performance with excellent wear/chipping resistance • Increased welding resistance due to lubricative new coating at medium to high speed
PC230F	P25 ~ P35	<ul style="list-style-type: none"> • For machining general steel at medium to high speed • Stable cutting performance with excellent wear/chipping resistance
ND2100 <small>new</small>	N03 ~ N08	<ul style="list-style-type: none"> • For machining composite materials • Diamond-coated layers with excellent adhesion
FG2 / FA1	N05 ~ N25	<ul style="list-style-type: none"> • Increased wear/chipping resistance with the use of ultra fine substrate

Features of KORLOY drills

Index	Features
MSD Plus	<ul style="list-style-type: none"> • Increased welding resistance in medium to high speed cutting due to highly lubricative coating layers • Increased wear resistance in carbon steel machining • Reduced friction resistance around corners and flutes
MSD Plus-S	<ul style="list-style-type: none"> • Exclusive for HRSA grooving with good wear resistance at high temperature and chipping resistance. • New coating layer with good surface finish reduces frictional resistance and increases chip evacuation. • Preventing chipping on the cutting edge and fracture of tool ensures high productivity.
MSD Plus CFRP	<ul style="list-style-type: none"> • The best tool for hole making of CFRP workpieces • Excellent wear resistance due to the diamond-coated grade • Reduced burr creation in CFRP machining due to high rake cutting edges
MSFD	<ul style="list-style-type: none"> • High quality hole making capability with 180° point angle • Improved anti-chipping and welding resistance by edge honing and chamfering • Minimized creation of burrs compared to general drills
MLD Plus	<ul style="list-style-type: none"> • Higher rigidity due to straight-edge design • Smooth chip flow due to wider chip pockets and improved surface finish on flutes • Double margin system for stable machinability
ESDP	<ul style="list-style-type: none"> • Lubricative coating layer improves welding resistance at middle to high speed. • Increase wear resistance in machining carbon steel • Increased welding resistance and wear resistance with new PC325U grade applied.
SSD Plus	<ul style="list-style-type: none"> • New shape increases chip control • Surface finish and improved shape realize high quality of machining • Stable tool life increases productivity



Diamond coated grades

Grade for graphite and ceramic

ND3000 **new**

- SP3-crystalline diamond coatings of high purity and high hardness
- Improved adhesion between coated layers and the substrate that is specialized for diamond coatings
- Excellent tool life when machining graphite and ceramic

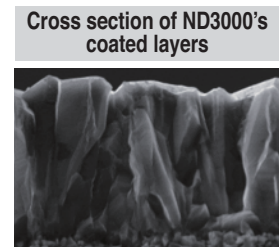
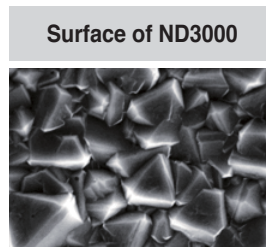

Grade for composite materials

ND2100 **new**

- Improved surface finish and wear resistance due to the control technology of nano-crystalline diamond particles
- Improved flaking resistance due to the substrate that is specialized for diamond coatings
- High quality and high precision machining availability thanks to sharp edges
- Excellent tool life when machining composite materials

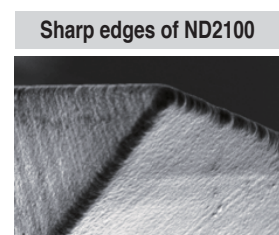
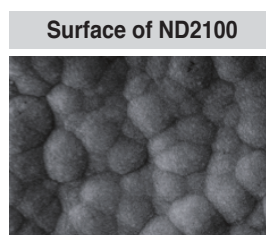

Application range

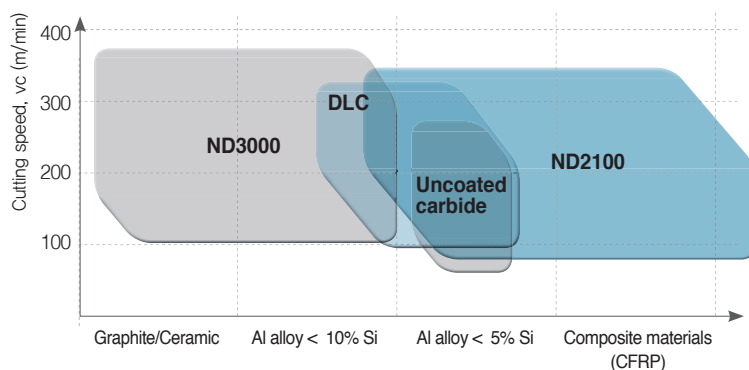

Selection system

Workpiece		Grade	ISO	Application range
N Nonferrous	Graphite/ Ceramic	ND3000 new	N01	ND3000 new
	Al alloy	ND3000 new ND2100 new	N05	
	Composite materials	ND2100 new	N10	ND2100 new

The features of diamond coated grades

Grade	ISO	Features
ND3000 new	N01 ~N05	<ul style="list-style-type: none"> • For continuous roughing of graphite, ceramic, and Al alloy at high speeds • Exceptional cutting performance due to high resistance to wear and flaking • High hardness diamond coatings of high purity SP3-crystalline structure
ND2100 new	N03~N08	<ul style="list-style-type: none"> • For continuous finishing of composite materials and Al alloy at high speeds • Stable machinability due to durable sharp edges • Nano-crystalline diamond coatings under particle control



DLC coated grades

DLC-Coated Inserts for Non-Ferrous Metals

PD1005 ^{new} / PD1010 ^{new}

- High hardness and low friction DLC coating technology
- Lubrication and maximized wear resistance increases machinability and machining quality.
- Optimal substrate for each workpiece ensures stable and long tool life
- For non-ferrous metals such as aluminum, Al-Si alloy, copper and etc. machining

Features

Smooth coating surface



Hard DLC coating

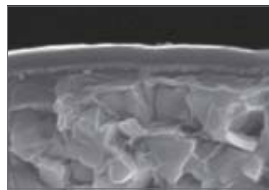

Grade	Wear resistance and Welding resistance	Surface finish	Chip curl
Carbide non coated			
DLC PD1010			

Application range

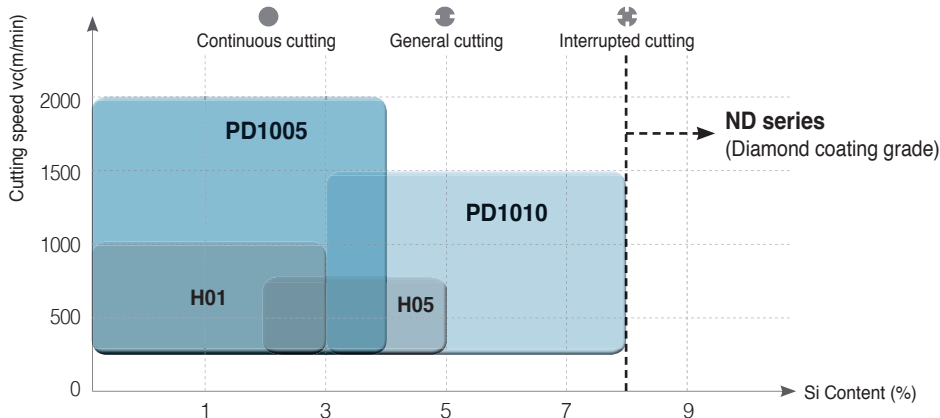

Selection criteria

Workpiece		Grade	ISO	Application range
N	Non-ferrous metals	Aluminum and copper (Soft non-ferrous metals)	PD1005	N05
		Aluminum alloy	PD1005 PD1010	N10
		Al-Si alloy (Hardened non-ferrous metals)	PD1010	N15

The features of DLC coating grades

Grade	ISO	Features
PD1005	N05	<ul style="list-style-type: none"> • For high speed and continuous machining of Aluminum and copper • High wear and welding resistance realize good machinability • High performance of DLC coating with high hardness and low friction
PD1010	N10	<ul style="list-style-type: none"> • For medium to high and interrupted machining of aluminum alloy and Al-Si alloy • Stable tool life due to substrate with chipping resistance • High performance DLC coating with high hardness and low friction



Application examples (ND3000/ND2100)

N Graphite mold

- **Cutting condition** vc (m/min) = 100, fz (mm/t) = 0.11, ap (mm) = 0.26, dry
- **Designation** Endmill : DBE4060-110-N250S06 (ND3000)
- **Test result**

Tool	Cutting time
ND3000	8h
Competitor	6.5h

N Graphite mold

- **Cutting condition** vc (m/min) = 300, fz (mm/t) = 0.1, ap (mm) = 0.15, dry
- **Designation** Endmill : DBE2060-080-N250S06 (ND3000)
- **Test result**

Tool	Cutting time
ND3000	6h
Competitor	5h

N CFRP

- **Cutting condition** vc (m/min) = 200, fn (mm/rev) = 0.21, ap (mm) = 10, ae (mm) = 2.8
- **Designation** Endmill : CCR2080-075 (ND2100)
- **Test result**

Tool	Cutting length
ND2100	19m
Competitor	8.5m

N CFRP

- **Cutting condition** vc (m/min) = 200, fz (mm/t) = 0.17, ap (mm) = 10, ae (mm) = 1.2
- **Designation** Endmill : CCLR4080-075 (ND2100)
- **Test result**

Tool	Cutting length
ND2100	40m
Competitor	20m

Application examples (PD1005/PD1010)

N Al-Si alloy

- **Workpiece** Aluminum die casting materials, ALDC7 (Si 8%)
- **Cutting condition** vc (m/min) = 400, fn (mm/rev) = 0.25-0.3, ap (mm) = 1.0-1.5, wet
- **Designation** Insert : CNMG120408-HA (PD1005)
Holder : PCLNR2525-M12
- **Test result**

Tool	Cutting pass (ea)
PD1005	80
Competitor	30

N Al-Si alloy

- **Workpiece** Aluminum forging materials, AC4C (Si 7%)
- **Cutting condition** vc (m/min) = 740, fn (mm/rev) = 0.15, ap (mm) = 1.0-1.5, wet
- **Designation** Insert : XEKT19M504FR-MA (PD1010)
Holder : PAXS5032HR-A
- **Test result**

Tool	Cutting pass (ea)
PD1010	900
Competitor	480



cBN inserts grades







Features

- Excellent hardness and thermal resistance by sintering KORLOY's main constituents and special ceramic binder at high pressure and high temperature
- Excellent hardness and wear resistance for higher productivity in machining cast iron and heat-treated alloy at high speed

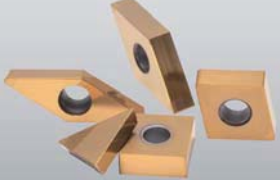
Insert type

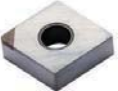
High precision		Wear resistance		Productivity	
					
For regrinding type	One use type	Multi-corner type	Multi-corner type (coated)	Solid type	Grooving type

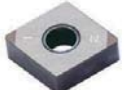
cBN inserts

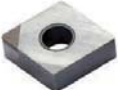
Multi edge coated type		One use type	
	 2NU-CNGA120408		 NU-CNGA120408
<ul style="list-style-type: none"> • Easy handling of corners • Strong Brazing • Excellent tool life compared to non-coated insertse 		<ul style="list-style-type: none"> • Economic price • Easy handling of tools • A wide variety of series • Smaller than expensive cBN and dramatic cost down • Strong weld face and stable cutting performance 	
Multi edge type		Regrinding type	
	 2NU-CNGA120408		 CNMA120408
<ul style="list-style-type: none"> • Price per edge is more reasonable compare to normal single cornered, one-used type • Insert with several brazed cBN • Wide application of continuous to interrupted machining 		<ul style="list-style-type: none"> • Long tool life • Excellent wear resistance, High hardness • Saved tool cost due to the regrinding insert 3~4 time 	



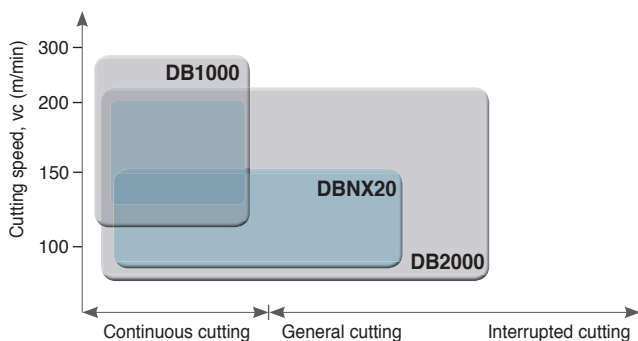



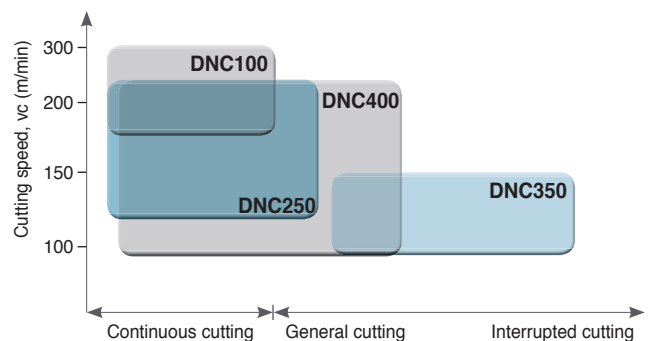









cBN application range



Coated cBN application range



Cutting condition of cBN grades

Workpiece	Grades	Insert color	Application	Cutting speed, vc (m/min)	Feed, fn (mm/rev)	Depth of cut, ap (mm)	
H High hardness steel	Coated	DNC100  <small>new</small>	Continuous cutting at high speed	180  300	0.03 ~ 0.3	0.03 ~ 0.3	
		DNC250 	Continuous and low interrupted cutting at high speed	120  220	0.05 ~ 0.3	0.05 ~ 0.3	
		DNC350 	Medium and high interrupted cutting	90  150	0.05 ~ 0.3	0.05 ~ 0.3	
		DNC400  <small>new</small>	Continuous and medium interrupted cutting	90  220	0.05 ~ 0.3	0.05 ~ 0.5	
	Non coated	DB1000		Continuous cutting at high speed	130  250	0.03 ~ 0.15	0.03 ~ 0.2
		DB2000		Medium and low interrupted cutting	80  200	0.03 ~ 0.2	0.03 ~ 0.3
		DBNX20		Highly efficient cutting	120  150	0.03 ~ 0.3	0.03 ~ 0.5
		DBN250		Medium and low interrupted cutting	80  120	0.03 ~ 0.2	0.03 ~ 0.3
		DBN350		High interrupted cutting		0.03 ~ 0.2	0.03 ~ 0.3
		DBN400		High speed and high depth of cut	120  220	0.10 ~ 0.3	0.5
S HRSA	DB7000		Continuous cutting at high speed	100  300	0.05 ~ 0.2	0.1 ~ 1.0	
K Cast iron	DBN700A		Continuous cutting at high speed	500  2000	0.10 ~ 0.4	0.1 ~ 0.4	

Solid type cBN DBN400

Features

- For medium and light interrupted cutting of heat-treated steel
- Balanced grade of wear resistance and shock resistance
- Solid type for highly efficient machining

Features of solid type



- Increased productivity at high speed and high depth of cut
- Ideal for removing cemented layer and machining the welds
- Stable welding with the use of 3-face blazing
- Excellent performance at varying depth of cuts

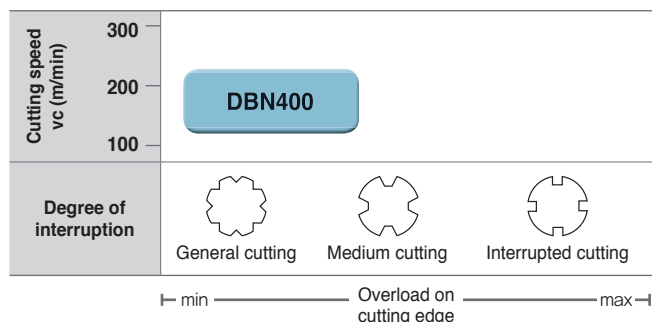

Application range



Recommended cutting condition

Cutting speed vc (m/min)	120  220
Feed fn (mm/rev)	0.1  0.3
Depth of cut per time ap (mm)	 0.5

A Others

Coated cBN

DNC100 new

- Features**
- Excellent thermal resistance
 - Coating layer with high hardness, oxidation resistance and chipping resistance

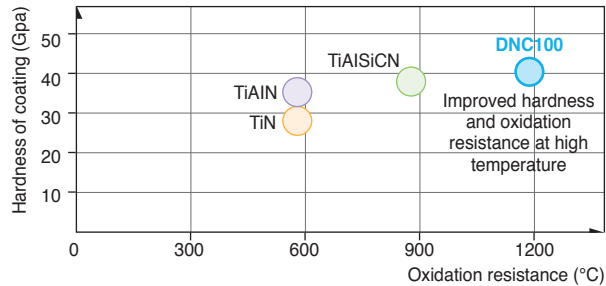

Application range

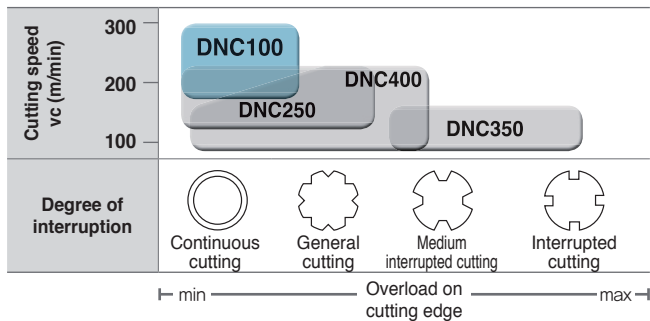

Recommended cutting condition

Cutting speed v_c (m/min)	180 ————— 300
Feed f_n (mm/rev)	0.03 ————— 0.3
Depth of cut per time a_p (mm)	0.03 ————— 0.3

- Increased oxidation resistance and wear resistance due to high hardness coating layer
- Dramatically improved fracture resistance and chipping resistance

Multi-corner coated cBN for high efficient cutting of heat-treated alloy

DNC250

- Features**
- Stable and long tool life
 - Cost effective by multi-cornered one-use insert

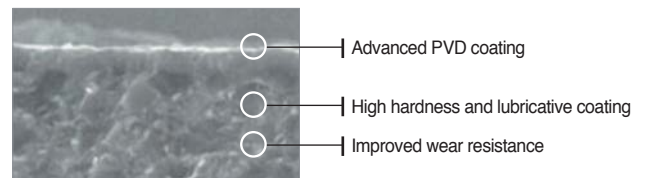
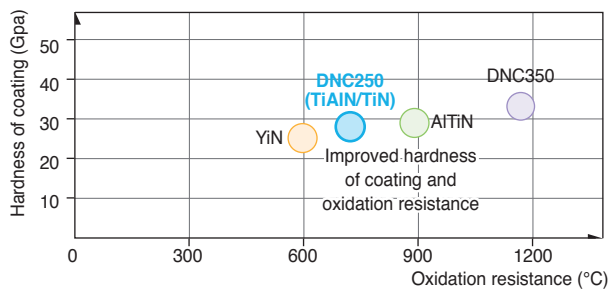

Application range

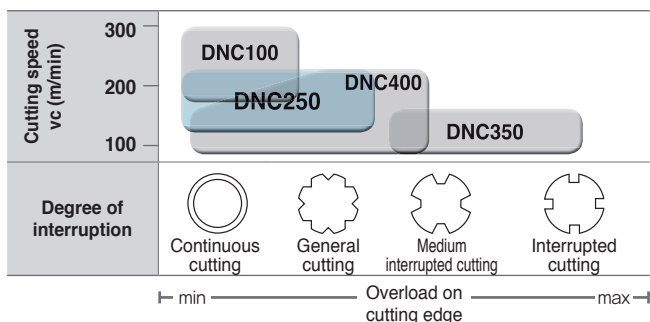

Recommended cutting condition

Cutting speed v_c (m/min)	120 ————— 220
Feed f_n (mm/rev)	0.05 ————— 0.3
Depth of cut per time a_p (mm)	0.05 ————— 0.3



Coated cBN for high interrupted cutting

DNC350

- Features**
- Excellent tool life and productivity in interrupted cutting
 - New PVD coating applied with high hardness and oxidation resistance

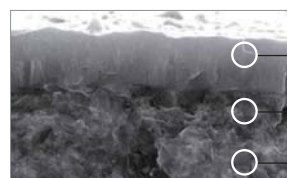
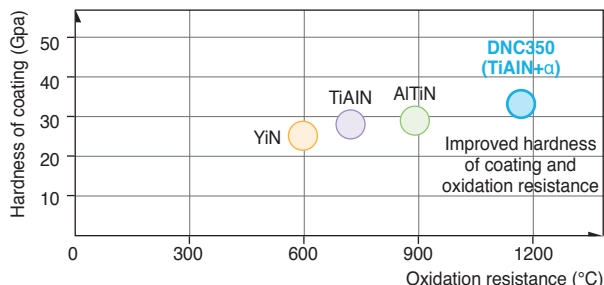

- High hardness and oxidation-resistant coating
- High tough coating
- Fine cBN + High tough substrate

Application range

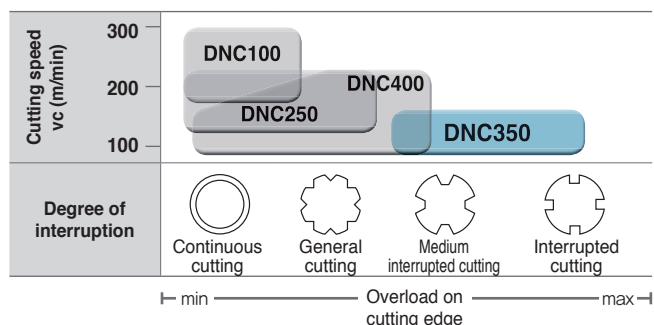

Recommended cutting condition

Cutting speed v_c (m/min)	90 — 150
Feed f_n (mm/rev)	0.05 — 0.3
Depth of cut per time a_p (mm)	0.05 — 0.3

Solid type coated cBN

DNC400 **new**

- Features**
- For machining heat-treated steel in continuous and medium interrupted cutting
 - Longer tool life due to coating layer
 - Solid type for universal purpose

Features of solid type cBN

- Increased productivity at high speed and high depth of cut
- Ideal for removing cemented layer and the welds
- Better welding stability due to 3-face blazing
- Excellent cutting performance at varying depth of cuts



Application range

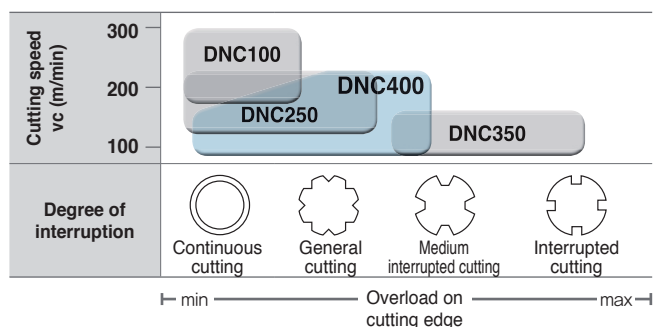

Recommended cutting condition

Feed f_n (mm/rev)	DNC400	0.05 — 0.3
	DNC250	0.05 — 0.3
	DNC350	0.05 — 0.3
Depth of cut per time a_p (mm)	DNC400	0.05 — 0.5
	DNC250	0.05 — 0.3
	DNC350	0.05 — 0.3



A Others

Non-coated cBN

DB1000

- **Features**
 - Non-coated cBN with the highest wear resistance at high speed
 - Excellent tool life in continuous to light interrupted cutting
 - Improved fracture resistance along with high wear resistance
 - Higher thermal resistance and hardness due to pure TiCN ceramic binder



Non-coated cBN

DB2000

- **Features**
 - Universal grade for overall machining of heat-treated
 - Stable tool life in continuous to low/medium interrupted cutting
 - Both fracture resistance and wear resistance acquired with the use of pure ceramic binder
 - Stable surface roughness



➤ New technology of high purity ceramic binding materials

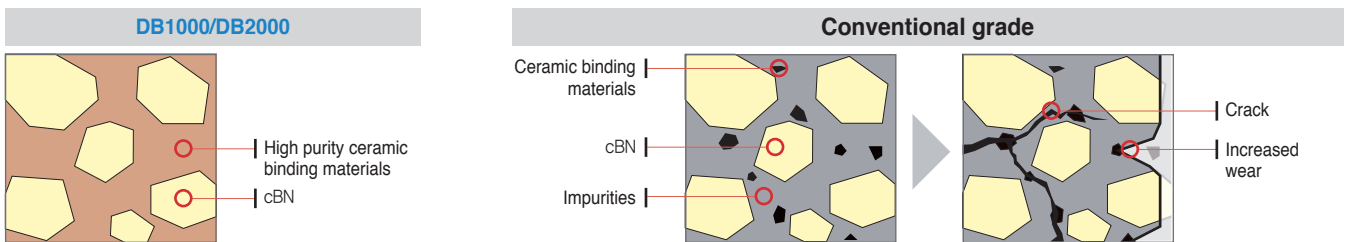

DB2000 dramatically minimizes impurities with the use of high purity ceramic binding materials and enhances thermal resistance and toughness.

Impurities included in conventional grade's ceramic binder caused inferior thermal resistance and hardness of sintered compounds, which led to crack (fracture) and wear

➤ Application range

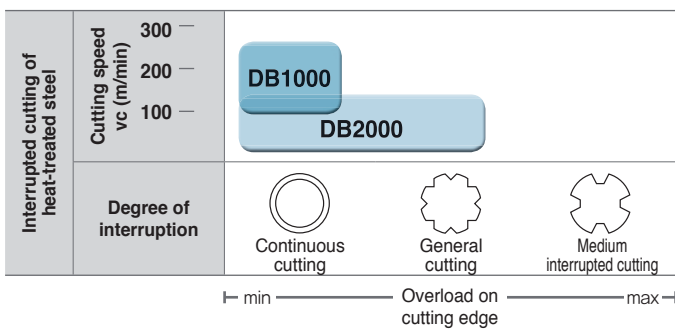

➤ Recommended cutting condition (DB1000)

Cutting speed v_c (m/min)	130 250
Feed f_n (mm/rev)	0.03 0.15
Depth of cut a_p (mm)	0.03 0.2

➤ Recommended cutting condition (DB2000)

Cutting speed v_c (m/min)	80 200
Feed f_n (mm/rev)	0.03 0.2
Depth of cut a_p (mm)	0.03 0.3



PCD inserts grades

Features

KORLOY PCD products are manufactured by using high quality PCD tips under ultra high temperatures and pressure. The PCD tip is welded on the qualified KORLOY carbide insert. KORLOY high quality PCD products meet a wide range of application needs in turning, milling, and endmills.

- Excellent tool life for aluminum alloy and copper alloy
- Excellent tool life for Ceramic, high-silicon aluminum and rock or stone
- Excellent tool life for rubber, carbon, graphite and wood

PCD grade

Grade	Features	Application	Grain size (μm)	Hardness (Hv)	TRS (kgf/mm ²)
DP90	Coarse diamond grain has been used to get excellent wear resistance enough to machine cemented-carbide, high Si aluminum alloy	Cemented carbide Ceramic roughing High Si aluminum alloy Rock, Stone	50	10,000 ~ 12,000	110
DP150	By use of fine diamond grain having good bonding property, it is suitable for machining of Non-ferrous metal, graphite	High Si aluminum alloy Copper, Bronze alloy Rubber, Wood, Carbon	5	10,000 ~ 12,000	200
DP200	By use of ultra fine diamond grain, it is possible to make sharp cutting edge. Thus it is appropriate grade to machine Non-ferrous material	Plastic Wood Precise finishing of aluminum	0.5	8,000 ~ 10,000	220

Recommended cutting condition

Workpiece	Cutting speed (m/min)	Feed (mm/rev)	Depth of cut (mm)	Recommended grade	
				1 st	2 nd
Aluminum alloy (4%~8% Si)	1000 ~ 3000	0.1 ~ 0.6	~ 3	DP150	DP200
Aluminum alloy (9%~14% Si)	600 ~ 2500	0.1 ~ 0.5	~ 3	DP150	DP200
Aluminum alloy (15%~18% Si)	300 ~ 700	0.1 ~ 0.4	~ 3	DP150	DP200
Copper, Bronze alloy	~ 1000	0.05 ~ 0.2	~ 3	DP150	DP200
Reinforced plastic	~ 1000	0.1 ~ 0.3	~ 2	DP150	DP200
Wood	~ 4000	0.1 ~ 0.4	-	DP150	DP200
Cemented carbide	10 ~ 30	~ 0.2	~ 0.5	DP90	DP150

Cutting performance

Continuous cutting test (Workpiece: Al-25%Si)

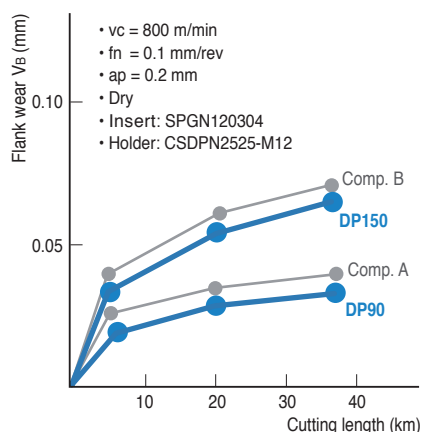



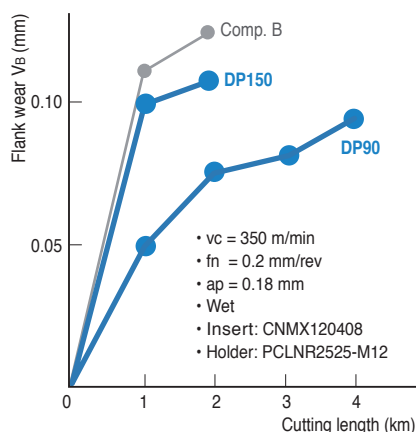



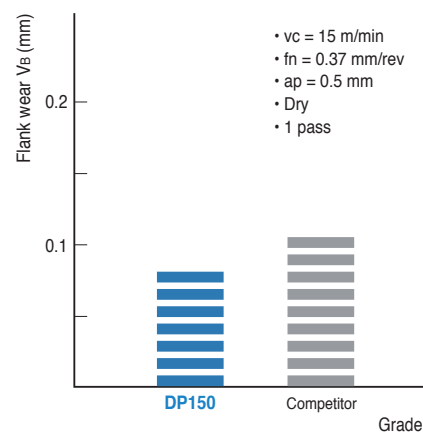













Interrupted cutting test (Workpiece: Al-20%Si)

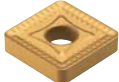

Cutting test of cemented carbide

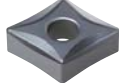

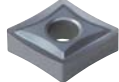









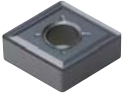



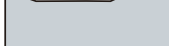
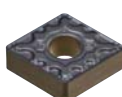

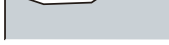
Chip breaker for turning

Geometry	Cutting edge	Application range												Features										
		feed rate f_n (mm/rev)																						
		0.04	0.063	0.10	0.16	0.25	0.4	0.63	1.0	1.6	2.5	4.0	6.3											
depth of cut a_p (mm)																								
												0.1	0.16	0.25	0.4	0.63	1.0	1.6	2.5	4.0	6.3	10.0	11.6	13
V series	VL																							For Finishing <ul style="list-style-type: none"> Stable chip control in high toughness material; low carbon steel, pipe steel & steel plates Improved chip control for facing, copy machining and better surface finish
	VB																							For Finishing <ul style="list-style-type: none"> Improved chip control for smaller depth of cuts Excellent chip control in copying, corner R machining
	VF																							For Finishing <ul style="list-style-type: none"> Good chip control quality on varied depth of cut Excellent cutting edge strength has been acquired due to the special chip-breaker
	VC																							For Medium to finish cutting <ul style="list-style-type: none"> Stable chip control in copying and internal machining with various depths of cut
	VQ																							For Medium to finish cutting <ul style="list-style-type: none"> Medium to finishing cutting edges offer improved edge hardness For cermet
	VM																							For Medium cutting <ul style="list-style-type: none"> Wide available chip control range from medium-finishing to medium-roughing Suitable chip breaker for CNC machining
	VH																							For Heavy duty cutting <ul style="list-style-type: none"> Designed specifically for heavy machining Specialized chip breaker for the heavy industries like Ship building, Power plant industry
	VT																							For Heavy duty cutting <ul style="list-style-type: none"> Designed specifically for heavy machining Specialized chip breaker for the heavy industries like Ship building, Power plant industry
	VP1																							For Finishing <ul style="list-style-type: none"> High positive cutting edge Reduced contract chip minimizes temperature to improve tool life
	VP2																							For Medium to finish cutting <ul style="list-style-type: none"> Stable chip control and high machinability in copying with various depths of cut

Notice: Application ranges are based on main cutting material





















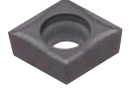

Chip breaker for turning

Geometry	Cutting edge	Application range												Features										
		feed rate f_n (mm/rev)																						
		0.04	0.063	0.10	0.16	0.25	0.4	0.63	1.0	1.6	2.5	4.0	6.3											
depth of cut a_p (mm)																								
												0.1	0.16	0.25	0.4	0.63	1.0	1.6	2.5	4.0	6.3	10.0	11.6	13
V series	VP3			0.05~0.45 0.5~4.5												<p>For Medium cutting</p> <ul style="list-style-type: none"> High positive cutting edge with wide land Stable cutting performance in interrupted machining with high toughness Stable machinability and chip control in machining with high depth of cut 								
	VP4			0.15~0.45 1.0~4.5												<p>For Roughing</p> <ul style="list-style-type: none"> The first recommended chip breaker for inconel cutting High hard and resistant rake angle to prevent notch wear in roughing of rugged surfaces 								
	VR			0.25~0.55 1.2~7.0												<p>For Roughing</p> <ul style="list-style-type: none"> High feed machining with the combination of wide land and pockets Shallow chip breaker design prevents chip blocking at high feed Decreased wear on major cutting edge due to special treatment on blade 								
-P series	LP			0.10~0.40 0.5~2.5												<p>For Medium to finish cutting</p> <ul style="list-style-type: none"> Angle land decreases cutting resistance for better surface roughness Special dot design prevents chip blocking by clear chip breaking 								
	MP			0.15~0.45 0.5~4.5												<p>For Medium cutting</p> <ul style="list-style-type: none"> Increased productivity due to excellent chip control in various conditions Stable tool life by reducing cutting load at high speed and high feed 								
-M series	MM			0.12~0.45 0.5~5.5												<p>For Medium cutting</p> <ul style="list-style-type: none"> The first recommended chip breaker for continuous stainless applications cutting Improved tool life and surface finish due to dual lands combining both machinability and toughness Wide chip pockets for stable chip evacuation at high depth of cuts and high feeds 								
	RM			0.15~0.55 2.0~6.0												<p>For Roughing</p> <ul style="list-style-type: none"> The first recommended chip breaker for interrupted cutting or roughing of stainless steel Inhibited notch wear and burr creation at high depth of cuts and feeds Reduced cutting loads and longer tool life at high feeds 								
-K series	MK			0.10~0.50 1.0~5.0												<p>For Medium cutting</p> <ul style="list-style-type: none"> Suitable for continuous cutting of ductile and gray cast iron Excellent tool life and surface finish thanks to angle lands improving cutting performance 								
	RK			0.20~0.60 1.5~6.0												<p>For Roughing</p> <ul style="list-style-type: none"> Suitable for machining ductile and gray cast iron at high speeds and high feeds Improved toughness and chipping resistance due to flat lands 								
H series	HA			0.03~0.30 0.5~2.5												<p>For Medium to finish cutting</p> <ul style="list-style-type: none"> Sharp cutting edge generates low cutting force Specially designed tough main cutting edge Suitable for cutting of low carbon steel, stainless steel, aluminum 								

Notice: Application ranges are based on main cutting material

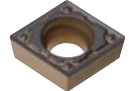

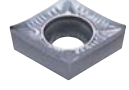









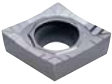

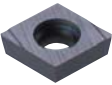
Chip breaker for turning

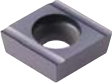
Geometry	Cutting edge	Application range												Features										
		feed rate f_n (mm/rev)																						
		0.04	0.063	0.10	0.16	0.25	0.4	0.63	1.0	1.6	2.5	4.0	6.3											
depth of cut ap (mm)																								
												0.1	0.16	0.25	0.4	0.63	1.0	1.6	2.5	4.0	6.3	10.0	11.6	13
G series	GR									0.30~0.80										3.0~8.0				For Roughing <ul style="list-style-type: none"> Suitable for deep depth of cut and high feed cutting of steel and cast iron Suitable for intermittent cutting
	GH										0.30~1.30										3.0~11.0			
B series	B25																							For General cutting <ul style="list-style-type: none"> Suitable for general cutting condition cutting
V-Posi series	VF									0.05~0.25														For Finishing <ul style="list-style-type: none"> Improved surface finish and size accuracy due to stable inner boring
	VL									0.05~0.20														For Finishing <ul style="list-style-type: none"> Superior chip control in low carbon steel, pipes, and steel plates
	VP1										0.01~0.25													For Finishing <ul style="list-style-type: none"> Excellent chip control in application with micro depth of cut and low feed Low cutting load and superb surface finish Optimal for both internal and external machining
H-Posi series	HMP																							For Medium cutting <ul style="list-style-type: none"> Excellent chip control at wide range of cutting conditions Machining versatility over a wide range of materials
C-Posi series	C25																							For Roughing <ul style="list-style-type: none"> Suitable for interrupted cutting and cast iron machining Good surface finish due to low cutting force Suitable for both boring and outer diameter turning
P-Posi series	MP																							For Medium cutting <ul style="list-style-type: none"> Sharp cutting edge and wide chip pocket for low cutting load Stable chip control at varying depth of cuts Excellent cutting performance when machining automobile components
AL series	AK																							For Medium to finish cutting <ul style="list-style-type: none"> High rake angle and low resistance cutting edge secures long tool life in continuous cutting of aluminum turning High speed of finishing operation

Notice: Application ranges are based on main cutting material

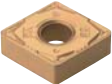

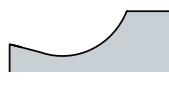









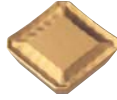







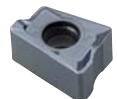

Chip breaker for turning

Geometry	Cutting edge	Application range												Features										
		feed rate f_n (mm/rev)																						
		0.04	0.063	0.10	0.16	0.25	0.4	0.63	1.0	1.6	2.5	4.0	6.3											
depth of cut a_p (mm)																								
												0.1	0.16	0.25	0.4	0.63	1.0	1.6	2.5	4.0	6.3	10.0	11.6	13
AL series AR			0.05~0.50												For Medium cutting • High stability of cutting edge secures great performance in high speed and interrupted machining • High speed of medium and interrupted operation									
													0.5~4.0											
Auto tool series KF			0.01~0.12												For Finishing • Shallow depth of cut with sharp edge • Longer tool life at high speed cutting due to low cutting force • Good surface finish									
													0.01~1.0											
Auto tool series KM			0.04~0.15												For Medium to finish cutting • Improved chip control makes tool life long and better machining									
													0.05~1.5											
For Wiper LW			0.15~0.60												For Medium cutting • Guarantees excellent surface roughness and good chip controls at high feed machining									
													1.0~5.0											
For Wiper VW			0.15~0.50												For Medium to finish cutting • Improved surface roughness at shallow depth of cut and high feed due to strong cutting edge									
													0.5~3.5											
For Shaft SR			0.12~0.45												For Finishing • Shallow depth of cut with sharp edge • Longer tool life at high speed cutting due to low cutting force • Good surface finish									
													1.0~4.5											
For Shaft SH			0.15~0.50												For Medium cutting • Good chip flow increases tool life and machinability.									
													1.5~5.0											

Notice: Application ranges are based on main cutting material





















Chip breaker for milling

Geometry	Cutting edge	Application range												Features	
		feed rate f_n (mm/rev)													
		0.04	0.063	0.10	0.16	0.25	0.4	0.63	1.0	1.6	2.5	4.0	6.3		
		depth of cut ap (mm)													
		0.1	0.16	0.25	0.4	0.63	1.0	1.6	2.5	4.0	6.3	10.0	11.6	14	
MX series	MX						0.10~0.30			1.0~5.0					For Roughing <ul style="list-style-type: none"> Possible to increase productivity through increase feed and depth Excellent heat resistance due to the special chip breaker design of top face of insert
	Mill-max Heavy						0.20~0.40			2.0~14.0					For Roughing <ul style="list-style-type: none"> Specialized tool for high depth of cut roughing with high rigidity cutting edge ensures stable machining.
Rich Mill series-RM3	MA					0.05~0.40				1.0~8.0					For Aluminum machining <ul style="list-style-type: none"> Sharp cutting edge for low cutting load, which is ideal for machining steel, hard-to-cut materials and aluminum
	ML					0.05~0.30				1.0~8.0					For machining hard-to-cut materials <ul style="list-style-type: none"> Low cutting resistance for light cutting and machining hard-to-cut materials with excellent tool life and surface roughness
	MM					0.05~0.35				1.0~8.0					For General cutting <ul style="list-style-type: none"> Available for most of applications with universal design for general milling
Rich Mill series-RM4	MA					0.05~0.25				0.3~14.0					For Aluminum machining <ul style="list-style-type: none"> Sharp cutting edge design ensures low cutting resistance and excellent machining in difficult-to-cut materials, aluminum and light machining
	MF					0.05~0.30				0.5~14.0					For Light cutting <ul style="list-style-type: none"> Low cutting force chip breaker design ensures longer tool life and excellent machining in difficult-to-cut material and light machining
	MM					0.05~0.30				1.0~14.0					For General cutting <ul style="list-style-type: none"> Suitable geometry design for general milling has wider ranges of machining
Rich Mill series-RM6	MA					0.05~0.2				1.0~8.2					For Aluminum machining <ul style="list-style-type: none"> Specialized sharp cutting edge for aluminum machining ensures machinability. Buffing treatment on the surface realizes good chip flow and welding resistance.
	ML					0.05~0.25				1.0~8.2					For Machining hard-to-cut materials <ul style="list-style-type: none"> Low cutting load chip breaker for light cutting Long tool life and high quality of machining in hard-to-cut material cutting

Notice: Application ranges are based on main cutting material



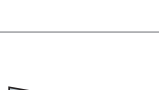



















Chip breaker for milling

Geometry	Cutting edge	Application range												Features	
		feed rate f_n (mm/rev)													
		0.04	0.063	0.10	0.16	0.25	0.4	0.63	1.0	1.6	2.5	4.0	6.3		
		depth of cut a_p (mm)													
		0.1	0.16	0.25	0.4	0.63	1.0	1.6	2.5	4.0	6.3	10.0	11.6	14	
Rich Mill series-RM6	MM						0.05~0.25						1.0~8.2		For General cutting • Optimally designed shape for general shoulder milling in various cutting ranges
Rich Mill series-RM8	MA						0.05~0.35						0.3~6.0		For Aluminum machining • Sharp cutting edge and lubricated top face show excellent chip flow and welding resistance in aluminum machining
	MF						0.05~0.35						0.3~6.0		For Light cutting • Low cutting force chip breaker design ensures longer tool life and excellent machining in difficult-to-cut material and light machining
	ML						0.05~0.30						0.3~6.0		For Machining hard-to-cut materials • Chip breaker with low cutting load resistance ensures long tool life and high quality in light and hard-to-cut material cutting.
	MM							0.10~0.40					0.5~6.0		For General cutting • Suitable geometry design for general milling has wider ranges of machining
Rich Mill series-RMT	MF						0.05~0.20						0.5~5.0		For Light cutting • Low cutting force chip breaker design ensures longer tool life and excellent machining in difficult-to-cut material and light machining
	MM							0.05~0.30					0.5~8.0		For General cutting • Suitable geometry design for general milling has wider ranges of machining
Rich Mill series-RM16	MA						0.05~0.30						0.3~5.5		For Aluminum machining • Sharp cutting edge design ensures low cutting resistance and excellent machining in difficult-to-cut materials, aluminum and light machining
	MF							0.05~0.40					0.3~5.5		For Light cutting • Low cutting force chip breaker design ensures longer tool life and excellent machining in difficult-to-cut material and light machining
	ML							0.05~0.35					0.3~5.5		For Machining hard-to-cut materials • Low cutting resistance for excellent tool life and surface roughness in machining hard-to-cut materials

Notice: Application ranges are based on main cutting material











Chip breaker for milling

Geometry	Cutting edge	Application range												Features										
		feed rate f_n (mm/rev)																						
		0.04	0.063	0.10	0.16	0.25	0.4	0.63	1.0	1.6	2.5	4.0	6.3											
depth of cut ap (mm)																								
												0.1	0.16	0.25	0.4	0.63	1.0	1.6	2.5	4.0	6.3	10.0	11.6	17
Rich Mill series-PM16	MM									0.10~0.45														<p>For General cutting</p> <ul style="list-style-type: none"> Suitable geometry design for general milling has wider ranges of machining
	W										0.05~0.30						0.3~2.0							
Alpha Mill series	MA									0.10~0.40														<p>For Aluminum machining</p> <ul style="list-style-type: none"> Sharp cutting edge and lubricated top face show excellent chip flow and welding resistance in aluminum machining
	MF									0.05~0.15														<p>For Light cutting</p> <ul style="list-style-type: none"> Low cutting force chip breaker design ensures longer tool life and excellent machining in difficult-to-cut material and light machining
	MM										0.10~0.25													<p>For General cutting</p> <ul style="list-style-type: none"> Suitable geometry design for general milling has wider ranges of machining
	ML										0.05~0.15													<p>For Hard-to-cut material machining</p> <ul style="list-style-type: none"> The chip breaker with low cutting resistance ensures superior machinability in hard-to-cut materials
	MN										0.10~0.25													<p>For Roughing (nick)</p> <ul style="list-style-type: none"> Design for easy chip cutting ensures high machinability in toughing.
Alpha Mill-X series	MM																							<p>For General cutting</p> <ul style="list-style-type: none"> Shape for general milling with most cutting range
	ML																							<p>For Hard-to-cut material machining</p> <ul style="list-style-type: none"> Chip breaker for cutting with low cutting load guarantees long tool life and qualified machining in light cutting and HRSA machining.
Future Mill series	MF																							<p>For Light cutting</p> <ul style="list-style-type: none"> Special design for light cutting of gummy materials like stainless steel and hard to machine material provide fine surface finish and longer tool life

Notice: Application ranges are based on main cutting material



Chip breaker for milling







Geometry	Cutting edge	Application range													Features			
		feed rate f_n (mm/rev)																
		0.04	0.063	0.10	0.16	0.25	0.4	0.63	1.0	1.6	2.5	4.0	6.3					
		depth of cut a_p (mm)																
		0.1	0.16	0.25	0.4	0.63	1.0	1.6	2.5	4.0	6.3	10.0	11.6	14				
Future Mill series	MM															0.05~0.30	1.0~5.0	<p>For General cutting</p> <ul style="list-style-type: none"> Chip breaker design to cover general cutting condition provides wide available application range Ground type and as sintered type is available
	MR															0.05~0.35	1.5~5.0	<p>For Roughing</p> <ul style="list-style-type: none"> Strongest cutting edge strength provide stable tool life even in case of severe cutting with heavy intermittent and heavy roughing
	MA															0.10~0.35	0.5~5.0	<p>For Aluminum machining</p> <ul style="list-style-type: none"> Sharp cutting edge and lubricated top face show excellent chip flow and welding resistance in aluminum machining
Future Mill series P-posi	MA															0.30~0.60	0.3~6.0	<p>For Aluminum machining</p> <ul style="list-style-type: none"> Excellent surface roughness due to buffed surface in machining aluminum
	ML															0.30~0.50	0.3~3.0	<p>For Hard-to-cut material machining</p> <ul style="list-style-type: none"> Low cutting resistance and high hardness cutting edges for excellent surface roughness in machining titanium and Inconel
	MF															0.12~0.50	0.3~6.0	<p>For Light cutting</p> <ul style="list-style-type: none"> Low cutting resistance for light cutting
	MM															0.20~0.70	0.3~6.0	<p>For General cutting</p> <ul style="list-style-type: none"> Universal purpose for most of milling applications
	None C/B															0.3~0.5	0.30~0.50	<p>For Machining high hardness steel</p> <ul style="list-style-type: none"> Ideal for machining high hardness mold steel and heat resistant alloy
	MF															0.1~0.4	0.30~1.0	<p>For Light cutting</p> <ul style="list-style-type: none"> Chip breaker for cutting with low cutting load is optimal for light cutting.
	None C/B															0.1~0.4	0.30~0.80	<p>For Machining high hardness steel</p> <ul style="list-style-type: none"> Shape with hard cutting edge is optimal for high hardness alloy steel machining.

Notice: Application ranges are based on main cutting material

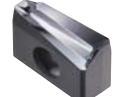

A Chip Breakers

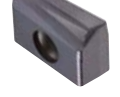







Chip breaker for milling

Geometry	Cutting edge	Application range													Features	
		feed rate f_n (mm/rev)														
		0.04	0.063	0.10	0.16	0.25	0.4	0.63	1.0	1.6	2.5	4.0	6.3			
depth of cut ap (mm)																
		0.1	0.16	0.25	0.4	0.63	1.0	1.6	2.5	4.0	6.3	10.0	11.6	57		
HFMD	ML 							0.30~0.80								For Hard-to-cut material machining
					0.2~1.0											• Chip breaker for cutting with low cutting load and hard cutting edge ensure high qualified machining.
	MF 							0.30~1.0								
					0.2~1.0											• Chip breaker for cutting with low cutting load is for light cutting.
MM 								0.30~1.20								For General cutting
					0.2~1.0											• Shape for general machining with high feed is available for most machining range.
TP2P	MA 				0.05~0.25				1.0~16.5							For Aluminum machining
																• Sharp cutting edge for aluminum machining ensures good machinability. • Buffed surface realizes chip flow and welding resistance.
	ML 					0.05~0.25				1.0~16.5						For Hard-to-cut material machining
																• Chip breaker for cutting with low cutting load guarantees long tool life and qualified machining in light cutting and HRSA machining.
MM 						0.05~0.25				1.0~16.5						For General cutting
																• Specialized shape for general slotting is applicable in most cutting ranges.
Pro-XL Mill	MA 					0.05~0.20										For Aluminum machining
														10~57		• Sharp cutting edge with buffing on the surface for aluminum machining ensures chip flow and welding resistance.
Pro-V Mill	MA 						0.10~0.30									For Aluminum machining
																• Shape for general slotting is applicable in most cutting ranges.

Notice: Application ranges are based on main cutting material



Chip breaker for drilling

Geometry	Cutting edge	Application range												Features									
		feed rate f_n (mm/rev)																					
		0.04	0.063	0.10	0.16	0.25	0.4	0.63	1.0	1.6	2.5	4.0	6.3										
depth of cut a_p (mm)																							
												30	60	90	120	150	180	210	240	270	300	330	900
King Drill series	PD 		<div style="display: flex; justify-content: space-between;"> 0.04~0.20 60~300 </div>												For General cutting • Chip breaker with strong cutting edge for universal applications with steel, stainless steel, and cast iron								
	LD 		<div style="display: flex; justify-content: space-between;"> 0.04~0.15 40~250 </div>												For Light cutting • Superior chip control in machining of mild steel, forged steel and stainless steel								
	RD 		<div style="display: flex; justify-content: space-between;"> 0.04~0.20 60~300 </div>												Reinforced chipping resistance • Improved central chipping resistance due to reinforced corners of the King Drill central inserts • Excellent cutting performance even in machining where there is frequent corner breakage of central inserts • e.g. Machining heat-treated steel or stainless steel, and high feed machining, etc.								
	ND 		<div style="display: flex; justify-content: space-between;"> 0.04~0.10 100~400 </div>												Non-ferrous metals • Chip breaker with sharp and polished cutting edge for aluminum and Non-ferrous metals. Machining with King Drill ensures good chip flow and resistance to chip welding.								

Notice: Application ranges are based on main cutting material



Turning Chip Breakers

- B02 Application range of KORLOY Main Chip Breakers
- B04 Recommended Chip Breakers for workpiece
- B12 Feature of Chip Breakers

Inserts

- B26 Turning Insert Code System (ISO)
- B28 Turning Insert (Negative)
- B66 Turning Insert (Positive)
- B90 Aluminum Insert (Positive)
- B98 cBN Insert
- B102 PCD Insert

SAVE TURN

- B104 Technical Information for Save Turn
- B105 Save Turn Insert
- B106 Save Turn Holder
- B109 Save Turn Boring Bar

Auto Tools

- B111 Technical Information for Auto Tools
- B112 ISO Type
- B117 KHP
- B121 Blade Type
- B124 Multi Utility Type
- B127 KGT/MGT Type
- B130 MSB Tool
- B136 Sleeve

Multi Turn

- B137 Technical Information for Multi Turn
- B139 Multi Turn

Bearing Solutions

- B140 Technical Information for Bearing Solution
- B141 Bearing Solution
- B147 Special Order Form for Bearing Inserts



External Tool Holder

- B148 External Tool Holder Code System (ISO)
- B149 Index for External Holder
- B152 Instruction of External Holder
- B153 Features of Double Clamp / Lever lock System
- B154 Double Clamp System
- B159 Lever Lock System
- B167 Wedge Clamp System
- B169 Clamp On System
- B171 Multi Lock System
- B178 Screw On System
- B185 Ceramic Holder

High Pressure Coolant

- B187 Technical Information for KHP
- B189 KHP

Boring Bar

- B191 Boring Bar Code System (ISO)
- B192 Index for Boring Bar

Boring Bar

- B194 Instruction of Boring Bar assembly
- B195 Double Clamp System
- B197 Lever Lock System
- B201 Clamp On System
- B202 Multi Lock System
- B204 Screw On System
- B214 Compact Mini

HSK/KM Tooling System

- B217 Technical Information for HSK/KM Tooling System
- B219 Index for HSK/KM Tooling System
- B220 HSK Tooling System
- B226 KM Tooling System

Cartridges

- B230 Cartridge Code System (ISO)
- B231 Index for Cartridge
- B232 Clamp On System
- B234 Screw On System



TURNING

Korloy turning tools cover a wide application range with a full line-up of ISO tools that produce high quality and high precision parts for all manufacturers' requirements.

B

B Turning Chip Breakers

Applications range of chip breakers

➤ Negative inserts

Workpiece P
Steel

Heavy	GH	VH	VT
Roughing	GR		
Medium cutting	VM	MP	HM
Medium to finishing	VC	LP	VQ
Finishing	VL	VB	VF

[Recommended]

Workpiece K
Cast iron

Roughing	VR	RK	MA
Medium cutting		MK	
Medium to finishing		MK	B25
Finishing		MP	

[Recommended]

Workpiece M
Stainless steel

Roughing		RM	
Medium cutting	MP	MM	
Medium to finishing		VP2	
Finishing			

[Recommended]

Workpiece N
Aluminum alloy

Roughing			
Medium cutting			
Medium to finishing		HA	
Finishing			

[Recommended]

Workpiece S
Heat resistant alloy

Roughing		VP4	
Medium cutting		VP3	
Medium to finishing		VP2	
Finishing		VP1	

[Recommended]



Applications range of chip breakers

Positive inserts

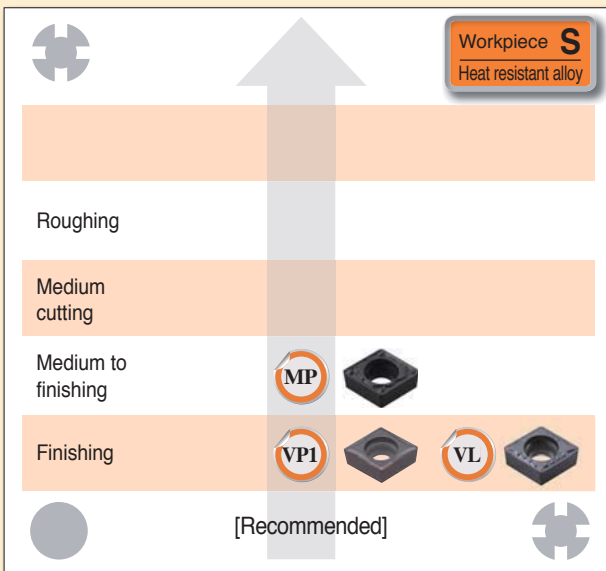
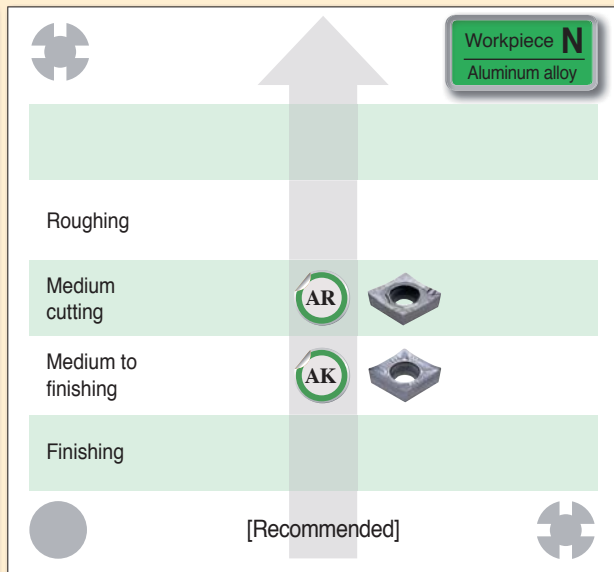
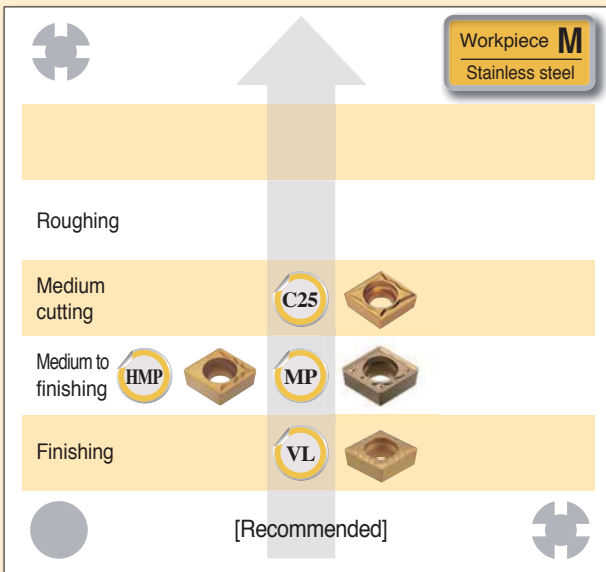
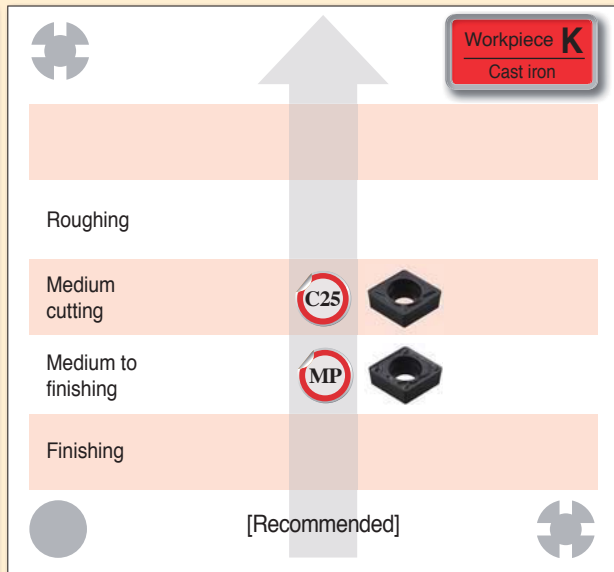
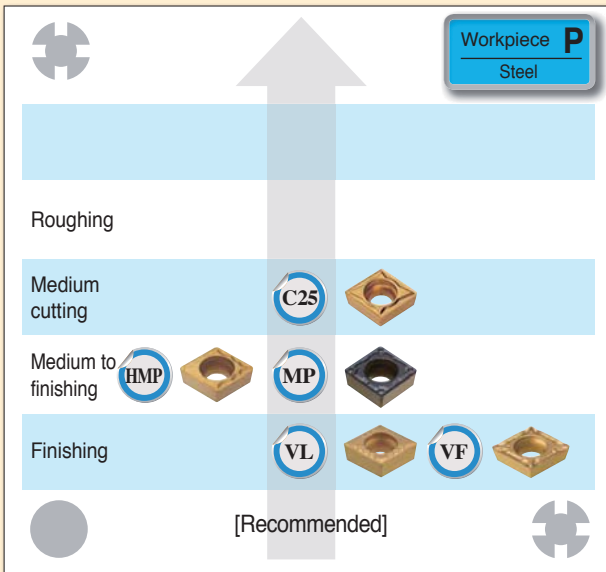

B Turning Chip Breakers

Recommended chip breaker for workpiece

Workpiece
P
Steel

Materials: SM10C, SM15C, SM25C, SS400, SCr415, SCM415, etc. Soft steel

Hardness: under 180HB

Depth of cut (mm)	C/B	Cutting edge	Feed (mm/rev)	Grades	Cutting Speed (m/min)	Insert shape					
						80°	55°	90°	60°	35°	80°
Negative	0.2 ~ 0.8 ~ 1.5 Finishing	VL	0.10 ~ 0.20 ~ 0.35	NC3215 NC3225 CN1500 CN2500	305 250 260 230	CNMG p. B29	DNMG p. B37	SNMG p. B46	TNMG p. B55	VNMG p. B60	WNMG p. B62
	0.5 ~ 1.0 ~ 2.0 Finishing	VB	0.15 ~ 0.20 ~ 0.40	NC3215 NC3225 CN1500 CN2500	340 250 240 210	CNMG p. B28	DNMG p. B36		TNMG p. B54		WNMG p. B62
	0.5 ~ 1.0 ~ 1.5 Finishing	VF	0.05 ~ 0.15 ~ 0.35	NC3215 NC3220 NC3225 NC5330	305 270 270 210	CNMG p. B28	DNMG p. B37	SNMG p. B46	TNMG p. B55	VNMG p. B60	WNMG p. B62
	0.5 ~ 1.5 ~ 3.5 Medium to finishing	VC	0.12 ~ 0.25 ~ 0.45	NC3215 NC3220 NC3225 NC5330	285 250 255 200	CNMG p. B29	DNMG p. B38	SNMG p. B46	TNMG p. B55	VNMG p. B60	WNMG p. B63
	0.5 ~ 1.0 ~ 2.5 Medium to finishing	LP	0.10 ~ 0.25 ~ 0.40	NC3215 NC3225 NC5330	300 250 200	CNMG p. B29	DNMG p. B38	SNMG p. B46	TNMG p. B55	VNMG p. B60	WNMG p. B63
	0.5 ~ 1.3 ~ 3.5 Medium to finishing	VQ	0.12 ~ 0.28 ~ 0.42	NC3215 NC3225 NC5330	300 250 200	CNMG p. B30	DNMG p. B38	SNMG p. B47	TNMG p. B56	VNMG p. B61	WNMG p. B63
	0.5 ~ 1.5 ~ 4.5 Medium cutting	MP	0.15 ~ 0.30 ~ 0.45	NC3215 NC3225 NC5330	300 265 200	CNMG p. B31	DNMG p. B39	SNMG p. B48	TNMG p. B56	VNMG p. B61	WNMG p. B64
	1.0 ~ 2.5 ~ 5.0 Medium cutting	VM	0.10 ~ 0.25 ~ 0.50	NC3215 NC3220 NC3225 NC5330 CN1500 CN2500	295 260 260 205 220 200	CNMG p. B32	DNMG p. B40	SNMG p. B48	TNMG p. B57	VNMG p. B61	WNMG p. B64
	1.5 ~ 2.5 ~ 5.5 Medium cutting	HM	0.12 ~ 0.28 ~ 0.52	NC3215 NC3225 NC5330	300 265 200	CNMG p. B30	DNMG p. B39	SNMG p. B47	TNMG p. B56	VNMG p. B61	WNMG p. B63
	1.0 ~ 3.0 ~ 4.5 Roughing	GR	0.20 ~ 0.35 ~ 0.50	NC3125 NC3225 NC5330	180~370 150~330 130~280	CNMG p. B33	DNMG p. B41	SNMG p. B49	TNMG p. B58		WNMG p. B64
5.0 ~ 8.0 ~ 3.5 Heavy	GH		NC3125 NC3225 NC5330	180~370 150~330 130~280	CNMM p. B35		SNMM p. B51				
6.0 ~ 10.0 ~ 15.0 Heavy (General)	VH		NC3215 NC3030 NC500H NC5330	50~250 50~150 50~150 50~150	CNMM p. B35		SNMM p. B51				
7.0 ~ 12.0 ~ 17.0 Heavy (High feed cutting)	VT		NC3215 NC3030 NC500H NC5330	50~250 50~150 50~150 50~150	CNMM p. B35		SNMM p. B51				

• The first recommended cutting condition



Workpiece
P
Steel

Recommended chip breaker for workpiece

Materials: SM10C, SM15C, SM25C, SS400, SCr415, SCM415, etc. Soft steel

Hardness: under 180HB

Depth of cut (mm)	C/B	Cutting edge	Feed (mm/rev)	Grades	Cutting Speed (m/min)	Insert shape					
						80°	55°	90°	60°	35°	80°
Positive	0.1 ~ 0.5 ~1.0 Finishing	VL	0.05 ~ 0.10 ~0.20	NC3215 NC3220 NC3225 NC5330 CN1500 CN2500	305 270 270 210 260 240	CCMT p. B68	DCMT p. B73	SCMT p. B75	TCMT p. B79	VB(C)MT p. B85	
	0.1 ~ 0.5 ~1.5 Finishing	VF	0.05 ~ 0.15 ~0.25	NC3215 NC3220 NC3225 NC5330 CC1500 CN1500 CN2500	305 270 270 210 260 250 230	CCMT p. B68	DCMT p. B72	SCMT p. B74	TC(P)MT p. B79	VB(C)MT p. B84	
	0.5 ~ 1.5 ~3.0 Medium to finishing	HMP	0.08 ~ 0.20 ~0.40	NC3215 NC3220 NC3225 NC5330 CN1500 CN2500	320 285 285 225 240 220	CCMT p. B69	DCMT p. B73	SCMT p. B75	TCMT p. B79	VB(C)MT p. B85	
	0.5 ~ 1.0 ~3.0 Medium to finishing	MP	0.10 ~ 0.20 ~0.35	NC3215 NC3225 CN1500 CN2500	300 250 240 200	CCMT p. B69	DCMT p. B73	SCMT p. B75	TC(P)MT p. B79	VB(C)MT p. B84	
	1.0 ~ 2.0 ~3.0 Medium cutting	C25	0.10 ~ 0.25 ~0.35	NC3215 NC3220 NC3225 NC5330 CN1500 CN2500	320 285 285 225 230 210	CCMT p. B69	DCMT p. B73	SCMT p. B75	TCMT p. B80		

• The first recommended cutting condition

P Negative

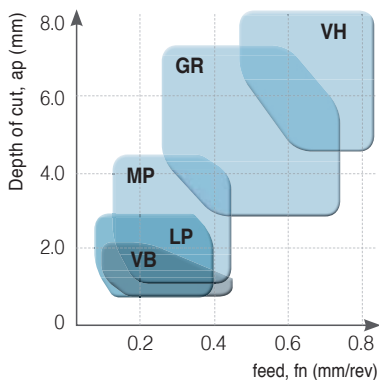

P Positive

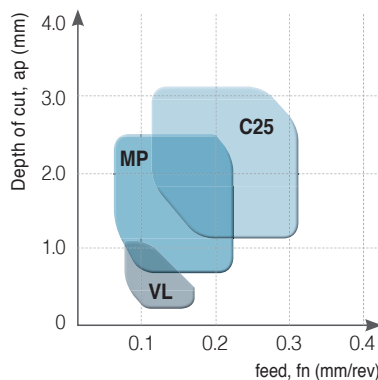

B Turning Chip Breakers

Recommended chip breaker for workpiece

Workpiece
P
Steel

Materials: SM45C, SM55C, SCM430, SCM440, etc. General steel

Hardness: under 180~260HB

Depth of cut (mm)	C/B	Cutting edge	Feed (mm/rev)	Grades	Cutting Speed (m/min)	Insert shape					
						80°	55°	90°	60°	35°	80°
Negative	0.5 ~ 1.0 ~2.0 Finishing	VB	0.15 ~ 0.20 ~0.40	NC3215 NC3225 CN1500 CN2500	340 250 230 190	CNMG p. B28	DNMG p. B36		TNMG p. B54		WNMG p. B62
	0.5 ~ 1.0 ~1.5 Finishing	VF	0.05 ~ 0.15 ~0.35	NC3215 NC3225 NC5330	305 270 250	CNMG p. B28	DNMG p. B37	SNMG p. B46	TNMG p. B55	VNMG p. B60	WNMG p. B62
	0.5 ~ 1.5 ~3.5 Medium to finishing	VC	0.12 ~ 0.25 ~0.45	NC3215 NC3220 NC3225 NC5330	285 255 250 200	CNMG p. B29	DNMG p. B38	SNMG p. B46	TNMG p. B55	VNMG p. B60	WNMG p. B63
	0.5 ~ 1.0 ~2.5 Medium to finishing	LP	0.10 ~ 0.25 ~0.40	NC3215 NC3225 NC5330	300 250 200	CNMG p. B29	DNMG p. B38	SNMG p. B46	TNMG p. B55	VNMG p. B60	WNMG p. B63
	0.5 ~ 1.5 ~4.5 Medium cutting	MP	0.15 ~ 0.30 ~0.45	NC3215 NC3225 NC5330	300 250 200	CNMG p. B31	DNMG p. B39	SNMG p. B48	TNMG p. B56	VNMG p. B61	WNMG p. B64
	1.0 ~ 2.5 ~5.0 Medium cutting	VM	0.10 ~ 0.25 ~0.50	NC3215 NC3220 NC3225 NC5330 CN1500 CN2500	260 245 245 205 210 170	CNMG p. B32	DNMG p. B40	SNMG p. B48	TNMG p. B57	VNMG p. B61	WNMG p. B64
	1.0 ~ 3.0 ~4.5 Roughing	GR	0.20 ~ 0.35 ~0.50	NC3125 NC3225 NC5330	180~370 150~330 130~280	CNMG p. B33	DNMG p. B41	SNMG p. B49	TNMG p. B58		WNMG p. B64
	6.0 ~ 10.0 ~15.0 Heavy (General)	VH	0.70 ~ 1.00 ~1.40	NC3215 NC3030 NC500H NC5330	50~250 50~150 50~150 50~150	CNMM p. B35		SNMM p. B51			
	7.0 ~ 12.0 ~17.0 Heavy (High feed cutting)	VT	0.75 ~ 1.20 ~1.60	NC3215 NC3030 NC500H NC5330	50~250 50~150 50~150 50~150	CNMM p. B35		SNMM p. B51			
	Positive	0.1 ~ 0.5 ~1.0 Finishing	VL	0.05 ~ 0.10 ~0.20	NC3215 NC3220 NC3225 NC5330 CN1500 CN2500	345 310 310 240 250 210	CCMT p. B68	DCMT p. B73	SCMT p. B75	TCMT p. B79	VB(C)MT p. B85
0.1 ~ 0.5 ~1.5 Finishing		VF	0.05 ~ 0.15 ~0.25	NC3215 NC3220 NC3225 NC5330 CC1500 CN1500 CN2500	265 300 300 230 260 240 210	CCMT p. B68	DCMT p. B72	SCMT p. B74	TC(P)MT p. B79	VCMT p. B84	
0.3 ~ 1.5 ~3.0 Medium to finishing		MP	0.05 ~ 0.15 ~0.35	NC3215 NC3225	300 250	CCMT p. B69	DCMT p. B73	SCMT p. B75	TC(P)MT p. B80	VB(C)MT p. B85	
1.0 ~ 2.0 ~3.0 Medium cutting		C25	0.10 ~ 0.15 ~0.35	NC3215 NC3220 NC3225 NC5330 CN1500 CN2500	320 285 285 225 230 200	CCMT p. B69	DCMT p. B73	SCMT p. B75	TCMT p. B80		

• The first recommended cutting condition



Workpiece
P
Steel

Recommended chip breaker for workpiece

Materials: SNC415, SNC815, SNCM240, SNCM439, STS12, STS61, etc
SCM440, Hardened steel

Hardness: 260~350HB

Depth of cut (mm)	C/B	Cutting edge	Feed (mm/rev)	Grades	Cutting Speed (m/min)	Insert shape					
						80°	55°	90°	60°	35°	80°
Negative	0.5 ~ 1.0 ~ 2.0 Finishing	VB	0.15 ~ 0.20 ~ 0.40	NC3215 NC3225 CN1500 CN2500	200 148 220 200	CNMG p. B28	DNMG p. B36		TNMG p. B55		WNMG p. B62
	0.5 ~ 1.0 ~ 1.5 Finishing	VF	0.08 ~ 0.15 ~ 0.30	NC3215 NC3220 NC3225	180 159 159	CNMG p. B28	DNMG p. B37	SNMG p. B46	TNMG p. B55	VNMG p. B60	WNMG p. B62
	0.5 ~ 1.5 ~ 3.5 Medium to finishing	VC	0.12 ~ 0.25 ~ 0.45	NC3215 NC3220 NC3225 NC5330	168 148 150 200	CNMG p. B29	DNMG p. B38	SNMG p. B46	TNMG p. B55	VNMG p. B60	WNMG p. B63
	0.5 ~ 1.0 ~ 2.5 Medium to finishing	LP	0.10 ~ 0.25 ~ 0.40	NC3215 NC3225 NC5330	250 200 200	CNMG p. B29	DNMG p. B38	SNMG p. B46	TNMG p. B55	VNMG p. B60	WNMG p. B63
	0.5 ~ 1.5 ~ 4.5 Medium cutting	MP	0.15 ~ 0.30 ~ 0.45	NC3215 NC3225 NC5330	250 200 200	CNMG p. B31	DNMG p. B39	SNMG p. B48	TNMG p. B56	VNMG p. B61	WNMG p. B64
	1.0 ~ 2.5 ~ 5.0 Medium cutting	VM	0.15 ~ 0.25 ~ 0.50	NC3215 NC3220 NC3225 CN1500 CN2500	174 153 153 120 100	CNMG p. B32	DNMG p. B40	SNMG p. B48	TNMG p. B57	VNMG p. B61	WNMG p. B64
	1.0 ~ 3.0 ~ 4.5 Roughing	GR	0.20 ~ 0.35 ~ 0.50	NC3125 NC3225 NC5330	180~370 150~330 130~280	CNMG p. B33	DNMG p. B41	SNMG p. B49	TNMG p. B58		WNMG p. B64
	6.0 ~ 10.0 ~ 15.0 Heavy (General)	VH	0.70 ~ 1.00 ~ 1.40	NC3215 NC3030 NC500H NC5330	50~250 50~150 50~150 50~150	CNMM p. B35		SNMM p. B51			
	7.0 ~ 12.0 ~ 17.0 Heavy (High feed cutting)	VT	0.75 ~ 1.20 ~ 1.60	NC3215 NC3030 NC500H NC5330	50~250 50~150 50~150 50~150	CNMM p. B35		SNMM p. B51			
	Positive	0.1 ~ 0.5 ~ 1.0 Finishing	VL	0.05 ~ 0.10 ~ 0.20	NC3215 NC3220 NC3225 NC5330 CN1500 CN2500	305 310 310 240 210 190	CCMT p. B68	DCMT p. B73	SCMT p. B75	TCMT p. B79	VB(C)MT p. B85
0.1 ~ 0.5 ~ 1.5 Finishing		VF	0.05 ~ 0.15 ~ 0.25	NC3215 NC3220 NC3225 NC5330 CC1500 CN1500 CN2500	330 300 300 230 260 250 240	CCMT p. B68	DCMT p. B72	SCMT p. B74	TC(P)MT p. B79	VB(C)MT p. B84	
0.3 ~ 1.5 ~ 3.0 Medium to finishing		MP	0.05 ~ 0.15 ~ 0.35	NC3215 NC3225 NC5300 CN1500 CN2500	305 285 225 240 220	CCMT p. B69	DCMT p. B73	SCMT p. B75	TC(P)MT p. B80	VB(C)MT p. B85	
1.0 ~ 2.0 ~ 3.0 Medium cutting		C25	0.10 ~ 0.15 ~ 0.35	NC3215 NC3220 NC3225 NC5330 CN1500 CN2500	320 285 285 225 100 80	CCMT p. B69	DCMT p. B73	SCMT p. B75	TCMT p. B80		

• The first recommended cutting condition

B Turning Chip Breakers

Recommended chip breaker for workpiece

Workpiece
M
Stainless steel

Materials: STS304, STS316, STS430, STS630

Ferrite, austenite, martensite, precipitation hardening stainless steels

Hardness: 135~300HB

Depth of cut (mm)	C/B	Cutting edge	Feed (mm/rev)	Grades	Cutting Speed (m/min)	Insert shape					
						80°	55°	90°	60°	35°	80°
Negative 0.5 ~ 1.5 ~ 4.0 Medium to finishing	VP2		0.10 ~ 0.20 ~ 0.40	PC8105 PC8110 PC8115 PC5300 PC5400	185 170 160 135 120	CNMG p. B30	DNMG p. B38	SNMG p. B46	TNMG p. B55	WNMG p. B63	
	MP		0.15 ~ 0.23 ~ 0.45	PC8105 PC8110 PC8115 PC5300 PC5400	175 160 150 130 110	CNMG p. B31	DNMG p. B39	SNMG p. B48	TNMG p. B56	VNMG p. B61 WNMG p. B64	
	MM		0.12 ~ 0.25 ~ 0.45	NC9115 NC9125 NC9135 PC8110 PC5300	190 170 130 160 150	CNMG p. B31	DNMG p. B39	SNMG p. B47	TNMG p. B56	VNMG p. B61 WNMG p. B63	
	RM		0.15 ~ 0.30 ~ 0.55	NC9115 NC9125 NC9135 PC8110 PC8115 PC5300	190 170 130 160 150 130	CNMG p. B33	DNMG p. B42	SNMG p. B50	TNMG p. B58	VNMG p. B61 WNMG p. B65	
Positive 0.1 ~ 0.5 ~ 1.0 Finishing	VL		0.05 ~ 0.10 ~ 0.20	PC8105 PC8110 PC8115 PC5300 PC5400 NC5330 NC9025	215 195 190 165 135 165 165	CCMT p. B68	DCMT p. B73	SCMT p. B75	TCMT p. B79	VB(C)MT p. B85	
	HMP		0.05 ~ 0.10 ~ 0.25	PC8105 PC8110 PC8115 PC5300 PC5400 NC5330 NC9025	190 175 170 135 120 150 150	CCMT p. B69	DCMT p. B73	SCMT p. B75	TCMT p. B79	VB(C)MT p. B85	
	MP		0.05 ~ 0.15 ~ 0.35	PC8105 PC8110 PC8115 PC5300 PC5400 NC5330 NC9025	190 175 170 135 120 150 150	CCMT p. B69	DCMT p. B73	SCMT p. B75	TC(P)MT p. B80	VB(C)MT p. B85	
	C25		0.08 ~ 0.13 ~ 0.25	PC8110 PC9030	170 155	CCMT p. B69	DCMT p. B73	SCMT p. B75	TCMT p. B80		

• The first recommended cutting condition

M Negative

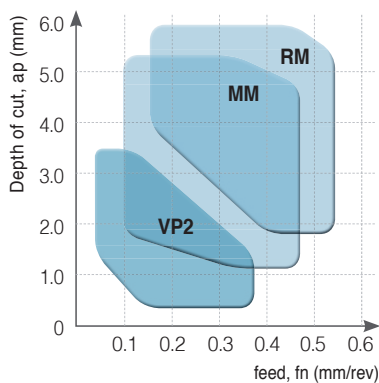

M Positive

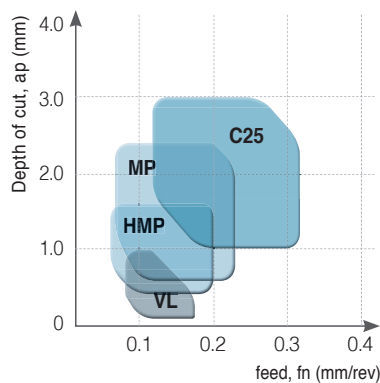

Workpiece
K
Cast iron

Recommended chip breaker for workpiece

Materials: GC250, GC300, GCD400, GCD700, etc : Gray cast iron, Ductile cast iron
Hardness: 135~185HB
Tensile strengt: under 450N/mm²

Depth of cut (mm)	C/B	Cutting edge	Feed (mm/rev)	Grades	Cutting Speed (m/min)	Insert shape					
						80°	55°	90°	60°	35°	80°
Negative	1.0 ~ 3.0 ~ 4.5 Roughing	VR	0.20 ~ 0.35 ~ 0.60	NC6310	220~420	CNMG p. B34	DNMG p. B42	SNMG p. B50	TNMG p. B58		WNMG p. B65
	1.5 ~ 3.0 ~ 6.0 Roughing	RK	0.20 ~ 0.30 ~ 0.60	NC6310	350~550	CNMG p. B33	DNMG p. B41	SNMG p. B49	TNMG p. B58		WNMG p. B65
	1.0 ~ 2.5 ~ 6.0 Roughing	C/B 無	0.15 ~ 0.30 ~ 0.60	DBNX10 DBN500 DBN700 NC6310 NC6315	150~200 200~500 500~2000 140~420 120~290	CNMA p. B28	DNMA p. B36	SNMA p. B45	TNMA p. B54		
	1.0 ~ 2.5 ~ 5.0 Medium to finishing	MK	0.10 ~ 0.25 ~ 0.50	NC6310	350~550	CNMG p. B30	DNMG p. B39	SNMG p. B47	TNMG p. B56	VNMG p. B61	WNMG p. B63
	0.5 ~ 2.0 ~ 3.5 Medium to finishing	B25	0.20 ~ 0.35 ~ 0.60	NC6310 NC6315	140~380 120~290	CNMG p. B32	DNMG p. B41	SNMG p. B49	TNMG p. B57		
	0.5 ~ 1.0 ~ 2.5 Finishing	MP	0.10 ~ 0.25 ~ 0.45	NC6310 NC6315	140~380 120~290	CNMG p. B31	DNMG p. B39	SNMG p. B48	TNMG p. B56	VNMG p. B61	WNMG p. B64
Positive	0.3 ~ 1.5 ~ 3.0 Medium to finishing	MP	0.10 ~ 0.20 ~ 0.35	NC6310	225~290	CCMT p. B69	DCMT p. B73	SCMT p. B75	TC(P)MT p. B80	VB(C)MT p. B85	
	1.0 ~ 2.0 ~ 3.5 Medium cutting	C25	0.10 ~ 0.25 ~ 0.40	NC6310 NC6315	285~340 200	CCMT p. B69	DCMT p. B73	SCMT p. B75	TCMT p. B80		

●: The first recommended cutting condition

K Negative

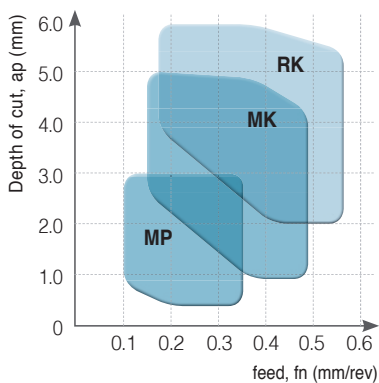

K Positive

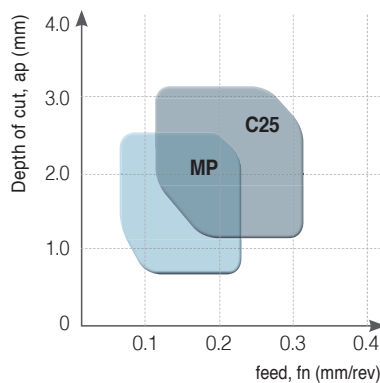

B Turning Chip Breakers

Workpiece
N
Aluminum alloy

Recommended chip breaker for workpiece

Materials: Aluminum alloy

Hardness: 20~110HB

Depth of cut (mm)	C/B	Cutting edge	Feed (mm/rev)	Grades	Cutting Speed (m/min)	Insert shape					
						80°	55°	90°	60°	35°	80°
Negative 0.5 ~ 2.0 ~ 6.0 Medium to finishing	HA		0.10 ~ 0.20 ~ 0.50	H01	500	CNMG p. B29	DNMG p. B37	SNMG p. B46	TNMG p. B55	VNMG p. B60	WNMG p. B62
Positive 0.1 ~ 1.0 ~ 4.0 Medium to finishing	AK		0.03 ~ 0.20 ~ 0.40	H01 ND1000 PD1000	1000	CCGT p. B91	DCGT p. B92	SCGT p. B94	TCGT p. B93	VB(C)GT p. B95	RCGT p. B93
	AR		0.05 ~ 0.30 ~ 0.50	H01 ND1000 PD1000	1000	CCGT p. B91	DCGT p. B92	SCGT p. B94	TCGT p. B95	VB(C)GT p. B96	RCGT p. B93

Materials: Copper Bronze alloy

Hardness: 20~110HB

Depth of cut (mm)	C/B	Cutting edge	Feed (mm/rev)	Grades	Cutting Speed (m/min)	Insert shape					
						80°	55°	90°	60°	35°	80°
Negative 0.5 ~ 2.0 ~ 4.0 Medium to finishing	HA		0.10 ~ 0.20 ~ 0.50	H01	1000	CNMG p. B29	DNMG p. B37	SNMG p. B46	TNMG p. B55	VNMG p. B60	WNMG p. B62
Positive 0.1 ~ 1.0 ~ 3.0 Medium to finishing	AK		0.03 ~ 0.20 ~ 0.30	H01	1000	CCGT p. B91	DCGT p. B92	SCGT p. B94	TCGT p. B95	VB(C)GT p. B96	RCGT p. B93
	AR		0.05 ~ 0.25 ~ 0.40	H01	1000	CCGT p. B91	DCGT p. B92	SCGT p. B94	TCGT p. B95	VB(C)GT p. B96	RCGT p. B93

• The first recommended cutting condition

N Negative

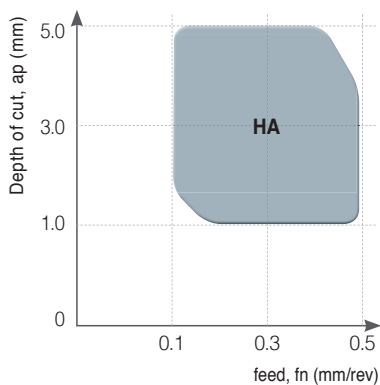

N Positive

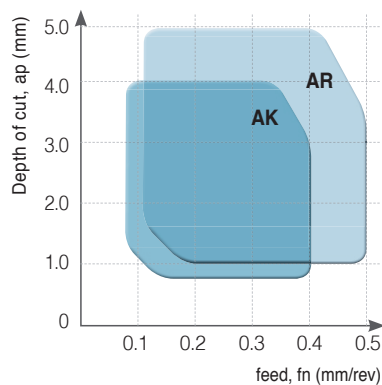

Workpiece
S
Heat resistant
alloy

Recommended chip breaker for workpiece

Materials: Inconel, Nimonic, Stellite, Ti alloy

Hardness: 160~350HB

Depth of cut (mm)	C/B	Cutting edge	Feed (mm/rev)	Grades	Cutting Speed (m/min)	Insert shape					
						80°	55°	90°	60°	35°	80°
Negative 0.1 ~ 0.5 ~ 1.5 Finishing 0.5 ~ 1.5 ~ 4.0 Medium to finishing 0.05 ~ 2.0 ~ 3.0 Medium cutting 1.0 ~ 2.5 ~ 4.0 Roughing	VP1		0.05 ~ 0.10 ~ 0.20	PC8110 PC5300 NC5330	60 50 50	CNGG p. B28	DNGG p. B36				
	VP2		0.10 ~ 0.20 ~ 0.40	PC8110 PC5300	60 45	CNMG p. B30	DNMG p. B38	SNMG p. B46	TNMG p. B55		WNMG p. B63
	VP3		0.05 ~ 0.15 ~ 0.25	PC8110 PC5300	60 40	CNMG p. B32	DNMG p. B40	SNMG p. B48	TNMG p. B57	VNMG p. B61	WNMG p. B64
	VP4		0.15 ~ 0.20 ~ 0.35	PC8115	60 40	CNMG p. B34	DNMG p. B42	SNMG p. B50	TNMG p. B58		WNMG p. B65
Positive 0.1 ~ 0.5 ~ 1.5 Finishing 0.1 ~ 0.5 ~ 1.0 Finishing 0.5 ~ 1.0 ~ 3.0 Medium to finishing	VP1		0.05 ~ 0.10 ~ 0.20	PC8110 PC5300	60 45	CCGT p. B67	DCGT p. B72			VCGT p. B86	
	VL		0.05 ~ 0.10 ~ 0.20	PC8110 PC8115	60 50	CCMT p. B68	DCMT p. B73	SCMT p. B75	TCMT p. B79		VCMT p. B87
	MP		0.10 ~ 0.20 ~ 0.35	PC8110 PC8115	60 50	CCMT p. B69	DCMT p. B73	SCMT p. B75	TC(P)MT p. B80		VB(C)MT p. B85(B87)

•: The first recommended cutting condition

S Negative

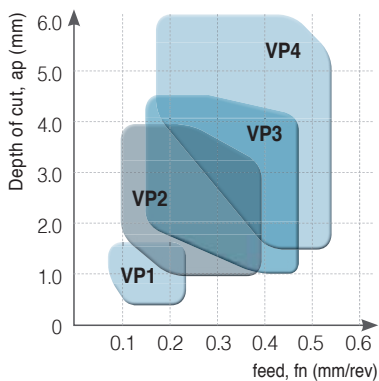

S Positive

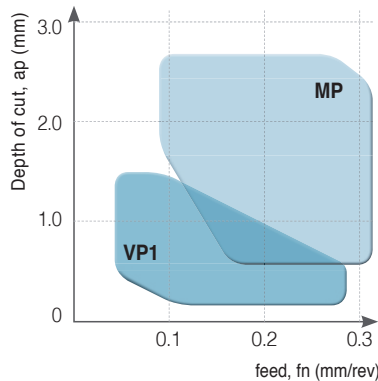

Features of Chip Breaker

LP Chip Breaker new [For medium to finishing]

- Chip breaker for forged steel of automobile parts and normal steel
- Quad dots improve productivity through efficient chip control at high feed
- Angle land minimizes cutting force

Features of LP chip breaker

▶ Front dot

- Higher stability of chip curls at high feed
- Excellent chip control when copying
- Lower cutting force at low depth of cut and high feed

▶ Variable land

- Less crater wear
- Prevents chipping on minor cutting edge

▶ Flat zone

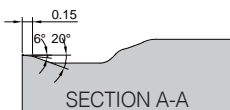

- Larger chip pocket for better chip evacuation at high feed
- Reduced cutting force with larger contact surface of chips

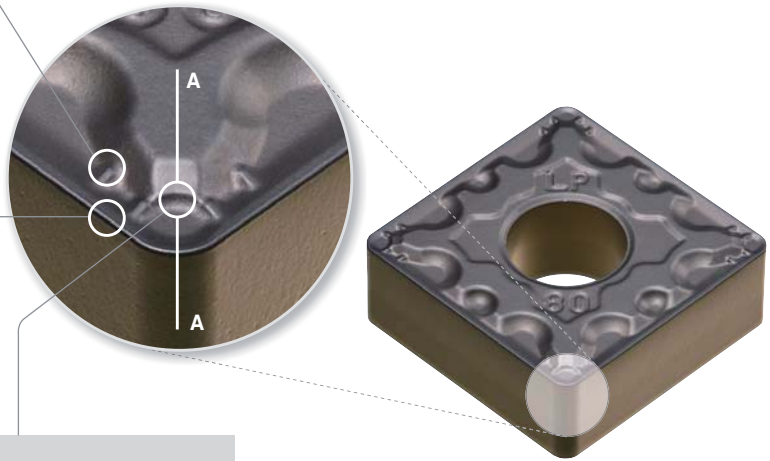

Application range

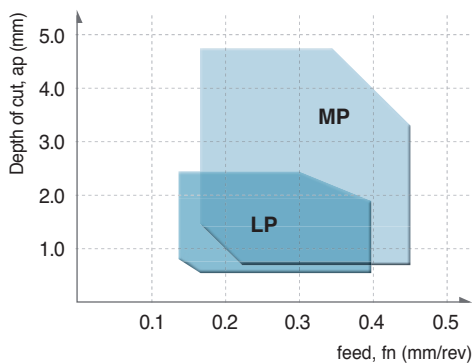

Performance evaluation (Evaluation of cutting force)

- **Workpiece** SM45C, $\varnothing 100$, External machining
- **Cutting condition** v_c (m/min) = 250, a_p (mm) = 1.0, f_n (mm/rev) = 0.25/0.40, wet
- **Tools** CNMG120408-□□

Medium feed (0.25 mm/rev)

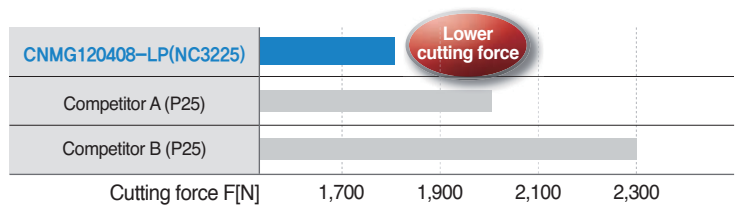

High feed (0.40 mm/rev)

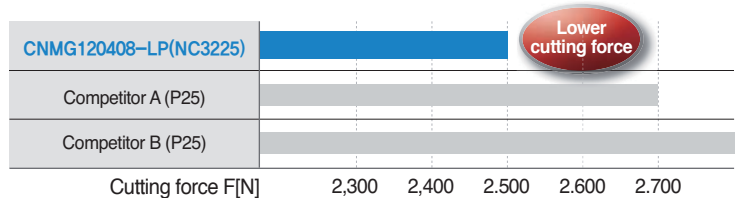

Features of Chip Breaker

MP Chip Breaker new [For medium cutting]

- Chip breaker for forged steel of automobile parts and all other steels
- Quad dots improve productivity through efficient chip control at high feed
- Angle land minimizes cutting force

Features of MP chip breaker

▶ Front two step dot

- Higher stability of chip curls at high feed
- Excellent chip control when copying
- Lower cutting force at high depth of cut

▶ Variable land

- Less crater wear
- Prevents chipping on minor cutting edge
- Higher toughness at high depth of cut and interrupted cutting

▶ Flat zone

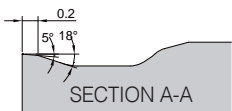

- Larger chip pocket for better chip evacuation at high feed
- Reduced cutting force with larger contact surface of chips

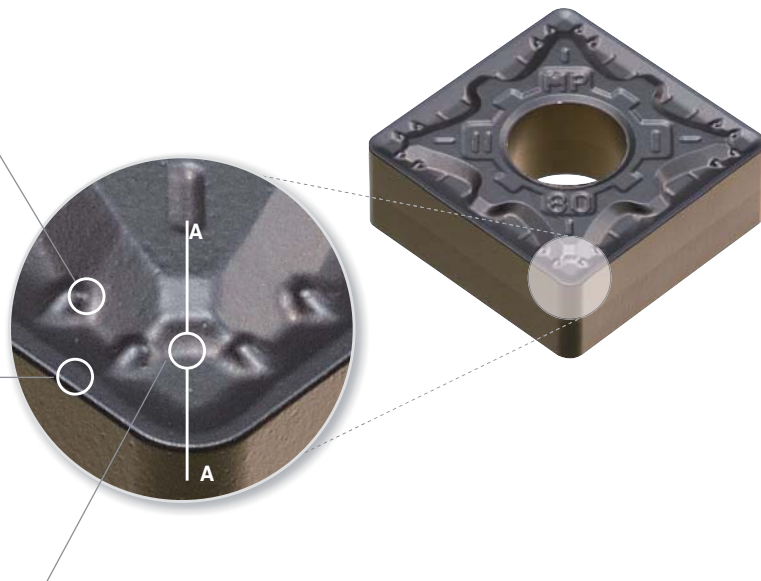

Application range

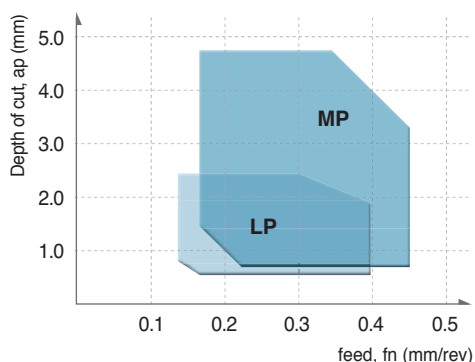

Performance evaluation

- **Workpiece** SCM440 (Alloy steel), Ø100, External machining
- **Cutting condition** v_c (m/min) = 280, a_p (mm) = 1.5, f_n (mm/rev) = 0.25/0.40, wet
- **Tools** CNMG120408-□□

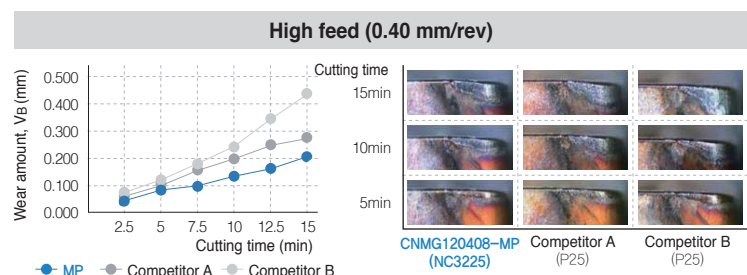
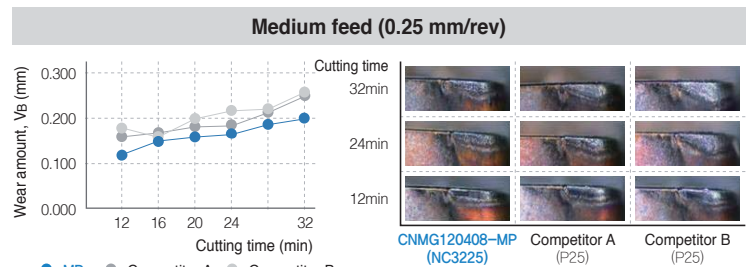

Features of Chip Breaker

MM Chip Breaker new [For medium cutting]

- The 1st recommended chip breaker for stainless steel machining
- Change to: A dual land achieves sharp cutting performance and insert toughness
- Wide chip pockets for stable chip evacuation at high feeds/depths of cut

Features of MM chip breaker

▶ Variable Land

- Excellent chip control and sharp cutting at low depths of cut
- Delays crater wear
- Prevents plastic deformation

▶ Dual Land

- Balance between requirements of sharp and tough cutting edges
- Sharp cutting edge for high speed machining
- Prevents chipping in interrupted machining

▶ Wide Chip Pocket

- Stable chip evacuation at high speeds/feeds
- Improved surface finishes by reduced workpiece scratches caused by work-hardened chips at high depths of cut
- Prevents built-up edge

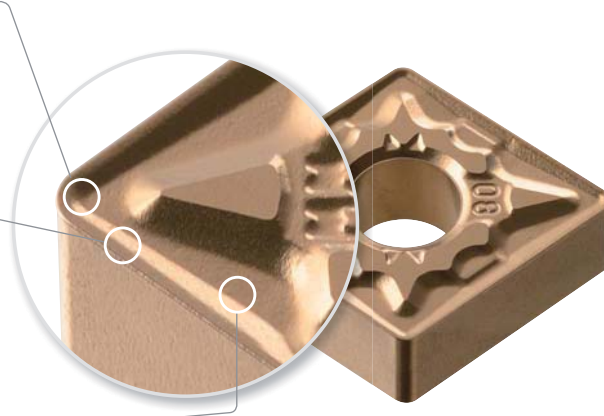

Performance evaluation

Built-up edge

- **Workpiece** STS405 (Ferrite)
- **Cutting condition** vc (m/min) = 180, fn (mm/rev) = 0.3, ap (mm) = 3.0, wet
- **Tools** **Insert** : CNMG120408-MM (NC9125)
Holder : PCLNL2525-M12

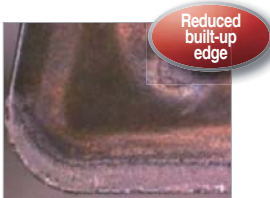

MM (NC9125)



Competitor

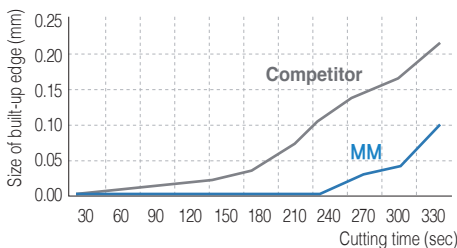

Plastic deformation

- **Workpiece** STS316 (Austenite)
- **Cutting condition** vc (m/min) = 200, fn (mm/rev) = 0.35, ap (mm) = 2.0, dry
- **Tools** **Insert** : CNMG120408-MM (NC9135)
Holder : PCLNL2525-M12

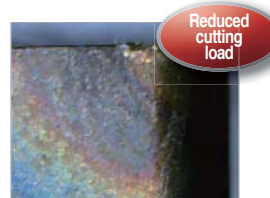

MM (NC9135)

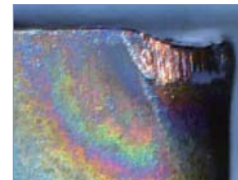

Competitor

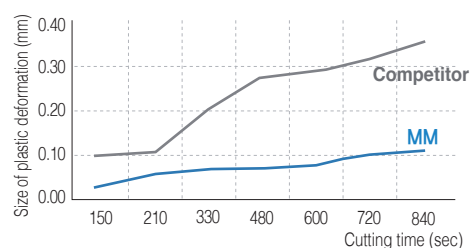

Features of Chip Breaker

RM Chip Breaker new [For roughing]

- The 1st recommended chip breaker for rough and interrupted machining of stainless steel
- Prevents notch wear and burrs at high feeds and depths of cut
- Reduced cutting force extends tool life in high feed machining

Features of RM chip breaker

▶ Variable Land

- Excellent chip control and sharp cutting at low depths of cut
- Delays crater wear
- Prevents plastic deformation

▶ Wide land & Gentle front angle

- Sharp cutting edges and a wide land reduce cutting force
- Reduced burrs
- Dispersed cutting load enables higher toughness

▶ Stepped Design

- Stepped design makes chip evacuation easier
- Smooth chip evacuation prevents plastic deformation

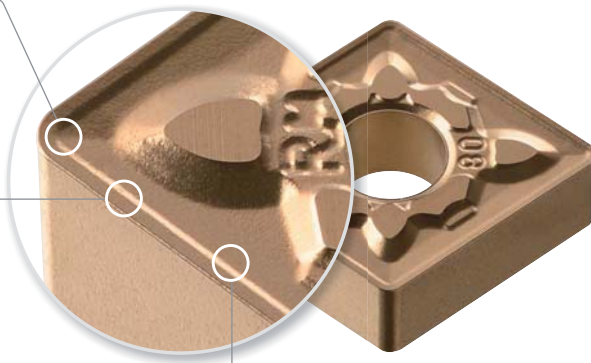

Performance evaluation

Notch wear

- **Workpiece** STS410 (Martensite)
- **Cutting condition** vc (m/min) = 150, fn (mm/rev) = 0.25, ap (mm) = 3.0, wet
- **Tools** **Insert** : CNMG120408-RM (NC9115)
Holder : PCLNL2525-M12

Burr

- **Workpiece** Duplex
- **Cutting condition** vc (m/min) = 120, fn (mm/rev) = 0.2, ap (mm) = 2.0, dry
- **Tools** **Insert** : CNMG120408-RM (NC9125)
Holder : PCLNL2525-M12



RM (NC9115)



Competitor



RM (NC9125)



Competitor

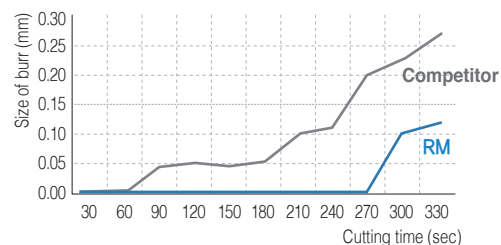
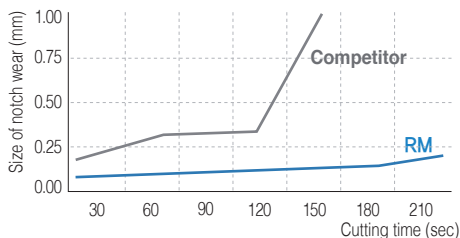

Features of Chip Breaker

MK Chip Breaker new [For medium cutting]

- Ideally suited for continuous cutting of ductile cast iron and gray cast iron
- Angle lands provide upgraded surface finish

Features of MK chip breaker

Angle land



- Angle lands provide sharper cutting performance
- Maximized wear resistance in continuous cutting
- High quality results in surface finish

Wide supporting area

- Higher clamping stability
- Prevents chipping at vibrations during operation



Performance evaluation

Wear resistance test

- **Workpiece** GCD500(KS), Ø90 (Spherical tube) → Ø30 machining
- **Cutting conditions** vc (m/min) = 400, fn (mm/rev) = 0.35, ap (mm) = 2.5, wet
- **Cutting time** 30 passes with results of normal wear on rake/flank surface
- **Tools** Insert : CNMG120408-MK (NC6315)
Holder : DCLNR2525-M12



MK (NC6315)

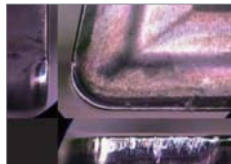

Existing product

130% increased flank wear resistance

Recommended cutting range

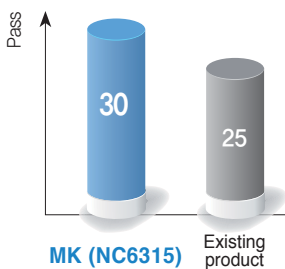
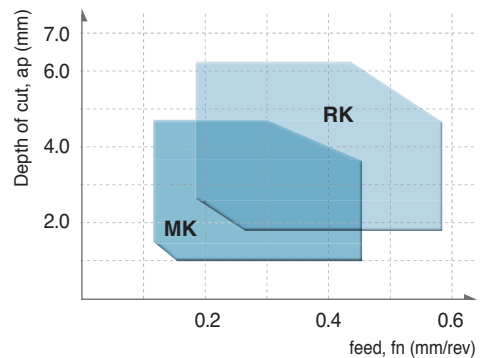

Features of Chip Breaker

RK Chip Breaker new [For roughing]

- Ideally suited for high speed / high feed cutting of ductile cast iron and gray cast iron
- Flat lands provide upgraded toughness and chipping resistance

Features of RK chip breaker

Flat land



- Flat lands provide upgraded toughness and chipping resistance
- Stable machining availability under high cutting loads at high depth of cuts or interrupted cutting
- Optimized land width for high feed machining

Wide supporting area

- Higher clamping stability
- Minimizes vibration and chipping.



Performance evaluation

Impact resistance test

- **Workpiece** GCD500(KS), Ø90 (Triangular tube) → Ø30 machining
- **Cutting conditions** v_c (m/min) = 380, f_n (mm/rev) = 0.35, a_p (mm) = 2, wet
- **Cutting time** 15 passes with results of normal rake surface wear and good chipping resistance
- **Tools** Insert : CNMG120408-RK (NC6315)
Holder : DCLNR2525-M12



RK (NC6315)

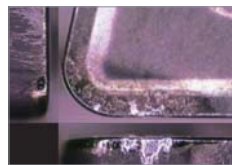

Existing product

125% increased chipping resistance

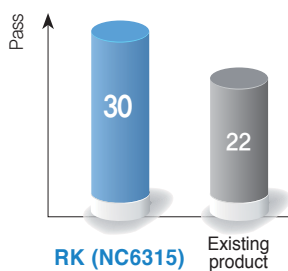

Recommended cutting range

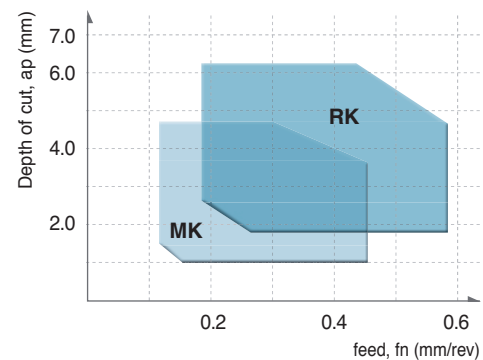

Features of Chip Breaker

VP1 Chip Breaker [For finishing]

- Cutting edges designed in high-positive
 - Reduced contact area between rake surface and chip minimizes cutting heat and improved tool life
- Recommended cutting conditions: f_n (mm/rev) = 0.05~0.2, a_p (mm) = 0.1~1.5

Optimized design for finishing



- Obtains excellent cutting performance and quality surface finish at low depth of cut and high speed

High-positive blade design

- Minimizes cutting heat by reducing the contact area between flank surface and chips
- Prevents built-up edge and extends tool life

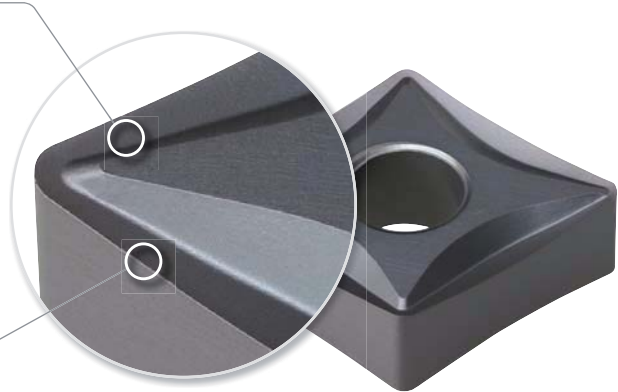

VP2 Chip Breaker [For medium to finishing]

- High-positive cutting edge design/Side rake angle applied
 - Stable chip control improves machinability when ball machining at variable depths of cut
- Recommended cutting conditions: f_n (mm/rev) = 0.1~0.4, a_p (mm) = 0.5~4.5

Sharp blades and wide chip pockets

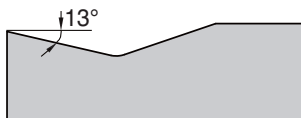

- Increase productivity
- Ideal for medium to finish cutting

High-positive blade design

- Improves cutting performance with its stable chip control at varying depth of cuts

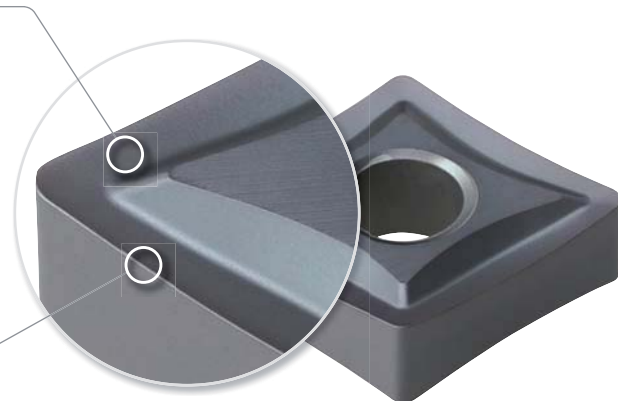

Features of Chip Breaker

VP3 Chip Breaker [For medium cutting]

- High-positive cutting edge design/Wide land applied
 - Improved stability at interrupted cutting when toughness is required. Stable chip control and machinability at high depth of cut
- Recommended cutting conditions: f_n (mm/rev) = 0.1~0.45, a_p (mm) = 0.5~5.0

Chip pocket design leading to a R-shaped cutting edge

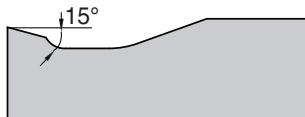

- Creates a stepped space between edge and land to make smooth chip flow at low and high depth of cuts

High-positive blade design / Wide land

- Minimize heat concentration at high depth of cut
- Improves stability in interrupted machining of a tough workpiece

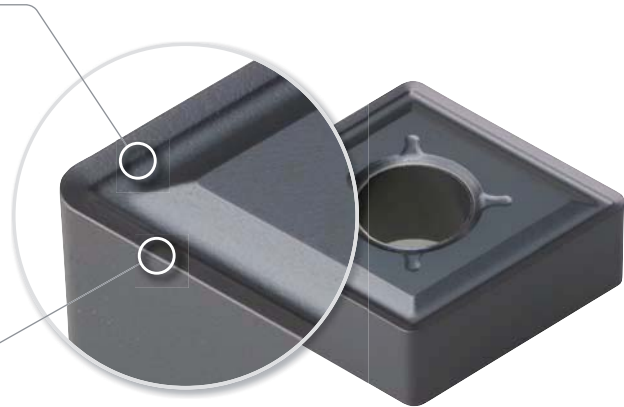

VP4 Chip Breaker **new** [For roughing]

- The 1st recommended chip breakers for machining Inconel which remains highly resistant to and hard at high temperature
- Rough machining stability resulting from reinforced cutting edges and wide chip pockets

Rake angle design resistant to high hardness cutting

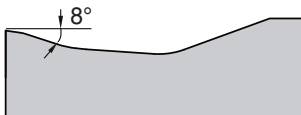

- Reinforces cutting edges and prevents notch wear in rough surface machining
- Prevents chipping in interrupted cutting

Wide chip pockets

- Reduce cutting loads and improve stability even at high depth of cut in roughing

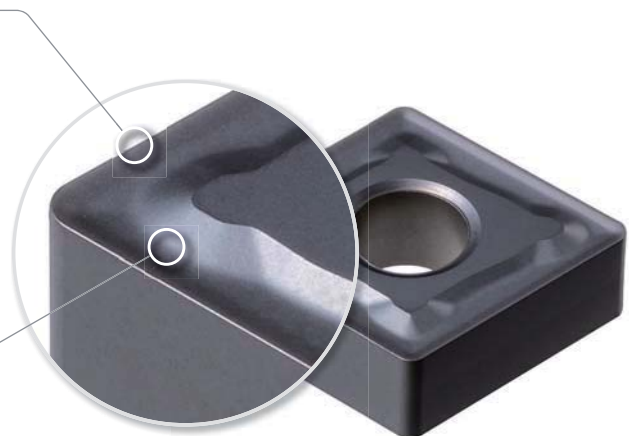

Features of Chip Breaker

Single-sided VL Chip Breaker

[For finishing]

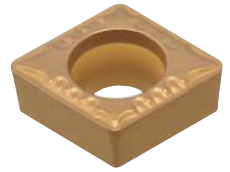

- The sharp flank surface and the chip breaker design significantly improve chip control when machining tough materials such as low carbon steel, pipe steel, and iron plates
- Sharp cutting edges reduce cutting resistance and provide excellent chip control at low depth of cuts, leading to stable machining on automated production lines

Features of VL chip breaker

- **Sharp cutting edges**
 - High rake cutting edges provide improved surface finishes
 - Low cutting resistance reduces cutting heat
- **2-step rear rake angle**
 - Stable chip control regardless of varying feed rates
 - Excellent machinability even when machining mild workpieces

Chip control test

- **Workpiece** SCM440(Alloy steel), Ø50, Internal diameter turning
- **Cutting condition** $vc = 250$ m/min, $ap = 0.3\sim 1.5$ mm, $fn = 0.05\sim 0.25$ mm/rev
- **Tools** CCMT09T304-VL

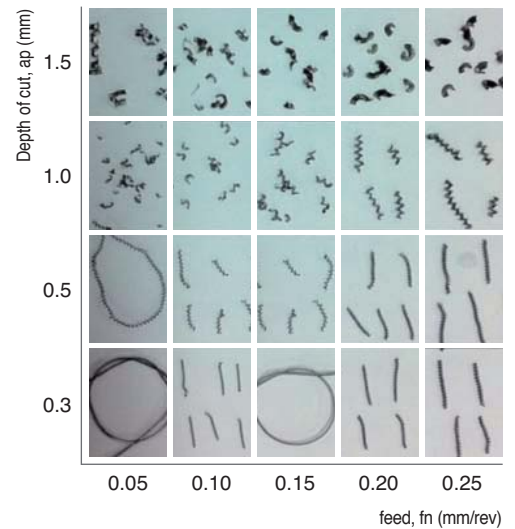

Single-sided MP Chip Breaker

[For medium to finishing]

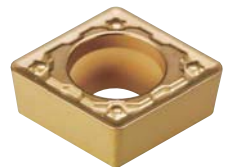

- For continuous cutting of forged steel at high feed
- Turning insert for internal machining of automobile components

Features of MP chip breaker

- **Three-dimensional 2 step chip breaker**
 - Stable chip control in unstable internal machining
 - Prevents chip blocking at internal diameter at varying depth of cut and feed.
- **Stronger cutting edge and wide chip pocket**
 - Increased chipping resistance in unstable internal machining

Chip control test

- **Workpiece** SCM440
- **Cutting condition** $vc = 200$ m/min, $ap = 0.5\sim 2.5$ mm, $fn = 0.05\sim 0.25$ mm/rev
- **Tools** CCMT09T304-MP

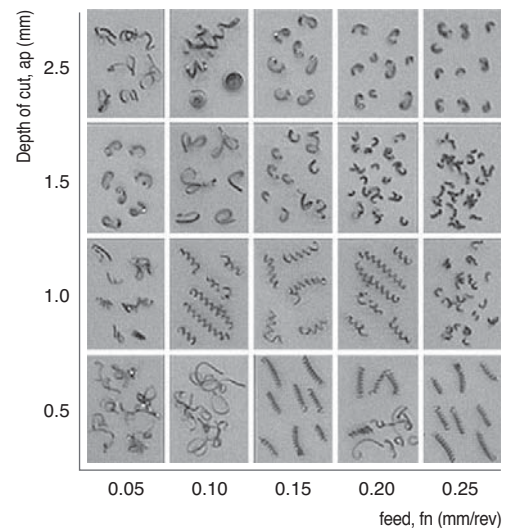

Features of Chip Breaker

VL Chip Breaker [For finishing]

- Improved chip control for machining material that have high toughness such as low carbon steel, pipe, steel plate etc
- Improved chip control and decreased cutting load on external, facing, and copying applications
- Improved strength of the cutting edge for measurable efficiency in automated production



Features of VC chip breaker

- **2 steps designed chip-breaker** - Suitable Mild steel
- Stable chip control on the low feed and cutting depth
- **Designed with special dots** - Stable chip breaking on the low cutting depth
- **Applied side rake angle** - Improved chip control on facing, copying applications
- Decreased cutting load and better surface finish

Chip control test

- **Workpiece** SM20C
- **Cutting conditions** $vc = 250 \text{ m/min}$, $ap = 0.5 \text{ mm}$
 $fn = 0.2 \text{ mm/rev}$ (Side), wet
- **Tools** DNMG150408-VL

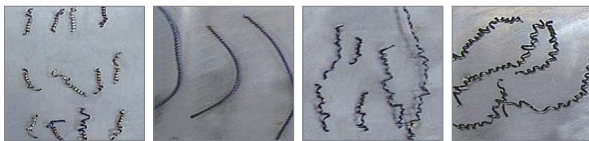

VL
Chip Breakers

FEM Cutting simulation analysis in the design

- For design of geometry, chip shapes and chip flow are predictable
- Optimal chip breaker design by various cutting conditions and workpieces

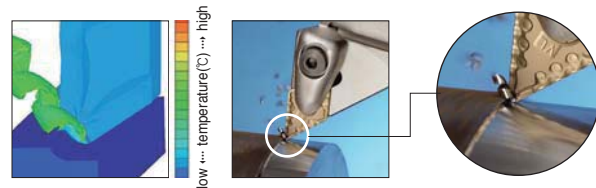

VB Chip Breaker [For finishing]

- Excellent chip evacuation in continuous and high speed machining of various workpieces
- 3-dimensional chip breaker achieves lower cutting resistance, high rigidity of the cutting edge, and longer tool life
- Stable chip control in copying and internal machining

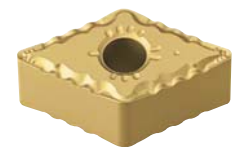

Features of VB chip breaker

- **6 bumps on the insert corner** - Superior chip control and chip cutting in copying with various depths of cut
- **Side rake angle** - Superb chip cutting in facing and copying. Superior tool life due to improved surface roughness and lower cutting resistance
- **Cutting edge on 100° part for medium machining (For CNMG)** - Excellent chip evacuation and toughness in machining with high depth of cut

Performance

Better machining Better Chip control Longer tool life

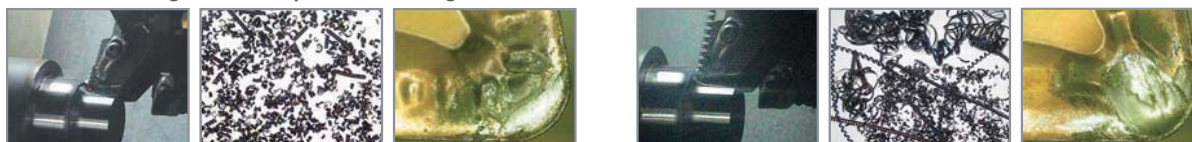

VB Chip Breakers

Conventional chip breaker

B Turning Chip Breakers

Features of Chip Breaker

VC Chip Breaker [For medium to finishing]



- Superior chip evacuation in high speed and continuous machining of various workpieces (carbon steel, alloy steel etc.)
- Korloy 3 dimensional chip breaker ensures longer tool life due to low cutting load and improved cutting edge strength
- Stable chip control in copying and internal machining

Features of VC chip breaker

- 4 bums on the insert corner
 - Excellent chip control in various depths of cut and superb chip cutting in external, internal, copy machining and facing

Evaluation of chip control (Copying)

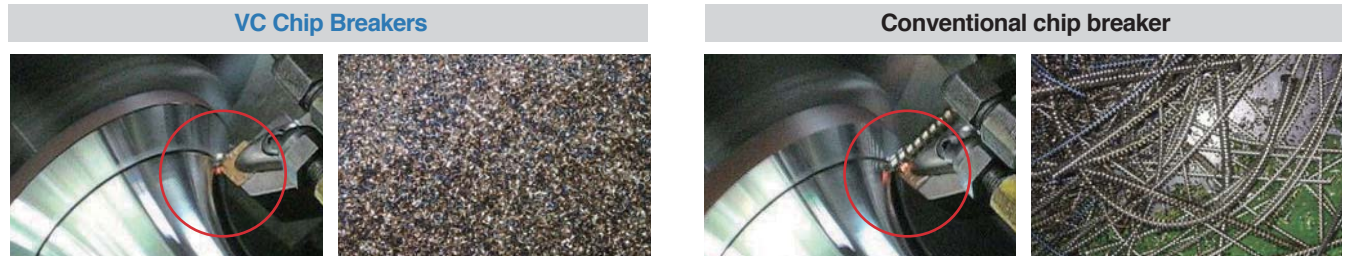

VQ Chip Breaker [For medium to finishing_For cermet]

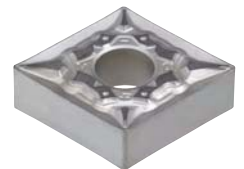

- Excellent cutting performance and reinforced cutting edges
- Improved chip control at low depth of cuts

Features of VQ chip breaker

- | | |
|--|---|
| <ul style="list-style-type: none"> • Three dimensional rake angle <ul style="list-style-type: none"> - Improved surface finish thanks to sharp cutting performance - Less cutting heat and longer tool life thanks to low cutting resistance | <ul style="list-style-type: none"> • Beveled protruding structure <ul style="list-style-type: none"> - Smooth chip flow at low depth of cuts - Wide application range |
|--|---|

Performance evaluation

- **Workpiece** SCM440(Alloy steel), Ø100, External diameter turning
- **Cutting condition** vc = 280 m/min, ap = 1.5 mm, fn = 0.25 mm/rev
- **Tools** CNMG120408-VQ

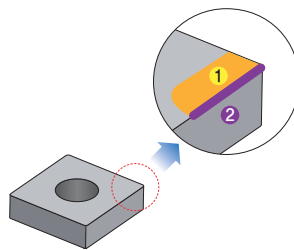

Wear comparison

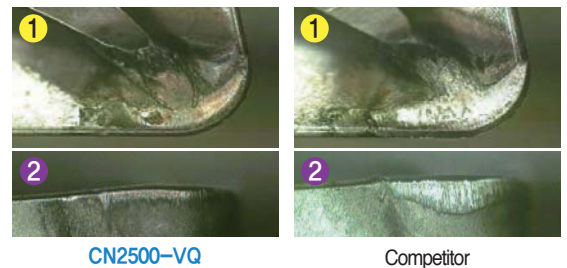

Surface roughness comparison

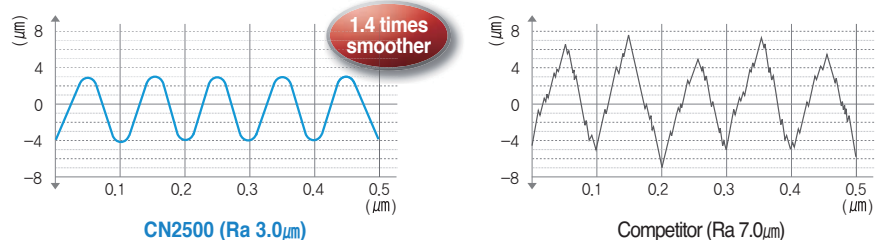

Features of Chip Breaker

VH/VT Chip Breaker [For heavy duty machining]

- Heavy duty chip breaker suitable for Heavy machining in the ship building and power plant industries
- Suitable for large vertical machines when machining shafts, rollers, rotors and optimal for the big flange machining

Features of VH chip breaker

For good chip control in heavy machining (comprehensive type)

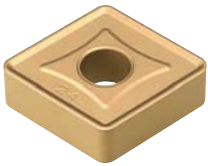

- Designed from the study of heavy cutting mechanism
- Smooth chip control from the high rake angle
- Wider cutting edge land provides stronger cutting
- Unique cutting edge treatment provides smooth cutting
- Optimized chip pocket design provides smooth chip flow

Features of VT chip breaker

For long tool life and stable cutting (higher feeds, big depth) in heavy machining

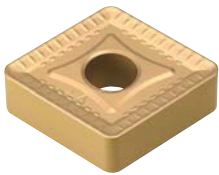

- Designed from the study of heavy cutting mechanism
- Strong edge design provides long and stable cutting (2 step rake angle of cutting edge)
- Varied cutting edge land strengthens the cutting edge
- The positioning of the chip breaking convex dot deflect the machining heat, optimizes inserts wear & absorb shock

Applications range of Chip breakers

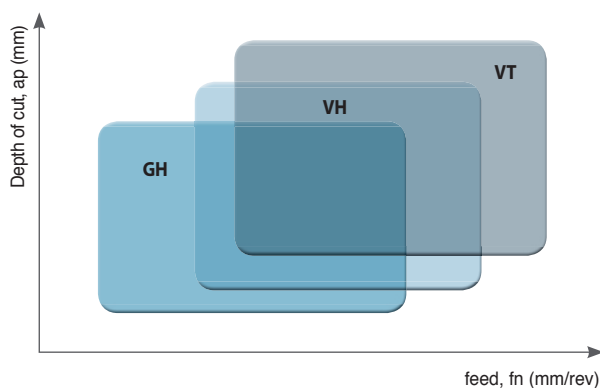

GH : $ap(\text{mm}) = 5.0\sim 12.0$, $fn(\text{mm/rev}) = 0.55\sim 1.20$

VH : $ap(\text{mm}) = 6.0\sim 15.0$, $fn(\text{mm/rev}) = 0.70\sim 1.40$

VT : $ap(\text{mm}) = 7.0\sim 17.0$, $fn(\text{mm/rev}) = 0.75\sim 1.60$

B Turning Chip Breakers

Features of Chip Breaker

LW/VW Chip Breaker [For high feed cutting]

- Improved productivity with higher feed rates and surface finishes
- Improved wear resistance and toughness

Features of LW chip breaker

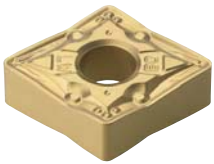

[For medium cutting]

- **Curvilinear cutting edge** - Reduces cutting force
- **Cutting edge design able to handle deeper depth of cuts** - lower cutting load & reduces heat
- **Greater chip control at shallow depths of cuts** - Chip pocket design improves smooth chip flow
- **For shallow depth cutting and low speed machining** - 3D design at the corner

Features of VW chip breaker

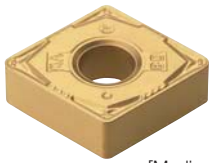

[Medium to finishing]

- **Excellent Finishing applications** - Excellent chip control
- **Insert design great for stable clamping** - Chip breaker designed close to the cutting edge
- **Similar cutting edge to C/B for medium** - strong cutting edge
- **3 Dimensional dot design on cutting corner** - reduces cutting force and good chip control at shallow depth of cut

Applications range of Chip breakers

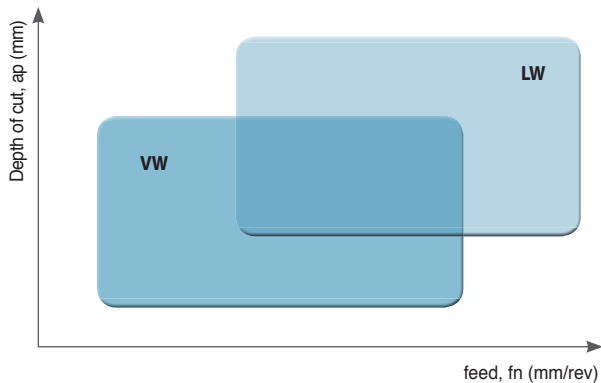

Wiper Insert

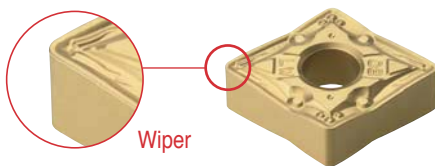

Wiper

- High productivity
- Improved surface roughness
- High feed-reducing machining time
- Improved tool life due to reduce cutting force

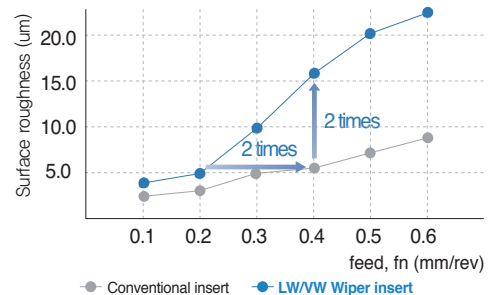

Features of Chip Breaker

SR/SH Chip Breaker new [For machining a shaft]

- Specialized for machining slender bars and thin walls
- High rake helix angle to reduce cutting resistance
- For machining steel and stainless steel

➤ The features of chip breaker, SR

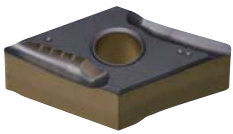

[For finishing]

- The first recommended chip breaker for machining a shaft
- For continuous finishing
- Improved chip and heat evacuation due to high rake cutting edge and 3-dimensional shape
- Good surface finish
- Preventing fracture due to chamfering on the cutting edge

➤ The features of chip breaker, SH



[For medium cutting]

- Specialized for interrupted and medium cutting
- Efficient heat evacuation due to concave shaped back side of insert

Surface finish evaluation



Chip breaker SR

Improved surface finish



Other chip breakers

Applications range of Chip breakers

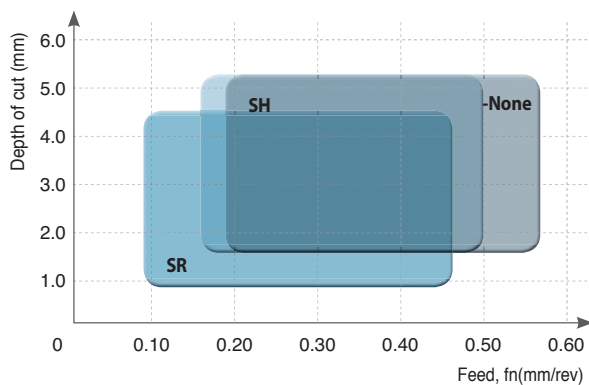

Machining	C/B	ap(mm)	fn(mm/rev)
Medium to rough cutting	-None	1.5 ~ 5.0	0.20 ~ 0.55
Medium cutting	SH	1.5 ~ 5.0	0.15 ~ 0.50
Finish cutting	SR	1.0 ~ 4.5	0.12 ~ 0.45

B Turning Insert Code System (ISO)



1 Insert Shape

C N M G 12 04 08 - MP

C D E K L
R S T V W

2 Relief Angle

C N M G 12 04 08 - MP

B C D E
F N P O

3 Tolerance

C N M G 12 04 08 - MP

d : Inscribed circle
t : Thickness
m : Refer to figure

Code	d (mm)	m (mm)	t (mm)
A	±0.025	±0.005	±0.025
C	±0.025	±0.013	±0.025
H	±0.013	±0.013	±0.025
E	±0.025	±0.025	±0.025
G	±0.025	±0.025	±0.13
J*	±0.05 ~ ±0.15	±0.005	±0.025
K*	±0.05 ~ ±0.15	±0.013	±0.025
L*	±0.05 ~ ±0.15	±0.025	±0.025
M*	±0.05 ~ ±0.15	±0.08 ~ ±0.20	±0.13
N*	±0.05 ~ ±0.15	±0.08 ~ ±0.18	±0.025
U*	±0.08 ~ ±0.25	±0.13 ~ ±0.38	±0.13

* Sides are based on unground insert

Tolerance on C, H, R, T, W Insert Shape (Exceptional case)

d	Tolerance on d		Tolerance on m	
	J, K, L, M, N	U	M, N	U
6.35	±0.05	±0.08	±0.08	±0.13
9.525	±0.05	±0.08	±0.08	±0.13
12.7	±0.08	±0.13	±0.13	±0.20
15.875	±0.10	±0.18	±0.15	±0.27
19.05	±0.10	±0.18	±0.15	±0.27
25.4	±0.13	±0.25	±0.18	±0.38

Tolerance on D Insert Shape (Exceptional case)

d	Tolerance on d		Tolerance on m	
6.35	±0.05		±0.11	
9.525	±0.05		±0.11	
12.7	±0.08		±0.15	
15.875	±0.10		±0.18	
19.05	±0.10		±0.18	

4 Cross Section Type

C N M G 12 04 08 - MP

A B C
F G H
J M N
Q R T
U W X



04

08

-

MP

6

7

8

Height of Cutting Edge

Nose "r"

Chip Breaker for Turning

5 Cutting Edge Length, Diameter of Incribed Circle
C N M G 12 04 08 - MP

Symbol							Inch	IC d(mm)
C	d	S	T	R	V	W		
03	04	03	06	03	-	02	1.2(5)	3.97
04	05	04	08	04	08	S3	1.5(6)	4.76
05	06	05	09	05	09	03	1.8(7)	5.56
-	-	-	-	06	-	-	-	6.00
06	07	06	11	06	11	04	2	6.35
08	09	07	13	07	13	05	2.5	7.94
-	-	-	-	08	-	-	-	8.00
09	11	09	16	09	16	06	3	9.525
-	-	-	-	10	-	-	-	10.00
11	13	11	19	11	19	07	3.5	11.11
-	-	-	-	12	-	-	-	12.00
12	15	12	22	12	22	08	4	12.70
14	17	14	24	14	24	09	4.5	14.29
16	19	15	27	15	27	10	5	15.875
-	-	-	-	16	-	-	-	16.00
17	21	17	30	17	30	11	5.5	17.46
19	23	19	33	19	33	13	6	19.05
-	-	-	-	20	-	-	-	20.00
22	27	22	38	22	38	15	7	22.225
-	-	-	-	25	-	-	-	25.00
25	31	25	44	25	44	17	8	25.40
32	38	31	54	31	54	21	10	31.75
-	-	-	-	32	-	-	-	32.00

() Symbol for small size insert

7 Nose "r"
C N M G 12 04 08 - MP



Symbol		Nose "r"	
Metric	Inch	Metric	Inch
003	0.1	0.1	0.004
005	0.13	0.2	0.008
01	0.2	0.4	1/64
02	0.5	0.8	1/32
04	1	1.2	3/64
08	2	1.6	1/16
12	3	2.0	5/64
16	4	2.4	3/32
20	5	2.8	7/64
24	6	3.2	1/8
28	7	Round insert (Inch)	
32	8	Round insert (Metric)	
00	-		
M0	-		

6 Height of Cutting Edge
C N M G 12 04 08 - MP

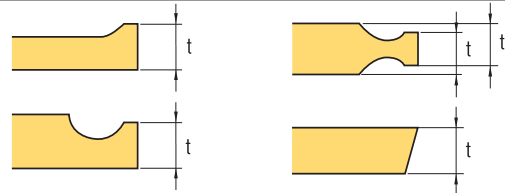

Symbol		Height of Cutting Edge (t)	
mm	Inch	mm	Inch
01	1(2)	1.59	1/16
T0	1.125	1.79	9/128
T1	1.2	1.98	5/64
02	1.5(3)	2.38	3/32
T2	1.75	2.78	7/64
03	2	3.18	1/8
T3	2.5	3.97	5/32
04	3	4.76	3/16
05	3.5	5.56	7/32
06	4	6.35	1/4
07	5	7.94	5/16
09	6	9.52	3/8
11	7	11.11	7/16
12	8	12.70	1/2

() Symbol for small size insert

8 Chip Breaker for Turning
C N M G 12 04 08 - MP

Negative Insert Chip Breaker

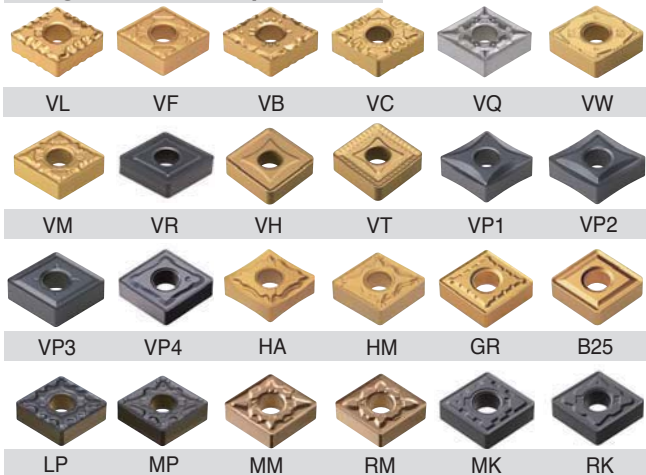

Positive Insert Chip Breaker

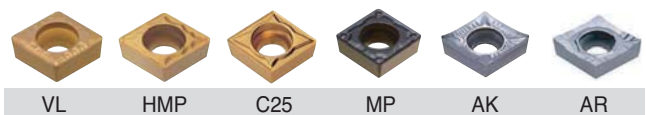

B Turning Insert (Negative)

CN○○○

 Rhombic **80° Negative**

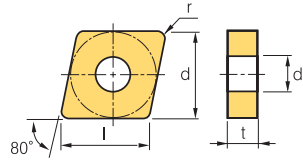

Dimensions (mm)			
Size	d	t	d ₁
09	9.525	3.18	3.81
12	12.7	4.76	5.16
16	15.875	6.35	6.35
19	19.05	6.35	7.93

Workpiece	Material		Machining types															
	Symbol	Color	1	2	3	4	5	6	7	8	9	10	11	12	13	14	15	16
Steel		Blue	●	●	●	●	●	●	●	●	●	●	●	●	●	●	●	●
Stainless steel		Yellow	●	●	●	●	●	●	●	●	●	●	●	●	●	●	●	●
Cast iron		Red	●	●	●	●	●	●	●	●	●	●	●	●	●	●	●	●
Non-ferrous metal		Green	●	●	●	●	●	●	●	●	●	●	●	●	●	●	●	●
Heat resistant alloy, Titanium alloy		Orange	●	●	●	●	●	●	●	●	●	●	●	●	●	●	●	●
Hardened steel		Grey	●	●	●	●	●	●	●	●	●	●	●	●	●	●	●	●

● Continuous cutting
● General cutting
● Interrupted cutting

	Inserts	Designation	Cermets		Coated		Coated										Uncoated		Cutting Condition											
			CN1500	CN2000	CN2500	CC1500	CC2500	NC3215	NC3120	NC3225	NC3030	NC5330	NC6310	NC6315	NC9115	NC9125	NC9135	PC5300	PC5400	PC8105	PC8110	PC8115	PC9030	H01	H05	f _n (mm/rev)	a _p (mm)			
Finishing		CNGG	120402-VP1																							0.01-0.10	0.10-1.00			
			120404-VP1																									0.05-0.15	0.10-1.50	
			120408-VP1																										0.07-0.20	0.10-1.50
Medium cutting		CNGG	120404-VP3																	●	●	●				●	0.05-0.30	0.10-3.00		
			120408-VP3																		●	●	●				●	0.10-0.40	0.50-4.50	
			120412-VP3																			●	●	●				●	0.12-0.50	0.50-5.00
Roughing		CNMA	090308																								0.10-0.30	0.50-3.00		
			120404																								●	0.15-0.60	1.00-5.00	
			120408																								●	0.15-0.60	1.00-6.00	
			120412																										0.15-0.70	1.50-6.00
			120416																										0.20-0.80	2.00-6.00
			160608																										0.15-0.70	2.00-6.00
			160612																										0.15-0.70	2.00-6.00
			160616																										0.15-0.70	2.00-6.00
			190608																										0.15-0.70	2.00-10.00
			190612																											0.15-0.70
190616																											0.20-1.00	3.00-10.00		
Finishing		CNMG	120404-VB	●	●	●	●	●	●	●	●	●	●	●	●	●	●	●	●	●	●	●	●	●	●	●	0.15-0.35	0.30-2.00		
			120408-VB	●	●	●	●	●	●	●	●	●	●	●	●	●	●	●	●	●	●	●	●	●	●	●	●	0.15-0.45	0.50-2.00	
			120412-VB																										0.20-0.50	0.50-2.00
Finishing		CNMG	090304-VF							●	●																0.07-0.30	0.50-1.50		
			090308-VF																									0.10-0.30	0.50-1.50	
			120404-VF									●		●														0.07-0.30	0.50-1.50	
			120408-VF											●														0.10-0.40	0.50-1.50	
			120412-VF																										0.10-0.50	0.60-1.50
Finishing		CNMG	120404-VP1																							●	0.05-0.15	0.10-1.50		
			120408-VP1																								●	0.07-0.20	0.10-1.50	

Cutting edge geometry A52~A61 Recommended chip breaker B04~B11 Code system B26~B27 ● : Stock item

Available tool holders			
Designation	Page	Designation	Page
MCKNR/L	B171	MCRNR/L	B172
MCLNR/L	B171	PCBNR/L	B159
MCMNN	B171	PCLNR/L	B160



CN○○○

Rhombic 80° Negative

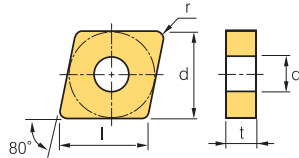

Dimensions (mm)			
Size	d	t	d ₁
09	9.525	3.18	3.81
12	12.7	4.76	5.16

Workpiece	Steel	P																	Machining types
	Stainless steel	M																	
Cast iron	K																	● Continuous cutting ● General cutting ✱ Interrupted cutting	
Non-ferrous metal	N																		
Heat resistant alloy, Titanium alloy	S																		
Hardened steel	H																		

	Inserts	Designation	Cermet		Coated		Coated										Uncoated		Cutting Condition									
			CN1500	CN2000	CN2500	CC1500	CC2500	NC3215	NC3120	NC3225	NC3030	NC5330	NC6310	NC6315	NC9115	NC9125	NC9135	PC5300	PC5400	PC8105	PC8110	PC8115	PC9030	H01	H05	f _n (mm/rev)	a _p (mm)	
Finishing	 [Mild steel]	CNMG 120404-VL	●	●																						0.05~0.25	0.10~1.00	
		CNMG 120408-VL	●	●			●	●																			0.10~0.35	0.20~1.50
		CNMG 120412-VL					●																				0.10~0.35	0.20~1.50
Finishing	 [wiper]	CNMG 120404-VW																								0.10~0.30	0.50~3.00	
		CNMG 120408-VW					●																			0.15~0.50	0.50~4.00	
		CNMG 120412-VW																								0.20~0.55	1.00~4.50	
Medium to finishing		CNMG 120404-HA																				●	●		0.05~0.20	0.80~3.50		
		CNMG 120408-HA																				●	●	●		0.10~0.40	0.80~3.50	
		CNMG 120412-HA																					●			0.13~0.55	0.80~3.50	
Medium to finishing	 <small>new</small>	CNMG 090304-LP																								0.07~0.30	0.30~1.50	
		CNMG 090308-LP						●	●																	0.10~0.30	0.30~1.50	
		CNMG 120404-LP									●															0.10~0.35	0.30~2.00	
		CNMG 120408-LP						●	●	●																0.10~0.40	0.50~2.50	
		CNMG 120412-LP						●	●	●																0.13~0.45	0.80~3.00	
Medium to finishing		CNMG 120404-VC					●	●	●																	0.10~0.35	0.30~2.00	
		CNMG 120408-VC					●	●	●																	0.15~0.40	0.50~3.00	
		CNMG 120412-VC					●	●	●																	0.15~0.45	0.50~3.00	

Cutting edge geometry **A52~A61**
 Recommended chip breaker **B04~B11**
 Code system **B26~B27**
● : Stock item

Available tool holders			
Designation	Page	Designation	Page
MCKNR/L	B171	MCRNR/L	B172
MCLNR/L	B171	PCBNR/L	B159
MCMNN	B171	PCLNR/L	B160



B Turning Insert (Negative)

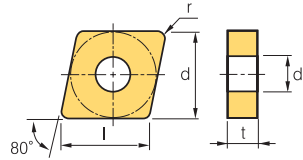

CN○○○

 Rhombic **80° Negative**

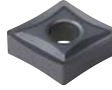
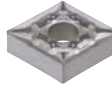

Dimensions (mm)			
Size	d	t	d ₁
09	9.525	3.18	3.81
12	12.7	4.76	5.16
16	15.875	6.35	6.35
19	19.05	6.35	7.93

Workpiece	Material													Machining types				
	Steel	Stainless steel	Cast iron	Non-ferrous metal	Heat resistant alloy, Titanium alloy	Hardened steel	P	M	K	N	S	H	●	●	●	●	●	●
Steel	●	●	●	●	●	●	●	●	●	●	●	●	●	●	●	●	●	●
Stainless steel	●	●	●	●	●	●	●	●	●	●	●	●	●	●	●	●	●	●
Cast iron	●	●	●	●	●	●	●	●	●	●	●	●	●	●	●	●	●	●
Non-ferrous metal	●	●	●	●	●	●	●	●	●	●	●	●	●	●	●	●	●	●
Heat resistant alloy, Titanium alloy	●	●	●	●	●	●	●	●	●	●	●	●	●	●	●	●	●	●
Hardened steel	●	●	●	●	●	●	●	●	●	●	●	●	●	●	●	●	●	●

Inserts	Designation	Cermet		Coated		Coated										Uncoated		Cutting Condition										
		CN1500	CN2000	CN2500	CC1500	CC2500	NC3215	NC3120	NC3225	NC3030	NC5330	NC6310	NC6315	NC9115	NC9125	NC9135	PC5300	PC5400	PC8105	PC8110	PC8115	PC9030	H01	H05	f _n (mm/rev)	a _p (mm)		
Medium to finishing 	CNMG 120404-VP2							●									●	●	●	●	●				0.05-0.30	0.10-3.00		
	120408-VP2																	●	●	●	●	●				0.10-0.40	0.50-4.50	
	160618-VP2																									0.12-0.45	0.80-5.00	
	190608-VP2																									0.12-0.50	1.00-5.20	
	190612-VP2																										0.15-0.50	1.20-5.50
	190616-VP2																										0.18-0.50	1.50-5.50
Medium to finishing  [Cermet]	CNMG 090304-VQ																									0.05-0.30	0.50-3.50	
	090308-VQ																										0.08-0.30	0.80-4.00
	090408-VQ										●																0.05-0.30	0.50-3.50
	090412-VQ										●																0.08-0.30	0.80-4.00
	120404-VQ	●	●	●	●	●																					0.05-0.30	0.80-4.00
	120408-VQ	●	●	●	●	●																					0.08-0.40	0.80-4.00
	120412-VQ																										0.10-0.40	0.80-4.00
Medium cutting 	CNMG 090304-HM										●															0.12-0.40	0.50-3.80	
	120404-HM							●	●	●												●				0.05-0.30	0.90-5.00	
	120408-HM							●	●	●						●						●				0.10-0.50	1.00-5.00	
	120412-HM							●															●				0.18-0.50	1.00-5.00
	190612-HM																										0.13-0.60	1.30-7.00
Medium cutting 	CNMG 120404-MK																									0.05-0.30	0.90-4.00	
	120408-MK																										0.10-0.50	1.00-5.00
	120412-MK																										0.13-0.60	1.30-5.00
	120416-MK																										0.15-0.60	1.30-5.00
	160608-MK																										0.28-0.70	1.80-7.00
	160612-MK																										0.28-0.72	2.00-8.00
	160616-MK																										0.28-0.74	2.00-8.00
	190608-MK																										0.33-0.78	2.50-9.00
	190612-MK																										0.35-0.78	2.60-9.50
190616-MK																										0.35-0.80	2.60-10.00	

 Cutting edge geometry A52~A61
  Recommended chip breaker B04~B11
  Code system B26~B27
 ● : Stock item

Available tool holders			
Designation	Page	Designation	Page
MCKNR/L	B171	MCRNR/L	B172
MCLNR/L	B171	PCBNR/L	B159
MCMNN	B171	PCLNR/L	B160



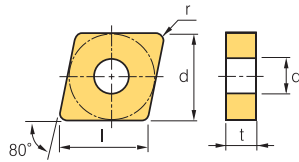

CN○○○

Rhombic 80° Negative



Dimensions (mm)			
Size	d	t	d ₁
09	9.525	3.18	3.81
12	12.7	4.76	5.16
16	15.875	6.35	6.35
19	19.05	6.35	7.93

Workpiece	Steel	P																	Machining types
	Stainless steel	M																	
Cast iron	K																	● Continuous cutting ● General cutting ✦ Interrupted cutting	
Non-ferrous metal	N																		
Heat resistant alloy, Titanium alloy	S																		
Hardened steel	H																		

Inserts	Designation	Cermet		Coated		Coated										Uncoated		Cutting Condition									
		CN1500	CN2000	CN2500	CC1500	CC2500	NC3215	NC3120	NC3225	NC3030	NC5330	NC6310	NC6315	NC9115	NC9125	NC9135	PC5300	PC5400	PC8105	PC8110	PC8115	PC9030	H01	H05	f _n (mm/rev)	a _p (mm)	
Medium cutting 	CNMG 090304-MM																									0.08~0.35	0.50~5.00
	CNMG 090308-MM													●	●								●			0.10~0.40	0.50~5.00
	CNMG 090312-MM																									0.12~0.45	0.50~5.00
	CNMG 090404-MM																									0.08~0.35	0.50~5.00
	CNMG 090408-MM																									0.10~0.40	0.50~5.00
	CNMG 090412-MM																									0.12~0.45	0.50~5.00
	CNMG 120404-MM														●	●	●					●	●	●		0.10~0.40	0.50~5.50
	CNMG 120408-MM														●	●	●	●				●	●	●		0.12~0.45	0.50~5.50
	CNMG 120412-MM														●	●	●	●				●	●	●		0.15~0.60	0.50~5.50
	CNMG 120416-MM															●	●	●					●			0.20~0.65	0.50~5.50
	CNMG 160608-MM															●	●	●					●			0.12~0.45	0.50~7.00
	CNMG 160612-MM															●	●	●					●	●		0.15~0.60	0.50~7.00
	CNMG 160616-MM															●	●	●					●	●		0.18~0.65	0.50~7.00
	CNMG 190608-MM															●	●	●					●			0.12~0.45	0.50~8.50
CNMG 190612-MM															●	●	●					●	●		0.15~0.60	0.50~8.50	
CNMG 190616-MM															●	●	●					●	●		0.18~0.65	0.50~8.50	
Medium cutting 	CNMG 090304-MP					●	●	●	●				●												0.10~0.40	0.40~3.80	
	CNMG 090308-MP					●	●	●	●				●												0.15~0.40	0.50~4.00	
	CNMG 090312-MP																								0.15~0.50	0.80~4.20	
	CNMG 090404-MP																								0.10~0.40	0.40~3.80	
	CNMG 090408-MP																								0.15~0.40	0.50~4.00	
	CNMG 090412-MP																								0.15~0.50	0.80~4.20	
	CNMG 120404-MP						●	●	●	●				●	●	●				●	●	●			0.10~0.40	0.40~4.00	
	CNMG 120408-MP						●	●	●	●				●	●	●				●	●	●			0.15~0.45	0.50~4.50	
	CNMG 120412-MP						●	●	●	●				●	●	●				●	●				0.15~0.50	0.80~5.00	
	CNMG 120416-MP						●	●	●	●				●	●	●					●				0.28~0.55	1.00~5.00	
	CNMG 160608-MP						●	●	●	●				●	●	●									0.15~0.50	0.50~7.00	
	CNMG 160612-MP						●	●	●	●				●	●	●									0.18~0.60	0.80~7.00	
	CNMG 160616-MP						●	●	●	●															0.15~0.60	1.00~7.00	
	CNMG 190608-MP							●																	0.15~0.60	0.50~8.50	
CNMG 190612-MP							●																	0.10~0.40	0.40~3.80		
CNMG 190616-MP														●	●	●								0.15~0.40	0.50~4.00		

🔄 Cutting edge geometry A52~A61
🔄 Recommended chip breaker B04~B11
🔄 Code system B26~B27
● : Stock item

Available tool holders			
Designation	Page	Designation	Page
MCKNR/L	B171	MCRNR/L	B172
MCLNR/L	B171	PCBNR/L	B159
MCMNN	B171	PCLNR/L	B160



B Turning Insert (Negative)



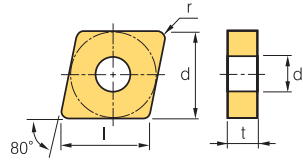

CN○○○

 Rhombic **80° Negative**

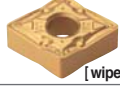

Dimensions (mm)			
Size	d	t	d ₁
09	9.525	3.18	3.81
12	12.7	4.76	5.16
16	15.875	6.35	6.35
19	19.05	6.35	7.93
25	25.4	9.52	9.12

Workpiece	Material Compatibility												Machining types			
	Steel	Stainless steel	Cast iron	Non-ferrous metal	Heat resistant alloy, Titanium alloy	Hardened steel	P	M	K	N	S	H	●	●	●	●
Steel	●	●	●	●	●	●	●	●	●	●	●	●	●	●	●	●
Stainless steel	●	●	●	●	●	●	●	●	●	●	●	●	●	●	●	●
Cast iron	●	●	●	●	●	●	●	●	●	●	●	●	●	●	●	●
Non-ferrous metal	●	●	●	●	●	●	●	●	●	●	●	●	●	●	●	●
Heat resistant alloy, Titanium alloy	●	●	●	●	●	●	●	●	●	●	●	●	●	●	●	●
Hardened steel	●	●	●	●	●	●	●	●	●	●	●	●	●	●	●	●

Inserts	Designation	Cermets		Coated		Coated										Uncoated		Cutting Condition											
		CN1500	CN2000	CN2500	CC1500	CC2500	NC3215	NC3120	NC3225	NC3030	NC5330	NC6310	NC6315	NC9115	NC9125	NC9135	PC5300	PC5400	PC8105	PC8110	PC8115	PC9030	H01	H05	f _n (mm/rev)	a _p (mm)			
Medium cutting 	CNMG 090304-VM																									0.05~0.30	0.90~3.50		
	CNMG 090308-VM						●		●																		0.10~0.45	1.00~3.50	
	CNMG 120404-VM	●	●	●			●	●	●	●						●	●					●					0.05~0.30	0.90~5.00	
	CNMG 120408-VM	●	●	●			●	●	●	●						●	●			●		●					0.10~0.50	1.00~5.00	
	CNMG 120412-VM						●		●	●						●	●			●							0.13~0.60	1.30~5.00	
	CNMG 120416-VM									●																		0.20~0.60	1.50~5.50
	CNMG 160608-VM									●																		0.10~0.50	1.00~6.70
	CNMG 160612-VM																											0.13~0.60	1.30~6.70
	CNMG 190608-VM									●																		0.13~0.65	1.30~7.00
	CNMG 190612-VM										●																	0.15~0.70	1.50~7.00
CNMG 190616-VM																											0.18~0.75	1.80~7.00	
Medium cutting 	CNMG 120404-VP3																●	●	●	●	●			●	●	0.05~0.30	0.10~3.00		
	CNMG 120408-VP3																●	●	●	●	●			●	●	0.10~0.40	0.50~4.50		
	CNMG 120412-VP3																●	●	●	●	●			●	●	0.12~0.50	0.50~5.00		
	CNMG 120416-VP3																										0.25~0.45	1.00~4.00	
	CNMG 160608-VP3																										0.15~0.35	0.80~6.00	
	CNMG 160612-VP3																										0.20~0.40	1.00~6.00	
	CNMG 160616-VP3																										0.20~0.40	1.00~6.00	
	CNMG 190608-VP3																										0.20~0.50	1.00~7.00	
	CNMG 190612-VP3																											0.25~0.55	1.00~8.00
	CNMG 190616-VP3																											0.30~0.60	1.00~8.00
Medium cutting 	CNMG 120408-LW						●	●	●						●												0.15~0.60	1.00~5.00	
	CNMG 120412-LW						●	●							●													0.20~0.70	1.00~6.00
General 	CNMG 120404-B25	●	●	●			●	●	●	●						●											0.17~0.45	1.00~5.00	
	CNMG 120408-B25	●	●	●			●	●	●	●						●	●			●		●					0.23~0.60	1.50~5.00	
	CNMG 120412-B25			●			●	●	●	●																		0.25~0.60	2.00~5.00
	CNMG 160608-B25						●	●	●	●																		0.25~0.60	2.00~6.50
	CNMG 160612-B25						●	●	●	●																		0.27~0.60	2.00~6.50
	CNMG 160616-B25						●	●	●	●																		0.27~0.60	2.00~6.50
	CNMG 190604-B25									●	●																	0.20~0.45	3.00~8.00
	CNMG 190608-B25						●	●	●	●	●																	0.25~0.60	3.00~8.00
	CNMG 190612-B25						●	●	●	●	●						●	●			●							0.30~0.60	3.00~8.00
	CNMG 190616-B25						●	●																				0.23~0.70	3.00~8.00

 Cutting edge geometry A52~A61
  Recommended chip breaker B04~B11
  Code system B26~B27
 ● : Stock item

Available tool holders			
Designation	Page	Designation	Page
MCKNR/L	B171	MCRNR/L	B172
MCLNR/L	B171	PCBNR/L	B159
MCMNN	B171	PCLNR/L	B160



CN○○○

Rhombic **80° Negative**

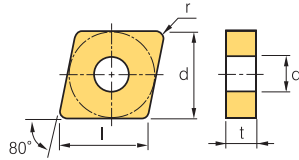

Dimensions (mm)			
Size	d	t	d ₁
12	12.7	4.76	5.16
16	15.875	6.35	6.35
19	19.05	6.35	7.93
25	25.4	9.52	9.12

Workpiece	Material Groups														Machining types			
	Steel	P	●	●	●	●	●	●	●	●	●	●	●	●	●	●	●	●
Stainless steel	M	●	●	●	●	●	●	●	●	●	●	●	●	●	●	●	●	●
Cast iron	K	●	●	●	●	●	●	●	●	●	●	●	●	●	●	●	●	●
Non-ferrous metal	N	●	●	●	●	●	●	●	●	●	●	●	●	●	●	●	●	●
Heat resistant alloy, Titanium alloy	S	●	●	●	●	●	●	●	●	●	●	●	●	●	●	●	●	●
Hardened steel	H	●	●	●	●	●	●	●	●	●	●	●	●	●	●	●	●	●

● Continuous cutting
 ● General cutting
 ● Interrupted cutting

Inserts	Designation	Cermet		Coated		Coated										Uncoated		Cutting Condition									
		CN1500	CN2000	CN2500	CC1500	CC2500	NC3215	NC3120	NC3225	NC3030	NC5330	NC6310	NC6315	NC9115	NC9125	NC9135	PC5300	PC5400	PC8105	PC8110	PC8115	PC9030	H01	H05	f _n (mm/rev)	a _p (mm)	
Roughing 	CNMG 120408-GR					●	●	●	●	●															0.20~0.50	1.00~7.00	
	120412-GR						●	●	●	●																0.25~0.50	1.30~7.00
	120416-GR																									0.25~0.60	1.80~6.00
	160608-GR									●																0.20~0.70	1.00~8.00
	160612-GR							●	●	●	●															0.25~0.70	1.30~8.00
	160616-GR									●																0.25~0.75	1.80~8.00
	190608-GR							●		●	●															0.20~0.70	1.70~10.00
	190612-GR							●	●	●	●	●														0.30~0.75	1.70~10.00
	190616-GR								●	●	●	●														0.30~0.80	1.80~10.00
	190624-GR																									0.35~0.85	2.00~12.00
	250724-GR																									0.40~1.00	2.30~15.00
250924-GR								●		●	●														0.40~1.00	2.30~15.00	
Roughing 	CNMG 120404-RK																									0.20~0.47	1.30~6.00
	120408-RK											●	●													0.20~0.50	1.50~6.00
	120412-RK											●	●													0.28~0.53	1.80~6.00
	120416-RK												●													0.28~0.63	2.00~6.00
	160608-RK												●													0.28~0.70	1.80~7.00
	160612-RK												●													0.28~0.72	2.00~8.00
	160616-RK												●	●												0.28~0.74	2.00~8.00
	190612-RK													●												0.35~0.78	2.60~9.50
	190616-RK													●												0.35~0.80	2.60~10.00
Roughing 	CNMG 120404-RM													●	●	●					●	●				0.10~0.50	2.00~6.00
	120408-RM													●	●	●	●					●	●	●		0.15~0.55	2.00~6.00
	120412-RM													●	●	●	●					●	●	●		0.20~0.60	2.00~6.00
	120416-RM														●	●	●					●				0.25~0.70	2.00~6.00
	160608-RM														●	●	●					●				0.15~0.55	2.00~8.00
	160612-RM														●	●	●					●				0.20~0.60	2.00~8.00
	160616-RM														●	●	●					●				0.25~0.70	2.00~8.00
	190608-RM														●	●	●					●				0.15~0.55	2.00~10.00
	190612-RM														●	●	●					●				0.20~0.60	2.00~10.00
	190616-RM														●	●	●					●				0.25~0.70	2.00~10.00
	250924-RM																									0.40~1.20	4.00~14.00

Cutting edge geometry **A52~A61**
 Recommended chip breaker **B04~B11**
 Code system **B26~B27**
 ● : Stock item

Available tool holders			
Designation	Page	Designation	Page
MCKNR/L	B171	MCRNR/L	B172
MCLNR/L	B171	PCBNR/L	B159
MCMNN	B171	PCLNR/L	B160



B Turning Insert (Negative)

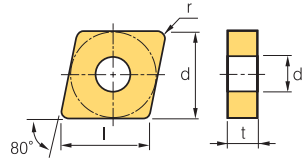

CN○○○

 Rhombic **80° Negative**

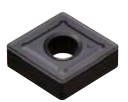

Dimensions (mm)			
Size	d	t	d ₁
12	12.7	4.76	5.16
16	15.875	4.76~6.35	6.35
19	19.05	6.35	7.93

Workpiece	Machining types															
	P	M	K	N	S	H										
Steel	●	●	●	●	●	●	●	●	●	●	●	●	●	●	●	●
Stainless steel	●	●	●	●	●	●	●	●	●	●	●	●	●	●	●	●
Cast iron	●	●	●	●	●	●	●	●	●	●	●	●	●	●	●	●
Non-ferrous metal	●	●	●	●	●	●	●	●	●	●	●	●	●	●	●	●
Heat resistant alloy, Titanium alloy	●	●	●	●	●	●	●	●	●	●	●	●	●	●	●	●
Hardened steel	●	●	●	●	●	●	●	●	●	●	●	●	●	●	●	●

Inserts	Designation	Cermets		Coated		Coated										Uncoated		Cutting Condition										
		CN1500	CN2000	CN2500	CC1500	CC2500	NC3215	NC3120	NC3225	NC3030	NC5330	NC6310	NC6315	NC9115	NC9125	NC9135	PC5300	PC5400	PC8105	PC8110	PC8115	PC9030	H01	H05	f _n (mm/rev)	a _p (mm)		
Roughing 	CNMG 120408-VP4																									0.15~0.35	1.00~4.00	
	120412-VP4																										0.20~0.40	1.00~4.00
	160608-VP4																										0.20~0.45	1.00~6.50
	160612-VP4																										0.25~0.50	1.50~6.50
	190608-VP4																										0.15~0.45	1.00~8.00
	190612-VP4																										0.20~0.50	1.20~8.50
Roughing 	CNMG 120404-VR																									0.20~0.50	1.00~6.50	
	120408-VR																										0.25~0.55	1.20~7.00
	120412-VR																										0.30~0.60	1.50~7.00
	120416-VR																										0.35~0.65	1.70~7.00
	120508-VR																										0.25~0.55	1.20~7.00
	120512-VR																										0.30~0.60	1.50~7.00
	160612-VR																										0.35~0.70	2.00~8.00
	160616-VR																										0.35~0.75	2.20~8.00
190612-VR							●	●																		0.35~0.70	2.00~10.00	
190616-VR							●	●																		0.35~0.75	2.20~10.00	
Medium to finishing 	CNMM 120408-HA																									0.10~0.40	0.80~3.50	
Roughing 	CNMM 120408-GR																									0.20~0.50	1.00~7.00	
	120412-GR																										0.25~0.50	1.30~7.00
	190612-GR								●																		0.30~0.75	1.70~10.00
	190616-GR																										0.30~0.80	1.80~10.00

 Cutting edge geometry **A52~A61**
 Recommended chip breaker **B04~B11**
 Code system **B26~B27**
● : Stock item

Available tool holders			
Designation	Page	Designation	Page
MCKNR/L	B171	MCRNR/L	B172
MCLNR/L	B171	PCBNR/L	B159
MCMNN	B171	PCLNR/L	B160



CN○○○

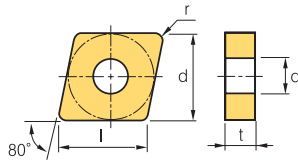

 Rhombic **80° Negative**



Dimensions (mm)			
Size	d	t	d ₁
12	12.7	4.76	5.16
16	15.875	4.76~6.35	6.35
19	19.05	6.35	7.93
25	25.4	7.94~9.52	9.12

Workpiece	Material												Machining types								
	Steel	Stainless steel	Cast iron	Non-ferrous metal	Heat resistant alloy, Titanium alloy	Hardened steel	P	M	K	N	S	H									
Steel							●	●	●	●	●	●	●	●	●	●	●	●			
Stainless steel		●					●	●	●	●	●	●	●	●	●	●	●	●	●	●	
Cast iron			●				●	●	●	●	●	●	●	●	●	●	●	●	●	●	
Non-ferrous metal				●															●	●	
Heat resistant alloy, Titanium alloy																			●	●	
Hardened steel																			●	●	

● Continuous cutting
 ● General cutting
 ✳ Interrupted cutting

Inserts	Designation	Cermet		Coated		Coated												Uncoated		Cutting Condition						
		CN1500	CN2000	CN2500	CC1500	CC2500	NC3215	NC3120	NC3225	NC3030	NC5330	NC6310	NC6315	NC9115	NC9125	NC9135	PC5300	PC5400	PC8105	PC8110	PC8115	PC9030	H01	H05	f _n (mm/rev)	a _p (mm)
Heavy 	CNMM 120408-GH							●	●	●															0.30~0.60	2.50~8.00
	120412-GH						●	●	●																0.30~0.70	2.50~8.00
	160412-GH																								0.30~0.70	2.50~8.00
	160424-GH																								0.30~1.20	2.50~8.00
	160612-GH									●															0.30~0.90	2.50~8.00
	160616-GH																								0.30~1.20	2.50~8.00
	160624-GH																								0.30~1.50	2.50~8.00
	190608-GH											●													0.30~0.60	2.50~8.00
	190612-GH							●	●		●	●													0.30~0.70	3.00~8.00
	190616-GH							●	●		●	●													0.45~0.90	3.00~8.00
	190624-GH							●	●			●													0.55~1.20	4.00~9.00
	250716-GH																								0.50~1.00	4.50~10.00
	250724-GH							●	●																0.55~1.20	5.00~12.00
	250924-GH							●	●		●	●													0.55~1.20	5.00~12.00
250950-GH																									0.65~1.30	6.00~12.00
Heavy  [General]	CNMM 190612-VH						●																	0.50~0.90	5.00~10.00	
	190616-VH						●																		0.50~1.10	5.00~10.00
	190624-VH						●																		0.60~1.20	6.00~12.00
	250724-VH						●																		0.70~1.40	6.00~15.00
	250924-VH						●																		0.70~1.40	6.00~15.00
Heavy  [High feed cutting]	CNMM 190612-VT						●			●	●													0.60~1.00	6.00~13.00	
	190616-VT						●																		0.60~1.10	5.00~10.00
	190624-VT						●																		0.60~1.60	7.00~13.00
	250724-VT						●																		0.75~16.0	7.00~17.00
	250924-VT						●																		0.75~16.0	7.00~17.00

🔄 Cutting edge geometry **A52~A61**

🔄 Recommended chip breaker **B04~B11**

🔄 Code system **B26~B27**

● : Stock item

Available tool holders			
Designation	Page	Designation	Page
MCKNR/L	B171	MCRNR/L	B172
MCLNR/L	B171	PCBNR/L	B159
MCMNN	B171	PCLNR/L	B160



B Turning Insert (Negative)



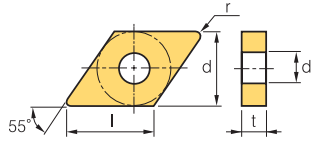

DN ○ ○

 Rhombic 55° Negative



Dimensions (mm)			
Size	d	t	d ₁
11	9.525	3.18~4.76	3.81
15	12.7	4.76~6.35	5.16

Workpiece	Machining types															
	P	M	K	N	S	H										
Steel	●	●	●	●	●	●	●	●	●	●	●	●	●	●	●	●
Stainless steel	●	●	●	●	●	●	●	●	●	●	●	●	●	●	●	●
Cast iron	●	●	●	●	●	●	●	●	●	●	●	●	●	●	●	●
Non-ferrous metal	●	●	●	●	●	●	●	●	●	●	●	●	●	●	●	●
Heat resistant alloy, Titanium alloy	●	●	●	●	●	●	●	●	●	●	●	●	●	●	●	●
Hardened steel	●	●	●	●	●	●	●	●	●	●	●	●	●	●	●	●

Inserts	Designation	Cermet		Coated		Coated										Uncoated		Cutting Condition											
		CN1500	CN2000	CN2500	CC1500	CC2500	NC3215	NC3120	NC3225	NC3030	NC5330	NC6310	NC6315	NC9115	NC9125	NC9135	PC5300	PC5400	PC8105	PC8110	PC8115	PC9030	H01	H05	f _n (mm/rev)	a _p (mm)			
Finishing 	DNMG	150404-VP1																								0.05~0.15	0.10~1.50		
		150408-VP1																									0.07~0.20	0.10~1.50	
		150604-VP1																									0.05~0.15	0.10~1.50	
		150608-VP1																									0.07~0.20	0.10~1.50	
Medium cutting 	DNMG	150404-VP3																	●	●	●			●		0.05~0.30	0.10~3.00		
		150408-VP3																		●	●	●			●		0.10~0.45	0.50~5.00	
		150412-VP3																			●	●	●			●		0.12~0.50	0.50~5.00
		150604-VP3																			●	●	●			●		0.05~0.30	0.10~3.00
		150608-VP3																			●	●	●			●		0.10~0.45	0.50~5.00
		150612-VP3																			●	●	●			●		0.12~0.50	0.50~5.00
Roughing 	DNMA	110408																								0.17~0.45	0.80~3.00		
		150404																									0.17~0.55	0.40~4.00	
		150408																									0.25~0.55	0.80~4.00	
		150412											●														0.25~0.65	0.50~4.00	
		150604																									0.17~0.55	0.40~4.00	
		150608												●													0.25~0.55	0.80~4.00	
		150612												●													0.25~0.65	1.20~4.00	
		190608																									0.30~0.80	2.50~13.00	
Finishing 	DNMG	110404-VB																								0.05~0.25	0.30~2.00		
		150404-VB	●	●	●	●	●	●	●	●	●	●	●	●	●	●	●	●	●	●	●	●	●	●	●	●	0.10~0.35	0.30~2.00	
		150408-VB	●	●	●	●	●	●	●	●	●	●	●	●	●	●	●	●	●	●	●	●	●	●	●	●	0.15~0.45	0.50~2.00	
		150412-VB																									0.15~0.45	0.50~2.00	
		150604-VB	●	●	●	●	●	●	●	●	●	●	●	●	●	●	●	●	●	●	●	●	●	●	●	●	0.10~0.35	0.30~2.00	
		150608-VB	●	●	●	●	●	●	●	●	●	●	●	●	●	●	●	●	●	●	●	●	●	●	●	●	0.15~0.45	0.50~2.00	
		150612-VB																									0.20~0.50	0.50~2.50	

 Cutting edge geometry A52~A61
  Recommended chip breaker B04~B11
  Code system B26~B27
 ● : Stock item

Available tool holders			
Designation	Page	Designation	Page
MCKNR/L	B171	MCRNR/L	B172
MCLNR/L	B171	PCBNR/L	B159
MCMNN	B171	PCLNR/L	B160



DN

Rhombic **55° Negative**

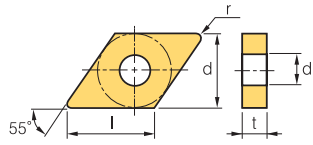

Dimensions (mm)			
Size	d	t	d ₁
11	9.525	3.18~4.76	3.81
15	12.7	4.76~6.35	5.16

Workpiece	Material Compatibility												Machining types					
	Steel	P	●	●	●	●	●	●	●	●	●	●	●	●	●	●	●	●
Stainless steel	M	●	●	●	●	●	●	●	●	●	●	●	●	●	●	●	●	●
Cast iron	K	●	●	●	●	●	●	●	●	●	●	●	●	●	●	●	●	●
Non-ferrous metal	N	●	●	●	●	●	●	●	●	●	●	●	●	●	●	●	●	●
Heat resistant alloy, Titanium alloy	S	●	●	●	●	●	●	●	●	●	●	●	●	●	●	●	●	●
Hardened steel	H	●	●	●	●	●	●	●	●	●	●	●	●	●	●	●	●	●

Inserts	Designation	Cermet		Coated		Coated											Uncoated		Cutting Condition									
		CN1500	CN2000	CN2500	CC1500	CC2500	NC3215	NC3120	NC3225	NC3030	NC5330	NC6310	NC6315	NC9115	NC9125	NC9135	PC5300	PC5400	PC8105	PC8110	PC8115	PC9030	H01	H05	f _n (mm/rev)	a _p (mm)		
Finishing 	DNMG 110402-VF																									0.05~0.20	0.20~1.00	
	110404-VF																										0.07~0.30	0.50~1.50
	110408-VF																										0.10~0.40	0.50~1.50
	150404-VF																										0.07~0.30	0.50~1.50
	150408-VF																										0.10~0.40	0.50~1.50
	150412-VF																										0.15~0.50	0.60~1.50
	150604-VF																										0.13~0.30	0.50~1.50
	150608-VF																										0.10~0.40	0.50~1.50
150612-VF																										0.15~0.50	0.60~1.50	
Finishing [Mild steel]	DNMG 110408-VL																									0.05~0.20	0.10~1.00	
	150404-VL																										0.05~0.25	0.10~1.50
	150408-VL																										0.05~0.30	0.20~1.50
	150412-VL																										0.10~0.30	0.25~1.50
	150604-VL																										0.05~0.25	0.10~1.50
	150608-VL																											0.05~0.30
150612-VL																											0.10~0.30	0.25~1.50
Finishing 	DNMG 150404-VP1																										0.05~0.15	0.10~1.50
	150408-VP1																										0.07~0.20	0.10~1.50
	150604-VP1																										0.05~0.15	0.10~1.50
	150608-VP1																										0.07~0.20	0.10~1.50
Finishing [wiper]	DNMG 150404-VW																										0.10~0.35	0.30~3.00
	150408-VW																										0.10~0.40	0.30~3.00
	150604-VW																										0.10~0.35	0.30~3.00
	150608-VW																										0.10~0.40	0.30~3.00
Medium to finishing 	DNMG 150404-HA																										0.05~0.30	0.80~3.50
	150408-HA																										0.10~0.40	0.80~3.50
	150604-HA																										0.05~0.30	0.80~3.50
	150608-HA																										0.10~0.40	0.80~3.50

Cutting edge geometry **A52~A61**
 Recommended chip breaker **B04~B11**
 Code system **B26~B27**
 ● : Stock item

Available tool holders			
Designation	Page	Designation	Page
MCKNR/L	B171	MCRNR/L	B172
MCLNR/L	B171	PCBNR/L	B159
MCMNN	B171	PCLNR/L	B160



B Turning Insert (Negative)

DN ○ ○

Rhombic **55° Negative**

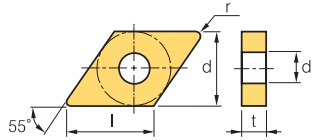

Dimensions (mm)			
Size	d	t	d ₁
11	9.525	4.76	3.81
15	12.7	4.76~6.35	5.16

Workpiece			Machining types																		
	Steel	▶ P	●	⊕	⊘	●	⊕	⊘	●	⊕	⊘	●	⊕	⊘	●	⊕	⊘	●	⊕	⊘	
Stainless steel	▶ M	●	⊕	⊘																	
Cast iron	▶ K	●	⊕	⊘																	
Non-ferrous metal	▶ N																				
Heat resistant alloy, Titanium alloy	▶ S																				
Hardened steel	▶ H																				

● Continuous cutting
 ⊕ General cutting
 ⊘ Interrupted cutting

Inserts	Designation	Cermet		Coated		Coated										Uncoated		Cutting Condition										
		CN1500	CN2000	CN2500	CC1500	CC2500	NC3215	NC3120	NC3225	NC3030	NC5330	NC6310	NC6315	NC9115	NC9125	NC9135	PC5300	PC5400	PC8105	PC8110	PC8115	PC9030	H01	H05	f _n (mm/rev)	a _p (mm)		
Medium to finishing LP <small>new</small>	DNMG 110402-LP																									0.06~0.30	0.25~1.20	
	110404-LP						●	●																		0.07~0.30	0.30~1.50	
	110408-LP																									0.10~0.40	0.30~1.50	
	110504-LP																									0.07~0.30	0.30~1.50	
	110508-LP																									0.10~0.40	0.30~1.50	
	150404-LP							●	●	●																0.10~0.35	0.30~2.00	
	150408-LP							●	●	●																0.10~0.40	0.50~2.50	
	150412-LP							●	●	●																	0.13~0.45	0.80~3.00
	150604-LP							●	●	●																	0.10~0.35	0.30~2.00
	150608-LP							●	●	●																	0.10~0.40	0.50~2.50
	150612-LP							●	●	●																	0.13~0.45	0.80~3.00
Medium to finishing VC	DNMG 150404-VC						●	●																		0.10~0.35	0.30~2.00	
	150408-VC						●	●	●																	0.15~0.40	0.50~3.00	
	150412-VC						●	●	●																	0.15~0.45	0.50~3.00	
	150604-VC						●	●	●																	0.10~0.35	0.30~2.00	
	150608-VC						●	●	●																	0.15~0.40	0.50~3.00	
150612-VC						●	●	●																	0.15~0.45	0.50~3.00		
Medium to finishing VP2	DNMG 150404-VP2															●	●	●	●	●	●		●		0.05~0.30	0.10~3.00		
	150408-VP2															●	●	●	●	●	●		●		0.10~0.40	0.50~4.50		
	150604-VP2															●	●	●	●	●	●		●		0.05~0.30	0.10~3.00		
	150608-VP2								●							●	●	●	●	●	●		●		0.10~0.40	0.50~4.50		
Medium to finishing VQ <small>[Cermet]</small>	DNMG 110404-VQ	●		●																						0.05~0.30	0.50~3.50	
	110408-VQ																									0.08~0.40	0.80~4.00	
	110412-VQ																									0.10~0.40	1.00~4.00	
	150404-VQ	●	●	●	●	●																				0.05~0.30	0.80~3.50	
	150408-VQ	●		●	●	●																				0.08~0.40	0.80~4.00	
	150412-VQ																									0.10~0.40	0.50~4.20	
	150604-VQ	●	●	●	●	●																				0.05~0.30	0.80~4.00	
	150608-VQ	●	●	●	●	●																				0.08~0.40	0.80~4.00	
150612-VQ																									0.10~0.40	0.50~4.20		

Cutting edge geometry **A52~A61**
 Recommended chip breaker **B04~B11**
 Code system **B26~B27**
● : Stock item

Available tool holders			
Designation	Page	Designation	Page
MCKNR/L	B171	MCRNR/L	B172
MCLNR/L	B171	PCBNR/L	B159
MCMNN	B171	PCLNR/L	B160



DN ○○

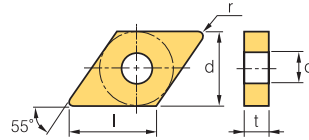

Dimensions (mm)			
Size	d	t	d ₁
11	9.525	3.18~4.76	3.81
15	12.7	4.76~6.35	5.16

Rhombic 55° Negative

Workpiece		P	M	K	N	S	H		
	Steel		●	●	●	●	●	●	●
Stainless steel		●	●	●	●	●	●	●	●
Cast iron		●	●	●	●	●	●	●	●
Non-ferrous metal		●	●	●	●	●	●	●	●
Heat resistant alloy, Titanium alloy		●	●	●	●	●	●	●	●
Hardened steel		●	●	●	●	●	●	●	●

Machining types
 ● Continuous cutting
 ● General cutting
 ✦ Interrupted cutting

Inserts	Designation	Cermet		Coated		Coated										Uncoated		Cutting Condition												
		CN1500	CN2000	CN2500	CC1500	CC2500	NC3215	NC3120	NC3225	NC3030	NC5330	NC6310	NC6315	NC9115	NC9125	NC9135	PC5300	PC5400	PC8105	PC8110	PC8115	PC9030	H01	H05	f _n (mm/rev)	a _p (mm)				
Medium cutting 	DNMG 110404-HM 110408-HM 150404-HM 150408-HM 150604-HM 150608-HM 150612-HM								●														●			0.05~0.50	0.80~4.00			
																								●			0.10~0.50	1.00~4.00		
										●																		0.05~0.30	0.90~5.00	
										●				●												●			0.10~0.50	1.00~5.00
											●		●													●			0.05~0.30	0.90~5.00
										●	●	●														●			0.10~0.50	1.00~5.00
												●														●			0.18~0.50	1.00~5.00
Medium cutting 	DNMG 150404-MK 150408-MK 150412-MK 150604-MK 150608-MK 150612-MK																										0.05~0.30	0.90~5.00		
																												0.10~0.50	1.00~5.00	
																												0.13~0.60	1.30~5.00	
														●														0.05~0.30	0.90~5.00	
														●														0.10~0.50	1.00~5.00	
														●	●													0.13~0.60	1.30~5.00	
																													0.13~0.60	1.30~5.00
Medium cutting 	DNMG 110404-MM 110408-MM 110412-MM 110504-MM 110508-MM 110512-MM 150404-MM 150408-MM 150412-MM 150416-MM 150604-MM 150608-MM 150612-MM 150616-MM																										0.08~0.35	0.50~5.00		
																													0.10~0.40	0.50~5.00
																													0.12~0.45	0.50~5.00
																													0.08~0.35	0.50~5.00
																													0.10~0.40	0.50~5.00
																													0.12~0.45	0.50~5.00
																													0.10~0.40	0.50~5.00
																													0.12~0.45	0.50~5.00
																													0.15~0.60	0.50~6.40
																													0.12~0.45	0.50~6.40
																													0.15~0.60	0.50~6.40
																													0.15~0.60	0.50~6.00
																													0.10~0.40	0.50~6.40
																											0.12~0.45	0.50~6.40		
																											0.15~0.60	0.50~6.40		
																											0.18~0.65	0.50~8.00		
Medium cutting 	DNMG 110404-MP 110408-MP 110412-MP 110504-MP 110508-MP 110512-MP 150404-MP 150408-MP 150412-MP 150416-MP 150604-MP 150608-MP 150612-MP 150616-MP																											0.10~0.40	0.40~3.80	
																													0.15~0.40	0.50~4.00
																													0.15~0.50	0.80~4.20
																													0.10~0.40	0.40~3.80
																													0.15~0.40	0.50~4.00
																													0.15~0.50	0.80~4.20
																													0.10~0.40	0.40~4.00
																													0.15~0.45	0.50~4.50
																													0.15~0.50	0.80~5.00
																													0.15~0.50	0.85~5.00
																													0.10~0.40	0.40~4.00
																													0.15~0.45	0.50~4.50
																													0.15~0.50	0.80~5.00
																													0.15~0.55	0.85~5.00

Cutting edge geometry A52~A61
 Recommended chip breaker B04~B11
 Code system B26~B27
 ● : Stock item

Available tool holders			
Designation	Page	Designation	Page
MCKNR/L	B171	MCRNR/L	B172
MCLNR/L	B171	PCBNR/L	B159
MCMNN	B171	PCLNR/L	B160



B Turning Insert (Negative)



DN ○○

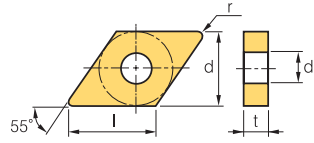

 Rhombic 55° Negative



Dimensions (mm)			
Size	d	t	d ₁
11	9.525	4.76	3.81
15	12.7	4.76~6.35	5.16

Workpiece	Machining types														
	P	M	K	N	S	H									
Steel	●	●	●	●	●	●	●	●	●	●	●	●	●	●	●
Stainless steel	●	●	●	●	●	●	●	●	●	●	●	●	●	●	●
Cast iron	●	●	●	●	●	●	●	●	●	●	●	●	●	●	●
Non-ferrous metal	●	●	●	●	●	●	●	●	●	●	●	●	●	●	●
Heat resistant alloy, Titanium alloy	●	●	●	●	●	●	●	●	●	●	●	●	●	●	●
Hardened steel	●	●	●	●	●	●	●	●	●	●	●	●	●	●	●

Inserts	Designation	Cermets		Coated		Coated										Uncoated		Cutting Condition									
		CN1500	CN2000	CN2500	CC1500	CC2500	NC3215	NC3120	NC3225	NC3030	NC5330	NC6310	NC6315	NC9115	NC9125	NC9135	PC5300	PC5400	PC8105	PC8110	PC8115	PC9030	H01	H05	f _n (mm/rev)	a _p (mm)	
Medium cutting 	DNMG 110404-VM																								0.05~0.30	0.90~4.00	
	110408-VM						●			●																0.10~0.50	1.00~4.00
	110412-VM																									0.13~0.50	1.30~4.00
	150404-VM	●									●					●	●									0.05~0.30	0.90~5.00
	150408-VM	●		●						●	●					●	●									0.10~0.50	1.00~5.00
	150412-VM	●									●					●	●									0.13~0.60	1.30~5.00
	150604-VM	●		●				●		●	●					●	●						●			0.05~0.30	0.90~5.00
	150608-VM	●						●	●	●	●					●	●						●			0.10~0.50	1.00~5.00
	150612-VM	●									●					●	●									0.13~0.60	1.30~5.00
Medium cutting 	DNMG 150404-VP3															●	●	●	●	●			●	●	0.05~0.30	0.10~3.00	
	150408-VP3															●	●	●	●	●			●	●	0.10~0.45	0.50~5.00	
	150412-VP3															●	●	●	●	●			●	●	0.12~0.50	0.50~5.00	
	150604-VP3															●	●	●	●	●			●	●	0.05~0.30	0.10~3.00	
	150608-VP3															●	●	●	●	●			●	●	0.10~0.45	0.50~5.00	
	150612-VP3															●	●	●	●	●			●	●	0.12~0.50	0.50~5.00	
Medium cutting  [wiper]	DNMG 150408-LW																								0.15~0.50	0.70~4.50	
	150412-LW																									0.20~0.60	1.00~5.00
	150608-LW							●		●																0.15~0.50	0.70~4.50
	150612-LW							●		●																0.20~0.60	1.00~5.00

 Cutting edge geometry A52~A61
  Recommended chip breaker B04~B11
  Code system B26~B27
 ● : Stock item

Available tool holders			
Designation	Page	Designation	Page
MCKNR/L	B171	MCRNR/L	B172
MCLNR/L	B171	PCBNR/L	B159
MCMNN	B171	PCLNR/L	B160



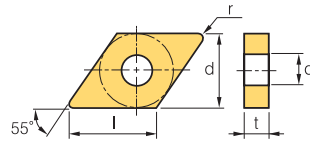

DN ○ ○

Dimensions (mm)			
Size	d	t	d ₁
15	12.7	4.76~6.35	5.16
19	15.875	6.35	7.93



Rhombic 55° Negative

Workpiece	Machining types															
	P	M	K	N	S	H										
Steel	●	●	●	●	●	●	●	●	●	●	●	●	●	●	●	●
Stainless steel	●	●	●	●	●	●	●	●	●	●	●	●	●	●	●	●
Cast iron	●	●	●	●	●	●	●	●	●	●	●	●	●	●	●	●
Non-ferrous metal	●	●	●	●	●	●	●	●	●	●	●	●	●	●	●	●
Heat resistant alloy, Titanium alloy	●	●	●	●	●	●	●	●	●	●	●	●	●	●	●	●
Hardened steel	●	●	●	●	●	●	●	●	●	●	●	●	●	●	●	●

Inserts	Designation	Cermet		Coated		Coated										Uncoated		Cutting Condition									
		CN1500	CN2000	CN2500	CC1500	CC2500	NC3215	NC3120	NC3225	NC3030	NC5330	NC6310	NC6315	NC9115	NC9125	NC9135	PC5300	PC5400	PC8105	PC8110	PC8115	PC9030	H01	H05	f _n (mm/rev)	a _p (mm)	
General 	DNMG 150402-B25																								0.15~0.40	0.50~3.50	
	150404-B25			●			●	●	●																	0.17~0.45	1.00~4.00
	150408-B25			●			●	●	●																	0.17~0.55	1.50~4.00
	150412-B25						●	●	●																	0.25~0.55	1.50~4.00
	150425-B25																									0.35~0.65	2.50~5.50
	150602-B25																									0.15~0.40	0.50~3.50
	150604-B25	●					●	●	●	●																0.17~0.55	1.50~4.00
	150608-B25	●					●	●	●	●													●			0.17~0.55	1.50~4.00
	150612-B25						●	●	●	●																0.25~0.55	1.50~4.00
150625-B25																									0.35~0.65	2.50~5.50	
Roughing 	DNMG 150408-GR						●		●																0.20~0.50	1.00~7.00	
	150412-GR																									0.25~0.90	1.30~7.00
	150416-GR																									0.30~0.75	1.80~7.00
	150608-GR								●	●	●															0.20~0.50	1.00~7.00
	150612-GR								●	●																0.25~0.70	1.30~7.00
	150616-GR										●															0.20~0.75	1.80~7.00
Roughing 	DNMG 150408-RK																								0.15~0.50	1.50~5.00	
	150412-RK												●												0.20~0.60	1.80~5.00	
	150608-RK											●	●												0.15~0.50	1.50~5.00	
	150612-RK												●												0.20~0.60	1.80~5.00	

Cutting edge geometry **A52~A61**
 Recommended chip breaker **B04~B11**
 Code system **B26~B27**
● : Stock item

Available tool holders			
Designation	Page	Designation	Page
MCKNR/L	B171	MCRNR/L	B172
MCLNR/L	B171	PCBNR/L	B159
MCMNN	B171	PCLNR/L	B160



B Turning Insert (Negative)



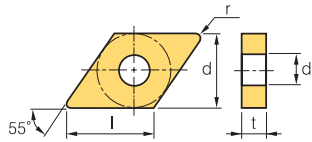

DN ○○



 Rhombic 55° Negative

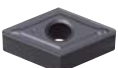

Dimensions (mm)			
Size	d	t	d ₁
15	12.7	4.76~6.35	5.16

Workpiece	Machining types															
	P	M	K	N	S	H										
Steel	●	●	●	●	●	●	●	●	●	●	●	●	●	●	●	●
Stainless steel	●	●	●	●	●	●	●	●	●	●	●	●	●	●	●	●
Cast iron	●	●	●	●	●	●	●	●	●	●	●	●	●	●	●	●
Non-ferrous metal	●	●	●	●	●	●	●	●	●	●	●	●	●	●	●	●
Heat resistant alloy, Titanium alloy	●	●	●	●	●	●	●	●	●	●	●	●	●	●	●	●
Hardened steel	●	●	●	●	●	●	●	●	●	●	●	●	●	●	●	●

Inserts	Designation	Cermet			Coated		Coated										Uncoated		Cutting Condition													
		CN1500	CN2000	CN2500	CC1500	CC2500	NC3215	NC3120	NC3225	NC3030	NC5330	NC6310	NC6315	NC9115	NC9125	NC9135	PC5300	PC5400	PC8105	PC8110	PC8115	PC9030	H01	H05	fn (mm/rev)	ap (mm)						
Roughing RM 	DNMG	150404-RM												●	●	●										0.10~0.50	2.00~6.00					
		150408-RM													●	●	●											0.15~0.55	2.00~6.00			
		150412-RM														●	●	●											0.20~0.60	2.00~6.00		
		150416-RM														●	●	●											0.25~0.70	2.00~6.00		
		150604-RM														●	●	●											0.10~0.50	2.00~6.00		
		150608-RM														●	●	●					●						0.15~0.55	2.00~6.00		
		150612-RM														●	●	●											0.20~0.60	2.00~6.00		
		150616-RM														●	●	●											0.25~0.70	2.00~6.00		
Roughing VP4 	DNMG	150408-VP4																									0.15~0.35	1.00~4.00				
		150412-VP4																										0.20~0.40	1.00~4.00			
		150608-VP4																						●					0.15~0.35	1.00~4.00		
		150612-VP4																							●				0.20~0.40	1.00~4.00		
Roughing VR 	DNMG	150408-VR																									0.25~0.55	1.20~7.00				
		150412-VR																										0.30~0.60	1.50~7.00			
		150608-VR																											0.25~0.55	1.20~7.00		
		150612-VR																											0.30~0.60	1.50~7.00		
Finishing SR  [Shaft]	DNMX	150404R-SR																									0.10~0.40	0.70~4.50				
		150408R-SR																											0.12~0.45	1.00~4.50		
		150604R-SR																											0.10~0.40	0.70~4.50		
		150608R-SR																												0.12~0.45	1.00~4.50	
		150404L-SR																												0.10~0.40	0.70~4.50	
		150408L-SR																												0.12~0.45	1.00~4.50	
		150604L-SR																												0.10~0.40	0.70~4.50	
		150608L-SR																												0.12~0.45	1.00~4.50	
Medium cutting SH  [Shaft]	DNMX	150404R-SH																										0.15~0.30	1.00~4.00			
		150408R-SH																												0.15~0.50	1.50~5.00	
		150604R-SH						●	●																					0.15~0.30	1.00~4.00	
		150608R-SH						●	●																						0.15~0.50	1.50~5.00
		150404L-SH																													0.15~0.30	1.00~4.00
		150408L-SH																													0.15~0.50	1.50~5.00
		150604L-SH						●	●																						0.15~0.30	1.00~4.00
		150608L-SH						●	●																						0.15~0.50	1.50~5.00

 Cutting edge geometry A52~A61  Recommended chip breaker B04~B11  Code system B26~B27 ●: Stock item

Available tool holders			
Designation	Page	Designation	Page
MCKNR/L	B171	MCRNR/L	B172
MCLNR/L	B171	PCBNR/L	B159
MCMNN	B171	PCLNR/L	B160



KN

Dimensions (mm)		
Size	d	t
16	9.525	4.76

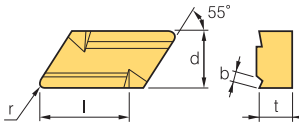

Parallelogram 55° Negative

Workpiece	Material	Code	Machining types															
			●	●	●	●	●	●	●	●	●	●	●	●	●	●	●	●
Steel	P	●	●	●	●	●	●	●	●	●	●	●	●	●	●	●	●	●
Stainless steel	M	●	●	●	●	●	●	●	●	●	●	●	●	●	●	●	●	●
Cast iron	K	●	●	●	●	●	●	●	●	●	●	●	●	●	●	●	●	●
Non-ferrous metal	N	●	●	●	●	●	●	●	●	●	●	●	●	●	●	●	●	●
Heat resistant alloy, Titanium alloy	S	●	●	●	●	●	●	●	●	●	●	●	●	●	●	●	●	●
Hardened steel	H	●	●	●	●	●	●	●	●	●	●	●	●	●	●	●	●	●

Inserts	Designation	Cermet		Coated		Coated										Uncoated		Cutting Condition										
		CN1500	CN2000	CN2500	CC1500	CC2500	NC3215	NC3120	NC3225	NC3030	NC5330	NC6310	NC6315	NC9115	NC9125	NC9135	PC5300	PC5400	PC8105	PC8110	PC8115	PC9030	H01	H05	fn (mm/rev)	ap (mm)		
Medium cutting	11	KNUX	160405R-11		●	●	●	●	●	●	●	●	●	●	●	●	●	●	●	●	●	●	●	●	0.20~0.35	1.00~6.00		
			160410R-11		●	●	●	●	●	●	●	●	●	●	●	●	●	●	●	●	●	●	●	●	●	0.30~0.60	1.50~6.00	
			160405L-11		●	●	●	●	●	●	●	●	●	●	●	●	●	●	●	●	●	●	●	●	●	●	0.20~0.35	1.00~6.00
			160410L-11		●	●	●	●	●	●	●	●	●	●	●	●	●	●	●	●	●	●	●	●	●	●	0.30~0.60	1.50~6.00
Roughing	12	KNUX	160405R-12		●	●	●	●	●	●	●	●	●	●	●	●	●	●	●	●	●	●	●	●	0.25~0.35	1.50~6.00		
			160410R-12		●	●	●	●	●	●	●	●	●	●	●	●	●	●	●	●	●	●	●	●	●	0.40~0.70	1.50~6.00	
			160405L-12		●	●	●	●	●	●	●	●	●	●	●	●	●	●	●	●	●	●	●	●	●	●	0.25~0.35	1.50~6.00
			160410L-12		●	●	●	●	●	●	●	●	●	●	●	●	●	●	●	●	●	●	●	●	●	●	0.40~0.70	1.50~6.00

⚙ Cutting edge geometry **A52~A61**
 ⚙ Recommended chip breaker **B04~B11**
 ⚙ Code system **B26~B27**
 ● : Stock item

Available tool holders

Designation	Page	Designation	Page
CKJNR/L	B169	CKUNR/L	B201
CKNNR/L	B169		

RN

Dimensions (mm)			
Size	d	t	d ₁
09	9.525	3.18	3.81
12	12.7	4.76	5.16
15	15.875	6.35	6.35
19	19.05	6.35	7.93
25	25.4	6.35~9.52	9.12
31	31.75	9.52	12.7

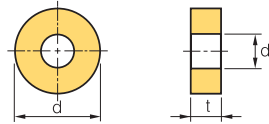

Round Negative

Workpiece	Material	Code	Machining types																						
			●	●	●	●	●	●	●	●	●	●	●	●	●	●	●	●	●						
Steel	P	●	●	●	●	●	●	●	●	●	●	●	●	●	●	●	●	●	●	●	●	●	●	●	●
Stainless steel	M	●	●	●	●	●	●	●	●	●	●	●	●	●	●	●	●	●	●	●	●	●	●	●	●
Cast iron	K	●	●	●	●	●	●	●	●	●	●	●	●	●	●	●	●	●	●	●	●	●	●	●	●
Non-ferrous metal	N	●	●	●	●	●	●	●	●	●	●	●	●	●	●	●	●	●	●	●	●	●	●	●	●
Heat resistant alloy, Titanium alloy	S	●	●	●	●	●	●	●	●	●	●	●	●	●	●	●	●	●	●	●	●	●	●	●	●
Hardened steel	H	●	●	●	●	●	●	●	●	●	●	●	●	●	●	●	●	●	●	●	●	●	●	●	●

Inserts	Designation	Cermet		Coated		Coated										Uncoated		Cutting Condition								
		CN1500	CN2000	CN2500	CC1500	CC2500	NC3215	NC3120	NC3225	NC3030	NC5330	NC6310	NC6315	NC9115	NC9125	NC9135	PC5300	PC5400	PC8105	PC8110	PC8115	PC9030	H01	H05	fn (mm/rev)	ap (mm)
General	B25	RNMG 090300-B25		●	●	●	●	●	●	●	●	●	●	●	●	●	●	●	●	●	●	●	●	0.90~4.50	0.09~0.90	
		120400-B25		●	●	●	●	●	●	●	●	●	●	●	●	●	●	●	●	●	●	●	●	●	1.20~4.80	0.12~1.20
		150600-B25		●	●	●	●	●	●	●	●	●	●	●	●	●	●	●	●	●	●	●	●	●	1.15~1.50	1.50~7.50
		190600-B25		●	●	●	●	●	●	●	●	●	●	●	●	●	●	●	●	●	●	●	●	●	1.90~7.60	0.19~1.90
		250600-B25		●	●	●	●	●	●	●	●	●	●	●	●	●	●	●	●	●	●	●	●	●	2.50~10.0	0.25~2.50
		250900-B25		●	●	●	●	●	●	●	●	●	●	●	●	●	●	●	●	●	●	●	●	●	2.50~10.0	0.25~2.50
		310900-B25		●	●	●	●	●	●	●	●	●	●	●	●	●	●	●	●	●	●	●	●	●	3.50~13.0	0.30~2.50

⚙ Cutting edge geometry **A52~A61**
 ⚙ Recommended chip breaker **B04~B11**
 ⚙ Code system **B26~B27**
 ● : Stock item



B Turning Insert (Negative)

SN ○ ○

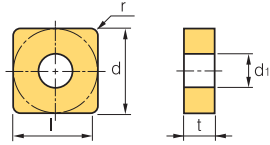

Dimensions (mm)			
Size	d	t	d ₁
09	9.525	3.18	3.81
12	12.7	4.76	5.16
15	15.875	6.35	6.35
19	19.05	6.35	7.93

□ Square 90° Negative

Workpiece	Material		Machining types																	
	Symbol	Color	●	◐	◑	●	◐	◑	●	◐	◑	●	◐	◑	●	◐	◑	●	◐	◑
Steel	P	Blue	●	◐	◑	●	◐	◑	●	◐	◑	●	◐	◑	●	◐	◑	●	◐	◑
Stainless steel	M	Yellow	●	◐	◑	●	◐	◑	●	◐	◑	●	◐	◑	●	◐	◑	●	◐	◑
Cast iron	K	Red	●	◐	◑	●	◐	◑	●	◐	◑	●	◐	◑	●	◐	◑	●	◐	◑
Non-ferrous metal	N	Green	●	◐	◑	●	◐	◑	●	◐	◑	●	◐	◑	●	◐	◑	●	◐	◑
Heat resistant alloy, Titanium alloy	S	Orange	●	◐	◑	●	◐	◑	●	◐	◑	●	◐	◑	●	◐	◑	●	◐	◑
Hardened steel	H	Grey	●	◐	◑	●	◐	◑	●	◐	◑	●	◐	◑	●	◐	◑	●	◐	◑

Inserts	Designation	Cermets		Coated		Coated													Uncoated		Cutting Condition								
		CN1500	CN2000	CN2500	CC1500	CC2500	NC3215	NC3120	NC3225	NC3030	NC5330	NC6310	NC6315	NC9115	NC9125	NC9135	PC5300	PC5400	PC8105	PC8110	PC8115	PC9030	H01	H05	fn (mm/rev)	ap (mm)			
Roughing		SNGA 090304																								0.17-0.50	0.50-4.50		
		090308																									0.17-0.50	0.50-4.50	
		120404																									0.15-0.60	1.50-8.00	
		120408																									0.15-0.60	1.50-8.00	
		120412																									0.20-0.80	1.50-8.00	
		150608																									0.20-0.80	2.00-10.00	
		150616																									0.20-0.90	2.00-10.00	
		190608																										0.15-0.60	3.00-12.00
		190612																										0.20-0.80	3.00-12.00
		Medium cutting		SNGG 090304R																								0.12-0.35	1.00-3.00
090308R																											0.15-0.35	1.00-3.00	
120404R	●																										0.15-0.35	1.00-4.00	
120408R																											0.15-0.35	1.00-4.00	
120412R																											0.15-0.35	1.00-4.00	
090304L																											0.12-0.35	1.00-3.00	
090308L																											0.15-0.35	1.00-3.00	
120404L																											0.15-0.35	1.00-4.00	
120408L																											0.15-0.35	1.00-4.00	
120412L																											0.15-0.35	1.00-4.00	
Medium cutting		SNGG 120404-VP3																	●	●	●	●	●	●	0.05-0.30	0.10-3.00			
		120408-VP3																		●	●	●	●	●	●	0.10-0.45	1.00-5.00		
		120412-VP3																			●	●	●	●	●	●	0.12-0.50	1.00-5.00	

↻ Cutting edge geometry A52~A61 ↻ Recommended chip breaker B04~B11 ↻ Code system B26~B27 ● : Stock item

Available tool holders					
Designation	Page	Designation	Page	Designation	Page
MSBNR/L	B173	MSRNR/L	B174	PSDNN	B163
MSDNN	B173	MSSNR/L	B175	PSKNR/L	B164, 199
MSKNR/L	B174	PSBNR/L	B163	PSSNR/L	B164



B Turning Insert (Negative)

SN

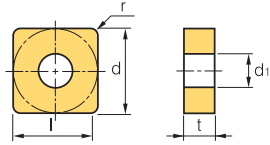

Dimensions (mm)			
Size	d	t	d ₁
09	9.525	3.18	3.81
12	12.7	3.18~4.76	5.16

Square **90° Negative**

Workpiece	Material Group											Machining types				
	Steel	Stainless steel	Cast iron	Non-ferrous metal	Heat resistant alloy, Titanium alloy	Hardened steel	P	M	K	N	S	H	●	⦿	⚙	
Steel	●	●	●	●	●	●	●	●	●	●	●	●	●	●	●	●
Stainless steel	●	●	●	●	●	●	●	●	●	●	●	●	●	●	●	●
Cast iron	●	●	●	●	●	●	●	●	●	●	●	●	●	●	●	●
Non-ferrous metal	●	●	●	●	●	●	●	●	●	●	●	●	●	●	●	●
Heat resistant alloy, Titanium alloy	●	●	●	●	●	●	●	●	●	●	●	●	●	●	●	●
Hardened steel	●	●	●	●	●	●	●	●	●	●	●	●	●	●	●	●

Inserts	Designation	Cermets		Coated		Coated											Uncoated		Cutting Condition									
		CN1500	CN2000	CN2500	CC1500	CC2500	NC3215	NC3120	NC3225	NC3030	NC5330	NC6310	NC6315	NC9115	NC9125	NC9135	PC5300	PC5400	PC8105	PC8110	PC8115	PC9030	H01	H05	f _n (mm/rev)	a _p (mm)		
Finishing	VB	SNMG 120404-VB	●	●	●	●	●	●	●	●	●	●	●	●	●	●	●	●	●	●	●	●	●	●	●	0.15~0.35	0.30~2.00	
		120408-VB	●	●	●	●	●	●	●	●	●	●	●	●	●	●	●	●	●	●	●	●	●	●	●	●	0.15~0.40	0.50~2.00
Finishing	VF	SNMG 090304-VF																								0.07~0.30	0.50~1.50	
		090308-VF																									0.07~0.30	0.50~1.50
		120404-VF																									0.07~0.30	0.50~1.50
		120408-VF								●																	0.10~0.40	0.50~1.50
		120412-VF																										0.20~0.50
Finishing	VL	SNMG 120408-VL																			●					0.10~0.35	0.20~1.50	
Medium to finishing	HA	SNMG 120404-HA																					●	●		0.10~0.35	0.80~3.50	
		120408-HA																						●	●		0.10~0.40	0.80~3.50
		120412-HA																									0.13~0.55	0.80~3.50
Medium to finishing	LP	SNMG 090308-LP																									0.10~0.30	0.30~1.50
		090408-LP																									0.10~0.30	0.30~1.50
		120404-LP							●	●	●																0.10~0.35	0.30~2.00
		120408-LP							●	●	●																0.10~0.40	0.50~2.50
		120412-LP							●	●	●																0.13~0.45	0.80~3.00
Medium to finishing	VC	SNMG 120408-VC									●	●														0.15~0.40	0.50~3.50	
Medium to finishing	VP2	SNMG 120404-VP2																			●	●	●	●	●	●	0.05~0.35	0.10~3.00
		120408-VP2										●										●	●	●	●	●	0.10~0.45	0.50~4.50
		120412-VP2																				●	●	●	●	●	0.10~0.50	0.50~5.00

Cutting edge geometry A52~A61 Recommended chip breaker B04~B11 Code system B26~B27 ● : Stock item

Available tool holders					
Designation	Page	Designation	Page	Designation	Page
MSBNR/L	B173	MSRNR/L	B174	PSDNN	B163
MSDNN	B173	MSSNR/L	B175	PSKNR/L	B164, 199
MSKNR/L	B174	PSBNR/L	B163	PSSNR/L	B164



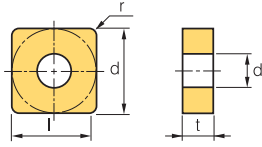

SN



Dimensions (mm)			
Size	d	t	d ₁
09	9.525	3.18	3.81
12	12.7	3.18~4.76	5.16
15	15.875	4.76~6.35	6.35
19	19.05	4.76~6.35	7.93
25	25.4	6.35~9.52	9.12

○ Square **90° Negative**

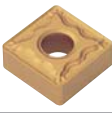
Workpiece	Steel	P																Machining types				
	Stainless steel	M	●	●	●	●	●	●	●	●	●	●	●	●	●	●	●	●	●	●	●	●
Cast iron	K	●	●	●	●	●	●	●	●	●	●	●	●	●	●	●	●	●	●	●	●	
Non-ferrous metal	N																					
Heat resistant alloy, Titanium alloy	S																					
Hardened steel	H																					

Inserts	Designation	Cermets		Coated		Coated										Uncoated		Cutting Condition												
		CN1500	CN2000	CN2500	CC1500	CC2500	NC3215	NC3120	NC3225	NC3030	NC5330	NC6310	NC6315	NC9115	NC9125	NC9135	PC5300	PC5400	PC8105	PC8110	PC8115	PC9030	H01	H05	f _n (mm/rev)	a _p (mm)				
Medium to finishing	 [Cermets]	SNMG 090304-VQ																								0.05~0.30	0.50~3.50			
		090408-VQ										●															0.08~0.30	0.80~4.00		
		090412-VQ										●															0.10~0.30	1.00~4.00		
		120404-VQ	●		●																						0.05~0.30	0.80~4.00		
		120408-VQ	●		●																						0.08~0.40	0.80~4.00		
Medium cutting		SNMG 120404-HM																						●		0.15~0.42	0.60~4.20			
		120408-HM						●	●		●		●												●		0.10~0.50	1.00~5.00		
		120412-HM						●																		●		0.18~0.50	1.00~5.00	
Medium cutting	 new	SNMG 090308-MK																								0.17~0.45	0.80~3.50			
		120404-MK																									0.08~0.45	0.80~4.00		
		120408-MK													●												0.10~0.50	1.00~5.00		
		120412-MK													●												0.13~0.60	1.30~5.00		
		120416-MK																									0.15~0.63	1.50~6.00		
		150608-MK																									0.25~0.60	1.80~6.00		
		150612-MK																									0.20~0.70	1.80~7.00		
		150616-MK																									0.23~0.70	2.00~7.50		
		190608-MK																										0.31~0.75	2.30~9.50	
		190612-MK															●											0.33~0.78	2.50~10.00	
		190616-MK																										0.35~0.78	2.70~10.00	
Medium cutting	 new	SNMG 090304-MM																								0.08~0.35	0.50~5.00			
		090308-MM																									0.10~0.40	0.50~5.00		
		090312-MM																									0.12~0.45	0.50~5.00		
		090404-MM																									0.08~0.35	0.50~5.00		
		090408-MM																									0.10~0.40	0.50~5.00		
		120404-MM													●	●	●	●							●	●	0.10~0.40	0.50~6.40		
		120408-MM													●	●	●	●							●	●	0.12~0.45	0.50~6.40		
		120412-MM														●	●	●								●	●	0.15~0.60	0.50~6.40	
		120416-MM																										0.18~0.65	0.50~6.40	
		150608-MM																										0.12~0.45	0.50~8.00	
		150612-MM															●	●	●								●	●	0.15~0.60	0.50~8.00
		150616-MM															●	●										0.18~0.65	0.50~8.00	
		190608-MM															●	●	●								●	0.12~0.45	0.50~9.50	
		190612-MM															●	●	●								●	0.15~0.60	0.50~9.50	
190616-MM															●	●									●	0.18~0.65	0.50~9.50			
250924-MM																●										0.20~0.80	1.00~10.00			

🔄 Cutting edge geometry **A52~A61**
🔄 Recommended chip breaker **B04~B11**
🔄 Code system **B26~B27**
● : Stock item

Available tool holders					
Designation	Page	Designation	Page	Designation	Page
MSBNR/L	B173	MSRNR/L	B174	PSDNN	B163
MSDNN	B173	MSSNR/L	B175	PSKNR/L	B164, 199
MSKNR/L	B174	PSBNR/L	B163	PSSNR/L	B164



B Turning Insert (Negative)

SN ○ ○

Square **90° Negative**

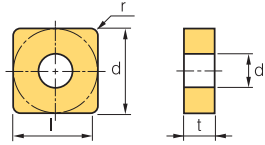

Dimensions (mm)			
Size	d	t	d ₁
09	9.525	3.18	3.81
12	12.7	4.76	5.16
15	15.875	6.35	6.35
19	19.05	6.35	7.93
25	25.4	7.94	9.12

Workpiece	Material Groups																Machining types	
	P	M	K	N	S	H	1	2	3	4	5	6	7	8	9	10	●	⊙
Steel	●	●	●	●	●	●	●	●	●	●	●	●	●	●	●	●	●	●
Stainless steel	●	●	●	●	●	●	●	●	●	●	●	●	●	●	●	●	●	●
Cast iron	●	●	●	●	●	●	●	●	●	●	●	●	●	●	●	●	●	●
Non-ferrous metal	●	●	●	●	●	●	●	●	●	●	●	●	●	●	●	●	●	●
Heat resistant alloy, Titanium alloy	●	●	●	●	●	●	●	●	●	●	●	●	●	●	●	●	●	●
Hardened steel	●	●	●	●	●	●	●	●	●	●	●	●	●	●	●	●	●	●

Inserts	Designation	Cermet		Coated		Coated										Uncoated		Cutting Condition												
		CN1500	CN2000	CN2500	CC1500	CC2500	NC3215	NC3120	NC3225	NC3030	NC5330	NC6310	NC6315	NC9115	NC9125	NC9135	PC5300	PC5400	PC8105	PC8110	PC8115	PC9030	H01	H05	f _n (mm/rev)	a _p (mm)				
Medium cutting 	SNMG 090304-MP						●	●	●																	0.10-0.40	0.40-3.80			
	090308-MP						●	●	●																		0.15-0.40	0.50-4.00		
	090312-MP																										0.15-5.00	0.80-4.20		
	090404-MP																										0.10-0.40	0.40-3.80		
	090408-MP																										0.15-0.40	0.50-4.00		
	090412-MP																										0.15-0.50	0.80-4.20		
	120404-MP							●	●	●				●	●	●			●	●							0.10-0.40	0.40-4.00		
	120408-MP							●	●	●				●	●	●			●	●							0.15-0.45	0.50-4.50		
	120412-MP							●	●	●				●	●	●												0.15-0.50	0.80-5.00	
	120416-MP							●	●	●																		0.18-0.60	0.80-7.00	
	150608-MP																											0.15-5.00	0.50-7.00	
	150612-MP																											0.18-0.60	0.80-8.50	
	190608-MP																											0.15-0.50	0.50-8.50	
	190612-MP																											0.18-0.60	0.80-8.50	
Medium cutting 	SNMG 090304-VM																										0.05-0.30	0.90-3.50		
	090308-VM																											0.10-5.00	1.00-3.50	
	120404-VM	●								●							●	●									0.05-0.30	0.90-5.00		
	120408-VM	●							●	●	●						●	●		●	●							0.10-0.50	1.00-5.00	
	120412-VM									●							●	●										0.13-0.60	1.30-5.00	
	190612-VM																											0.25-0.60	2.50-7.50	
190616-VM																											0.25-0.60	2.50-7.50		
Medium cutting 	SNMG 120404-VP3																●	●	●	●	●		●	●		0.05-0.30	0.10-3.00			
	120408-VP3																●	●	●	●	●		●	●			0.10-0.45	1.00-5.00		
	120412-VP3																●	●	●	●	●		●	●			0.12-0.50	1.00-5.00		
	120416-VP3																	●	●	●	●	●		●	●			0.25-0.45	0.50-4.00	
	160608-VP3																											0.15-0.35	0.80-6.00	
	160612-VP3																											0.20-0.40	1.00-6.00	
	160616-VP3																											0.20-0.40	1.00-6.00	
	190608-VP3																												0.15-0.35	0.80-7.00
	190612-VP3																												0.20-0.40	1.00-7.00
190616-VP3																												0.25-0.45	1.00-7.00	

Cutting edge geometry A52~A61
 Recommended chip breaker B04~B11
 Code system B26~B27
 ● : Stock item

Available tool holders					
Designation	Page	Designation	Page	Designation	Page
MSBNR/L	B173	MSRNR/L	B174	PSDNN	B163
MSDNN	B173	MSSNR/L	B175	PSKNR/L	B164, 199
MSKNR/L	B174	PSBNR/L	B163	PSSNR/L	B164



SN ○ ○

□ Square **90° Negative**

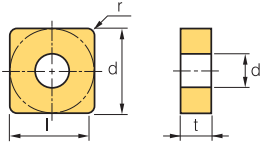

Dimensions (mm)			
Size	d	t	d ₁
09	9.525	3.18	3.81
12	12.7	4.76	5.16
15	15.875	6.35	6.35
19	19.05	6.35	7.93
25	25.4	7.94	9.12

Workpiece	Material	Machining types															
		●	●	●	●	●	●	●	●	●	●	●	●	●	●	●	●
Steel	P	●	●	●	●	●	●	●	●	●	●	●	●	●	●	●	●
Stainless steel	M	●	●	●	●	●	●	●	●	●	●	●	●	●	●	●	●
Cast iron	K	●	●	●	●	●	●	●	●	●	●	●	●	●	●	●	●
Non-ferrous metal	N																
Heat resistant alloy, Titanium alloy	S																
Hardened steel	H																

● Continuous cutting
 ● General cutting
 ● Interrupted cutting

Inserts	Designation	Cermet		Coated		Coated												Uncoated		Cutting Condition								
		CN1500	CN2000	CN2500	CC1500	CC2500	NC3215	NC3120	NC3225	NC3030	NC5330	NC6310	NC6315	NC9115	NC9125	NC9135	PC5300	PC5400	PC8105	PC8110	PC8115	PC9030	H01	H05	f _n (mm/rev)	a _p (mm)		
General 	SNMG 090308-B25																									0.17~0.45	0.80~3.50	
	120404-B25	●		●			●	●	●	●																	0.17~0.45	1.00~3.50
	120408-B25	●		●			●	●	●	●						●	●						●				0.23~0.60	1.50~5.00
	120412-B25			●			●	●	●	●																	0.25~0.60	2.00~5.00
	120416-B25						●	●	●	●																	0.35~0.70	2.50~5.00
	120420-B25																										0.40~0.70	3.00~5.00
	150608-B25									●																	0.25~0.60	1.50~6.00
	150612-B25																										0.25~0.60	2.00~6.00
	150616-B25									●																	0.35~0.70	2.00~6.00
	190608-B25							●	●	●																	0.25~0.60	3.00~8.00
	190612-B25							●	●	●	●																0.30~0.60	3.00~8.00
	190616-B25							●	●	●	●										●						0.35~0.70	3.00~8.00
	250716-B25																										0.35~0.70	4.00~12.00
	250724-B25							●			●																0.50~1.00	5.00~12.00
250924-B25							●																			0.50~1.00	5.00~12.00	
Roughing 	SNMG 120404-GR																									0.15~0.45	0.08~6.00	
	120408-GR										●	●															0.20~0.50	1.00~7.00
	120412-GR									●																	0.20~0.50	1.00~7.00
	150608-GR									●																	0.25~0.60	1.00~7.00
	150612-GR								●	●	●																0.29~0.75	1.40~7.00
	190608-GR									●																	0.30~0.80	1.70~9.00
	190612-GR								●	●	●	●															0.30~0.80	1.70~9.00
	190616-GR								●	●	●	●															0.31~0.82	1.90~12.30
	190624-GR																										0.35~0.82	2.00~12.50
	250724-GR											●															0.45~1.20	2.60~14.00
250924-GR								●		●																0.50~1.20	2.60~14.00	
Roughing 	SNMG 120404-RK																									0.15~0.50	1.20~6.00	
	120408-RK											●	●														0.23~0.53	1.50~6.00
	120412-RK											●	●														0.28~0.53	1.80~6.00
	120416-RK												●														0.28~0.53	2.00~6.00
	150612-RK													●													0.20~0.70	1.80~7.00
	150616-RK																										0.23~0.70	2.00~7.50
	190612-RK																										0.33~0.78	2.50~10.00
	190616-RK																										0.35~0.78	2.70~10.00

Cutting edge geometry **A52~A61**
 Recommended chip breaker **B04~B11**
 Code system **B26~B27**
 ● : Stock item

Available tool holders					
Designation	Page	Designation	Page	Designation	Page
MSBNR/L	B173	MSRNR/L	B174	PSDNN	B163
MSDNN	B173	MSSNR/L	B175	PSKNR/L	B164, 199
MSKNR/L	B174	PSBNR/L	B163	PSSNR/L	B164



B Turning Insert (Negative)

SN

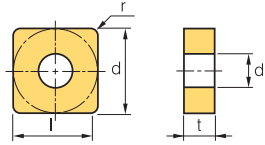

Dimensions (mm)			
Size	d	t	d ₁
12	12.7	4.76	5.16
15	15.875	6.35	6.35
19	19.05	6.35	7.93
25	25.4	7.94~9.52	9.12

Square **90° Negative**

Workpiece	Machining types												
	P	M	K	N	S	H							
Steel	●	●	●	●	●	●	●	●	●	●	●	●	●
Stainless steel	●	●	●	●	●	●	●	●	●	●	●	●	●
Cast iron	●	●	●	●	●	●	●	●	●	●	●	●	●
Non-ferrous metal	●	●	●	●	●	●	●	●	●	●	●	●	●
Heat resistant alloy, Titanium alloy	●	●	●	●	●	●	●	●	●	●	●	●	●
Hardened steel	●	●	●	●	●	●	●	●	●	●	●	●	●

Inserts	Designation	Cermets		Coated		Coated										Uncoated		Cutting Condition										
		CN1500	CN2000	CN2500	CC1500	CC2500	NC3215	NC3120	NC3225	NC3030	NC5330	NC6310	NC6315	NC9115	NC9125	NC9135	PC5300	PC5400	PC8105	PC8110	PC8115	PC9030	H01	H05	f _n (mm/rev)	a _p (mm)		
Roughing 	SNMG 120404-RM												●	●	●	●					●				0.10~0.50	2.00~6.00		
	120408-RM												●	●	●	●					●	●	●			0.15~0.55	2.00~6.00	
	120412-RM													●	●	●					●					0.20~0.60	2.00~6.00	
	120416-RM																					●					0.25~0.70	2.00~6.00
	150608-RM																										0.20~0.60	0.20~6.00
	150612-RM														●	●	●					●					0.20~0.60	2.00~8.00
	150616-RM																										0.25~0.70	2.00~8.00
	190608-RM															●	●	●				●					0.20~0.60	2.00~10.00
	190612-RM															●	●	●				●					0.20~0.60	2.00~10.00
	190616-RM																										0.27~0.70	2.00~10.00
	190624-RM																										0.30~0.75	3.00~10.00
250924-RM																										0.40~1.20	4.00~14.00	
Roughing 	SNMG 120408-VP4																				●					0.15~0.35	1.00~4.00	
	120412-VP4																				●						0.20~0.40	1.00~4.00
	150612-VP4																				●						0.20~0.45	1.00~5.00
	190608-VP4																				●						0.20~0.50	1.00~9.00
	190612-VP4																				●						0.23~0.55	1.00~9.00
	190616-VP4																				●						0.27~0.60	1.00~9.00
Roughing 	SNMG 120408-VR																									0.25~0.55	1.20~7.00	
	120412-VR																										0.30~0.60	1.50~7.00
	120416-VR																										0.35~0.60	2.00~7.00
	190612-VR						●	●																			0.35~0.70	2.00~10.00
	190616-VR						●	●																			0.35~0.75	2.20~10.00
Roughing 	SNMM 120408-GR																									0.20~0.50	1.00~7.00	
	120412-GR								●																		0.25~0.65	1.30~7.00
	190612-GR								●																		0.25~0.65	1.30~11.50
	190616-GR																										0.32~0.85	1.80~11.50

Cutting edge geometry **A52~A61**
 Recommended chip breaker **B04~B11**
 Code system **B26~B27**
● : Stock item

Available tool holders					
Designation	Page	Designation	Page	Designation	Page
MSBNR/L	B173	MSRNR/L	B174	PSDNN	B163
MSDNN	B173	MSSNR/L	B175	PSKNR/L	B164, 199
MSKNR/L	B174	PSBNR/L	B163	PSSNR/L	B164



SN

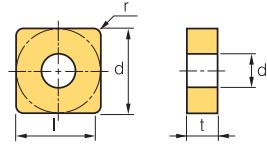

Dimensions (mm)			
Size	d	t	d ₁
12	12.7	4.76	5.16
15	15.875	6.35	6.35
19	19.05	6.35	7.93
25	25.4	7.94~9.52	9.12

Square **90° Negative**

Workpiece	Material	Code	Machining types																
			●	●	●	●	●	●	●	●	●	●	●	●	●	●			
Steel	P	●	●	●	●	●	●	●	●	●	●	●	●	●	●	●	●	●	●
Stainless steel	M	●	●	●	●	●	●	●	●	●	●	●	●	●	●	●	●	●	●
Cast iron	K	●	●	●	●	●	●	●	●	●	●	●	●	●	●	●	●	●	●
Non-ferrous metal	N	●	●	●	●	●	●	●	●	●	●	●	●	●	●	●	●	●	●
Heat resistant alloy, Titanium alloy	S	●	●	●	●	●	●	●	●	●	●	●	●	●	●	●	●	●	●
Hardened steel	H	●	●	●	●	●	●	●	●	●	●	●	●	●	●	●	●	●	●

Inserts	Designation	Cermet		Coated		Coated											Uncoated		Cutting Condition											
		CN1500	CN2000	CN2500	CC1500	CC2500	NC3215	NC3120	NC3225	NC3030	NC5330	NC6310	NC6315	NC9115	NC9125	NC9135	PC5300	PC5400	PC8105	PC8110	PC8115	PC9030	H01	H05	f _n (mm/rev)	a _p (mm)				
Heavy GH 	SNMM 120408-GH								●	●																	0.30~0.60	2.50~8.00		
	120412-GH								●	●																		0.30~0.70	2.50~8.00	
	150612-GH								●	●																		0.30~0.70	2.50~8.00	
	190612-GH							●	●	●	●																	0.30~0.70	3.00~8.00	
	190616-GH							●	●	●	●																	0.45~1.00	4.00~9.00	
	190624-GH							●	●	●	●																	0.55~1.20	4.00~9.00	
	250724-GH							●	●	●	●																	0.55~1.20	5.00~12.00	
	250924-GH							●	●	●	●																	0.55~1.20	5.00~12.00	
250932-GH																											0.55~1.20	5.00~12.00		
Heavy VH [General]	SNMM 190612-VH						●																				0.50~0.90	5.00~10.00		
	190616-VH						●																					0.50~1.10	5.00~10.00	
	190624-VH						●																					0.60~1.20	6.00~12.00	
	250716-VH																											0.70~1.40	6.00~15.00	
	250724-VH							●		●																		0.70~1.40	6.00~15.00	
	250920-VH																											0.70~1.40	6.00~15.00	
	250924-VH							●																				0.70~1.50	6.00~14.00	
Heavy VT [High feed cutting]	SNMM 190612-VT						●			●																		0.60~1.00	6.00~13.00	
	190616-VT						●			●																			0.60~1.10	6.00~13.00
	190624-VT						●																						0.60~1.60	7.00~13.00
	250716-VT																												0.75~1.60	7.00~15.00
	250724-VT							●		●																			0.75~1.60	7.00~15.00
	250920-VT																												0.75~1.60	7.00~15.00
	250924-VT							●		●																			0.75~1.60	7.00~17.00

Cutting edge geometry **A52~A61**
 Recommended chip breaker **B04~B11**
 Code system **B26~B27**
● : Stock item

Available tool holders					
Designation	Page	Designation	Page	Designation	Page
MSBNR/L	B173	MSRNR/L	B174	PSDNN	B163
MSDNN	B173	MSSNR/L	B175	PSKNR/L	B164, 199
MSKNR/L	B174	PSBNR/L	B163	PSSNR/L	B164

B Turning Insert (Negative)

SN ○ ○

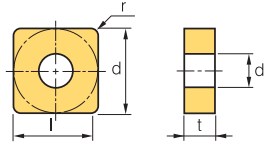

Dimensions (mm)			
Size	d	t	d ₁
12	12.7	3.18~4.76	5.16
15	15.875	4.76	-
19	19.05	4.76	-
25	25.4	7.94	-

Square **90° Negative**

Workpiece	Material	Grade	Machining types															
			●	●	●	●	●	●	●	●	●	●	●	●	●	●	●	●
Steel		P	●	●	●	●	●	●	●	●	●	●	●	●	●	●	●	
Stainless steel		M	●	●	●	●	●	●	●	●	●	●	●	●	●	●	●	
Cast iron		K	●	●	●	●	●	●	●	●	●	●	●	●	●	●	●	
Non-ferrous metal		N																
Heat resistant alloy, Titanium alloy		S																
Hardened steel		H																

● Continuous cutting
● General cutting
● Interrupted cutting

Inserts	Designation	Cermets		Coated		Coated												Uncoated		Cutting Condition										
		CN1500	CN2000	CN2500	CC1500	CC2500	NC3215	NC3120	NC3225	NC3030	NC5330	NC6310	NC6315	NC9115	NC9125	NC9135	PC5300	PC5400	PC8105	PC8110	PC8115	PC9030	H01	H05	f _n (mm/rev)	a _p (mm)				
Medium to roughing		SNMN	120304																							0.17~0.45	1.00~3.50			
			120308																									0.23~0.60	1.50~6.00	
			120312																									0.25~0.60	2.00~5.00	
			120404																									0.17~0.45	1.00~3.50	
			120408																									0.23~0.60	1.50~5.00	
			120412																									0.25~0.60	2.00~5.00	
			150404																									0.20~0.50	1.50~6.00	
			150408																										0.25~0.60	1.50~6.00
			150412																										0.25~0.60	2.00~6.00
			190416																										0.35~0.70	2.00~6.00
Medium cutting		SNMX	120408R																							0.15~0.35	1.00~4.00			
Medium to roughing		SNUN	120408																							0.23~0.60	1.50~5.00			
			120412																								0.25~0.60	2.00~5.00		
			190412																								0.30~1.00	3.00~10.00		
			120412TN																								0.25~0.60	2.00~5.00		
			250724TN																									0.30~1.20	3.00~12.00	

Cutting edge geometry **A52~A61** Recommended chip breaker **B04~B11** Code system **B26~B27** ● : Stock item

Available tool holders					
Designation	Page	Designation	Page	Designation	Page
MSBNR/L	B173	MSRNR/L	B174	PSDNN	B163
MSDNN	B173	MSSNR/L	B175	PSKNR/L	B164, 199
MSKNR/L	B174	PSBNR/L	B163	PSSNR/L	B164





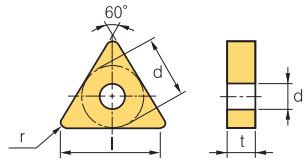

TN ○ ○

Triangular 60° Negative



Dimensions (mm)			
Size	d	t	d ₁
11	6.35	3.18	2.40
16	9.525	3.18~4.76	3.81
22	12.7	4.76	5.16
27	15.875	6.35	6.35

Workpiece	Material	Machining types															
		● Continuous cutting ● General cutting ✱ Interrupted cutting															
Steel	P	●	●	✱	●	●	●	●	●	●	●	●	●	●	●	●	●
Stainless steel	M	●	●	✱	●	●	●	●	●	●	●	●	●	●	●	●	●
Cast iron	K	●	●	✱	●	●	●	●	●	●	●	●	●	●	●	●	●
Non-ferrous metal	N																
Heat resistant alloy, Titanium alloy	S																
Hardened steel	H																

Inserts	Designation	Cermet		Coated		Coated										Uncoated		Cutting Condition											
		CN1500	CN2000	CN2500	CC1500	CC2500	NC3215	NC3120	NC3225	NC3030	NC5330	NC6310	NC6315	NC9115	NC9125	NC9135	PC5300	PC5400	PC8105	PC8110	PC8115	PC9030	H01	H05	f _n (mm/rev)	a _p (mm)			
Roughing		TNGA 110302																								0.05~0.30	0.20~3.00		
		TNGA 110304																									0.05~0.30	0.40~3.00	
		TNGA 160304																									0.10~0.35	0.40~4.00	
		TNGA 160402																									0.10~0.30	0.20~4.00	
		TNGA 160404																									0.10~0.35	0.40~5.00	
		TNGA 160408																									0.12~0.40	0.50~5.00	
		TNGA 220304																									0.10~0.35	0.50~5.00	
		TNGA 220402																										0.05~0.30	0.20~3.00
		TNGA 220404																										0.10~0.35	0.40~5.00
		TNGA 220408																										0.10~0.40	0.50~5.00
		TNGA 220412																										0.12~0.45	1.00~5.50
		TNGA 270612																										0.12~0.45	1.00~7.00
		TNGA 270624																										0.20~0.55	2.00~7.00
Finishing		TNGG 160402R-SC		●																						0.03~0.20	0.10~1.50		
		TNGG 160404R-SC		●																							0.05~0.25	0.30~2.00	
		TNGG 160402L-SC																									0.03~0.20	0.10~1.50	
		TNGG 160404L-SC																									0.05~0.25	0.30~2.00	
Medium cutting		TNGG 110304R																								0.05~0.30	0.50~2.50		
		TNGG 160402R			●																						0.08~0.30	0.50~3.50	
		TNGG 160404R		●	●																						0.12~0.30	1.00~3.50	
		TNGG 160408R			●																						0.15~0.35	1.30~3.50	
		TNGG 220404R			●																						0.12~0.30	1.00~5.00	
		TNGG 220408R			●																						0.15~0.35	1.30~5.00	
		TNGG 220412R																									0.17~0.40	1.50~5.00	
		TNGG 110304L																									0.05~0.30	0.50~2.50	
		TNGG 160402L																										0.08~0.30	0.50~3.50
		TNGG 160404L		●	●																							0.12~0.30	1.00~3.50
		TNGG 160408L			●																							0.15~0.35	1.30~3.50
		TNGG 220404L																										0.12~0.30	1.00~5.00
		TNGG 220408L																										0.15~0.35	1.30~5.00
TNGG 220412L																										0.17~0.40	1.50~5.00		
Medium cutting		TNGG 160404-VP3																	●	●	●	●	●		0.05~0.30	0.10~3.00			
		TNGG 160408-VP3																		●	●	●	●	●		0.10~0.45	0.50~5.00		

↻ Cutting edge geometry **A52~A61**
 ↻ Recommended chip breaker **B04~B11**
 ↻ Code system **B26~B27**
 ● : Stock item

Available tool holders					
Designation	Page	Designation	Page	Designation	Page
MTENN	B175	PTFNR/L	B165, 199	WTJNR/L	B167
MTFNR/L	B175	PTGNR/L	B165	WTXNR/L	B167
MTGNR/L	B176	PTTNR/L	B166		
MTJNR/L	B176	WTENN	B167		

B Turning Insert (Negative)

TN ○ ○

Triangular 60° Negative

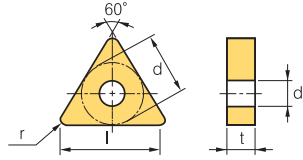

Dimensions (mm)			
Size	d	t	d ₁
11	6.35	3.18	2.40
16	9.525	3.18~4.76	3.81
22	12.7	4.76	5.16
27	15.875	6.35	6.35
33	19.05	9.52	7.93

Workpiece	Material	Machining types															
		●	●	●	●	●	●	●	●	●	●	●	●	●	●	●	●
Steel	P	●	●	●	●	●	●	●	●	●	●	●	●	●	●	●	
Stainless steel	M	●	●	●	●	●	●	●	●	●	●	●	●	●	●	●	
Cast iron	K	●	●	●	●	●	●	●	●	●	●	●	●	●	●	●	
Non-ferrous metal	N	●	●	●	●	●	●	●	●	●	●	●	●	●	●	●	
Heat resistant alloy, Titanium alloy	S	●	●	●	●	●	●	●	●	●	●	●	●	●	●	●	
Hardened steel	H	●	●	●	●	●	●	●	●	●	●	●	●	●	●	●	

Inserts	Designation	Cermets		Coated		Coated										Uncoated		Cutting Condition										
		CN1500	CN2000	CN2500	CC1500	CC2500	NC3215	NC3120	NC3225	NC3030	NC5330	NC6310	NC6315	NC9115	NC9125	NC9135	PC5300	PC5400	PC8105	PC8110	PC8115	PC9030	H01	H05	f _n (mm/rev)	a _p (mm)		
Medium cutting	TNGN	110302																								0.05-0.25	0.20-2.50	
		110304																									0.10-0.30	0.50-2.50
		110308																									0.10-0.30	0.80-2.50
		160302																									0.05-0.30	0.20-3.00
		160304																									0.10-0.30	0.50-4.00
		160308																									0.10-0.40	0.80-4.00
		160404																									0.10-0.40	0.50-4.00
		160408																									0.10-0.40	1.00-4.00
		160412																									0.10-0.50	1.50-4.50
		220404																									0.10-0.35	1.00-4.00
		220408																									0.15-0.40	1.50-5.00
		220412																									0.20-0.50	1.50-5.00
		220416																									0.25-0.55	1.50-5.00
		220424																									0.30-0.65	2.00-5.00
	270630																									0.35-0.70	2.00-5.00	
Roughing	TNMA	110308																								0.05-0.30	0.50-3.00	
		160404										●	●													0.10-0.30	1.00-4.00	
		160408										●	●													0.10-0.40	1.00-4.00	
		160412										●														0.10-0.50	1.50-4.50	
		160416										●														0.15-0.55	1.50-4.50	
		220404																								0.10-0.35	1.00-4.00	
		220408											●													0.15-0.40	1.50-5.00	
		220412											●													0.20-0.50	1.50-5.00	
		220416											●													0.25-0.55	1.50-5.00	
		220420																								0.30-0.65	2.00-5.00	
		220432																								0.35-0.70	2.00-5.00	
		270608																								0.20-0.45	2.00-7.00	
		270612																								0.25-0.55	3.00-7.00	
	270616																								0.30-0.65	3.00-7.00		
	330924																								0.35-0.75	3.00-9.00		
Finishing	TNMG	160404-VB	●		●	●	●	●	●	●																0.10-0.35	0.30-1.50	
		160408-VB	●		●	●	●	●	●	●	●															0.15-0.45	0.50-7.00	
		160412-VB						●	●	●																0.15-0.45	0.50-2.50	
		220408-VB							●	●																0.15-0.45	0.50-2.50	
		220412-VB								●	●															0.20-0.50	0.70-2.50	

➤ Cutting edge geometry A52~A61
 ➤ Recommended chip breaker B04~B11
 ➤ Code system B26~B27
 ● : Stock item

Available tool holders					
Designation	Page	Designation	Page	Designation	Page
MTENN	B175	PTFNR/L	B165, 199	WTJNR/L	B167
MTFNR/L	B175	PTGNR/L	B165	WTXNR/L	B167
MTGNR/L	B176	PTTNR/L	B166		
MTJNR/L	B176	WTENN	B167		



TN ○○

Triangular 60° Negative

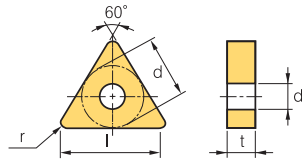

Dimensions (mm)			
Size	d	t	d ₁
11	6.35	3.18	2.40
16	9.525	4.76	3.81
22	12.7	4.76	5.16

Workpiece	Material Groups														Machining types			
	Steel	Stainless steel	Cast iron	Non-ferrous metal	Heat resistant alloy, Titanium alloy	Hardened steel	P	M	K	N	S	H	○	●		⊖		
Steel							●	●	●	●	●	●	●	●	●			● Continuous cutting ● General cutting ⊖ Interrupted cutting
Stainless steel																		
Cast iron																		
Non-ferrous metal																		
Heat resistant alloy, Titanium alloy																		
Hardened steel																		

Inserts	Designation	Cermet		Coated		Coated											Uncoated		Cutting Condition								
		CN1500	CN2000	CN2500	CC1500	CC2500	NC3215	NC3120	NC3225	NC3030	NC5330	NC6310	NC6315	NC9115	NC9125	NC9135	PC5300	PC5400	PC8105	PC8110	PC8115	PC9030	H01	H05	f _n (mm/rev)	a _p (mm)	
Finishing 	TNMG 160404-VL	●					●																			0.05~0.25	0.10~1.00
	160408-VL	●					●	●		●																0.10~0.35	0.20~1.50
	160412-VL						●																			0.15~0.40	0.20~1.50
	220408-VL																									0.10~0.35	0.20~1.50
	220412-VL																									0.10~0.35	0.50~2.00
Finishing 	TNMG 110304-VF	●	●							●																0.05~0.20	0.20~1.00
	160404-VF	●						●		●									●							0.07~0.30	0.50~1.50
	160408-VF						●	●		●																0.10~0.40	0.50~1.50
	160412-VF																									0.15~0.50	0.50~1.50
	220404-VF																					●				0.10~0.40	0.50~1.50
	220408-VF																									0.10~0.40	0.50~1.50
Finishing [wiper]	TNMG 160404-VW																									0.10~0.35	0.30~3.00
	160408-VW																									0.10~0.40	0.30~3.00
Medium to finishing 	TNMG 160404-HA																			●	●	●				0.05~0.30	0.80~3.50
	160408-HA																			●	●	●				0.10~0.40	0.80~3.50
	160412-HA																									0.13~0.55	0.80~3.50
	220408-HA																					●				0.10~0.40	0.80~5.30
Medium to finishing 	TNMG 110304-LP																									0.07~0.30	0.30~1.50
	110308-LP																									0.10~0.30	0.30~1.50
	160404-LP							●	●	●																0.10~0.35	0.30~2.00
	160408-LP							●	●	●																0.10~0.40	0.50~2.50
	160412-LP							●	●																	0.13~0.45	0.80~3.00
Medium to finishing 	TNMG 160404-VC							●	●	●																0.10~0.35	0.30~2.00
	160408-VC							●	●	●																0.15~4.00	0.50~3.00
	160412-VC							●	●	●																0.15~4.50	0.50~3.00
	220408-VC							●	●																	0.15~0.40	0.50~3.00
	220412-VC							●	●																	0.15~0.45	0.50~3.00
Medium to finishing 	TNMG 160404-VP2																●	●	●	●	●	●	●			0.05~0.30	0.10~3.00
	160408-VP2																●	●	●	●	●	●	●			0.10~0.45	0.50~5.00
	160412-VP2																●	●	●	●	●	●	●			0.13~0.55	0.80~3.30
	220404-VP2																●	●		●						0.05~0.30	0.80~5.00
	220408-VP2																●	●		●						0.10~0.40	0.80~5.00

Cutting edge geometry A52~A61
 Recommended chip breaker B04~B11
 Code system B26~B27
 ● : Stock item

Available tool holders					
Designation	Page	Designation	Page	Designation	Page
MTENN	B175	PTFNR/L	B165, 199	WTJNR/L	B167
MTFNR/L	B175	PTGNR/L	B165	WTXNR/L	B167
MTGNR/L	B176	PTTNR/L	B166		
MTJNR/L	B176	WTENN	B167		

B Turning Insert (Negative)



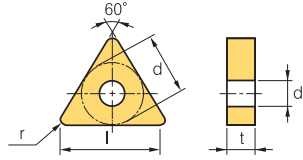

TN ○ ○

Triangular 60° Negative



Dimensions (mm)			
Size	d	t	d ₁
11	6.35	3.18	2.40
16	9.525	3.18~4.76	3.81
22	12.7	4.76	5.16
27	15.875	6.35	6.35

Workpiece	Machining types															
	P	M	K	N	S	H										
Steel	●	●	●	●	●	●	●	●	●	●	●	●	●	●	●	●
Stainless steel	●	●	●	●	●	●	●	●	●	●	●	●	●	●	●	●
Cast iron	●	●	●	●	●	●	●	●	●	●	●	●	●	●	●	●
Non-ferrous metal	●	●	●	●	●	●	●	●	●	●	●	●	●	●	●	●
Heat resistant alloy, Titanium alloy	●	●	●	●	●	●	●	●	●	●	●	●	●	●	●	●
Hardened steel	●	●	●	●	●	●	●	●	●	●	●	●	●	●	●	●

Inserts	Designation	Cermets		Coated		Coated										Uncoated		Cutting Condition								
		CN1500	CN2000	CN2500	CC1500	CC2500	NC3215	NC3120	NC3225	NC3030	NC5330	NC6310	NC6315	NC9115	NC9125	NC9135	PC5300	PC5400	PC8105	PC8110	PC8115	PC9030	H01	H05	f _n (mm/rev)	a _p (mm)
Medium to finishing  [Cermets]	TNMG 110304-VQ																								0.05~0.30	0.50~3.00
	160404-VQ	●	●	●	●	●																			0.05~0.30	0.80~3.50
	160408-VQ	●		●	●	●																			0.08~0.40	0.80~3.50
	160412-VQ																								0.10~0.40	0.80~3.50
	220404-VQ																								0.05~0.35	0.80~4.00
Medium cutting 	TNMG 110308-HM							●																	0.17~0.40	1.50~3.00
	160404-HM							●	●	●						●						●			0.05~0.30	0.90~4.00
	160408-HM						●	●	●	●													●		0.10~0.50	1.00~4.00
	160412-HM																						●		0.13~0.60	1.30~4.00
	220404-HM							●	●	●															0.15~0.45	0.60~5.00
220408-HM								●																0.18~0.48	0.80~5.80	
Medium cutting 	TNMG 160404-MK											●	●												0.05~0.30	0.90~3.50
	160408-MK												●												0.10~0.50	1.00~4.00
	160412-MK												●												0.12~0.60	1.20~4.50
	160416-MK												●												0.13~0.60	1.20~4.50
	220404-MK																								0.17~0.45	1.50~5.00
	220408-MK																								0.21~0.50	1.30~5.50
	220412-MK																								0.23~0.52	1.40~5.50
	220416-MK																								0.25~0.53	1.60~6.00
270612-MK																								0.25~0.55	3.00~7.00	
Medium cutting 	TNMG 160404-MM												●	●	●	●				●	●	●			0.10~0.40	0.50~4.80
	160408-MM												●	●	●	●				●	●	●			0.12~0.45	0.50~4.80
	160412-MM													●	●	●						●			0.18~0.65	0.50~4.80
	160416-MM													●	●	●							●		0.18~0.65	0.50~4.80
	220404-MM																								0.10~0.40	0.50~6.50
	220408-MM													●	●	●						●	●		0.12~0.45	0.50~6.50
	220412-MM													●	●	●						●	●		0.15~0.60	0.50~6.50
	220416-MM														●	●	●					●	●		0.18~0.65	0.50~6.50
Medium cutting 	TNMG 110308-MP						●	●																	0.15~0.42	0.50~3.50
	160404-MP						●	●	●	●			●	●	●				●	●					0.10~0.40	0.40~3.50
	160408-MP						●	●	●	●			●	●	●				●	●					0.15~0.45	0.50~4.00
	160412-MP						●	●	●	●			●	●	●				●	●					0.15~0.50	0.80~4.50
	160616-MP																								0.18~0.50	1.00~4.50
	220404-MP						●	●	●	●			●	●	●										0.10~0.35	0.40~5.00
	220408-MP						●	●	●	●			●	●	●										0.15~0.45	0.50~5.50
	220412-MP						●	●	●	●			●	●	●										0.15~0.50	0.80~6.00
	220416-MP						●	●	●	●															0.20~0.55	1.00~6.00
	270612-MP																								0.28~0.60	1.20~8.00

➤ Cutting edge geometry A52~A61
➤ Recommended chip breaker B04~B11
➤ Code system B26~B27
● : Stock item

Available tool holders					
Designation	Page	Designation	Page	Designation	Page
MTENN	B175	PTFNR/L	B165, 199	WTJNR/L	B167
MTFNR/L	B175	PTGNR/L	B165	WTXNR/L	B167
MTGNR/L	B176	PTTNR/L	B166		
MTJNR/L	B176	WTENN	B167		



TN ○ ○

Triangular 60° Negative

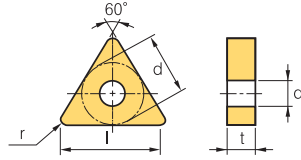

Dimensions (mm)			
Size	d	t	d ₁
11	6.35	3.18	2.40
16	9.525	4.76	3.81
22	12.7	4.76	5.16
27	15.875	6.35	6.35
33	19.05	7.94~9.52	7.93

Workpiece	Machining types															
	P	M	K	N	S	H										
Steel	●	●	●	●	●	●	●	●	●	●	●	●	●	●	●	●
Stainless steel	●	●	●	●	●	●	●	●	●	●	●	●	●	●	●	●
Cast iron	●	●	●	●	●	●	●	●	●	●	●	●	●	●	●	●
Non-ferrous metal	●	●	●	●	●	●	●	●	●	●	●	●	●	●	●	●
Heat resistant alloy, Titanium alloy	●	●	●	●	●	●	●	●	●	●	●	●	●	●	●	●
Hardened steel	●	●	●	●	●	●	●	●	●	●	●	●	●	●	●	●

Inserts	Designation	Cermet		Coated		Coated										Uncoated		Cutting Condition									
		CN1500	CN2000	CN2500	CC1500	CC2500	NC3215	NC3120	NC3225	NC3030	NC5330	NC6310	NC6315	NC9115	NC9125	NC9135	PC5300	PC5400	PC8105	PC8110	PC8115	PC9030	H01	H05	f _n (mm/rev)	a _p (mm)	
Medium cutting	VM	TNMG 110308-VM																								0.05~0.30	0.80~4.00
		160404-VM	●					●	●	●	●						●	●								0.05~0.30	0.90~5.00
		160408-VM	●		●			●	●	●	●	●					●	●					●			0.10~0.50	1.00~5.00
		160412-VM	●					●	●								●	●								0.13~0.60	1.30~5.00
		220404-VM															●	●								0.05~0.30	0.90~6.60
		220408-VM							●			●					●	●			●					0.10~0.50	1.00~6.60
		220412-VM																●	●			●				0.13~0.60	1.30~6.60
Medium cutting	VP3	TNMG 160404-VP3															●	●	●	●	●		●	●	0.05~0.30	0.10~3.00	
		160408-VP3															●	●	●	●	●		●	●	0.10~0.45	0.50~5.00	
		160412-VP3																								0.20~0.40	0.50~3.50
		220404-VP3																								0.20~0.30	0.80~4.00
		220408-VP3																								0.25~0.35	0.80~5.00
		220412-VP3																								0.30~0.40	1.00~5.00
		220416-VP3																								0.30~0.40	1.00~5.00
Medium cutting	LW	TNMG 160408-LW																							0.15~0.50	0.70~4.50	
		160412-LW																							0.20~0.60	1.00~5.00	
General	B25	TNMG 110308-B25																							0.17~0.40	1.50~3.00	
		160404-B25	●		●			●	●	●	●												●		0.17~0.45	2.00~3.50	
		160408-B25	●		●			●	●	●	●														0.17~0.55	2.00~3.50	
		160412-B25			●			●	●	●	●														0.25~0.55	2.00~3.50	
		160416-B25																								0.30~0.60	2.50~3.00
		220404-B25							●	●	●	●														0.17~0.45	1.50~5.00
		220408-B25							●	●	●	●														0.17~0.55	2.00~5.00
		220412-B25							●	●	●	●														0.25~0.55	2.00~5.00
		220416-B25							●	●	●	●														0.30~0.60	2.00~5.00
		220424-B25																								0.35~0.70	3.00~7.00
		220432-B25																								0.40~0.75	3.50~7.00
		270608-B25											●													0.17~0.55	2.00~5.00
		270612-B25											●	●	●											0.25~0.55	3.00~7.00
		270616-B25											●	●	●											0.30~0.60	3.00~7.00
330716-B25								●	●															0.35~0.70	3.00~9.00		
330924-B25																								0.40~0.80	3.00~9.00		

🔄 Cutting edge geometry A52~A61
🔄 Recommended chip breaker B04~B11
🔄 Code system B26~B27
● : Stock item

Available tool holders					
Designation	Page	Designation	Page	Designation	Page
MTENN	B175	PTFNR/L	B165, 199	WTJNR/L	B167
MTFNR/L	B175	PTGNR/L	B165	WTXNR/L	B167
MTGNR/L	B176	PTTNR/L	B166		
MTJNR/L	B176	WTENN	B167		



B Turning Insert (Negative)

TN ○ ○

Triangular 60° Negative

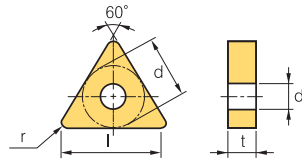

Dimensions (mm)			
Size	d	t	d ₁
16	9.525	4.76	3.81
22	12.7	4.76	5.16
27	15.875	6.35	6.35
33	19.05	7.94~9.52	7.93

Workpiece	Material		Machining types																
	Symbol	Code	●	◐	◑	●	◐	◑	●	◐	◑	●	◐	◑	●	◐	◑	●	◐
Steel	P	●	◐	◑	●	◐	◑	●	◐	◑	●	◐	◑	●	◐	◑	●	◐	◑
Stainless steel	M	●	◐	◑	●	◐	◑	●	◐	◑	●	◐	◑	●	◐	◑	●	◐	◑
Cast iron	K	●	◐	◑	●	◐	◑	●	◐	◑	●	◐	◑	●	◐	◑	●	◐	◑
Non-ferrous metal	N	●	◐	◑	●	◐	◑	●	◐	◑	●	◐	◑	●	◐	◑	●	◐	◑
Heat resistant alloy, Titanium alloy	S	●	◐	◑	●	◐	◑	●	◐	◑	●	◐	◑	●	◐	◑	●	◐	◑
Hardened steel	H	●	◐	◑	●	◐	◑	●	◐	◑	●	◐	◑	●	◐	◑	●	◐	◑

● Continuous cutting
◐ General cutting
◑ Interrupted cutting

Inserts	Designation	Cermet		Coated		Coated												Uncoated		Cutting Condition								
		CN1500	CN2000	CN2500	CC1500	CC2500	NC3215	NC3120	NC3225	NC3030	NC5330	NC6310	NC6315	NC9115	NC9125	NC9135	PC5300	PC5400	PC8105	PC8110	PC8115	PC9030	H01	H05	f _n (mm/rev)	a _p (mm)		
Roughing GR	TNMG 160408-GR							●	●																0.20~0.50	1.00~7.00		
	160412-GR							●																		0.23~0.54	1.20~8.00	
	220408-GR							●	●	●	●															0.22~0.61	1.10~7.80	
	220412-GR							●	●	●																0.28~0.78	1.20~7.80	
	220416-GR								●																	0.31~0.75	1.50~7.80	
	270608-GR								●																	0.31~0.75	1.50~7.80	
	270612-GR								●	●																0.31~0.75	1.50~7.80	
	270616-GR									●																	0.36~1.00	1.60~7.80
330924-GR									●																	0.40~1.00	2.00~9.00	
Roughing RK	TNMG 160408-RK											●	●													0.23~0.53	1.50~5.00	
	160412-RK											●	●														0.28~0.53	1.80~5.00
	160416-RK												●														0.28~0.53	1.80~5.00
	220408-RK												●														0.23~0.53	1.50~6.00
	220412-RK												●														0.28~0.53	1.80~6.00
	220416-RK													●													0.28~0.63	2.00~6.00
Roughing RM	TNMG 160404-RM													●	●	●	●				●	●	●			0.10~0.50	2.00~5.50	
	160408-RM													●	●	●	●				●	●	●			0.15~0.55	2.00~5.50	
	160412-RM														●	●										0.20~0.60	2.00~5.50	
	220408-RM														●	●	●					●				0.10~0.50	2.00~7.50	
	220412-RM														●	●	●					●				0.15~0.55	2.00~7.50	
	220416-RM															●	●	●								0.25~0.70	2.00~7.50	
Roughing VP4	TNMG 160408-VP4																					●				0.15~0.35	1.00~4.00	
	160412-VP4																						●			0.20~0.40	1.00~4.00	
Roughing VR	TNMG 160404-VR																									0.20~0.50	0.80~7.00	
	160408-VR																									0.25~0.55	1.20~7.00	
	160412-VR																									0.35~0.65	1.70~7.00	
	160416-VR																									0.35~0.70	2.00~10.0	
	220408-VR																									0.35~0.70	2.00~10.0	
	220412-VR																									0.35~0.70	2.00~10.0	
	220416-VR																									0.35~0.75	2.20~10.0	

➤ Cutting edge geometry A52~A61 ➤ Recommended chip breaker B04~B11 ➤ Code system B26~B27 ● : Stock item

Available tool holders					
Designation	Page	Designation	Page	Designation	Page
MTENN	B175	PTFNR/L	B165, 199	WTJNR/L	B167
MTFNR/L	B175	PTGNR/L	B165	WTXNR/L	B167
MTGNR/L	B176	PTTNR/L	B166		
MTJNR/L	B176	WTENN	B167		



TN ○ ○

Triangular 60° Negative

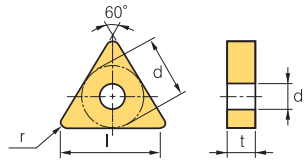

Dimensions (mm)			
Size	d	t	d ₁
16	9.525	4.76	3.81
22	12.7	4.76	5.16
27	15.875	6.35	6.35
33	19.05	7.94~9.52	7.93

Workpiece	Machining types															
	P	M	K	N	S	H										
Steel	●	●	●	●	●	●	●	●	●	●	●	●	●	●	●	●
Stainless steel	●	●	●	●	●	●	●	●	●	●	●	●	●	●	●	●
Cast iron	●	●	●	●	●	●	●	●	●	●	●	●	●	●	●	●
Non-ferrous metal	●	●	●	●	●	●	●	●	●	●	●	●	●	●	●	●
Heat resistant alloy, Titanium alloy	●	●	●	●	●	●	●	●	●	●	●	●	●	●	●	●
Hardened steel	●	●	●	●	●	●	●	●	●	●	●	●	●	●	●	●

Inserts	Designation	Cermet		Coated		Coated											Uncoated		Cutting Condition								
		CN1500	CN2000	CN2500	CC1500	CC2500	NC3215	NC3120	NC3225	NC3030	NC5330	NC6310	NC6315	NC9115	NC9125	NC9135	PC5300	PC5400	PC8105	PC8110	PC8115	PC9030	H01	H05	f _n (mm/rev)	a _p (mm)	
Roughing	GR	TNMM 220408-GR																							0.22~0.61	1.10~7.80	
		220412-GR																								0.28~0.78	1.20~7.80
		220416-GR																								0.31~0.75	1.50~7.80
Heavy	GH	TNMM 160408-GH																							0.20~0.50	1.00~7.00	
		220408-GH																								0.25~0.60	1.30~7.00
		220412-GH							●																	0.20~0.50	1.00~8.00
		220416-GH																								0.25~0.60	1.30~8.00
		270616-GH																								0.32~0.70	1.80~8.00
		270624-GH																								0.35~0.50	1.80~13.00
		330924-GH																								0.35~0.70	2.30~13.00
Medium to roughing	[Shaft]	TNMM 160408																							0.10~0.30	1.00~4.00	
		220408		●																					0.15~0.40	1.50~5.00	
		220412																							0.20~0.50	1.50~5.00	
Finishing	SR	TNMX 160404R-SR																							0.10~0.35	0.70~3.50	
		160408R-SR																							0.12~0.40	1.00~3.50	
		160404L-SR																							0.10~0.35	0.70~3.50	
		160408L-SR																							0.12~0.40	1.00~3.50	
Medium cutting	SH	TNMX 160404R-SH					●	●																	0.15~0.30	0.50~4.00	
		160408R-SH					●	●																	0.15~0.45	1.00~4.00	
		160404L-SH					●	●																	0.15~0.30	0.50~4.00	
		160408L-SH					●	●																	0.15~0.45	1.00~4.00	
Medium to roughing	[Shaft]	TNMX 160402R		●	●																				0.10~0.30	0.50~3.00	
		160404R		●				●	●	●	●														0.12~0.30	1.00~3.50	
		160408R						●	●	●															0.15~0.35	1.30~3.40	
		220404R							●	●	●														0.12~0.30	1.00~5.00	
		220408R								●	●	●													0.15~0.35	1.30~5.00	
		160404L							●	●	●														0.12~0.30	1.00~3.50	
		160408L								●	●														0.15~0.35	1.30~3.40	

Cutting edge geometry **A52~A61**
 Recommended chip breaker **B04~B11**
 Code system **B26~B27**
 ● : Stock item

Available tool holders					
Designation	Page	Designation	Page	Designation	Page
MTENN	B175	PTFNR/L	B165, 199	WTJNR/L	B167
MTFNR/L	B175	PTGNR/L	B165	WTXNR/L	B167
MTGNR/L	B176	PTTNR/L	B166		
MTJNR/L	B176	WTENN	B167		



B Turning Insert (Negative)

VN○○○

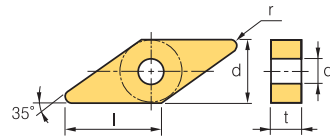

Dimensions (mm)			
Size	d	t	d ₁
16	9.525	4.76	3.81

Rhombic **35° Negative**

Workpiece			Machining types															
	Steel	▶ P	●	⊖	⊕	●	⊖	⊕	●	⊖	⊕	●	⊖	⊕	●	⊖	⊕	
Stainless steel		▶ M											⊕	⊕		●	●	●
Cast iron		▶ K														●	●	●
Non-ferrous metal		▶ N															●	●
Heat resistant alloy, Titanium alloy		▶ S														●	●	●
Hardened steel		▶ H															●	●

● Continuous cutting
 ⊖ General cutting
 ⊕ Interrupted cutting

	Inserts	Designation	Cermet		Coated		Coated										Uncoated		Cutting Condition								
			CN1500	CN2000	CN2500	CC1500	CC2500	NC3215	NC3120	NC3225	NC3030	NC5330	NC6310	NC6315	NC9115	NC9125	NC9135	PC5300	PC5400	PC8105	PC8110	PC8115	PC9030	H01	H05	f _n (mm/rev)	a _p (mm)
Medium to finishing	HA	VNKG 160408-HA																		●						0.10-0.40	0.80-3.50
Medium cutting	VP3	VNKG 160404-VP3																		●	●	●	●			0.05-0.30	0.10-3.00
		160408-VP3																								0.10-0.45	0.50-5.00
Finishing	VB	VNMG 160404-VB	●	●	●	●	●	●	●																0.10-0.35	0.30-1.50	
		160408-VB	●	●	●	●	●	●	●																0.15-0.45	0.50-2.00	
		160412-VB					●	●	●																0.20-0.45	0.80-2.50	
Finishing	VF	VNMG 160402-VF		●				●	●																0.06-0.20	0.30-1.00	
		160404-VF	●	●				●	●											●					0.08-0.30	0.50-1.50	
		160408-VF	●					●	●	●															0.10-0.40	0.50-1.50	
		160412-VF																							0.15-0.50	0.50-1.50	
Finishing	VL	VNMG 160404-VL	●	●			●	●	●																0.05-0.20	0.10-1.00	
		160408-VL	●	●			●	●	●																0.10-0.25	0.20-1.50	
		160412-VL					●	●	●																0.15-0.30	0.50-2.00	
Medium to finishing	HA	VNMG 160404-HA																					●	0.08-0.35	0.50-3.00		
		160408-HA																						●	0.10-0.40	0.80-3.50	
Medium to finishing	LP <small>new</small>	VNMG 160404-LP					●	●																0.10-0.35	0.30-1.50		
		160408-LP					●	●																	0.10-0.40	0.50-2.00	
		160412-LP					●	●																	0.10-0.45	0.80-2.50	
Medium to finishing	VC	VNMG 160404-VC	●			●	●	●																0.10-0.35	0.30-2.00		
		160408-VC	●			●	●	●																0.15-4.00	0.50-3.00		
		160412-VC					●	●																0.15-0.40	0.80-3.00		

Cutting edge geometry A52~A61
 Recommended chip breaker B04~B11
 Code system B26~B27
 ● : Stock item

Available tool holders			
Designation	Page	Designation	Page
MVJNR/L	B176	MVVNN	B177
MVQNR/L	B177	MVUNR/L	B203



VN ○ ○

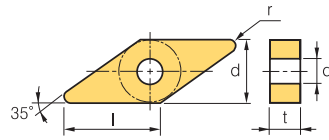

Dimensions (mm)			
Size	d	t	d ₁
16	9.525	4.76	3.81
22	12.7	4.76	5.16

Rhombic **35° Negative**

Workpiece	Steel	P	●	●	●	●	●	●	●	●	●	●	●	●	●	●	●	●	●	●	Machining types		
	Stainless steel	M	●	●	●	●	●	●	●	●	●	●	●	●	●	●	●	●	●	●	●	●	●
Cast iron	K	●	●	●	●	●	●	●	●	●	●	●	●	●	●	●	●	●	●	●	●	●	●
Non-ferrous metal	N																						
Heat resistant alloy, Titanium alloy	S																						
Hardened steel	H																						

● Continuous cutting
 ● General cutting
 ● Interrupted cutting

Inserts	Designation	Cermets		Coated		Coated													Uncoated		Cutting Condition								
		CN1500	CN2000	CN2500	CC1500	CC2500	NC3215	NC3120	NC3225	NC3030	NC5330	NC6310	NC6315	NC9115	NC9125	NC9135	PC5300	PC5400	PC8105	PC8110	PC8115	PC9030	H01	H05	f _n (mm/rev)	a _p (mm)			
Medium to finishing VQ [Cermets]	VNMG 160404-VQ	●	●	●	●	●	●	●	●	●	●	●	●	●	●	●	●	●	●	●	●	●	●	●	●	0.10~0.40	0.50~3.50		
	VNMG 160408-VQ	●	●	●	●	●	●	●	●	●	●	●	●	●	●	●	●	●	●	●	●	●	●	●	●	0.12~0.45	0.50~3.50		
	VNMG 160412-VQ	●	●	●	●	●	●	●	●	●	●	●	●	●	●	●	●	●	●	●	●	●	●	●	●	0.15~0.45	0.80~3.50		
Medium cutting HM	VNMG 160404-HM						●		●																	0.13~0.40	0.80~3.80		
	VNMG 160408-HM						●		●																		0.20~0.45	0.80~4.50	
	VNMG 160412-HM							●																			0.10~0.60	1.00~4.00	
Medium cutting MK <i>new</i>	VNMG 160404-MK													●													0.08~0.45	0.50~3.00	
	VNMG 160408-MK												●	●													0.10~0.50	1.00~3.50	
	VNMG 160412-MK												●														0.20~0.50	1.50~4.00	
Medium cutting MM <i>new</i>	VNMG 160404-MM													●	●	●						●	●				0.10~0.40	0.50~4.80	
	VNMG 160408-MM													●	●	●						●	●				0.12~0.45	0.50~4.80	
	VNMG 160412-MM																						●	●				0.15~0.60	0.50~4.00
Medium cutting MP <i>new</i>	VNMG 160404-MP						●		●		●		●	●	●					●	●						0.10~0.40	0.40~3.50	
	VNMG 160408-MP						●		●		●		●	●	●					●	●						0.15~0.45	0.50~4.00	
	VNMG 160412-MP						●		●		●		●										●	●				0.15~0.50	0.80~4.50
	VNMG 160616-MP																											0.18~0.50	1.00~4.50
Medium cutting RM <i>new</i>	VNMG 160404-RM																										0.10~0.50	2.00~5.00	
	VNMG 160408-RM																										0.15~0.55	2.00~5.00	
	VNMG 160412-RM																										0.20~0.60	2.00~5.00	
Medium cutting VM	VNMG 160404-VM	●								●	●					●	●										0.08~0.45	0.50~3.50	
	VNMG 160408-VM	●								●	●	●	●			●	●					●	●				0.10~0.50	1.00~4.00	
	VNMG 160412-VM																										0.20~0.50	1.50~4.00	
	VNMG 220404-VM																										0.08~0.45	1.00~5.00	
	VNMG 220408-VM																										0.10~0.50	1.50~5.00	
Medium cutting VP3	VNMG 160404-VP3																						●		●	0.05~0.30	0.10~3.00		
	VNMG 160408-VP3																						●	●	●	0.10~0.45	0.50~5.00		
	VNMG 160412-VP3																						●	●	●	0.20~0.40	0.50~3.50		

↻ Cutting edge geometry **A52~A61** ⚙ Recommended chip breaker **B04~B11** 🔑 Code system **B26~B27** ● : Stock item

Available tool holders			
Designation	Page	Designation	Page
MVJNR/L	B176	MVVNN	B177
MVQNR/L	B177	MVUNR/L	B203

B Turning Insert (Negative)

WN○○○

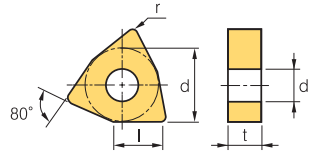

Dimensions (mm)			
Size	d	t	d ₁
06	9.525	4.76	3.81
08	12.7	4.76	5.16

Trigon 80° Negative

Workpiece	Material		Machining types																			
	Symbol	Code	1	2	3	4	5	6	7	8	9	10	11	12	13	14	15	16	17	18	19	20
Steel		P	●	●	●	●	●	●	●	●	●	●	●	●	●	●	●	●	●	●	●	●
Stainless steel		M	●	●	●	●	●	●	●	●	●	●	●	●	●	●	●	●	●	●	●	●
Cast iron		K	●	●	●	●	●	●	●	●	●	●	●	●	●	●	●	●	●	●	●	●
Non-ferrous metal		N																				
Heat resistant alloy, Titanium alloy		S																				
Hardened steel		H																				

● Continuous cutting
 ● General cutting
 ● Interrupted cutting

Inserts	Designation	Cermets		Coated		Coated												Uncoated		Cutting Condition									
		CN1500	CN2000	CN2500	CC1500	CC2500	NC3215	NC3120	NC3225	NC3030	NC5330	NC6310	NC6315	NC9115	NC9125	NC9135	PC5300	PC5400	PC8105	PC8110	PC8115	PC9030	H01	H05	f _n (mm/rev)	a _p (mm)			
Medium cutting	VP3	WNGG	080404-VP3																							0.10-0.45	0.50-5.00		
Roughing		WNMA	060404																							0.10-0.30	0.50-3.00		
			060408																								0.10-0.30	0.50-3.00	
			060412																									0.10-0.40	1.00-3.00
			080404																									0.15-0.60	1.00-5.00
			080408																									0.15-0.60	1.00-6.00
			080412																									0.15-0.70	1.50-6.00
			080416																									0.15-0.70	1.50-6.00
Finishing	VB	WNMG	080404-VB						●	●	●															0.10-0.35	0.30-1.50		
			080408-VB						●	●	●																0.15-0.45	0.50-2.00	
			080412-VB						●	●																	0.18-0.45	0.80-2.50	
Finishing	VF	WNMG	060404-VF		●							●														0.07-0.30	0.50-1.50		
			060408-VF																								0.10-0.40	0.50-1.50	
			080404-VF							●			●														0.07-0.30	0.50-1.50	
			080408-VF										●														0.10-0.40	0.50-1.50	
			080412-VF																									0.20-0.50	0.50-1.50
Finishing	VL	WNMG	060404-VL																							0.05-0.25	0.20-1.50		
			080404-VL																								0.05-0.25	0.10-1.00	
			080408-VL								●	●															0.10-0.35	0.20-1.50	
Finishing	VW	WNMG	060404-VW																							0.05-0.30	0.40-3.00		
			060408-VW																								0.08-0.30	0.40-3.50	
			080404-VW																								0.10-0.30	0.50-3.00	
			080408-VW																								0.15-0.50	0.50-4.00	
			080412-VW																									0.18-0.50	1.00-4.00
Medium to finishing	HA	WNMG	060404-HA																				●	●	0.05-0.30	0.10-3.00			
			060408-HA																					●	●	0.10-0.40	0.80-3.50		
			080404-HA																						●	●	0.05-0.30	0.80-3.50	
			080408-HA																						●	●	0.10-0.40	0.80-3.50	
			080412-HA																							●	●	0.13-0.55	0.80-3.50

Cutting edge geometry A52~A61
 Recommended chip breaker B04~B11
 Code system B26~B27
 ● : Stock item

Available tool holders			
Designation	Page	Designation	Page
MWLN/L	B177	WWLN/L	B168
PWLN/L	B200		



WN○○○

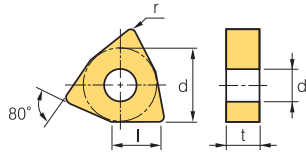

Dimensions (mm)			
Size	d	t	d ₁
06	9.525	4.76	3.81
08	12.7	4.76	5.16

Trigon **80° Negative**

Workpiece	Steel	P	●	●	●	●	●	●	●	●	●	●	●	●	●	●	●	●	●	●	●	Machining types		
	Stainless steel	M																						● Continuous cutting
	Cast iron	K	●	●	●	●																		● General cutting
	Non-ferrous metal	N																						✱ Interrupted cutting
	Heat resistant alloy, Titanium alloy	S																						
	Hardened steel	H																						

Inserts	Designation	Cermets		Coated		Coated														Uncoated		Cutting Condition						
		CN1500	CN2000	CN2500	CC1500	CC2500	NC3215	NC3120	NC3225	NC3030	NC5330	NC6310	NC6315	NC9115	NC9125	NC9135	PC5300	PC5400	PC8105	PC8110	PC8115	PC9030	H01	H05	f _n (mm/rev)	a _p (mm)		
Medium to finishing	LP new	WNMG 06T308-LP																								0.70~0.30	0.30~1.50	
		060404-LP																									0.07~0.30	0.30~1.50
		060408-LP						●	●																		0.10~0.30	0.30~1.50
		080404-LP						●	●	●																	0.10~0.35	0.30~2.00
		080408-LP						●	●	●																	0.10~0.40	0.50~2.50
		080412-LP						●	●	●																		0.13~0.45
Medium to finishing	VC 	WNMG 080404-VC					●	●																		0.15~0.40	0.15~4.00	
		080408-VC					●	●																		0.15~0.45	0.15~4.50	
		080412-VC					●	●	●																		0.15~0.45	0.15~4.50
Medium to finishing	VP2 	WNMG 080404-VP2															●	●		●						0.10~0.45	0.50~5.00	
		080408-VP2								●							●	●	●	●	●			●		0.12~0.50	0.50~5.00	
		080412-VP2															●	●	●	●	●			●		0.05~0.30	0.10~3.00	
Medium to finishing	VQ [Cermets]	WNMG 060404-VQ																									0.05~0.30	0.50~4.00
		060408-VQ																									0.08~0.30	0.80~4.00
		060412-VQ																									0.10~0.30	1.00~4.00
		080404-VQ	●	●	●	●																					0.05~0.30	0.50~4.00
		080408-VQ	●	●	●	●																						0.08~0.40
Medium cutting	HM 	WNMG 060404-HM																									0.15~0.43	0.42~3.00
		060408-HM						●	●																●	0.10~0.50	1.00~4.00	
		080404-HM						●	●	●																●	0.15~0.42	0.50~4.20
		080408-HM						●	●	●	●	●														●	0.10~0.50	1.00~5.00
		080412-HM																								●	0.10~0.50	1.00~5.00
Medium cutting	MK new	WNMG 060408-MK																									0.08~0.30	0.80~2.50
		080404-MK																									0.10~0.45	1.00~3.00
		080408-MK																									0.10~0.50	1.00~3.50
		080412-MK																									0.10~0.50	1.00~4.00
		080416-MK																									0.13~0.50	1.20~4.20
Medium cutting	MM new	WNMG 06T304-MM																									0.08~0.35	0.50~4.00
		06T308-MM																									0.10~0.40	0.50~4.00
		06T312-MM																									0.12~0.45	0.50~4.00
		060404-MM																									0.08~0.35	0.50~4.00
		060408-MM																●	●							●	0.10~0.40	0.50~4.00
		060412-MM																●	●							●	0.12~0.45	0.50~4.00
		080404-MM																●	●	●						●	0.10~0.40	0.50~4.00
		080408-MM																●	●	●	●					●	0.12~0.45	0.50~4.00
080412-MM																●	●	●	●					●	0.15~0.60	0.50~4.00		

↻ Cutting edge geometry A52~A61 ↻ Recommended chip breaker B04~B11 ↻ Code system B26~B27 ● : Stock item

Available tool holders			
Designation	Page	Designation	Page
MWLNRL	B177	WWLNRL	B168
PWLNRL	B200		



B Turning Insert (Negative)

WN○○○

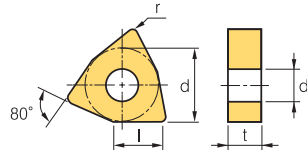

Dimensions (mm)			
Size	d	t	d ₁
06	9.525	4.76	3.81
08	12.7	4.76	5.16
13	19.05	6.35	7.93

Trigon 80° Negative

Workpiece	Machining types												
	P	M	K	N	S	H							
Steel	●	●	●	●	●	●	●	●	●	●	●	●	●
Stainless steel	●	●	●	●	●	●	●	●	●	●	●	●	●
Cast iron	●	●	●	●	●	●	●	●	●	●	●	●	●
Non-ferrous metal	●	●	●	●	●	●	●	●	●	●	●	●	●
Heat resistant alloy, Titanium alloy	●	●	●	●	●	●	●	●	●	●	●	●	●
Hardened steel	●	●	●	●	●	●	●	●	●	●	●	●	●

Inserts	Designation	Cermets		Coated		Coated										Uncoated		Cutting Condition										
		CN1500	CN2000	CN2500	CC1500	CC2500	NC3215	NC3120	NC3225	NC3030	NC5330	NC6310	NC6315	NC9115	NC9125	NC9135	PC5300	PC5400	PC8105	PC8110	PC8115	PC9030	H01	H05	f _n (mm/rev)	a _p (mm)		
Medium cutting MP	WNMG 06T304-MP																									0.10-0.40	0.40-2.80	
	06T308-MP																										0.15-0.45	0.50-3.00
	060404-MP						●	●	●				●													0.10-0.40	0.40-2.80	
	060408-MP						●	●	●	●			●													0.15-0.45	0.50-3.00	
	060412-MP																									0.15-0.50	0.80-3.20	
	080404-MP						●	●	●				●	●	●				●	●	●					0.10-0.40	0.40-4.00	
	080408-MP						●	●	●				●	●	●				●	●	●					0.15-0.45	0.50-4.50	
	080412-MP						●	●	●				●	●	●				●	●						0.15-0.50	0.80-5.00	
	080416-MP						●	●	●																	0.18-0.55	0.10-5.00	
Medium cutting VM	WNMG 060404-VM									●						●	●									0.10-0.45	1.00-3.50	
	060408-VM							●	●	●						●	●									0.10-0.50	1.00-4.00	
	060412-VM																									0.13-0.60	1.30-4.00	
	080404-VM						●			●						●	●									0.05-0.30	0.90-5.00	
	080408-VM						●	●	●	●						●	●		●		●		●			0.10-0.50	1.00-5.00	
	080412-VM						●			●						●	●									0.10-0.50	1.00-5.00	
Medium cutting VP3	WNMG 060408-VP3																									0.60-0.38	0.40-3.50	
	060412-VP3																									0.60-0.38	0.40-3.50	
	080404-VP3															●	●	●	●	●		●	●			0.10-0.45	0.50-5.00	
	080408-VP3															●	●	●	●	●		●	●			0.12-0.50	0.50-5.00	
	080412-VP3															●	●	●	●	●		●	●			0.05-0.30	0.10-3.00	
	130612-VP3																									0.20-0.40	1.00-5.00	
Medium cutting LW	WNMG 060408-LW						●	●					●													0.15-0.60	0.50-3.50	
	060412-LW																									0.20-0.70	0.80-3.50	
	080408-LW						●	●	●				●													0.15-0.60	1.00-5.00	
	080412-LW																									0.20-0.70	1.00-6.00	
General B25	WNMG 080404-B25						●	●	●																	0.17-0.45	1.00-5.00	
	080408-B25						●	●	●	●																0.23-0.60	1.50-5.00	
	080412-B25						●	●	●																	0.25-0.60	2.00-5.00	
Roughing GR	WNMG 080404-GR							●	●	●	●															0.15-0.50	0.08-6.00	
	080408-GR						●	●	●	●																0.20-0.50	1.00-7.00	
	080412-GR						●	●	●	●																0.25-0.50	1.30-7.00	
	080416-GR																									0.25-0.60	1.80-6.00	

Cutting edge geometry A52~A61
 Recommended chip breaker B04~B11
 Code system B26~B27
 ● : Stock item

Available tool holders			
Designation	Page	Designation	Page
MWLN/L	B177	WWLN/L	B168
PWLN/L	B200		



WN○○○

Trigon 80° Negative

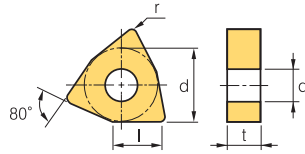

Dimensions (mm)			
Size	d	t	d ₁
06	9.525	4.76	3.81
08	12.7	4.76	5.16
10	15.875	6.35	6.35
13	19.05	6.35	7.93

Workpiece	Machining types																			
	●	●	●	●	●	●	●	●	●	●	●	●	●	●	●	●	●	●	●	●
Steel	●	●	●	●	●	●	●	●	●	●	●	●	●	●	●	●	●	●	●	●
Stainless steel	●	●	●	●	●	●	●	●	●	●	●	●	●	●	●	●	●	●	●	●
Cast iron	●	●	●	●	●	●	●	●	●	●	●	●	●	●	●	●	●	●	●	●
Non-ferrous metal	●	●	●	●	●	●	●	●	●	●	●	●	●	●	●	●	●	●	●	●
Heat resistant alloy, Titanium alloy	●	●	●	●	●	●	●	●	●	●	●	●	●	●	●	●	●	●	●	●
Hardened steel	●	●	●	●	●	●	●	●	●	●	●	●	●	●	●	●	●	●	●	●

● Continuous cutting
 ● General cutting
 ● Interrupted cutting

Inserts	Designation	Cermet		Coated		Coated														Uncoated		Cutting Condition							
		CN1500	CN2000	CN2500	CC1500	CC2500	NC3215	NC3120	NC3225	NC3030	NC5330	NC6310	NC6315	NC9115	NC9125	NC9135	PC5300	PC5400	PC8105	PC8110	PC8115	PC9030	H01	H05	f _n (mm/rev)	a _p (mm)			
	WNMG 060408-RK																									0.10~0.40	1.00~3.50		
	060412-RK																										0.23~0.40	1.50~5.00	
	080404-RK											●															0.23~0.50	1.50~6.00	
	080408-RK											●	●														0.23~0.53	1.50~6.00	
	080412-RK												●	●													0.28~0.53	1.80~6.00	
	080416-RK													●														0.25~0.60	2.00~6.00
	WNMG 060404-RM														●	●											0.10~0.50	1.50~3.00	
	060408-RM														●	●											0.15~0.55	1.50~3.00	
	060412-RM														●	●											0.20~0.60	1.50~3.00	
	080404-RM															●	●	●									0.10~0.50	2.00~4.00	
	080408-RM														●	●	●	●				●	●	●			0.15~0.55	2.00~4.00	
	080412-RM														●	●	●	●					●				0.20~0.60	2.00~4.00	
	WNMG 080408-VP4																						●			0.15~0.35	1.00~4.00		
	080412-VP4																						●				0.20~0.40	1.00~4.00	
	WNMG 060408-VR																										0.20~0.40	1.00~6.00	
	080404-VR																											0.20~0.50	0.80~7.00
	080408-VR																											0.25~0.55	1.20~7.00
	080412-VR																											0.30~0.60	1.50~7.00
	080416-VR																											0.40~0.60	1.50~4.00
	WNMM 100608-B25									●																	0.30~0.80	3.00~8.00	
	130612-B25																										0.40~0.90	4.00~10.00	
	WNMX 080404R-SR																										0.10~0.35	0.70~3.00	
	080408R-SR																											0.12~0.40	1.00~3.00
	080404L-SR																											0.10~0.35	0.70~3.00
	080408L-SR																											0.12~0.40	1.00~3.00
	WNMX 080404R-SH																										0.15~0.30	1.00~4.00	
	080408R-SH																											0.15~0.50	1.50~5.00
	080404L-SH																											0.15~0.30	1.00~4.00
	080408L-SH																											0.15~0.50	1.50~5.00

➡ Cutting edge geometry **A52~A61**
 ➡ Recommended chip breaker **B04~B11**
 ➡ Code system **B26~B27**
● : Stock item

Available tool holders			
Designation	Page	Designation	Page
MWLN/L	B177	WWLN/L	B168
PWLN/L	B200		



B Turning Insert (Positive)



Rhombic 80° Positive
Relief Angle: 7°

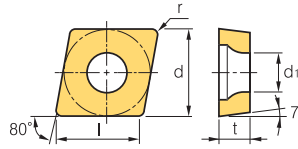

Dimensions (mm)			
Size	d	t	d ₁
03	3.5	1.39	1.9
04	4.3	1.79	2.3
06	6.35	2.38	2.8
09	9.525	3.97	4.4

Workpiece	Machining types															
	P	M	K	N	S	H										
Steel	●	●	●	●	●	●	●	●	●	●	●	●	●	●	●	●
Stainless steel	●	●	●	●	●	●	●	●	●	●	●	●	●	●	●	●
Cast iron	●	●	●	●	●	●	●	●	●	●	●	●	●	●	●	●
Non-ferrous metal	●	●	●	●	●	●	●	●	●	●	●	●	●	●	●	●
Heat resistant alloy, Titanium alloy	●	●	●	●	●	●	●	●	●	●	●	●	●	●	●	●
Hardened steel	●	●	●	●	●	●	●	●	●	●	●	●	●	●	●	●

Inserts	Designation	Cermets		Coated		Coated										Uncoated		Cutting Condition											
		CN1500	CN2000	CN2500	CC1500	CC2500	NC3215	NC3120	NC3225	NC3030	NC5330	NC6310	NC6315	NC9115	NC9125	NC9135	PC5300	PC5400	PC8105	PC8110	PC8115	PC9030	H01	H05	fn (mm/rev)	ap (mm)			
Finishing	CCET	0301005R																								0.01~0.05	0.10~0.30		
		030101R																									0.01~0.05	0.10~0.30	
		030102R																									0.01~0.05	0.10~0.30	
		030104R																									0.01~0.05	0.10~0.30	
		0401005R																									0.01~0.10	0.10~0.50	
		040101R																									0.01~0.10	0.10~0.50	
		040102R																									0.01~0.10	0.10~0.50	
		040104R																									0.01~0.10	0.10~0.50	
		0301005L																										0.01~0.05	0.10~0.30
		030101L																										0.01~0.05	0.10~0.30
		030102L		●																					●	●		0.01~0.05	0.10~0.30
		030104L																										0.01~0.05	0.10~0.30
		0401005L																										0.01~0.10	0.10~0.50
		040101L																										0.01~0.10	0.10~0.50
		040102L		●																					●	●		0.01~0.10	0.10~0.50
040104L																										0.01~0.10	0.10~0.50		
Finishing	CCET	0602005MFR-KF														●			●							0.01~0.06	0.04~1.30		
		060201MFR-KF														●			●							0.02~0.08	0.05~1.50		
		060202MFR-KF														●			●							0.03~0.11	0.06~1.70		
		09T3005MFR-KF														●			●							0.02~0.08	0.05~1.50		
		09T301MFR-KF														●			●							0.03~0.11	0.06~1.70		
		09T302MFR-KF														●			●							0.04~0.15	0.08~2.00		
		0602005MFL-KF														●			●							0.01~0.06	0.04~1.30		
		060201MFL-KF														●			●							0.02~0.08	0.05~1.50		
		060202MFL-KF														●			●							0.03~0.11	0.06~1.70		
		09T3005MFL-KF														●			●							0.02~0.08	0.05~1.50		
		09T301MFL-KF														●			●							0.03~0.11	0.06~1.70		
		09T302MFL-KF														●			●							0.04~0.15	0.08~2.00		
Medium to finishing	CCET	0602005MFR-KM														●			●							0.01~0.06	0.04~1.30		
		060201MFR-KM														●			●							0.02~0.08	0.05~1.50		
		060202MFR-KM														●			●							0.03~0.11	0.06~1.70		
		09T3005MFR-KM														●			●							0.02~0.08	0.05~1.50		
		09T301MFR-KM														●			●							0.03~0.11	0.06~1.70		
		09T302MFR-KM														●			●							0.04~0.15	0.08~2.00		
		0602005MFL-KM														●			●							0.01~0.06	0.04~1.30		
		060201MFL-KM														●			●							0.02~0.08	0.05~1.50		
		060202MFL-KM														●			●							0.03~0.11	0.06~1.70		
		09T3005MFL-KM														●			●							0.02~0.08	0.05~1.50		
		09T301MFL-KM														●			●							0.03~0.11	0.06~1.70		
		09T302MFL-KM														●			●							0.04~0.15	0.08~2.00		

➤ Cutting edge geometry A52~A61
 ➤ Recommended chip breaker B04~B11
 ➤ Code system B26~B27
 ● : Stock item

Available tool holders			
Designation	Page	Designation	Page
SCACR/L	B113, 178	SCLCR/L	B113, 178, 204, 214





Rhombic 80° Positive Relief Angle: 7°

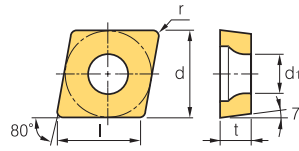

Dimensions (mm)			
Size	d	t	d ₁
06	6.35	2.38	2.8
09	9.525	3.97	4.4

Workpiece	Material Compatibility													Machining types				
	Steel	Stainless steel	Cast iron	Non-ferrous metal	Heat resistant alloy, Titanium alloy	Hardened steel	P	M	K	N	S	H	●	⦿	⚡	●	⦿	
Steel	●	●	●	●	●	●	●	●	●	●	●	●	●	●	●	●	●	●
Stainless steel	●	●	●	●	●	●	●	●	●	●	●	●	●	●	●	●	●	●
Cast iron	●	●	●	●	●	●	●	●	●	●	●	●	●	●	●	●	●	●
Non-ferrous metal	●	●	●	●	●	●	●	●	●	●	●	●	●	●	●	●	●	●
Heat resistant alloy, Titanium alloy	●	●	●	●	●	●	●	●	●	●	●	●	●	●	●	●	●	●
Hardened steel	●	●	●	●	●	●	●	●	●	●	●	●	●	●	●	●	●	●

Inserts	Designation	Cermets		Coated		Coated										Uncoated		Cutting Condition											
		CN1500	CN2000	CN2500	CC1500	CC2500	NC3215	NC3120	NC3225	NC3030	NC5330	NC6310	NC6315	NC9115	NC9125	NC9135	PC5300	PC5400	PC8105	PC8110	PC8115	PC9030	H01	H05	f _n (mm/rev)	a _p (mm)			
Finishing 	CCGT	0602003R-KF																								0.01~0.06	0.04~1.30		
		060201R-KF																									0.02~0.08	0.05~1.50	
		060202R-KF																									0.03~0.11	0.06~1.70	
		09T3003R-KF																									0.02~0.08	0.05~1.50	
		09T301R-KF																									0.03~0.11	0.06~1.70	
		09T302R-KF																									0.04~0.15	0.08~2.00	
		0602003L-KF																									0.01~0.06	0.04~1.30	
		060201L-KF																										0.02~0.08	0.05~1.50
		060202L-KF																										0.03~0.11	0.06~1.70
		09T3003L-KF																										0.02~0.08	0.05~1.50
		09T301L-KF																										0.03~0.11	0.06~1.70
	09T302L-KF																										0.04~0.15	0.08~2.00	
Finishing 	CCGT	060201-VP1															●	●	●	●			●			0.05~0.06	0.06~1.00		
		060202-VP1															●	●	●	●			●			0.03~0.10	0.08~1.50		
		060204-VP1															●	●	●	●			●			0.05~0.12	0.10~1.50		
		09T301-VP1															●	●	●	●			●			0.03~0.13	0.06~1.00		
		09T302-VP1															●	●	●	●			●			0.04~0.15	0.08~1.50		
		09T304-VP1															●	●	●	●			●			0.06~0.20	0.10~1.50		
Finishing [High precision]	CCGT	060201MFN-VP1															●			●						0.03~0.06	0.06~1.00		
		060202MFN-VP1															●			●						0.03~0.10	0.08~1.50		
		060204MFN-VP1															●			●						0.05~0.12	0.10~1.50		
		09T301MFN-VP1															●			●						0.03~0.13	0.06~1.00		
		09T302MFN-VP1															●			●						0.04~0.15	0.08~1.50		
		09T304MFN-VP1															●			●						0.06~0.20	0.10~1.50		

➤ Cutting edge geometry A52~A61
➤ Recommended chip breaker B04~B11
➤ Code system B26~B27
● : Stock item

Available tool holders			
Designation	Page	Designation	Page
SCACR/L	B113, 178	SCLCR/L	B113, 178, 204, 214



B Turning Insert (Positive)

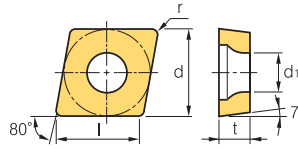

Dimensions (mm)			
Size	d	t	d ₁
06	6.35	2.38	2.8
09	9.525	3.97	4.4
12	12.7	4.76	5.5

Rhombic **80° Positive**
Relief Angle: 7°

Workpiece	Machining types											
	P	M	K	N	S	H						
Steel	●	●	●	●	●	●	●	●	●	●	●	●
Stainless steel	●	●	●	●	●	●	●	●	●	●	●	●
Cast iron	●	●	●	●	●	●	●	●	●	●	●	●
Non-ferrous metal	●	●	●	●	●	●	●	●	●	●	●	●
Heat resistant alloy, Titanium alloy	●	●	●	●	●	●	●	●	●	●	●	●
Hardened steel	●	●	●	●	●	●	●	●	●	●	●	●

● Continuous cutting
● General cutting
● Interrupted cutting

Inserts	Designation	Cermet		Coated		Coated										Uncoated		Cutting Condition											
		CN1500	CN2000	CN2500	CC1500	CC2500	NC3215	NC3120	NC3225	NC3030	NC5330	NC6310	NC6315	NC9115	NC9125	NC9135	PC5300	PC5400	PC8105	PC8110	PC8115	PC9030	H01	H05	f _n (mm/rev)	a _p (mm)			
Medium to finishing 	CCGT	0602003R-KM																								0.01-0.06	0.04-1.30		
		060201R-KM																									0.02-0.08	0.05-1.50	
		060202R-KM																					●				0.03-0.11	0.06-1.70	
		09T3003R-KM																									0.02-0.08	0.06-1.50	
		09T301R-KM																									0.03-0.11	0.06-1.70	
		09T302R-KM																									0.04-0.15	0.08-2.00	
		0602003L-KM																									0.01-0.06	0.04-1.30	
		060201L-KM																										0.02-0.08	0.05-1.50
		060202L-KM																										0.03-0.11	0.06-1.70
		09T3003L-KM																										0.02-0.08	0.06-1.50
		09T301L-KM																										0.03-0.11	0.06-1.70
	09T302L-KM																										0.04-0.15	0.08-2.00	
Finishing 	CCMT	060202-VF						●								●			●							0.05-0.20	0.30-1.00		
		060204-VF	●		●				●							●			●								0.10-0.25	0.30-1.00	
		09T302-VF							●																		0.04-0.16	0.80-1.50	
		09T304-VF	●	●	●				●							●			●								0.05-0.20	0.30-1.50	
		09T308-VF	●		●				●	●						●												0.10-0.25	0.30-1.50
		120404-VF							●																			0.07-0.22	0.10-2.00
Finishing 	CCMT	060202-VL																								0.04-0.18	0.20-1.40		
		060204-VL	●		●	●	●	●	●	●			●	●	●	●	●	●	●	●	●	●					0.04-0.10	0.08-0.90	
		060208-VL						●	●	●				●	●												0.06-0.12	0.10-1.00	
		09T304-VL	●	●	●	●	●	●	●	●				●	●	●	●	●	●	●	●	●	●	●	●	●	0.05-0.10	0.10-1.00	
		09T308-VL	●	●	●	●	●	●	●	●				●	●	●	●	●	●	●	●	●	●	●	●	●	0.08-0.15	0.10-1.00	
		120404-VL																									0.06-0.12	0.30-1.50	
		120408-VL																									0.08-0.15	0.30-1.50	
	120412-VL																									0.08-0.15	0.30-1.50		
Finishing 	CCMT	060204-VP1																								0.06-0.12	0.10-1.50		
		09T304-VP1																									0.06-0.20	0.10-1.50	
		09T308-VP1																									0.08-0.20	0.50-2.00	
		120404-VP1																									0.08-0.22	0.20-2.00	
		120408-VP1																									0.10-0.25	0.50-2.00	
		120412-VP1																									0.10-0.30	0.80-2.50	

➤ Cutting edge geometry A52~A61 ➤ Recommended chip breaker B04~B11 ➤ Code system B26~B27 ● : Stock item

Available tool holders			
Designation	Page	Designation	Page
SCACR/L	B113, 178	SCLCR/L	B113, 178, 204, 214





Rhombic 80° Positive
Relief Angle: 7°

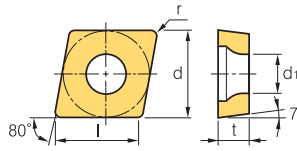

Dimensions (mm)			
Size	d	t	d ₁
06	6.35	2.38	2.8
08	7.94	3.18	3.4
09	9.525	3.97	4.4
12	12.7	4.76	5.5

Workpiece		P	M	K	N	S	H	Machining types														
		●	●	●	●	●	●	●	●	●	●	●	●	●	●	●	●	●	●	●	●	
Steel		●	●	●																		
Stainless steel			●																			
Cast iron		●	●																			
Non-ferrous metal				●																		
Heat resistant alloy, Titanium alloy						●																
Hardened steel							●															

Inserts	Designation	Cermet		Coated		Coated											Uncoated		Cutting Condition										
		CN1500	CN2000	CN2500	CC1500	CC2500	NC3215	NC3120	NC3225	NC3030	NC5330	NC6310	NC6315	NC9115	NC9125	NC9135	PC5300	PC5400	PC8105	PC8110	PC8115	PC9030	H01	H05	f _n (mm/rev)	a _p (mm)			
Medium to finishing	HMP	CCMT 060202-HMP	●																							0.03~0.12	0.10~1.50		
		CCMT 060204-HMP	●		●			●		●	●									●	●	●				0.06~0.17	0.20~2.40		
		CCMT 060208-HMP						●		●	●										●	●	●				0.08~0.23	0.40~2.40	
		CCMT 09T302-HMP		●																		●	●				0.07~0.22	0.10~2.00	
		CCMT 09T304-HMP			●				●		●	●		●								●	●	●			0.08~0.23	0.30~3.00	
		CCMT 09T308-HMP			●				●		●	●											●	●	●			0.10~0.30	0.50~3.00
		CCMT 120404-HMP							●		●												●	●				0.09~0.27	0.30~3.60
		CCMT 120408-HMP							●		●	●												●	●			0.24~0.36	1.00~3.60
	CCMT 120412-HMP																									0.14~0.43	0.70~3.60		
Medium to finishing	MP	CCMT 060202-MP	●		●	●	●	●	●	●	●	●	●	●	●	●	●	●	●	●	●	●	●	●			0.04~0.12	0.20~1.50	
		CCMT 060204-MP	●		●	●	●	●	●	●	●		●	●	●	●	●	●	●	●	●	●	●	●			0.05~0.15	0.30~1.50	
		CCMT 060208-MP													●												0.07~0.15	0.50~2.00	
		CCMT 09T302-MP	●		●	●	●	●	●	●	●		●	●	●	●	●	●	●	●	●	●	●	●			0.07~0.15	0.30~2.00	
		CCMT 09T304-MP	●		●	●	●	●	●	●	●	●	●	●	●	●	●	●	●	●	●	●	●	●			0.08~0.25	0.50~2.50	
		CCMT 09T308-MP	●		●	●	●	●	●	●	●	●	●	●	●	●	●	●	●	●	●	●	●	●			0.10~0.30	0.50~2.50	
		CCMT 120404-MP									●			●	●												0.10~0.30	0.50~3.50	
		CCMT 120408-MP									●		●	●	●	●	●	●	●	●	●	●	●	●			0.15~0.35	0.80~3.50	
	CCMT 120412-MP													●	●											0.25~0.40	1.00~3.50		
Medium cutting	C25	CCMT 060202-C25	●	●	●	●	●	●	●	●	●	●	●	●	●	●	●	●	●	●	●	●	●			0.03~0.12	0.40~2.00		
		CCMT 060204-C25	●	●	●	●	●	●	●	●	●	●	●	●	●	●	●	●	●	●	●	●	●			0.05~0.15	0.60~2.30		
		CCMT 060208-C25	●		●																●	●	●			0.07~0.20	0.80~2.30		
		CCMT 080308-C25																									0.08~0.25	0.80~2.30	
		CCMT 09T302-C25																									0.05~0.20	0.50~2.50	
		CCMT 09T304-C25	●	●	●	●	●	●	●	●	●	●	●	●	●	●	●	●	●	●	●	●	●	●			0.08~0.25	0.80~3.00	
		CCMT 09T308-C25	●	●	●	●	●	●	●	●	●	●	●	●	●	●	●	●	●	●	●	●	●	●			0.10~0.30	1.00~3.00	
		CCMT 120404-C25									●																0.10~0.32	0.80~3.00	
		CCMT 120408-C25	●		●	●	●	●	●	●	●	●	●	●	●	●	●	●	●	●	●	●	●	●			0.12~0.36	1.20~3.50	
	CCMT 120412-C25								●		●	●	●	●	●	●	●	●	●	●	●	●			0.15~0.40	1.40~3.50			

➡ Cutting edge geometry **A52~A61**
➡ Recommended chip breaker **B04~B11**
➡ Code system **B26~B27**
● : Stock item

Available tool holders			
Designation	Page	Designation	Page
SCACR/L	B113, 178	SCLCR/L	B113, 178, 204, 214



B Turning Insert (Positive)

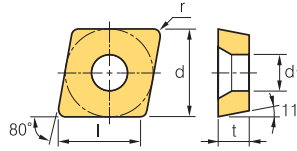

CP○○○

 Rhombic **80° Positive**
Relief Angle: 11°



Dimensions (mm)			
Size	d	t	d ₁
06	6.35	2.38	2.8
08	7.94	2.38	3.4
09	9.525	3.18	4.4

Workpiece	Material		Machining types																	
	Symbol	Code	●	⊙	⊛	●	⊙	⊛	●	⊙	⊛	●	⊙	⊛	●	⊙	⊛	●	⊙	⊛
Steel		P	●	⊙	⊛	●	⊙	⊛	●	⊙	⊛	●	⊙	⊛	●	⊙	⊛	●	⊙	⊛
Stainless steel		M	●	⊙	⊛	●	⊙	⊛	●	⊙	⊛	●	⊙	⊛	●	⊙	⊛	●	⊙	⊛
Cast iron		K	●	⊙	⊛	●	⊙	⊛	●	⊙	⊛	●	⊙	⊛	●	⊙	⊛	●	⊙	⊛
Non-ferrous metal		N																		
Heat resistant alloy, Titanium alloy		S																		
Hardened steel		H																		

Inserts	Designation	Cermet		Coated		Coated										Uncoated		Cutting Condition										
		CN1500	CN2000	CN2500	CC1500	CC2500	NC3215	NC3120	NC3225	NC3030	NC5330	NC6310	NC6315	NC9115	NC9125	NC9135	PC5300	PC5400	PC8105	PC8110	PC8115	PC9030	H01	H05	fn (mm/rev)	ap (mm)		
Finishing		CPGT 080202																								0.06-0.20	0.10-2.00	
		080204	●	●																						0.08-0.20	0.30-2.00	
		080208																									0.10-0.25	0.50-2.00
		090302																									0.04-0.20	0.30-1.50
		090304	●	●																							0.06-0.25	0.50-2.00
		090308																									0.08-0.30	0.70-2.50
Medium to finishing	HMP	CPGT 090308-HMP																							0.05-0.20	0.70-2.00		
Finishing		CPMT 080204-VF																							0.05-0.20	0.30-1.20		
		080208-VF																								0.10-0.25	0.30-1.20	
		090304-VF								●																0.05-0.20	0.30-1.50	
		090308-VF								●																0.10-0.25	0.30-1.50	
Finishing		CPMT 080204-VL																							0.03-0.08	0.08-1.00		
		080208-VL																								0.04-0.12	0.10-1.00	
		090304-VL																								0.05-0.10	0.10-1.00	
		090308-VL																								0.08-0.15	0.10-1.00	
Medium cutting	C25	CPMT 060204-C25																							0.05-0.15	0.60-2.30		

Cutting edge geometry A52~A61
 Recommended chip breaker B04~B11
 Code system B26~B27
 ● : Stock item

Available tool holders			
Designation	Page	Designation	Page
SCLPR/L	B205		



DC



Rhombic 55° Positive
Relief Angle: 7°

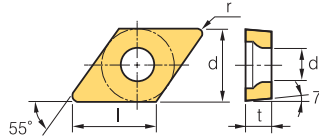

Dimensions (mm)			
Size	d	t	d ₁
07	6.35	2.38	2.8
11	9.525	3.97	4.4

Workpiece	Machining types												
	P	M	K	N	S	H							
Steel	●	●	●	●	●	●	●	●	●	●	●	●	●
Stainless steel	●	●	●	●	●	●	●	●	●	●	●	●	●
Cast iron	●	●	●	●	●	●	●	●	●	●	●	●	●
Non-ferrous metal	●	●	●	●	●	●	●	●	●	●	●	●	●
Heat resistant alloy, Titanium alloy	●	●	●	●	●	●	●	●	●	●	●	●	●
Hardened steel	●	●	●	●	●	●	●	●	●	●	●	●	●

● Continuous cutting
 ● General cutting
 ✦ Interrupted cutting

Inserts	Designation	Cermet		Coated		Coated										Uncoated		Cutting Condition										
		CN1500	CN2000	CN2500	CC1500	CC2500	NC3215	NC3120	NC3225	NC3030	NC5330	NC6310	NC6315	NC9115	NC9125	NC9135	PC5300	PC5400	PC8105	PC8110	PC8115	PC9030	H01	H05	f _n (mm/rev)	a _p (mm)		
Finishing [High precision]	DCET	0702005MFR-KF														●				●						0.01~0.06	0.04~1.30	
		070201MFR-KF															●				●						0.02~0.08	0.05~1.50
		070202MFR-KF															●				●						0.03~0.11	0.06~1.70
		11T3005MFR-KF															●				●						0.02~0.08	0.05~1.50
		11T301MFR-KF															●				●						0.03~0.11	0.06~1.70
		11T302MFR-KF															●				●						0.04~0.15	0.08~2.00
		0702005MFL-KF															●				●						0.01~0.06	0.04~1.30
		070201MFL-KF															●				●						0.02~0.08	0.05~1.50
		070202MFL-KF															●				●						0.03~0.11	0.06~1.70
		11T3005MFL-KF															●				●						0.02~0.08	0.05~1.50
		11T301MFL-KF															●				●						0.03~0.11	0.06~1.70
		11T302MFL-KF															●				●						0.04~0.15	0.08~2.00
Medium to finishing [High precision]	DCET	0702005MFR-KM														●				●						0.01~0.06	0.04~1.30	
		070201MFR-KM															●				●						0.02~0.08	0.05~1.50
		070202MFR-KM															●				●						0.03~0.11	0.06~1.70
		11T3005MFR-KM															●				●						0.02~0.08	0.05~1.50
		11T301MFR-KM															●				●						0.03~0.11	0.06~1.70
		11T302MFR-KM															●				●						0.04~0.15	0.08~2.00
		0702005MFL-KM															●				●						0.01~0.06	0.04~1.30
		070201MFL-KM															●				●						0.02~0.08	0.05~1.50
		070202MFL-KM															●				●						0.03~0.11	0.06~1.70
		11T3005MFL-KM															●				●						0.02~0.08	0.05~1.50
		11T301MFL-KM															●				●						0.03~0.11	0.06~1.70
		11T302MFL-KM															●				●						0.04~0.15	0.08~2.00
Finishing 	DCGT	0702003R-KF																								0.01~0.06	0.04~1.30	
		070201R-KF																									0.02~0.08	0.05~1.50
		070202R-KF																									0.03~0.11	0.06~1.50
		11T3003R-KF																									0.02~0.08	0.05~1.50
		11T301R-KF																									0.03~0.11	0.06~1.70
		11T302R-KF																					●				0.04~0.15	0.08~2.00
		0702003L-KF																									0.01~0.06	0.04~1.30
		070201L-KF																									0.02~0.08	0.05~1.50
		070202L-KF																									0.03~0.11	0.06~1.50
		11T3003L-KF																									0.02~0.08	0.05~1.50
		11T301L-KF																									0.03~0.11	0.06~1.70
		11T302L-KF																									0.04~0.15	0.08~2.00

↻ Cutting edge geometry **A52~A61**
 ↻ Recommended chip breaker **B04~B11**
 ↻ Code system **B26~B27**
 ● : Stock item

Available tool holders			
Designation	Page	Designation	Page
SDACR/L	B178	SDQCR/L	B206
SDJCR/L	B113, 179	SDUCR/L	B207
SDNCN	B114, 179	SDZCR/L	B208

B Turning Insert (Positive)

DC ○ ○ ○



Rhombic 55° Positive
Relief Angle: 7°

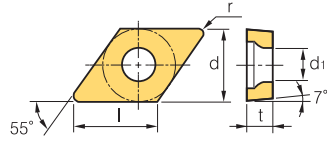

Dimensions (mm)			
Size	d	t	d ₁
07	6.35	2.38	2.8
11	9.525	3.97	4.4

Workpiece	Machining types															
	P	M	K	N	S	H										
Steel	●	●	●	●	●	●	●	●	●	●	●	●	●	●	●	●
Stainless steel	●	●	●	●	●	●	●	●	●	●	●	●	●	●	●	●
Cast iron	●	●	●	●	●	●	●	●	●	●	●	●	●	●	●	●
Non-ferrous metal	●	●	●	●	●	●	●	●	●	●	●	●	●	●	●	●
Heat resistant alloy, Titanium alloy	●	●	●	●	●	●	●	●	●	●	●	●	●	●	●	●
Hardened steel	●	●	●	●	●	●	●	●	●	●	●	●	●	●	●	●

Inserts	Designation	Cermets		Coated		Coated										Uncoated		Cutting Condition																		
		CN1500	CN2000	CN2500	CC1500	CC2500	NC3215	NC3120	NC3225	NC3030	NC5330	NC6310	NC6315	NC9115	NC9125	NC9135	PC5300	PC5400	PC8105	PC8110	PC8115	PC9030	H01	H05	f _n (mm/rev)	a _p (mm)										
Finishing 	DCGT 070201-VP1															●		●	●	●	●	●	●	●	●	●	●	●	●	●	●	0.03-0.06	0.06-1.00			
	070202-VP1															●		●	●	●	●	●	●	●	●	●	●	●	●	●	●	●	0.03-0.10	0.08-1.50		
	070204-VP1															●		●	●	●	●	●	●	●	●	●	●	●	●	●	●	●	0.05-0.12	0.10-1.50		
	11T301-VP1															●		●		●													0.03-0.13	0.06-1.00		
	11T302-VP1															●		●	●	●	●	●	●	●	●	●	●	●	●	●	●	●	●	0.04-0.15	0.08-1.50	
	11T304-VP1															●		●	●	●	●	●	●	●	●	●	●	●	●	●	●	●	●	0.06-0.20	0.10-1.50	
Finishing [High precision]	DCGT 070201MFN-VP1															●		●		●													0.03-0.06	0.06-1.00		
	070202MFN-VP1															●		●		●														0.03-0.10	0.08-1.50	
	070204MFN-VP1															●		●		●														0.05-0.12	0.10-1.50	
	11T301MFN-VP1															●		●		●														0.03-0.13	0.06-1.00	
	11T302MFN-VP1															●		●	●	●	●	●	●	●	●	●	●	●	●	●	●	●	●	0.04-0.15	0.08-1.50	
	11T304MFN-VP1															●		●	●	●	●	●	●	●	●	●	●	●	●	●	●	●	●	0.06-0.20	0.10-1.50	
Medium to finishing 	DCGT 0702003R-KM																																	0.01-0.06	0.04-1.30	
	070201R-KM																																		0.02-0.08	0.05-1.50
	070202R-KM																																		0.03-0.11	0.06-1.50
	11T3003R-KM																																		0.02-0.08	0.05-1.50
	11T301R-KM																																		0.03-0.11	0.06-1.70
	11T302R-KM																																		0.04-0.15	0.08-2.00
	0702003L-KM																																		0.01-0.06	0.04-1.30
	070201L-KM																																		0.02-0.08	0.05-1.50
	070202L-KM																																		0.03-0.11	0.06-1.50
	11T3003L-KM																																		0.02-0.08	0.05-1.50
	11T301L-KM																																		0.03-0.11	0.06-1.70
	11T302L-KM																																		0.04-0.15	0.08-2.00
Finishing [High precision]	DCMT 070202-VF			●						●																								0.03-0.10	0.06-1.00	
	070204-VF		●	●						●							●			●															0.05-0.20	0.30-1.20
	11T302-VF		●	●						●																									0.04-0.15	0.08-1.50
	11T304-VF		●	●	●					●							●			●															0.05-0.20	0.30-1.50
	11T308-VF		●	●													●			●															0.10-0.25	0.30-1.50

Cutting edge geometry A52~A61
 Recommended chip breaker B04~B11
 Code system B26~B27
 ● : Stock item

Available tool holders			
Designation	Page	Designation	Page
SDACR/L	B178	SDQCR/L	B206
SDJCR/L	B113, 179	SDUCR/L	B207
SDNCN	B114, 179	SDZCR/L	B208



DC

Rhombic **55° Positive**
Relief Angle: 7°

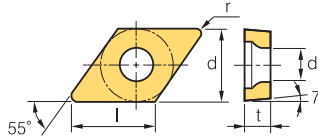

Dimensions (mm)			
Size	d	t	d ₁
07	6.35	2.38	2.8
11	9.525	3.97	4.4

Workpiece	Machining types											
	P	M	K	N	S	H						
Steel	●	●	●	●	●	●	●	●	●	●	●	●
Stainless steel	●	●	●	●	●	●	●	●	●	●	●	●
Cast iron	●	●	●	●	●	●	●	●	●	●	●	●
Non-ferrous metal	●	●	●	●	●	●	●	●	●	●	●	●
Heat resistant alloy, Titanium alloy	●	●	●	●	●	●	●	●	●	●	●	●
Hardened steel	●	●	●	●	●	●	●	●	●	●	●	●

● Continuous cutting
 ● General cutting
 ✦ Interrupted cutting

Inserts	Designation	Cermet		Coated		Coated										Uncoated		Cutting Condition									
		CN1500	CN2000	CN2500	CC1500	CC2500	NC3215	NC3120	NC3225	NC3030	NC5330	NC6310	NC6315	NC9115	NC9125	NC9135	PC5300	PC5400	PC8105	PC8110	PC8115	PC9030	H01	H05	f _n (mm/rev)	a _p (mm)	
Finishing VL	DCMT 070202-VL																								0.02~0.10	0.06~0.80	
	DCMT 070204-VL	●	●	●	●	●	●	●	●	●	●	●	●	●	●	●	●	●	●	●	●	●	●	●	●	0.04~0.10	0.08~0.90
	DCMT 070208-VL						●	●	●	●	●	●	●	●	●	●	●	●	●	●	●	●	●	●	●	0.06~0.12	0.10~1.00
	DCMT 11T302-VL																									0.03~0.10	0.07~0.80
	DCMT 11T304-VL	●	●	●	●	●	●	●	●	●	●	●	●	●	●	●	●	●	●	●	●	●	●	●	●	0.05~0.10	0.10~1.00
	DCMT 11T308-VL	●	●	●	●	●	●	●	●	●	●	●	●	●	●	●	●	●	●	●	●	●	●	●	●	0.08~0.15	0.10~1.00
DCMT 11T312-VL																									0.08~0.15	0.30~1.50	
Finishing VP1	DCMT 070204-VP1																								0.05~0.12	0.10~1.50	
	DCMT 11T304-VP1																								0.06~0.20	0.10~1.50	
	DCMT 11T308-VP1																								0.08~0.23	0.10~1.50	
Medium to finishing HMP	DCMT 070202-HMP										●													●	0.03~0.12	0.10~1.50	
	DCMT 070204-HMP										●	●	●				●			●	●			●	0.06~0.17	0.20~2.30	
	DCMT 070208-HMP										●	●								●	●			●	0.08~0.23	0.40~2.30	
	DCMT 11T302-HMP											●								●	●			●	0.04~0.22	0.10~2.00	
	DCMT 11T304-HMP			●								●	●	●	●					●	●			●	0.08~0.23	0.30~3.00	
	DCMT 11T308-HMP											●	●	●						●	●			●	0.10~0.30	0.50~3.00	
Medium to finishing MP	DCMT 070202-MP	●	●	●	●	●	●	●	●	●	●	●	●	●	●	●	●	●	●	●	●	●	●	●	0.04~0.12	0.12~1.80	
	DCMT 070204-MP	●	●	●	●	●	●	●	●	●	●	●	●	●	●	●	●	●	●	●	●	●	●	●	0.05~0.15	0.30~1.80	
	DCMT 070208-MP	●	●	●	●	●	●	●	●	●	●	●	●	●	●	●	●	●	●	●	●	●	●	●	0.08~0.22	0.30~1.80	
	DCMT 11T302-MP	●	●	●	●	●	●	●	●	●	●	●	●	●	●	●	●	●	●	●	●	●	●	●	0.04~0.15	0.30~2.00	
	DCMT 11T304-MP	●	●	●	●	●	●	●	●	●	●	●	●	●	●	●	●	●	●	●	●	●	●	●	0.08~0.20	0.50~2.30	
	DCMT 11T308-MP	●	●	●	●	●	●	●	●	●	●	●	●	●	●	●	●	●	●	●	●	●	●	●	0.10~0.30	0.50~2.30	
	DCMT 11T312-MP																								0.25~0.35	0.80~3.00	
Medium cutting C25 new	DCMT 070202-C25	●	●	●	●	●	●	●	●	●	●	●	●	●	●	●	●	●	●	●	●	●	●	●	0.03~0.15	0.30~2.00	
	DCMT 070204-C25	●	●	●	●	●	●	●	●	●	●	●	●	●	●	●	●	●	●	●	●	●	●	●	0.05~0.20	0.50~2.50	
	DCMT 070208-C25	●	●	●	●	●	●	●	●	●	●	●	●	●	●	●	●	●	●	●	●	●	●	●	0.06~0.25	0.80~2.50	
	DCMT 11T302-C25	●	●	●	●	●	●	●	●	●	●	●	●	●	●	●	●	●	●	●	●	●	●	●	0.04~0.25	0.50~2.50	
	DCMT 11T304-C25	●	●	●	●	●	●	●	●	●	●	●	●	●	●	●	●	●	●	●	●	●	●	●	0.08~0.30	0.80~3.00	
	DCMT 11T308-C25	●	●	●	●	●	●	●	●	●	●	●	●	●	●	●	●	●	●	●	●	●	●	●	0.10~0.30	1.00~3.00	

↻ Cutting edge geometry **A52~A61**
 ↻ Recommended chip breaker **B04~B11**
 ↻ Code system **B26~B27**
 ● : Stock item

Available tool holders			
Designation	Page	Designation	Page
SDACR/L	B178	SDQCR/L	B206
SDJCR/L	B113, 179	SDUCR/L	B207
SDNCN	B114, 179	SDZCR/L	B208



B Turning Insert (Positive)

RC

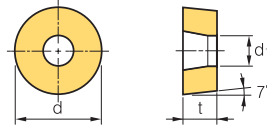

Dimensions (mm)			
Size	d	t	d ₁
08	8.0	3.18	3.35
10	10.0	3.97	3.6
12	12.0	4.76	4.2
16	16.0	6.35	5.2
20	20.0	6.35	6.5
25	25.0	7.94	7.25
32	32.0	9.52	9.55

Round **R° Positive**
Relief Angle: 7°

Workpiece	Machining types											
	P	M	K	N	S	H	●	●	●	●	●	●
Steel	●	●	●	●	●	●	●	●	●	●	●	●
Stainless steel	●	●	●	●	●	●	●	●	●	●	●	●
Cast iron	●	●	●	●	●	●	●	●	●	●	●	●
Non-ferrous metal	●	●	●	●	●	●	●	●	●	●	●	●
Heat resistant alloy, Titanium alloy	●	●	●	●	●	●	●	●	●	●	●	●
Hardened steel	●	●	●	●	●	●	●	●	●	●	●	●

Inserts	Designation	Cermert		Coated										Uncoated		Cutting Condition												
		CN1500	CN2000	CN2500	CC1500	CC2500	NC3215	NC3120	NC3225	NC3030	NC5330	NC6310	NC6315	NC9115	NC9125	NC9135	PC5300	PC5400	PC8105	PC8110	PC8115	PC9030	H01	H05	f _n (mm/rev)	a _p (mm)		
Medium cutting	VM	RCMT	0803M0-VM																						0.05~0.30	0.80~2.50		
		10T3M0-VM																								0.05~0.35	0.90~3.00	
		1204M0-VM																									0.10~0.50	1.00~3.50
		1606M0-VM																									0.13~0.60	1.30~6.50
Medium cutting	RCMX	1003M0						●	●	●	●	●														0.25~0.50	1.50~4.00	
		1204M0						●	●	●	●	●															0.30~0.60	2.50~5.00
		1606M0							●	●	●	●	●														0.40~0.70	3.00~7.00
		2006M0								●	●	●	●														0.48~0.90	3.50~9.00
		2507M0									●	●	●														0.55~1.20	4.00~12.00
		3209M0									●	●	●														0.65~1.50	5.00~15.00

➤ Cutting edge geometry A52~A61 ➤ Recommended chip breaker B04~B11 ➤ Code system B26~B27 ● : Stock item

Available tool holders			
Designation	Page	Designation	Page
PRDCN	B162	PRGCR/L	B162

SC

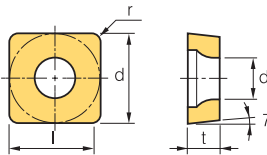

Dimensions (mm)			
Size	d	t	d ₁
09	9.525	3.97	4.4

Square **90° Positive**
Relief Angle: 7°

Workpiece	Machining types											
	P	M	K	N	S	H	●	●	●	●	●	●
Steel	●	●	●	●	●	●	●	●	●	●	●	●
Stainless steel	●	●	●	●	●	●	●	●	●	●	●	●
Cast iron	●	●	●	●	●	●	●	●	●	●	●	●
Non-ferrous metal	●	●	●	●	●	●	●	●	●	●	●	●
Heat resistant alloy, Titanium alloy	●	●	●	●	●	●	●	●	●	●	●	●
Hardened steel	●	●	●	●	●	●	●	●	●	●	●	●

Inserts	Designation	Cermert		Coated										Uncoated		Cutting Condition											
		CN1500	CN2000	CN2500	CC1500	CC2500	NC3215	NC3120	NC3225	NC3030	NC5330	NC6310	NC6315	NC9115	NC9125	NC9135	PC5300	PC5400	PC8105	PC8110	PC8115	PC9030	H01	H05	f _n (mm/rev)	a _p (mm)	
Finishing	VF	SCMT	09T304-VF						●							●										0.05~0.20	0.30~1.50

➤ Cutting edge geometry A52~A61 ➤ Recommended chip breaker B04~B11 ➤ Code system B26~B27 ● : Stock item

Available tool holders			
Designation	Page	Designation	Page
SSBCR/L	B180	SSKCR/L	B181, 208
SSDCN	B180	SSSCR/L	B181, 234



SC

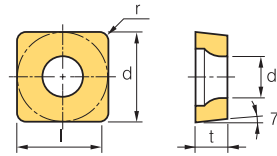

Dimensions (mm)			
Size	d	t	d ₁
06	6.35	2.38	2.8
09	9.525	3.97	4.4
12	12.7	4.76	5.5

Square **90° Positive**
Relief Angle: 7°

Workpiece	Machining types											
	P	M	K	N	S	H	●	●	●	●	●	●
Steel	●	●	●	●	●	●	●	●	●	●	●	●
Stainless steel	●	●	●	●	●	●	●	●	●	●	●	●
Cast iron	●	●	●	●	●	●	●	●	●	●	●	●
Non-ferrous metal	●	●	●	●	●	●	●	●	●	●	●	●
Heat resistant alloy, Titanium alloy	●	●	●	●	●	●	●	●	●	●	●	●
Hardened steel	●	●	●	●	●	●	●	●	●	●	●	●

	Inserts	Designation	Cermet		Coated		Coated										Uncoated		Cutting Condition									
			CN1500	CN2000	CN2500	CC1500	CC2500	NC3215	NC3120	NC3225	NC3030	NC5330	NC6310	NC6315	NC9115	NC9125	NC9135	PC5300	PC5400	PC8105	PC8110	PC8115	PC9030	H01	H05	f _n (mm/rev)	a _p (mm)	
Finishing	VL	SCMT 09T304-VL	●	●	●	●	●	●	●	●	●	●	●	●	●	●	●	●	●	●	●	●	●	●	●	0.05~0.10	0.10~1.00	
		SCMT 09T308-VL	●	●	●	●	●	●	●	●	●	●	●	●	●	●	●	●	●	●	●	●	●	●	●	●	0.08~0.15	0.10~1.00
Medium to finishing	HMP	SCMT 09T304-HMP	●	●	●	●	●	●	●	●	●	●	●	●	●	●	●	●	●	●	●	●	●	●	●	0.08~0.23	0.30~3.00	
		SCMT 09T308-HMP	●	●	●	●	●	●	●	●	●	●	●	●	●	●	●	●	●	●	●	●	●	●	●	0.10~0.30	0.50~3.00	
		SCMT 120404-HMP	●	●	●	●	●	●	●	●	●	●	●	●	●	●	●	●	●	●	●	●	●	●	●	●	0.09~0.27	0.30~3.60
		SCMT 120408-HMP	●	●	●	●	●	●	●	●	●	●	●	●	●	●	●	●	●	●	●	●	●	●	●	●	0.12~0.36	0.60~3.60
Medium to finishing	MP	SCMT 09T304-MP	●	●	●	●	●	●	●	●	●	●	●	●	●	●	●	●	●	●	●	●	●	●	●	0.05~0.25	0.30~2.80	
		SCMT 09T308-MP	●	●	●	●	●	●	●	●	●	●	●	●	●	●	●	●	●	●	●	●	●	●	●	0.10~0.30	0.50~2.80	
		SCMT 120404-MP	●	●	●	●	●	●	●	●	●	●	●	●	●	●	●	●	●	●	●	●	●	●	●	0.10~0.30	0.50~2.80	
		SCMT 120408-MP	●	●	●	●	●	●	●	●	●	●	●	●	●	●	●	●	●	●	●	●	●	●	●	0.15~0.35	0.80~3.50	
		SCMT 120412-MP	●	●	●	●	●	●	●	●	●	●	●	●	●	●	●	●	●	●	●	●	●	●	●	0.25~0.40	1.00~3.50	
Medium cutting	C25	SCMT 060204-C25	●	●	●	●	●	●	●	●	●	●	●	●	●	●	●	●	●	●	●	●	●	●	●	0.08~0.25	0.40~2.50	
		SCMT 09T304-C25	●	●	●	●	●	●	●	●	●	●	●	●	●	●	●	●	●	●	●	●	●	●	●	0.08~0.25	0.60~3.00	
		SCMT 09T308-C25	●	●	●	●	●	●	●	●	●	●	●	●	●	●	●	●	●	●	●	●	●	●	●	0.10~0.30	1.00~3.00	
		SCMT 120404-C25	●	●	●	●	●	●	●	●	●	●	●	●	●	●	●	●	●	●	●	●	●	●	●	0.10~0.30	0.80~3.80	
		SCMT 120408-C25	●	●	●	●	●	●	●	●	●	●	●	●	●	●	●	●	●	●	●	●	●	●	●	0.12~0.38	1.20~3.80	

Cutting edge geometry **A52~A61**
 Recommended chip breaker **B04~B11**
 Code system **B26~B27**
 ● : Stock item

Available tool holders			
Designation	Page	Designation	Page
SSBCR/L	B180	SSKCR/L	B181, 208
SSDCN	B180	SSSCR/L	B181, 234



B Turning Insert (Positive)

SP ○○

 Square **90° Positive**
Relief Angle: 11°

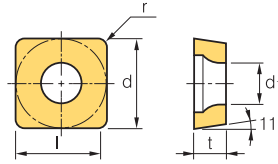

Dimensions (mm)			
Size	d	t	d ₁
06	6.35	2.38	2.8
07	7.94	2.38	-
09	9.525	3.18	3.4
12	12.7	4.76	-
15	15.875	4.76	-
19	19.05	4.76	-

Workpiece	Machining types											
	P	M	K	N	S	H						
Steel	●	●	●	●	●	●	●	●	●	●	●	●
Stainless steel	●	●	●	●	●	●	●	●	●	●	●	●
Cast iron	●	●	●	●	●	●	●	●	●	●	●	●
Non-ferrous metal	●	●	●	●	●	●	●	●	●	●	●	●
Heat resistant alloy, Titanium alloy	●	●	●	●	●	●	●	●	●	●	●	●
Hardened steel	●	●	●	●	●	●	●	●	●	●	●	●

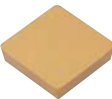
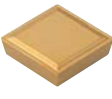
Inserts	Designation	Cermets		Coated		Coated										Uncoated		Cutting Condition											
		CN1500	CN2000	CN2500	CC1500	CC2500	NC3215	NC3120	NC3225	NC3030	NC5330	NC6310	NC6315	NC9115	NC9125	NC9135	PC5300	PC5400	PC8105	PC8110	PC8115	PC9030	H01	H05	f _n (mm/rev)	a _p (mm)			
Medium to finishing	SPGA 	060204																							0.50-0.25	0.50-2.00			
		090308T	●	●																						0.10-0.25	0.70-3.00		
		090308T-Z <small>(Z = Special Nega land)</small>		●																							0.10-0.25	0.70-3.00	
Medium to finishing	SPGN 	070202																								0.03-0.10	0.50-2.00		
		070208																									0.10-0.25	0.70-3.00	
		090302																									0.03-0.10	0.50-3.00	
		090304																									0.08-0.20	0.70-3.50	
		090308																									0.10-0.25	0.70-3.50	
		120302																									0.03-0.20	0.50-3.00	
		120304																									0.08-0.20	1.00-5.00	
		120308									●																	0.10-0.25	1.00-5.00
		120312																										0.15-0.30	1.00-5.00
		120316																										0.18-0.33	1.00-5.00
		120402																										0.03-0.20	0.50-3.00
		120404																										0.08-0.20	1.00-5.00
		120408																										0.10-0.25	1.00-5.00
		120412																										0.15-0.30	1.00-5.00
		120416																										0.18-0.33	1.00-5.00
		120430																										0.20-0.60	2.00-5.00
		120440																										0.25-0.70	3.00-5.00
		150404																										0.08-0.20	1.50-7.00
		150408																										0.10-0.25	1.50-7.00
		150412																										0.15-0.30	1.50-7.00
150416																										0.18-0.33	1.50-7.00		
150420																										0.20-0.45	1.50-7.00		
190404																										0.08-0.20	1.50-9.00		
190408																										0.10-0.25	1.50-9.00		
190412																										0.15-0.45	1.50-9.00		
190416																										0.18-0.60	1.50-9.00		
190424																										0.25-0.70	2.50-9.00		
Finishing	SPGR 	090304-F																								0.05-0.20	0.30-2.00		
		120304-F																									0.10-0.25	0.50-2.00	

 Cutting edge geometry **A52~A61**
 Recommended chip breaker **B04~B11**
 Code system **B26~B27**
● : Stock item

Available tool holders			
Designation	Page	Designation	Page
CSDPN	B169	SSKPR/L	B208
CSKPR/L	B170		



SP

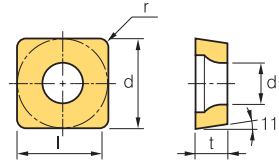

Dimensions (mm)			
Size	d	t	d ₁
09	9.525	3.18	3.4~4.4
12	12.7	3.18	-
15	15.875	4.76	-
19	19.05	4.76	-
25	25.4	6.35	-

Square **90° Positive**
Relief Angle: 11°

Workpiece	Machining types															
	P	M	K	N	S	H										
Steel	●	●	●	●	●	●	●	●	●	●	●	●	●	●	●	●
Stainless steel	●	●	●	●	●	●	●	●	●	●	●	●	●	●	●	●
Cast iron	●	●	●	●	●	●	●	●	●	●	●	●	●	●	●	●
Non-ferrous metal	●	●	●	●	●	●	●	●	●	●	●	●	●	●	●	●
Heat resistant alloy, Titanium alloy	●	●	●	●	●	●	●	●	●	●	●	●	●	●	●	●
Hardened steel	●	●	●	●	●	●	●	●	●	●	●	●	●	●	●	●

Inserts	Designation	Cermet		Coated		Coated										Uncoated		Cutting Condition										
		CN1500	CN2000	CN2500	CC1500	CC2500	NC3215	NC3120	NC3225	NC3030	NC5330	NC6310	NC6315	NC9115	NC9125	NC9135	PC5300	PC5400	PC8105	PC8110	PC8115	PC9030	H01	H05	f _n (mm/rev)	a _p (mm)		
Medium cutting	M	SPGR	090308-M																							0.10~0.40	1.00~3.50	
			120308-M																								0.20~0.40	1.50~4.00
Medium to finishing	VL	SPGT	090304R																							0.08~0.23	0.30~3.00	
			090308R																							0.10~0.30	0.50~3.00	
			090304L	●																							0.08~0.23	0.30~3.00
			090308L																								0.10~0.30	0.50~3.00
Finishing	F	SPMR	090304-F																							0.05~0.20	0.30~2.00	
			120304-F						●	●																	0.10~0.25	0.50~2.00
Finishing	VL	SPMT	09T304-VL																							0.04~0.18	0.20~1.40	
			09T308-VL																								0.08~0.22	0.20~1.40
Finishing	VF	SPMT	090304-VF																							0.05~0.20	0.30~1.50	
			090308-VF																								0.10~0.25	0.30~1.50
Medium cutting	M	SPMR	090308-M							●	●															0.10~0.40	1.00~3.50	
			120308-M								●	●														0.10~0.40	1.50~4.00	
			120312-M									●															0.20~0.40	1.50~4.00
Medium to finishing	SPUN	120304	120304																							0.10~0.30	1.00~5.00	
			120308																								0.15~0.40	1.00~5.00
			120308SN																								0.15~0.40	1.00~5.00
			150412																								0.20~0.50	1.00~5.00
			190412										●														0.20~0.50	1.50~7.00
			190416																								0.25~0.60	2.00~7.00
			250620																								0.30~0.80	3.00~10.0

Cutting edge geometry **A52~A61**
 Recommended chip breaker **B04~B11**
 Code system **B26~B27**
 ● : Stock item

Available tool holders			
Designation	Page	Designation	Page
CSDPN	B169	SSKPR/L	B208
CSKPR/L	B170		



B Turning Insert (Positive)

TB ○○



Triangular **60° Positive**
Relief Angle: 5°

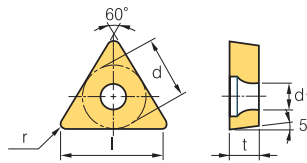

Dimensions (mm)			
Size	d	t	d ₁
06	3.97	1.59	2.16

Workpiece	Machining types																							
	P	M	K	N	S	H	NC3215	NC3120	NC3225	NC3030	NC5330	NC6310	NC6315	NC9115	NC9125	NC9135	PC5300	PC5400	PC8105	PC8110	PC8115	PC9030	H01	H05
Steel	●	●	●	●	●	●	●	●	●	●	●	●	●	●	●	●	●	●	●	●	●	●	●	●
Stainless steel	●	●	●	●	●	●	●	●	●	●	●	●	●	●	●	●	●	●	●	●	●	●	●	●
Cast iron	●	●	●	●	●	●	●	●	●	●	●	●	●	●	●	●	●	●	●	●	●	●	●	●
Non-ferrous metal	●	●	●	●	●	●	●	●	●	●	●	●	●	●	●	●	●	●	●	●	●	●	●	●
Heat resistant alloy, Titanium alloy	●	●	●	●	●	●	●	●	●	●	●	●	●	●	●	●	●	●	●	●	●	●	●	●
Hardened steel	●	●	●	●	●	●	●	●	●	●	●	●	●	●	●	●	●	●	●	●	●	●	●	●

Inserts	Designation	Cermets		Coated		Coated														Uncoated		Cutting Condition				
		CN1500	CN2000	CN2500	CC1500	CC2500	NC3215	NC3120	NC3225	NC3030	NC5330	NC6310	NC6315	NC9115	NC9125	NC9135	PC5300	PC5400	PC8105	PC8110	PC8115	PC9030	H01	H05	f _n (mm/rev)	a _p (mm)
Finishing	TBGT	060102L	●																				●	●	0.05~0.20	0.10~1.30
		060104L	●																							0.08~0.20
Finishing	TBMT	060102-VL																							0.03~0.06	0.05~0.60

Cutting edge geometry **A52~A61**
 Recommended chip breaker **B04~B11**
 Code system **B26~B27**
● : Stock item

Available tool holders			
Designation	Page	Designation	Page
STUBR/L	B214		



TC



Triangular 60° Positive
Relief Angle: 7°

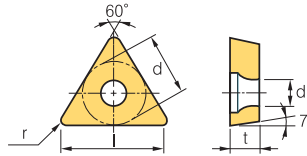

Dimensions (mm)			
Size	d	t	d ₁
08	4.76	2.38	2.3
09	5.56	2.38	2.5
11	6.35	2.38	2.8
16	9.523	3.97	4.4

Workpiece	Machining types											
	P	M	K	N	S	H	●	●	●	●	●	●
Steel	●	●	●	●	●	●	●	●	●	●	●	●
Stainless steel	●	●	●	●	●	●	●	●	●	●	●	●
Cast iron	●	●	●	●	●	●	●	●	●	●	●	●
Non-ferrous metal	●	●	●	●	●	●	●	●	●	●	●	●
Heat resistant alloy, Titanium alloy	●	●	●	●	●	●	●	●	●	●	●	●
Hardened steel	●	●	●	●	●	●	●	●	●	●	●	●

Inserts	Designation	Cermet		Coated		Coated										Uncoated		Cutting Condition										
		CN1500	CN2000	CN2500	CC1500	CC2500	NC3215	NC3120	NC3225	NC3030	NC5330	NC6310	NC6315	NC9115	NC9125	NC9135	PC5300	PC5400	PC8105	PC8110	PC8115	PC9030	H01	H05	f _n (mm/rev)	a _p (mm)		
Finishing 	TCGT	0802003R-KF																								0.01~0.06	0.04~1.30	
		080201R-KF																									0.02~0.08	0.05~1.50
		080202R-KF																									0.03~0.11	0.06~1.70
		0802003L-KF																									0.01~0.06	0.04~1.30
		080201L-KF																									0.02~0.08	0.05~1.50
		080202L-KF																									0.03~0.11	0.06~1.70
Finishing 	TCGT	090204-VP1																								0.04~0.18	0.10~1.00	
		16T304-VP1																								0.06~0.20	0.10~1.50	
		16T308-VP1																								0.08~0.23	0.10~1.50	
Finishing 	TCMT	110202-VF																								0.03~0.13	0.06~0.70	
		110204-VF	●													●										0.05~0.20	0.30~1.20	
		110208-VF														●										0.10~0.25	0.30~1.20	
		16T302-VF														●										0.05~0.15	0.10~1.30	
		16T304-VF								●	●					●										0.05~0.20	0.30~1.50	
Finishing 	TCMT	090208-VL																								0.08~0.20	0.10~1.20	
		110204-VL																								0.05~0.15	0.10~1.30	
		110208-VL																								0.08~0.20	0.10~1.30	
		16T304-VL	●	●	●	●	●	●	●	●	●	●	●	●	●	●	●	●	●	●	●	●	●	●	●	0.05~0.20	0.30~1.50	
		16T308-VL	●	●	●	●	●	●	●	●	●	●	●	●	●	●	●	●	●	●	●	●	●	●	●	0.05~0.20	0.30~1.50	
Finishing 	TCMT	16T304-VP1																								0.06~0.20	0.10~1.50	
		16T308-VP1																								0.08~0.23	0.10~1.50	
Medium to finishing 	TCMT	090204-HMP								●													●			0.06~0.17	0.20~2.30	
		090208-HMP								●																0.08~0.23	0.40~2.30	
		110202-HMP								●	●	●	●													0.03~0.15	0.10~1.50	
		110204-HMP				●				●	●	●	●				●			●	●	●	●	●	●	0.06~0.19	0.20~2.50	
		110208-HMP									●						●									0.09~0.26	0.40~2.50	
		16T304-HMP				●				●	●	●					●									0.08~0.23	0.30~3.00	
	16T308-HMP								●	●	●					●									0.10~0.30	0.50~3.00		

🔄 Cutting edge geometry A52~A61
🔄 Recommended chip breaker B04~B11
🔄 Code system B26~B27
● : Stock item

Available tool holders			
Designation	Page	Designation	Page
STACR/L	B114, 181	STTCR/L	B182, 235
STFCR/L	B182, 234	STWCR/L	B235
STGCR/L	B182		



B Turning Insert (Positive)

TC ○○



Triangular **60° Positive**
Relief Angle: 7°

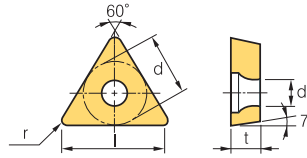

Dimensions (mm)			
Size	d	t	d ₁
09	5.56	2.38	2.5
11	6.35	2.38	2.8
16	9.523	3.97	4.4

Workpiece	Machining types											
	P	M	K	N	S	H						
Steel	●	●	●	●	●	●	●	●	●	●	●	●
Stainless steel	●	●	●	●	●	●	●	●	●	●	●	●
Cast iron	●	●	●	●	●	●	●	●	●	●	●	●
Non-ferrous metal	●	●	●	●	●	●	●	●	●	●	●	●
Heat resistant alloy, Titanium alloy	●	●	●	●	●	●	●	●	●	●	●	●
Hardened steel	●	●	●	●	●	●	●	●	●	●	●	●

Inserts	Designation	Cermet		Coated										Uncoated		Cutting Condition												
		CN1500	CN2000	CN2500	CC1500	CC2500	NC3215	NC3120	NC3225	NC3030	NC5330	NC6310	NC6315	NC9115	NC9125	NC9135	PC5300	PC5400	PC8105	PC8110	PC8115	PC9030	H01	H05	f _n (mm/rev)	a _p (mm)		
Medium to finishing 	TCMT 090204-MP 090208-MP 110202-MP 110204-MP 110208-MP 16T302-MP 16T304-MP 16T308-MP 16T312-MP 220408-MP	●	●	●	●	●	●	●	●	●	●	●	●	●	●	●	●	●	●	●	●	●	●	●	●	0.05~0.18	0.10~1.00	
		●	●	●	●	●	●	●	●	●	●	●	●	●	●	●	●	●	●	●	●	●	●	●	●	●	0.08~0.20	0.10~1.20
		●	●	●	●	●	●	●	●	●	●	●	●	●	●	●	●	●	●	●	●	●	●	●	●	●	0.03~0.12	0.20~1.50
		●	●	●	●	●	●	●	●	●	●	●	●	●	●	●	●	●	●	●	●	●	●	●	●	●	0.05~0.15	0.20~15.0
		●	●	●	●	●	●	●	●	●	●	●	●	●	●	●	●	●	●	●	●	●	●	●	●	●	0.10~0.28	0.25~2.00
		●	●	●	●	●	●	●	●	●	●	●	●	●	●	●	●	●	●	●	●	●	●	●	●	●	0.08~0.25	0.20~1.50
		●	●	●	●	●	●	●	●	●	●	●	●	●	●	●	●	●	●	●	●	●	●	●	●	●	0.08~0.20	0.30~2.50
		●	●	●	●	●	●	●	●	●	●	●	●	●	●	●	●	●	●	●	●	●	●	●	●	●	0.10~0.30	0.50~2.50
		●	●	●	●	●	●	●	●	●	●	●	●	●	●	●	●	●	●	●	●	●	●	●	●	●	0.20~0.40	0.50~2.50
Medium cutting 	TCMT 090204-C25 090208-C25 110202-C25 110204-C25 110208-C25 16T304-C25 16T308-C25	●	●	●	●	●	●	●	●	●	●	●	●	●	●	●	●	●	●	●	●	●	●	●	●	0.06~0.18	0.40~2.50	
		●	●	●	●	●	●	●	●	●	●	●	●	●	●	●	●	●	●	●	●	●	●	●	●	0.08~0.25	0.80~2.50	
		●	●	●	●	●	●	●	●	●	●	●	●	●	●	●	●	●	●	●	●	●	●	●	●	0.04~0.12	0.40~2.00	
		●	●	●	●	●	●	●	●	●	●	●	●	●	●	●	●	●	●	●	●	●	●	●	●	●	0.06~0.20	0.60~2.50
		●	●	●	●	●	●	●	●	●	●	●	●	●	●	●	●	●	●	●	●	●	●	●	●	●	0.08~0.25	0.80~2.50
		●	●	●	●	●	●	●	●	●	●	●	●	●	●	●	●	●	●	●	●	●	●	●	●	●	0.08~0.28	0.80~3.00

➤ Cutting edge geometry A52~A61 ➤ Recommended chip breaker B04~B11 ➤ Code system B26~B27 ● : Stock item

TO ○○



Triangular **60° Positive**
Relief Angle: 8°

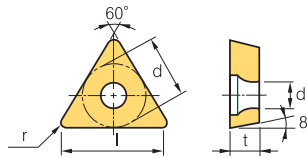

Dimensions (mm)			
Size	d	t	d ₁
06	3.97	1.59	2.15
09	5.56	2.38	2.8
14	8.2	3.0	3.8

Workpiece	Machining types											
	P	M	K	N	S	H						
Steel	●	●	●	●	●	●	●	●	●	●	●	●
Stainless steel	●	●	●	●	●	●	●	●	●	●	●	●
Cast iron	●	●	●	●	●	●	●	●	●	●	●	●
Non-ferrous metal	●	●	●	●	●	●	●	●	●	●	●	●
Heat resistant alloy, Titanium alloy	●	●	●	●	●	●	●	●	●	●	●	●
Hardened steel	●	●	●	●	●	●	●	●	●	●	●	●

Inserts	Designation	Cermet		Coated										Uncoated		Cutting Condition											
		CN1500	CN2000	CN2500	CC1500	CC2500	NC3215	NC3120	NC3225	NC3030	NC5330	NC6310	NC6315	NC9115	NC9125	NC9135	PC5300	PC5400	PC8105	PC8110	PC8115	PC9030	H01	H05	f _n (mm/rev)	a _p (mm)	
Medium to finishing 	TOEH 060102L 090204L 140304L	●	●	●	●	●	●	●	●	●	●	●	●	●	●	●	●	●	●	●	●	●	●	●	●	0.05~0.17	0.10~1.50
		●	●	●	●	●	●	●	●	●	●	●	●	●	●	●	●	●	●	●	●	●	●	●	●	0.05~0.20	0.30~2.50
		●	●	●	●	●	●	●	●	●	●	●	●	●	●	●	●	●	●	●	●	●	●	●	●	0.05~0.25	0.30~2.50

➤ Cutting edge geometry A52~A61 ➤ Recommended chip breaker B04~B11 ➤ Code system B26~B27 ● : Stock item



TP



Triangular 60° Positive
Relief Angle: 11°

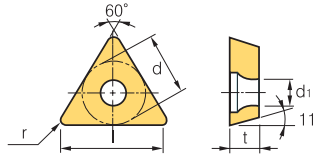

Dimensions (mm)			
Size	d	t	d ₁
08	4.76	2.38	2.3
09	5.56	2.38	-
11	6.35	2.38~3.18	3.4
16	9.525	3.18~4.76	4.4
22	12.7	4.76	-
27	15.875	4.76~6.35	-

Workpiece	Machining types											
	P	M	K	N	S	H	●	●	●	●	●	●
Steel	●	●	●	●	●	●	●	●	●	●	●	●
Stainless steel	●	●	●	●	●	●	●	●	●	●	●	●
Cast iron	●	●	●	●	●	●	●	●	●	●	●	●
Non-ferrous metal	●	●	●	●	●	●	●	●	●	●	●	●
Heat resistant alloy, Titanium alloy	●	●	●	●	●	●	●	●	●	●	●	●
Hardened steel	●	●	●	●	●	●	●	●	●	●	●	●

Inserts	Designation	Cermet		Coated		Coated										Uncoated		Cutting Condition										
		CN1500	CN2000	CN2500	CC1500	CC2500	NC3215	NC3120	NC3225	NC3030	NC5330	NC6310	NC6315	NC9115	NC9125	NC9135	PC5300	PC5400	PC8105	PC8110	PC8115	PC9030	H01	H05	f _n (mm/rev)	a _p (mm)		
Finishing	TPGH	080202L	●																							0.01~0.12	0.06~1.70	
		080204L	●	●																							0.01~0.15	0.08~1.70
		110202L																									0.01~0.12	0.06~2.00
		110204L																									0.01~0.15	0.08~2.00
Medium to finishing	TPGN	090204																								0.07~0.20	0.70~2.00	
		110302																								0.05~0.15	0.50~2.00	
		110304								●													●			0.07~0.20	0.70~3.00	
		110308								●													●			0.10~0.25	1.00~3.00	
		160302																								0.05~0.18	1.00~5.00	
		160304								●	●												●			0.07~0.20	1.00~5.00	
		160308								●	●												●			0.10~0.25	1.00~5.00	
		160310																									0.10~0.25	1.00~5.00
		160312																									0.15~0.30	1.00~5.00
		160316																									0.15~0.30	1.00~5.00
		160404																									0.07~0.20	1.00~5.00
		220404										●															0.07~0.20	1.50~7.00
		220408										●	●														0.10~0.25	1.50~7.00
		220412										●															0.15~0.30	1.50~7.00
		220430																									0.30~0.45	1.50~7.00
		220440																									0.30~0.50	1.50~7.00
270408																									0.15~0.25	3.00~8.00		
270608																									0.15~0.25	3.00~8.00		
Finishing	TPGR	110302-F																								0.05~0.15	0.10~1.50	
		110304-F																								0.05~0.20	0.30~1.50	
		160304-F																								0.08~0.25	0.50~2.00	
Medium cutting	TPGR	110308-M																								0.13~0.30	1.00~3.00	
		160308-M																								0.13~0.30	1.00~5.00	

➡ Cutting edge geometry A52~A61
➡ Recommended chip breaker B04~B11
➡ Code system B26~B27
● : Stock item

Available tool holders			
Designation	Page	Designation	Page
STFPR/L	B210	STUPR/L	B215
CTFPR/L	B170	CTGPR/L	B170



B Turning Insert (Positive)

TP ○○

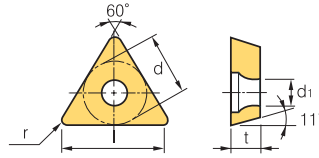

 Triangular **60° Positive**
Relief Angle: 11°



Dimensions (mm)			
Size	d	t	d ₁
08	4.76	2.38	2.3
09	5.56	2.38	3.0
11	6.35	3.18	3.4
16	9.525	3.18~4.76	4.4
22	12.7	4.76	-

Workpiece	Machining types															
	P	M	K	N	S	H										
Steel	●	●	●	●	●	●	●	●	●	●	●	●	●	●	●	●
Stainless steel	●	●	●	●	●	●	●	●	●	●	●	●	●	●	●	●
Cast iron	●	●	●	●	●	●	●	●	●	●	●	●	●	●	●	●
Non-ferrous metal	●	●	●	●	●	●	●	●	●	●	●	●	●	●	●	●
Heat resistant alloy, Titanium alloy	●	●	●	●	●	●	●	●	●	●	●	●	●	●	●	●
Hardened steel	●	●	●	●	●	●	●	●	●	●	●	●	●	●	●	●

Inserts	Designation	Cermets		Coated		Coated										Uncoated		Cutting Condition											
		CN1500	CN2000	CN2500	CC1500	CC2500	NC3215	NC3120	NC3225	NC3030	NC5330	NC6310	NC6315	NC9115	NC9125	NC9135	PC5300	PC5400	PC8105	PC8110	PC8115	PC9030	H01	H05	f _n (mm/rev)	a _p (mm)			
Medium to finishing	TPGT	080202R																								0.05-0.20	0.30-1.50		
		110302R																									0.05-0.20	0.30-1.50	
		110304R	●																								0.05-0.20	0.50-2.00	
		110308R																									0.07-0.25	0.50-2.00	
		160404R	●																								0.05-0.20	0.70-3.00	
		160408R																									0.05-0.20	0.70-3.00	
		080202L	●																				●	●			0.05-0.20	0.30-1.50	
		110302L																										0.05-0.20	0.30-1.50
		110304L	●	●																								0.05-0.20	0.50-2.00
		110308L																										0.07-0.25	0.50-2.00
		160404L	●																									0.05-0.20	0.70-3.00
		160408L																										0.05-0.20	0.70-3.00
Medium to finishing	TPGX	090202L																								0.10-0.20	0.30-1.00		
		090204L		●																						0.10-0.25	0.50-1.00		
		090208L																								0.10-0.30	1.00-1.00		
		110304L																								0.10-0.25	0.50-1.20		
Finishing	TPMR	090202-F																								0.05-0.15	0.10-1.00		
		090204-F																								0.05-0.15	0.10-1.00		
		110302-F																								0.05-0.15	0.10-1.50		
		110304-F						●	●	●													●			0.05-0.20	0.30-1.50		
		110308-F																									0.05-0.25	0.30-1.50	
		160304-F						●	●	●	●												●	●			0.08-0.25	0.50-2.00	
160308-F																									0.08-0.25	0.50-3.00			
Medium cutting	TPMR	110304-M																								0.10-0.25	0.70-3.00		
		110308-M								●		●														0.13-0.30	1.00-3.00		
		160304-M								●		●														0.10-0.25	1.00-5.00		
		160308-M						●	●	●		●														0.13-0.30	1.00-5.00		
		160312-M								●																	0.15-0.35	1.00-5.00	
		220408-M							●																		0.13-0.30	1.50-7.00	

 Cutting edge geometry A52~A61
  Recommended chip breaker B04~B11
  Code system B26~B27
 ● : Stock item

Available tool holders			
Designation	Page	Designation	Page
STFPR/L	B210	STUPR/L	B215
CTFPR/L	B170	CTGPR/L	B170



TP



Triangular 60° Positive
Relief Angle: 11°

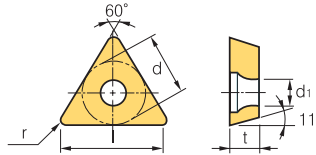

Dimensions (mm)			
Size	d	t	d ₁
09	5.56	3.18	-
11	6.35	3.18	3.4
16	9.525	3.18~4.76	4.4
22	12.7	4.76	-
33	19.05	6.35	-

Workpiece	Machining types															
	P	M	K	N	S	H	1	2	3	4	5	6	7	8	9	10
Steel	●	●	●	●	●	●	●	●	●	●	●	●	●	●	●	●
Stainless steel	●	●	●	●	●	●	●	●	●	●	●	●	●	●	●	●
Cast iron	●	●	●	●	●	●	●	●	●	●	●	●	●	●	●	●
Non-ferrous metal	●	●	●	●	●	●	●	●	●	●	●	●	●	●	●	●
Heat resistant alloy, Titanium alloy	●	●	●	●	●	●	●	●	●	●	●	●	●	●	●	●
Hardened steel	●	●	●	●	●	●	●	●	●	●	●	●	●	●	●	●

Inserts	Designation	Cermets		Coated		Coated										Uncoated		Cutting Condition										
		CN1500	CN2000	CN2500	CC1500	CC2500	NC3215	NC3120	NC3225	NC3030	NC5330	NC6310	NC6315	NC9115	NC9125	NC9135	PC5300	PC5400	PC8105	PC8110	PC8115	PC9030	H01	H05	f _n (mm/rev)	a _p (mm)		
Finishing 	TPMT	110304-VF	●					●	●								●			●						0.05~0.20	0.30~1.50	
		110308-VF						●	●											●							0.10~0.25	0.30~1.50
		160404-VF																									0.05~0.20	0.30~2.00
		160408-VF																									0.10~0.25	0.30~2.00
Finishing 	TPMT	090204-VL																								0.04~0.10	0.10~0.90	
		090208-VL																									0.06~0.12	0.10~1.00
		110304-VL	●	●	●	●	●	●	●	●	●	●	●	●	●	●	●	●	●	●	●	●	●	●	●	0.05~0.15	0.10~1.30	
		110308-VL					●							●	●												0.08~0.20	0.10~1.30
		160404-VL																									0.05~0.20	0.30~1.50
		160408-VL																									0.05~0.20	0.30~1.50
Medium to finishing 	TPMT	090202-MP																								0.03~0.15	0.10~1.00	
		090204-MP																									0.05~0.18	0.10~1.00
		110302-MP																									0.03~0.12	0.20~1.50
		110304-MP	●	●	●	●	●	●	●	●	●	●	●	●	●	●	●	●	●	●	●	●	●	●	●	0.05~0.20	0.20~1.50	
		110308-MP					●	●	●	●	●	●	●	●	●	●	●	●	●	●	●	●	●	●	●	0.10~0.28	0.30~2.00	
		160402-MP																									0.06~0.20	0.30~2.50
		160404-MP					●	●	●	●	●	●	●	●	●	●	●	●	●	●	●	●	●	●	●	0.08~0.20	0.30~2.50	
		160408-MP					●	●	●	●	●	●	●	●	●	●	●	●	●	●	●	●	●	●	●	0.10~0.30	0.50~2.50	
Medium to finishing 	TPUN	090308																								0.10~0.30	0.50~2.00	
		110208																								0.15~0.40	1.00~3.00	
		110304																								0.10~0.30	1.00~3.00	
		110308																								0.15~0.40	1.00~3.00	
		160304								●																0.10~0.30	1.00~5.00	
		160308								●							●									0.15~0.40	1.00~5.00	
		160308TN																								0.15~0.40	1.00~5.00	
		160312																								0.20~0.50	1.50~5.00	
		160312TN																								0.20~0.50	1.50~5.00	
		220404																								0.10~0.30	1.50~7.00	
		220408									●															0.15~0.40	1.50~7.00	
		220412																								0.20~0.50	1.50~7.00	
		220412TN																								0.20~0.50	1.50~7.00	
		330620																								0.30~0.70	3.00~10.00	

🔄 Cutting edge geometry A52~A61
🔄 Recommended chip breaker B04~B11
🔄 Code system B26~B27
● : Stock item

Available tool holders			
Designation	Page	Designation	Page
STFPR/L	B210	STUPR/L	B215
CTFPR/L	B170	CTGPR/L	B170



B Turning Insert (Positive)

VB ○○



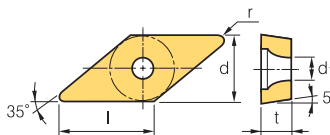



 Rhombic **35° Positive**
Relief Angle: 5°



Dimensions (mm)			
Size	d	t	d ₁
11	6.35	3.18	2.8
16	9.525	4.76	4.4

Workpiece	Material		Machining types																	
	Symbol	Material	●	◐	◑	●	◐	◑	●	◐	◑	●	◐	◑	●	◐	◑	●	◐	◑
Steel	P	Steel	●	◐	◑	●	◐	◑	●	◐	◑	●	◐	◑	●	◐	◑	●	◐	◑
Stainless steel	M	Stainless steel	●	◐	◑	●	◐	◑	●	◐	◑	●	◐	◑	●	◐	◑	●	◐	◑
Cast iron	K	Cast iron	●	◐	◑	●	◐	◑	●	◐	◑	●	◐	◑	●	◐	◑	●	◐	◑
Non-ferrous metal	N	Non-ferrous metal	●	◐	◑	●	◐	◑	●	◐	◑	●	◐	◑	●	◐	◑	●	◐	◑
Heat resistant alloy, Titanium alloy	S	Heat resistant alloy, Titanium alloy	●	◐	◑	●	◐	◑	●	◐	◑	●	◐	◑	●	◐	◑	●	◐	◑
Hardened steel	H	Hardened steel	●	◐	◑	●	◐	◑	●	◐	◑	●	◐	◑	●	◐	◑	●	◐	◑

● Continuous cutting
◐ General cutting
◑ Interrupted cutting

Inserts	Designation	Cermet		Coated		Coated														Uncoated		Cutting Condition						
		CN1500	CN2000	CN2500	CC1500	CC2500	NC3215	NC3120	NC3225	NC3030	NC5330	NC6310	NC6315	NC9115	NC9125	NC9135	PC5300	PC5400	PC8105	PC8110	PC8115	PC9030	H01	H05	f _n (mm/rev)	a _p (mm)		
Finishing 	VBGT	1103003R-KF																								0.01-0.06	0.04-1.30	
		110301R-KF																									0.02-0.08	0.05-1.50
		110302R-KF																					●				0.03-0.13	0.06-1.70
		1103003L-KF																									0.01-0.06	0.04-1.30
		110301L-KF																									0.02-0.08	0.05-1.50
		110302L-KF																									0.03-0.13	0.06-1.70
Finishing 	VBGT	110302-VP1																								0.03-0.10	0.08-1.50	
		160402-VP1																								0.04-0.20	0.16-1.50	
		160404-VP1																								0.05-0.20	0.18-1.80	
Medium to finishing 	VBGT	160404																								0.07-0.20	0.50-1.50	
		160408																								0.15-0.25	0.70-2.00	
Medium to finishing 	VBGT	1103003R-KM																								0.01-0.06	0.04-1.30	
		110301R-KM																									0.02-0.08	0.05-1.50
		110302R-KM																									0.03-0.13	0.06-1.70
		160404R-KM																									0.05-0.15	0.50-2.00
		1103003L-KM																									0.01-0.06	0.04-1.30
		110301L-KM																									0.02-0.08	0.05-1.50
		110302L-KM																									0.03-0.13	0.06-1.70
		160404L-KM																									0.05-0.15	0.50-2.00
Finishing 	VBMT	110302-VB																								0.05-0.15	0.20-1.20	
		110304-VB																								0.06-0.18	0.20-1.20	
		110308-VB																								0.08-0.20	0.60-1.20	
		160402-VB																								0.06-0.20	0.05-1.00	
		160404-VB	●	●					●																	0.08-0.20	0.20-1.50	
		160408-VB	●	●					●																	0.10-0.23	0.50-1.50	
		160412-VB																								0.12-0.25	0.80-1.50	
Finishing 		160404-VF	●	●	●			●	●							●				●					0.05-0.20	0.30-1.00		
		160408-VF	●	●	●												●									0.10-0.25	0.30-1.00	

 Cutting edge geometry **A52~A61**
 Recommended chip breaker **B04~B11**
 Code system **B26~B27**
● : Stock item

Available tool holders			
Designation	Page	Designation	Page
SVABR/L	B183	SVVBN	B184
SVHBR/L	B183	SVQBR/L	B211
SVJBR/L	B115, 183	SVUBR/L	B212





Rhombic 35° Positive Relief Angle: 5°

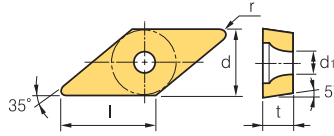

Dimensions (mm)			
Size	d	t	d ₁
11	6.35	2.38~3.18	2.8~3.4
16	9.525	4.76	4.4

Workpiece	Steel	P	M	K	N	S	H	Machining types
	Stainless steel	●	●	●				
Cast iron	●	●	●					
Non-ferrous metal				●	●			
Heat resistant alloy, Titanium alloy						●		
Hardened steel							●	

	Inserts	Designation	Cermets		Coated		Coated										Uncoated		Cutting Condition										
			CN1500	CN2000	CN2500	CC1500	CC2500	NC3215	NC3120	NC3225	NC3030	NC5330	NC6310	NC6315	NC9115	NC9125	NC9135	PC5300	PC5400	PC8105	PC8110	PC8115	PC9030	H01	H05	f _n (mm/rev)	a _p (mm)		
Finishing	VL [Mild steel]	VBMT	110302-VL																							0.03~0.20	0.20~1.20		
			110304-VL																									0.04~0.20	0.20~1.20
			110308-VL																									0.08~0.20	0.20~1.20
			160402-VL																									0.03~0.20	0.30~1.50
			160404-VL	●	●	●	●	●		●		●			●	●	●	●	●	●	●	●	●	●				0.05~0.20	0.30~1.50
			160408-VL	●	●	●	●	●		●		●			●	●	●	●	●	●	●	●	●	●				0.10~0.20	0.30~1.50
			160412-VL														●	●	●			●	●	●				0.10~0.25	0.30~1.50
Finishing	VP1 	VBMT	160402-VP1																							0.04~0.20	0.16~1.50		
			160404-VP1																								0.05~0.20	0.18~1.80	
			160408-VP1																								0.06~0.20	0.20~1.80	
Medium to finishing		VBMT	160404		●				●	●	●														●	0.07~0.20	0.50~1.50		
			160408							●	●	●		●													●	0.15~0.25	0.70~2.00
Medium to finishing	HMP 	VBMT	110304-HMP						●																	●	0.03~0.20	0.15~2.70	
			110308-HMP							●																		0.05~0.25	0.40~2.70
			160404-HMP							●	●	●		●				●			●							0.07~0.20	0.20~2.70
			160408-HMP							●	●	●	●					●			●							0.09~0.27	0.50~2.70
			160412-HMP																				●						0.11~0.32
Medium to finishing	MP new 	VBMT	110302-MP																								0.04~0.14	0.20~1.50	
			110304-MP							●	●						●	●										0.05~0.15	0.20~1.50
			110308-MP							●	●																	0.10~0.28	0.30~2.00
			160402-MP																									0.06~0.16	0.25~2.00
			160404-MP	●	●	●	●	●		●		●		●	●	●	●	●	●	●	●	●	●	●				0.08~0.20	0.30~2.00
			160408-MP	●	●	●	●	●		●		●		●	●	●	●	●	●	●	●	●	●	●				0.10~0.25	0.50~2.30
			160412-MP	●	●					●		●		●				●	●	●	●	●	●	●				0.10~0.35	0.50~2.30

⌚ Cutting edge geometry A52~A61
 ⌚ Recommended chip breaker B04~B11
 ⌚ Code system B26~B27
 ●: Stock item

Available tool holders			
Designation	Page	Designation	Page
SVABR/L	B183	SVVBN	B184
SVHBR/L	B183	SVQBR/L	B211
SVJBR/L	B115, 183	SVUBR/L	B212



B Turning Insert (Positive)





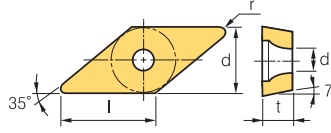

VC ○ ○

 Rhombic **35° Positive**
Relief Angle: 7°



Dimensions (mm)			
Size	d	t	d ₁
11	6.35	3.18	2.8~3.4
16	9.525	4.76	4.4

Workpiece	Machining types											
	P	M	K	N	S	H						
Steel	●	●	●	●	●	●	●	●	●	●	●	●
Stainless steel	●	●	●	●	●	●	●	●	●	●	●	●
Cast iron	●	●	●	●	●	●	●	●	●	●	●	●
Non-ferrous metal	●	●	●	●	●	●	●	●	●	●	●	●
Heat resistant alloy, Titanium alloy	●	●	●	●	●	●	●	●	●	●	●	●
Hardened steel	●	●	●	●	●	●	●	●	●	●	●	●

Inserts	Designation	Cermets		Coated		Coated										Uncoated		Cutting Condition										
		CN1500	CN2000	CN2500	CC1500	CC2500	NC3215	NC3120	NC3225	NC3030	NC5330	NC6310	NC6315	NC9115	NC9125	NC9135	PC5300	PC5400	PC8105	PC8110	PC8115	PC9030	H01	H05	f _n (mm/rev)	a _p (mm)		
Finishing  [High precision]	VCET	1103005MFR-KF															●									0.01~0.06	0.04~1.30	
		110301MFR-KF																●			●						0.02~0.08	0.05~1.50
		110302MFR-KF																●			●						0.03~0.11	0.06~1.70
		1103005MFL-KF																●									0.01~0.06	0.04~1.30
		110301MFL-KF																●									0.02~0.08	0.05~1.50
		110302MFL-KF																●			●						0.03~0.11	0.06~1.70
Medium to finishing  [High precision]	VCET	1103005MFR-KM															●									0.02~0.08	0.05~1.50	
		110301MFR-KM															●			●						0.03~0.11	0.06~1.70	
		110302MFR-KM															●			●						0.04~0.15	0.08~2.00	
		1103005MFL-KM															●									0.02~0.08	0.05~1.50	
		110301MFL-KM															●									0.03~0.11	0.06~1.70	
		110302MFL-KM															●									0.04~0.15	0.08~2.00	
Finishing 	VCGT	1103003R-KF																								0.01~0.06	0.04~1.30	
		110301R-KF																								0.02~0.08	0.05~1.50	
		110302R-KF																						●		0.03~0.13	0.06~1.70	
		1103003L-KF																								0.01~0.06	0.04~1.30	
		110301L-KF																								0.02~0.08	0.05~1.50	
		110302L-KF																								0.03~0.13	0.06~1.70	
Finishing 	VCGT	110301-VP1															●	●	●	●		●		0.02~0.15	0.05~0.50			
		110302-VP1															●	●	●	●		●		0.02~0.18	0.10~1.00			
		110304-VP1															●	●	●	●		●		0.03~0.18	0.15~1.20			
		160404-VP1									●														0.05~0.20	0.18~1.80		
		160408-VP1									●														0.06~0.20	0.20~1.80		
		Finishing  [High precision]	VCGT	110301MFN-VP1															●			●				0.02~0.15	0.05~0.50	
110302MFN-VP1																		●			●				0.02~0.18	0.10~1.00		
110304MFN-VP1																		●			●				0.03~0.18	0.15~1.20		
1203008FN-VP1																									0.03~0.12	0.06~1.20		
120301FN-VP1																									0.04~0.13	0.08~1.20		
120302FN-VP1																									0.04~0.15	0.08~1.20		
Medium to finishing 	VCGT	1103003R-KM																							0.01~0.06	0.04~1.30		
		110301R-KM																							0.02~0.08	0.05~1.50		
		110302R-KM																						●	0.03~0.13	0.06~1.70		
		1103003L-KM																							0.01~0.06	0.04~1.30		
		110301L-KM																							0.02~0.08	0.05~1.50		
		110302L-KM																							0.03~0.13	0.06~1.70		

 Cutting edge geometry A52~A61
  Recommended chip breaker B04~B11
  Code system B26~B27
 ● : Stock item

Available tool holders			
Designation	Page	Designation	Page
SVJCR/L	B115, 184, 211	SVQCR/L	B212
SVVCN	B184	SVUCR/L	B212



VC ○ ○ ○

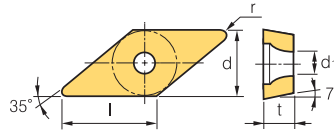

Dimensions (mm)			
Size	d	t	d ₁
08	4.76	2.38	2.3
11	6.35	3.18	2.8~3.4
12	7.5	3.18	2.8
16	9.525	4.76	4.4

Rhombic **35° Positive**
Relief Angle: 7°

Workpiece	Machining types														
	P	M	K	N	S	H	●	●	●	●	●	●	●	●	●
Steel	●	●	●	●	●	●	●	●	●	●	●	●	●	●	●
Stainless steel	●	●	●	●	●	●	●	●	●	●	●	●	●	●	●
Cast iron	●	●	●	●	●	●	●	●	●	●	●	●	●	●	●
Non-ferrous metal	●	●	●	●	●	●	●	●	●	●	●	●	●	●	●
Heat resistant alloy, Titanium alloy	●	●	●	●	●	●	●	●	●	●	●	●	●	●	●
Hardened steel	●	●	●	●	●	●	●	●	●	●	●	●	●	●	●

● Continuous cutting
● General cutting
● Interrupted cutting

Inserts	Designation	Cermet		Coated		Coated										Uncoated		Cutting Condition									
		CN1500	CN2000	CN2500	CC1500	CC2500	NC3215	NC3120	NC3225	NC3030	NC5330	NC6310	NC6315	NC9115	NC9125	NC9135	PC5300	PC5400	PC8105	PC8110	PC8115	PC9030	H01	H05	f _n (mm/rev)	a _p (mm)	
Finishing [High precision]	VCGX 120300MFR-VP1															●				●					0.02~0.10	0.05~0.50	
	120301MFR-VP1															●				●						0.02~0.15	0.05~0.50
	120302MFR-VP1															●				●						0.02~0.18	0.10~1.00
	120304MFR-VP1															●				●						0.03~0.20	0.12~1.20
	120308MFR-VP1															●				●						0.05~0.20	0.15~1.20
Finishing 	VCMT 080202-VF																								0.05~0.20	0.30~1.00	
	080204-VF																									0.10~0.25	0.30~1.00
	110304-VF								●																	0.03~0.18	0.15~1.20
	160404-VF								●		●										●					0.04~0.20	0.15~1.50
Finishing [Mild steel]	VCMT 080202-VL						●		●		●					●									0.03~0.08	0.10~0.80	
	080204-VL						●		●		●					●										0.04~0.10	0.10~0.90
	160404-VL						●		●		●					●				●	●					0.05~0.20	0.30~1.50
	160408-VL						●		●		●					●				●	●					0.05~0.20	0.30~1.50
	160412-VL																									0.10~0.25	0.30~1.50
Finishing 	VCMT 160404-VP1																								0.05~0.20	0.18~1.80	
	160408-VP1																								0.06~0.20	0.20~1.80	
Medium to finishing 	VCMT 160404-HMP								●		●					●				●	●				0.10~0.25	0.30~2.60	
	160408-HMP								●		●					●				●	●				0.13~0.33	0.60~2.60	
Medium to finishing new	VCMT 080202-MP						●		●																0.03~0.15	0.10~1.00	
	080204-MP						●		●																	0.05~0.18	0.10~1.00
	110302-MP																									0.06~0.18	0.20~1.80
	110304-MP																									0.06~0.18	0.20~1.80
	160404-MP						●		●		●		●	●	●	●				●	●					0.08~0.18	0.30~2.00
	160408-MP						●		●		●		●	●	●	●				●	●					0.10~0.23	0.50~2.30
	160412-MP															●	●	●		●	●					0.10~0.33	0.50~2.30

Cutting edge geometry **A52~A61**
 Recommended chip breaker **B04~B11**
 Code system **B26~B27**
 ● : Stock item

Available tool holders			
Designation	Page	Designation	Page
SVJCR/L	B115, 184, 211	SVQCR/L	B212
SVVCN	B184	SVUCR/L	B212



B Turning Insert (Positive)

VP ○○

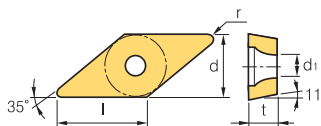

Dimensions (mm)			
Size	d	t	d ₁
08	6.35	2.38	2.3
11	6.35	3.18	2.8

Rhombic **35° Positive**
Relief Angle: 11°

Workpiece	Machining types																							
	P	M	K	N	S	H	NC3215	NC3120	NC3225	NC3030	NC5330	NC6310	NC6315	NC9115	NC9125	NC9135	PC5300	PC5400	PC8105	PC8110	PC8115	PC9030	H01	H05
Steel	●	●	●	●	●	●	●	●	●	●	●	●	●	●	●	●	●	●	●	●	●	●	●	●
Stainless steel	●	●	●	●	●	●	●	●	●	●	●	●	●	●	●	●	●	●	●	●	●	●	●	●
Cast iron	●	●	●	●	●	●	●	●	●	●	●	●	●	●	●	●	●	●	●	●	●	●	●	●
Non-ferrous metal	●	●	●	●	●	●	●	●	●	●	●	●	●	●	●	●	●	●	●	●	●	●	●	●
Heat resistant alloy, Titanium alloy	●	●	●	●	●	●	●	●	●	●	●	●	●	●	●	●	●	●	●	●	●	●	●	●
Hardened steel	●	●	●	●	●	●	●	●	●	●	●	●	●	●	●	●	●	●	●	●	●	●	●	●

Inserts	Designation	Cermet		Coated		Coated												Uncoated		Cutting Condition								
		CN1500	CN2000	CN2500	CC1500	CC2500	NC3215	NC3120	NC3225	NC3030	NC5330	NC6310	NC6315	NC9115	NC9125	NC9135	PC5300	PC5400	PC8105	PC8110	PC8115	PC9030	H01	H05	f _n (mm/rev)	a _p (mm)		
Finishing [High precision]	VPET	0802005MFR-KF															●			●						0.01~0.12	0.05~0.50	
		080201MFR-KF															●			●							0.02~0.15	0.05~0.50
		080202MFR-KF															●			●							0.02~0.18	0.10~1.00
		0802005MFL-KF															●			●							0.01~0.12	0.05~0.50
		080201MFL-KF															●			●							0.02~0.15	0.05~0.50
		080202MFL-KF															●			●							0.02~0.18	0.10~1.00
Medium to finishing [High precision]	VPET	0802005MFR-KM															●			●						0.01~0.12	0.05~0.50	
		080201MFR-KM															●			●							0.02~0.15	0.05~0.50
		080202MFR-KM															●			●							0.02~0.18	0.10~1.00
		0802005MFL-KM															●			●							0.01~0.12	0.05~0.50
		080201MFL-KM															●			●							0.02~0.15	0.05~0.50
		080202MFL-KM															●			●							0.02~0.18	0.10~1.00
Finishing 	VPGT	110301-VP1															●		●	●	●		●			0.02~0.15	0.05~0.50	
		110302-VP1															●		●	●	●		●			0.02~0.18	0.10~1.00	
		110304-VP1															●		●	●	●		●			0.03~0.18	0.15~1.20	
Finishing [High precision]	VPGT	110301MFN-VP1															●			●						0.02~0.15	0.05~0.50	
		110302MFN-VP1															●			●						0.02~0.18	0.10~1.00	
		110304MFN-VP1															●			●						0.03~0.18	0.15~1.20	

Cutting edge geometry A52~A61
 Recommended chip breaker B04~B11
 Code system B26~B27
 ● : Stock item

Available tool holders			
Designation	Page	Designation	Page
SVABR/L	B183	SVVBN	B184
SVJBR/L	B115, 183		



WB

Dimensions (mm)			
Size	d	t	d ₁
02	3.97	1.59	2.2
S3	4.76	2.38	2.4

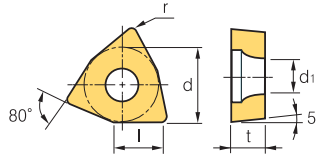

Trigon 80° Positive
Relief Angle: 5°

Workpiece	Material Groups																Machining types	
	P	M	K	N	S	H	1	2	3	4	5	6	7	8	9	10	●	⊙
Steel	●	●	●	●	●	●	●	●	●	●	●	●	●	●	●	●	●	⊙
Stainless steel	●	●	●	●	●	●	●	●	●	●	●	●	●	●	●	●	●	⊙
Cast iron	●	●	●	●	●	●	●	●	●	●	●	●	●	●	●	●	●	⊙
Non-ferrous metal	●	●	●	●	●	●	●	●	●	●	●	●	●	●	●	●	●	⊙
Heat resistant alloy, Titanium alloy	●	●	●	●	●	●	●	●	●	●	●	●	●	●	●	●	●	⊙
Hardened steel	●	●	●	●	●	●	●	●	●	●	●	●	●	●	●	●	●	⊙

Inserts	Designation	Cermet		Coated		Coated										Uncoated		Cutting Condition										
		CN1500	CN2000	CN2500	CC1500	CC2500	NC3215	NC3120	NC3225	NC3030	NC5330	NC6310	NC6315	NC9115	NC9125	NC9135	PC5300	PC5400	PC8105	PC8110	PC8115	PC9030	H01	H05	f _n (mm/rev)	a _p (mm)		
Medium to finishing	WBGT 020102R																									0.01~0.05	0.10~0.30	
	S30204R																										0.01~0.10	0.10~0.50
	020102L	●																				●	●			0.01~0.08	0.10~0.40	
	S30202L																										0.01~0.08	0.10~0.40
	S30204L																										0.01~0.10	0.10~0.50

➡ Cutting edge geometry **A52~A61**
➡ Recommended chip breaker **B04~B11**
➡ Code system **B26~B27**
● : Stock item

Available tool holders			
Designation	Page	Designation	Page
SWUBR/L	B216		

Technical Information for Aluminum

AK special chip breaker for aluminum

- Unique and 3-dimensional rake angle controls chip breaking and chip flow ensuring longer tool life and reducing cutting load
- High rake angle at cutting edge part reduces cutting load to increase tool life
- Buffed finish on top face controls chip flow reducing built-up edge



- 1 High rake angle & tabby pattern chip pocket - Low cutting load
- 2 Unique rake angle design - Effective chip breaking and good chip flow
- 3 Unique and 3-dimensional top face - Longer tool life & Excellent surface roughness
- 4 Tabby pattern & Sharp cutting edge - Distributing cutting load, long tool life
- 5 Buffed on top face - Excellent machining, Reducing built-up edge, Excellent chip flow

AR special chip breaker for aluminum

- AR chip breaker ensures reliability and good cutting performance at high feed, speed and interrupted machining



- 1 Flat corner cutting edge improved productivity at high feed machining and ensures good surface roughness and reliability owing to strong cutting edge
- 2 Specially buffed on top face controls chip flow reducing built-up edge
- 3 KORLOY's own technology applied for cutting edge and corner shape controlling chip flow ensures longer tool life
- 4 KORLOY special chip breaker design controls chip flow at high speed machining

AK and AR chip breaker specially developed for aluminum

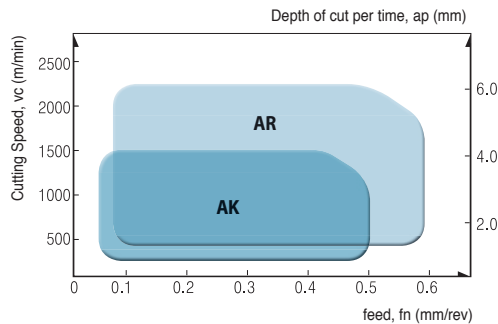

	Recommendation range	Grades
AK	$a_p = 0.1 \sim 5.0$ mm $f_n = 0.03 \sim 0.5$ mm/rev	H01 (Uncoated cemented carbides K10~K20) ND1000 (Diamond coating) PD1000 (DLC coating)
AR	$a_p = 0.5 \sim 6.0$ mm $f_n = 0.05 \sim 0.6$ mm/rev	H01 (Uncoated cemented carbides K10~K20) ND1000 (Diamond coating) PD1000 (DLC coating)

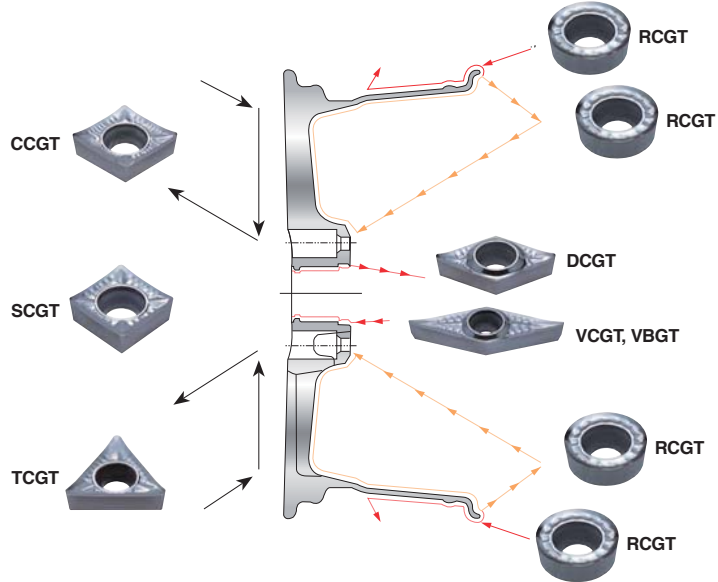

Features of H01 and cutting conditions

- Good for aluminum and alloy steel machining - Surface treatment reduces built-up edge
- 3-dimensional design reduces cutting resistance and ensures high machinability in high feed and speed machining

Workpiece		Hardness (HB)	k_c (MPa)	v_c (m/min)	f_n (mm/rev)
Aluminum alloy (forged)	before heat treatment	50~70	500~600	1000~2500	0.1~0.6
	after heat treatment	90~110	700~900	300~1000	0.1~0.5
Aluminum alloy (cast)	before heat treatment	70~80	700~800	300~1000	0.1~0.6
	after heat treatment	80~100	800~950	200~600	0.1~0.4
Copper alloy	-	90~110	700	250~600	0.1~0.5
Non-ferrous metal, etc	-	100	1700	150~300	0.1~0.6



CC ○ ○

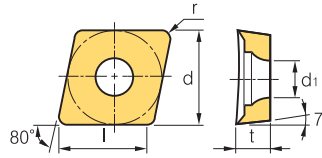

 Rhombic **80° Positive**
Relief Angle: 7°



Dimensions (mm)			
Size	d	t	d ₁
06	6.35	2.38	2.8
09	9.525	3.97	4.4
12	12.7	4.76	5.5

Workpiece	Steel	P					Machining types
	Stainless steel	M					
	Cast iron	K					
	Non-ferrous metal	N	✱	●	✱	✱	
	Heat resistant alloy, Titanium alloy	S					
Hardened steel	H						

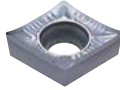
● Continuous cutting
 ● General cutting
 ✱ Interrupted cutting

Inserts	Designation	Coated			Uncoated		Cutting Condition		
		PC5040	PD1000	PD1010	H01	H05	fn (mm/rev)	ap (mm)	
AK 	CCGT	060202-AK	●			●	●	0.01~0.12	0.05~3.00
		060204-AK	●		●	●	●	0.02~0.15	0.10~3.00
		060208-AK				●	●	0.02~0.20	0.10~4.00
		09T302-AK	●		●	●	●	0.02~0.20	0.05~3.00
		09T304-AK	●		●	●	●	0.02~0.30	0.10~5.00
		09T308-AK	●			●	●	0.03~0.50	0.10~5.00
		120402-AK				●	●	0.02~0.30	0.05~4.00
		120404-AK	●		●	●	●	0.03~0.50	0.10~5.00
		120408-AK				●	●	0.04~0.80	0.10~5.50
	AR 	CCGT	060202-AR				●	●	0.02~0.30
		060204-AR						0.03~0.35	0.50~4.50
		060208-AR						0.04~0.50	0.50~4.50
		09T302-AR				●	●	0.03~0.45	0.30~4.00
		09T304-AR				●	●	0.04~0.50	0.50~4.50
		09T308-AR				●	●	0.05~0.60	0.50~6.00
		120402-AR						0.04~0.50	0.30~5.00
		120404-AR				●	●	0.05~0.60	0.50~6.00
		120408-AR				●	●	0.06~0.65	0.50~6.00
		120412-AR						0.08~0.70	0.50~6.50

 Cutting edge geometry **A52~A61**
  Recommended chip breaker **B04~B11**
  Code system **B26~B27**
 ● : Stock item

Available tool holders			
Designation	Page	Designation	Page
SCACR/L	B113, 178	SCLCR/L	B113, 178, 204

B Aluminum Insert (Positive)

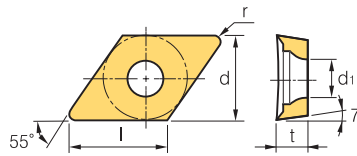

DC ○○

 Rhombic **55° Positive**
Relief Angle: 7°



Dimensions (mm)			
Size	d	t	d ₁
07	6.35	2.38	2.8
11	9.525	3.97	4.4

Workpiece	Steel	P						Machining types	
	Stainless steel	M							● Continuous cutting
Cast iron	K							● General cutting	
Non-ferrous metal	N	✱	●	✱	●	✱		✱ Interrupted cutting	
Heat resistant alloy, Titanium alloy	S								
Hardened steel	H								

Inserts	Designation	Coated			Uncoated		Cutting Condition	
		PC5040	PD1000	PD1010	H01	H05	f _n (mm/rev)	a _p (mm)
AK 	DCGT 070202-AK	●			●	●	0.01~0.20	0.05~3.00
	070204-AK	●		●	●	●	0.02~0.30	0.10~4.00
	070208-AK	●			●	●	0.03~0.40	0.10~4.00
	11T302-AK	●		●	●	●	0.02~0.30	0.05~4.00
	11T304-AK	●	●	●	●	●	0.03~0.50	0.10~5.00
	11T308-AK	●		●	●	●	0.03~0.50	0.10~5.00
	11T312-AK				●	●	0.04~0.60	0.15~5.00
AR 	DCGT 070202-AR				●	●	0.02~0.30	0.30~4.00
	070204-AR				●	●	0.03~0.40	0.50~5.00
	070208-AR				●	●	0.04~0.50	0.50~5.00
	11T302-AR						0.03~0.45	0.30~6.00
	11T304-AR				●	●	0.04~0.50	0.50~6.00
	11T308-AR				●	●	0.05~0.60	0.50~6.00
	11T312-AR				●	●	0.08~0.65	0.50~6.50

 Cutting edge geometry **A52~A61**
 Recommended chip breaker **B04~B11**
 Code system **B26~B27**
●: Stock item

Available tool holders			
Designation	Page	Designation	Page
SDACR/L	B178	SDQCR/L	B206
SDJCR/L	B113, 179	SDUCR/L	B207
SDNCN	B114, 179	SDZCR/L	B208





RC ○○

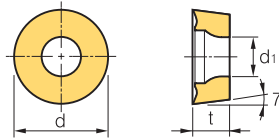

 Round **Positive**
Relief Angle: 7°



Dimensions (mm)			
Size	d	t	d ₁
06	6.0	2.38	2.8
08	8.0	3.18	3.35
10	10.0	3.18~3.97	4.4
12	12.0	4.76	4.4

Workpiece	Steel	P					Machining types
	Stainless steel	M					
Cast iron	K						● Continuous cutting
Non-ferrous metal	N	✱	●	✱	✱	✱	● General cutting
Heat resistant alloy, Titanium alloy	S						✱ Interrupted cutting
Hardened steel	H						

Inserts	Designation	Coated			Uncoated		Cutting Condition		
		PC5040	PD1000	PD1010	H01	H05	f _n (mm/rev)	a _p (mm)	
AK 	RCGT	0602M0-AK			●	●	0.05~0.20	0.50~2.00	
		0803M0-AK			●	●	0.05~0.25	0.50~2.50	
		1003M0-AK			●	●	0.10~0.30	1.00~3.00	
		10T3M0-AK					0.10~0.30	1.00~3.00	
		1204M0-AK				●	●	0.10~0.35	1.00~3.50
AR 	RCGT	0602M0-AR					0.05~0.20	0.50~2.00	
		0803M0-AR					0.05~0.25	0.50~2.50	
		1003M0-AR				●	●	0.10~0.30	1.00~3.00
		10T3M0-AR						0.10~0.30	1.00~3.00
		1204M0-AR						0.10~0.35	1.00~3.50

 Cutting edge geometry **A52~A61**
  Recommended chip breaker **B04~B11**
  Code system **B26~B27**
 ● : Stock item

Available tool holders			
Designation	Page	Designation	Page
SRDCN	B179	SRGCR/L	B180

B Aluminum Insert (Positive)

SC ○○

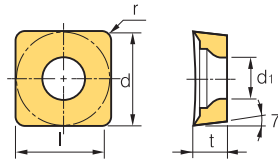

 Square **90° Positive**
Relief Angle: 7°

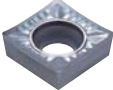
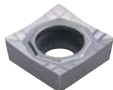

Dimensions (mm)			
Size	d	t	d ₁
09	9.525	3.97	4.4
12	12.7	4.76	5.5

Workpiece	Machining types						
	Steel	P					
Stainless steel	M						
Cast iron	K						
Non-ferrous metal	N	✱	●	✱	●	✱	
Heat resistant alloy, Titanium alloy	S						
Hardened steel	H						

Inserts	Designation	Coated			Uncoated		Cutting Condition	
		PC5040	PD1000	PD1010	H01	H05	f _n (mm/rev)	a _p (mm)
	SCGT 09T302-AK	●				●	0.02~0.30	0.10~4.00
	09T304-AK	●			●	●	0.04~0.40	0.10~5.00
	09T308-AK				●	●	0.03~0.40	0.10~5.00
	120404-AK				●	●	0.03~0.50	0.10~5.00
	120408-AK				●	●	0.04~0.60	0.15~5.50
	120416-AK						0.04~0.60	0.15~5.50
	SCGT 09T302-AR						0.03~0.40	0.50~5.00
	09T304-AR				●	●	0.04~0.50	0.50~6.00
	09T308-AR						0.04~0.50	0.50~6.50
	120404-AR				●	●	0.05~0.60	0.50~6.50
	120408-AR						0.05~0.60	0.50~7.00
	120416-AR						0.05~0.60	0.50~7.00

 Cutting edge geometry **A52~A61**
 Recommended chip breaker **B04~B11**
 Code system **B26~B27**
●: Stock item

Available tool holders			
Designation	Page	Designation	Page
SSBCR/L	B180	SSKCR/L	B181
SSDCN	B180	SSSCR/L	B181



TC

 **Triangular 60° Positive**
Relief Angle: 7°

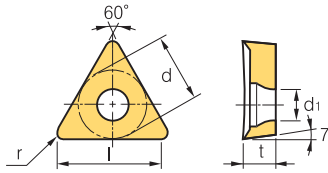

Dimensions (mm)			
Size	d	t	d ₁
09	5.56	2.38	2.5
11	6.35	2.38	2.8
16	9.525	3.97	4.4

Workpiece	Steel	P						Machining types	
	Stainless steel	M							● Continuous cutting
Cast iron	K							● General cutting	
Non-ferrous metal	N	✱	●	✱	✱	✱	✱	✱ Interrupted cutting	
Heat resistant alloy, Titanium alloy	S								
Hardened steel	H								

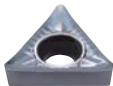
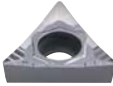
Inserts	Designation	Coated		Uncoated		Cutting Condition		
		PC5040	PD1000	H01	H05	f _n (mm/rev)	a _p (mm)	
AK 	TCGT			●	●	0.01~0.12	0.05~3.00	
		090202-AK			●	●	0.02~0.15	0.10~4.00
		090204-AK	●		●	●	0.02~0.20	0.05~4.00
		110202-AK	●		●	●	0.03~0.30	0.10~4.00
		110204-AK			●	●	0.03~0.40	0.10~5.00
		110208-AK			●	●	0.02~0.30	0.05~5.00
		16T302-AK			●	●	0.03~0.40	0.10~5.50
		16T304-AK			●	●	0.03~0.50	0.10~5.50
		16T308-AK			●	●	0.04~0.60	0.15~5.50
		16T312-AK			●	●	0.05~0.80	0.15~5.50
		16T316-AK			●	●	0.06~0.90	0.20~7.00
	16T325-AK							
AR 	TCGT			●	●	0.02~0.18	0.30~3.00	
		090202-AR			●	●	0.02~0.25	0.30~5.00
		090204-AR			●	●	0.02~0.30	0.30~4.00
		110202-AR			●	●	0.03~0.40	0.30~5.00
		110204-AR			●	●	0.04~0.45	0.50~6.00
		110208-AR			●	●	0.03~0.45	0.30~5.00
		16T302-AR			●	●	0.04~0.50	0.50~6.00
		16T304-AR			●	●	0.05~0.60	0.50~6.00
		16T308-AR			●	●	0.06~0.65	0.50~6.00
		16T312-AR					0.08~0.70	0.50~6.50
		16T316-AR					0.10~0.10	0.80~7.00
	16T325-AR							

 Cutting edge geometry **A52~A61**
 Recommended chip breaker **B04~B11**
 Code system **B26~B27**
● : Stock item

Available tool holders			
Designation	Page	Designation	Page
STACR/L	B114,181	STTCR/L	B182, 235
STFCR/L	B182, 234	STWCR/L	B235
STGCR/L	B182		



B Aluminum Insert (Positive)

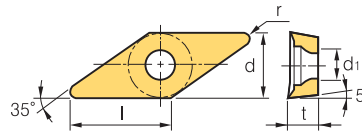

VB ○○

 Rhombic **35° Positive**
Relief Angle: 5°



Dimensions (mm)			
Size	d	t	d ₁
11	6.35	3.18	2.8
16	9.525	4.76	4.4

Workpiece	Steel	P					Machining types
	Stainless steel	M					
Cast iron	K						
Non-ferrous metal	N	✱	●	✱	●	✱	
Heat resistant alloy, Titanium alloy	S						
Hardened steel	H						

Inserts	Designation	Coated			Uncoated		Cutting Condition	
		PC5040	PD1000	PD1010	H01	H05	fn (mm/rev)	ap (mm)
AK 	VBGT 110302-AK				●	●	0.02~0.15	0.05~3.00
	110304-AK				●	●	0.02~0.15	0.10~4.00
	110308-AK					●	0.03~0.18	0.10~5.00
	160402-AK						0.03~0.30	0.05~4.00
	160404-AK				●	●	0.03~0.40	0.10~5.00
	160408-AK				●	●	0.03~0.50	0.10~5.00
	160412-AK					●	0.05~0.60	0.10~5.50
AR 	VBGT 110302-AR						0.02~0.35	0.30~3.00
	110304-AR						0.03~0.45	0.30~4.00
	110308-AR						0.03~0.50	0.50~6.00
	160402-AR						0.04~0.45	0.30~5.00
	160404-AR				●	●	0.04~0.50	0.50~6.00
	160408-AR				●	●	0.05~0.60	0.50~6.00
	160412-AR						0.05~0.70	0.50~6.50

➡ Cutting edge geometry **A52~A61**

➡ Recommended chip breaker **B04~B11**

➡ Code system **B26~B27**

●: Stock item

Available tool holders			
Designation	Page	Designation	Page
SVABR/L	B183	SVVBN	B184
SVHBR/L	B183	SVQBR/L	B211
SVJBR/L	B115, 183	SVUBR/L	B212



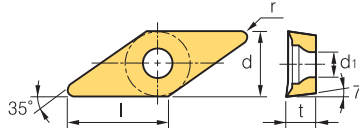

VC ○○

Rhombic 35° Positive
Relief Angle: 7°



Dimensions (mm)			
Size	d	t	d ₁
11	6.35	3.18	2.8
13	7.94	3.18	3.4
16	9.525	4.76	4.4
22	12.7	5.56	5.6

Workpiece	Steel	P						Machining types	
	Stainless steel	M							● Continuous cutting
Cast iron	K							● General cutting	
Non-ferrous metal	N	✱	●	✱	✱	✱		✱ Interrupted cutting	
Heat resistant alloy, Titanium alloy	S								
Hardened steel	H								

Inserts	Designation	Coated			Uncoated		Cutting Condition	
		PC5040	PD1000	PD1010	H01	H05	f _n (mm/rev)	a _p (mm)
AK 	VC GT	110301-AK			●		0.02~0.15	0.05~3.00
	110302-AK	●			●	●	0.02~0.20	0.05~3.00
	110304-AK	●		●	●	●	0.02~0.25	0.10~4.00
	110308-AK				●	●	0.03~0.30	0.10~5.00
	130302-AK	●			●	●	0.02~0.35	0.10~5.00
	130304-AK	●			●	●	0.03~0.35	0.10~5.00
	130308-AK						0.04~0.40	0.10~5.00
	160402-AK				●	●	0.02~0.30	0.05~5.00
	160404-AK		●	●	●	●	0.03~0.40	0.10~5.00
	160408-AK			●	●	●	0.03~0.50	0.10~5.00
	160412-AK				●	●	0.03~0.50	0.10~5.00
	220516-AK				●	●	0.03~0.60	0.10~7.00
	220525-AK					●	0.05~0.70	0.10~7.00
	220530-AK				●	●	0.08~1.00	0.10~7.00
AR 	VC GT	110301-AR					0.02~0.20	0.10~3.00
	110302-AR				●	●	0.02~0.25	0.30~3.00
	110304-AR				●	●	0.03~0.35	0.30~4.00
	110308-AR						0.04~0.45	0.50~6.00
	130302-AR					●	0.02~0.40	0.50~3.00
	130304-AR				●	●	0.03~0.45	0.50~4.00
	130308-AR						0.04~0.50	0.50~5.00
	160402-AR				●	●	0.03~0.40	0.30~5.00
	160404-AR				●	●	0.04~0.50	0.50~6.00
	160408-AR				●	●	0.05~0.60	0.50~6.00
	160412-AR						0.06~0.65	0.50~6.50
	220516-AR						0.10~0.65	0.80~6.50
	220525-AR						0.10~0.70	0.80~7.00
	220530-AR				●	●	0.12~0.75	1.00~7.00

Cutting edge geometry **A52~A61**
 Recommended chip breaker **B04~B11**
 Code system **B26~B27**
 ● : Stock item

Available tool holders			
Designation	Page	Designation	Page
SVJCR/L	B115, 184, 211	SVQCR/L	B212
SVVCN	B184	SVUCR/L	B212



cBN

Multi-Corner Type (Negative)

Dimensions (mm)			
Size	d	t	d ₁
12	12.7	4.76	5.16
15	12.7	4.76~6.358	3.4
16	9.525	4.76	3.81

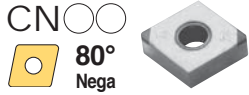
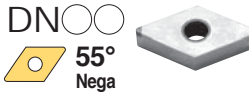
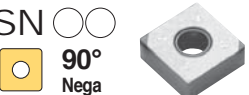
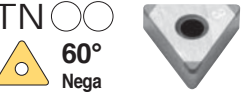
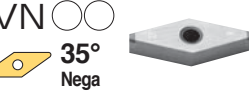
Inserts	Designation	Coated										Uncoated										Available tool holders				
		DNC250	DNC350	DNC400	DB1000	DB2000	DBN400	DBN250	DBN300	DBN700A	DBN20	DNC250	DNC350	DNC400	DB1000	DB2000	DBN400	DBN250	DBN300	DBN700A	DBN20	Designation	Page			
 <p>CN 80° Nega</p>	2NU-CNGA	120404	●	●		●	●															DCBNR/L	DCLNR/L	B154	B154	
			120404F	●				●															MCKNR/	MCLNR/L	B171	B171
			120404T	●			●	●															MCMNN	PCBNR/L	B171	B159
			120404W	●																			PCLNR/L		B160	
			120404WF	●																						
			120408	●	●		●	●																		
			120408F	●				●																		
			120408T	●			●	●																		
			120408W	●	●		●	●																		
			120408WF	●				●																		
			120408WT					●	●																	
			120412	●	●																					
			120412F	●																						
			120412T	●																						
			120412W	●				●	●																	
			120412WF	●					●																	
			120412WT					●	●																	
		T-2NU-CNGA	120408	●																						
	2NU-CNMA	120404															●									
		120408															●									
	2NS-CNGA	120408			●						●															
 <p>DN 55° Nega</p>	2NU-DNGA	150404	●	●		●	●				●											DDJNR/L	MDJNR/L	B155	B172	
		150404F	●				●																MDNNN	MDQNR/L	B172	B173
		150404T	●				●	●															MDUNR/L	PDJNR/L	B202	B160
		150408	●	●			●	●			●												PDNNR/L	PDSNR/L	B161	B197
		150408F	●					●															PDUNR/L		B198	
		150408T	●				●	●																		
		150412	●	●																						
		150412F	●																							
		150412T	●																							
		150608																								●
		T-2NU-DNGA	150412	●																						
		2NS-DNGA	150408			●						●														
	 <p>SN 90° Nega</p>	4NU-SNGA	120404	●			●	●															DSBNR/L	MSBNR/L	B155	B173
			120404F						●															MSDNN	MSKNR/L	B173
		120404T					●	●															MSRNR/L	MSSNR/L	B174	B175
		120408	●				●	●															PSBNR/L	PSDNN	B163	B163
		120408F						●															PSKNR/L		B164	
		120408T					●	●																		
		120412																							●	
		2NS-SNGA	120408			●						●														
 <p>TN 60° Nega</p>	3NU-TNGA	160404	●	●		●	●				●											MTENN	MTFNR/L	B175	B175	
		160404F	●					●															MTGNR/	MTJNR/L	B176	B176
		160404T	●				●	●															PTFNR/L	PTGNR/L	B165	B165
		160408	●	●			●	●															PTTNR/L	WTENN	B166	B167
		160408F	●					●															WTJNR/L	WTXNR/L	B167	B167
		160408T	●				●	●																		
		160412		●																						
		2NS-TNGA	160408			●						●														
 <p>VN 35° Nega</p>	2NU-VNGA	160404	●	●		●	●				●												MVJNR/L		B176	
		160404F	●					●																MVQNR/L		B177
		160404T	●				●	●																MVUNR/L		B203
		160408	●	●			●	●			●													MVVNN		B177
		160408F	●					●																		
		160408T	●				●	●																		
		2NS-VNGA	160408			●						●														





● : Stock item

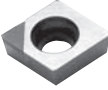

cBN

Multi-Corner Type (Positive)

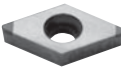
Dimensions (mm)			
Size	d	t	d ₁
06	6.35	2.38	2.8
07	6.35	2.38	2.8
09	9.525	3.97	4.4
11	9.525	3.97	4.4

Inserts	Designation	Coated			Uncoated						Available tool holders			
		DNC250	DNC350	DNC400	DB1000	DB2000	DBN400	DBN250	DBN300	DBN700A	DBNX20	Designation	Page	
 	2NU-CCGW	060202	●									SCACR/L	B178	
		060202F	●										SCLCR/L	B178
		060202T	●											
		060204	●			●	●							
		060204F	●				●							
		060204T	●			●	●							
		060208				●	●							
		060208F					●							
		060208T				●	●							
		09T304	●	●		●	●		●		●			
		09T304F	●				●							
		09T304T	●			●	●							
		09T308	●	●		●	●		●		●			
		09T308F	●				●							
		09T308T	●			●	●							
		09T308W	●											
		09T308WF	●											
 	2NU-DCGW	070204				●	●					SDACR/L	B178	
		070204F					●						SDJCR/L	B179
		070204T					●	●					SDNCN	B179
		070208					●	●					SDQCR/L	B206
		070208F						●					SDUCR/L	B207
		070208T					●	●					SDZCR/L	B208
		11T304	●	●		●	●		●		●			
		11T304F	●				●							
		11T304T	●			●	●							
		11T308	●	●		●	●		●		●			
		11T308F	●				●							
11T308T	●			●	●									
	T-2NU-DCGW	11T304	●											
 	3NU-TCGW	090204	●									STACR/L	B181	
		090204F	●										STFCR/L	B182
		090204T	●										STGCR/L	B182
													STTCR/L	B182





●: Stock item



cBN

Multi-Corner Type (Positive)

Dimensions (mm)			
Size	d	t	d _i
11	6.35	3.18	2.4
16	9.525	4.76	3.81

Inserts	Designation	Coated			Uncoated						Available tool holders			
		DNC250	DNC350	DNC400	DB1000	DB2000	DBN400	DBN250	DBN300	DBN700A	DBN20	Designation	Page	
 <p>TP 60° Posi</p>	3NU-TPGB	110304	●					●				CTFPR/L	B170	
		110304F	●										CTGPR/L	B170
		110304T	●											
		110308	●						●					
		110308F	●											
		110308T	●											
 <p>TP 60° Posi</p>	3NU-TPGN	110304				●	●					CTFPR/L	B170 B201	
		110304F						●				CTGPR/L	B170	
		110304T					●	●						
		110308					●	●						
		110308F						●						
		110308T					●	●						
		160304	●	●										
160308	●	●												
 <p>TPG 35° Posi</p>	3NU-TPGW	110304	●	●		●	●				●			
		110304F	●				●							
		110304T	●				●	●						
		110308	●	●			●	●				●		
		110308F	●					●						
		110308T	●				●	●						
 <p>VB 35° Posi</p>	2NU-VBGW	160404	●	●		●	●		●		●	SVABR/L	B183	
		160404F	●				●						SVHBR/L	B183
		160404T	●				●	●					SVJBR/L	B183
		160408	●	●			●	●		●		●	SVQBR/L	B211
		160408F	●					●					SVUBR/L	B212
		160408T	●				●	●						
 <p>VC 35° Posi</p>	2NU-VCGW	160404	●	●		●	●				●			
		160404F	●				●							
		160404T	●				●	●						
		160408	●	●			●	●				●		
		160408F	●					●						
		160408T	●				●	●						

● : Stock item







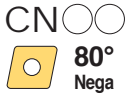

cBN

Regrinding Type (Negative/Positive)

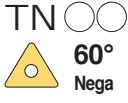
Dimensions (mm)			
Size	d	t	d ₁
09	9.525	3.97	4.4
11	6.35~9.525	3.8~3.97	3.4~4.4
12	12.7	4.76	5.16

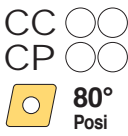
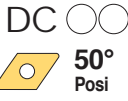
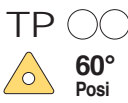
Dimensions (mm)			
Size	d	t	d ₁
15	12.7	4.76	5.16
16	9.525	4.76	3.81~4.4

Inserts	Designation	Coated			Uncoated				Available tool holders					
		DNC250	DNC350	DNC400	DB1000	DB2000	DBN400	DBN250	DBN300	DBN700A	DBNX20	Designation	Page	
 CN ○○ 80° Nega	CNMA	120404					●				DCBNR/L	MCKNR/L	B154	B171
		120408					●			●	DCLNR/L	MCLNR/L	B154	B171
	T-CNMA	120408					●				PCBNR/L	MCMNN	B159	B171
							●				PCLNR/L		B160	
 DN ○○ 55° Nega	DNMA	150404					●				DDJNR/L	MDJNR/L	B155	B172
		150408					●	●			MDNNN	MDQNR/L	B172	B173
											MDUNR/L	PDJNR/L	B202	B160
											PDNNR/L	PDSNR/L	B161	B197
											PDUNR/L		B198	
 SN ○○ 90° Nega	SNMA	120404					●				DSBNR/L	MSBNR/L	B155	B173
		120408					●				MSDNN	MSKNR/L	B173	B174
											MSRNR/L	MSSNR/L	B174	B175
											PSBNR/L	PSDNN	B163	B163
											PSKNR/L		B164	
 TN ○○ 60° Nega	TNMA	160404					●				MTENNS	MTFNR/L	B175	B175
		160408					●				MTGNR/L	MTJNR/L	B176	B176
											PTFNR/L	PTGNR/L	B165	B165
											PTTNR/L	WTENN	B166	B167
											WTJNR/L	WTXNR/L	B167	B167
 VN ○○ 35° Nega	VNMA	160404					●				MVJNR/L		B176	
		160408					●				MVQNR/L		B177	
	T-VNMA	160404					●				MVUNR/L		B203	
											MVVNN		B177	
 CC ○○ CP ○○ 80° Posi	CCMW	09T304					●				SCACR/L		B178	
											SCLCR/L		B178	
 DC ○○ 50° Posi	DCGW	11T308					●				SDACR/L		B178	
	T-DCGW	11T308					●				SDJCR/L		B179	
											SDNCN		B179	
 TP ○○ 60° Posi	TPGB	110304					●	●			CTFPR/L		B170	B201
		110308					●				CTGPR/L		B170	
 VB ○○ 35° Posi	VBMW	160404					●				SVABR/L		B183	
		160408					●				SVHBR/L		B183	
											SVJBR/L		B183	
											SVQBR/L		B211	
											SVUBR/L		B212	

●: Stock item





PCD

Insert (Negative/Positive)

Dimensions (mm)			
Size	d	t	d ₁
06	6.35	2.38	2.8
07	6.35	2.38	2.8
08	7.94	2.38	3.4
09	9.525	3.18	4.4

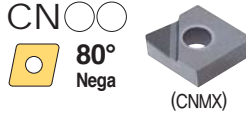
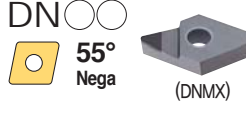
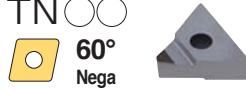
Dimensions (mm)			
Size	d	t	d ₁
11	9.525	3.97	4.4
12	12.7	4.76	5.16
15	12.7	4.76	5.16
16	9.525	4.76	3.81

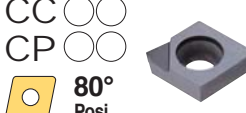
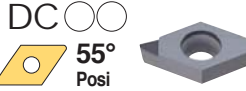
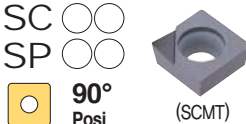
Inserts	Designation	PCD			Available tool holders				
		DP90	DP150	DP200	Designation		Page		
 <p>CN 80° Nega (CNMX)</p>	CNMM	120404	●		DCBNR/L	DCLNR/L	B154	B154	
		120408	●		MCKNR/L	MCLNR/L	B171	B171	
		120412			MCMNN	PCBNR/L	B171	B159	
	CNMX	120404				PCLNR/L		B160	
		120408							
		120412							
 <p>DN 55° Nega (DNMX)</p>	DNMM	150404	●		DDJNR/L	MDJNR/L	B155	B172	
		150408	●		MDNNN	MDQNR/L	B172	B173	
		150412			MDUNR/L	PDJNR/L	B202	B160	
	DNMX	150404				PDNNR/L	PDSNR/L	B161	B197
		150408				PDUNR/L		B198	
		150412							
 <p>TN 60° Nega</p>	TNMX	160404			MTENN	MTFNR/L	B175	B175	
		160408			MTGNR/L	MTJNR/L	B176	B176	
		160412			PTFNR/L	PTGNR/L	B165	B165	
					PTTNR/L	WTENN	B166	B167	
					WTJNR/L	WTXNR/L	B167	B167	
 <p>VN 35° Nega</p>	VNMX	160404			MVJNR/L		B176		
		160408			MVQNR/L		B177		
		160412			MVUNR/L		B203		
					MVVNN		B177		
 <p>CC 80° Posi CP</p>	CCMT	060202	●		SCACR/L		B178		
		060204	●		SCLCR/L		B178		
		060208							
		09T304	●						
		09T308	●						
	CPMT	09T312							
		080204							
		080208							
		080212							
		090304							
		090308							
090312									
 <p>DC 55° Posi</p>	DCMT	070202	●		SDACR/L		B178		
		070204	●		SDJCR/L		B179		
		070208			SDNCN		B179		
		11T302			SDQCR/L		B206		
		11T304	●		SDUCR/L		B207		
		11T308	●		SDZCR/L		B208		
 <p>SC 90° Posi SP (SCMT)</p>	SCMT	09T304			SSBCR/L		B180		
		09T308			SSDCN		B180		
		09T312			SSKCR/L		B181		
	SPGW	090302			SSSCR/L		B181		
		090304							
		090308							

● : Stock item









PCD

Insert (Positive)

Dimensions (mm)			
Size	d	t	d ₁
06	3.97	1.59	2.8
08	4.76	2.38	2.4
09	5.56~9.525	2.38~3.18	2.55

Dimensions (mm)			
Size	d	t	d ₁
11	9.525	3.97	4.4
12	6.35	2.38~3.18	2.8~3.4
16	12.7	3.18	4.4

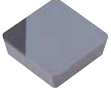
Inserts	Designation	PCD			Available tool holders				
		DP90	DP150	DP200	Designation	Page			
<p>TB ○○ TC ○○ TP ○○</p>  <p>60° Posi</p> 	TBGW	060102 060104				STUBR/L B214			
	TCMT	090201 090202 090204 110201 110202 110204				STACR/L STFCR/L STFPR/L STGCR/L STTCR/L B181 B182 B210 B182 B182			
	TPGB	080204 080208 090204 090208 110304 110308		●					
	TPGW	080202 080204 090204 090208 110302 110304 110308 160404 160408		●					
	TPGT	110302 110304					STFPR/L STUPR/L B210 B215		
	<p>VB ○○ VC ○○</p>  <p>35° Posi</p> 	VBMT	110302 110304 110308 160402 160404 160408 160412	●			SVABR/L SVHBR/L SVJBR/L SVQBR/L SVUBR/L B183 B183 B183 B211 B212		
		VCMT	110302 110304 110308 160404 160408 160412	●			SVJCR SVVCN B184 B184		
		<p>TP ○○</p>  <p>60° Posi</p> 	TPGN	090204 090208 110302 110304 110308 160302 160304 160308	●			CTFPR/L CTGPR/L B170 B170	
			<p>SP ○○</p>  <p>90° Posi</p> 	SPGN	090304 090308 120304 120308	●			CSDPN CSKPR/L B169 B170

●: Stock item



B Technical Information for Save Turn

Economical small insert with powerful cutting performance

SAVE TURN

- Strongly recommended turning insert for machining smaller diameter than $\varnothing 100$
- Small but powerful and economical insert which performs the same like standard-sized inserts under the depth of cut of 3.0 mm



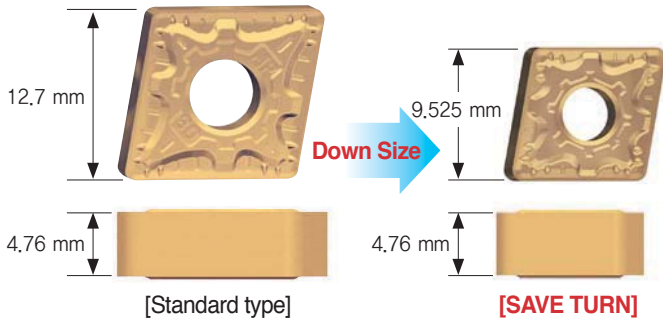

Features

Comparison of insert sizes

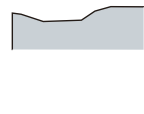

- Optimized size of the same performance like the standard type

Features of chip breaker

Insert shape	Cutting edge	Features
		<ul style="list-style-type: none"> • For finishing steel • Efficient chip breaking and low cutting resistance • Various application available at low depth of cut • Recommended depth of cut: 0.5~2.5 mm
		<ul style="list-style-type: none"> • For medium cutting of steel • 4 dots for improved chip control in medium cutting to finishing • Stable chip evacuation at high depth of cut • Stable tool life due to lower cutting loads at high feed • Recommended depth of cut: 0.5~4.0 mm
		<ul style="list-style-type: none"> • For medium cutting of stainless steel • Limits plastic deformation caused by heat • Stable tool life thanks to the balanced cutting performance and toughness • Stable chip flow at high speeds and feeds • Recommended depth of cut: 0.5~5.0 mm

Application example

Alloy steel (SCM440)

- **Cutting conditions** vc (m/min) = 250, fn (mm/rev) = 0.25
 ap (mm) = 2.0~3.0, continuous cutting, wet

- **Cutting Result**



CNMG090408-HM
SAVE TURN

CNMG120408-HM
Standard type

Comparison of cutting performance

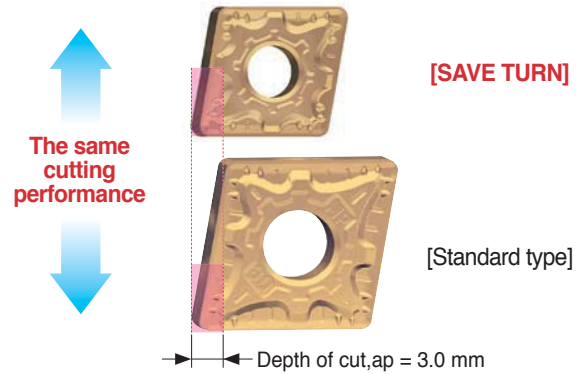

- Performs the same like standard type inserts under the depth of cut of 3.0 mm

Application area of chip breaker

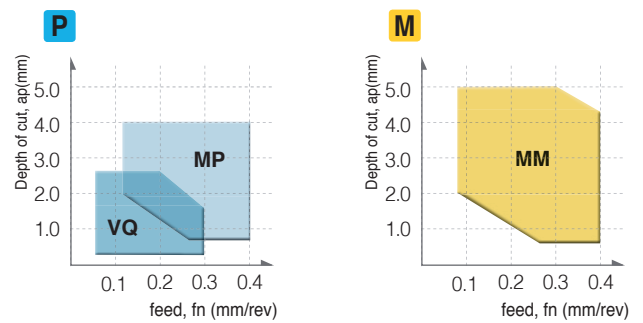

VQ : Depth of cut, ap = 0.5~2.5 mm / feed, fn = 0.05~0.30 mm/rev

MP : Depth of cut, ap = 0.5~4.0 mm / feed, fn = 0.15~0.40 mm/rev

MM : Depth of cut, ap = 0.5~5.0 mm / feed, fn = 0.10~0.40 mm/rev

Alloy steel (SCM440)

- **Cutting conditions** vc (m/min) = 250, fn (mm/rev) = 0.25
 ap (mm) = 2.0~3.0, interrupted cutting, wet

- **Cutting Result**



CNMG090408-HM
SAVE TURN

CNMG120408-HM
Standard type





Type	Picture	Designation	Coated					Dimensions (mm)				cutting conditions		Configuration	Available tool holders page
			NC9215	NC9225	NC5330	NC9125	NC9135	PC9030	d	t	r	d ₁	ap (mm)		
C type		CNMG 090408-VQ			●			9.525	4.76	0.8	3.81	0.50~2.50	0.08~0.30		B106 B109
		090412-VQ			●			9.525	4.76	1.2	3.81	0.50~2.50	0.10~0.30		
		CNMG 090404-MP						9.525	4.76	0.4	3.81	0.50~4.00	0.10~0.40		B106 B109
		090408-MP						9.525	4.76	0.8	3.81	0.50~4.00	0.15~0.40		
		090412-MP						9.525	4.76	1.2	3.81	0.50~4.00	0.15~0.45		
		CNMG 090404-MM						9.525	4.76	0.4	3.81	0.50~5.00	0.08~0.35		B106 B109
		090408-MM						9.525	4.76	0.8	3.81	0.50~5.00	0.10~0.40		
		090412-MM						9.525	4.76	1.2	3.81	0.50~5.00	0.12~0.45		
	D type		DNMG 110508-VQ			●			9.525	5.56	0.4	3.81	0.50~2.50	0.08~0.30	
110512-VQ					●			9.525	5.56	0.8	3.81	0.50~2.50	0.10~0.30		
		DNMG 110504-MP						9.525	5.56	0.4	3.81	0.50~4.00	0.10~0.40		B106 B107 B109 B110
		110508-MP						9.525	5.56	0.8	3.81	0.50~4.00	0.15~0.40		
		110512-MP						9.525	5.56	1.2	3.81	0.50~4.00	0.15~0.45		
		DNMG 110504-MM						9.525	5.56	0.4	3.81	0.50~5.00	0.08~0.35		B106 B107 B109 B110
		110508-MM						9.525	5.56	0.8	3.81	0.50~5.00	0.10~0.40		
		110512-MM						9.525	5.56	1.2	3.81	0.50~5.00	0.12~0.45		
S type			SNMG 090408-VQ			●			9.525	4.76	0.4	3.81	0.50~2.50	0.08~0.30	
	090412-VQ				●			9.525	4.76	0.8	3.81	0.50~2.50	0.10~0.30		
		SNMG 090404-MP						9.525	4.76	0.4	3.81	0.50~4.00	0.10~0.40		B107 B108 B110
		090408-MP						9.525	4.76	0.8	3.81	0.50~4.00	0.15~0.40		
		090412-MP						9.525	4.76	1.2	3.81	0.50~4.00	0.15~0.45		
		SNMG 090404-MM						9.525	4.76	0.4	3.81	0.50~5.00	0.08~0.35		B107 B108 B110
		090408-MM						9.525	4.76	0.8	3.81	0.50~5.00	0.10~0.40		
		090412-MM						9.525	4.76	1.2	3.81	0.50~5.00	0.12~0.45		
	W type		WNMG 060404-VQ						9.525	4.76	0.4	3.81	0.30~2.00	0.06~0.30	
060408-VQ								9.525	4.76	0.8	3.81	0.50~2.00	0.08~0.30		
060412-VQ								9.525	4.76	1.2	3.81	0.50~2.00	0.10~0.30		
		WNMG 060404-MP	●	●	●	●		9.525	4.76	0.4	3.81	0.50~3.50	0.10~0.40		B109 B110
		060408-MP	●	●	●	●		9.525	4.76	0.8	3.81	0.50~3.50	0.15~0.40		
		060412-MP						9.525	4.76	1.2	3.81	0.50~3.50	0.15~0.45		
		WNMG 060404-MM						9.525	4.76	0.4	3.81	0.50~4.00	0.08~0.35		B109 B110
		060408-MM			●	●	●	9.525	4.76	0.8	3.81	0.50~4.00	0.10~0.40		
		060412-MM			●	●	●	9.525	4.76	1.2	3.81	0.50~4.00	0.12~0.45		



B SAVE TURN Holder

PCLNR/L



CN□□

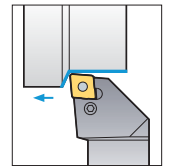
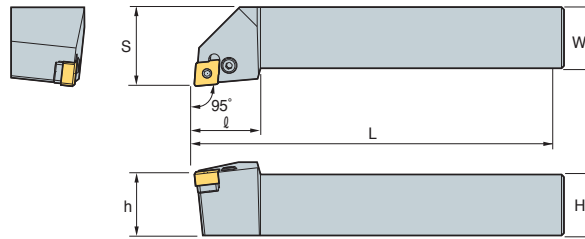

95°

• R type insert (mm)

Designation	H	W	L	S	h	ℓ	Insert	Lever	Screw	Shim	Shim pin	Wrench	Shim Pin Punch
PCLNR/L 1616-H09-4N	16	16	100	20	16	20	CN□□ 0904□□						
2020-K09-4N	20	20	125	25	20	25							
2525-M09-4N	25	25	150	32	25	27							

➔ Applicable inserts B105

PCBNR/L



CN□□

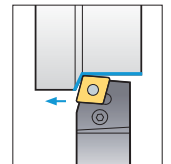
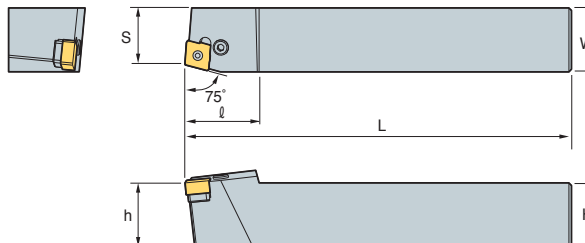

75°

• R type insert (mm)

Designation	H	W	L	S	h	ℓ	Insert	Lever	Screw	Shim	Shim pin	Wrench	Shim Pin Punch
PCBNR/L 2020-K09-4N	20	20	125	17	20	27	CN□□ 0904□□						
2525-M09-4N	25	25	150	22	25	29							

➔ Applicable inserts B105

PDJNR/L



DN□□

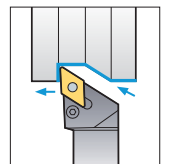
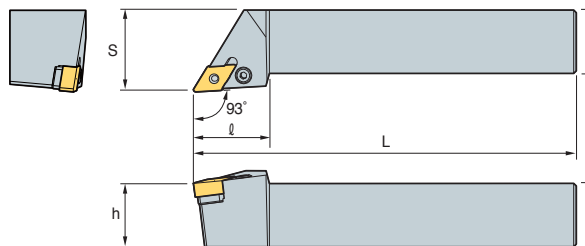

93°

• R type insert (mm)

Designation	H	W	L	S	h	ℓ	Insert	Lever	Screw	Shim	Shim pin	Wrench	Shim Pin Punch
PDJNR/L 2020-K11-5N	20	20	125	25	20	25	DN□□ 1105□□						
2525-M11-5N	25	25	150	32	25	30							

➔ Applicable inserts B105



PDNNR/L



DN□□

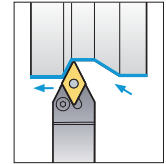
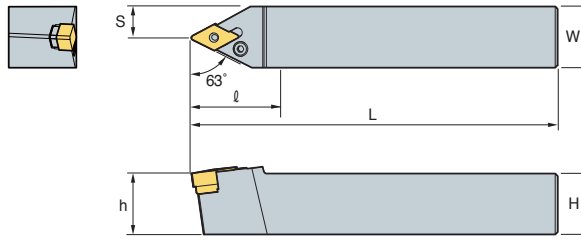

63°

• R type insert
(mm)

Designation	H	W	L	S	h	ℓ	Insert	Lever	Screw	Shim	Shim pin	Wrench	Shim Pin Punch
PDNNR/L 2020-K11-5N	20	20	125	25	20	30	DN□□1105□□						
2525-M11-5N	25	25	150	32	25	30							

↻ Applicable inserts **B105**

PDQNR/L



DN□□

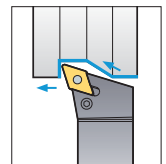
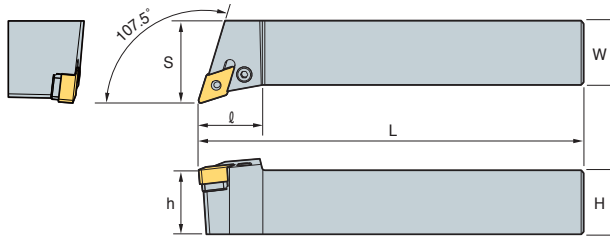

107.5°

• R type insert
(mm)

Designation	H	W	L	S	h	ℓ	Insert	Lever	Screw	Shim	Shim pin	Wrench	Shim Pin Punch
PDQNR/L 2020-K11-5N	20	20	125	25	20	30	DN□□1105□□						
2525-M11-5N	25	25	150	32	25	30							

↻ Applicable inserts **B105**

PSBNR/L

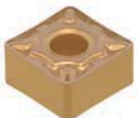

SN□□

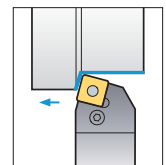
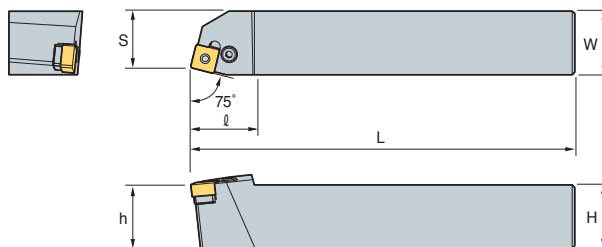

75°

• R type insert
(mm)

Designation	H	W	L	S	h	ℓ	Insert	Lever	Screw	Shim	Shim pin	Wrench	Shim Pin Punch
PSBNR/L 2020-K09-4N	20	20	125	17	20	25	SN□□0904□□						
2525-M09-4N	25	25	150	22	25	25							

↻ Applicable inserts **B105**

B SAVE TURN Holder

PSDNN



SN□□

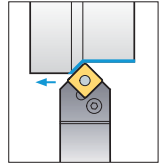
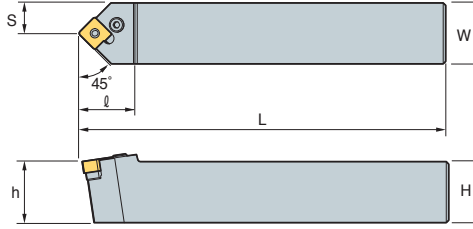

45°

• R type insert (mm)

Designation		H	W	L	S	h	l	Insert	Lever	Screw	Shim	Shim pin	Wrench	Shim Pin Punch
PSDNN	2020-K09-4N	20	20	125	17	20	25	SN□□0904□□						
	2525-M09-4N	25	25	150	22	25	25							

↻ Applicable inserts B105

PSKNR/L



SN□□

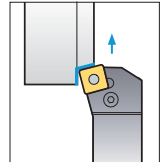
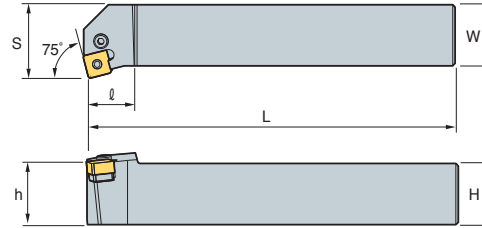

75°

• R type insert (mm)

Designation		H	W	L	S	h	l	Insert	Lever	Screw	Shim	Shim pin	Wrench	Shim Pin Punch
PSKNR/L	2020-K09-4N	20	20	125	17	20	25	SN□□0904□□						
	2525-M09-4N	25	25	150	22	25	25							

↻ Applicable inserts B105

PSSNR/L



SN□□

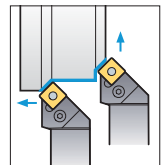
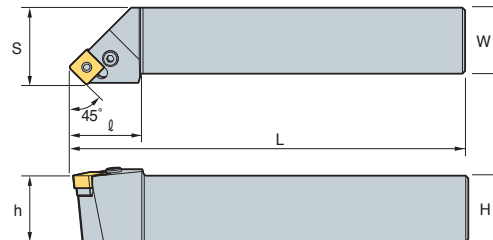

45°

• R type insert (mm)

Designation		H	W	L	S	h	l	Insert	Lever	Screw	Shim	Shim pin	Wrench	Shim Pin Punch
PSSNR/L	2020-K09-4N	20	20	125	17	20	25	SN□□0904□□						
	2525-M09-4N	25	25	150	22	25	25							

↻ Applicable inserts B105



PWLNRL/L



WN□□

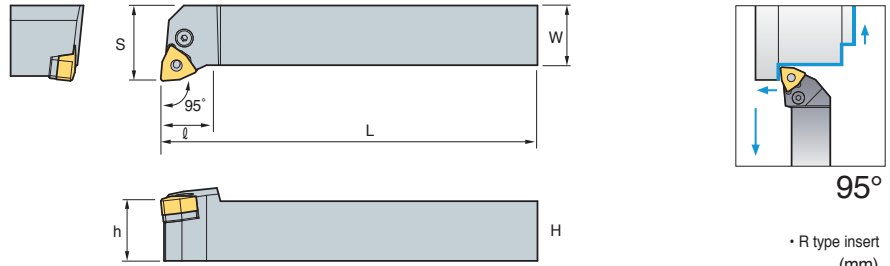

• R type insert (mm)

Designation	H	W	L	S	h	ℓ	Insert	Lever	Screw	Shim	Shim pin	Wrench	Shim Pin Punch
PWLNRL/L 1616-H06	16	16	100	20	16	20	WN□□0604□□						
2020-K06	20	20	125	25	20	20							
2525-M06	25	25	150	32	25	20							

↻ Applicable inserts B105

PCLNR/L



CN□□

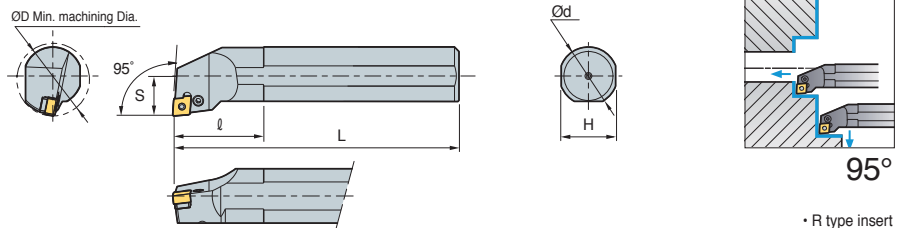

• R type insert (mm)

Designation	ØD	Ød	H	L	S	ℓ	Insert	Lever	Screw	Shim	Shim pin	Wrench	Shim Pin Punch
S20Q-PCLNR/L-09-4N	25	20	18	180	13	50	CN□□0904□□						
S25R-PCLNR/L-09-4N	32	25	23	200	17	50							
S32S-PCLNR/L-09-4N	40	32	30	250	22	50							

↻ Applicable inserts B105

PDUNR/L



DN□□

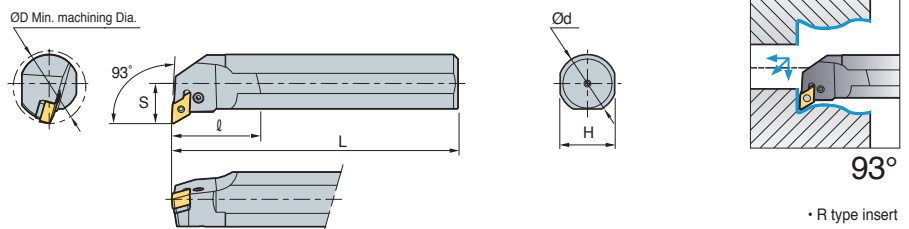

• R type insert (mm)

Designation	ØD	Ød	H	L	S	ℓ	Insert	Lever	Screw	Shim	Shim pin	Wrench	Shim Pin Punch
S32S-PDUNR/L-11-5N	40	32	30	250	22	30	DN□□1105□□						
S40T-PDUNR/L-11-5N	50	40	38	300	27	50							

↻ Applicable inserts B105

PDZNR/L



DN□□

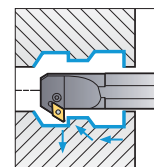
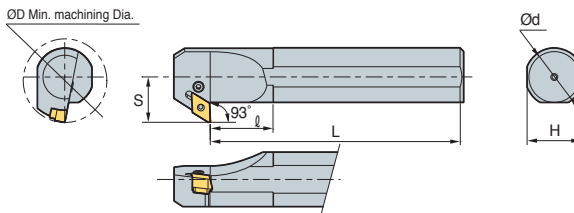

93°

• R type insert (mm)

Designation	ØD	Ød	H	L	S	ℓ	Insert	Lever	Screw	Shim	Shim pin	Wrench	Shim Pin Punch
S32S-PDZNR/L-11-5N	40	32	30	250	22	30	DN□□1105□□						
S40T-PDZNR/L-11-5N	50	40	38	300	27	50							

↻ Applicable inserts B105

PSKNR/L



SN□□

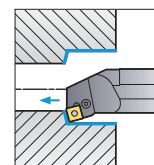
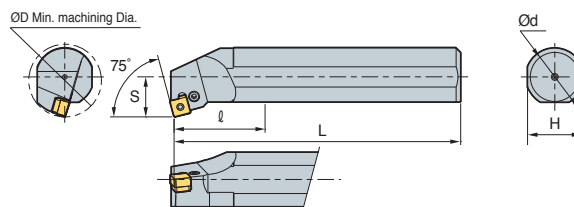

75°

• R type insert (mm)

Designation	ØD	Ød	H	L	S	ℓ	Insert	Lever	Screw	Shim	Shim pin	Wrench	Shim Pin Punch
S25R-PSKNR/L-09-4N	32	25	23	200	17	32	SN□□0904□□						
S32S-PSKNR/L-09-4N	40	32	30	250	22	32							

↻ Applicable inserts B105

PWLNR/L



WN□□

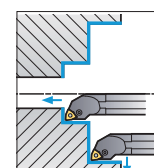
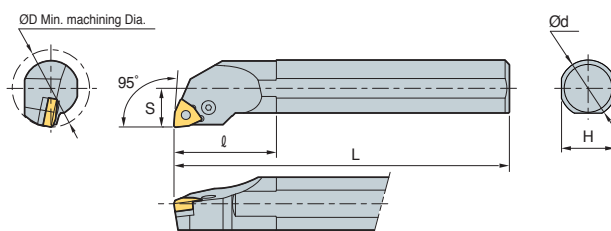

95°

• R type insert (mm)

Designation	ØD	Ød	H	L	S	ℓ	Insert	Lever	Screw	Shim	Shim pin	Wrench	Shim Pin Punch						
S20S-PWLNR/L-06	25	20	18	250	13	40	WN□□0604□□												
S25R-PWLNR/L-06	32	25	23	200	17	40								LV3B	VHX0512B	-	-	-	-
S32S-PWLNR/L-06	44	32	30	250	22	45								LV3B	VHX0617B	SW317	SW317	HW25L	LSPS3

↻ Applicable inserts B105



Excellent for precision machining

Auto Tools

- High precision machining of small parts and complex forms, etc.
- High quality products through stable machining
- Exclusive insert for automatic lathes

Type



Application example

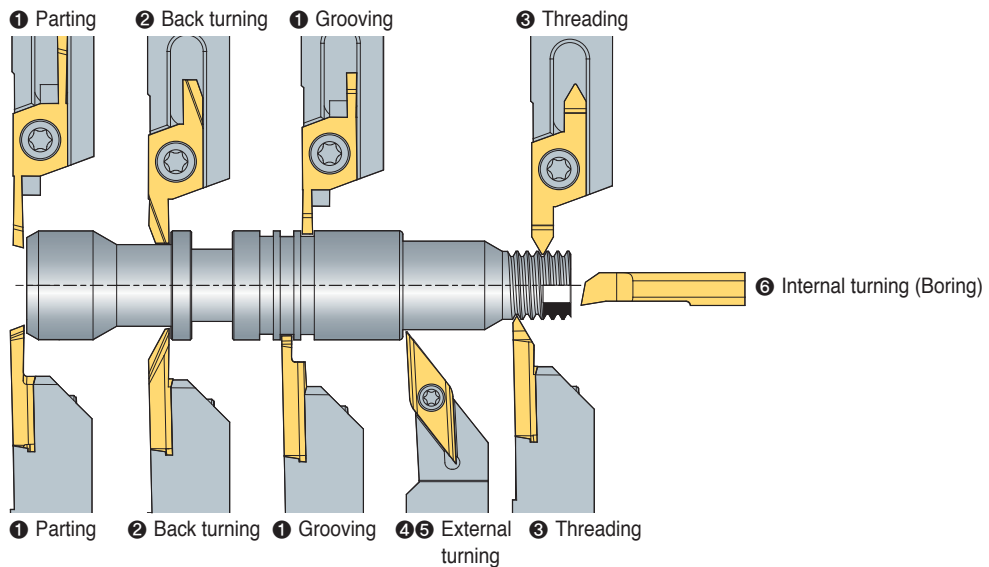

Index

Specification	1 Parting and Grooving						2 Back turning			Specification	3 Threading	
Holder	SXGNR/L	SXGNR/L	SBHR/L	SBHR/L	MGEHR/L	KGEHR/L	SXGNR/L	SXGNR/L	SBHR/L	Holder	SXGNR/L	SBHR/L
Insert	SG	SC	SBG	SBC	MGMN	KGMM	SB	SGB	SBB	Insert	ST	SBT
Holder size	10~20mm	10~20mm	10~16mm	10~16mm	10~16mm	10~16mm	10~20mm	10~20mm	10~16mm	Shank diameter	10~20mm	10~16mm
Insert shape										Insert shape		
Cutting width	1~3mm	1~3mm	0.7~2.0mm	0.7~2.0mm	1.5~2.5mm	1.5~2.5mm	2~4mm	2~3mm	3.18mm	ØDmin	Pitch ranges 0.5~1.5 / 1.5~3.0	Pitch ranges 0.2~1.5 / 1.0~2.0
ØDmax	Ø18	Ø18	Ø16	Ø16	Ø32	Ø32	Tmax 8.0	Tmax 8.5	Tmax 8.0	Page	B125	B122
Page	B125	B125	B122	B122	B129	B129	B125	B125	B122			

Specification	4 External turning and Copy machining				5 External turning and Facing			Specification	6 Internal turning (Boring)				
Holder	SDJCR/L	SDNCN	SVJBR/L	SVJCR/L	SCACR/L	SCLCR/L	STACR/L	Holder	SCLCR/L	STUBR/L	STUPR/L	SWUBR/L	MSB
Insert	DC□T	DC□T	VB□T	VC□T	CC□T	CC□T	TC□T	Insert	CC□T	TB□T	TP□T	WB□T	-
Holder size	8~16mm	8~16mm	10~16mm	10~16mm	8~16mm	8~16mm	8~10mm	Shank diameter	Ø4~Ø10	Ø8	Ø8	Ø5~Ø8	Ø4~Ø6
Insert shape								Insert shape					
Feature	Offset "0"				Offset "0"			ØDmin	Ø5	Ø8	Ø10	Ø5.5	Ø3.2
Page	B113	B114	B115	B115	B113	B113	B114	Page	B214	B214	B215	B216	B132~B136

B Auto Tools (ISO type)

Auto Tools (ISO type)

- ISO inserts for automatic lathes
- Precise R shape with the use of minus tolerance of nose R
- Tolerance class precise enough in no need for adjusting tools with the use of accurate cutting edge height
- Sharp blade for excellent chip control and surface roughness with low cutting force
- High precision tools for electrical/ electronics instruments and medical instruments



Code system (ISO type)

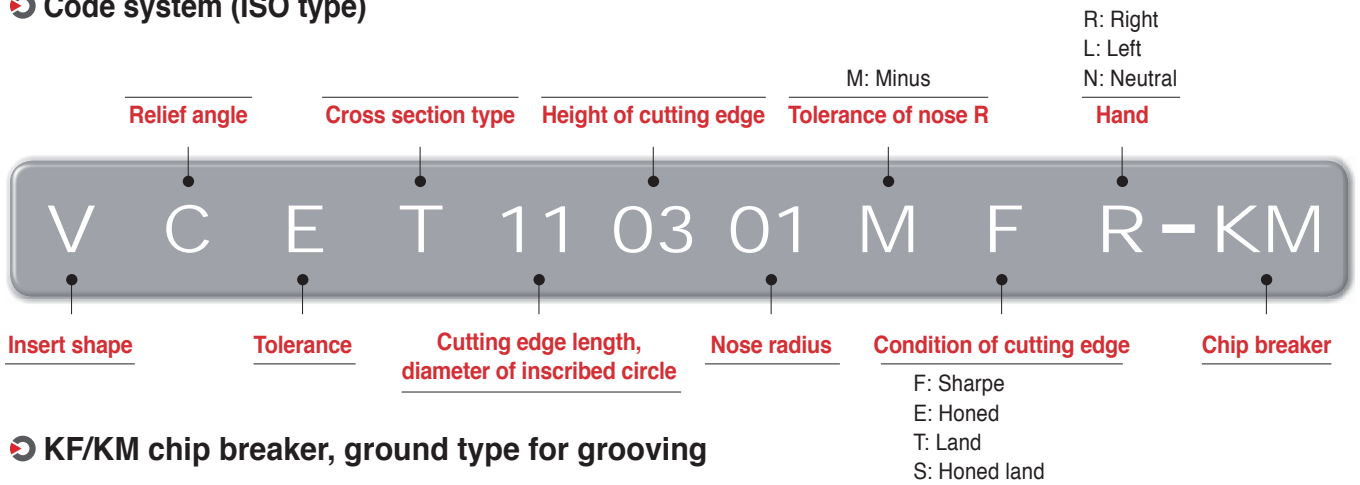

KF/KM chip breaker, ground type for grooving

- Ground chip breaker with sharp cutting edge
- High precision insert of E-class tolerance with accurate nose radius

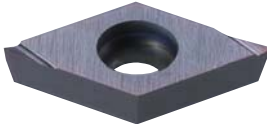
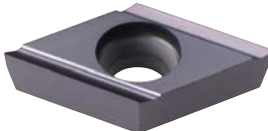
KF	KM
 <ul style="list-style-type: none"> • For finishing • Low cutting loads with sharp cutting edges • Longer tool life due to lower chip evacuation resistance at high speed • Excellent surface roughness 	 <ul style="list-style-type: none"> • For medium cutting to finishing • Better chip flow due to wide chip pockets • Longer tool life and better cutting action due to improved chip evacuation • Excellent surface roughness

VP1/MS chip breaker

- Exclusive chip breaker for hard-to-cut materials such as titanium alloy, Inconel, stainless steel, etc.
- Minimized cutting heat by reducing contact area between chips and rake surface with the use of high positive blade

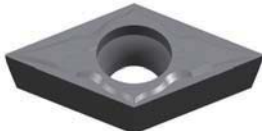
VP1	MS
 <ul style="list-style-type: none"> • Hard cutting edge for medium cutting • Optimal width of chip breaker by each depth of cuts realizes wide workpiece machining. 	 <ul style="list-style-type: none"> • Good surface finish for medium cutting • Preventing welding in Titanium machining • Increasing chip evacuation in high feed machining • Protecting cutting edge due to structure for good chip evacuation



SCACR/L

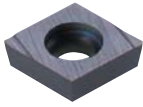

CC□T

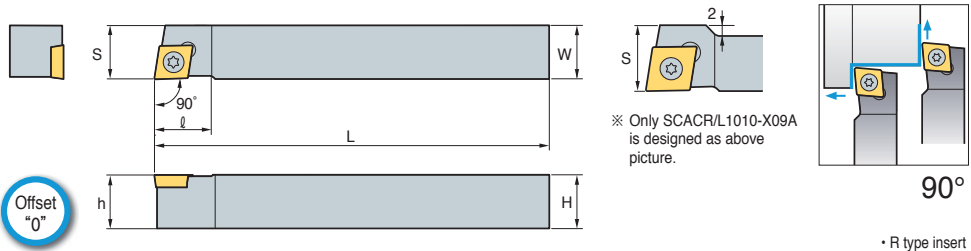

• R type insert (mm)

Designation	H	W	L	S	h	l	Insert	Screw	Wrench
SCACR/L 0808-X06A	8	8	120	8	8	10	CC□T0602□□	FTKA02565	TW07P
1010-X06A	10	10	120	10	10	10			
1010-X09A	10	10	120	12	10	13			
1212-X09A	12	12	120	12	12	16	CC□T09T3□□	FTKA0410	TW15P
1616-X09A	16	16	120	16	16	16			

➔ Applicable inserts B66~B69, B91

SCLCR/L

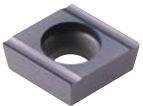

CC□T

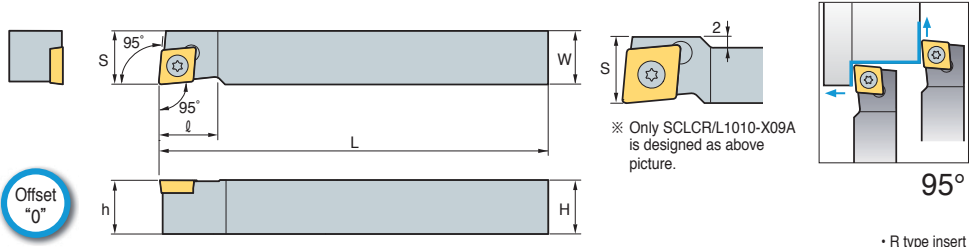

• R type insert (mm)

Designation	H	W	L	S	h	l	Insert	Screw	Wrench
SCLCR/L 0808-X06A	8	8	120	8	8	10	CC□T0602□□	FTKA02565	TW07P
1010-X06A	10	10	120	10	10	10			
1010-X09A	10	10	120	12	10	13			
1212-X09A	12	12	120	12	12	16	CC□T09T3□□	FTKA0410	TW15P
1616-X09A	16	16	120	16	16	16			

➔ Applicable inserts B66~B69, B91

SDJCR/L

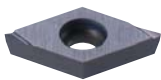

DC□T

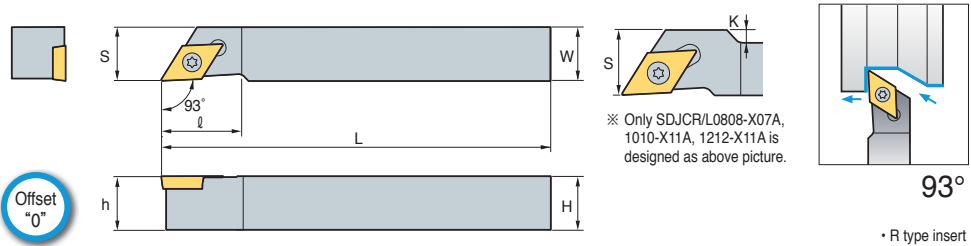

• R type insert (mm)

Designation	H	W	L	S	h	K	l	Insert	Screw	Wrench
SDJCR/L 0808-X07A	8	8	120	10	8	2	18	DC□T0702□□	FTKA02565	TW07P
1010-X07A	10	10	120	10	10	-	15			
1010-X11A	10	10	120	14	10	4	18			
1212-X11A	12	12	120	14	12	2	18	DC□T11T3□□	FTKA0410	TW15P
1616-X11A	16	16	120	16	16	-	22			

➔ Applicable inserts B71~B73, B92

SDNCN



DC□T

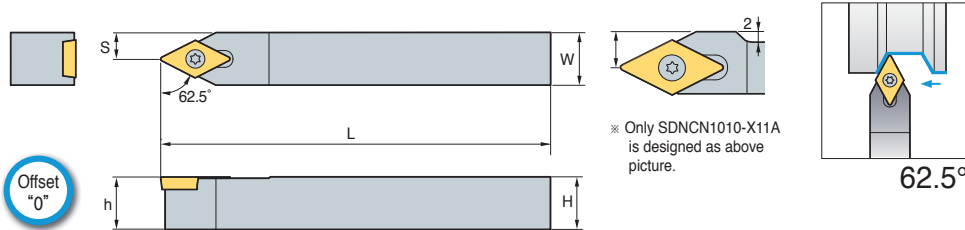

62.5°

• R type insert (mm)

Designation	H	W	L	S	h	Insert	Screw	Wrench
SDNCN 0808-X07A	8	8	120	4	8	DC□T0702□□	FTKA02565	TW 07P
	10	10	120	5	10			
	10	10	120	7	10			
SDNCN 1212-X11A	12	12	120	6	12	DC□T11T3□□	FTKA0410	TW 15P
SDNCN 1616-X11A	16	16	120	8	16			

➔ Applicable inserts B71~B73, B92

STACR/L

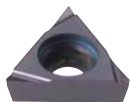

TC□T

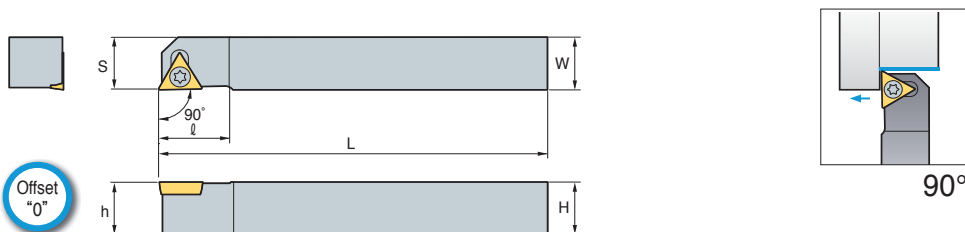

90°

• R type insert (mm)

Designation	H	W	L	S	h	K	ℓ	Insert	Screw	Wrench
STACR/L 0808-X08A	8	8	120	8	8	1	12	TC□T0802□□	FTNA 0206	TW 06P
	10	10	120	10	10	3	12			

➔ Applicable inserts B79~B80

SVACR/L



VC□□

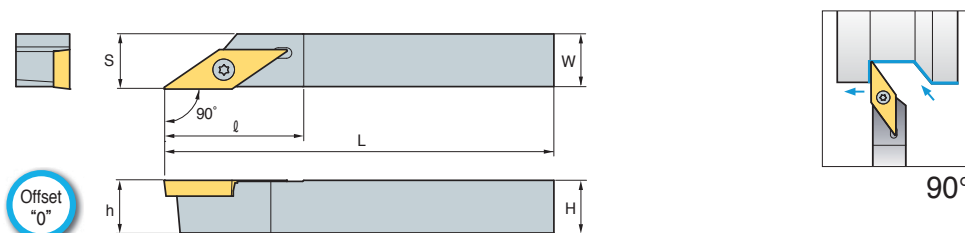

90°

• R type insert (mm)

Designation	H	W	L	S	h	ℓ	Insert	Screw	Wrench
SVACR/L 0808-X12A	8	8	120	8.5	8	26	VP□T1203□□	FTKA 02565	TW 07P
	10	10	120	10.5	10	26			
	12	12	120	12.5	12	26			
	16	16	120	16.5	16	26			
SVACR/L 0808-X12C	8	8	120	8.5	8	26	VC□X1203□□R/L	FTKA 02565	TW 07P
	10	10	120	10.5	10	26			
	12	12	120	12.5	12	26			
	16	16	120	16.5	16	26			

➔ Applicable inserts B86~B87, B97



SVAPR/L



VP□T

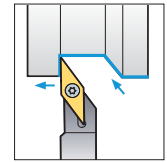
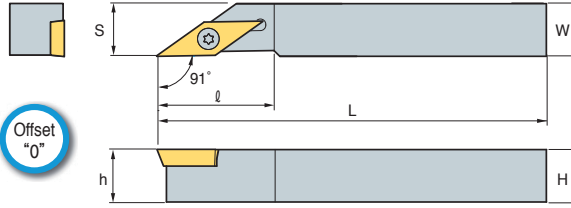

91°

• R type insert

(mm)

Designation	H	W	L	S	h	ℓ	Insert	Screw	Wrench
SVAPR/L 0808-X11A	8	8	120	8	8	22	VP□T1103□□	FTKA 02565	TW 07P
1010-X11A	10	10	120	10	10	22			
1212-X11A	12	12	120	12	12	22			
1616-X11A	16	16	120	16	16	24			

➔ Applicable inserts B88

SVJBR/L



VB□T

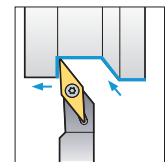
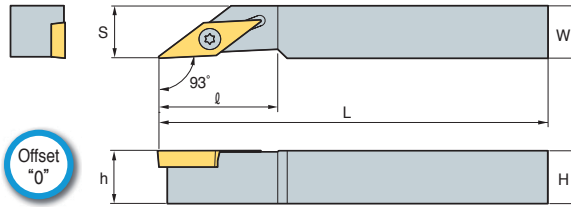

93°

• R type insert
(mm)

Designation	H	W	L	S	h	ℓ	Insert	Screw	Wrench
SVJBR/L 1010-X11A	10	10	120	10	10	22	VB□T1103□□	FTKA 02565	TW 07P
1212-X11A	12	12	120	12	12	22			
1616-X11A	16	16	120	16	16	24			

➔ Applicable inserts B84~B85, B96

SVJCR/L

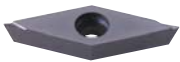

VC□T

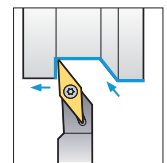
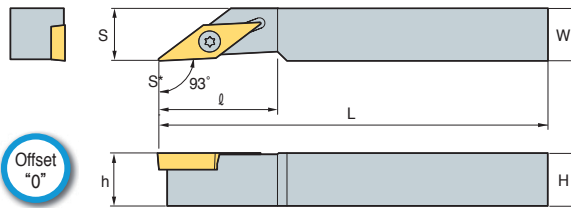

93°

• R type insert
(mm)

Designation	H	W	L	S	h	ℓ	Insert	Screw	Wrench
SVJCR/L 1010-X11A	10	10	120	10	10	22	VC□T1103□□	FTKA 02565	TW 07P
1212-X11A	12	12	120	12	12	22			
1616-X11A	16	16	120	16	16	24			
0810-X12A	8	10	120	10	8	26	VP□T1203□□	FTKA 02565	TW 07P
1010-X12A	10	10	120	10	10	26			
1212-X12A	12	12	120	12	12	26			
1616-X12A	16	16	120	16	16	26			
SVJCR/L 0810-X12C	8	10	120	10	8	26	VC□X1203□□R/L	FTKA 02565	TW 07P
1010-X12C	10	10	120	10	10	26			
1212-X12C	12	12	120	12	12	26			
1616-X12C	16	16	120	16	16	26			

➔ Applicable inserts B86~B87, B97

SVJPR/L

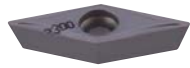

VP□T

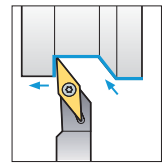
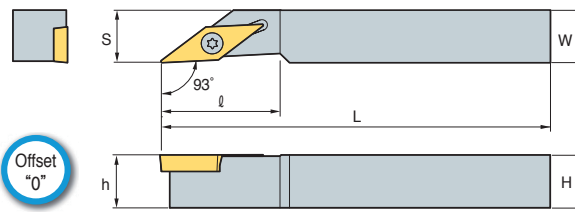

93°

• R type insert
(mm)

Designation		H	W	L	S	h	ℓ	Insert	Screw	Wrench
SVJPR/L	0810-X11A	8	10	120	8	10	22	VP□T1103□□	FTKA 02565	TW 07P
	1010-X11A	10	10	120	10	10	22			
	1212-X11A	12	12	120	12	12	22			
	1616-X11A	16	16	120	16	16	24			

➔ Applicable inserts **B88**

SVVPN

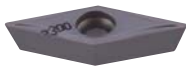

VP□T

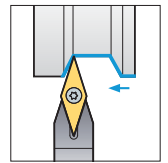
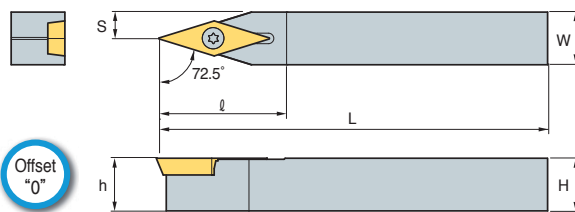

72.5°

• R type insert
(mm)

Designation		H	W	L	S	h	ℓ	Insert	Screw	Wrench
SVVPN	0808-X11A	8	8	120	4	8	24	VP□T1103□□	FTKA 02565	TW 07P
	1010-X11A	10	10	120	5	10	24			
	1212-X11A	12	12	120	6	12	24			
	1616-X11A	16	16	120	8	16	28			

➔ Applicable inserts **B88**



Auto Tools (KHP)

- KORLOY Coolant holder for high productivity of automatic lathe
- Injecting coolant through two holes to the main cutting edge and nose R concentrically improves cooling and chip control.
- Two holes with different injection angles each other increase chip control
- Easy clamping system of quick hose adapter and quick hose provides convenient using

Structure of coolant

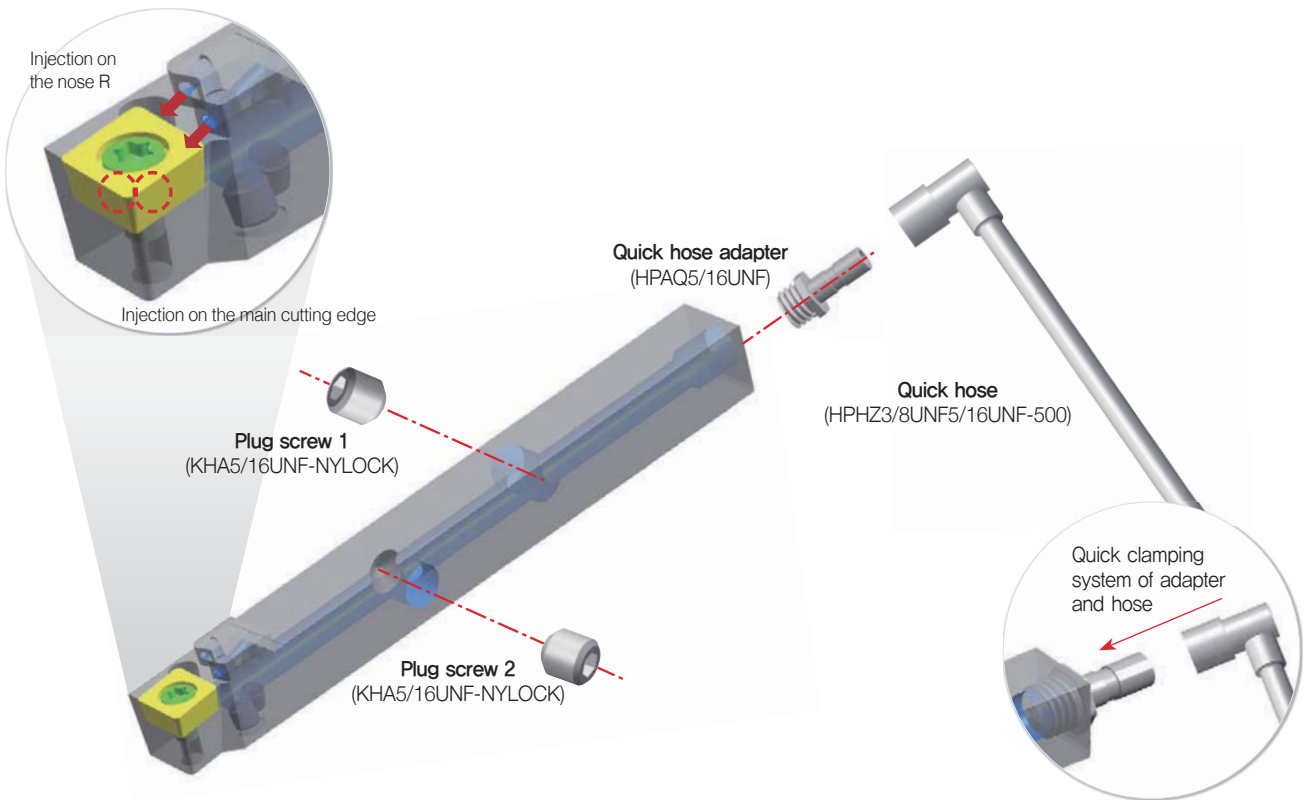

Parts

	Shape	Configuration	Length	Q clamping dimensions	S clamping dimensions
Straight quick hose	HPHZ5/16UNF3/8UNF 500 		500 mm	5/16 UNF	3/8 UNF
Quick hose adapter	HPAQ5/16UNF 		18.5 mm	5/16 UNF	

SCLCR/L

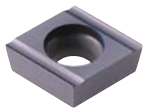

CC□T

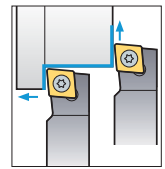
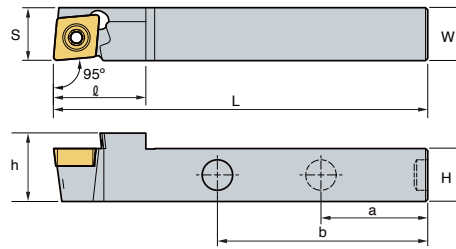

95°

• R type insert (mm)

Designation	H	W	L	S	h	ℓ	a	b	Insert	Screw	Screw plug	Wrench
SCLCR/L 1212-X09A-KHP	12	12	120	12	15.5	21	40	70	CC□T09T3□□	FTKA0410	KHA0404-NYLOCK	TW15P

➔ Applicable inserts B66~69, B91

SDJCR/L

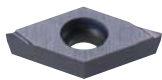

DC□T

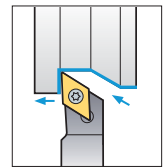
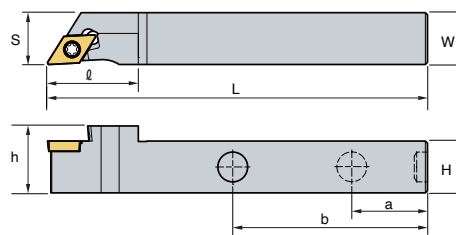

93°

• R type insert (mm)

Designation	H	W	L	S	h	ℓ	a	b	Insert	Screw	Screw plug	Wrench
SCLCR/L 1212-X07A-KHP	12	12	120	14	15.5	21	40	70	DC□T0702□□	FTKA02565	KHA0404-NYLOCK	TW07P
1212-X11A-KHP	12	12	120	14	15.5	29.8	40	70	DC□T11T3□□	FTKA0410	KHA0404-NYLOCK	TW15P

➔ Applicable inserts B71~73, B92

SVJCR/L

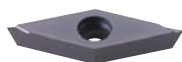

VC□T

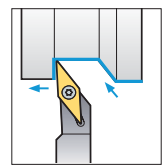
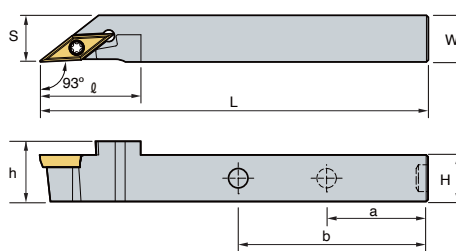

93°









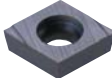
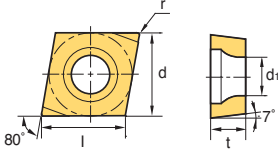
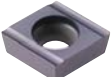
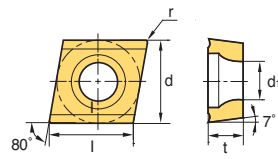

• R type insert (mm)

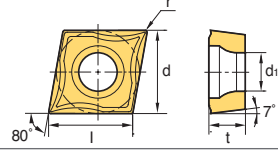
Designation	H	W	L	S	h	ℓ	a	b	Insert	Screw	Screw plug	Wrench
SVJCR/L 1212-X11A-KHP	12	12	120	12	15.5	26	40	70	VC□T1103□□	FTKA02565	KHA0404-NYLOCK	TW07P
1212-X12A-KHP	12	12	120	12	15.5	26	40	70	VC□T1203□□	FTKA02565	KHA0404-NYLOCK	TW07P

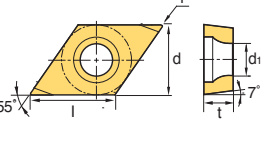
➔ Applicable inserts B86~87, B97

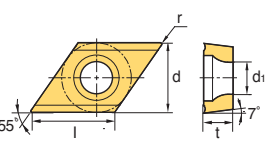

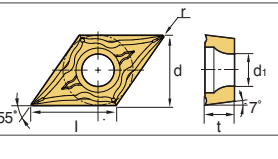

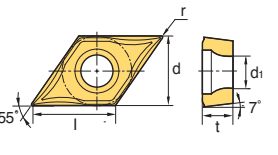







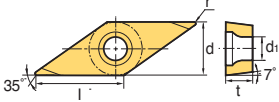

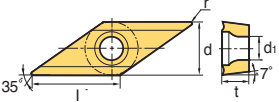

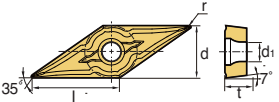
Insert

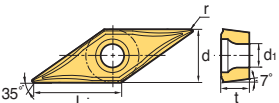
Picture	Designation	Coated				Uncoated	Dimensions (mm)					Configuration
		PC5300	PC8105	PC8110	PC8115	H01	l	d	t	r	d ₁	
 Finishing (High precision)	0602005MFR-KF	●		●			6.6	6.35	2.38	<0.05	2.8	
	060201MFR-KF	●		●			6.4	6.35	2.38	<0.1	2.8	
	060202MFR-KF	●		●			6.2	6.35	2.38	<0.2	2.8	
	09T3005MFR-KF	●		●			9.8	9.525	3.97	<0.05	4.4	
	09T301MFR-KF	●		●			9.6	9.525	3.97	<0.1	4.4	
	09T302MFR-KF	●		●			9.2	9.525	3.97	<0.2	4.4	
	0602005MFL-KF	●		●			6.6	6.35	2.38	<0.05	2.8	
	060201MFL-KF	●		●			6.4	6.35	2.38	<0.1	2.8	
	060202MFL-KF	●		●			6.2	6.35	2.38	<0.2	2.8	
	09T3005MFL-KF	●		●			9.8	9.525	3.97	<0.05	4.4	
	09T301MFL-KF	●		●			9.6	9.525	3.97	<0.1	4.4	
09T302MFL-KF	●		●			9.2	9.525	3.97	<0.2	4.4		
 Medium to finishing (High precision)	0602005MFR-KM	●		●			6.6	6.35	2.38	<0.05	2.8	
	060201MFR-KM	●		●			6.4	6.35	2.38	<0.1	2.8	
	060202MFR-KM	●		●			6.2	6.35	2.38	<0.2	2.8	
	09T3005MFR-KM	●		●			9.8	9.525	3.97	<0.05	4.4	
	09T301MFR-KM	●		●			9.6	9.525	3.97	<0.1	4.4	
	09T302MFR-KM	●		●			9.2	9.525	3.97	<0.2	4.4	
	0602005MFL-KM	●		●			6.6	6.35	2.38	<0.05	2.8	
	060201MFL-KM	●		●			6.4	6.35	2.38	<0.1	2.8	
	060202MFL-KM	●		●			6.2	6.35	2.38	<0.2	2.8	
	09T3005MFL-KM	●		●			9.8	9.525	3.97	<0.05	4.4	
	09T301MFL-KM	●		●			9.6	9.525	3.97	<0.1	4.4	
09T302MFL-KM	●		●			9.2	9.525	3.97	<0.2	4.4		
 Finishing (High precision)	060201MFN-VP1	●		●			6.6	6.35	2.38	<0.1	2.8	
	060202MFN-VP1	●		●			6.4	6.35	2.38	<0.2	2.8	
	060204MFN-VP1	●		●			6.2	6.35	2.38	<0.4	2.8	
	09T301MFN-VP1	●		●			9.8	9.525	3.97	<0.1	4.4	
	09T302MFN-VP1	●		●			9.6	9.525	3.97	<0.2	4.4	
	09T304MFN-VP1	●		●			9.2	9.525	3.97	<0.4	4.4	
 Finishing (High precision)	0702005MFR-KF	●		●			7.8	6.35	2.38	<0.05	2.8	
	070201MFR-KF	●		●			7.8	6.35	2.38	<0.1	2.8	
	070202MFR-KF	●		●			7.8	6.35	2.38	<0.2	2.8	
	11T3005MFR-KF	●		●			11.6	9.525	3.97	<0.05	4.4	
	11T301MFR-KF	●		●			11.6	9.525	3.97	<0.1	4.4	
	11T302MFR-KF	●		●			11.6	9.525	3.97	<0.2	4.4	
	0702005MFL-KF	●		●			7.8	6.35	2.38	<0.05	2.8	
	070201MFL-KF	●		●			7.8	6.35	2.38	<0.1	2.8	
	070202MFL-KF	●		●			7.8	6.35	2.38	<0.2	2.8	
	11T3005MFL-KF	●		●			11.6	9.525	3.97	<0.05	4.4	
	11T301MFL-KF	●		●			11.6	9.525	3.97	<0.1	4.4	
11T302MFL-KF	●		●			11.6	9.525	3.97	<0.2	4.4		
 Medium to finishing (High precision)	0702005MFR-KM	●		●			7.8	6.35	2.38	<0.05	2.8	
	070201MFR-KM	●		●			7.8	6.35	2.38	<0.1	2.8	
	070202MFR-KM	●		●			7.8	6.35	2.38	<0.2	2.8	
	11T3005MFR-KM	●		●			11.6	9.525	3.97	<0.05	4.4	
	11T301MFR-KM	●		●			11.6	9.525	3.97	<0.1	4.4	
	11T302MFR-KM	●		●			11.6	9.525	3.97	<0.2	4.4	
	0702005MFL-KM	●		●			7.8	6.35	2.38	<0.05	2.8	
	070201MFL-KM	●		●			7.8	6.35	2.38	<0.1	2.8	
	070202MFL-KM	●		●			7.8	6.35	2.38	<0.2	2.8	
	11T3005MFL-KM	●		●			11.6	9.525	3.97	<0.05	4.4	
	11T301MFL-KM	●		●			11.6	9.525	3.97	<0.1	4.4	
11T302MFL-KM	●		●			11.6	9.525	3.97	<0.2	4.4		
 Medium (High precision)	11T301MFN-MS	●		●			11.6	9.525	3.97	<0.1	4.4	
	11T302MFN-MS	●		●			11.6	9.525	3.97	<0.2	4.4	
	11T304MFN-MS	●		●			11.6	9.525	3.97	<0.4	4.4	
 Finishing (High precision)	070201MFN-VP1	●		●			7.8	6.35	2.38	<0.1	2.8	
	070202MFN-VP1	●		●			7.8	6.35	2.38	<0.2	2.8	
	070204MFN-VP1	●		●			7.8	6.35	2.38	<0.4	2.8	
	11T301MFN-VP1	●		●			11.6	9.525	3.97	<0.1	4.4	
	11T302MFN-VP1	●		●			11.6	9.525	3.97	<0.2	4.4	
	11T304MFN-VP1	●		●			11.6	9.525	3.97	<0.4	4.4	

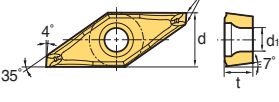
●: Stock item

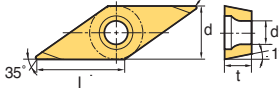

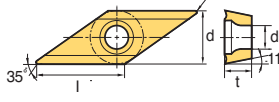
Insert

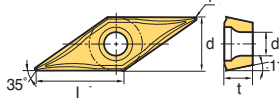
Picture	Designation	Coated				Uncoated	Dimensions (mm)					Configuration
		PC5300	PC8105	PC8110	PC8115	H01	l	d	t	r	d ₁	
 Finishing (High precision)	1103005MFR-KF	●		●			11.0	6.35	3.18	<0.05	2.8	
	110301MFR-KF	●		●			11.0	6.35	3.18	<0.1	2.8	
	110302MFR-KF	●		●			11.0	6.35	3.18	<0.2	2.8	
	1103005MFL-KF	●		●			11.0	6.35	3.18	<0.05	2.8	
	110301MFL-KF	●		●			11.0	6.35	3.18	<0.1	2.8	
	110302MFL-KF	●		●			11.0	6.35	3.18	<0.2	2.8	
 Medium to finishing (High precision)	1103005MFR-KM	●		●			11.0	6.35	3.18	<0.05	2.8	
	110301MFR-KM	●		●			11.0	6.35	3.18	<0.1	2.8	
	110302MFR-KM	●		●			11.0	6.35	3.18	<0.2	2.8	
	1103005MFL-KM	●		●			11.0	6.35	3.18	<0.05	2.8	
	110301MFL-KM	●		●			11.0	6.35	3.18	<0.1	2.8	
	110302MFL-KM	●		●			11.0	6.35	3.18	<0.2	2.8	
 Medium to finishing (High precision)	1203008FN-MS						11.0	7.50	3.00	<0.08	2.8	
	120301FN-MS						11.0	7.50	3.00	<0.1	2.8	
	120302FN-MS						11.0	7.50	3.00	<0.2	2.8	
	120304FN-MS						11.0	7.50	3.00	<0.4	2.8	
 Finishing (High precision)	110301MFN-VP1	●		●			11.0	6.35	3.18	<0.1	2.8	
	110302MFN-VP1	●		●			11.0	6.35	3.18	<0.2	2.8	
	110304MFN-VP1	●		●			11.0	6.35	3.18	<0.4	2.8	
 Finishing (High precision)	120300MFR-VP1	●		●			11.0	7.50	3.18	<0.0	2.8	
	120301MFR-VP1	●		●			11.0	7.50	3.18	<0.1	2.8	
	120302MFR-VP1	●		●			11.0	7.50	3.18	<0.2	2.8	
	120304MFR-VP1	●		●			11.0	7.50	3.18	<0.4	2.8	
	120308MFR-VP1	●		●			11.0	7.50	3.18	<0.8	2.8	
 Finishing (High precision)	0802005MFR-KF	●		●			8.0	6.35	2.38	<0.1	2.3	
	080201MFR-KF	●		●			8.0	6.35	2.38	<0.1	2.3	
	080202MFR-KF	●		●			8.0	6.35	2.38	<0.2	2.3	
	0802005MFL-KF	●		●			8.0	6.35	2.38	<0.1	2.3	
	080201MFL-KF	●		●			8.0	6.35	2.38	<0.1	2.3	
	080202MFL-KF	●		●			8.0	6.35	2.38	<0.2	2.3	
 Medium to finishing (High precision)	0802005MFR-KM	●		●			8.0	6.35	2.38	<0.1	2.3	
	080201MFR-KM	●		●			8.0	6.35	2.38	<0.1	2.3	
	080202MFR-KM	●		●			8.0	6.35	2.38	<0.2	2.3	
	0802005MFL-KM	●		●			8.0	6.35	2.38	<0.1	2.3	
	080201MFL-KM	●		●			8.0	6.35	2.38	<0.1	2.3	
	080202MFL-KM	●		●			8.0	6.35	2.38	<0.2	2.3	
 Finishing (High precision)	110301MFN-VP1	●		●			11.0	6.35	3.18	<0.1	2.8	
	110302MFN-VP1	●		●			11.0	6.35	3.18	<0.2	2.8	
	110304MFN-VP1	●		●			11.0	6.35	3.18	<0.4	2.8	

● : Stock item



Auto tools (Blade type) *new*

- Blade insert for automatic lathes
- For external machining of precise small parts
- 4 types - SSB(for back turning), SGB(for grooving), SBT(for threading), SBC(for parting off)
- Convenient use of one holder to all blade inserts
- Exclusive holder for close cutting action to the sub spindle

Code system of Auto Tools insert (Blade type)

Turning (Back turning)	SB	B	R	25	10		
	Small blade	Back turning	Hand R: Right L: Left	Length of insert	Nose radius		
Grooving	SB	G	R	25	20		
	Small blade	Grooving	Hand R: Right L: Left	Length of insert	Width of cutting edge		
Threading	SB	T	R	25	60	N	010
	Small blade	Threading	Hand R: Right L: Left	Length of insert	Angle of thread	Hand of thread R: Right L: Left N: Neutral	Nose radius
Parting	SB	C	R	25	20	16	N
	Small blade	Cut off / Parting	Hand R: Right L: Left	Length of insert	Width of cutting edge	Max. machining diameter	Hand of thread R: Right L: Left N: None

Code system of Auto Tools holder (Blade type)

SB	H	R	10	10	K25	X
Small blade	Holder	Hand R: Right L: Left	Height of shank	Width of shank	Length of insert	Sub spindle

Types of blade insert

Possible to apply various types of blade inserts to one holder

			
SBB: For back turning	SGB: For grooving	SBT: For threading	SBC: For cut off/Parting
<ul style="list-style-type: none"> • Approach angle: 59° • Max. cutting depth: 4 mm • Nose R: 0.05, 0.1, 0.2 mm 	<ul style="list-style-type: none"> • Width: 0.5~2.5 mm • Nose R: 0.05 mm 	<ul style="list-style-type: none"> • V profile: 60° • Pitch: 0.2~1.0 mm • Nose R: 0.05 mm 	<ul style="list-style-type: none"> • Cutting width: 0.7~2.0 • D Max.: 16 mm • Nose R: 0.05 mm

SBHR/L



SBBR SBGR
SBTR SBCR

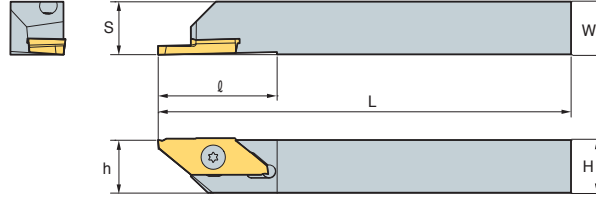

Designation		H	W	L	S	h	l	Insert	Screw	Wrench
SBHR/L	1010-K25	10	10	125	10	10	27	SB□R/L25	FTKA0409S	T9
	1212-K25	12	12	125	12	12	27			
	1616-K25	16	16	125	16	16	27			

SBHR/L-X (Sub spindle)



SBBR SBGR
SBTR SBCR

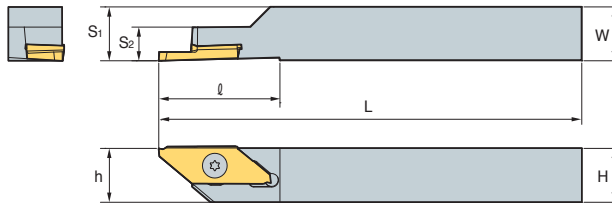

Designation		H	W	L	S1	S2	h	l	Insert	Screw	Wrench
SBHR/L	1010-K25-X	10	10	125	10	7.5	10	27	SB□R/L25	FTKA0407S	T9
	1212-K25-X	12	12	125	12	7.5	12	27			

Insert

Application	Picture	Designation	Coated				Dimensions (mm)										Configuration	Feed direction		
			PC8110		PC5300		l	α	t	r	La	ar	f	D-MAX	Pitch range					
			R	L	R	L									Min.	Max.				
Back turning		SBBR/L 25005	●	●	●	●	25	59	3.18	0.05	-	-	-	-	-	-	-	-		
		25010	●	●	●	●	25	59	3.18	0.10	-	-	-	-	-	-	-	-		
		25020	●	●	●	●	25	59	3.18	0.20	-	-	-	-	-	-	-	-		
Grooving		SBGR/L 2505	●	●	●	●	25	-	-	0.05	0.5	1.35	-	-	-	-	-	-		
		2510	●	●	●	●	25	-	-	0.05	1.0	2.75	-	-	-	-	-	-		
		2515	●	●	●	●	25	-	-	0.05	1.5	3.75	-	-	-	-	-	-		
		2520	●	●	●	●	25	-	-	0.05	2.0	3.75	-	-	-	-	-	-		
		2525	●	●	●	●	25	-	-	0.05	2.5	3.75	-	-	-	-	-	-		
Threading		SBTR/L 2560-N-005	●	●	●	●	25	-	-	0.05	-	-	1.59	-	0.2	2.0	-	-		
		2560-N-010	●	●	●	●	25	-	-	0.10	-	-	1.59	-	1.0	2.0	-	-		
		2560-R-005	●	●	●	●	25	-	-	0.05	-	-	0.6	-	0.2	1.5	-	-		
		2560-R-010	●	●	●	●	25	-	-	0.10	-	-	0.6	-	1.0	1.5	-	-		
		2560-L-005	●	●	●	●	25	-	-	0.05	-	-	0.6	-	0.2	1.5	-	-		
		2560-L-010	●	●	●	●	25	-	-	0.10	-	-	0.6	-	1.0	1.5	-	-		

● : Stock item

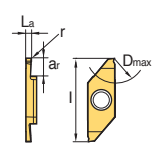
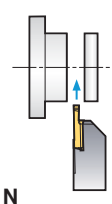
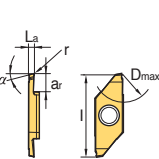
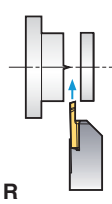
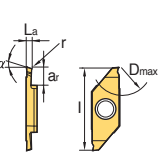
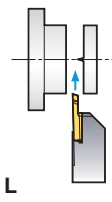
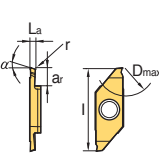
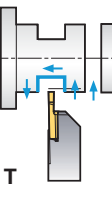

Insert

Application	Picture	Designation	Coated				Dimensions (mm)										Configuration	Feed direction
			PC8110		PC5300		l	α	t	r	La	ar	f	D-MAX	Pitch range			
			R	L	R	L									Min.	Max.		
Parting off SBCR/L		SBCR/L 250708-N	●	●	●	●	25	0	-	0.05	0.70	4.3	-	8	-	-		
		251012-N	●	●	●	●	25	0	-	0.05	1.00	6.3	-	12	-	-		
		251512-N	●	●	●	●	25	0	-	0.05	1.50	6.3	-	12	-	-		
		252016-N	●	●	●	●	25	0	-	0.05	2.00	8.3	-	16	-	-		
		250708-R	●	●	●	●	25	15	-	0.05	0.70	4.3	-	8	-	-		
		251012-R	●	●	●	●	25	15	-	0.05	1.00	6.3	-	12	-	-		
		251512-R	●	●	●	●	25	15	-	0.05	1.50	6.3	-	12	-	-		
		252016-R	●	●	●	●	25	15	-	0.05	2.00	8.3	-	16	-	-		
		250708-L	●	●	●	●	25	15	-	0.05	0.70	4.3	-	8	-	-		
		251012-L	●	●	●	●	25	15	-	0.05	1.00	6.3	-	12	-	-		
		251512-L	●	●	●	●	25	15	-	0.05	1.50	6.3	-	12	-	-		
		252016-L	●	●	●	●	25	15	-	0.05	2.00	8.3	-	16	-	-		
		251012-T	●	●	●	●	25	0	-	0.05	1.00	6.3	-	12	-	-		
		251512-T	●	●	●	●	25	0	-	0.05	1.50	6.3	-	12	-	-		
		252016-T	●	●	●	●	25	0	-	0.05	2.00	8.3	-	16	-	-		

● : Stock item



B Auto Tools (For multi utility)

Auto Tools (For multi utility)

- Multifunctional insert for automatic lathes
- For external machining of precise small parts
- 5 types - SB(for back turning), SG(for grooving), ST(for threading), SC(for parting off), SGB(for grooving and back turning)
- Convenient use of one holder to all inserts
- Offset "0" to all ISO type holders

Insert code system (Multi utility type)

B: Back turning G: Grooving
 C: Parting off T: Threading
 GB: Grooving and back turning

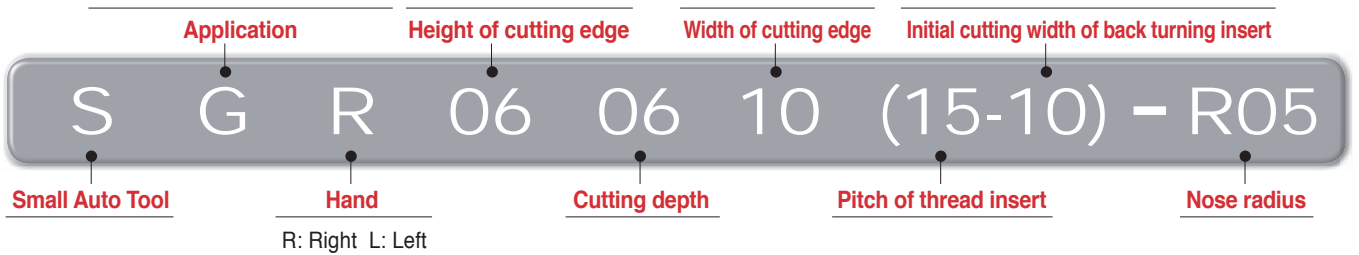

Application example

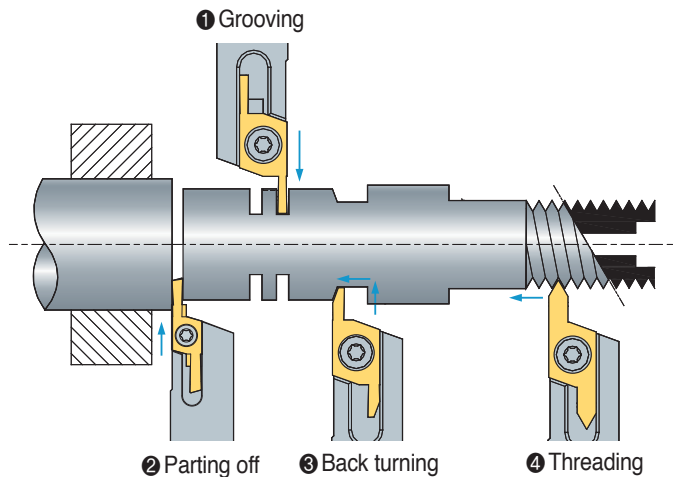

Types of multifunctional insert

Possible to apply various types of blade inserts to one holder (Ex: All designations of 06 size inserts can be applied to one 06 size holder.)

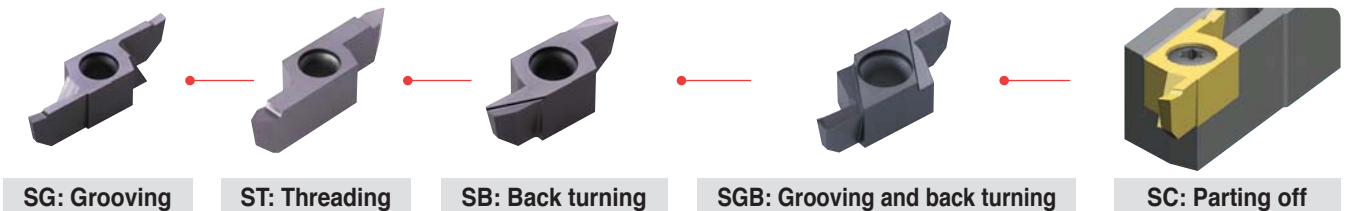

Recommended cutting conditions

Workpiece	Turning		Grooving		Parting off		Back turning	
	Cutting speed, vc (m/min)	Feed, fn (mm/rev)	Cutting speed, vc (m/min)	Feed, fn (mm/rev)	Cutting speed, vc (m/min)	Feed, fn (mm/rev)	Cutting speed, vc (m/min)	Feed, fn (mm/rev)
Stainless steel	50~120	0.02~0.20	30~120	0.02~0.05	30~120	0.02~0.05	30~120	0.02~0.20
Carbon steel	50~150	0.01~0.25	50~150	0.02~0.08	50~150	0.01~0.08	50~150	0.01~0.25
Free cutting steel	30~150	0.02~0.25	30~150	0.02~0.08	30~150	0.01~0.08	30~150	0.01~0.25
Non-ferrous metal	70~200	0.03~0.25	70~200	0.03~0.10	70~200	0.03~0.10	70~200	0.03~0.30



SXGNR/L

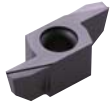

SBR, SGBR
SCR, STR, SGR

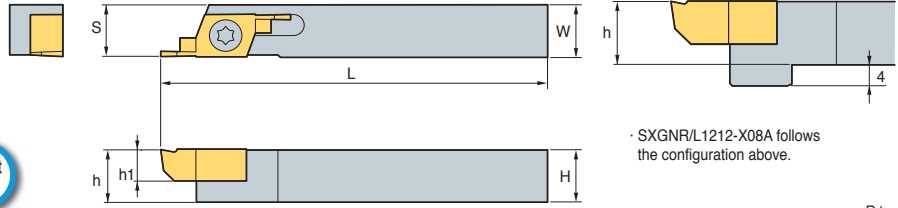

• R type insert (mm)

Designation	H	W	L	S	h	h1	Insert	Screw	Wrench
SXGNR/L	1010-X06A	10	10	125	10	10	S□R/L 06	FTNA 0408	TW 15P
	1212-X06A	12	12	125	12	12			
	1616-X06A	16	16	125	16	16			
	2020-X06A	20	20	125	20	20			
SXGNR/L	1212-X08A	12	12	130	12	12	S□R/L 08	FTNA 0411	TW 15P
	1616-X08A	16	16	130	16	16			
	2020-X08A	20	20	130	20	20			



Insert

Application	Picture	Designation	Coated		Dimensions (mm)							Configuration	Feed direction	
			PC9030		b ₁	b	W	L	r	h	T-MAX			ØD
			R	L										
Back turning		SBR/L 060520-10-R00			1	2	8	22	0	6	5.5	-		
		060520-10-R05			1	2	8	22	0.05	6	5.5	-		
		060520-10-R10			1	2	8	22	0.1	6	5.5	-		
		060630-20-R00			2	3	8	24	0	6	6.5	-		
		060630-20-R05			2	3	8	24	0.05	6	6.5	-		
		060630-20-R10			2	3	8	24	0.1	6	6.5	-		
		080630-20-R00			2	3	8	23	0	8	6.5	-		
		080630-20-R05			2	3	8	23	0.05	8	6.5	-		
		080630-20-R10			2	3	8	23	0.1	8	6.5	-		
		080840-20-R00			2	4	8	27	0	8	8.5	-		
080840-20-R05			2	4	8	27	0.05	8	8.5	-				
080840-20-R10			2	4	8	27	0.1	8	8.5	-				
Parting off		SCR/L 060610-R00			-	1	8	24	0	6	-	11		
		060610-R05	●		-	1	8	24	0.05	6	-	11		
		060610-R10	●		-	1	8	24	0.1	6	-	11		
		060615-R00			-	1.5	8	24	0	6	-	11		
		060615-R05	●		-	1.5	8	24	0.05	6	-	11		
		060615-R10	●		-	1.5	8	24	0.1	6	-	11		
		060620-R00			-	2	8	24	0	6	-	11		
		060620-R05	●		-	2	8	24	0.05	6	-	11		
		060620-R10	●		-	2	8	24	0.1	6	-	11		
		081015-R00			-	1.5	8	31	0	8	-	18		
		081015-R05			-	1.5	8	31	0.05	8	-	18		
		081015-R10			-	1.5	8	31	0.1	8	-	18		
		081020-R00			-	2	8	31	0	8	-	18		
		081020-R05			-	2	8	31	0.05	8	-	18		
		081020-R10	●		-	2	8	31	0.1	8	-	18		
		081025-R00			-	2.5	8	31	0	8	-	18		
081025-R05	●		-	2.5	8	31	0.05	8	-	18				
081025-R10	●		-	2.5	8	31	0.1	8	-	18				
081030-R00			-	3	8	31	0	8	-	18				
081030-R05	●		-	3	8	31	0.05	8	-	18				
081030-R10			-	3	8	31	0.1	8	-	18				

● : Stock item

B Auto Tools (For multi utility)

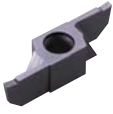
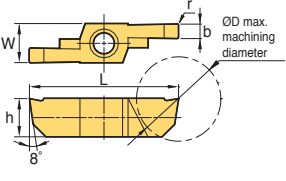
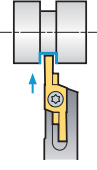
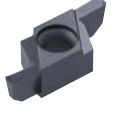
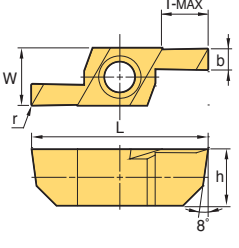
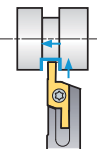
Insert

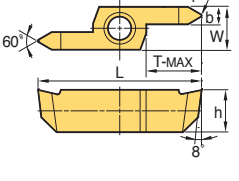
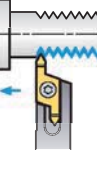
Application	Picture	Designation	Coated		Dimensions (mm)								Configuration	Feed direction
			PC9030		b	W	L	r	h	T-MAX	ØD	Pitch		
			R	L										
Grooving	 SGR/L	SGR/L 060610-R00			1	8	24	0	6	-	11	-	 W h 8° r b ØD max. machining diameter	
		060610-R05	●		1	8	24	0.05	6	-	11	-		
		060610-R10	●		1	8	24	0.1	6	-	11	-		
		060615-R00			1.5	8	24	0	6	-	11	-		
		060615-R05	●		1.5	8	24	0.05	6	-	11	-		
		060615-R10	●		1.5	8	24	0.1	6	-	11	-		
		060620-R00			2	8	24	0	6	-	11	-		
		060620-R05	●		2	8	24	0.05	6	-	11	-		
		060620-R10	●		2	8	24	0.1	6	-	11	-		
		081015-R00			1.5	8	31	0	8	-	18	-		
		081015-R05			1.5	8	31	0.05	8	-	18	-		
		081015-R10			1.5	8	31	0.1	8	-	18	-		
		081020-R00			2	8	31	0	8	-	18	-		
		081020-R05	●		2	8	31	0.05	8	-	18	-		
		081020-R10			2	8	31	0.1	8	-	18	-		
		081025-R00			2.5	8	31	0	8	-	18	-		
		081025-R05			2.5	8	31	0.05	8	-	18	-		
		081025-R10			2.5	8	31	0.1	8	-	18	-		
081030-R00			3	8	31	0	8	-	18	-				
081030-R05			3	8	31	0.05	8	-	18	-				
081030-R10			3	8	31	0.1	8	-	18	-				
Grooving and back turning	 SGBR/L	SGBR/L 0604520-R00			2	8	22	0	6	4.5	-	-	 W r L T-MAX b h 8°	
		0604520-R05			2	8	22	0.05	6	4.5	-	-		
		0604520-R10			2	8	22	0.1	6	4.5	-	-		
		0604525-R00			2.5	8	22	0	6	4.5	-	-		
		0604525-R05			2.5	8	22	0.05	6	4.5	-	-		
		0604525-R10			2.5	8	22	0.1	6	4.5	-	-		
		0605530-R00			3	8	24	0	6	5.5	-	-		
		0605530-R05			3	8	24	0.05	6	5.5	-	-		
		0605530-R10			3	8	24	0.1	6	5.5	-	-		
		0805525-R00			2.5	8	24	0	8	5.5	-	-		
		0805525-R05			2.5	8	24	0.05	8	5.5	-	-		
		0805525-R10			2.5	8	24	0.1	8	5.5	-	-		
		0806530-R00			3	8	26	0	8	6.5	-	-		
0806530-R05			3	8	26	0.05	8	6.5	-	-				
0806530-R10			3	8	26	0.1	8	6.5	-	-				
Threading	 STR/L	STR/L 06073215			3.2	8	25	0.06	6	7	-	0.5-1.5	 60° r b W L T-MAX h 8°	
		06073230			3.2	8	25	0.19	6	7	-	1.5-3.0		
		08103215			3.2	8	31	0.06	8	10.5	-	0.5-1.5		
		08103230			3.2	8	31	0.19	8	10.5	-	1.5-3.0		

● : Stock item



AutoTools (KGT/MGT type)

- Grooving insert for automatic lathes
- Exclusive holder for automatic lathes
- Economic double sided insert
- Strong clamping system secures stable machining and precision.
- A wide selection of chip breakers according to various cutting conditions such as low/high feed, continuous/interrupted machining, etc.

Insert code system (KGT/MGT type)

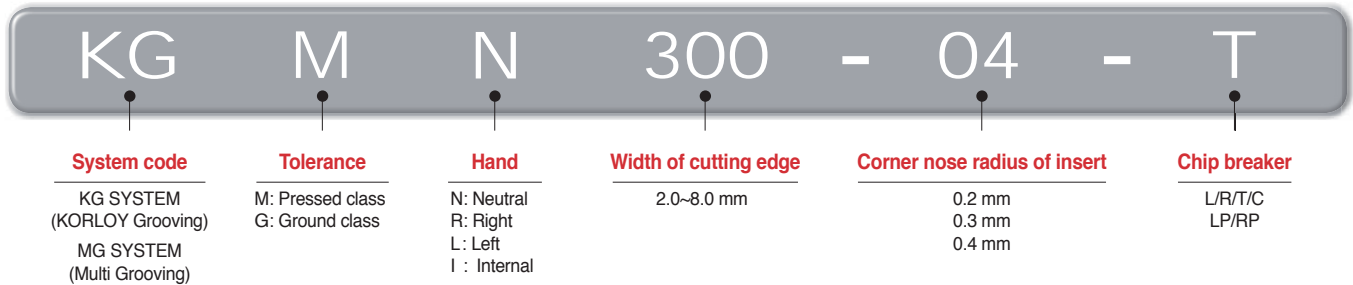



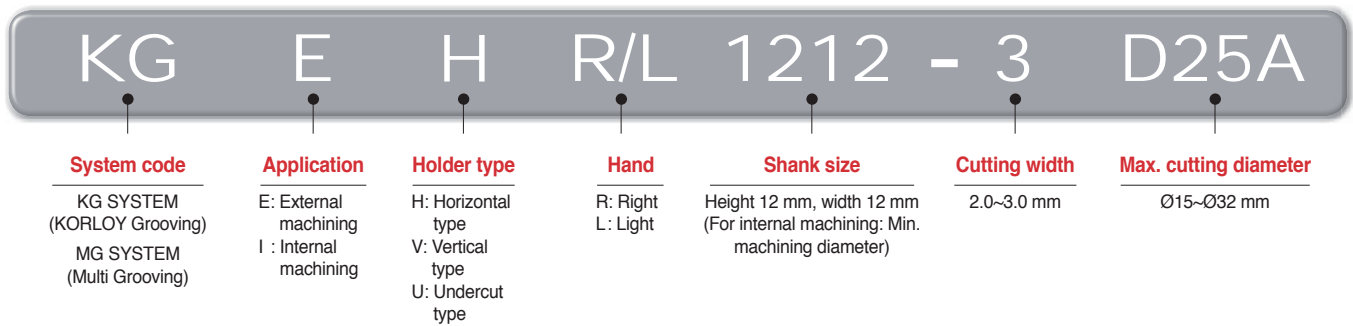



Holder code system (KGT/MGT type)





Chip breaker line-up

KGT Type

KGMMN-L  <ul style="list-style-type: none"> • Sharp cutting edge • For low feed machining • For small diameter parts 	KGMMN-R  <ul style="list-style-type: none"> • Reinforced cutting edge • For high feed machining • For interrupted cutting 	KGMMN-T  <ul style="list-style-type: none"> • Sharp cutting edge • Stronger chip control • For turning and grooving
KGMR/L-LP  <ul style="list-style-type: none"> • Sharp cutting edge • For low feed machining • Small diameter component • Right/Left handed • Low carbon steel 	KGMR/L-RP  <ul style="list-style-type: none"> • Strong cutting edge • For high feed machining • For interrupted cutting • Right/Left handed 	KRMN-C  <ul style="list-style-type: none"> • Improved chip control • Copying • Relief

MGT Type

MGM(G)N-M  <ul style="list-style-type: none"> • Easier chip control by narrowing chip width with the use of chip breaker on rake surface center • Smooth chip flow by small dots in external machining • Available for both external machining and grooving 	MGMN-G  <ul style="list-style-type: none"> • Specially designed chip breaker allows narrower chips to promote better chip flow with the use of center dots • Exclusive chip breaker for grooving
---	--

B Auto Tools (KGT/MGT type)

KGEHR/L-D00A

Compact type

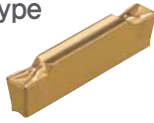

KGGN KGMN KGMR/L
KRGN KRMN

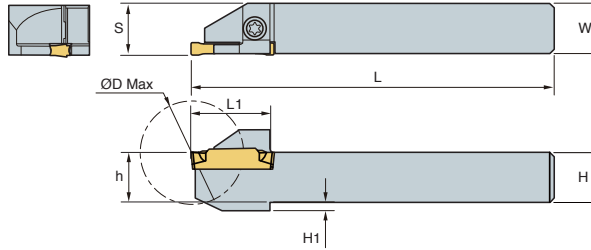

Grooving, turning, parting off

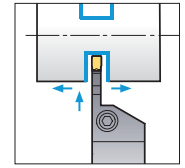

• R type insert (mm)

Designation	Dimensions (mm)							Insert	Screw	Wrench	
	H	W	L1	L	S	h1	ØD_MAX				
KGEHR/L	1010-2-D20A	10	10	19	125	10.2	2	20	KGMN200-□-□ KGMR/L200-□-□ KRMN200-C KRGN200-□-□	ETNA0412	TW15L
	1212-2-D25A	12	12	19	125	12.2	2	25			
	1414-2-D25A	14	14	19	125	14.2	-	25			
	1616-2-D32A	16	16	24	125	16.2	-	32			
	1212-3-D25A	12	12	19	130	12.4	2	25	KGMN300-□-□ KGMR/L300-□-□ KRMG300-C KRGN300-□-□		
	1616-3-D32A	16	16	24	130	16.4	-	32			

KGEHR/L-D00B

High rigidity type

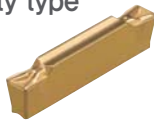

KGGN KGMN KGMR/L
KRGN KRMN

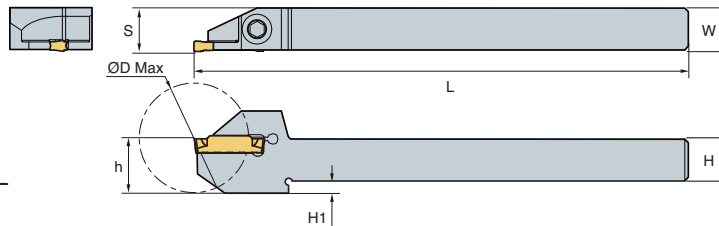

Grooving, turning, parting off

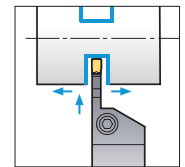

• R type insert (mm)

Designation	Dimensions (mm)						Insert	Screw	Wrench	
	H	W	L	S	h1	ØD_MAX				
KGEHR/L	1010-2-D30B	10	10	125	10.2	6.6	30	KGMN200-□-□ KGMR/L200-□-□ KRMN200-C KGGN200-□-□	MHA0512	HW40L
	1212-2-D25B	12	12	125	12.5	3.5	25			
	1212-2-D30B	12	12	125	12.2	3.5	30			
	1616-2-D32B	16	16	125	16.2	-	32			
	1212-3-D25B	12	12	125	12.4	3.5	25			
	1212-3-D32B	12	12	125	12.4	3.5	32			
1616-3-D32B	16	16	125	16.4	-	32	KGMN300-□-□ KGMR/L300-□-□ KRMN300-C KGGN300-□-□			

➤ KGT Insert

Application	Picture	Designation	Coated						Dimensions (mm)					Configuration
			NC3120	NC3225	NC5330	NC6315	PC5300	PC9030	b	r	l	d	α °	
Grooving		KGMN 200-02-L		●	●		●	●	2.0	0.2	20	1.7	-	
		300-02-L		●	●		●	●	3.0	0.2	20	2.3	-	
Grooving-Parting off		KGMN 200-02-R		●	●		●	●	2.0	0.2	20	1.7	-	
		300-02-R		●	●		●	●	3.0	0.2	20	2.3	-	
Grooving-turning		KGMN 200-02-T		●	●	●	●	●	2.0	0.2	20	1.7	-	
		300-02-T		●	●	●	●	●	3.0	0.2	20	2.3	-	
		300-04-T		●	●	●	●	●	3.0	0.4	20	2.3	-	
Parting off (Right handed)		KGMR 200-6D-LP			●		●		2.0	0.2	20	-	6	
		200-15D-LP			●		●		2.0	0.2	20	-	15	
		300-6D-LP			●		●		3.0	0.2	20	-	6	
		300-15D-LP			●		●		3.0	0.2	20	-	15	

● : Stock item



KGT Insert

Application	Picture	Designation	Coated						Dimensions (mm)					v
			NC3120	NC3225	NC5330	NC6315	PC5300	PC9030	b	r	l	d	a °	
Parting off (Right handed)		KGMR 200-6D-RP 200-15D-RP 300-6D-RP 300-15D-RP			●		●		2.0	0.2	20	-	6	
					●		●		2.0	0.2	20	-	15	
					●		●		3.0	0.2	20	-	6	
					●		●		3.0	0.2	20	-	15	
Parting off (Left handed)		KGML 200-6D-LP 200-15D-LP 300-6D-LP 300-15D-LP							2.0	0.2	20	1.7	6	
									2.0	0.2	20	1.7	15	
									3.0	0.2	20	2.3	6	
									3.0	0.2	20	2.3	15	
Parting off (Left handed)		KGML 200-6D-RP 200-15D-RP 300-6D-RP 300-15D-RP							2.0	0.2	20	1.7	6	
									2.0	0.2	20	1.7	15	
									3.0	0.2	20	2.3	6	
									3.0	0.2	20	2.3	15	
Copying		KRMI 200-C 300-C 400-C							2.0	1.0	20	1.7	-	
									3.0	1.5	20	2.2	-	
									4.0	2.0	20	3.2	-	
Copying		KRMN 200-C 300-C	●	●	●	●	●	2.0	1.0	20	1.7	-		
			●	●	●	●	●	●	3.0	1.5	20	2.2		-

● : Stock item

MGEHR/L

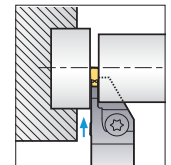
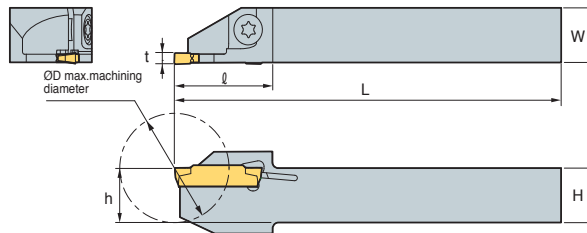

• R type insert (mm)

Designation		ØD	H=h	W	L	ℓ	t	Insert	Screw	Wrench
MGEHR/L	1010-X15A	20	10	10	125	18	1.5	MGMN150-G	ETNA 0412	TW 15L
	1212-X15A	25	12	12	125	19.5	1.5			
	1010-X20A	20	10	10	125	18	2	MGMN200-M MGMN200-G		
	1212-X20A	25	12	12	125	19.5	2			
	1616-X20A	32	16	16	125	25	2	MGMN250-M MGMN250-G		
	1010-X25A	20	10	10	125	20	2.5			
	1212-X25A	25	12	12	125	20	2.5			
	1616-X25A	32	16	16	125	25	2.5			

MGT Insert

Application	Picture	Designation	Coated						Uncoated			Dimensions (mm)					Configuration		
			NC3120	NC3225	NC5330	NC6315	NC3030	PC5300	PC9030	H01	G10	STA30	b	r	l	d		t	
Grooving		MGMN 150-G 200-G 250-G		●				●	●	●	●			1.5	0.15	16.0	1.2	3.5	
				●	●			●	●	●	●			2.0	0.2	16.0	1.6	3.5	
				●				●	●	●	●			2.5	0.2	18.5	2.0	3.85	
Grooving		MGMN 200-M 250-M	●	●	●		●	●	●	●			2.0	0.2	16.0	1.6	3.5		
			●	●			●	●	●	●			2.5	0.2	18.5	2.0	3.85		

● : Stock item



B Auto Tool (MSB tool)

Auto Tool (MSB tool)

- High hardness grade guarantees longer tool life
- Various kinds of machining (Fitting, Valve, Medical parts, Automobile component, and Semiconductor equipment) are available
- Various types of MSB tools (Boring, Grooving, Threading)

Code system

B	: Boring	
BC	: Copying	
BB	: Back Boring	
BF	: Chamfering	03: 3.0
G	: Square Grooving	04: 4.0
GR	: Round Grooving	06: 6.0
GF	: Face Grooving	08: 8.0
T	: Threading	10: 10.0

Boring	No Code		
Copying	Width of Groove		
Threading	60°	55°	
	Pitch	tpi	
◇	F	0.25~1.0	72~24
	A	0.5~1.5	48~16
	AG	0.5~3.0	48~8

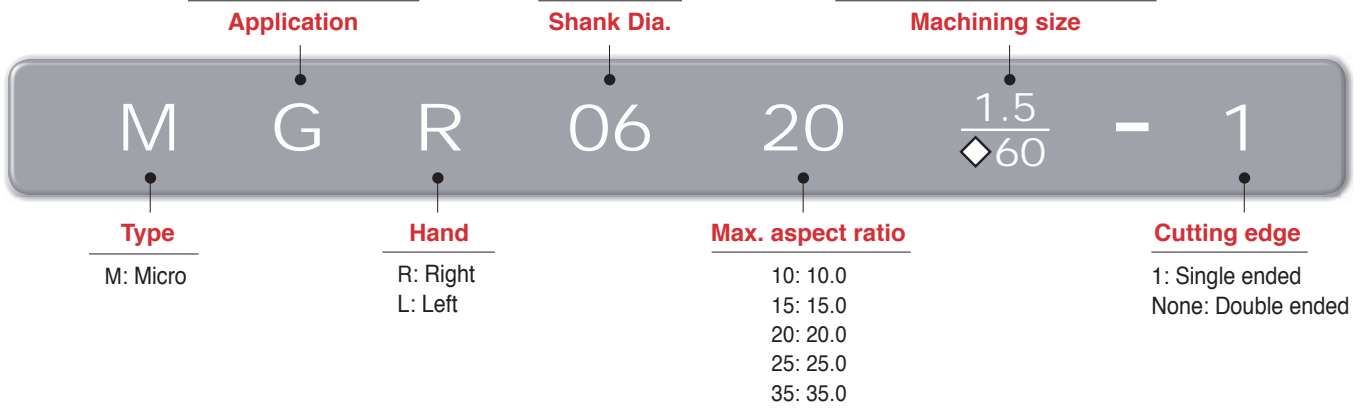

MSB tool code system

Types		Application	Designation	
01	Boring	Boring	MBR/LOO☆☆	
02		Copying	MBCR/LOO☆☆	
03		Back Boring	MBBR/LOO☆☆	
04		Chamfering	MBFR/LOO☆☆	
05	Grooving	Square Grooving	MGR/LOO☆☆-□□	
06		Round Grooving	MGRR/LOO☆☆-□□	
07		Face Grooving	MGFR/LOO00-□□	
08	Threading	Partial	60°	MTR/LOO☆☆-◇60
			55°	MTR/LOO☆☆-◇55

Details

Marks	○○	Shank Dia.			
	☆☆	Max. depth of boring			
	□□	Width of groove			
	◇	Pitch / tpi	F	0.25~1.0	72~24
			A	0.5~1.5	48~16
AG			0.5~3.0	48~8	



Grades

Grades	Coating	Application and features
Z12M	Carbide	Ultra fine grain substrate ensures superior wear resistance and toughness Application: Cast iron, Aluminum alloy and Non-ferrous metals machining
PC30M	TiN coating	TiN coated ultra fine grain substrate ensures long tool life Application: Stainless steel, heat resisting alloy and hard-to-cut material machining

Machining types

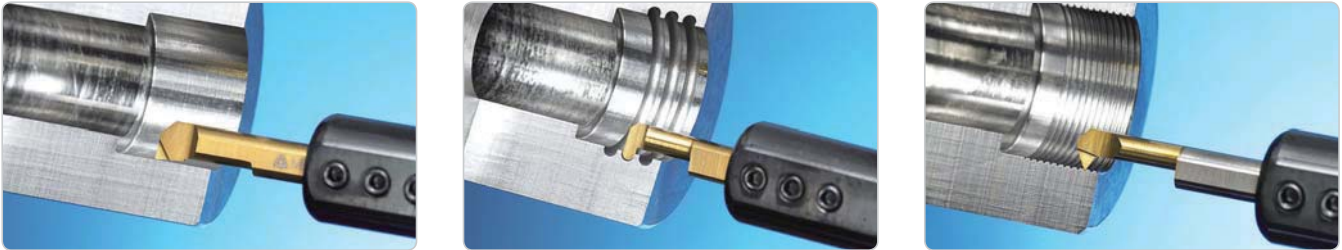

Types

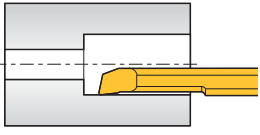
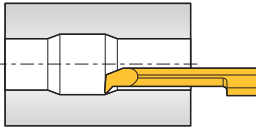
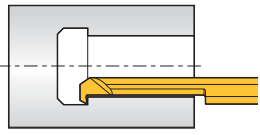
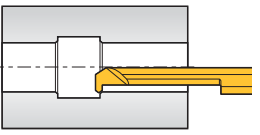
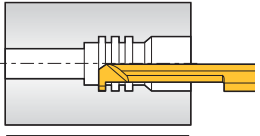
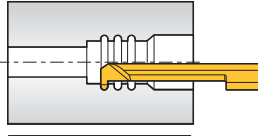
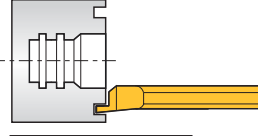
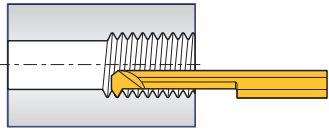
Boring	 <p>Boring Min. dia. of machining: Ø3.2</p>	 <p>Copying Min. dia. of machining: Ø4.2</p>	 <p>Back Boring Min. dia. of machining: Ø3.2</p>	 <p>Chamfering Min. dia. of machining: Ø4.2</p>
Grooving	 <p>Square Grooving Min. dia. of machining: Ø3.2</p>	 <p>Round Grooving Min. dia. of machining: Ø3.2</p>	 <p>Face Grooving Min. dia. of machining: Ø6.0</p>	
Threading	 <p>Threading Min. dia. of machining: Ø3.3</p>			

Boring

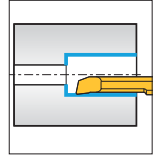
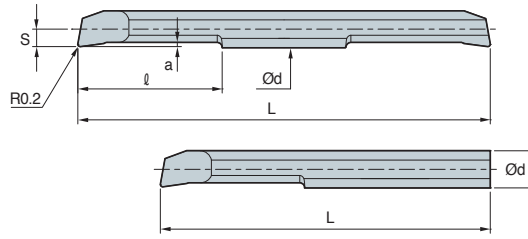

Twin Edge			Single Edge			Ød	Min.dia. of machining	l	Overall length		Detailed cutting edge	
Designation	Coated	Uncoated	Designation	Coated	Uncoated				L		a	S
	PC30M	Z12M		PC30M	Z12M				Double ended	Single ended		
MBR	0310	●	MBR	0310-1		3.0	3.2	10	40	35	0.5	1.4
	0315	●		0315-1				15	50	45		
	0410	●		0410-1				10	40	35		
	0415	●		0415-1		4.0	4.2	15	50	45	0.6	1.9
	0420	●		0420-1				20	60	50		
	0610			0610-1				10	45	40		
	0615	●		0615-1		6.0	6.2	15	55	45	0.75	2.9
	0620	●		0620-1				20	65	50		
	0810			0810-1				10	50	45		
	0820	●		0820-1		8.0	8.2	20	70	60	0.8	3.9
	0830			0830-1				30	80	70		
	1015			1015-1				15	60	60		
	1025	●		1025-1		10.0	10.2	25	80	70	1.0	4.9
	1035			1035-1				35	100	80		

● : Stock item

Copying

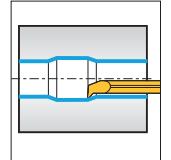
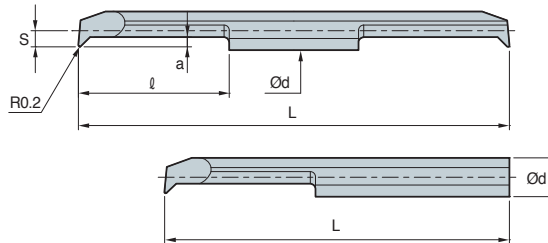

Twin Edge			Single Edge			Ød	Min.dia. of machining	l	Overall length		Detailed cutting edge	
Designation	Coated	Uncoated	Designation	Coated	Uncoated				L		a	S
	PC30M	Z12M		PC30M	Z12M				Double ended	Single ended		
MBCR	0410		MBCR	0410-1		4.0	4.2	10	40	35	1.0	1.9
	0415	●		0415-1				15	50	45		
	0420	●		0420-1				20	60	50		
	0610			0610-1		6.0	6.2	10	45	40	1.3	2.9
	0615	●		0615-1				15	55	45		
	0620	●		0620-1				20	60	50		

● : Stock item



Back Boring

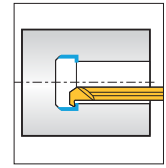
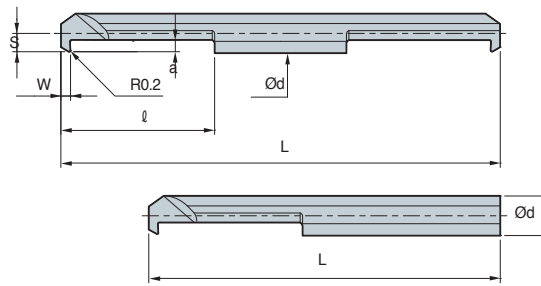

Twin Edge			Single Edge			Ød	Min.dia. of machining	ℓ	Overall length		Detailed cutting edge		
Designation	Coated	Uncoated	Designation	Coated	Uncoated				L		W	a	S
	PC30M	Z12M		PC30M	Z12M				Double ended	Single ended			
MBBR	0310		MBBR	0310-1		3.0	3.2	10	40	35	1.5	0.8	1.4
	0315			0315-1					15	45			
	0410			0410-1		4.0	4.2	10	40	35	2.0	1.3	1.9
	0415			0415-1					15	45			
	0420			0420-1					20	50			
	0610			0610-1		6.0	6.2	10	45	40	2.0	1.9	2.9
	0615			0615-1					15	45			
	0620			0620-1					20	50			

• : Stock item

Chamfering

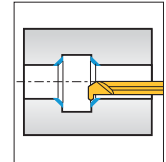
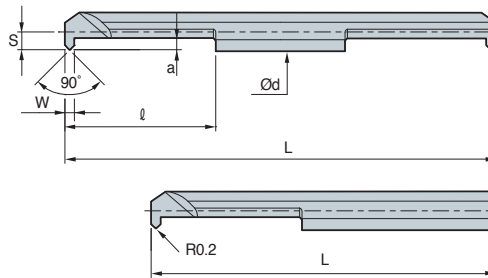

Twin Edge			Single Edge			Ød	Min.dia. of machining	ℓ	Overall length		Detailed cutting edge		
Designation	Coated	Uncoated	Designation	Coated	Uncoated				L		W	a	S
	PC30M	Z12M		PC30M	Z12M				Double ended	Single ended			
MBFR	0410		MBFR	0410-1		4.0	4.2	10	40	35	0.8	1.0	1.9
	0415			0415-1					15	45			
	0420			0420-1					20	50			
	0610			0610-1		6.0	6.2	10	45	40	1.4	1.2	2.9
	0615			0615-1					15	45			
	0620			0620-1					20	50			

• : Stock item



Square Grooving

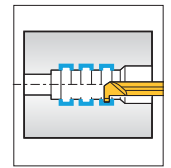
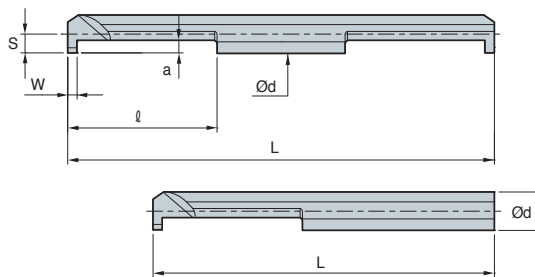

Twin Edge			Single Edge			Ød	Min.dia. of machining	l	Overall length		Detailed cutting edge		
Designation	Coated	Uncoated	Designation	Coated	Uncoated				L		W	a	S
	PC30M	Z12M		PC30M	Z12M				Double ended	Single ended			
MGR 0310-1.0			MGR 0310-1.0-1			3.0	3.2	10	40	35	1.0	0.8	1.4
0315-1.0			0315-1.0-1					15	50	45			
0310-1.5			0310-1.5-1					10	40	35	1.5		
0315-1.5			0315-1.5-1					15	50	45			
0410-1.0			0410-1.0-1			4.0	4.2	10	40	35	1.0	1.4	1.9
0420-1.0			0420-1.0-1					20	60	50			
0410-1.5			0410-1.5-1					10	40	35	1.5		
0420-1.5			0420-1.5-1					20	60	50			
0410-2.0			0410-2.0-1					10	40	35	2.0		
0420-2.0			0420-2.0-1					20	60	50			
0610-1.0	●		0610-1.0-1			6.0	6.2	10	45	40	1.0	1.8	2.9
0620-1.0	●		0620-1.0-1					20	65	50			
0610-1.5			0610-1.5-1					10	45	40	1.5		
0620-1.5			0620-1.5-1					20	65	50			
0610-2.0			0610-2.0-1					10	45	40	2.0		
0620-2.0			0620-2.0-1					20	65	50			
0610-2.5			0610-2.5-1					10	45	40	2.5		
0620-2.5			0620-2.5-1					20	65	50			
0820-1.5			0820-1.5-1			8.0	8.2	20	70	60	1.5	2.5	3.9
0820-2.0			0820-2.0-1								2.0		
0820-2.5			0820-2.5-1								2.5	3.5	
0820-3.0			0820-3.0-1								3.0		
1025-1.5			1025-1.5-1			10.0	10.2	25	80	70	1.5	2.5	4.9
1025-2.0			1025-2.0-1								2.0		
1025-2.5			1025-2.5-1								2.5	3.5	
1025-3.0			1025-3.0-1								3.0		

● : Stock item



Round Grooving

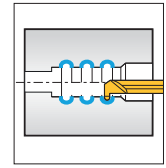
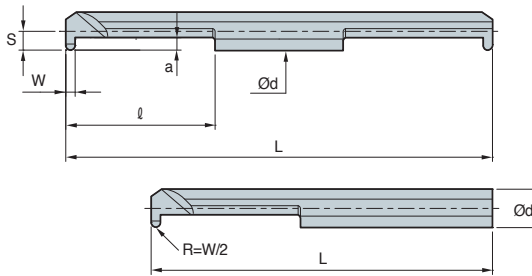

Twin Edge			Single Edge			Ød	Min.dia. of machining	l	Overall length		Detailed cutting edge			
Designation	Coated	Uncoated	Designation	Coated	Uncoated				L		W	a	S	
	PC30M	Z12M		PC30M	Z12M				Double ended	Single ended				
MGRR	0310-0.8		MGRR	0310-0.8-1		3.0	3.2	10	40	35	0.8	0.8	1.4	
	0315-0.8			0315-0.8-1					15	45				
	0410-1.0			0410-1.0-1		4.0	4.2	10	40	35	1.0	1.0	1.9	
	0420-1.0			0420-1.0-1					20	60				50
	0610-1.0			0610-1.0-1		6.0	6.2	10	45	40	1.0	2.0	2.9	
	0620-1.0			0620-1.0-1					20	65				50
	0610-1.5			0610-1.5-1					10	45	40			
	0620-1.5			0620-1.5-1					20	65	50			
	0610-2.0			0610-2.0-1		8.0	8.2	20	45	40	2.0	2.3	3.9	
	0620-2.0			0620-2.0-1					10	45				40
	0820-1.0			0820-1.0-1					20	70				60
	0820-1.5			0820-1.5-1		10.0	10.2	25	80	70	1.0	2.8	4.9	
	0820-2.0			0820-2.0-1							1.5			
	1025-1.0			1025-1.0-1							2.0			
	1025-1.5			1025-1.5-1		1.0	2.0	2.0	80	70	1.5	2.8	4.9	
	1025-2.0			1025-2.0-1		2.0								

● : Stock item

Face Grooving

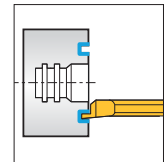
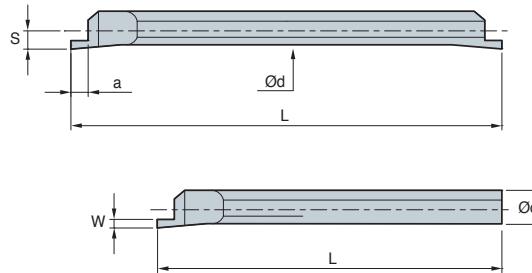
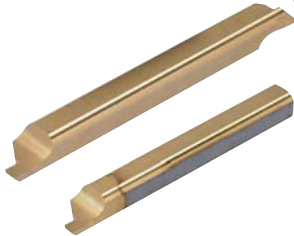

Twin Edge			Single Edge			Ød	Min.dia. of machining	Overall length		Detailed cutting edge		
Designation	Coated	Uncoated	Designation	Coated	Uncoated			L		W	a	S
	PC30M	Z12M		PC30M	Z12M			Double ended	Single ended			
MGFR	0400-1.0		MGFR	0400-1.0-1		4.0	6.0	50	45	1.0	1.5	1.8
	0400-1.5			0400-1.5-1						1.5	2.0	
	0600-1.0			0600-1.0-1		6.0	8.5	50	45	1.0	1.5	2.9
	0600-1.5			0600-1.5-1						1.5	2.0	
	0600-2.0	●		0600-2.0-1		8.0	10.4	70	60	2.0	2.5	3.9
	0800-1.0	●		0800-1.0-1						1.0	1.5	
	0800-1.5	●		0800-1.5-1						1.5	2.0	
	0800-2.0	●		0800-2.0-1						2.0	2.5	
	0800-2.5	●		0800-2.5-1	●	10.0	12.4	80	70	2.5	3.0	4.9
	0800-3.0	●		0800-3.0-1	●					3.0	3.5	
				0800-3.5-1	●					3.5	4.0	
	1000-2.0			1000-2.0-1		10.0	12.4	80	70	2.0	2.5	4.9
	1000-2.5			1000-2.5-1						2.5	3.0	
	1000-3.0			1000-3.0-1						3.0	3.5	
	1000-3.5			1000-3.5-1						3.5	4.0	
	1000-4.0			1000-4.0-1						4.0	4.5	
1000-4.5		1000-4.5-1		4.5	5.0							

● : Stock item



Threading

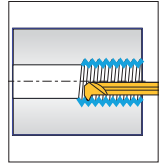
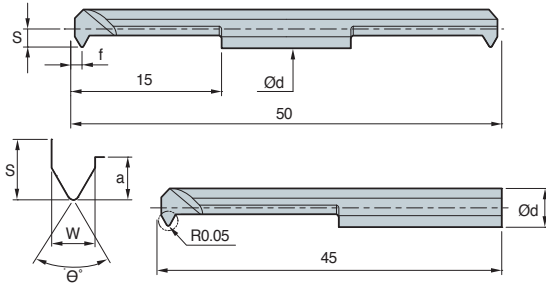
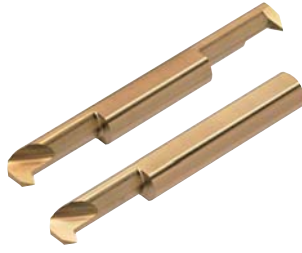

Twin Edge			Single Edge			Ød	Min.dia. of machining	Threading			Detailed cutting edge		
Designation	Coated PC30M	Uncoated Z12M	Designation	Coated PC30M	Uncoated Z12M			W	Pitch / tpi	θ°	S	a	f
MTR	0315-F60		MTR	0315-F60-1		3.0	3.3	1.2	0.5~1.0	60°	1.45	1.2	0.6
	0415-F60			0415-F60-1		4.0	4.3				1.95		
	0615-A60			0615-A60-1		6.0	6.2				2.0		
	0315-F55			0315-F55-1		3.0	3.3	1.2	48~24	55°	1.45	1.2	0.6
	0415-F55			0415-F55-1		4.0	4.3				1.95		
	0615-A55			0615-A55-1		6.0	6.2				2.0		

● : Stock item

SLEEVE

SL (SLEEVE)

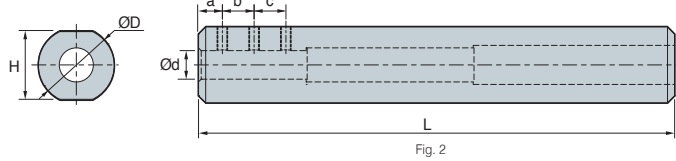
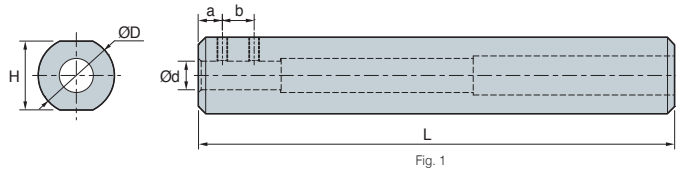

Designation	Ød	a	b	c	ØD	H	L	Screw	Wrench	Fig.
SL1603	3	5	-	-	16	14	100	M3	HW15L	1
SL1604	4	5	6	-	16	14	100	M4	HW20L	
SL1605	5	5	8	-	16	14	100	M4	HW20L	
SL1606	6	5	6	6	16	14	100	M4	HW20L	2
SL1607	7	5	6	8	16	14	100	M4	HW20L	
SL2008	8	5	10	10	20	18	100	M4	HW20L	2
SL2010	10	5	10	10	20	18	100	M5	HW20L	

* Fine tolerance and surface roughness



Multi Turn

Holder code system



Insert code system

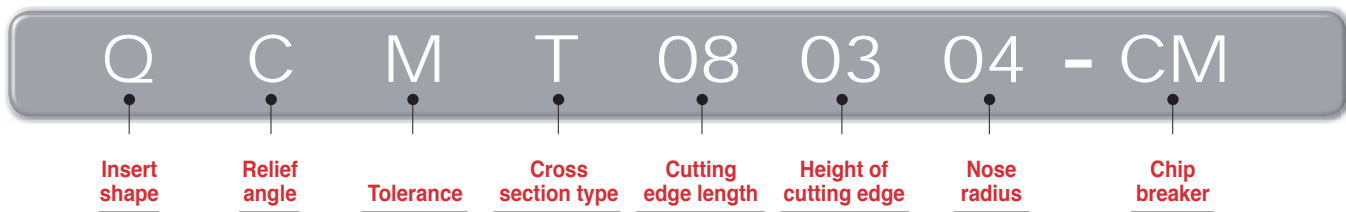

Tool design by FEM analysis

- Double coolant system
- Excellent chip evacuation and tool life
- Ideal flute design minimizing stress concentrations

※ Notice: Clamp an insert shown as in the picture

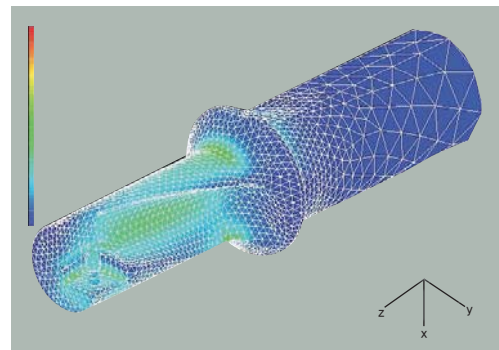

• Minimized stress during cutting, prevented damage from vibration and longer tool life
Optimized design

Creative stepping cutting edge

Drilling edge (Drilling) Turning edge (Internal, external and face turning)

Multi-Turn

L1 L2

- Special chip formed by edge geometry better chip
- evacuation due to small radius width of chip curl

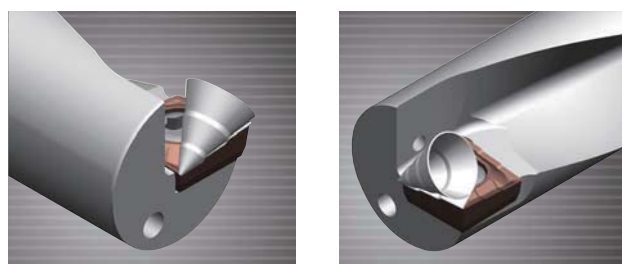

Comparison	Multi turn	Competitor A	Competitor B
v_{fn} (mm/rev) = 0.08			
Feed f_n (mm/rev) = 0.10			
Chip width (rate)	80%	100%	120%

B Technical Information for Multi Turn

🔗 User's guide

External / Internal turning

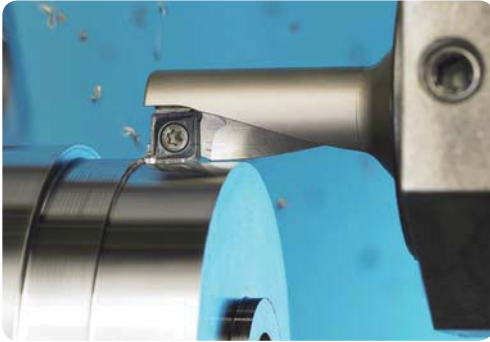

● Application range

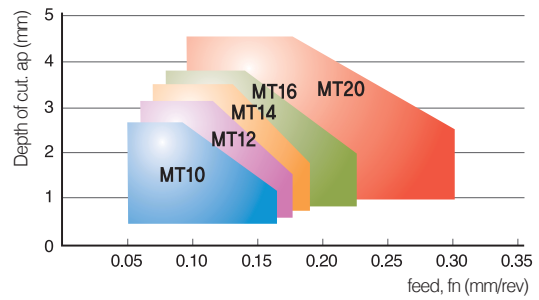

Facing



● Application ranges of facing

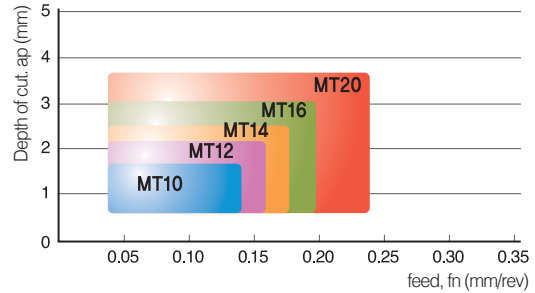

Drilling



● Drilling feed range by designation

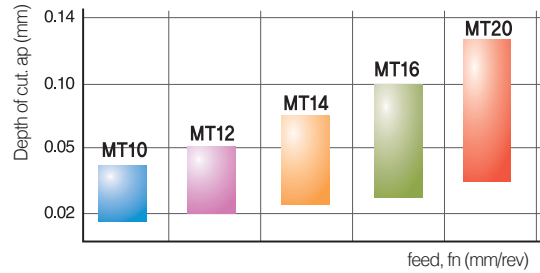

Offset (Diameter compensation)

Disignation	Machined diameter (mm)	ØDmin (mm)	ØDmax (mm)
MT10R/L-2.25D	10	9.85	10.35
MT12R/L-2.25D	12	11.85	12.35
MT14R/L-2.25D	14	13.85	14.35
MT16R/L-2.25D	16	15.85	16.35
MT20R/L-2.25D	20	19.85	20.35
MT25R/L-2.25D	25	24.85	25.35
MT32R/L-2.25D	32	31.85	32.35

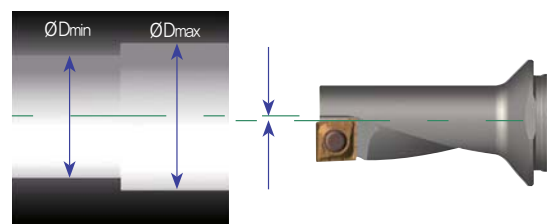

Drill diameter is adjustable by the offset compensation



MT (Multi-Turn)

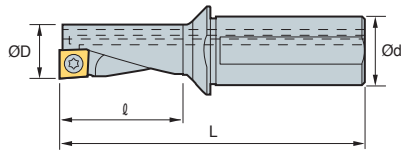
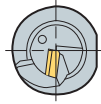

Designation		ØD	Ød	l	L	Insert	Screw	Wrench
MT	10R/L-2.25D	10	12	22.5	69.5	QC□T050204	FTNA0204S	TW06P
	12R/L-2.25D	12	16	27.0	78.0	QC□T060204	FTNA02205S	TW06P
	14R/L-2.25D	14	16	31.5	83.5	QC□T070304	FTKA02555	TW07P
	16R/L-2.25D	16	20	36.0	94.0	QC□T080304	FTNA0306	TW09P
	20R/L-2.25D	20	25	45.0	111.0	QC□T10T304	FTNA03508	TW15P
	25R/L-2.25D	25	32	56.5	130.0	QC□T130408	FTNC04509	TW20S
	32R/L-2.25D	32	40	72.0	160.0	QC□T170508	FTNC04511	TW20S

(mm)

Insert

Picture	Designation	Coated				Uncoated		Dimensions (mm)					Configuration
		NC3120	NC3225	NC6315	PC5300	H01	H05	l	d	t	r	Ød ₁	
	QCMT 050204-CM		●	●	●			5.0	5.4	2.10	0.4	2.3	
	060204-CM		●	●	●			6.0	6.4	2.38	0.4	2.5	
	070304-CM		●	●	●			7.0	7.4	3.18	0.4	2.8	
	080304-CM		●	●	●			8.0	8.4	3.18	0.4	3.4	
	10T304-CM		●			●		10.0	10.4	3.97	0.4	4.0	
	130408-CM		●			●		12.7	13.5	4.76	0.8	5.5	
	QCGT 050204-CA					●		5.0	5.4	2.10	0.4	2.3	
	060204-CA					●		6.0	6.4	2.38	0.4	2.5	
	070304-CA					●		7.0	7.4	3.18	0.4	2.8	
	080304-CA					●		8.0	8.4	3.18	0.4	3.4	
	10T304-CA					●		10.0	10.4	3.97	0.4	4.0	
	130408-CA					●		12.7	13.5	4.76	0.8	5.5	
	170508-CA					●		16.7	17.5	5.56	0.8	5.5	

● : Stock item



Bearing Solution

Holder code system

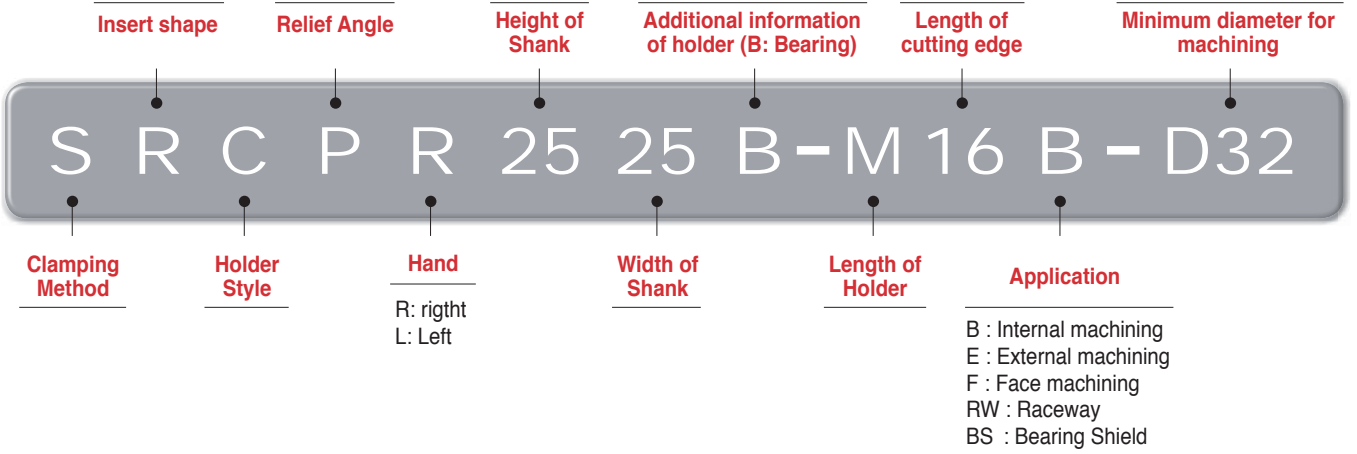

Insert code system for race way and bearing shield machining

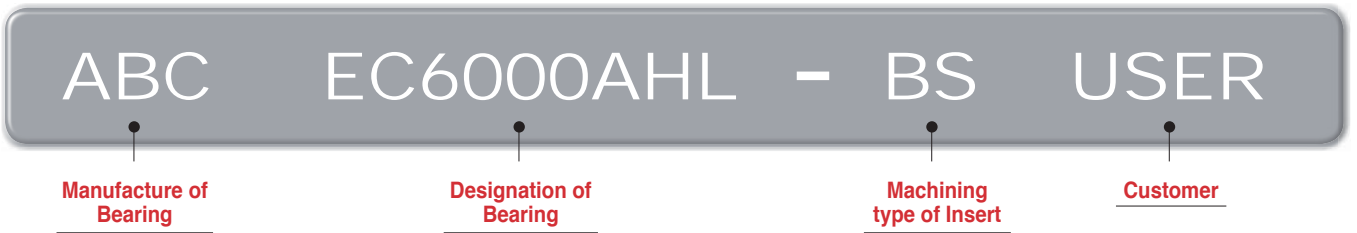

CMSN...F Type

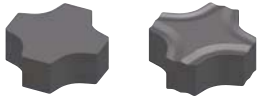

MC12□□ MC12□□-BR
MC15□□

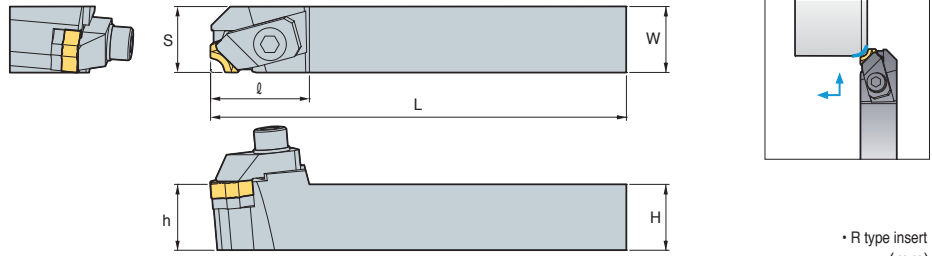

• R type insert (mm)

Designation	H	W	L	S	h	ℓ	Insert	Clamp	Clamp Screw	Shim	Shim Screw	Wrench	
CMSNR/L	2020B-L12F	20	20	140	21	20	33	MC12□□	CH6R/L1B	BHA0620	SX42CB	SS0308	HW50L
	2023B-L12F	20	23	140	24	20	33	MC12□□-BR					
	2525B-L15F	25	25	140	26	25	35	MC15□□					

CMSN...B Type

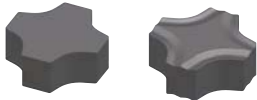

MC12□□ MC12□□-BR

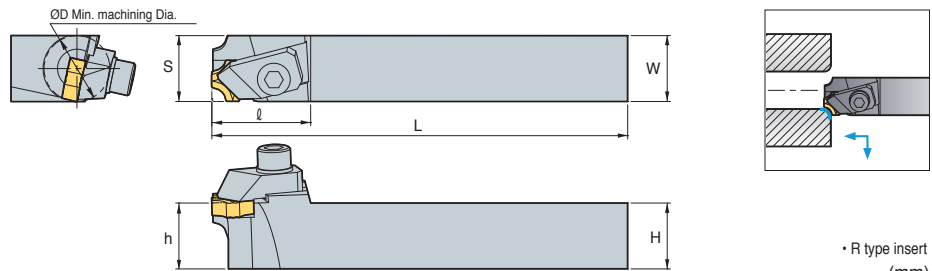

• R type insert (mm)

Designation	ØD	H	W	L	S	h	ℓ	Insert	Clamp	Clamp Screw	Shim	Shim Screw	Wrench
CMSNR/L	2020B-L12B-D28	28	20	20	140	21	20	MC12□□	CH6R/L1B	BHA0620	SX42CB	SS0308	HW50L
	2525B-L12B-D28	28	25	25	140	26	25		33	CH6R/L1B	BHA0620	SX42CB	SS0308
	1620B-L12B-D20	20	16	20	140	18	16	32	CH6R/L1B	BHA0620	-	-	HW50L
	2023B-L12B-D28	28	20	23	140	24	20	33	CH6R/L1B	BHA0620	SX42CB	SS0308	HW50L

Insert

Application	Picture	Designation	Cermet	Dimensions (mm)					Configuration
			CN2000	R	θ°	B	d	t	
R-Chamfering ²⁾		MC0906		0.6	12	1.8	9.525	3.18	
		MC0910		1.0	12	2.4	9.525	3.18	
		MC1206		0.6	18	1.8	12.7	4.76	
		MC1210		1.0	18	2.4	12.7	4.76	
		MC1212		1.2	18	2.2	12.7	4.76	
		MC1215		1.5	18	3.0	12.7	4.76	
		MC1220		2.0	18	3.8	12.7	4.76	
		MC1225		2.5	18	2.8	12.7	4.76	
		MC1525		2.5	18	4.0	15.875	5.56	
		MC1530		3.0	18	4.7	15.875	5.56	
	MC1540		4.0	20	4.7	15.875	5.56		
		MC1206-BR		0.6	18	1.8	12.7	4.76	
		MC1210-BR		1.0	18	2.4	12.7	4.76	
		MC1212-BR		1.2	18	2.2	12.7	4.76	
		MC1215-BR		1.5	18	3.0	12.7	4.76	
		MC1220-BR		2.0	18	3.2	12.7	4.76	
MC1230-BR			3.0	18	3.7	12.7	4.76		
MC1235-BR		3.5	18	3.9	12.7	4.76			

● : Stock item

Special order-form

Designation	CN1000	CN2000	R	θ°	B	d	t	Configuration
MC...								



SRGP...E Type



RPGT1203M0
RPGT1604M0
RPGT2004M0

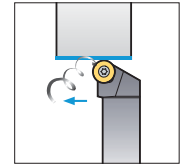
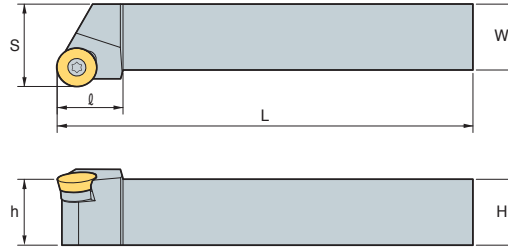

• R type insert
(mm)

Designation	H	W	L	S	h	l	Insert	Screw	Shim	Shim Screw	Wrench
SRGPR/L	2020B-L12E	20	20	140	25	20	RPGT1203M0	FTKA0410	SR1203S	SHXN0609F	TW15P
	2020B-L16E	20	20	140	25	20	RPGT1604M0	FTNA0513	SR16T3S	SHXN0712F	TW20P
	2525B-L20E	25	25	140	32	25	RPGT2004M0	FTNA0513	SR20T3S	SHXN0712F	TW20P

SRGP...F Type



RPGT1203M0
RPGT1604M0
RPGT2004M0

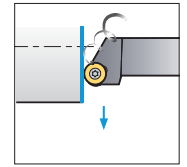
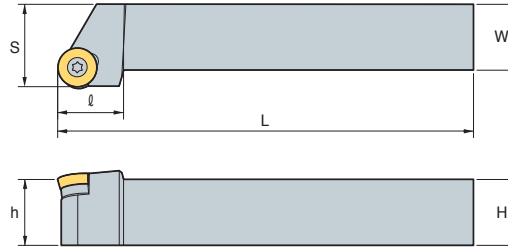

• R type insert
(mm)

Designation	H	W	L	S	h	l	Insert	Screw	Shim	Shim Screw	Wrench
SRGPR/L	2020B-L12F	20	20	140	25	20	RPGT1203M0	FTKA0410	SR1203S	SHXN0609F	TW15P
	2020B-L16F	20	20	140	25	20	RPGT1604M0	FTNA0513	SR16T3S	SHXN0712F	TW20P
	2525B-L20F	25	25	140	32	25	RPGT2004M0	FTNA0513	SR20T3S	SHXN0712F	TW20P

SRCP...B Type



RPGT0802M0
RPGT1203M0
RPGT1604M0

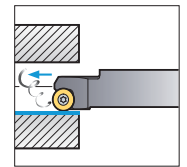
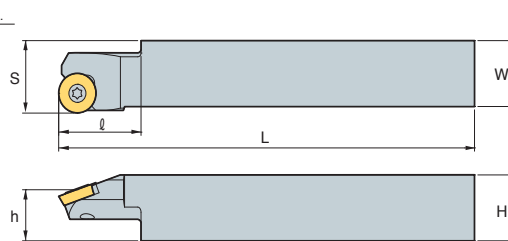
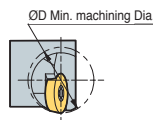

• R type insert
(mm)

Designation	ØD	H	W	L	S	h	l	Insert	Screw	Wrench
SRCPR/L	2020B-L08B-D12	12	20	20	140	21.5	15.5	RPGT0802M0	FTKA0305	TW09P
	1919B-L12B-D15	15	19	19	140	21	16	RPGT1203M0	FTNA0408	TW15P
	2020B-L12B-D20	20	20	20	140	22	15.5	RPGT1203M0	FTNA0408	TW15P
	2525B-L16B-D32	32	25	25	140	27	20	RPGT1604M0	FTKA0510	TW20P



CSKP...B Type



SPGR120440L

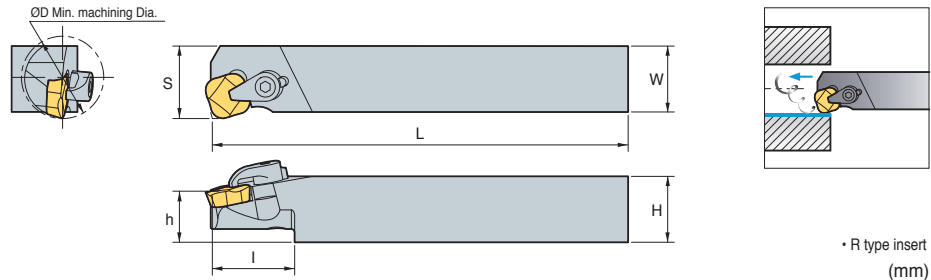

• R type insert (mm)

Designation	ØD	H	W	L	S	h	ℓ	Insert	Clamp	Clamp Screw	Wrench
CSKPR/L 2022B-L12B-D30	30	20	22	140	27	20	37	SPGR120440R/L	CH5R1	CHX0510	HW30L

SSKP...B Type

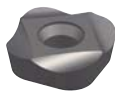

SPGH090330L

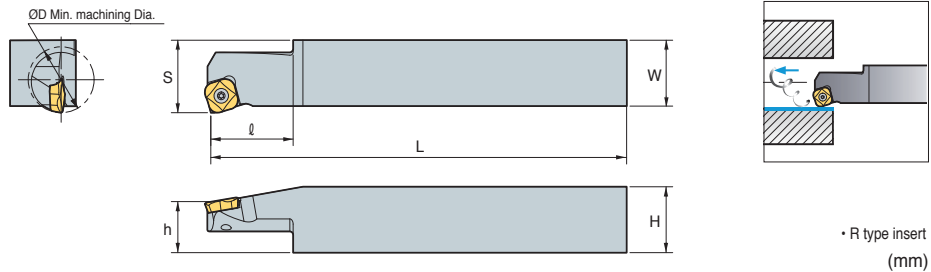

• R type insert (mm)

Designation	ØD	H	W	L	S	h	ℓ	Insert	Screw	Wrench
SSKPR/L 2020B-L09B-D12	12	20	20	140	21.7	19	20	SPGH090330R/L	FTNA0307	TW09P
2020B-L09B-D13	13	20	20	140	21.7	19	20			
2020B-L09B-D20	20	20	20	140	21.7	19	20			

Insert

Application	Picture	Designation	Cermet	Dimensions (mm)				Configuration	
			CN2000	r	d	d ₁	t		
Internal turning		RPGT0802M0		-	8	3.4	2.38		
		RPGT1203M0		-	12	4.4	3.18		
		RPGT1604M0		-	16	5.5	4.76		
		RPGT2004M0		-	20	5.5	4.76		
		SPGR120440L			4.0	12..7	-	4.76	
		SPGH090330L			3.0	9.525	3.4	3.18	



B Bearing Solution

CKFN...RW Type



KORIC

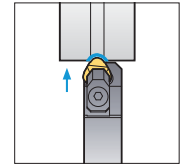
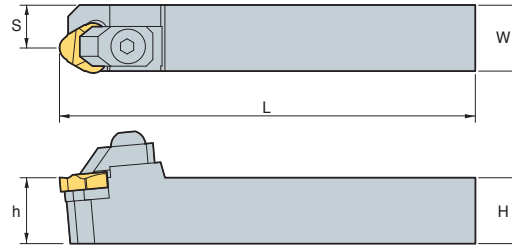
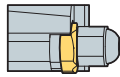

• R type insert (mm)

Designation	H	W	L	S	h	Insert	Clamp	Clamp Screw	Shim	Shim Screw	Wrench
CKFNRL 2020B-L22RW	20	20	140	12.5	20	KORIC2204R/L	CH6N1B	BHA0620	ST42CB	SS0408	HW50L
2022B-L27RW	20	22	140	13	20	KORIC2704R/L	CH8R/L1B	BHA0820	ST52CB	SS0408	HW60L
2025B-L33RW	20	25	140	16	20	KORIC3306R/L	CH8R/L1B	BHA0820	ST62CB	SS0408	HW60L
2533B-L44RW	25	33	140	21	25	KORIC4408R/L	CH8R/L1B	BHA0820	ST82CB	SS0408	HW60L

CKGN...RW Type



KORIC

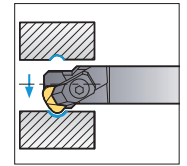
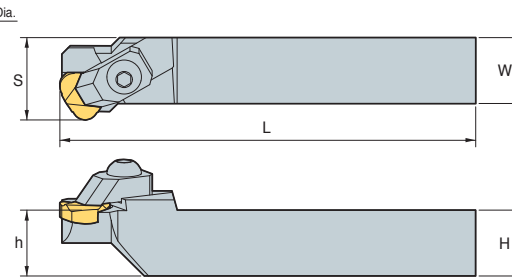
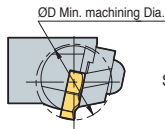

• R type insert (mm)

Designation	ØD	H	W	L	S	h	Insert	Clamp	Clamp Screw	Shim	Shim Screw	Wrench
CKGNRL 2022B-L22RW-D23	23	20	22	140	30	20	KORIC2204R/L	CH6R/L3B	BHA0620	ST42CB	SS0408	HW50L
2022B-L27RW-D29	29	20	22	140	34	20	KORIC2704R/L	CH6R/L7B	BHA0620	ST52CB	SS0408	HW50L
2025B-L33RW-D38	38	20	25	140	33	20	KORIC3306R/L	CH6R/L5B	BHA0620	ST62CB	SS0408	HW50L
2528B-L38RW-D50	50	25	28	140	46	25	KORIC3806R/L	CH8R/L2B	BHA0820	ST72CB	SS0408	HW60L
2528B-L44RW-D52	52	25	28	140	50	25	KORIC4408R/L	CH8R/L2B	BHA0820	ST82CB	SS0408	HW60L

CSGN...RW Type



SNGN

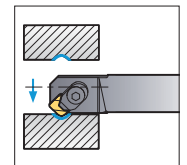
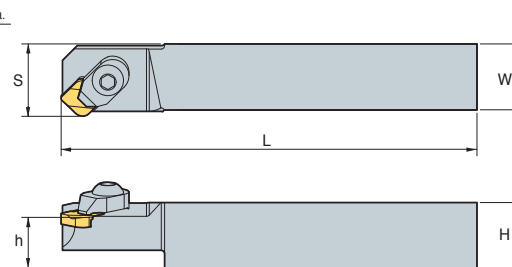
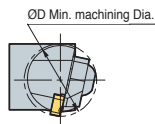

• R type insert (mm)

Designation	ØD	H	W	L	S	h	Insert	Clamp	Clamp Screw	Wrench
CSGNRL 2020B-L09RW-D17	17	20	20	140	22	20	SNGN0903WR/L	CH5R1	CHX0510	HW30L
2020B-L09RW-D22	22	20	20	140	22	20	SNGN0903WR/L	CH5R1	CHX0510	HW30L



CSBN...BS Type

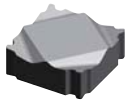

SNGN

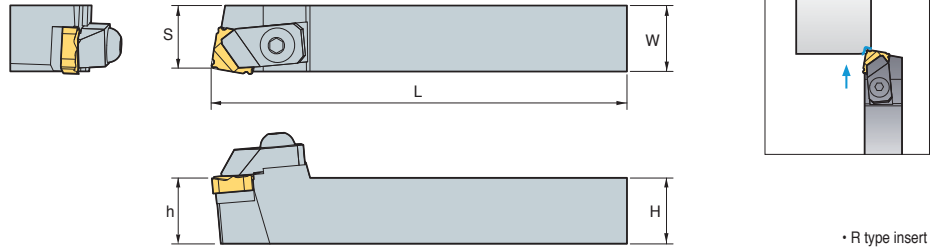

• R type insert (mm)

Designation	H	W	L	S	h	Insert	Clamp	Clamp Screw	Shim	Shim Screw	Wrench
CSBNR/L 2023B-L12BS	20	23	140	21	20	SNGN1204SR/L	CH6N1B	BHA0620	SS42CB	SS0308	HW50L
2525B-L15BS	25	25	140	23	25	SNGN1504SR/L	CH6N1B	BHA0620	SS52CB	SS0408	HW50L

CSKN...BS Type

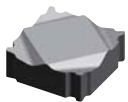

SNGN

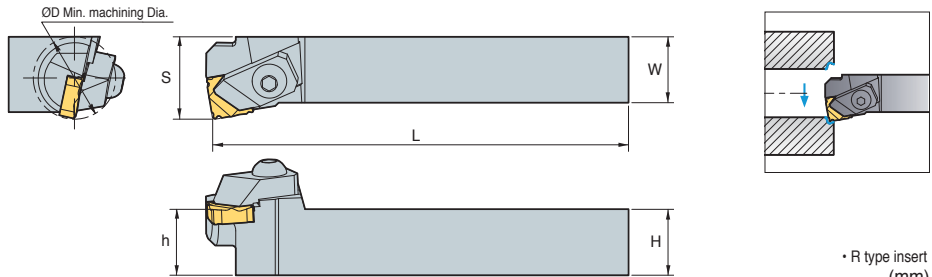

• R type insert (mm)

Designation	ØD	H	W	L	S	h	Insert	Clamp	Clamp Screw	Shim	Shim Screw	Wrench
CSKNR/L 1622B-L09BS-D14	14	16	22	140	16	16	SNGN0903SR/L	CH6R/L2B	BHA0620	-	-	HW50L
2022B-L12BS-D26	26	20	22	140	27	20	SNGN1204SR/L	CH6R/L1B	BHA0620	SS42CB	SS0308	HW50L
2525B-L15BS-D35	35	25	25	140	31	25	SNGN1504SR/L	CH6R/L3B	BHA0620	SS52CB	SS0408	HW50L

CTGN...BS Type

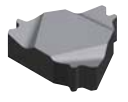

TNGN

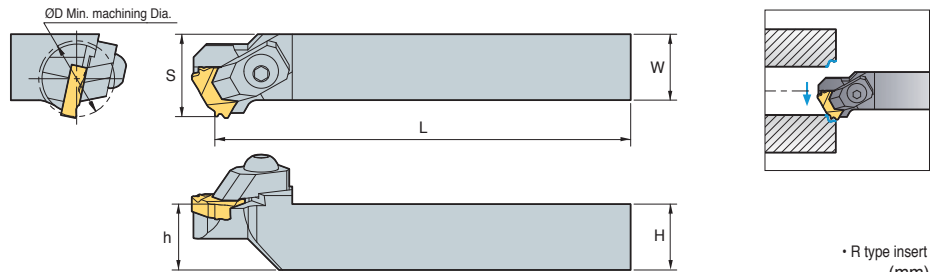

• R type insert (mm)

Designation	ØD	H	W	L	S	h	Insert	Clamp	Clamp Screw	Shim	Shim Screw	Wrench
CTGNR/L 2021B-K22BS-D25	25	20	21	140	30	20	TNGN2204SR/L	CH6R/L7B	BHA0620	ST42CB	SS0408	HW50L



SPB-S Type

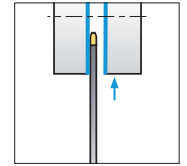
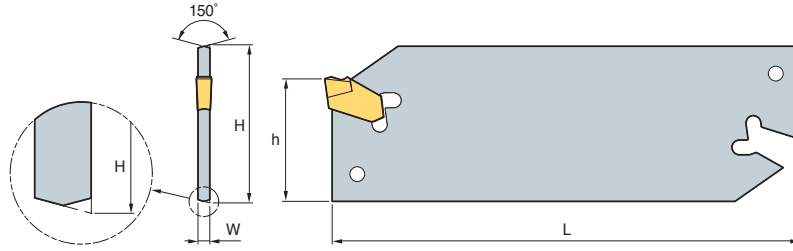

(mm)

Designation	H	W	L	h	Insert	Wrench	
SPB	1626-S	26	1.3	110	21	SP160	SW15S
	1632-S	32	1.3	150	25		
	1826-S	26	1.5	110	21	SP180	
	1832-S	32	1.5	150	25		
	226-S	26	1.6	110	21	SP200, SP200R/L	
	232-S	32	1.6	150	25		
	326-S	26	2.4	110	21	SP300, SP300R/L	
	332-S	32	2.4	150	25		
	426-S	26	3.2	110	21	SP400, SP400R/L	
	432-S	32	3.2	150	25		
	526-S	26	4.0	110	21	SP500, SP500R/L	
	532-S	32	4.0	150	25		
	626-S	26	5.2	110	21	SP600, SP600R/L	
	632-S	32	5.2	150	25		

Insert

Application	Picture	Designation	Coated										Un-coated	Dimensions (mm)			Configuration	
			NCM325	NC3120	NC3225	NC3030	NC5330	PC3035	PC8105	PC8110	PC5300	PC9030	STA30	W	l	r		
Parting tools		SP 160												1.6	7.8	0.16	<div style="display: flex; justify-content: space-around;"> <div style="text-align: center;"> <p>R type</p> </div> <div style="text-align: center;"> <p>Standard</p> </div> </div> <div style="display: flex; justify-content: space-around; margin-top: 10px;"> <div style="text-align: center;"> <p>L type</p> </div> <div style="text-align: center;"> </div> </div>	
		SP 180													1.8	9.3		0.16
		SP 200	●		●	●	●			●	●	●			2.2	9.3		0.2
		SP 200R					●					●			2.2	9.3		0.2
		SP 200L										●			2.2	9.3		0.2
		SP 300	●	●	●	●	●			●	●	●	●		3.1	11.3		0.2
		SP 300R	●		●	●				●					3.1	11.3		0.2
		SP 300L				●									3.1	11.3		0.2
		SP 400	●	●	●	●	●			●	●	●			4.1	11.3		0.25
		SP 400R				●				●					4.1	11.3		0.25
		SP 400L				●									4.1	11.3		0.25
		SP 500	●			●	●			●	●				5.1	11.4		0.3
		SP 500R													5.1	11.4		0.3
		SP 500L													5.1	11.4		0.3
		SP 600				●	●				●				6.4	11.4		0.35
		SP 600R													6.4	11.4		0.35
SP 600L													6.4	11.4	0.35			

● : Stock item



Machining Race-way

KORIC... R/L Type

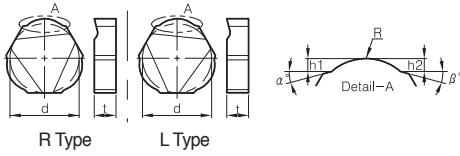

		d	t	R	h ₁	h ₂	α°	β°
KORIC	2204R/L	12.7	4.76					
	2704R/L	15.875	4.76					
	3306R/L	19.05	6.0					
	3806R/L	22.225	6.0					
	4408R/L	25.4	8.0					

SNGN... WR/L Type

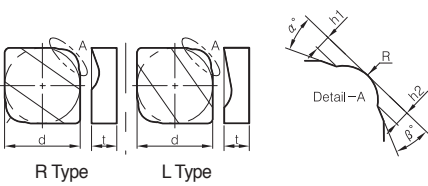

		d	t	R	h ₁	h ₂	α°	β°
SNGN	0903WR/L	9.525	3.18					
	1504WR/L	15.875	4.76					
	1905WR/L	19.05	5.56					

Machining for Bearing shield

KORIC... R/L Type

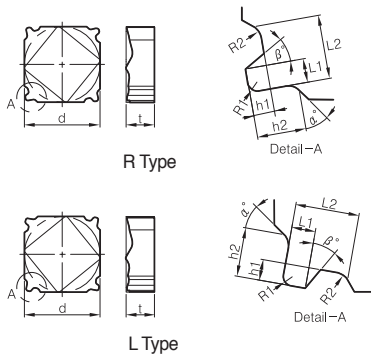

		d	t	L ₁	L ₂	h ₁	h ₂	R ₁	R ₂	α°	β°
SNGN	0903SR/L	9.525	3.18								
	1204SR/L	12.7	4.76								
	1504SR/L	15.875	4.76								

TNGN...SR/L Type

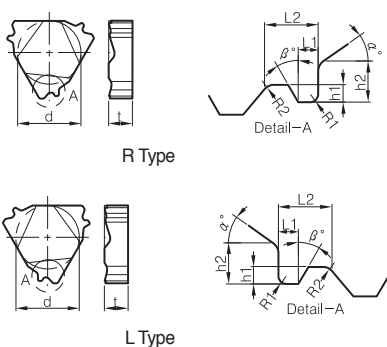

		d	t	L ₁	L ₂	h ₁	h ₂	R ₁	R ₂	α°	β°
TNGN	02204SR/L	12.7	4.76								

B External tool Holder Code System(ISO)

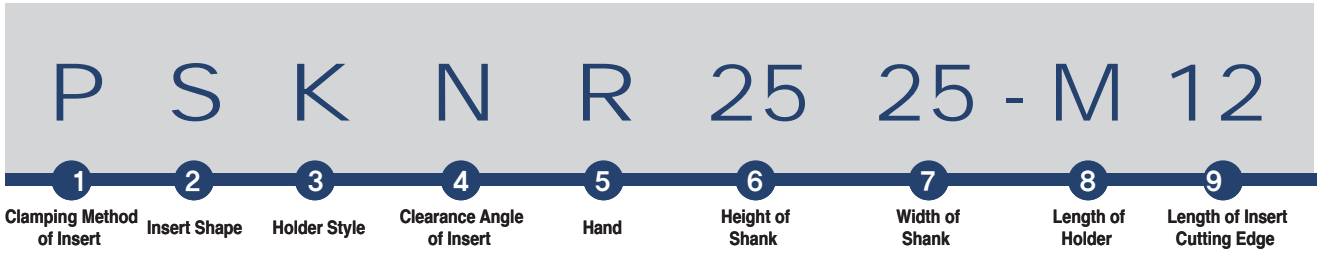

1 Clamping Method of Insert

P S K N R 25 25 - M 12

C
D
M
P
S
W

2 Insert Shape

P S K N R 25 25 - M 12

C
D
E
K

L
R
S
T

V
W

3 Holder Style

P S K N R 25 25 - M 12

B
D
E
F
G
J
K

L
N
R
S
T
V
Y

4 Clearance Angle of Insert

P S K N R 25 25 - M 12

B
C
D
E

F
N
P

5 Hand

P S K N R 25 25 - M 12

L
N
R

6 Height of Shank

P S K N R 25 25 - M 12

H

7 Width of Shank

P S K N R 25 25 - M 12

W

8 Length of Holder

P S K N R 25 25 - M 12

A - 32	H - 100	Q - 180
B - 40	J - 110	R - 200
C - 50	K - 125	S - 250
D - 60	L - 140	T - 300
E - 70	M - 150	U - 350
F - 80	N - 160	V - 400
G - 90	P - 170	W - 450

X-Special Item

9 Length of Insert Cutting Edge

P S K N R 25 25 - M 12

A,B,K
C,D,E,M,V
H
L

O
P
R

S
T
W



Double Clamp System

Cutting Shape										
Designation	DCBNR/L	DCKNR/L	DCLNR/L	DDJNR/L	DSBNR/L	DSDNN	DSKNR/L	DSSNR/L	DTFNR/L	DTGNR/L
Approach angle	75°	75°	95°	93°	75°	45°	75°	45°	90°	90°
Page	B154	B154	B154	B155	B155	B156	B156	B156	B157	B157
Turning	●		●	●	●	●		●		●
Copying				●						
Facing		●	●				●	●	●	
Chamfering						●				
Back turning			●	●						
Cutting Shape										
Designation	DVJNR/L	DVVNN	DWLNR/L							
Approach angle	93°	72.5°	95°							
Page	B157	B158	B158							
Turning	●	●	●							
Copying	●	●								
Facing			●							
Chamfering										
Back turning	●		●							

Lever Lock System

Cutting Shape										
Designation	PCBNR/L	PCKNR/L	PCLNR/L	PDJNR/L	PDNNR/L	PRDCN	PRGCR/L	PSBNR/L	PSDNN	PSKNR/L
Approach angle	75°	75°	95°	93°	62.5°	-	-	75°	45°	75°
Page	B159	B159	B160	B160	B161	B162	B162	B163	B163	B164
Turning	●	●	●	●	●	●	●	●	●	
Copying				●	●	●	●			
Facing			●							●
Chamfering										
Back turning			●	●						
Cutting Shape										
Designation	PSSNR/L	PTFNR/L	PTGNR/L	PTTNR/L	PWLNR/L					
Approach angle	45°	90°	90°	60°	95°					
Page	B164	B165	B165	B166	B166					
Turning	●		●	●	●					
Copying										
Facing	●	●			●					
Chamfering				●						
Back turning					●					

B Index for External Holder

Wedge Clamp System

Cutting Shape										
Designation	WTENN	WTJNR/L	WTXNR/L	WWLNR/L						
Approach angle	60°	93°	105°	95°						
Page	B167	B167	B167	B168						
Turning	●	●	●	●						
Copying	●	●	●							
Facing				●						
Chamfering										
Back turning		●	●	●						

Clamp on System

Cutting Shape										
Designation	CKJNR/L	CKNNR/L	CSDPN	CSKPR/L	CTFPR/L	CTGPR/L				
Approach angle	93°	62.5°	45°	75°	90°	90°				
Page	B169	B169	B169	B170	B170	B170				
Turning	●	●	●			●				
Copying	●	●								
Facing				●	●					
Chamfering										
Back turning	●									

Multi Lock System

Cutting Shape										
Designation	MCKNR/L	MCLNR/L	MCMNN	MCRNR/L	MDJNR/L	MDNNN	MDQNR/L	MSBNR/L	MSDNN	MSKNR/L
Approach angle	75°	95°	50°	75°	93°	62.5°	107.5°	75°	45°	75°
Page	B171	B171	B171	B172	B172	B172	B173	B173	B173	B174
Turning		●	●	●	●	●	●	●	●	
Copying					●	●	●			
Facing	●	●								●
Chamfering										
Back turning		●			●		●			

Cutting Shape										
Designation	MSRNR/L	MSSNR/L	MTENN	MTFNR/L	MTGNR/L	MTJNR/L	MVJNR/L	MVQNR/L	MVVNN	MWLNR/L
Approach angle	75°	45°	60°	90°	90°	93°	93°	117.5°	72.5°	95°
Page	B174	B175	B175	B175	B176	B176	B176	B177	B177	B177
Turning	●	●	●		●	●	●	●	●	●
Copying			●			●	●	●	●	
Facing		●		●		●				●
Chamfering										
Back turning						●	●	●		●



Screw on System

Cutting Shape										
Designation	SCACR/L	SCLCR/L	SDACR/L	SDJCR/L	SDNCN	SRDCN	SRGCR/L	SSBCR/L	SSDCN	SSKCR/L
Approach angle	90°	95°	90°	93°	62.5°	-	-	75°	45°	75°
Page	B178	B178	B178	B179	B179	B179	B180	B180	B180	B181
Turning	●	●	●	●	●	●	●	●	●	
Copying			●	●	●	●	●			
Facing		●								●
Chamfering										
Back turning		●		●						

Cutting Shape										
Designation	SSSCR/L	STACR/L	STFCR/L	STGCR/L	STTCR/L	SVABR/L	SVHBR/L	SVJBR/L	SVJCR/L	SVVBN
Approach angle	45°	90°	90°	90°	60°	90°	107.5°	93°	93°	72.5°
Page	B181	B181	B182	B182	B182	B183	B183	B183	B184	B184
Turning	●	●		●	●	●	●	●	●	●
Copying						●	●	●	●	●
Facing	●		●							
Chamfering										
Back turning						●	●	●	●	

Cutting Shape										
Designation	SVVCN									
Approach angle	72.5°									
Page	B184									
Turning	●									
Copying	●									
Facing										
Chamfering										
Back turning										

Ceramic Holder

Cutting Shape										
Designation	CCNLR/L	CRDNN	CRGNR/L	CSDNN	CSKNR/L	CTFNR/L	CTGNR/L			
Approach angle	95°	-	-	45°	75°	90°	90°			
Page	B185	B185	B185	B185	B186	B186	B186			
Turning	●	●	●	●			●			
Copying			●							
Facing	●				●	●				
Chamfering										
Back turning	●									

Instruction of External Holder

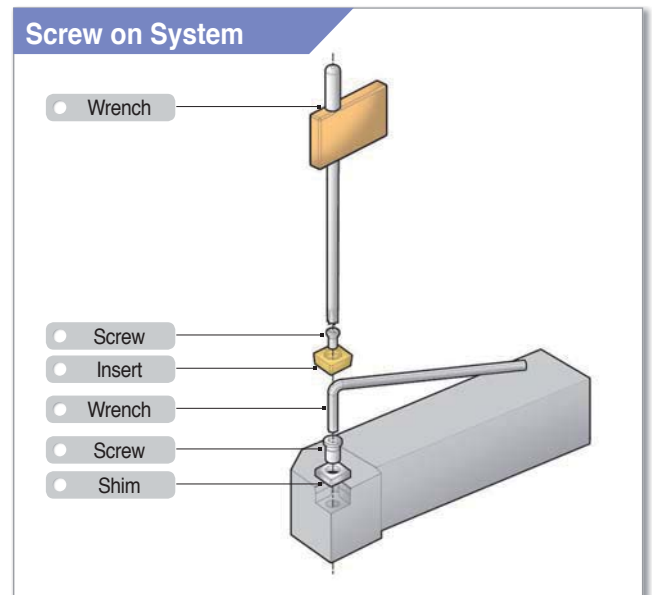
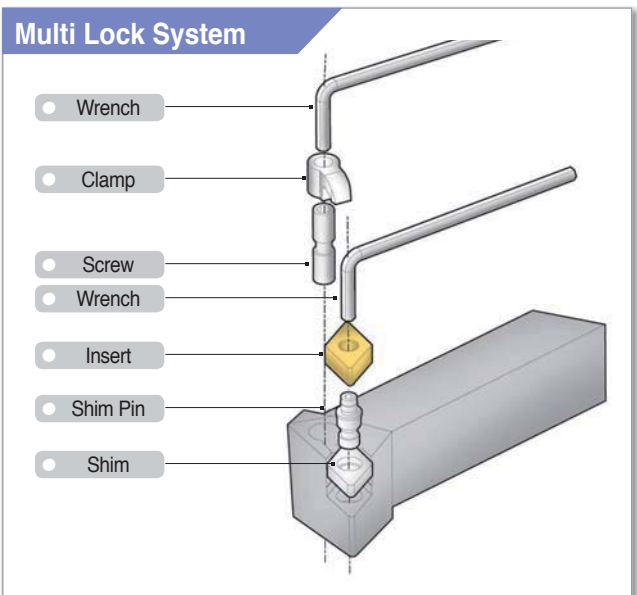
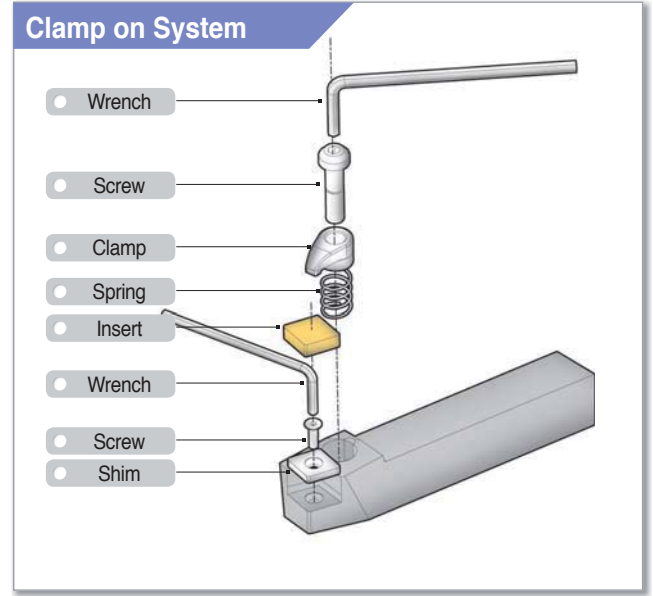
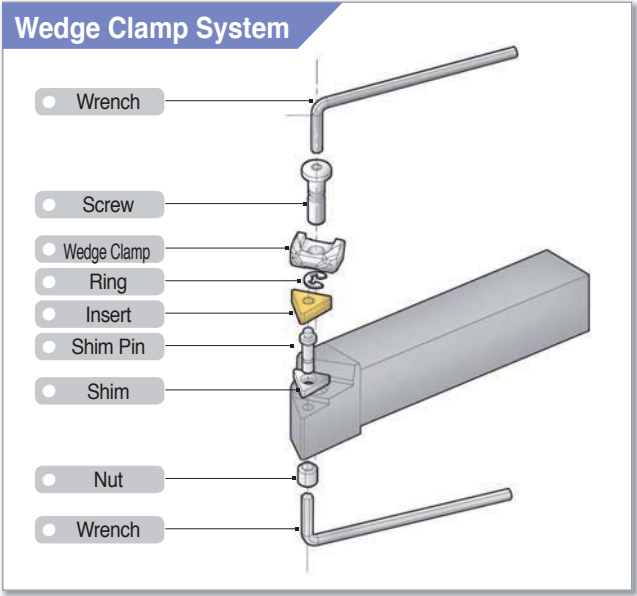
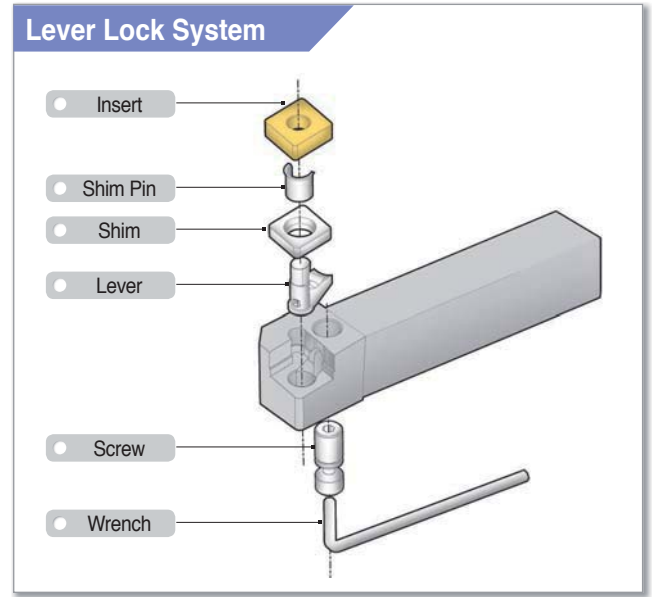
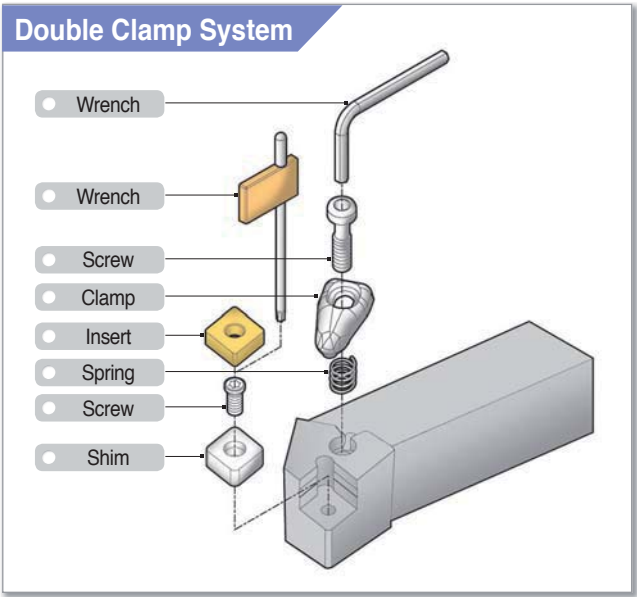

Double Clamp System

Stable clamping with double clamp system

- Features**
- Simple and powerful clamping system operated by only a single clamp screw
 - The powerful double-clamping system (upper and internal) is suitable for machining in very tough cutting conditions
 - The holder offers precision due to the special design in the rear of the clamp
 - Compact and optimized design for avoiding chip interference with a powerful clamp

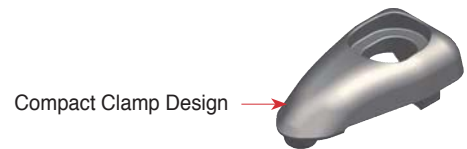
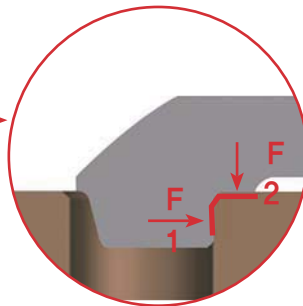
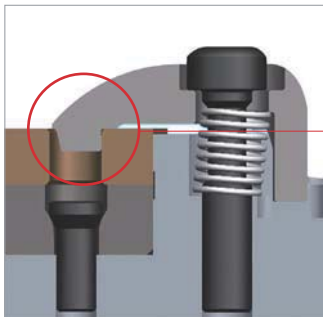
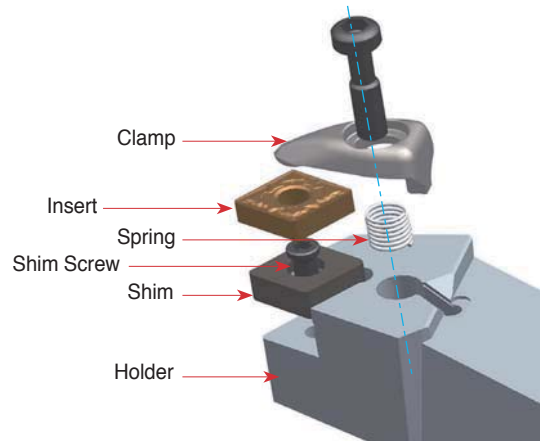

Lever Lock System

Excellent clamping stability and rigidity compared to existing lever-lock holders and boring bars

- Features**
- The holder offers precision due to the special design due to the improved Lever tip seat
 - The durability of parts has been improved
 - Superior tool life due to powerful clamping system and optimized design of part
 - Part designation on holder body makes it easy to check the right part description for each product
 - Adjustable coolant nozzle gives the option to change the direction of the coolant to optimize chip control and improve tool life

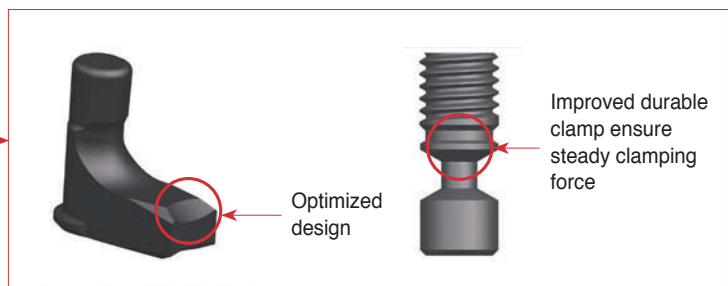
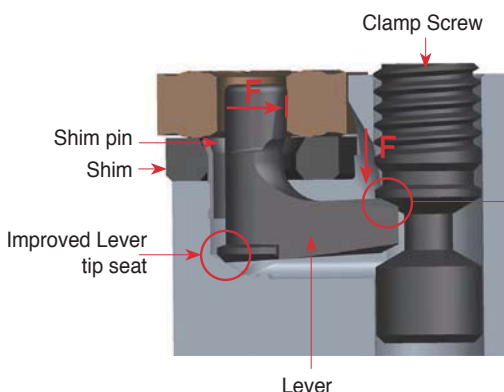
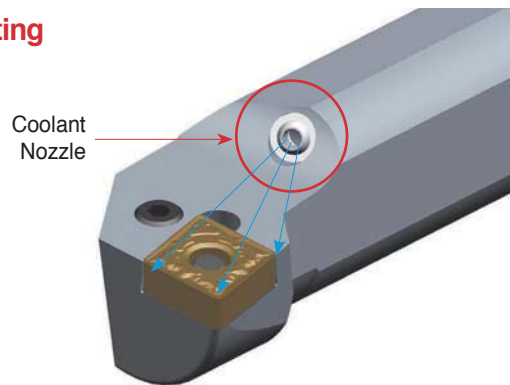

B Double Clamp System

DCBNR/L



CN□□

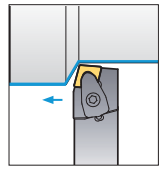
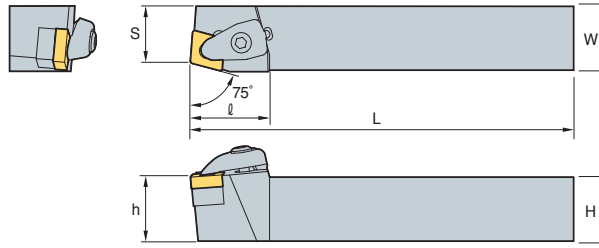

75°

• R type insert (mm)

Designation	Stock	H	W	L	S	h	ℓ	Insert	Clamp	Clamp Screw	Shim	Shim Screw	Spring	Wrench
DCBNR/L	2020-K12	20	20	125	17	20	31	CN□□1204□□						
	2525-M12	25	25	150	22	25	31							
	3225-P12	32	25	170	22	32	31							
	2525-M16	25	25	150	22	25	36	CN□□1606□□						
	3232-P16	32	32	170	27	32	36							
	3232-P19	32	32	170	27	32	40							
	4040-S19	40	40	250	35	40	40	CN□□1906□□						

➔ Applicable inserts B28~B35

DCKNR/L



CN□□

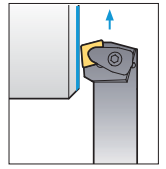
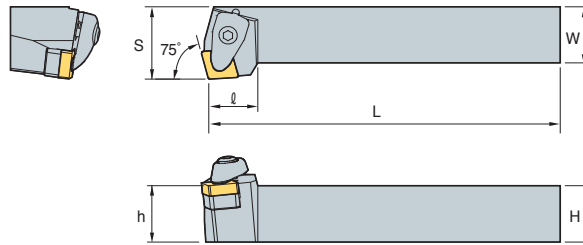

75°

• R type insert (mm)

Designation	H	W	L	S	h	ℓ	Insert	Clamp	Clamp Screw	Shim	Shim Screw	Spring	Wrench	
DCKNR/L	2020-K12	20	20	125	25	20	21	CN□□1204□□						
	2525-M12	25	25	150	32	25	21							
	3225-P12	32	25	170	32	32	21							
	3232-P16	32	32	170	40	32	26	CN□□1606□□						
	4040-S16	40	40	250	50	40	26							

➔ Applicable inserts B28~B35

DCLNR/L



CN□□

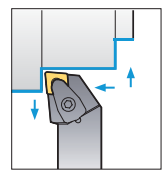
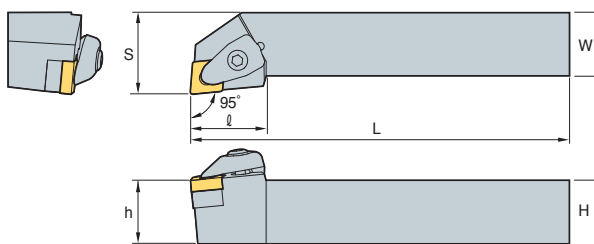

95°

• R type insert (mm)

Designation	H	W	L	S	h	ℓ	Insert	Clamp	Clamp Screw	Shim	Shim Screw	Spring	Wrench	
DCLNR/L	2020-K09	20	20	125	25	20	24.5	CN□□0903□□						
	2525-M09	25	25	150	32	25	24.5							
	2020-K12	20	20	125	25	20	30	CN□□1204□□						
	2525-M12	25	25	150	32	25	30							
	3225-P12	32	25	170	32	32	30							
	3232-P12	32	32	170	40	32	30	CN□□1606□□						
	2525-M16	25	25	150	32	25	36							
	3225-P16	32	25	170	32	32	36	CN□□1606□□						
	3232-P16	32	32	170	40	32	36							
	2525-M19	25	25	150	32	25	40							
	3225-P19	32	25	170	32	32	40	CN□□1906□□						
	3232-P19	32	32	170	40	32	40							
	4040-S19	40	40	250	50	40	40							

➔ Applicable inserts B28~B35



DDJNR/L

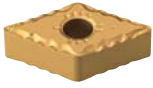

DN□□

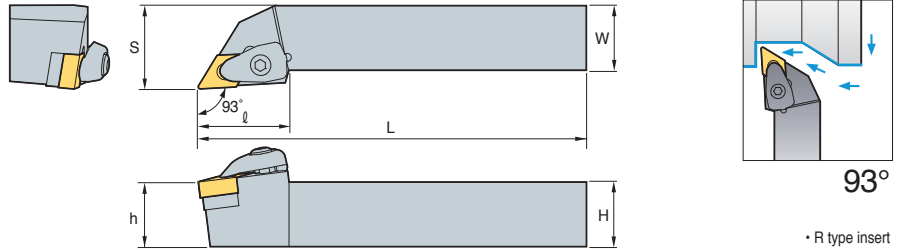

• R type insert (mm)

Designation	H	W	L	S	h	ℓ	Insert	Clamp	Clamp Screw	Shim	Shim Screw	Spring	Wrench
DDJNR/L 2020-K11	20	20	125	25	20	30	DN□□1104□□						
2525-M11	25	25	150	32	25	30							
3225-P11	32	25	170	32	32	30							
3232-P11	32	32	170	40	32	30							
2020-K15	20	20	125	25	20	35	DN□□1506□□						
2525-M15	25	25	150	32	25	35							
3225-P15	32	25	170	32	32	35							
3232-P15	32	32	170	40	32	35							
2020-K15-3	20	20	125	25	20	35	DN□□1504□□						
2525-M15-3	25	25	150	32	25	35							
3232-P15-3	32	32	170	40	32	35							

➔ Applicable inserts B36~B42

DSBNR/L



SN□□

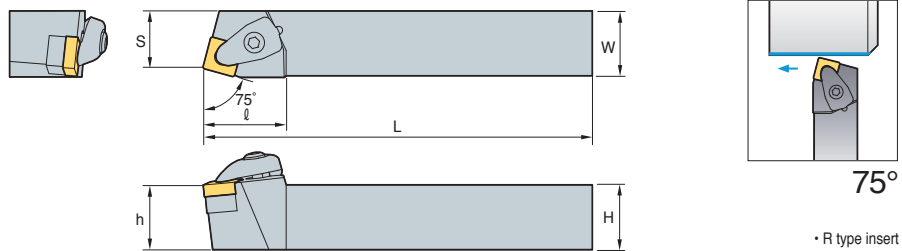

• R type insert (mm)

Designation	H	W	L	S	h	ℓ	Insert	Clamp	Clamp Screw	Shim	Shim Screw	Spring	Wrench
DSBNR/L 2020-K09	20	20	125	17	20	25	SN□□0903□□						
2525-M09	25	25	150	22	25	25							
2020-K12	20	20	125	17	20	32							
2525-M12	25	25	150	22	25	32	SN□□1204□□						
3225-P12	32	25	170	22	32	32							
3232-P12	32	32	170	27	32	32	SN□□1506□□						
2525-M15	25	25	150	22	25	38							
3225-P15	32	25	170	22	32	38							
3232-P15	32	32	170	27	32	38							
3232-P19	32	32	170	27	32	43	SN□□1906□□						
4040-S19	40	40	250	35	40	43							

➔ Applicable inserts B44~B52

B Double Clamp System

DSDNN



SN□□

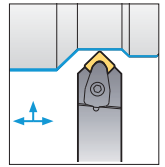
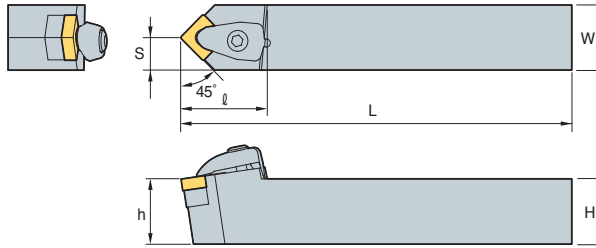

45°

• R type insert (mm)

Designation	H	W	L	S	h	ℓ	Insert	Clamp	Clamp Screw	Shim	Shim Screw	Spring	Wrench
DSDNN 2020-K09	20	20	125	10	20	26.5	SN□□0903□□	CVH3	CHX0415	SS32V	FTKA0307	SPR0510	HW25P
2020-K12	20	20	125	10	20	33	SN□□1204□□	CVH4	CHX0518	SS44V	FTKA0410	SPR0714	HW30P
2525-M12	25	25	150	12.5	25	33							
3225-P12	32	25	170	12.5	32	33							
3232-P12	32	32	170	16	32	33	SN□□1506□□	CVH5	CHX0622	SS54V	FTNA0511	SPR0811	HW25P
2525-M15	25	25	150	12.5	25	39.4							
3232-P15	32	32	170	16	32	38							
3232-P19	32	32	170	16	32	43	SN□□1906□□	CVH6	CHX0622	SS64V	FTNA0511	SPR0811	HW40L
4040-S19	40	40	250	20	40	45							

↻ Applicable inserts B44~B52

DSKNR/L

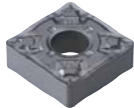

SN□□

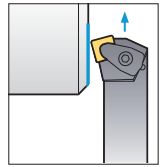
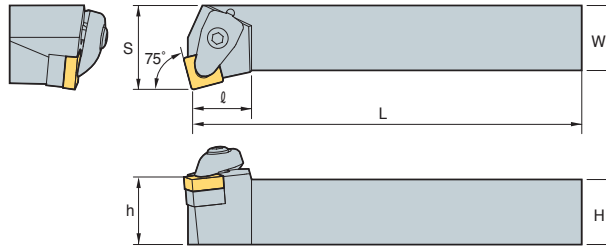

75°

• R type insert (mm)

Designation	H	W	L	S	h	ℓ	Insert	Clamp	Clamp Screw	Shim	Shim Screw	Spring	Wrench
DSKNR/L 2020-K09	20	20	125	25	20	20	SN□□0903□□	CVH3	CHX0415	SS32V	FTKA0307	SPR0510	HW25P
2020-K12	20	20	125	25	20	23	SN□□1204□□	CVH4	CHX0518	SS44V	FTKA0410	SPR0714	HW30P
2525-M12	25	25	150	32	25	23							
3232-P12	32	32	170	40	32	23							
3232-P15	32	32	170	40	32	28	SN□□1506□□	CVH5	CHX0622	SS54V	FTNA0511	SPR0811	HW40L
3232-P19	32	32	170	40	32	35	SN□□1906□□	CVH6	CHX0622	SC64V	FTNA0511	SPR0811	HW40L
4040-S19	40	40	250	50	40	43							

↻ Applicable inserts B44~B52

DSSNR/L



SN□□

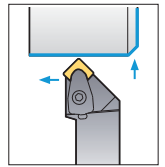
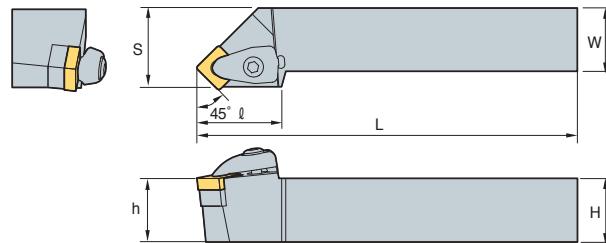

45°

• R type insert (mm)

Designation	H	W	L	S	h	ℓ	Insert	Clamp	Clamp Screw	Shim	Shim Screw	Spring	Wrench
DSSNR/L 2020-K09	20	20	125	25	20	28.5	SN□□0903□□	CVH3	CHX0415	SS32V	FTKA0307	SPR0510	HW25P
2020-K12	20	20	125	25	20	35	SN□□1204□□	CVH4	CHX0518	SS44V	FTKA0410	SPR0714	HW30P
2525-M12	25	25	150	32	25	35							
3225-P12	32	25	170	32	32	35							
3232-P12	32	32	170	40	32	35	SN□□1506□□	CVH5	CHX0622	SS54V	FTNA0511	SPR0811	HW40L
2525-M15	25	25	150	32	25	38.5							
3232-P15	32	32	170	40	32	38.5							
3232-P19	32	32	170	40	32	46	SN□□1906□□	CVH6	CHX0622	SS64V	FTNA0511	SPR0811	HW40L
4040-S19	40	40	250	50	40	46							

↻ Applicable inserts B44~B52



DTFNR/L



TN□□

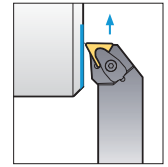
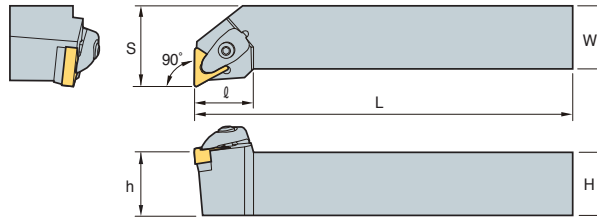

90°

• R type insert
(mm)

Designation	H	W	L	S	h	ℓ	Insert	Clamp	Clamp Screw	Shim	Shim Screw	Spring	Wrench
DTFNR/L 2020-K16	20	20	125	25	20	24.5	TN□□1604□□						
	25	25	150	32	25	24.5							
	32	32	170	40	32	23.5							
DTFNR/L 2525-M22	25	25	150	32	25	33	TN□□2204□□						
DTFNR/L 3225-P22	32	25	170	32	32	33							
DTFNR/L 3232-P22	32	32	170	40	32	33							

➔ Applicable inserts B53~B59

DTGNR/L



TN□□

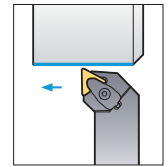
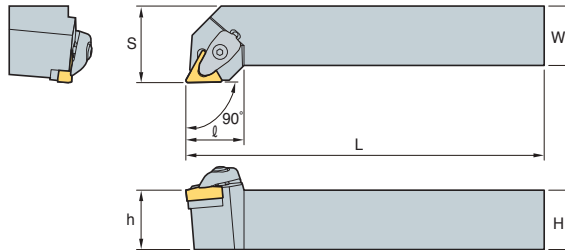

90°

• R type insert
(mm)

Designation	H	W	L	S	h	ℓ	Insert	Clamp	Clamp Screw	Shim	Shim Screw	Spring	Wrench
DTGNR/L 2020-K16	20	20	125	25	20	24.5	TN□□1604□□						
	25	25	150	32	25	24.5							
	32	32	170	40	32	24.5							
DTGNR/L 2525-M22	25	25	150	32	25	32.6	TN□□2204□□						
DTGNR/L 3225-P22	32	25	170	32	32	32.6							
DTGNR/L 3232-P22	32	32	170	40	32	32.6							

➔ Applicable inserts B53~B59

DVJNR/L



VN□□

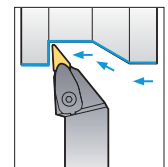
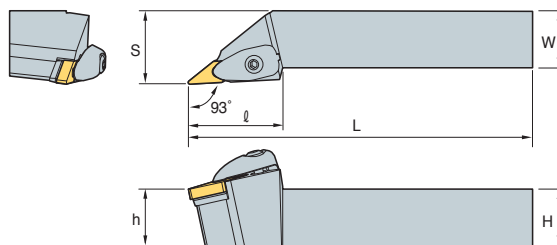

93°

• R type insert
(mm)

Designation	H	W	L	S	h	ℓ	Insert	Clamp	Clamp Screw	Shim	Shim Screw	Spring	Wrench
DVJNR/L 2020-K16	20	20	125	25	20	41.5	VN□□1604□□						
	25	25	150	32	25	41.5							
	32	32	170	40	32	41.5							

➔ Applicable inserts B60~B61

B Double Clamp System

DVVNN



VN□□

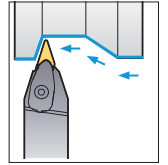
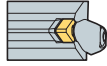

72.5°

· R type insert (mm)

Designation		H	W	L	S	h	l	Insert	Clamp	Clamp Screw	Shim	Shim Screw	Spring	Wrench
DVVNN	2020-K16	20	20	125	10	20	40	VN□□1604□□						
	2525-M16	25	25	150	12.5	25	40							
	3232-P16	32	32	170	16	32	40							
									CVH3V	CHX0518	SV32V	FTNA03508	SPR0714	HW30P

↻ Applicable inserts B60~B61

DWLNRL



WN□□

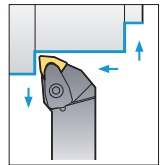
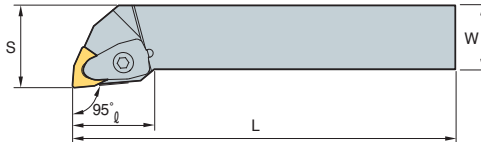
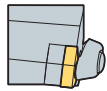

95°

· R type insert (mm)

Designation		H	W	L	S	h	l	Insert	Clamp	Clamp Screw	Shim	Shim Screw	Spring	Wrench
DWLNRL	2020-K06	20	20	125	25	20	26	WN□□0604□□						
	2525-M06	25	25	150	32	25	26							
	2020-K08	20	20	125	25	20	32							
									CVH4	CHX0518	SW44V	FTKA0410	SPR0714	HW30P

↻ Applicable inserts B62~B65



PCBNR/L

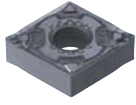

CN□□

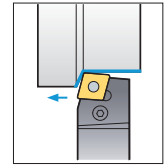
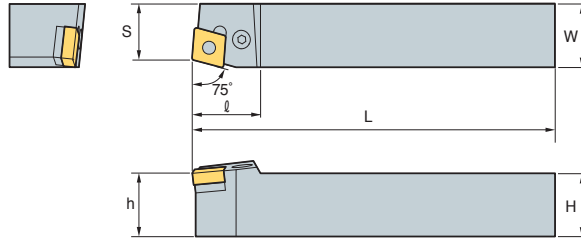

75°

• R type insert (mm)

Designation	H	W	L	S	h	ℓ	Insert	Lever	Screw	Shim	Shim Pin	Wrench	Shim Pin Punch	
PCBNR/L	2020-K12	20	20	125	17	20	CN□□ 1204□□	LV4	VHX0821	SC42	SP4	HW30L	LSPS4	
	2525-M12	25	25	150	22	25								27
	3225-P12	32	25	170	22	32	27	CN□□ 1606□□	LV5	VHX0825	SC53	SP5	HW30L	LSPS6
	2525-M16	25	25	150	22	25	33							
	3232-P16	32	32	170	27	32	33	CN□□ 1906□□	LV6N	VHX1027N	SC63N	SP6N	HW40L	LSPS6
	3232-P19	32	32	170	27	32	36							
	4040-S19	40	40	250	35	40	36	CN□□ 2509□□	LV8N	VHX1236N	SC84N	SP8N	HW50L	LSPS8
	4040-S25	40	40	250	35	40	47							
4040-S25-5	40	40	250	35	40	47	CN□□ 2507□□	LV8N	VHX1236N	SC84N	SP8N	HW50L	LSPS8	
5050-T25	50	50	300	43	50	47	CN□□ 2509□□							
PCBNR/L	2020-K12N	20	20	125	17	20	CN□□ 1204□□	LV4N	VHX0820N	SC42N	SP4N	HW30L	LSPS4	
	2525-M12N	25	25	150	22	25								27
	3225-P12N	32	25	170	22	32	27	CN□□ 1606□□	LV6N	VHX1027N	SC63N	SP6N	HW40L	LSPS8
	2525-M16N	25	25	150	22	25	33							
	3232-P16N	32	32	170	27	32	33	CN□□ 1906□□	LV6N	VHX1027N	SC63N	SP6N	HW40L	LSPS8
	3232-P19N	32	32	170	27	32	36							

↻ Applicable inserts B28~B35

PCKNR/L



CN□□

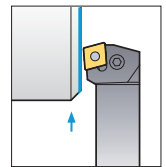
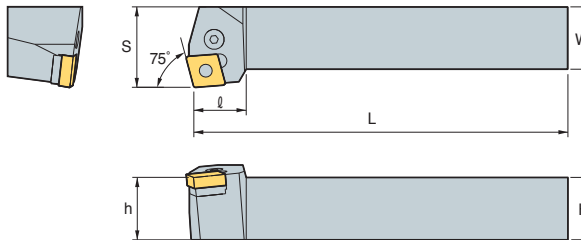

95°

• R type insert (mm)

Designation	H	W	L	S	h	ℓ	Insert	Lever	Screw	Shim	Shim Pin	Wrench	Shim Pin Punch	
PCKNR/L	2020-K12	20	20	125	25	20	CN□□ 1204□□	LV4	VHX0821	SC42	SP4	HW30L	LSPS4	
	2525-M12	25	25	150	32	25								27
	3225-P12	32	25	170	40	32	30	CN□□ 1606□□	LV5	VHX0825	SC53	SP5	HW30L	HW30L
	3232-P16	32	32	170	40	32	26							
4040-S16	40	40	250	50	40	25								
PCKNR/L	2020-K12N	20	20	125	25	20	CN□□ 1204□□	LV4N	VHX0820N	SC42N	SP4N	HW30L	LSPS4	
	2525-M12N	25	25	150	32	25								27
	3225-P12N	32	25	170	40	32	30	CN□□ 1606□□	LV5N	VHX0820AN	SC53N	SP5N	HW30L	LSPS5
	3232-P16N	32	32	170	40	32	26							

↻ Applicable inserts B28~B35



- Improved holders and parts ensure performance and durability
- “N” stand for New type (Holders and parts)



B Lever Lock System

PCLNR/L

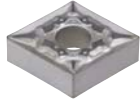

CN□□

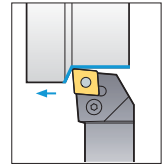
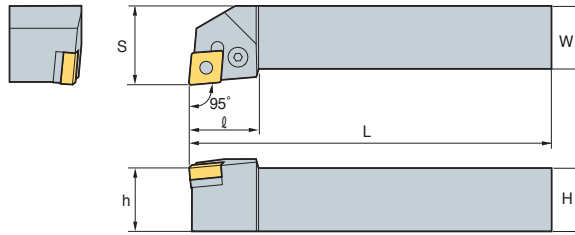

95°

• R type insert (mm)

Designation	H	W	L	S	h	l	Insert	Lever	Screw	Shim	Shim Pin	Wrench	Shim Pin Punch	
PCLNR/L	1616-H09	16	16	100	20	16	20	CN□□ 0903□□	LV3	VHX0617	SC32	SP3	HW25L	LSPS3
	2020-K09	20	20	125	25	20	22							
	2525-M09	25	25	150	32	25	22							
	1616-H12	16	16	100	20	16	28	CN□□ 1204□□	LV4	VHX0821	SC42	SP4	HW30L	LSPS4
	2020-K12	20	20	125	25	20	28							
	2525-M12	25	25	150	32	25	28							
	3225-P12	32	25	170	32	32	28							
	3232-P12	32	32	170	40	32	28							
	2525-M16	25	25	150	32	25	33	CN□□ 1606□□	LV5	VHX0825	SC53	SP5	HW30L	LSPS5
	3232-P16	32	32	170	40	32	33							
	2525-M19	25	25	150	32	25	36	CN□□ 1906□□	LV6N	VHX1027N	SC63N	SP6N	HW40L	LSPS6
	3225-P19	32	25	170	32	32	36							
	3232-P19	32	32	170	40	32	36							
	4040-P19	40	40	170	50	40	36							
	4040-S19	40	40	250	50	40	36							
4040-S25	40	40	250	50	40	47	CN□□ 2509□□	LV8N	VHX1236N	SC84N	SP8N	HW50L	LSPS8	
5050-T25	50	50	300	60	50	47								
4040-S25-5	40	40	250	50	40	47	CN□□ 2507□□	LV8N	VHX1236N	SC84N	SP8N	HW50L	LSPS8	
5050-S25-5	50	50	300	60	50	47								
PCLNR/L	1616-H09N	16	16	100	20	16	20	CN□□ 0903□□	LV3N	VHX0617N	SC32N	SP3	HW25L	LSPS3
	2020-K09N	20	20	125	25	20	22							
	2525-M09N	25	25	150	32	25	22							
	1616-H12N	16	16	100	20	16	28	CN□□ 1204□□	LV4N	VHX0817N VHX0820N	SC42N	SP4N	HW30L	LSPS4
	2020-K12N	20	20	125	25	20	28							
	2525-M12N	25	25	150	32	25	28							
	3225-P12N	32	25	170	32	32	28							
	3232-P12N	32	32	170	40	32	28							
	2525-M16N	25	25	150	32	25	33	CN□□ 1606□□	LV5N	VHX0820AN	SC53N	SP5N	HW30L	LSPS5
	3232-P16N	32	32	170	40	32	33							
	2525-M19N	25	25	150	32	25	38	CN□□ 1906□□	LV6N	VHX1027N	SC63N	SP6N	HW40L	LSPS6
	4040-S19N	40	40	250	50	40	36							

➔ Applicable inserts B28~B35

PDJNR/L



DN□□

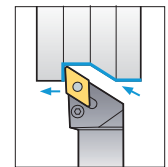
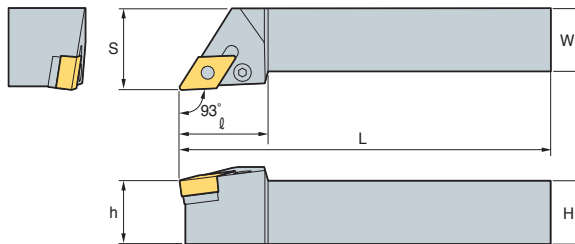

93°

• R type insert (mm)

Designation	H	W	L	S	h	l	Insert	Lever	Screw	Shim	Shim Pin	Wrench	Shim Pin Punch	
PDJNR/L	1616-H11	16	16	100	20	16	25	DN□□ 1104□□	LV3	VHX0617	SD317	SP3	HW25L	LSPS3
	2020-K11	20	20	125	25	20	25							
	2525-M11	25	25	150	32	25	30							
	2020-K15	20	20	125	25	20	35	DN□□ 1506□□	LV4B	VHX0821	SD42	SP4	HW30L	LSPS4
	2525-M15	25	25	150	32	25	35							
	3225-P15	32	25	170	32	32	35							
	3232-P15	32	32	170	40	32	35							
	2020-K15-3	20	20	125	25	20	35							
	2525-M15-3	25	25	150	32	25	35	DN□□ 1504□□	LV4	VHX0821	SD42	SP4	HW30L	LSPS4
	3232-P15-3	32	32	170	40	32	35							

➔ Applicable inserts B36~B42



B

Turning

PDJNR/L



DN□□

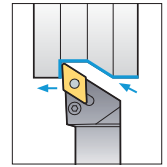
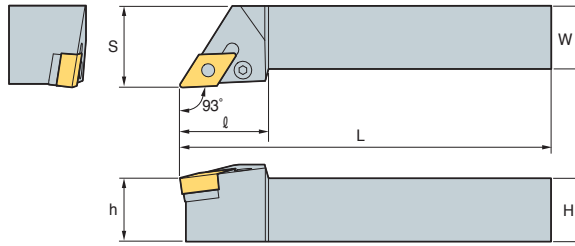

93°

• R type insert (mm)

Designation	H	W	L	S	h	l	Insert	Lever	Screw	Shim	Shim Pin	Wrench	Shim Pin Punch							
PDJNR/L	1616-H11N	16	16	100	20	16	DN□□ 1104□□													
	2020-K11N	20	20	125	25	20								LV3AN	VHX0617N	SD32N	SP3	HW25L	LSPS3	
	2525-M11N	25	25	150	32	25								30						
PDJNR/L	2020-K15N	20	20	125	25	20	DN□□ 1506□□													
	2525-M15N	25	25	150	32	25								35	LV4BN	VHX0821N	SD42N	SP4N	HW30L	LSPS4
	3225-P15N	32	25	170	32	32								35						
	3232-P15N	32	32	170	40	32								35						
PDJNR/L	2020-K15-3N	20	20	125	25	20	DN□□ 1504□□													
	2525-M15-3N	25	25	150	32	25								35	LV4BN	VHX0821N	SD43N	SP4N	HW30L	LSPS4
	3232-P15-3N	32	32	170	40	32								35						

↻ Applicable inserts B36~B42

PDNNR/L

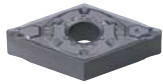

DN□□

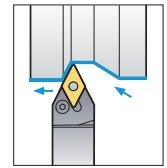
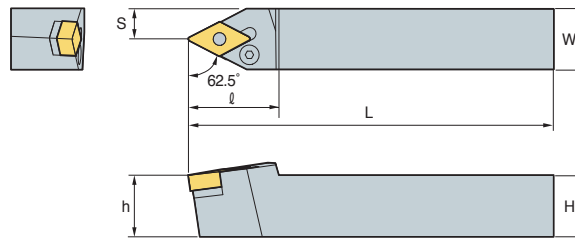

62.5°

• R type insert (mm)

Designation	H	W	L	S	h	l	Insert	Lever	Screw	Shim	Shim Pin	Wrench	Shim Pin Punch							
PDNNR/L	2020-K15	20	20	125	8	20	DN□□ 1506□□													
	2525-M15	25	25	150	12.5	25								37	LV4B	VHX0821	SD42	SP4	HW30L	LSPS4
	3232-P15	32	32	150	16	32								37						
	4025-M15	40	25	170	12.5	32	37	DN□□ 1504□□												
	2525-M15-3	25	25	150	12.5	25	37								LV4	VHX0821	SD42	SP4	HW30L	LSPS4
	4025-M15-3	40	25	150	12.5	25	37													
PDNNR/L	2020-K15N	20	20	125	8	20	DN□□ 1506□□													
	2525-M15N	25	25	150	12.5	25								37	LV4BN	VHX0821N	SD42N	SP4N	HW30L	LSPS4
	3232-P15N	32	32	170	16	32								37						
	2525-M15-3N	25	25	150	12.5	25	37	DN□□ 1504□□												
	3232-P15-3N	32	32	170	16	32	37								LV4BN	VHX0821N	SD43N	SP4N	HW30L	LSPS4

↻ Applicable inserts B36~B42

B Lever Lock System

PRDCN



RCMX

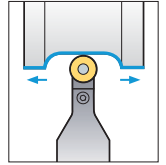
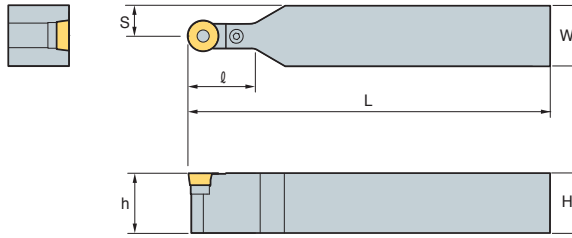

(mm)

Designation	H	W	L	S	h	l	Insert	Lever	Screw	Shim	Shim Pin	Wrench	Shim Pin Punch
PRDCN 2020-M10	20	20	150	10	20	24	RCMX 1003M0	LR10	VHX0514	SR10	SP3	HW20L	LSPS3
	25	25	150	12.5	25	24							
2525-M12	25	25	150	12.5	25	24	RCMX 1204M0	LR12	VHX0617	SR12	SP3	HW25L	LSPS3
2020-K12	20	20	125	10	20	24							
3225-Q12	32	25	180	12.5	32	24	RCMX 1606M0	LR16	VHX0621	SR16	SP4	HW25L	LSPS4
2525-Q16	25	25	180	12.5	25	30							
3225-Q16	32	25	180	12.5	32	30	RCMX 2006M0	LR20	VHX0823	SR20	SP20	HW30L	LSPS5
3232-Q16	32	32	180	16	32	35							
3232-Q20	32	32	180	16	32	40	RCMX 2507M0	LR25	VHX1030	SR25	SP6N	HW40L	LSPS6
4040-S25	40	40	250	20	40	42							
4040-T25	40	40	300	20	40	42	RCMX 3209M0	LR32	VHX1236	SR32	SP8N	HW50L	LSPS8
5050-U32	50	50	350	25	50	52							

Applicable inserts B74

PRGCR/L



RCMX

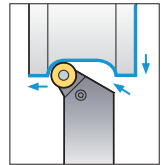
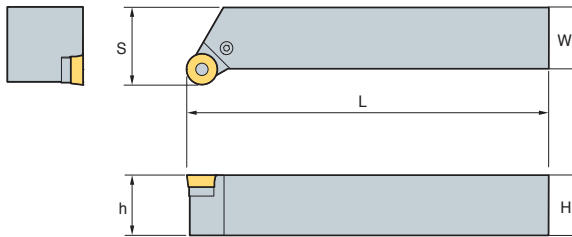

• R type insert
(mm)

Designation	H	W	L	S	h	Insert	Lever	Screw	Shim	Shim Pin	Wrench	Shim Pin Punch
PRGCR/L 2020-K10	20	20	125	25	20	RCMX 1003M0	LR10	VHX0514	SR10	SP3	HW20L	LSPS3
	25	25	150	32	25							
2020-K12	20	20	125	25	20	RCMX 1204M0	LR12	VHX0617	SR12	SP3	HW25L	LSPS3
2525-M12	25	25	150	32	25							
3225-P12	32	25	170	32	32	RCMX 1606M0	LR16	VHX0621	SR16	SP4	HW25L	LSPS4
2525-M16	25	25	150	32	25							
3225-P16	32	25	170	32	32	RCMX 2006M0	LR20	VHX0823	SR20	SP5-1	HW30L	LSPS5
3232-P20	32	32	170	40	32							
4040-S25	40	40	250	50	40	RCMX 2507M0	LR25	VHX1030	SR25	SP6N	HW40L	LSPS6

Applicable inserts B74



PSBNR/L

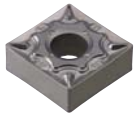

SN□□

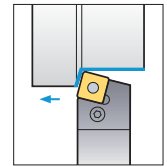
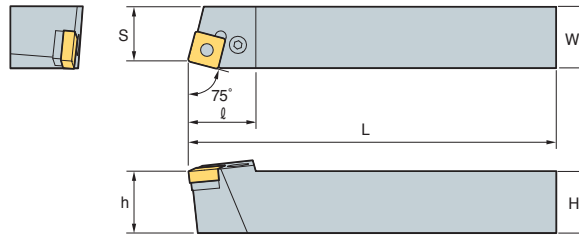

75°

• R type insert
(mm)

Designation	H	W	L	S	h	ℓ	Insert	Lever	Screw	Shim	Shim Pin	Wrench	Shim Pin Punch	
PSBNR/L	1616-H09	16	16	100	13	16	21	SN□□ 0903□□	LV3	VHX0617	SS32	SP3	HW25L	LSPS3
	2020-K09	20	20	125	17	20	23	SN□□ 1204□□	LV4	VHX0821	SS42	SP4	HW30L	LSPS4
	2020-K12	20	20	125	17	20	28							
	2525-M12	25	25	150	22	25	28							
	3225-P12	32	25	170	22	32	28							
	3232-P12	32	32	170	27	32	28	SN□□ 1506□□	LV5	VHX0825	SS53	SP5	HW30L	LSPS5
	2525-M15	25	25	150	22	25	35							
	3232-P15	32	32	170	27	32	35	SN□□ 1906□□	LV6N	VHX1027N	SS63N	SP6N	HW40L	LSPS6
	3232-P19	32	32	170	27	32	40							
	4040-S19	40	40	250	35	40	40	SN□□ 2507□□	LV8N	VHX1236N	SS84N	SP8N	HW50L	LSPS8
4040-S25	40	40	250	35	40	50								
4040-S25-6	40	40	250	35	40	50	SN□□ 2509□□	LV8N	VHX1236N	SS84N	SP8N	HW50L	LSPS8	
5050-T25	50	50	300	43	50	50	SN□□ 2507□□							
5050-T25-6	50	50	300	43	50	46	SN□□ 2509□□							
PSBNR/L	1616-H09N	16	16	100	13	16	21	SN□□ 0903□□	LV3N	VHX0617N	SS32N	SP3	HW25L	LSPS3
	2020-K09N	20	20	125	17	20	23	SN□□ 1204□□	LV4N	VHX0820N	SS42N	SP4N	HW30L	LSPS4
	2020-K12N	20	20	125	17	20	28							
	2525-M12N	25	25	150	22	25	28							
	3225-P12N	32	25	150	22	25	28							
	3232-P12N	32	32	170	27	32	28	SN□□ 1506□□	LV5N	VHX0820AN	SS53N	SP5N	HW30L	LSPS5
	2525-M15N	25	25	150	22	25	35							

↻ Applicable inserts B44~B52

PSDNN



SN□□

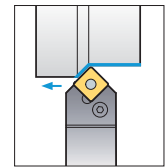
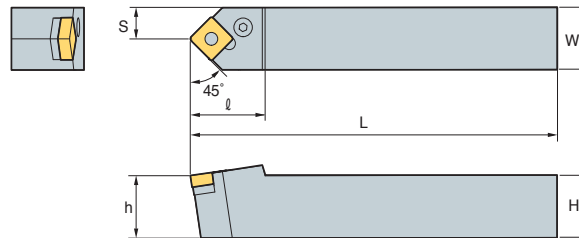

45°

(mm)

Designation	H	W	L	S	h	ℓ	Insert	Lever	Screw	Shim	Shim Pin	Wrench	Shim Pin Punch	
PSDNN	1616-H09	16	16	100	8	16	23	SN□□ 0903□□	LV3	VHX0617	SS32	SP3	HW25L	LSPS3
	2020-K12	20	20	125	10	20	30	SN□□ 1204□□	LV4	VHX0821	SS42	SP4	HW30L	LSPS4
	2525-M12	25	25	150	12.5	25	30							
	3225-P12	32	25	170	12.5	32	30							
	3232-P12	32	32	170	16	32	40							
	2525-M15	25	25	150	12.5	25	40	SN□□ 1506□□	LV5	VHX0825	SS53	SP5	HW30L	LSPS5
	3232-P15	32	32	170	16	32	40							
	3225-P19	32	25	170	12.5	32	40	SN□□ 1906□□	LV6N	VHX1027N	SS63N	SP6N	HW40L	LSPS6
	3232-P19	32	32	170	16	32	40							
	4040-S19	40	40	250	20	40	40	SN□□ 2507□□	LV8N	VHX1236N	SS84N	SP8N	HW50L	LSPS8
	4040-S25	40	40	250	20	40	50							
	5050-T25	50	50	300	25	50	50	SN□□ 2509□□	LV8N	VHX1236N	SS84N	SP8N	HW50L	LSPS8
	4040-S25-6	40	40	250	20	40	50							
4040-S25-6	40	40	250	20	40	50	SN□□ 2509□□	LV8N	VHX1236N	SS84N	SP8N	HW50L	LSPS8	
5050-T25-6	50	50	300	25	50	50								
5050-T25-6	50	50	300	25	50	50								
PSDNN	1616-H09N	16	16	100	8	16	23	SN□□ 0903□□	LV3N	VHX0617N	SS32N	SP3	HW25L	LSPS3
	2020-K12N	20	20	125	10	20	30	SN□□ 1204□□	LV4N	VHX0820N	SS42N	SP4N	HW30L	LSPS4
	2525-M12N	25	25	150	12.5	20	30							
	3225-P12N	32	25	170	12.5	32	30							
	3232-P12N	32	32	170	16	32	40							
	2525-M15N	25	25	150	12.5	25	40	SN□□ 1506□□	LV5N	VHX0820AN	SS53N	SP5N	HW30L	LSPS5
	3232-P15N	32	32	170	16	32	40							

↻ Applicable inserts B44~B52

B Lever Lock System

PSKNR/L



SN□□

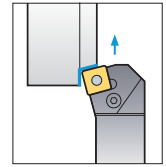
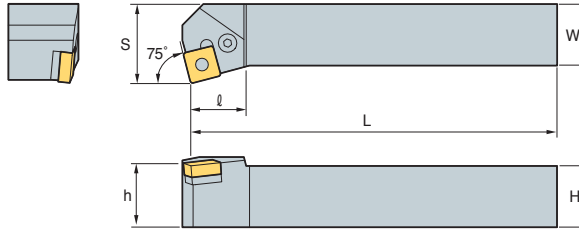

75°

• R type insert (mm)

Designation	H	W	L	S	h	ℓ	Insert	Lever	Screw	Shim	Shim Pin	Wrench	Shim Pin Punch	
PSKNR/L	1616-H09	16	16	100	20	16	17	SN□□ 0903□□	LV3	VHX0617	SS32	SP3	HW25L	LSPS3
	2020-K09	20	20	125	25	20	20							
	2020-K12	20	20	125	25	20	23							
	2525-M12	25	25	150	32	25	23	SN□□ 1204□□	LV4	VHX0821	SS42	SP4	HW30L	LSPS4
	3232-P12	32	32	170	40	32	23							
	2525-M15	25	25	150	32	25	28	SN□□ 1506□□	LV5	VHX0825	SS53	SP5	HW30L	LSPS5
	3232-P15	32	32	170	40	32	28							
	3232-P19	32	32	170	40	32	41.5	SN□□ 1906□□	LV6N	VHX1027N	SS63N	SP6N	HW40L	LSPS6
	4040-S19	40	40	250	50	40	41.5							
	4040-S25	40	40	250	50	40	46	SN□□ 2507□□	LV8N	VHX1236N	SS84N	SP8N	HW50L	LSPS8
4040-S25-6	40	40	250	50	40	46	SN□□ 2509□□	LV8N	VHX1236N	SS84N	SP8N	HW50L	LSPS8	
5050-T25-6	50	50	300	60	50	37.5	SN□□ 2509□□	LV8N	VHX1236N	SS84N	SP8N	HW50L	LSPS8	
PSKNR/L	1616-H09N	16	16	100	20	16	17	SN□□ 0903□□	LV3N	VHX0617N	SS32N	SP3	HW25L	LSPS3
	2020-K09N	20	20	125	25	20	20							
	2020-K12N	20	20	125	25	20	26							
	2525-M12N	25	25	150	32	25	26	SN□□ 1204□□	LV4N	VHX0820N	SS42N	SP4N	HW30L	LSPS4
	3232-P12N	32	32	170	40	32	26							
	2525-M15N	25	25	150	32	25	32	SN□□ 1506□□	LV5N	VHX0820AN	SS53N	SP5N	HW30L	LSPS5
	3232-P15N	32	32	170	40	32	32							

↻ Applicable inserts B44~B52

PSSNR/L



SN□□

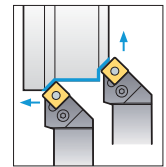
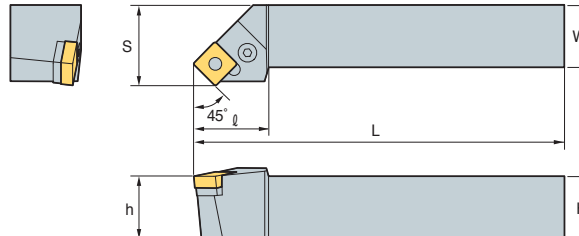

45°

• R type insert (mm)

Designation	H	W	L	S	h	ℓ	Insert	Lever	Screw	Shim	Shim Pin	Wrench	Shim Pin Punch	
PSSNR/L	1616-H09	16	16	100	20	16	25	SN□□ 0903□□	LV3	VHX0617	SS32	SP3	HW25L	LSPS3
	2020-K12	20	20	125	25	20	30							
	2525-M12	25	25	150	32	25	36							
	3225-P12	32	25	170	32	32	36	SN□□ 1204□□	LV4	VHX0821	SS42	SP4	HW30L	LSPS4
	3232-P12	32	32	170	40	32	40							
	2525-M15	25	25	150	32	25	36	SN□□ 1506□□	LV5	VHX0825	SS53	SP5	HW30L	LSPS5
	3232-P15	32	32	170	40	32	45							
	3232-P19	32	32	170	40	32	41.5	SN□□ 1906□□	LV6N	VHX1027N	SS63N	SP6N	HW40L	LSPS6
	4040-R19	40	40	200	50	40	41.5							
	4040-S19	40	40	250	50	40	41.5	SN□□ 2507□□	LV8N	VHX1236N	SS84N	SP8N	HW50L	LSPS8
4040-S25	40	40	250	50	40	48	SN□□ 2509□□	LV8N	VHX1236N	SS84N	SP8N	HW50L	LSPS8	
4040-S25-6	40	40	250	50	40	48	SN□□ 2509□□	LV8N	VHX1236N	SS84N	SP8N	HW50L	LSPS8	
PSSNR/L	1616-H09N	16	16	100	20	16	25	SN□□ 0903□□	LV3N	VHX0617N	SS32N	SP3	HW25L	LSPS3
	2020-K12N	20	20	125	25	20	30							
	2525-M12N	25	25	150	32	25	36							
	3225-P12N	32	25	170	32	32	45	SN□□ 1204□□	LV4N	VHX0821N	SS42N	SP4N	HW30L	LSPS4
	3232-P12N	32	32	170	40	32	40							
	2525-M15N	25	25	150	32	25	36	SN□□ 1506□□	LV5N	VHX08209N	SS53N	SP5N	HW30L	LSPS5
	3232-P15N	32	32	170	40	32	45							

↻ Applicable inserts B44~B52



PTFNR/L



TN□□

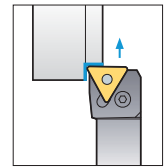
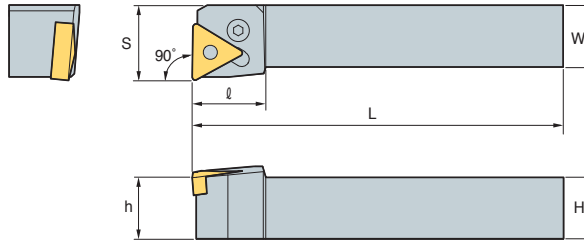

90°

• R type insert (mm)

Designation	H	W	L	S	h	ℓ	Insert	Lever	Screw	Shim	Shim Pin	Wrench	Shim Pin Punch	
PTFNR/L	1616-H16	16	16	100	20	16	TN□□1604□□	LV3	VHX0617	ST317	SP3	HW25L	LSPS3	
	2020-K16	20	20	125	25	20								20
	2525-M16	25	25	150	32	25								20
	2525-M22	25	25	150	32	25	25	TN□□2204□□	LV4	VHX0821	ST42	SP4	HW30L	LSPS4
	3232-P22	32	32	170	40	32	25							
	3232-P27	32	32	170	40	32	34							
4040-S27	40	40	250	50	40	34	TN□□2706□□	LV5	VHX0825	ST53	SP5	HW30L	LSPS5	
PTFNR/L	2525-M22N	25	25	150	32	25	TN□□2204□□	LV4N	VHX0820N	ST42N	SP4N	HW30L	LSPS4	
	3232-P22N	32	32	170	40	32	25	TN□□2706□□	LV5AN	VHX0823N	ST53N	SP5N	HW30L	LSPS5
	3232-P27N	32	32	170	40	32	34							
	4040-S27N	40	40	250	50	40	34							

↻ Applicable inserts B53~B59

PTGNR/L



TN□□

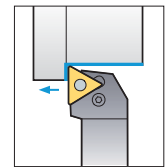
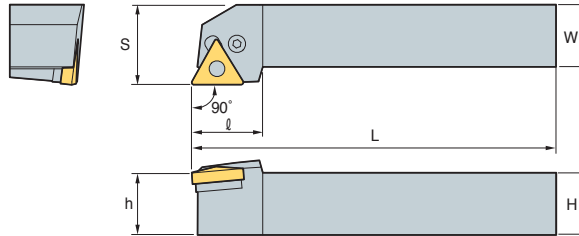

90°

• R type insert (mm)

Designation	H	W	L	S	h	ℓ	Insert	Lever	Screw	Shim	Shim Pin	Wrench	Shim Pin Punch	
PTGNR/L	1212-F11	12	12	80	16	12	TN□□1103□□	LV2	VHX0509B	-	-	HW20L	-	
	1616-H11	16	16	100	20	16								18
	2020-K11	20	20	125	25	20								19
	2525-M11	25	25	150	32	25	20	TN□□1604□□	LV3	VHX0617	ST317	SP3	HW25L	LSPS3
	1616-H16	16	16	100	20	16	20							
	2020-K16	20	20	125	25	20	20							
	2525-M16	25	25	150	32	25	20							
	3232-P16	32	32	170	40	32	20							
	2525-M22	25	25	150	32	25	28							
	3232-P22	32	32	170	40	32	28	TN□□2706□□	LV5	VHX0825	ST53	SP5	HW30L	LSPS5
3232-P27	32	32	170	40	32	33								
4040-S27	40	40	250	50	40	33								
PTGNR/L	2525-M22N	25	25	150	32	25	TN□□2204□□	LV4N	VHX0820N	ST42N	SP4N	HW30L	LSPS4	
	3232-P22N	32	32	170	40	32	28	TN□□2706□□	LV5AN	VHX0823N	ST53N	SP5N	HW30L	LSPS5
	3232-P27N	32	32	170	40	32	33							
	4040-S27N	40	40	250	50	40	33							

↻ Applicable inserts B53~B59



B Lever Lock System

PTTNR/L



TN□□

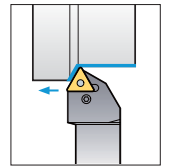
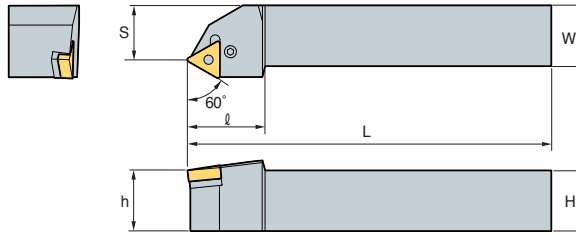

60°

• R type insert (mm)

Designation	H	W	L	S	h	ℓ	Insert	Lever	Screw	Shim	Shim Pin	Wrench	Shim Pin Punch						
PTTNR/L	1616-H16	16	16	100	13	16	TN□□1604□□												
	2020-K16	20	20	125	17	20								LV3	VHX0617	ST317	SP3	HW25L	LSPS3
	2525-M16	25	25	150	22	25								32	LV4	VHX0821	ST42	SP4	HW30L
PTTNR/L	2525-M22N	25	25	150	22	25	32	TN□□2204□□	LV4N	VHX0820N	ST42N	SP4N	HW30L	LSPS4					

Applicable inserts B53~B59

PWLNR/L



WN□□

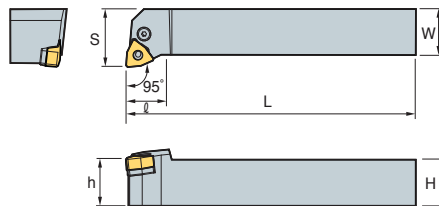

Fig.1

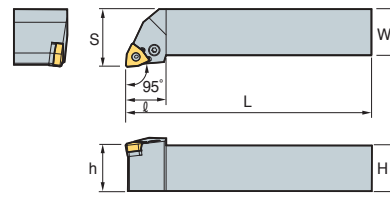
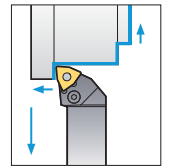

Fig.2



95°

• R type insert (mm)

Designation	H	W	L	S	h	ℓ	Insert	Lever	Screw	Shim	Shim Pin	Wrench	Shim Pin Punch	Fig.						
PWLNR/L	1616-H06	16	16	100	20	16	WN□□0604□□							1						
	2020-K06	20	20	125	25	20									LV3	VHX0617	SW317	SP3	HW25L	LSPS3
	2525-M06	25	25	150	32	25									20	LV4	VHX0821	SW42	SP4	HW30L
	2020-K08	20	20	125	25	20	26	WN□□0804□□							2					
	2525-M08	25	25	150	32	25	26									LV4	VHX0820N	SW42N	SP4N	HW30L
PWLNR/L	1616-H06N	16	16	100	20	16	WN□□0604□□							1						
	2020-K06N	20	20	125	25	20									LV3N	VHX0617N	SW317N	SP3	HW25L	LSPS3
	2525-M06N	25	25	150	32	25									20	LV4N	VHX0820N	SW42N	SP4N	HW30L
	2020-K08N	20	20	125	25	20	26	WN□□0804□□							2					
	2525-N08N	25	25	150	32	25	26									LV4N	VHX0820N	SW42N	SP4N	HW30L

Applicable inserts B62~B65



WTENN

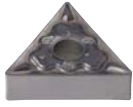

TN□□

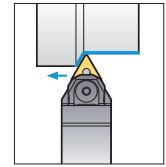
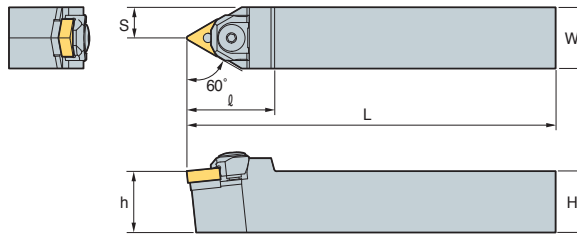

60°

• R type insert (mm)

Designation	H	W	L	S	h	ℓ	Insert	Wedge Clamp	Screw	Stopper Ring	Shim	Shim Pin	Nut	Wrench						
WTENN 2020-K16	20	20	125	10	20	36	TN□□1604□□													
	25	25	150	12.5	25	CMH6R6									MHX0626	ER04	ST32M	SP3M-1	N0407	HW30L
	25	25	150	12.5	25	42									SP3M					
WTENN 2525-M22	25	25	150	12.5	25	42	TN□□2204□□	CMH6R1	MHX0626	ER04	ST43M	SP4M	N0508	HW30L						

↻ Applicable inserts B53~B59

WTJNR/L



TN□□

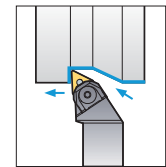
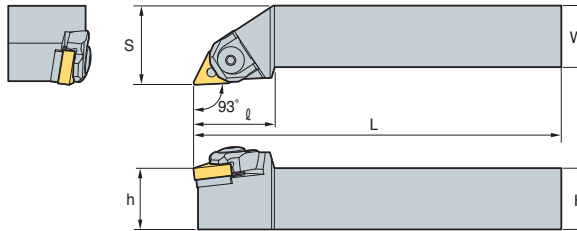

93°

• R type insert (mm)

Designation	H	W	L	S	h	ℓ	Insert	Wedge Clamp	Screw	Stopper Ring	Shim	Shim Pin	Nut	Wrench						
WTJNR/L 2020-K16	20	20	125	25	20	33	TN□□1604□□													
	25	25	150	32	25	CMH6R6									MHX0626	ER04	ST32M	SP3M-1	N0407	HW30L
	32	32	170	40	32	33									SP3M					
WTJNR/L 2525-M22	25	25	150	32	25	35	TN□□2204□□	CMH6R1	MHX0626	ER04	ST43M	SP4M	N0508	HW30L						

↻ Applicable inserts B53~B59

WTXNR/L

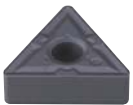

TN□□

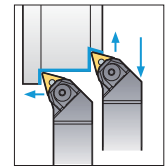
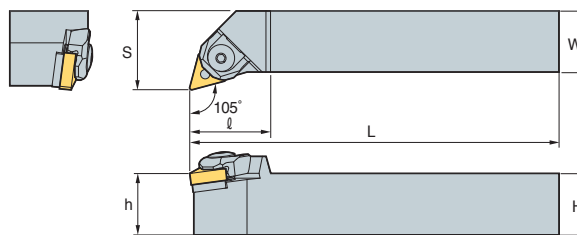

105°

• R type insert (mm)

Designation	H	W	L	S	h	ℓ	Insert	Wedge Clamp	Screw	Stopper Ring	Shim	Shim Pin	Nut	Wrench						
WTXNR/L 2020-K16	20	20	125	25	20	30	TN□□1604□□													
	25	25	150	32	25	CMH6R6									MHX0626	ER04	ST32M	SP3M-1	N0407	HW25L
	32	32	170	40	32	33									SP3M					HW30L

↻ Applicable inserts B53~B59

B Wedge Clamp System

WWLNR/L



WN□□

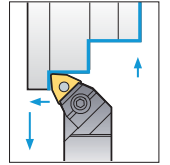
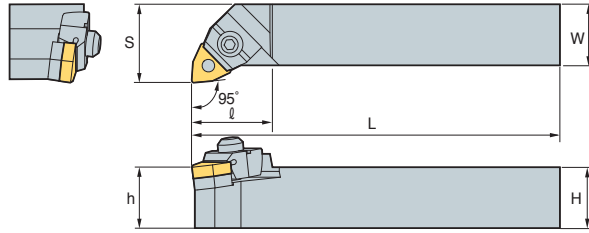

95°

• R type insert (mm)

Designation	H	W	L	S	h	l	Insert	Wedge Clamp	Screw	Stopper Ring	Shim	Shim Pin	Nut	Wrench	
WWLNR/L 2020-K08	20	20	125	25	20	32	WN□□0804□□								
2525-M08	25	25	150	32	25	33		CMH6R/L3	CMH6R2	MHX0630	CR05	SW43M	SP2M	N0508	HW30L
3232-P08	32	32	170	40	32	33		CMH6R2					SP4M		HW40L

↻ Applicable inserts B62~B65



CKJNR/L



KN□□

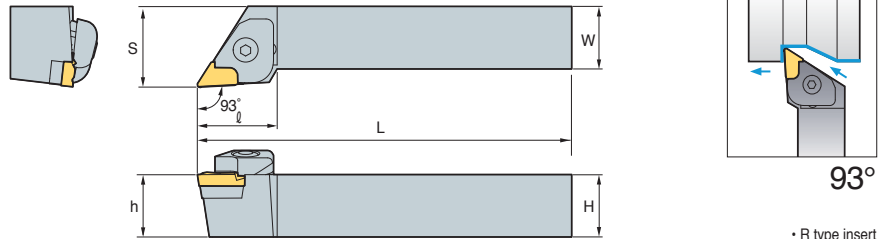

• R type insert (mm)

Designation		H	W	L	S	h	ℓ	Insert	Clamp	Clamp Screw	Spring	Shim	Pin + Spring	Shim Screw	Wrench
CKJNR	2020-K16	20	20	125	25	20	32	KN□□1604□□R							
	2525-M16	25	25	150	32	25	32								
	3225-M16	32	25	150	32	32	32								
	3225-P16	32	25	170	32	32	32								
	3232-P16	32	32	170	40	32	32								
4040-R16	40	40	200	50	40	32	CTH6R1	CHX0625	SR3	SK33C	PN0515 SR4	SHX0310	HW20L HW40L		
CKJNL	2020-K16	20	20	125	25	20	32	KN□□1604□□L							
	2525-M16	25	25	150	32	25	32								
	3232-P16	32	32	170	40	32	32								
	4040-R16	40	40	200	50	40	32								

➔ Applicable inserts B43

CKNNR/L



KN□□

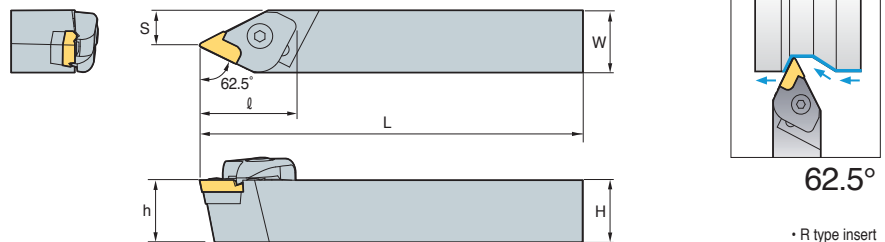

• R type insert (mm)

Designation		H	W	L	S	h	ℓ	Insert	Clamp	Clamp Screw	Spring	Shim	Pin + Spring	Shim Screw	Wrench
CKNNR	2525-M16	25	25	150	14.3	25	37	KN□□ 1604□□R							
	3232-P16	32	32	170	16.8	32	37								
CKNNL	2525-M16	25	25	150	14.3	25	37	KN□□ 1604□□L							
	3232-P16	32	32	170	16.8	32	37								

➔ Applicable inserts B43

CSDPN

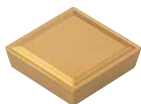

SP□R

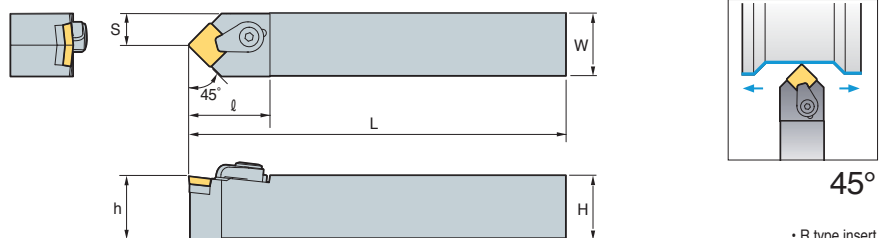

• R type insert (mm)

Designation		H	W	L	S	h	ℓ	Insert	Clamp	Clamp Screw	Shim	Shim Pin	C-Ring	Wrench
CSDPN	1616-H09	16	16	100	8	16	30	SP□R 0903□□						
	2525-M12	25	25	150	12.5	25	35	SP□R 1203□□						

➔ Applicable inserts B76~77

B Clamp on System

CSKPR/L

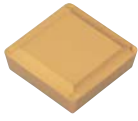

SP□R

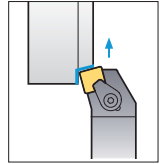
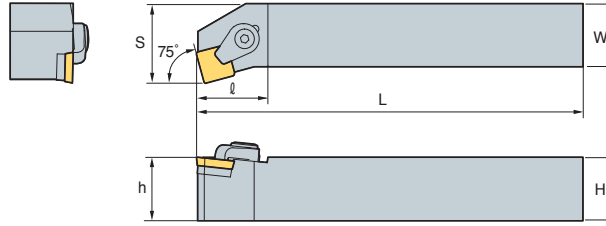

75°

• R type insert (mm)

Designation	H	W	L	S	h	l	Insert	Clamp	Clamp Screw	Shim	Shim Pin	C-Ring	Wrench
CSKPR/L 2525-M12	25	25	150	32	20	32	SP□R 1203□□						

➔ Applicable inserts B76~B77

CTFPR/L



TP□R

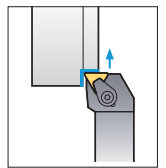
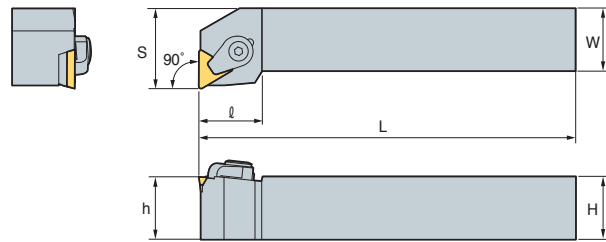

90°

• R type insert (mm)

Designation	H	W	L	S	h	l	Insert	Clamp	Clamp Screw	Shim	Shim Pin	C-Ring	Wrench
CTFPR/L 2020-K16	25	25	125	25	20	32	TP□R 1603□□						
2525-M16	25	25	150	32	25	32							

➔ Applicable inserts B81~B83

CTGPR/L



TP□R

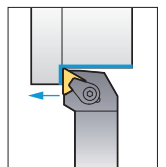
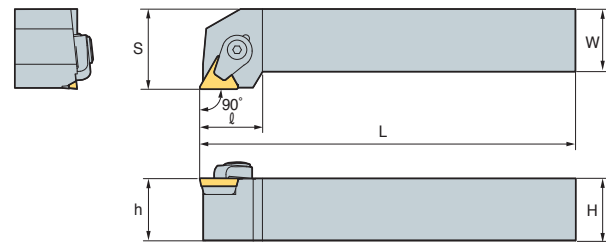

90°

• R type insert (mm)

Designation	H	W	L	S	h	l	Insert	Clamp	Clamp Screw	Shim	Shim Pin	C-Ring	Wrench
CTGPR/L 1212-F11	12	12	80	16	12	20	TP□R 1103□□						
1616-H11	16	16	100	20	16	20							
2020-K11	20	20	125	25	20	20							
2020-K16	20	20	125	25	20	25	TP□R 1603□□						
2525-M16	25	25	150	32	25	25							
2525-M22	25	25	150	32	25	32	TP□R 2204□□						
3232-P22	32	32	170	40	32	32							

➔ Applicable inserts B81~B83



MCKNR/L

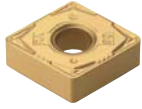

CN□□

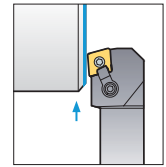
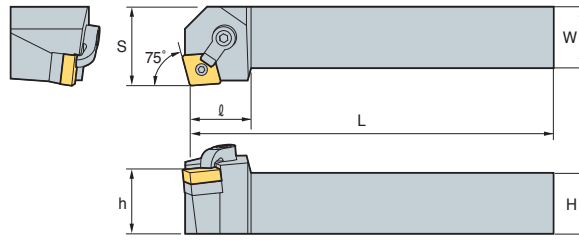

75°

• R type insert
(mm)

Designation	H	W	L	S	h	ℓ	Insert	Clamp	Clamp Screw	Shim	Shim Pin	Wrench
MCKNR/L 2020-K12	20	20	125	25	20	32	CN□□1204□□	CDH6N	DHA1/4-25	SC43D	SP4D	HW31.8L HW23.8L
2525-M12	25	25	150	32	25	32						
3232-P12	32	32	170	40	32	32						

➔ Applicable inserts B28~B35

MCLNR/L

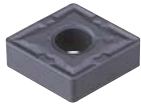

CN□□

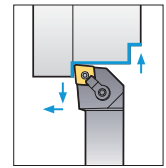
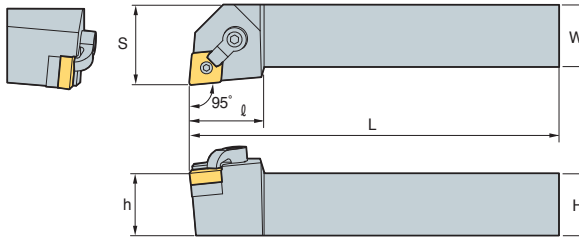

95°

• R type insert
(mm)

Designation	H	W	L	S	h	ℓ	Insert	Clamp	Clamp Screw	Shim	Shim Pin	Wrench
MCLNR/L 1616-H09	16	16	100	20	16	25	CN□□0903□□	CDH7N	DHA10-32-19	SC32D	SP3DS	HW23.8L HW19.8L
2020-K09	20	20	125	25	20	25						
2525-M09	25	25	150	32	25	25						
2020-K12	20	20	125	25	20	32	CN□□1204□□	CDH6N	DHA1/4-25	SC43D	SP4D	HW31.8L HW23.8L
2525-M12	25	25	150	32	25	32						
3225-P12	32	25	170	32	32	32						
3232-P12	32	32	170	40	32	32	CN□□1606□□	CDH8N	DHA5/16-32	SC53D	SP5D	HW39.7L HW31.8L
2525-M16	25	25	150	32	25	33						
3232-P16	32	32	170	40	32	33						
4040-S16	40	40	250	50	40	33	CN□□1906□□	CDH8N	DHA5/16-32	SC63D	SP6D	HW39.7L HW35.7L
2525-M19	25	25	150	32	25	38						
3232-P19	32	32	170	40	32	38						
4040-S19	40	40	250	50	40	38	CN□□2507□□	CDH8N3	DHA3/8-35	SC84D	SP8D	HW39.7L HW47.6L
4040-S25	40	40	250	50	40	38						

➔ Applicable inserts B28~B35

MCMNN

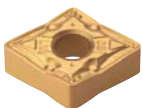

CN□□

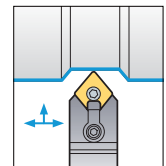
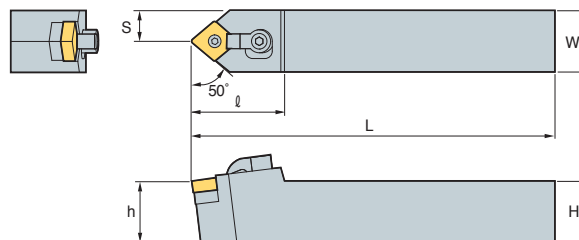

50°

• R type insert
(mm)

Designation	H	W	L	S	h	ℓ	Insert	Clamp	Clamp Screw	Shim	Shim Pin	Wrench
MCMNN 2020-K12	20	20	125	10	20	32	CN□□1204□□	CDH6N	DHA1/4-25	SC43D	SP4D	HW31.8L HW23.8L
2525-M12	25	25	150	12.5	25	32						
3232-P12	32	32	170	16	32	32						
2525-M16	25	25	150	12.5	25	40	CN□□1606□□	CDH8N	DHA5/16-32	SC53D	SP5D	HW39.7L HW31.8L
3232-P16	32	32	170	16	32	40						
3232-P19	32	32	170	16	32	40						
4040-S19	40	40	250	20	40	32	CN□□1906□□	CDH8N	DHA5/16-32	SD63D	SP6D	HW39.7L HW35.7L

➔ Applicable inserts B28~B35



B Multi Lock System

MCRNR/L



CN□□

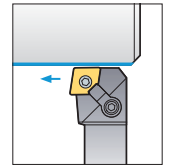
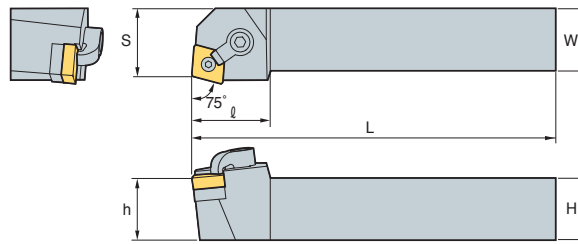

75°

• R type insert (mm)

Designation	H	W	L	S	h	ℓ	Insert	Clamp	Clamp Screw	Shim	Shim Pin	Wrench
MCRNR/L 2020-K12	20	20	125	22	20	32	CN□□1204□□					
	25	25	150	27	25	32						
2525-M16	25	25	150	27	25	33	CN□□1606□□					
3232-P16	32	32	170	35	32	33						
3232-P19	32	32	170	35	32	38	CN□□1906□□					
4040-S19	40	40	250	43	40	38						

➔ Applicable inserts B28~B35

MDJNR/L



DN□□

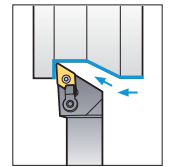
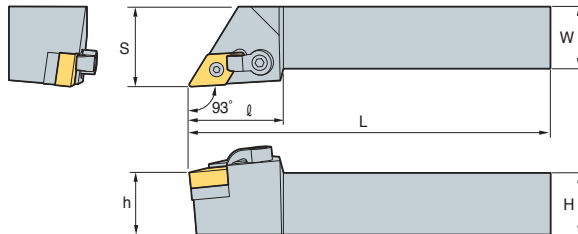

93°

• R type insert (mm)

Designation	H	W	L	S	h	ℓ	Insert	Clamp	Clamp Screw	Shim	Shim Pin	Wrench
MDJNR/L 2020-K11	20	20	125	25	20	32	DN□□1204□□					
	25	25	150	32	25	32						
2020-K15-3	20	20	125	25	20	36	DN□□1504□□					
2525-M15-3	25	25	150	32	25	36						
3232-P15-3	32	32	170	40	32	36	DN□□1506□□					
2020-K15	20	20	125	25	20	36						
2525-M15	25	25	150	32	25	36	DN□□1506□□					
3232-P15	32	32	170	40	32	36						

➔ Applicable inserts B36~B42

MDNNN



DN□□

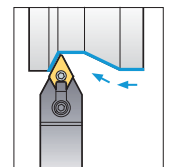
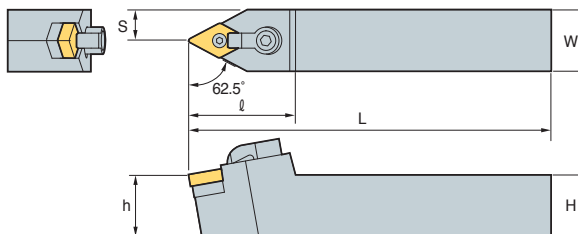

62.5°

(mm)

Designation	H	W	L	S	h	ℓ	Insert	Clamp	Clamp Screw	Shim	Shim Pin	Wrench
MDNNN 2525-M15-3	25	25	150	12.5	25	41	DN□□1504□□					
	25	25	150	12.5	25	41						
2525-M15	25	25	150	12.5	25	41	DN□□1506□□					
								CDH8N	DHA5/16-32	SD43D	SP4DL	HW39.7L HW23.8L

➔ Applicable inserts B36~B42



MDQNR/L



DN□□

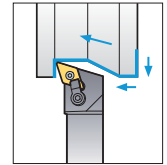
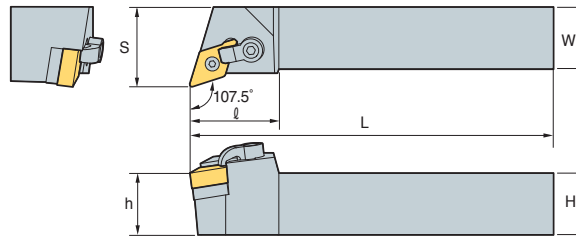

107.5°

• R type insert (mm)

Designation	H	W	L	S	h	ℓ	Insert	Clamp	Clamp Screw	Shim	Shim Pin	Wrench
MDQNR/L 2525-M15-3	25	25	150	32	25	36	DN□□1504□□					
	32	32	170	40	32	36						
2525-M15	25	25	150	32	25	36	DN□□1506□□					
	32	32	170	40	32	36						

➔ Applicable inserts B36~B42

MSBNR/L

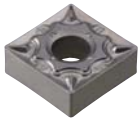

SN□□

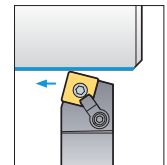
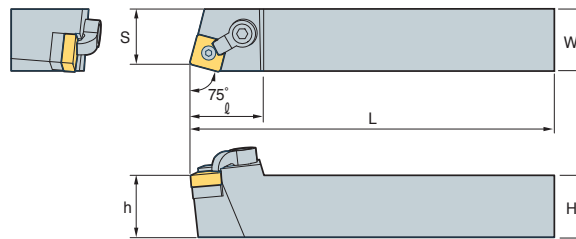

75°

• R type insert (mm)

Designation	H	W	L	S	h	ℓ	Insert	Clamp	Clamp Screw	Shim	Shim Pin	Wrench
MSBNR/L 2020-K12	20	20	125	17	20	32	SN□□1204□□					
2525-M12	25	25	150	22	25	32	SN□□1506□□					
2525-M15	25	25	150	22	25	35						
3232-P15	32	32	170	22	32	35	SN□□1906□□					
3232-P19	32	32	170	27	32	40						
4040-S19	40	40	250	35	40	40						

➔ Applicable inserts B44~B52

MSDNN

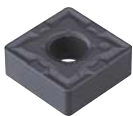

SN□□

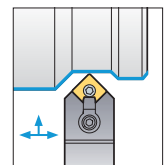
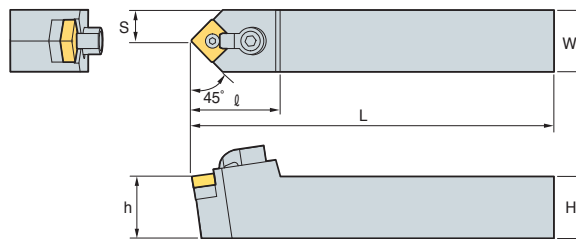

45°

(mm)

Designation	H	W	L	S	h	ℓ	Insert	Clamp	Clamp Screw	Shim	Shim Pin	Wrench
MSDNN 1616-H09	16	16	100	8	16	28	SN□□0903□□					
	20	20	125	10	20	28						
2020-K12	20	20	125	10	20	32	SN□□1204□□					
2525-M12	25	25	150	12.5	25	32						
3225-P12	32	25	170	12.5	32	32	SN□□1506□□					
2525-M15	25	25	150	12.5	25	35						
3225-P15	32	25	170	12.5	32	35	SN□□1906□□					
3232-P15	32	32	170	16	32	35						
4040-S15	40	40	250	20	40	35	SN□□1906□□					
3232-P19	32	32	170	16	32	42						
4040-S19	40	40	250	20	40	42						

➔ Applicable inserts B44~B52

B Multi Lock System

MSKNR/L



SN□□

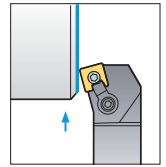
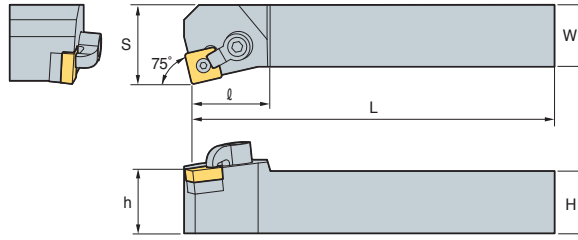

75°

• R type insert (mm)

Designation	H	W	L	S	h	l	Insert	Clamp	Clamp Screw	Shim	Shim Pin	Wrench
MSKNR/L 1616-H09	16	16	100	20	16	28	SN□□0903□□	CDH7N	DHA10-32-19	SS32D	SP3DS	HW19.8L HW23.8L
2020-K09	20	20	125	22	20	28						
2020-K12	20	20	125	25	20	32						
2525-M12	25	25	150	32	25	32	SN□□1204□□	CDH8N1	DHA5/16-32	SS43D	SP4D	HW39.7L HW23.8L
3225-P12	32	25	170	32	32	32						
2525-M15	25	25	150	32	25	35	SN□□1506□□	CDH8N	DHA5/16-32	SS53D	SP5D	HW39.7L HW31.8L
3232-P15	32	32	170	40	32	35						
3232-P19	32	32	170	40	32	40	SN□□1906□□	CDH8N	DHA5/16-32	SS63D	SP6D	HW39.7L HW35.7L
4040-S19	40	40	250	50	40	40						
4040-S25	40	40	250	50	40	40	SN□□2507□□	CDH8N3	DHA3/8-35	SS84D	SP8D	HW47.6L HW39.7L

➔ Applicable inserts B44~B52

MSRNR/L



SN□□

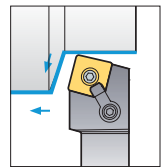
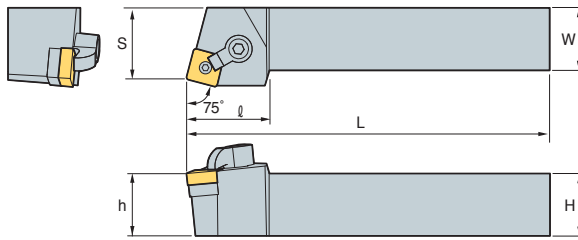

75°

• R type insert (mm)

Designation	H	W	L	S	h	l	Insert	Clamp	Clamp Screw	Shim	Shim Pin	Wrench
MSRNR/L 1616-H09	16	16	100	17	16	28	SN□□0903□□	CDH7N	DHA10-32-19	SS32D	SP3DS	HW19.8L HW23.8L
2020-K09	20	20	125	22	20	28						
2020-K12	20	20	125	22	20	32						
2525-M12	25	25	150	27	25	32	SN□□1204□□	CDH8N1	DHA5/16-32	SS43D	SP4D	HW39.7L HW23.8L
2525-M15	25	25	150	27	25	35						
3232-P15	32	32	170	35	32	35	SN□□1506□□	CDH8N	DHA5/16-32	SS53D	SP5D	HW39.7L HW31.8L
3225-P19	32	25	170	27	32	40						
3232-P19	32	32	170	35	32	40	SN□□1906□□	CDH8N	DHA5/16-32	SS63D	SP6D	HW39.7L HW35.7L
4040-S19	40	40	250	43	40	40						
4040-S25	40	40	250	43	40	40	SN□□2507□□	CDH8N3	DHA3/8-35	SS84D	SP8D	HW47.6L HW39.7L

➔ Applicable inserts B44~B52



MSSNR/L

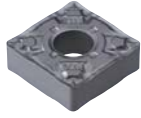

SN□□

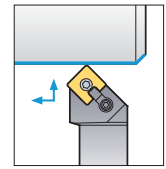
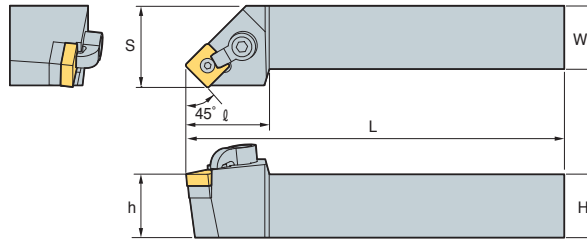

45°

• R type insert (mm)

Designation	H	W	L	S	h	ℓ	Insert	Clamp	Clamp Screw	Shim	Shim Pin	Wrench
MSSNR/L 1616-H09	16	16	100	20	16	28	SN□□0903□□	CDH7N	DHA10-32-19	SS32D	SP3DS	HW19.8L HW23.8L
	20	20	125	25	20	28						
2020-K12	20	20	125	25	20	32	SN□□1204□□	CDH8N1	DHA5/16-32	SS43D	SP4D	HW39.7L HW23.8L
2525-M12	25	25	150	32	25	32						
2525-M15	25	25	150	32	25	35	SN□□1506□□	CDH8N1	DHA5/16-32	SS53D	SP5D	HW39.7L HW31.8L
3232-P15	32	32	170	40	32	35						
3232-P19	32	32	170	40	32	40	SN□□1906□□	CDH8N1	DHA5/16-32	SS63D	SP6D	HW39.7L HW35.7L
4040-S19	40	40	250	50	40	40						

↻ Applicable inserts B44~B52

MTENN



TN□□

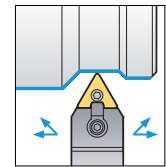
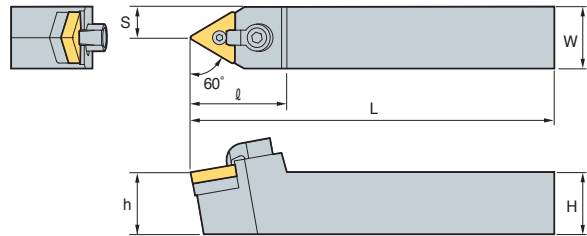

60°

(mm)

Designation	H	W	L	S	h	ℓ	Insert	Clamp	Clamp Screw	Shim	Shim Pin	Wrench
MTENN 2020-K16	20	20	125	10	20	32	TN□□1604□□	CDH7N	DHA10-32-19	ST32D	SP3D	HW23.8L HW19.8L
	25	25	150	12.5	25	32						
2525-M22	25	25	150	12.5	25	35	TN□□2204□□	CDH8N1	DHA5/16-32	ST43D	SP4D	HW39.7L HW23.8L
3232-P27	32	32	170	16	32	35	TN□□2706□□	CDH8N1	DHA5/16-32	ST53D	SP5D	HW39.7L HW31.8L
4040-S33	40	40	250	20	40	40	TN□□3307□□	CDH8N	DHA5/16-32	ST63D	SP6DL	HW39.7L HW35.7L

↻ Applicable inserts B53~B59

MTFNR/L



TN□□

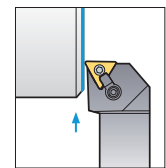
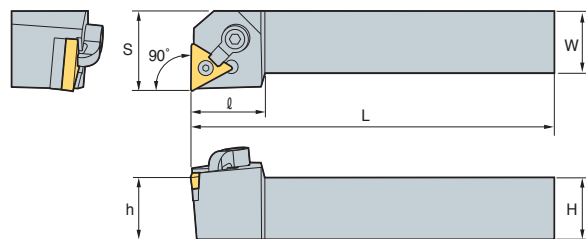

90°

• R type insert (mm)

Designation	H	W	L	S	h	ℓ	Insert	Clamp	Clamp Screw	Shim	Shim Pin	Wrench
MTFNR/L 1616-H16	16	16	100	20	16	32	TN□□1604□□	CDH7N	DHA10-32-19	ST32D	SP3D	HW23.8L HW19.8L
	20	20	125	25	20	32						
2525-M16	25	25	150	32	25	32	TN□□2204□□	CDH8N1	DHA5/16-32	ST43D	SP4D	HW39.7L HW23.8L
2525-M22	25	25	150	32	25	32						
3232-P22	32	32	170	40	32	32	TN□□2706□□	CDH8N1	DHA5/16-32	ST53D	SP5D	HW39.7L HW31.8L
4040-S22	40	40	250	50	40	32						
3232-P27	32	32	170	40	32	35	TN□□2706□□	CDH8N1	DHA5/16-32	ST53D	SP5D	HW39.7L HW31.8L
4040-S27	40	40	250	50	40	35						
4040-S33	40	40	250	50	40	40	TN□□3307□□	CDH8N	DHA5/16-32	ST63D	SP6DL	HW39.7L HW35.7L

↻ Applicable inserts B53~B59



B Multi Lock System

MTGNR/L



TN□□

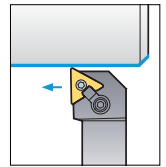
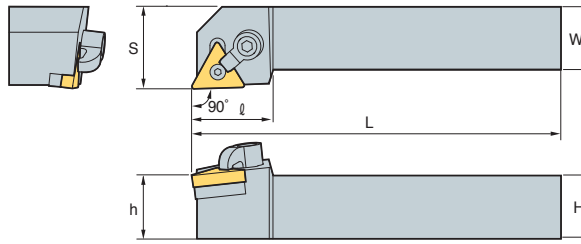

90°

• R type insert (mm)

Designation	H	W	L	S	h	ℓ	Insert	Clamp	Clamp Screw	Shim	Shim Pin	Wrench
MTGNR/L 1616-H16	16	16	100	20	16	32	TN□□1604□□					
2020-K16	20	20	125	25	20	32						
2525-M16	25	25	150	32	25	32						
2525-M22	25	25	150	32	25	32	TN□□2204□□					
3232-P22	32	32	170	40	32	32						
3232-P27	32	32	170	40	32	35	TN□□2706□□					
4040-S27	40	40	250	50	40	35						
4040-S33	40	40	250	50	40	40	TN□□3307□□					

➔ Applicable inserts B53~B59

MTJNR/L



TN□□

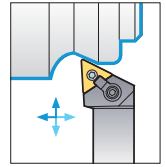
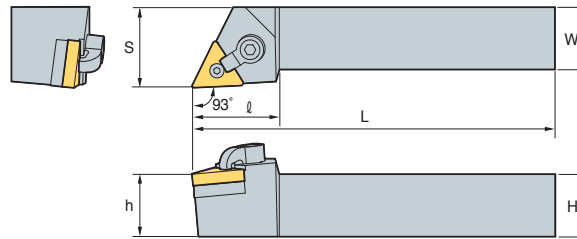

93°

• R type insert (mm)

Designation	H	W	L	S	h	ℓ	Insert	Clamp	Clamp Screw	Shim	Shim Pin	Wrench
MTJNR/L 2020-K16	20	20	125	25	20	32	TN□□1604□□					
2525-M16	25	25	150	32	25	32						
2525-M22	25	25	150	32	25	32						
3232-P22	32	32	170	40	32	32	TN□□2204□□					
3232-P27	32	32	170	40	32	35						
4040-S27	40	40	250	50	40	35	TN□□2706□□					
4040-S33	40	40	250	50	40	40						
							TN□□3307□□					

➔ Applicable inserts B53~B59

MVJNR/L



VN□□

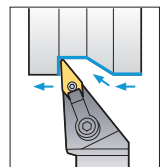
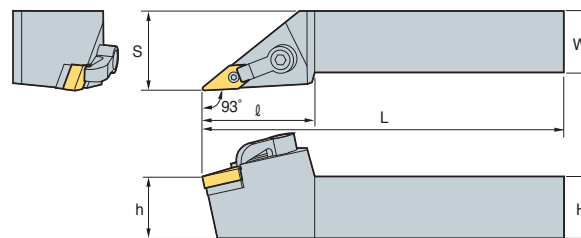

93°

• R type insert (mm)

Designation	H	W	L	S	h	ℓ	Insert	Clamp	Clamp Screw	Shim	Shim Pin	Wrench
MVJNR/L 2020-K16	20	20	125	25	20	37	VN□□1604□□					
2525-M16	25	25	150	32	25	37						
3232-P16	32	32	170	40	32	37						
2525-M22	25	25	150	32	25	50	VN□□2204□□					
3232-P22	32	32	170	40	32	50						
4040-S22	40	40	250	50	40	50						

➔ Applicable inserts B60~B61



MVQNR/L



VN□□

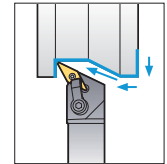
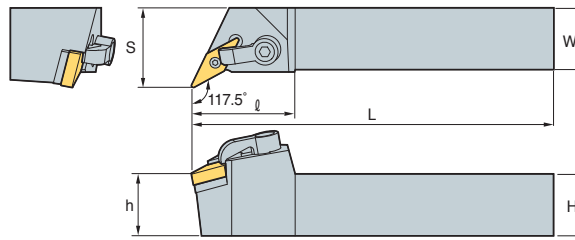

117.5°

· R type insert (mm)

Designation	H	W	L	S	h	ℓ	Insert	Clamp	Clamp Screw	Shim	Shim Pin	Wrench
MVQNR/L 2020-K16	20	20	125	25	20	42	VN□□1604□□					
2525-M16	25	25	150	32	25	42						
3232-P16	32	32	170	40	32	37						
								CDH8N2	DHA5/16-32	SV32D	SP3D	HW39.7L HW19.8L

↻ Applicable inserts B60~B61

MVVNN



VN□□

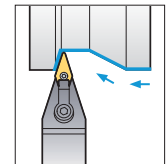
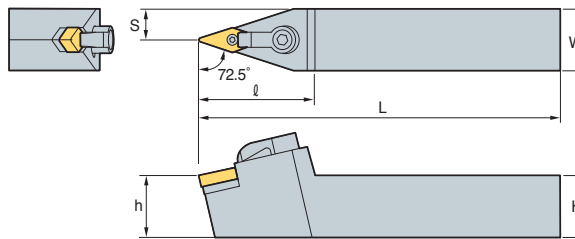

72.5°

(mm)

Designation	H	W	L	S	h	ℓ	Insert	Clamp	Clamp Screw	Shim	Shim Pin	Wrench
MVVNN 2020-K16	20	20	125	25	20	42	VN□□1604□□					
2525-M16	25	25	150	32	25	42						
								CDH8N2	DHA5/16-32	SV32D	SP3D	HW39.7L HW19.8L

↻ Applicable inserts B60~B61

MWLNR/L

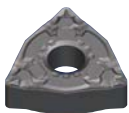

WN□□

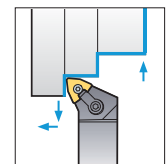
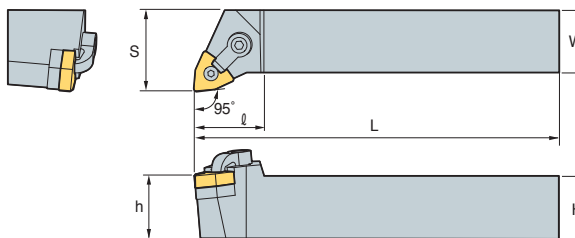

95°

· R type insert (mm)

Designation	H	W	L	S	h	ℓ	Insert	Clamp	Clamp Screw	Shim	Shim Pin	Wrench
MWLNR/L 2020-K06	20	20	125	25	20	32	WN□□0604□□					
2525-M06	25	25	150	32	25	32						
3232-P06	32	32	170	40	32	32						
2020-K08	20	20	125	25	20	32	WN□□0804□□					
2525-M08	25	25	150	32	25	32						
3232-P08	32	32	170	40	32	32						
								CDH7N	DHA10-32-19	SW32D	SP3D	HW19.8L HW23.8L
								CDH6N	DHA1/4-21	SW43D	SP4D	HW31.8L HW23.8L

↻ Applicable inserts B62~B65

B Screw on System

SCACR/L



CC□□

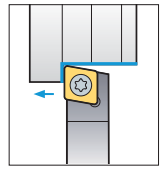
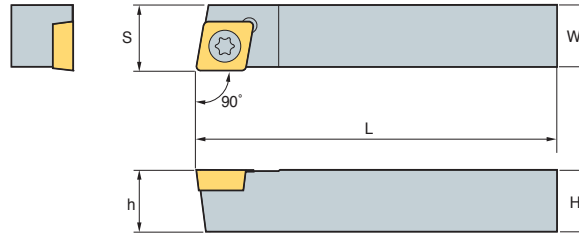

90°

• R type insert (mm)

Designation	H	W	L	S	h	Insert	Screw	Shim	Shim Screw	Wrench
SCACR/L 1010-E06	10	10	70	10.5	10	CC□□0602□□	FTKA02565	-	-	TW07P
1212-F09	12	12	80	12.5	12	CC□□09T3□□	FTKA03508	-	-	TW15P

➔ Applicable inserts B66~B69, B91

SCLCR/L

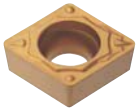

CC□□

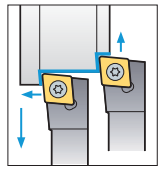
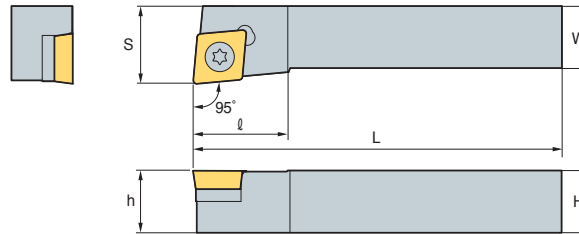

95°

• R type insert (mm)

Designation	H	W	L	S	h	ℓ	Insert	Screw	Shim	Shim Screw	Wrench
SCLCR/L 0808-D06	08	08	60	10	08	10	CC□□0602□□	FTKA02565	-	-	TW07P
1010-E06	10	10	70	16	10	10					
1212-F09	12	12	80	20	12	16					
1616-H09	16	16	100	20	16	16	CC□□09T3□□	CDH7N	-	-	TW15P
2020-K09	20	20	125	25	20	16					
2020-K12	20	20	125	25	20	25	CC□□1204□□	FTGA0411F	SC42S	SHXN0610F	TW15P
2525-M09	25	25	150	32	25	26	CC□□09T3□□	FTGA03508	-	-	TW15P
2525-M12	25	25	150	32	25	26	CC□□1204□□	FTGA0411F	SC42S	SHXN0610F	HW40L

➔ Applicable inserts B66~B69, B91

SDACR/L



DC□□

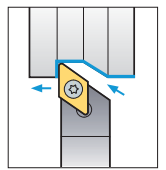
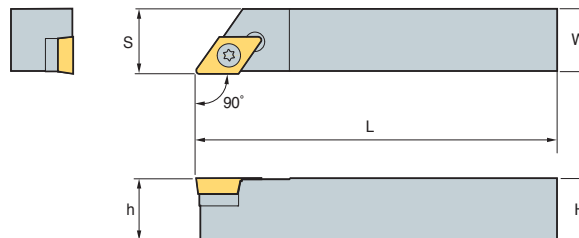

90°

• R type insert (mm)

Designation	H	W	L	S	h	Insert	Screw	Shim	Shim Screw	Wrench
SDACR/L 1010-E07	10	10	70	10.5	10	DC□□0702□□	FTKA02565	-	-	TW07P
1212-F11	12	12	80	12.5	12	DC□□11T3□□	FTKA03508	-	-	TW15P
1616-H11	16	16	100	16.5	16		FTGA03512	SD32S	SHXN0509F	TW15P, HW35L

➔ Applicable inserts B71~B73, B92



SDJCR/L



DC□□

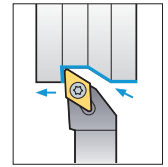
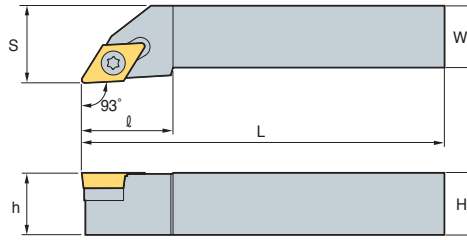

93°

• R type insert
(mm)

Designation	H	W	L	S	h	ℓ	Insert	Screw	Shim	Shim Screw	Wrench
SDJCR/L	1010-E07	10	10	70	12	10	DC□□0702□□	FTKA02565	-	-	TW07P
	1212-F07	12	12	80	16	12					
	1616-H07	16	16	100	20	16					
	2020-K07	20	20	125	25	20					
SDJCR/L	1212-F11	12	12	80	16	12	DC□□11T3□□	FTGA03512	-	-	TW15P, HW35L
	1616-H11	16	16	100	20	16					
	2020-K11	20	20	125	25	20					
	2525-M11	25	25	150	32	25					

➔ Applicable inserts B71~B73, B92

SDNCN



DC□□

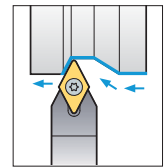
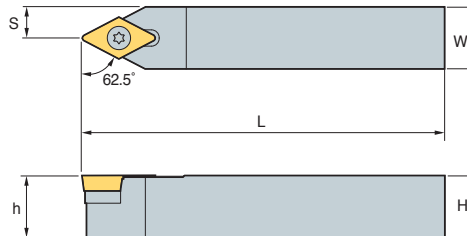

62.5°

(mm)

Designation	H	W	L	S	h	Insert	Screw	Shim	Shim Screw	Wrench	
SDNCN	1010-E07	10	10	70	5	10	DC□□0702□□	FTKA02565	-	-	TW07P
	1212-F07	12	12	80	6	12					
	1212-H11	12	12	100	6	12	DC□□11T3□□	FTGA03508	-	-	TW15P
	1616-H11	16	16	100	8	16	DC□□11T3□□	FTGA03512	SD32S	SHXN0509F	TW15P, HW35L
	2020-K11	20	20	125	10	20	DC□□11T3□□	FTGA03512	SD32S	SHXN0509F	TW15P, HW35L
	2020-M11	25	25	150	12.5	25	DCMT□□11T3□□	FTGA03512	SD32S	SHXN0509F	TW25P, HW35L

➔ Applicable inserts B71~B73, B92

SRDCN



RCGT

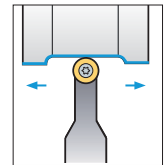
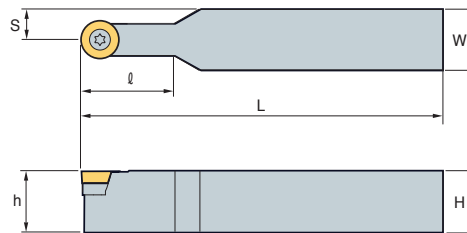

(mm)

Designation	H	W	L	S	h	ℓ	Insert	Screw	Shim	Shim Screw	Wrench	
SRDCN	1010-E06	10	10	70	5	10	RCGT 0602M0	FTKA02565	-	-	TW07P	
	1212-F06	12	12	80	6	12						
	1616-H06	16	16	100	8	16						
	2525-M06	25	25	150	12.5	25	20	RCGT 0803M0	FTNA0307	-	-	TW09P
	1616-H08	16	16	100	8	16						
	2020-K08	20	20	125	10	20						
	2525-M08	25	25	150	12.5	25	20	RCGT 1003M0	FTKA03511A	SR10S	SHXN0509F	TW15P HW35L
	1616-H10	16	16	100	8	16						
	2020-K10	20	20	125	10	20						
	2525-M10	25	25	150	12.5	25	25	RCGT 1204M0	FTGA03512	SR12S	SHXN0509F	TW15P HW35L
	2020-K12	20	20	125	10	20						
	2525-M12	25	25	150	12.5	25						

➔ Applicable inserts B93

SRGCR/L



RCGT

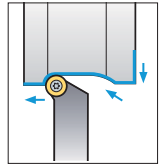
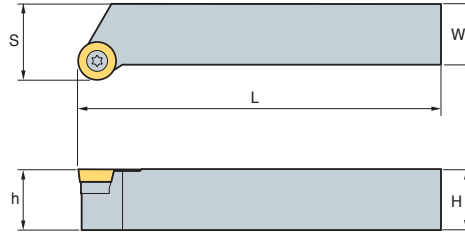

• R type insert
(mm)

Designation	H	W	L	S	h	Insert	Screw	Shim	Shim Screw	Wrench	
SRGCR/L	1010-E06	10	10	70	12	10	RCGT 0602M0	FTKA02565	-	-	TW07P
	1212-F06	12	12	80	16	12					
	1616-H06	16	16	100	20	16					
SRGCR/L	1616-H08	16	16	100	20	16	RCGT 0803M0	FTNA0307	-	-	TW09P
	2020-K08	20	20	125	25	20					
	2525-M08	25	25	150	32	25					
SRGCR/L	1616-H10	16	16	100	20	16	RCGT 1003M0	FTKA03511A	SR10S	SHXN0509F	TW15P HW35L
	2020-K10	20	20	125	25	20					
	2525-M10	25	25	150	32	25					
SRGCR/L	2020-K12	20	20	125	25	20	RCGT 1204M0	FTGA03512	SR12S	SHXN0509F	TW15P HW35L
	2525-M12	25	25	150	32	25					

➔ Applicable inserts B93

SSBCR/L



SC□□

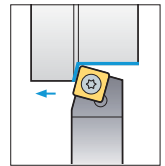
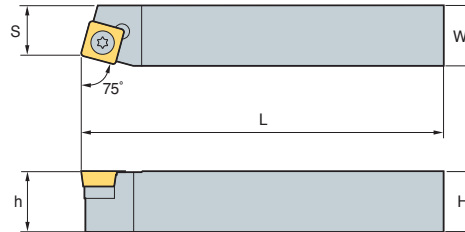

75°

• R type insert
(mm)

Designation	H	W	L	S	h	Insert	Screw	Shim	Shim Screw	Wrench	
SSBCR/L	1212-F09	12	12	80	11	12	SC□□09T3□□	FTGA03508	-	-	TW15P
	1616-H09	16	16	100	13	16					
	2020-K12	20	20	125	17	20					
SSBCR/L						SC□□1204□□	FTGA0411F	SS42S	SHXN0610F	TW15P, HW40L	

➔ Applicable inserts B74~B75, B94

SSDCN



SC□□

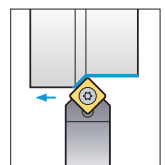
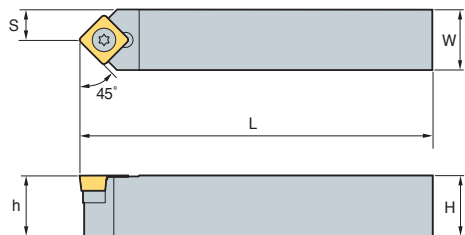

45°

(mm)

Designation	H	W	L	S	h	Insert	Screw	Shim	Shim Screw	Wrench	
SSDCN	1212-F09	12	12	80	6	12	SC□□09T3□□	FTGA03508	-	-	TW15P
	1616-H09	16	16	100	8	16					
SSDCN							FTGA03512	SS32S	SHXN0509F	TW15P, HW35L	

➔ Applicable inserts B74~B75, B94



SSKCR/L



SC□□

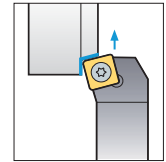
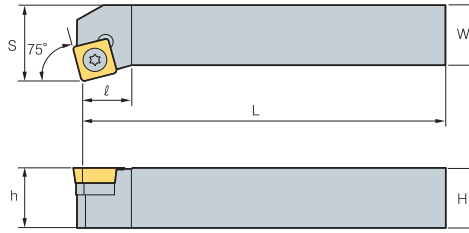

75°

• R type insert (mm)

Designation	H	W	L	S	h	ℓ	Insert	Screw	Shim	Shim Screw	Wrench
SSKCR/L 1616-H09	16	16	100	20	16	13	SC□□09T3□□	FTGA03512	SS32S	SHXN0509F	TW15P, HW35L

➔ Applicable inserts B74~B75, B94

SSSCR/L



SC□□

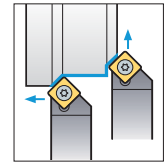
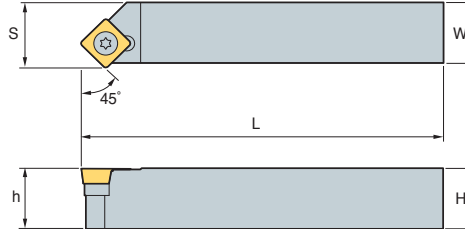

45°

• R type insert (mm)

Designation	H	W	L	S	h	Insert	Screw	Shim	Shim Screw	Wrench
SSSCR/L 1616-H09	16	16	100	17	16	SC□□09T3□□	FTGA03512	SS32S	SHXN0509F	TW15P, HW35L
2020-K12	20	20	125	21	20	SC□□1204□□	FTGA0411F	SS42S	SHXN0610F	TW15P, HW40L
2525-M12	25	25	150	26	25	SC□□1204□□	FTGA0411F	SS42S	SHXN0610F	TW15P, HW40L

➔ Applicable inserts B74~B75, B94

STACR/L



TC□□

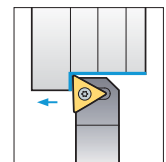
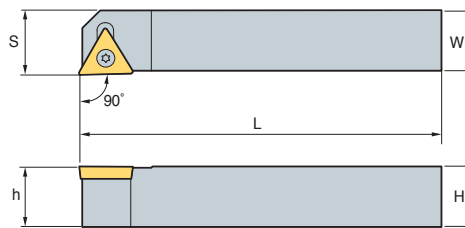

90°

• R type insert (mm)

Designation	H	W	L	S	h	Insert	Screw	Shim	Shim Screw	Wrench
STACR/L 1010-E09	10	10	70	10.5	10	TC□□0902□□	FTKA02206	-	-	TW06P
1212-F11	12	12	80	12.5	12	TC□□1102□□	FTKA02565	-	-	TW07P

➔ Applicable inserts B79~B80, B95

B Screw on System

STFCR/L



TC□□

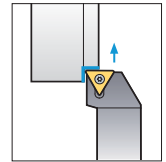
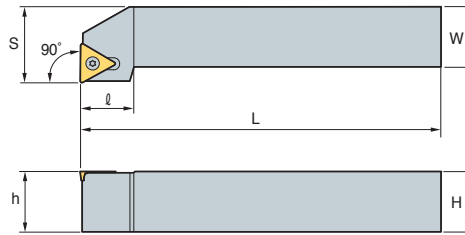

90°

• R type insert (mm)

Designation	H	W	L	S	h	ℓ	Insert	Screw	Shim	Shim Screw	Wrench
STFCR/L 1010-E09	10	10	70	12	10	10	TC□□0902□□	FTKA02206	-	-	TW06P
	12	12	80	16	12	14					
1616-H11	16	16	100	20	16	14	TC□□1102□□	FTKA02565	-	-	TW07P
1616-H16	16	16	100	20	16	19	TC□□16T3□□	FTGA03512	ST32S	SHXN0509F	TW15P, HW35L
2020-K16	20	20	125	25	20	19					
2525-M16	25	25	150	32	25	25.2	TC□□16T3□□	FTGA03512	ST32S	SHXN0509F	TW15P, HW35L

➔ Applicable inserts B79~B80, B95

STGCR/L



TC□□

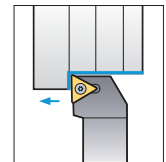
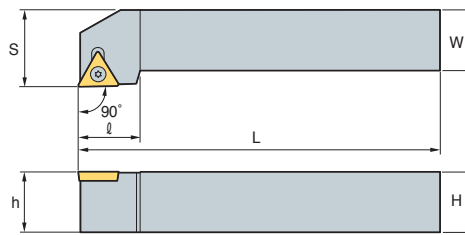

90°

• R type insert (mm)

Designation	H	W	L	S	h	ℓ	Insert	Screw	Shim	Shim Screw	Wrench
STGCR/L 0808-D09	08	08	60	10	08	11	TC□□0902□□	FTKA02206	-	-	TW06P
	10	10	70	12	10	11					
1212-F11	12	12	80	16	12	14	TC□□1102□□	FTKA02565	-	-	TW07P
1616-H11	16	16	100	20	16	16	TC□□16T3□□	FTGA03512	ST32S	SHXN0509F	TW15P, HW35L
1616-H16	16	16	100	20	16	21					
2020-K16	20	20	125	25	20	21	TC□□16T3□□	FTGA03512	ST32S	SHXN0509F	TW15P, HW35L
2525-M16	25	25	150	32	25	21	TC□□16T3□□	FTGA03512	ST32S	SHXN0509F	TW15P, HW35L

➔ Applicable inserts B79~B80, B95

STTCR/L



TC□□

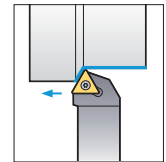
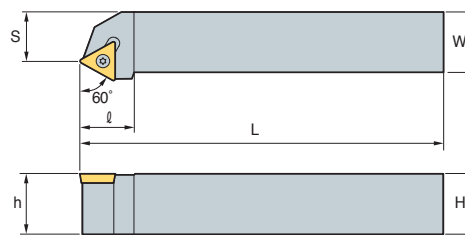

60°

• R type insert (mm)

Designation	H	W	L	S	h	ℓ	Insert	Screw	Shim	Shim Screw	Wrench
STTCR/L 1616-H11	16	16	100	13	16	14	TC□□1102□□	FTKA02565	-	-	TW07P
	16	16	100	13	16	19					
2020-K16	20	20	125	17	20	19	TC□□16T3□□	FTGA03512	ST32S	SHXN0509F	TW15P, HW35L

➔ Applicable inserts B79~B80, B95



SVABR/L



VB□□

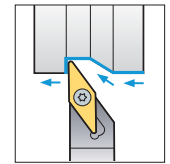
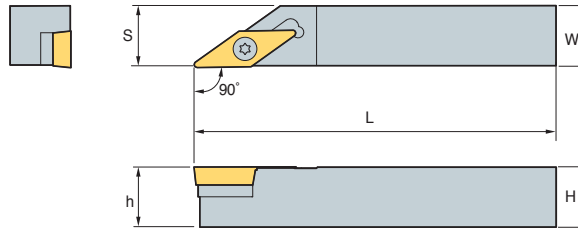

90°

• R type insert (mm)

Designation	H	W	L	S	h	Insert	Screw	Shim	Shim Screw	Wrench
SVABR/L 1616-H16	16	16	100	16.5	16	VB□□1604□□	FTGA03512	SV32S	SHXN0509F	TW15P, HW35L
2020-K16	20	20	125	20.5	20					

➔ Applicable inserts B84~B85, B96

SVHBR/L



VB□□

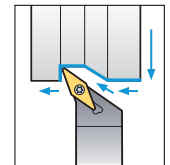
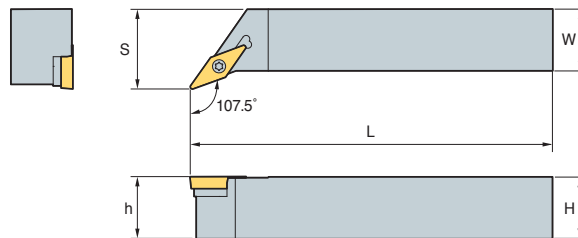

107.5°

• R type insert (mm)

Designation	H	W	L	S	h	Insert	Screw	Shim	Shim Screw	Wrench
SVHBR/L 2525-M16	25	25	150	32	25	VB□□1604□□	FTGA03512	SV32S	SHXN0509F	TW15P, HW35L
3225-P16	32	25	170	32	32					

➔ Applicable inserts B84~B85, B96

SVJBR/L



VB□□

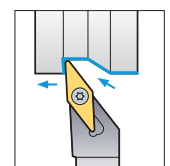
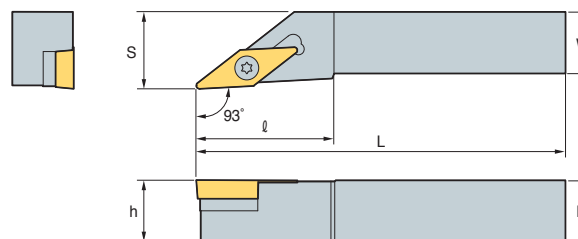

93°

• R type insert (mm)

Designation	H	W	L	S	h	ℓ	Insert	Screw	Shim	Shim Screw	Wrench
SVJBR/L 1212-F11	12	12	80	16	12	27	VB□□1102□□	FTKA02565	-	-	TW07P
1616-H11	16	16	100	20	16	27	VB□□1604□□	FTGA03512	SV32S	SHXN0509F	TW15P, HW35L
2020-K11	20	20	125	25	20	27					
1616-H16	16	16	100	20	16	36					
2020-K16	20	20	125	25	20	41	VB□□1604□□	FTGA03512	SV32S	SHXN0509F	TW15P, HW35L
2525-M16	25	25	150	32	25	41	VB□□1604□□	FTGA03512	SV32S	SHXN0509F	TW15P, HW35L
3225-P16	32	25	170	32	32	55					
3232-P16	32	32	170	40	33	55					

➔ Applicable inserts B84~B85, B96

B Screw on System

SVJCR/L



VC□□

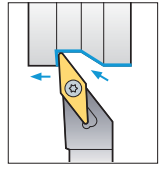
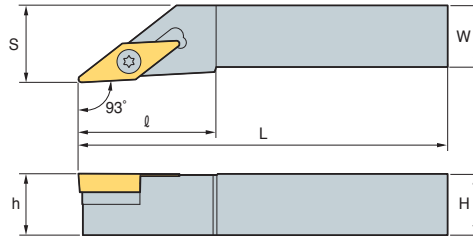

93°

• R type insert (mm)

Designation	H	W	L	S	h	ℓ	Insert	Screw	Shim	Shim Screw	Wrench	
SVJCR/L	1212-F11	12	12	80	16	12	VC□□1103□□	FTKA02565	-	-	TW07P	
	1616-H11	16	16	100	20	16						25
	2020-K11	20	20	125	25	20						25
1212-F13	12	12	80	16	12	32	VC□□1303□□	FTKA0307	-	-	TW09P	
	1616-H13	16	16	100	20	16						32
	2020-K13	20	20	125	25	20						32
1616-H16	16	16	100	20	16	40	VC□□1604□□	FTGA03512	SV32S	SHXN0509F	TW15P, HW35L	
	2020-K16	20	20	125	25	20						40
2525-M16	25	25	150	32	25	40						

⇒ Applicable inserts B86~B87, B97

SVVBN



VB□□

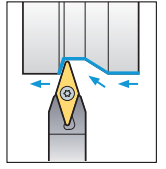
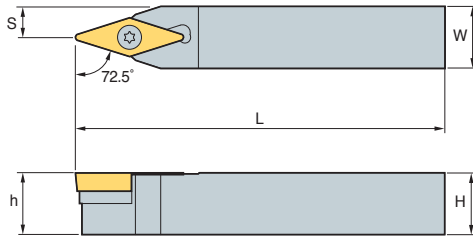

72.5°

(mm)

Designation	H	W	L	S	h	Insert	Screw	Shim	Shim Screw	Wrench	
SVVBN	1212-F11	12	12	80	6	12	VB□□1102□□	FTKA02565	-	-	TW07P
	1616-H11	16	16	100	8	16					
	2020-K11	20	20	125	10	20					
1616-H16	16	16	100	8	16	VB□□1604□□	FTGA03512	SV32S	SHXN0509F	TW15P, HW35L	
	2020-K16	20	20	125	10						20
2525-M16	25	25	150	12.5	25						
3225-P16	32	25	170	12.5	32						

⇒ Applicable inserts B84~B85, B96

SVVCN



VC□□

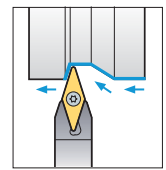
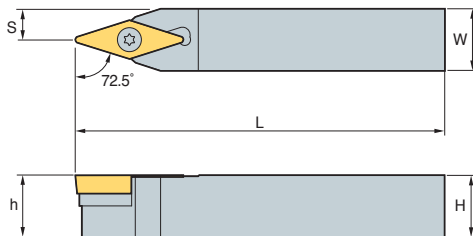

72.5°

(mm)

Designation	H	W	L	S	h	Insert	Screw	Shim	Shim Screw	Wrench	
SVVCN	1212-F11	12	12	80	6	12	VC□□1103□□	FTKA02565	-	-	TW07P
	1616-H11	16	16	100	8	16					
	2020-K11	20	20	125	10	20					
1212-F13	12	12	80	6	12	VC□□1303□□	FTNA0307	-	-	TW09P	
	1616-H13	16	16	100	8						16
	2020-K13	20	20	125	10						20
1616-H16	16	16	100	8	16	VC□□1604□□	FTGA03512	SV32S	SHXN0509F	TW15P, HW35L	
	2020-K16	20	20	125	10						20
2525-M16	25	25	150	12.5	25						

⇒ Applicable inserts B86~B87, B97



CCLNR/L



CN□N

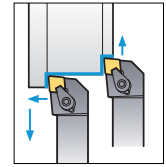
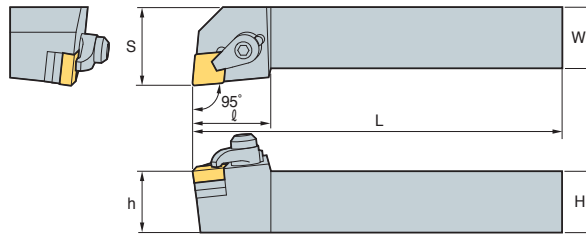

95°

• R type insert
(mm)

Designation	H	W	L	S	h	ℓ	Insert	Clamp	Screw	Shim	Spring	Wrench
CCLNR/L 2525-M12C	25	25	150	32	25	32	CN□N 1204□□ 1207□□	CH6R3	MHX0630 SHX0310	SC42CC	SR3	HW40L HW20L

CRDNN



RN□N

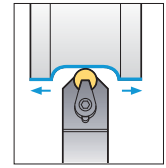
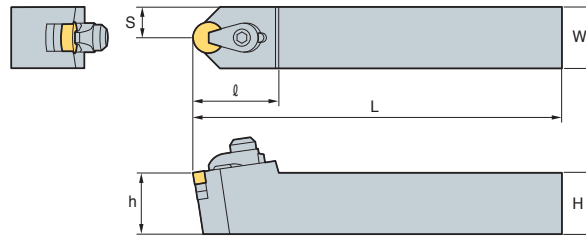

(mm)

Designation	H	W	L	S	h	ℓ	Insert	Clamp	Screw	Shim	Spring	Wrench
CRDNN 2525-M12C	25	25	150	12.5	25	35	RN□N 1204□□ 1207□□	CH6R3	MHX0630 SHX0310	SC42CC	SR3	HW40L HW20L

CRGNR/L



RN□N

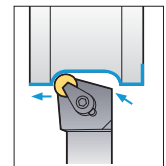
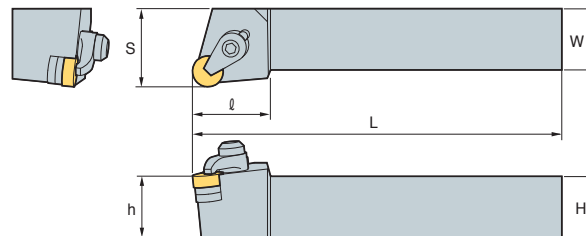

• R type insert
(mm)

Designation	H	W	L	S	h	ℓ	Insert	Clamp	Screw	Shim	Spring	Wrench
CRGNR/L 2525-M12C	25	25	150	32	25	32	RN□N 1204□□ 1207□□	CH6R3	MHX0630 SHX0310	SC42CC	SR3	HW40L HW20L

CSDNN



SN□N

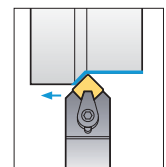
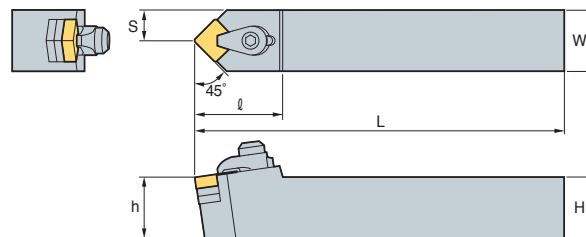

45°

(mm)

Designation	H	W	L	S	h	ℓ	Insert	Clamp	Screw	Shim	Spring	Wrench
CSDNN 2525-M12C	25	25	125	12.5	25	35	SN□N 1204□□ 1207□□	CH6R3	MHX0630 SHX0310	SS42CC	SR3	HW40L HW20L

B Ceramic Holder

CSKNR/L



SN□N

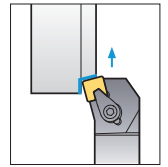
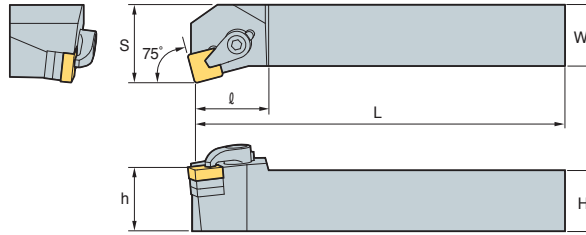

75°

• R type insert
(mm)

Designation	H	W	L	S	h	l	Insert	Clamp	Screw	Shim	Spring	Wrench
CSKNR/L 2525-M12C	25	25	150	32	25	28	SN□N 1204□□ 1207□□	CH6R3	MHX0630 SHX0310	SS42CC	SR3	HW40L HW20L

CTFNR/L



TN□N

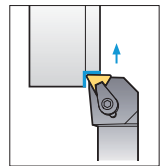
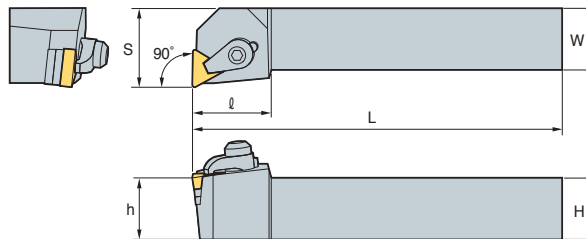

90°

• R type insert
(mm)

Designation	H	W	L	S	h	l	Insert	Clamp	Screw	Shim	Spring	Wrench
CTFNR/L 2525-M16C	25	25	150	32	25	32	TN□N 1604□□ 1607□□	CH6R3	MHX0630 SHX0310	ST32CC	SR3	HW40L HW20L

CTGNR/L



TN□N

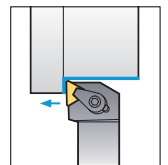
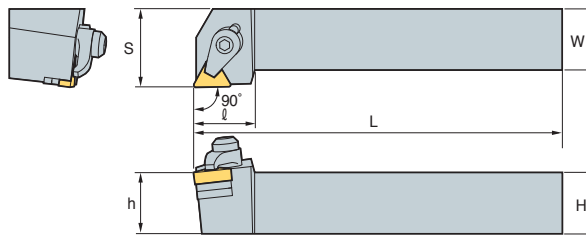

90°

• R type insert
(mm)

Designation	H	W	L	S	h	l	Insert	Clamp	Screw	Shim	Spring	Wrench
CTGNR/L 2525-M16C	25	25	150	32	25	32	TN□N 1604□□ 1607□□	CH6R3	MHX0630 SHX0310	ST32CC	SR3	HW40L HW20L



Note) Generally, two shims are clamped to a Ceramic Holder.

However, only one shim is used in clamping 1207□□ and 1607□□ sized inserts.



High pressure coolant holder for inconel machining

KHP **new**

KORLOY High Pressure Coolant holder

- 300% increased productivity on Inconel machining vs. low pressure coolant system
- Cooling, tool life, and chip control are improved by the high volume coolant multi-directional injection system

Structure of Holder

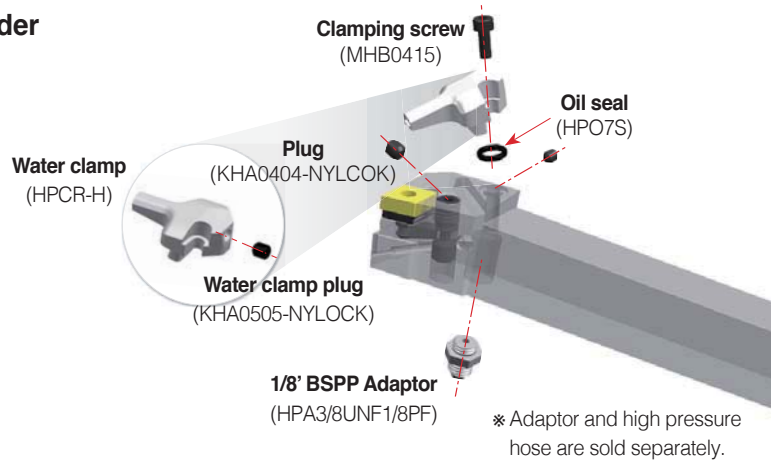

Features

- The optimal distance between the insert and the jet orifice and the ideal place of the jet orifice
- Maximized pressure of coolant due to the streamlined jet orifice
- Easy to clamp an insert for sliding clamp system

MAX 300 bar

Workpiece	The minimum pressure	The maximum pressure
P	50	300
M	70	
K	60	
N	50	
S	70	

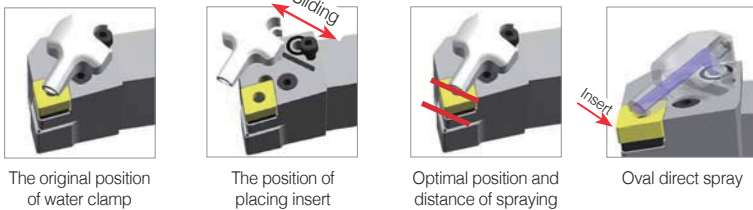

Water clamp with a hole

Water clamp with three holes

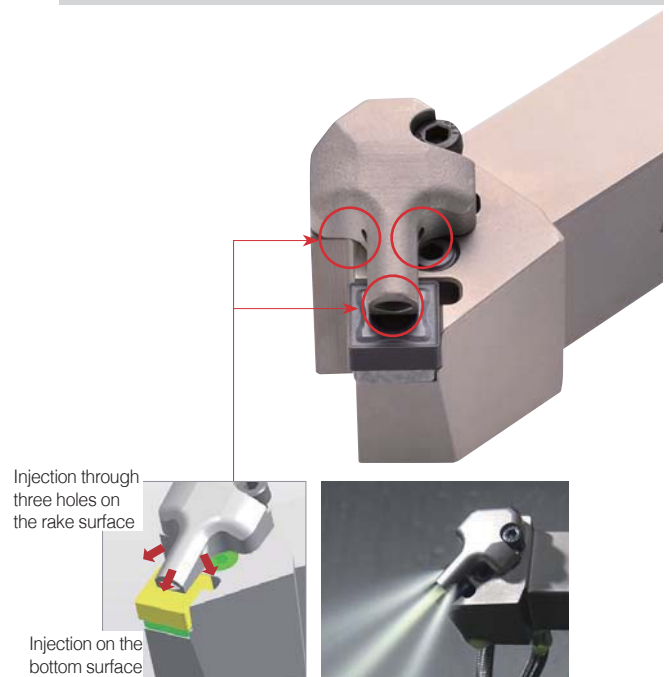
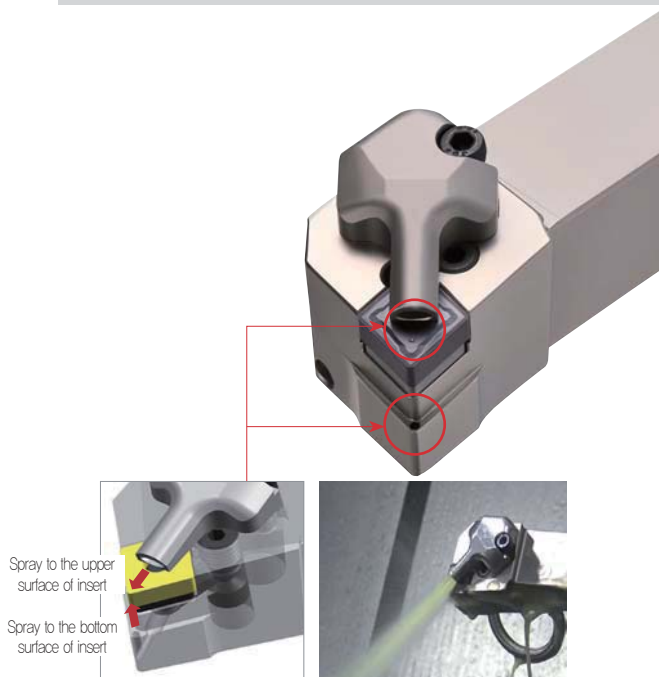

B Technical Information for KHP

How to use the water clamp



Application range

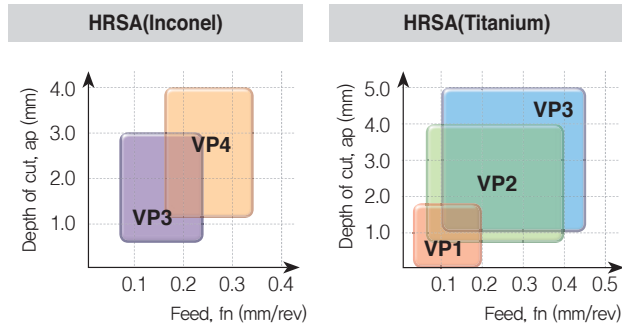

Grade Line-up

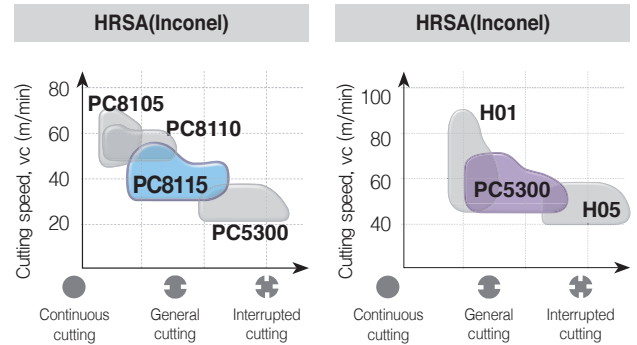

How to clamp the KHP

- Easy to clamp with 3 types of installation system
- The banjo type hose provides wider area for machining



※ Blank including a fixed oil seal provides easy clamping

※ Banjo screws provide easy clamping and clamping a holder to the turning machine with various types of blanks.

Components of KHP

- The components of high pressure coolant are sold separately
- Various components are available according to different machining sites and uses machining with high pressure coolant

Designation	Shape	Hose length	High pressure hose	Blank	Adaptor	Banjo screw	Copper washer	Pic.
HPH3/8UNF-200-SET	S S	200mm	1 EA	1 EA	2 EA	-	-	1
HPH3/8UNF-250-SET		250mm						
HPH3/8UNF1/8PF-200-SET	S B	200mm	1 EA	1 EA	1 EA	1 EA	3EA	2
HPH3/8UNF1/8PF-250-SET		250mm						
HPH1/8PF-200-SET	B B	200mm	-	-	-	2 EA	5EA	3
HPH1/8PF-250-SET		250mm						



PCLNR/L

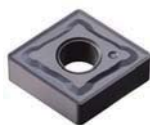

CN□□

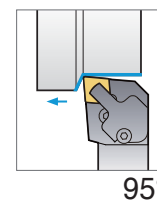
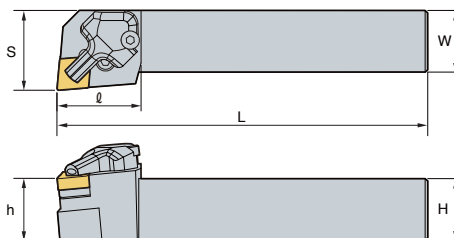
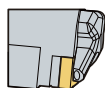

95°

• R type insert (mm)

Designation	H	W	L	S	h	l	Insert	Lever	Screw	Shim	Ship pin	Wrench	Shim Pin Punch	Clamp	Clamping screw	Oil seal	Plug
PCLNR/L 2525-M12-KHP	25	25	150	32	25	34	CN□□1204□□										
3232-P12-KHP	32	32	170	40	32	34											

➔ Applicable inserts B28~B35

PDJNR/L



DN□□

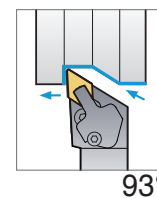
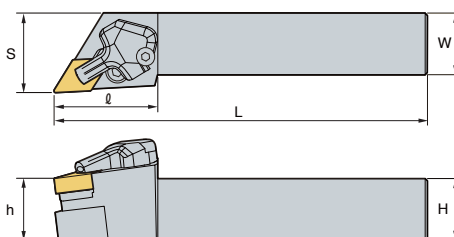
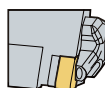

93°

• R type insert (mm)

Designation	H	W	L	S	h	l	Insert	Lever	Screw	Shim	Ship pin	Wrench	Shim Pin Punch	Clamp	Clamping screw	Oil seal	Plug										
PDJNR/L 2525-M11-KHP	25	25	150	32.25	25	42	DN□□1104□□																				
2525-M1504-KHP	25	25	150	32.25	25	42	DN□□1504□□											LV3AN	VHX0617N	SD32N	SP3	HW20L HW25L HW30L	LSPS3	HPCR-H	MHB0415	HPO7S	KHA0404-NYLOCK
2525-M1506-KHP	25	25	150	32.25	25	42	DN□□1506□□											LV4BN	VHX0821N	SD43N	SP4N	HW20L HW30L	LSPS4	HPCR-H	MHB0415	HPO7S	KHA0404-NYLOCK

➔ Applicable inserts B36~B42

PSSNR/L



SN□□

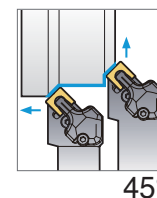
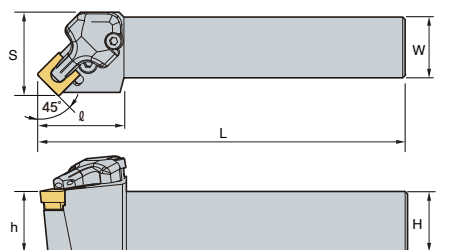
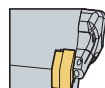

45°

• R type insert (mm)

Designation	H	W	L	S	h	l	Insert	Lever	Screw	Shim	Ship pin	Wrench	Shim Pin Punch	Clamp	Screw bolt	Oil seal	Screw plug
PSSNR/L 2525-M12-KHP	25	25	150	34.25	25	34	SN□□1204□□										
							LV4N										

➔ Applicable inserts B44~B52

PWLNR/L



WN□□

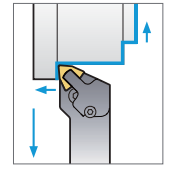
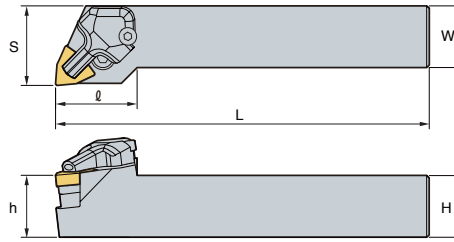
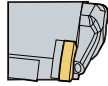

95°

• R type insert
(mm)

Designation	H	W	L	S	h	l	Insert	Lever	Screw	Shim	Shim pin	Wrench	Shim Pin Punch	Clamp	Clamping screw	Oil seal	Plug
PWLNR/L 2525-M08-KHP	25	25	150	32.25	25	33	WN□□0804□□										
3232-P08-KHP	32	32	170	39.25	32	33											

➔ Applicable inserts B62~B65

SRGCR/L



RCGT

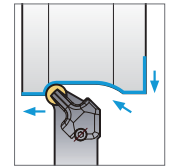
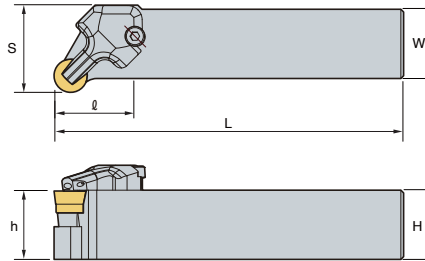

• R type insert
(mm)

Designation	H	W	L	S	h	l	Insert	Screw	Shim	Shim Screw	Wrench	Clamp	Clamping screw	Oil seal
SRGCR/L 2525-M12-KHP	25	25	150	31.5	25	-	RCGT1204M0							
								FTGA03512	SR12S	SHXN0509F	HW15P HW30L HW35L	HPCR/L-3H	MHB0415	HPO7S

➔ Applicable inserts B93

SVJBR/L



VB□□

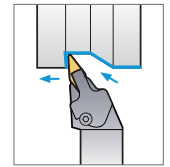
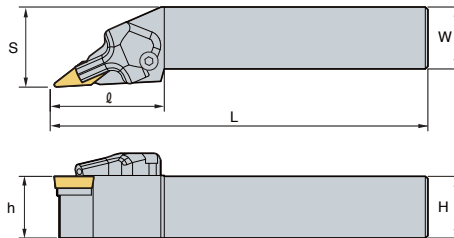

93°

• R type insert
(mm)

Designation	H	W	L	S	h	l	Insert	Screw	Shim Screw	Shim	Wrench	Clamp	Clamping screw	Oil seal
SVJBR/L 2525-M16-KHP	25	25	150	32.5	25	46.5	VB□□1604□□							
								FTGA03512	SHXN0509F	SV32S	TW15P HW30L HW35L	HPCR-H	MHB0415	HPO7S

➔ Applicable inserts B84~B85, B96



S 12 M - S T F P R - 11

1

2

3

4

5

6

7

8

9

Type of Bar

Bar Diameter

Bar Length

Method of Mounting Insert

Insert Shape

Lead Angle of Boring Bar

Relief Angle of Insert

Hand of Bar

Length of Cutting Edge

1 Type of Bar

S 12 M - S T F P R - 11

- "A" Steel with coolant hole
- "E" Carbide bar with fixed steel head and coolant hole
- "C" Carbide shank
- "S" Steel shank
- "X" Special type

2 Bar Diameter

S 12 M - S T F P R - 11

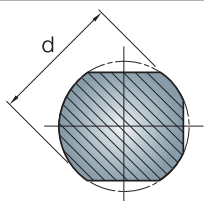

3 Bar Length

S 12 M S T F P R - 11

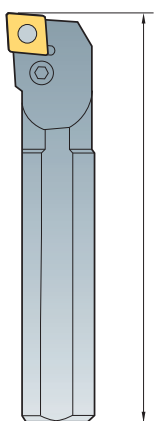

Symbol(L)	length(mm)
H	100
J	110
K	125
M	150
N	160
Q	180
R	200
S	250
T	300
U	350
V	400
W	450
Y	500

4 Method of Mounting Insert

S 12 M S T F P R - 11



Top clamping
C

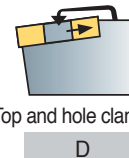

Top and hole clamping
D

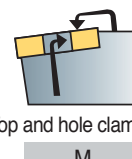

Top and hole clamping
M

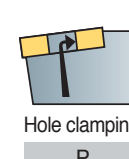

Hole clamping
P



Screw on
S

5 Insert Shape

S 12 M - S T F P R - 11

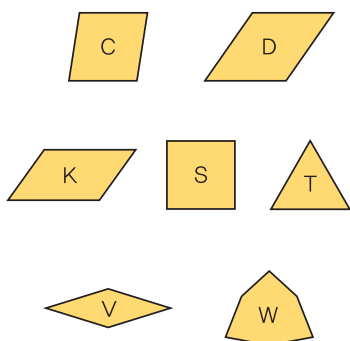

6 Lead Angle of Boring Bar

S 12 M - S T F P R - 11

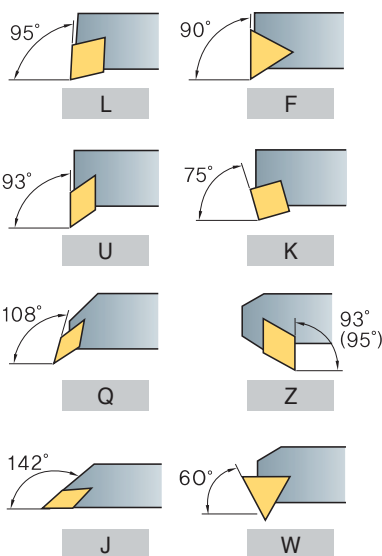

7 Relief Angle of Insert

S 12 M - S T F P R - 11

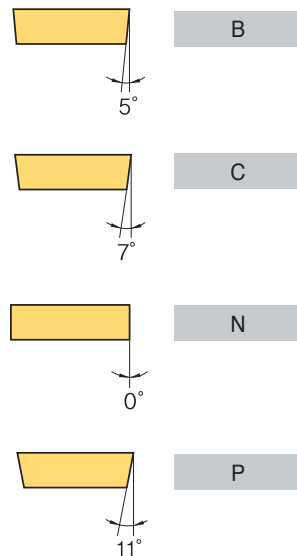

8 Hand of Bar

S 12 M - S T F P R - 11

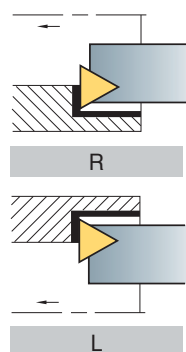

9 Length of Cutting Edge

S 12 M - S T F P R - 11

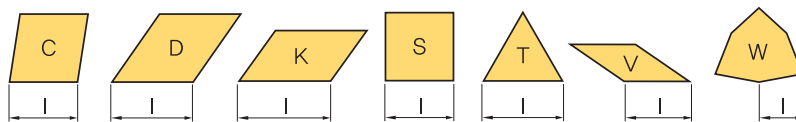

B Index for Boring Bar

Double Clamp System

Cutting Shape								
Designation	DCLNR/L	DDUNR/L	DSKNR/L	DTFNR/L	DWLNR/L			
Approach angle	95°	93°	75°	90°	95°			
Page	B195	B195	B195	B196	B196			
Copying		●						
Facing	●				●			
Back turning		●						
Turning	●	●	●	●	●			

Lever Lock System

Cutting Shape								
Designation	PCLNR/L	PDSNR/L	PDUNR/L	PSKNR/L	PTFNR/L	PWLNR/L		
Approach angle	95°	62.5°	93°	75°	90°	95°		
Page	B197	B197	B198	B199	B199	B200		
Copying		●	●					
Facing	●					●		
Back turning		●	●			●		
Turning	●	●	●	●	●	●		

Clamp on System

Cutting Shape								
Designation	CKUNR/L	CSKPR/L	CTFPR/L					
Approach angle	93°	75°	90°					
Page	B201	B201	B201					
Copying								
Facing								
Back turning	●							
Turning	●	●	●					

Multi Lock System

Cutting Shape								
Designation	MCLNR/L	MDUNR/L	MSKNR/L	MTFNR/L	MVUNR/L	MWLNR/L		
Approach angle	95°	93°	75°	90°	93°	95°		
Page	B202	B202	B202	B203	B203	B203		
Copying		●			●			
Facing	●					●		
Back turning		●			●	●		
Turning	●	●	●	●	●	●		



Screw on System

Cutting Shape								
Designation	SCLCR/L	SCLPR/L	SDQCR/L	SDUCR/L	SDZCR/L	SSKCR/L	SSKPR/L	STFCLR/L
Approach angle	95°	95°	107.5°	93°	93°	75°	75°	90°
Page	B204	B205	B206	B207	B208	B208	B208	B209
Copying			●	●				
Facing	●	●						
Back turning			●	●	●			
Turning	●	●	●	●	●	●	●	●

Cutting Shape								
Designation	STFPR/L	STWPR/L	SVJCR/L	SVQBR/L	SVQCR/L	SVUBR/L	SVUCR/L	SWLCR/L
Approach angle	90°	60°	142°	108°	108°	93°	93°	95°
Page	B210	B211	B211	B211	B212	B212	B212	B213
Copying			●	●	●	●	●	●
Facing								
Back turning				●	●	●	●	●
Turning	●	●	●	●	●	●	●	●

Compact Mini

Cutting Shape								
Designation	SCLCR/L	STUBR/L	STUPR/L	SWUBR/L				
Approach angle	95°	93°	93°	93°				
Page	B214	B214	B215	B216				
Copying								
Facing	●	●						
Back turning			●					
Turning	●	●	●	●				

Carbide Shank Boring Bar

Designation	SCLCR/L	SCLPR/L	SDQCR/L	SDUCR/L	STFCLR/L
Approach angle	95°	95°	107.5°	93°	90°
Page	B204	B205	B206	B207	B209

Designation	STFPR/L	STUBR/L	STUPR/L	SWUBR/L	-
Approach angle	90°	93°	93°	93°	-
Page	B210	B214	B215	B216	-

Sleeve

Shape		
Designation	SL	
Page	B136	

B Instructions of Boring Bar assembly

Instructions of Boring Bar assembly

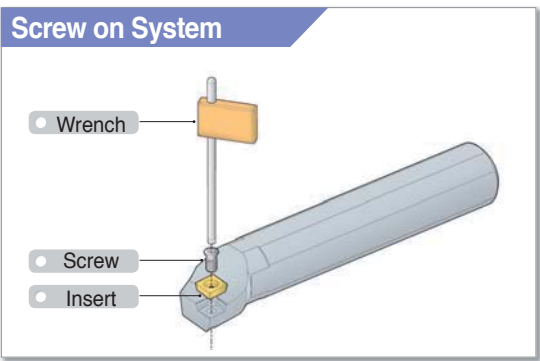
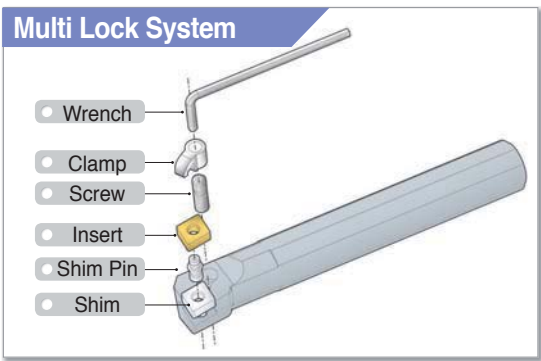
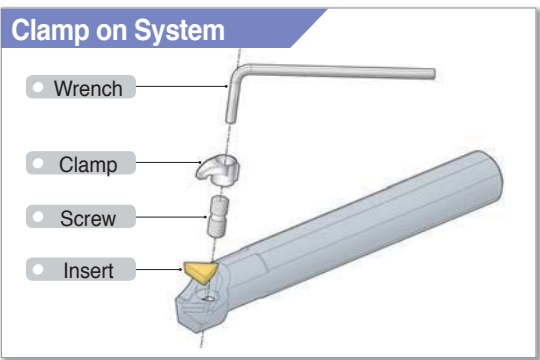
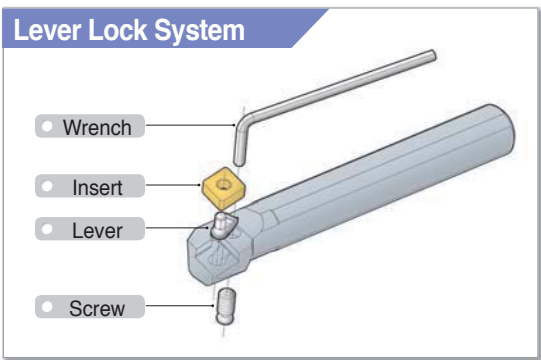
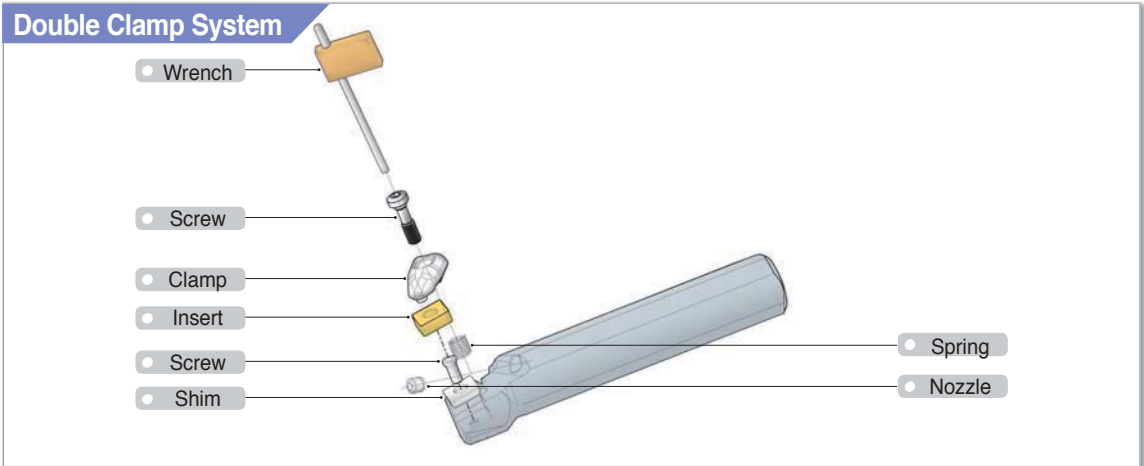

Carbide Shank Boring Bar

- Excellent cutting performance even in internal machining with chattering
- Available for various workpieces such as steel, stainless steel, cast iron, etc.
- Improved tool life and surface roughness

Features

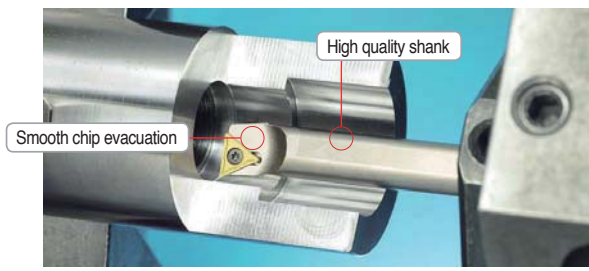

Higher strength and durability than steel shank, special surface treatment applied

Comparison of chipping

Specifications	Steel boring bar	Carbide boring bar												
<ul style="list-style-type: none"> • SCM440 • v_c : 200 m/min • a_p : 0.4 mm • f_n : 0.15 mm/rev • Cutting depth: 5D 														
	<table border="1"> <thead> <tr> <th>Rmax</th> <th>Rz</th> <th>Ra</th> </tr> </thead> <tbody> <tr> <td>4.67</td> <td>3.68</td> <td>0.62</td> </tr> </tbody> </table>	Rmax	Rz	Ra	4.67	3.68	0.62	<table border="1"> <thead> <tr> <th>Rmax</th> <th>Rz</th> <th>Ra</th> </tr> </thead> <tbody> <tr> <td>3.07</td> <td>2.76</td> <td>0.53</td> </tr> </tbody> </table>	Rmax	Rz	Ra	3.07	2.76	0.53
Rmax	Rz	Ra												
4.67	3.68	0.62												
Rmax	Rz	Ra												
3.07	2.76	0.53												



DCLNR/L



CN□□

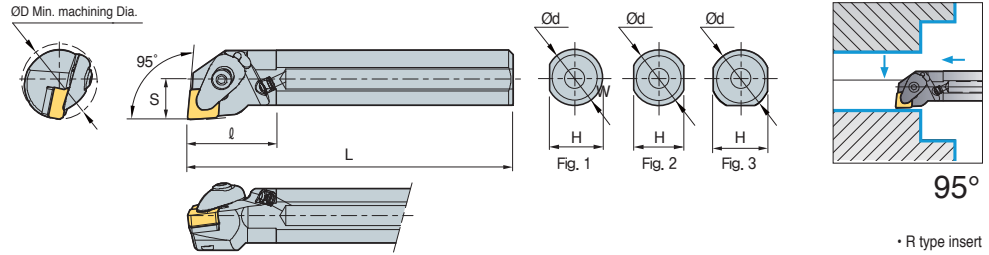

• R type insert (mm)

Designation	ØD	Ød	H	L	S	ℓ	Insert	Clamp	Clamp Screw	Shim	Shim Screw	Spring	Nozzle	Wrench	Fig.
A25R-DCLNR/L-09	32	25	24	200	17	40	CN□□0903□□	CVH3	CHX0415	SC32V	FTKA0307	SPR0510	CN0605	HW25P	1
A25R-DCLNR/L-12	32	25	24	200	17	40	CN□□1204□□	CVH4	CHX0518	SC42V	FTKA0410	SPR0714	CN0605	HW30P	1
A32S-DCLNR/L-12	40	32	30	250	22	50									3
A40T-DCLNR/L-12	50	40	38	300	27	60									
A50U-DCLNR/L-16	63	50	48	350	35	70	CN□□1606□□	CVH5	CHX0622	SC54V	FTNA0511	SPR0811	CN0605	HW40L	3

↻ Applicable inserts B28~B35

DDUNR/L



DN□□

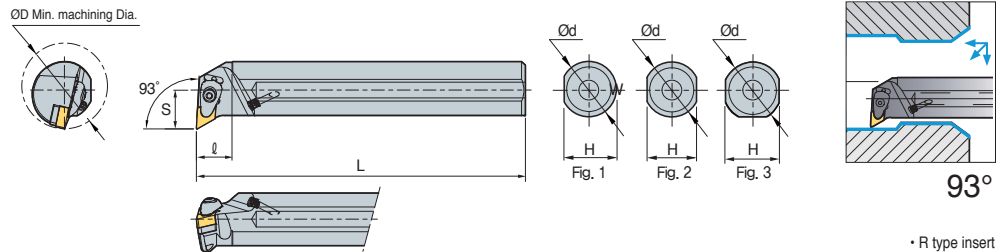

• R type insert (mm)

Designation	ØD	Ød	H	L	S	ℓ	Insert	Clamp	Clamp Screw	Shim	Shim Screw	Spring	Nozzle	Wrench	Fig.
A40T-DDUNR/L-15	50	40	38	300	27	60	DN□□1506□□	CVH4	CHX0518	SD43V	FTKA0410	SPR0714	CN0605	HW30P	3
A50U-DDUNR/L-15	63	50	47	350	35	70									
A40T-DDUNR/L-15 -3	50	40	38	300	27	60	DN□□1504□□	CVH4	CHX0518	SD44V	FTKA0410	SPR0714	CN0605	HW30P	3
A50U-DDUNR/L-15 -3	63	50	47	350	35	70									

↻ Applicable inserts B36~B42

DSKNR/L



SN□□

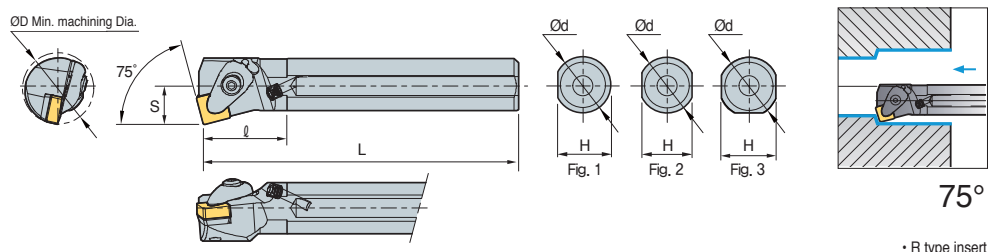

• R type insert (mm)

Designation	ØD	Ød	H	L	S	ℓ	Insert	Clamp	Clamp Screw	Shim	Shim Screw	Spring	Nozzle	Wrench	Fig.
A25R-DSKNR/L-09	32	25	24	200	17	40	SN□□0903□□	CVH3	CHX0415	SS32V	FTKA0307	SPR0510	CN0605	HW25P	1
A25R-DSKNR/L-12	32	25	24	200	17	40	SN□□1204□□	CVH4	CHX0518	SS42V	FTKA0410	SPR0714	CN0605	HW30P	1
A32S-DSKNR/L-12	40	32	30	250	22	50									3
A40T-DSKNR/L-12	50	40	38	300	27	60									

↻ Applicable inserts B44~B52



B Double Clamp System

DTFNR/L

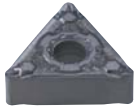

TN□□

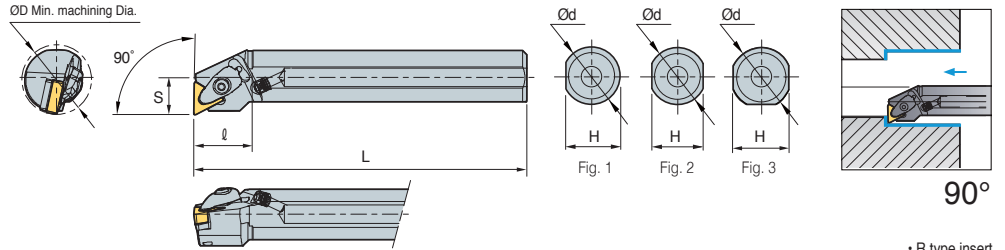

• R type insert (mm)

Designation	ØD	Ød	H	L	S	ℓ	Insert	Clamp	Clamp Screw	Shim	Shim Screw	Spring	Nozzle	Wrench	Fig.
A25R-DTFNR/L-16	32	25	24	200	17	40	TN□□1604□□								1
A32S-DTFNR/L-16	40	32	30	250	22	3									
A40T-DTFNR/L-22	50	40	38	300	27	60									
A50U-DTFNR/L-22	63	50	47	350	35	70	TN□□2204□□								3

↻ Applicable inserts B53~B59

DWLNR/L



WN□□

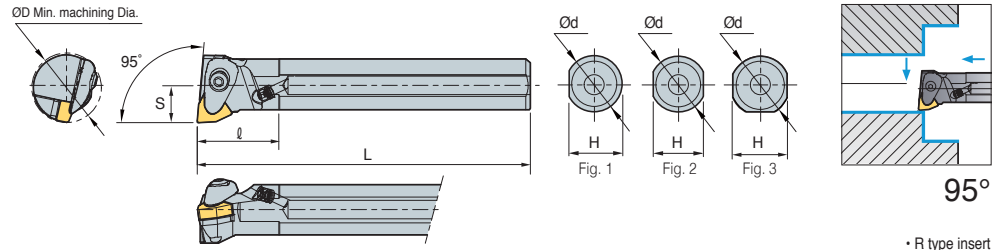

• R type insert (mm)

Designation	ØD	Ød	H	L	S	ℓ	Insert	Clamp	Clamp Screw	Shim	Shim Screw	Spring	Nozzle	Wrench	Fig.
A25R-DWLNR/L-06	32	25	24	200	17	40	WN□□0604□□								1
A32S-DWLNR/L-06	40	32	30	250	22	50									3
A40T-DWLNR/L-06	50	40	38	300	27	60									
A25R-DWLNR/L-08	32	25	24	200	17	40	WN□□0804□□								1
A32S-DWLNR/L-08	40	32	30	250	22	50									3
A40T-DWLNR/L-08	50	40	38	300	27	60									
A50U-DWLNR/L-08	63	50	47	350	35	70									

↻ Applicable inserts B62~B65

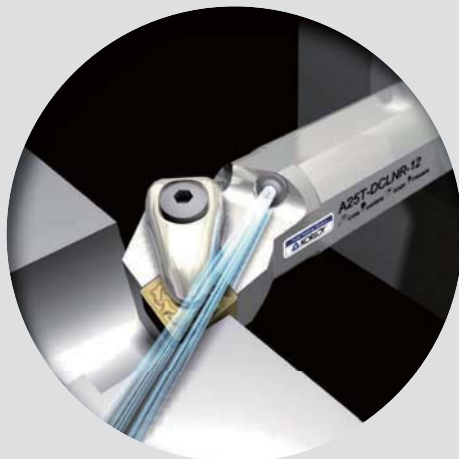

Features of Double Clamp (Boring bar)

Longer tool life and excellent surface finish can be achieved with the adjustable Coolant Nozzle

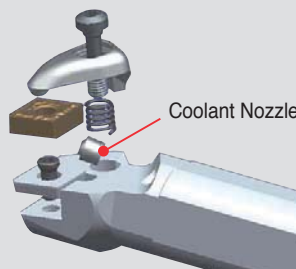

PCLNR/L



CN□□

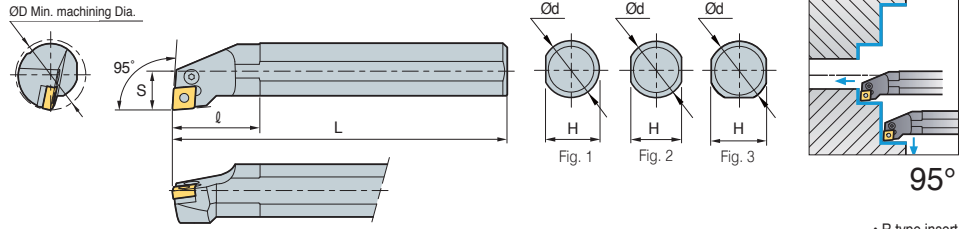

• R type insert (mm)

Designation	ØD	Ød	H	L	S	l	Insert	Lever	Screw	Shim	Shim Pin	Shim Pin Punch	Wrench	Fig.					
S16R-PCLNR/L-09	20	16	14	200	11	25	CN□□0903□□	LV3C	VHX0509B	-	-	-	HW20L	2					
S20S-PCLNR/L-09	25	20	18	250	13	32								3					
S25R-PCLNR/L-09	32	25	23	200	17	40	CN□□1204□□	LV4A	VHX0613A	-	-	-	HW25L	3					
S25T-PCLNR/L-12	32	25	23	300	17	40													
S32S-PCLNR/L-12	40	32	30	250	22	50													
S32U-PCLNR/L-12	40	32	30	350	22	50								LV4	VHX0821	SC42B	SP4	LSPS4	HW30L
S40T-PCLNR/L-12	50	40	38	300	27	60													
S50U-PCLNR/L-12	63	50	47	350	35	70													
S50U-PCLNR/L-19	63	50	47	350	35	70	CN□□1906□□	LV6	VHX1027	SC63	SP6	LSPS6	HW40L	3					
A25R-PCLNR/L-12	32	25	24	200	17	40	CN□□1204□□	LV4A	VHX0613A	-	-	-	HW25L	1					
A32S-PCLNR/L-12	40	32	30	250	22	50								3					
A40T-PCLNR/L-12	50	40	38	300	27	60	CN□□1204□□	LV4N	VHX0820N	SC42N	SP4N	LSPS4	HW30L	3					
S16R-PCLNR/L-09N	20	16	14	200	11	25													
S20S-PCLNR/L-09N	25	20	18	250	13	32													
S25R-PCLNR/L-09N	32	25	23	200	17	40													
S25R-PCLNR/L-12N	32	25	23	200	17	40													
S25T-PCLNR/L-12N	32	25	23	300	17	40													
S32S-PCLNR/L-12N	40	32	30	250	22	50													
S32U-PCLNR/L-12N	40	32	30	350	22	50													
S40T-PCLNR/L-12N	50	40	38	300	27	60													
S50U-PCLNR/L-12N	63	50	47	350	35	70													
S50U-PCLNR/L-19N	63	50	47	350	35	70	CN□□1906□□	LV6N	VHX1027N	SC63N	SP6N	LSPS6	HW40L	3					
A16R-PCLNR/L-09N	20	16	14	200	11	25	CN□□0903□□	LV3CN	VHX0509BN	-	-	-	HW20L	1					
A20S-PCLNR/L-09N	25	20	18	250	13	32								1					
A25R-PCLNR/L-09N	32	25	23	200	17	40	CN□□1204□□	LV4AN	VHX0613N	-	-	-	HW25L	1					
A25R-PCLNR/L-12N	32	25	23	200	17	40													
A32R-PCLNR/L-12N	40	32	30	250	22	50													
A40T-PCLNR/L-12N	50	40	38	300	27	60								LV4N	VHX0820N	SC42N	SP4N	LSPS4	HW30L
A50U-PCLNR/L-12N	63	50	47	350	35	70													
A50U-PCLNR/L-19N	63	50	47	350	35	70													

↻ Applicable inserts B28~B35

PDSNR/L



DN□□

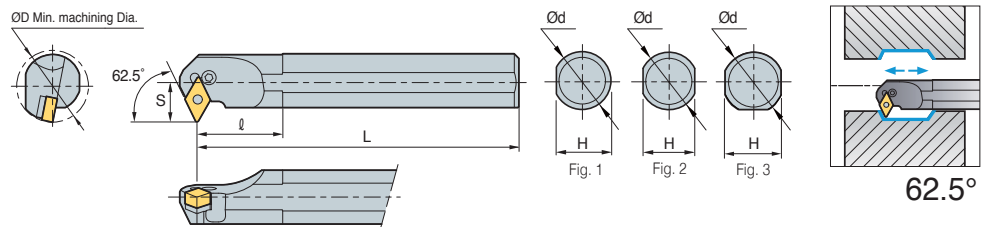

• R type insert (mm)

Designation	ØD	Ød	H	L	S	l	Insert	Lever	Screw	Shim	Shim Pin	Shim Pin Punch	Wrench	Fig.
S32S-PDSNR/L-15	40	32	30	250	22	50	DN□□1506□□	LV4B	VHX0821	SD42	SP4	LSPS4	HW30L	3
S40T-PDSNR/L-15	50	40	38	300	27	60								
S32S-PDSNR/L-15-3	40	32	30	250	22	50	DN□□1504□□	LV4	VHX0821	SD42	SP4	LSPS4	HW30L	
S40T-PDSNR/L-15-3	50	40	38	300	27	60								
A32S-PDSNR/L-15	40	32	30	250	22	50	DN□□1506□□	LV4B	VHX0821	SD42	SP4	LSPS4	HW30L	
A32S-PDSNR/L-15-3	40	32	30	250	22	50	DN□□1504□□	LV4	VHX0821	SD42	SP4	LSPS4	HW30L	

↻ Applicable inserts B36~B42



B Lever Lock System

PDSNR/L



DN□□

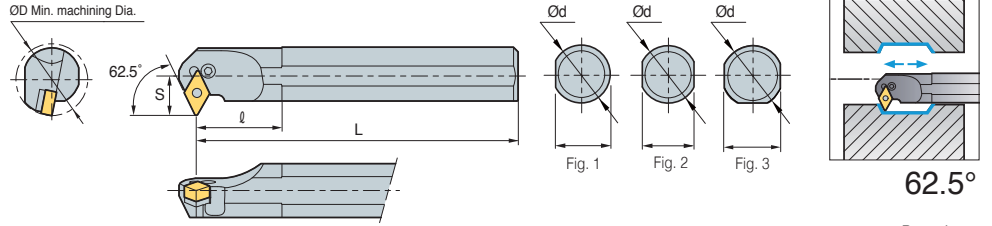

• R type insert (mm)

Designation	ØD	Ød	H	L	S	ℓ	Insert	Lever	Screw	Shim	Shim Pin	Shim Pin Punch	Wrench	Fig.
S32S-PDSNR/L-15N	40	32	30	250	22	50	DN□□1506□□	LV4BN	VHX0821	SD42N	SP4N	LSPS4	HW30L	3
S40T-PDSNR/L-15N	50	40	38	300	27	60								
S32S-PDSNR/L-15-3N	40	32	30	250	22	50	DN□□1504□□	LV4BN	VHX0821	SD42N	SP4N	LSPS4	HW30L	
S40T-PDSNR/L-15-3N	50	40	38	300	27	60								
A32S-PDSNR/L-15N	40	32	30	250	22	50	DN□□1506□□	LV4BN	VHX0821	SD42N	SP4N	LSPS4	HW30L	
A40T-PDSNR/L-15N	50	40	38	300	27	60								
A32S-PDSNR/L-15-3N	40	32	30	250	22	50	DN□□1504□□	LV4BN	VHX0821	SD42N	SP4N	LSPS4	HW30L	
A40T-PDSNR/L-15-3N	50	40	38	300	27	60								

↻ Applicable inserts B36-B42

PDUNR/L



DN□□

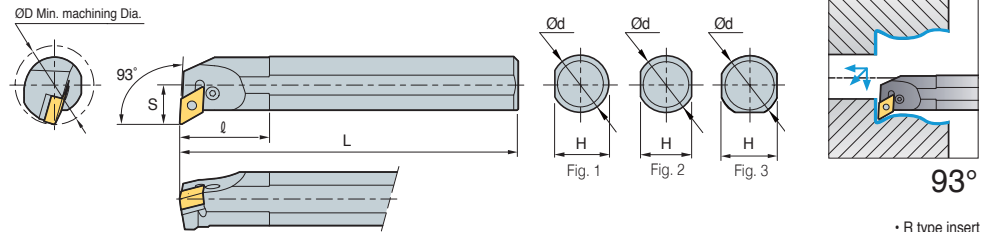

• R type insert (mm)

Designation	ØD	Ød	H	L	S	ℓ	Insert	Lever	Screw	Shim	Shim Pin	Shim Pin Punch	Wrench	Fig.
S32S-PDUNR/L-11	40	32	30	250	22	50	DN□□1104□□	LV3	VHX0617	SD317	SP3	LSPS3	HW25L	3
S32S-PDUNR/L-15	40	32	30	250	22	50								
S40T-PDUNR/L-15	50	40	38	300	27	60	DN□□1506□□	LV4B	VHX0821	SD42	SP4	LSPS4	HW30L	3
S50U-PDUNR/L-15	63	50	47	350	35	70								
S32S-PDUNR/L-15-3	40	32	30	250	22	50	DN□□1504□□	LV4	VHX0821	SD42	SP4	LSPS4	HW30L	3
S40T-PDUNR/L-15-3	50	40	38	300	27	60								
A32S-PDUNR/L-15	40	32	30	250	22	50	DN□□1506□□	LV4B	VHX0821	SD42	SP4	LSPS4	HW30L	3
A32S-PDUNR/L-15-3	40	32	30	250	22	50								
S20S-PDUNR/L-11N	25	20	18	250	13	32	DN□□1104□□	LV3DN	VHX0512BN	-	-	-	HW20L	2
S25R-PDUNR/L-11N	32	25	23	200	17	40								
S32S-PDUNR/L-11N	40	32	30	250	22	50	DN□□1506□□	LV3AN	VHX0617N	SD32N	SP3	LSPS3	HW30L	3
S32S-PDUNR/L-15N	40	32	30	250	22	50								
S32U-PDUNR/L-15N	40	32	30	350	22	50	DN□□1506□□	LV4BN	VHX0821N	SD42N	SP4N	LSPS4	HW30L	3
S40T-PDUNR/L-15N	50	40	38	300	27	60								
S50U-PDUNR/L-15N	63	50	47	350	35	70	DN□□1504□□	LV4BN	VHX0821N	SD43N	SP4N	LSPS4	HW30L	3
S32S-PDUNR/L-15-3N	40	32	30	250	22	50								
S40T-PDUNR/L-15-3N	50	40	38	300	27	60	DN□□1104□□	LV3DN	VHX0512BN	-	-	-	HW20L	1
A20S-PDUNR/L-11N	25	20	19	250	13	32								
A25R-PDUNR/L-11N	32	25	24	200	17	40	DN□□1104□□	LV3AN	VHX0617N	SD32N	SP3	LSPS3	HW30L	3
A32S-PDUNR/L-11N	40	32	30	250	22	50								
A32S-PDUNR/L-15N	40	32	30	250	22	50	DN□□1506□□	LV4BN	VHX0821N	SD42N	SP4N	LSPS4	HW30L	3
A40T-PDUNR/L-15N	50	40	38	300	27	60								
A50U-PDUNR/L-15N	63	50	47	350	35	70	DN□□1504□□	LV4BN	VHX0821N	SD43N	SP4N	LSPS4	HW30L	3
A32S-PDUNR/L-15-3N	40	32	30	250	22	50								
A40T-PDUNR/L-15-3N	50	40	38	300	27	60								

↻ Applicable inserts B36-B42



PSKNR/L



SN□□

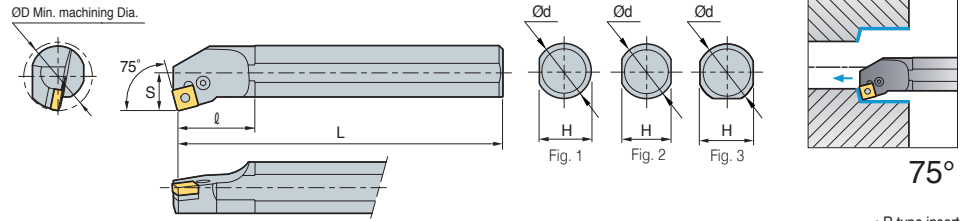

• R type insert (mm)

Designation	ØD	Ød	H	L	S	ℓ	Insert	Lever	Screw	Shim	Shim Pin	Shim Pin Punch	Wrench	Fig.
S25R-PSKNR/L-12	32	25	23	200	17	40	SN□□1204□□	LV4A	VHX0613A	-	-	-	HW30L	3
S32S-PSKNR/L-12	40	32	30	250	22	50		LV4	VHX0821	SS42B	SP4	LSPS4	HW30L	
S40T-PSKNR/L-12	50	40	38	300	27	60		LV4A	VHX0613A	-	SP4	-	HW25L	
A25R-PSKNR/L-12	32	25	24	200	17	40	SN□□1204□□	LV4	VHX0821	SS42B	SP4	LSPS4	HW30L	3
A32S-PSKNR/L-12	40	32	30	250	22	50		LV4AN	VHX0613N	-	-	-	HW25L	3
S25R-PSKNR/L-12N	32	25	23	200	17	40		LV4N	VHX0821N	SS42N	SP4N	LSPS4	HW30L	
S32S-PSKNR/L-12N	40	32	30	250	22	50	LV4AN	VHX0613N	-	-	-	HW25L	1	
S40T-PSKNR/L-12N	50	40	38	300	27	60	SN□□1204□□	LV4N	VHX0821N	SS42N	SP4N	LSPS4	HW30L	3
A25R-PSKNR/L-12N	32	25	24	200	17	40		LV4AN	VHX0613N	-	-	-	HW25L	1
A32S-PSKNR/L-12N	40	32	30	250	22	50		LV4N	VHX0821N	SS42N	SP4N	LSPS4	HW30L	3
A40T-PSKNR/L-12N	50	40	38	300	27	60								

↻ Applicable inserts B44~B52

PTFNR/L

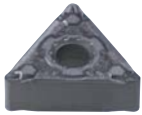

TN□□

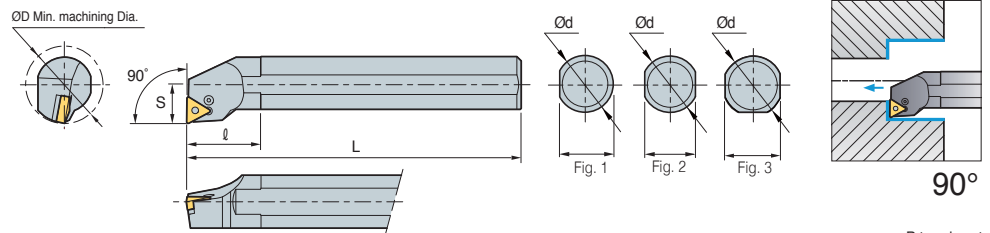

• R type insert (mm)

Designation	ØD	Ød	H	L	S	ℓ	Insert	Lever	Screw	Shim	Shim Pin	Shim Pin Punch	Wrench	Fig.
S16R-PTFNR/L-11	20	16	23	200	11	25	TN□□1103□□	LV2	VHX0509B	-	-	-	HW25L	1
S20S-PTFNR/L-11	25	20	30	250	13	32		LV3B	VHX0512B	-	-	-	HW20L	3
S25R-PTFNR/L-11	32	25	38	200	17	40		LV3	VHX0617	ST317B	SP3	LSPS3	HW25L	1
S25R-PTFNR/L-16	32	25	23	200	17	40	TN□□1604□□	LV3	VHX0617	ST317B	SP3	LSPS3	HW25L	1
S32S-PTFNR/L-16	40	32	30	250	22	50		LV3	VHX0617	ST317B	SP3	LSPS3	HW25L	3
S40T-PTFNR/L-16	50	40	38	300	27	60		LV3	VHX0617	ST317B	SP3	LSPS3	HW25L	3
A25R-PTFNR/L-16	32	25	24	200	17	40								
A32S-PTFNR/L-16	40	32	30	250	22	50								

↻ Applicable inserts B53~B59



B Lever Lock System

PWLNR/L



WN□□

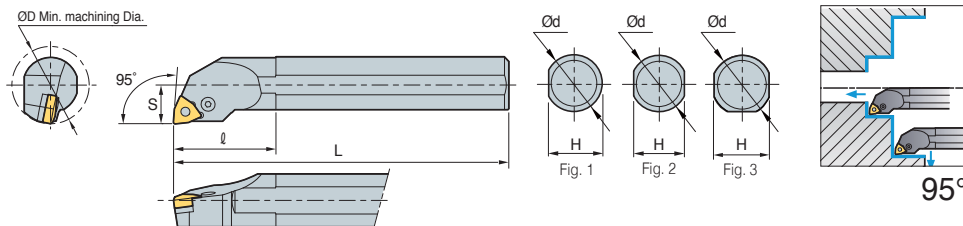

• R type insert (mm)

Designation	ØD	Ød	H	L	S	ℓ	Insert	Lever	Screw	Shim	Shim Pin	Shim Pin Punch	Wrench	Fig.
S16R-PWLNR/L-06	20	16	14	200	11	25	WNMG060408	LV3B	VHX0512B	-	-	-	HW20L	2
S20S-PWLNR/L-06	25	20	18	250	13	32	WN□□0604□□	LV3B	VHX0512B	-	-	-	HW20L	2
S25R-PWLNR/L-06	32	25	23	200	17	40		LV3	VHX0617	SW317	SP3	LSPS3	HW25L	3
S32S-PWLNR/L-06	40	32	30	250	22	50		LV4A	VHX0613A	-	-	-	HW25L	3
S25R-PWLNR/L-08	32	25	23	200	17	40	WN□□0804□□	LV4	VHX0821	SW42	SP4	LSPS3	HW30L	
S32S-PWLNR/L-08	40	32	30	250	22	50		WN□□0604□□	LV3N	VHX0617N	SW317N	SP3	LSPS3	HW25L
S25R-PWLNR/L-08N	32	25	23	200	17	40	WN□□0804□□	LV4AN	VHX0613N	-	-	-	HW25L	
S32S-PWLNR/L-08N	40	32	30	250	22	50		LV4N	VHX0820N	SW42N	SP4N	LSPS4	HW30L	

➔ Applicable inserts B62-B65



- Improved holders and parts ensure performance and durability
- “N” stand for New type (parts)



CKUNR/L



KN□□

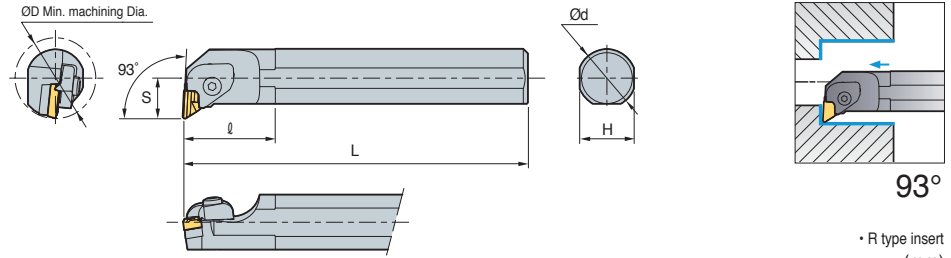

93°
• R type insert (mm)

Designation	ØD	Ød	H	L	S	ℓ	Insert	Clamp	Clamp Screw	Spring	Shim	Pin+Spring	Shim Screw	Wrench
S32S-CKUNR-16	40	32	30	250	22	70	KN□□1604□□L	CTH6LI	CHX0625	SR3	SK33CL	PN0515 SR4	SHX0310	HW40L HW20L
S40T-CKUNR-16	50	40	37	300	27	60								
S50U-CKUNR-16	63	50	43	350	35	55								
S32S-CKUNL-16	40	32	30	250	22	70	KN□□1604□□R	CTH6RI	CHX0625	SR3	SK33C	PN0515 SR4	SHX0310	HW40L HW20L
S40T-CKUNL-16	50	40	37	300	27	60								
S50U-CKUNL-16	63	50	43	350	35	55								

➔ Applicable inserts **B43**

• Use left handed insert for right handed holder

CSKPR/L

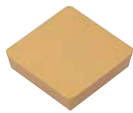

SP□□

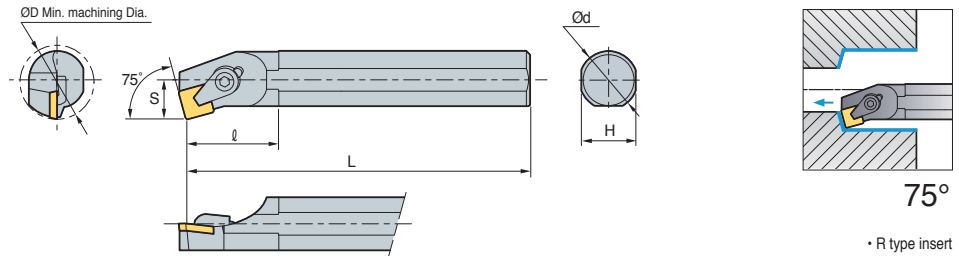

75°
• R type insert (mm)

Designation	ØD	Ød	H	L	S	ℓ	Insert	Clamp	Clamp Screw	C-ring	Wrench
S16R-CSKPR/L-09	20	16	15	200	11	30	SP□□0903□□	CH4R1C	CHX0414C	CR02C	HW25L
S20S-CSKPR/L-09	25	20	18	250	13	36					
S20S-CSKPR/L-12	25	20	18	250	13	28	SP□□1203□□	CH6R5	CH0616	CR04C	HW30L
S25R-CSKPR/L-12	32	25	23	300	17	40					

➔ Applicable inserts **B76~B77**

CTFPR/L



TP□□

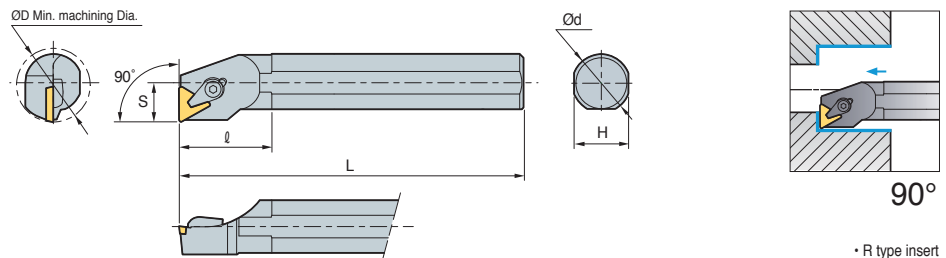

90°
• R type insert (mm)

Designation	ØD	Ød	H	L	S	ℓ	Insert	Clamp	Clamp Screw	C-ring	Shim	Shim Pin	Wrench
S12M-CTFPR/L-11	16	12	11	150	9	26	TP□□1103□□L	CH4R1C	CHX0414C	CR02C	-	-	HW25L
S16R-CTFPR/L-11	20	16	15	200	11	40							
S20S-CTFPR/L-11	25	20	18	250	13	40							
S16R-CTFPR/L-16	20	16	15	200	11	40	TP□□1603□□L	CH5R5C	CHX0519C	CR03C	-	-	HW30L
S20S-CTFPR/L-16	25	20	18	250	13	40							
S25R-CTFPR/L-16	32	25	23	200	17	40							
S32S-CTFPR/L-16	40	32	30	250	22	45	TP□□2204□□L	CH6R5	CHX0622C	CR04C	ST32C	SP3C	-
S40T-CTFPR/L-16	50	40	37	300	27	60							
S40T-CTFPR/L-22	50	40	37	300	27	60							

➔ Applicable inserts **B81~B83**



B Multi Lock System

MCLNR/L



CN□□

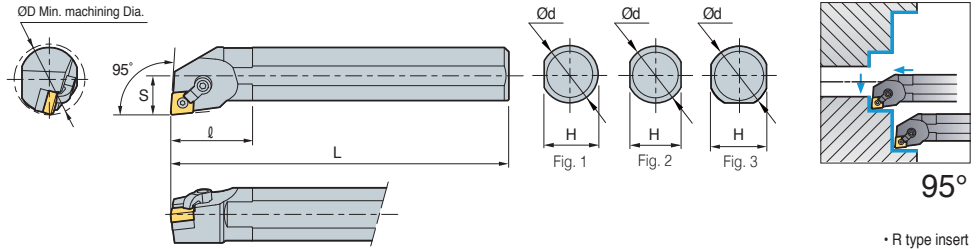

• R type insert (mm)

Designation	ØD	Ød	H	L	S	ℓ	Insert	Clamp	Clamp Screw	Shim	Shim Pin	Wrench	Fig.
S20S-MCLNR/L-09	25	20	18	200	13	32	CN□□0903□□	CDH7N	DHA10/32-19	-	SP3D3	HW19.8L HW23.8L	2
S25R-MCLNR/L-09	32	25	23	250	17	40							3
S25R-MCLNR/L-12	32	25	23	200	17	40	CN□□1204□□	CDH6N	DHA1/4-21	SC43D	SP4DS	HW31.8L HW23.8L	3
S32S-MCLNR/L-12	40	32	30	250	22	50							3
S40T-MCLNR/L-12	50	40	38	300	27	60	CN□□1204□□	CDH6N	DHA1/4-21	SC43D	SP4DS	HW31.8L HW23.8L	1
A25R-MCLNR/L-12	32	25	24	200	17	40							3
A32S-MCLNR/L-12	40	32	31	250	22	50							3

➔ Applicable inserts B28~B35

MDUNR/L



DN□□

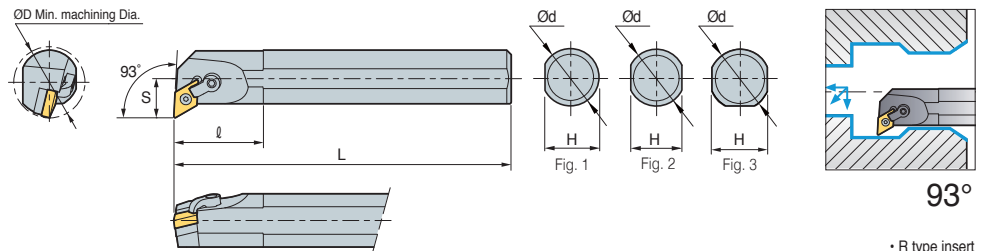

• R type insert (mm)

Designation	ØD	Ød	H	L	S	ℓ	Insert	Clamp	Clamp Screw	Shim	Shim Pin	Wrench	Fig.
S32S-MDUNR/L-15-3	40	32	30	250	22	50	DN□□1504□□	CDH6N	DHA1/4-21	SD43D	SP4D	HW31.8L HW23.8L	3
S40T-MDUNR/L-15-3	50	40	38	300	27	60							3
A32S-MDUNR/L-15-3	40	32	30	250	22	50							3

➔ Applicable inserts B36~B42

MSKNR/L



SN□□

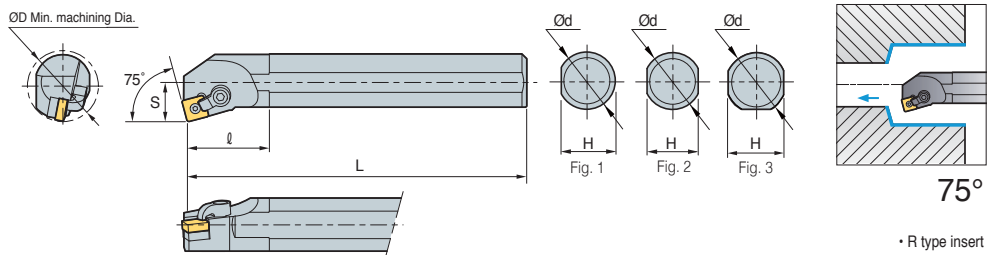

• R type insert (mm)

Designation	ØD	Ød	H	L	S	ℓ	Insert	Clamp	Clamp Screw	Shim	Shim Pin	Wrench	Fig.
S25R-MSKNR/L-12	32	25	23	200	17	40	SN□□1204□□	CDH8N1	DHA5/16-28	SS43D	SP4DS	HW39.7L HW23.8L	3
S32S-MSKNR/L-12	40	32	30	250	22	50							3
S40T-MSKNR/L-12	50	40	38	300	27	60	SN□□1204□□	CDH8N1	DHA5/16-28	SS43D	SP4DS	HW39.7L HW23.8L	1
A25R-MSKNR/L-12	32	25	23	200	17	40							3
A32S-MSKNR/L-12	40	32	30	250	22	50							3
A40T-MSKNR/L-12	50	40	38	300	27	60							

➔ Applicable inserts B44~B52



MTFNR/L

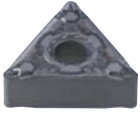

TN□□

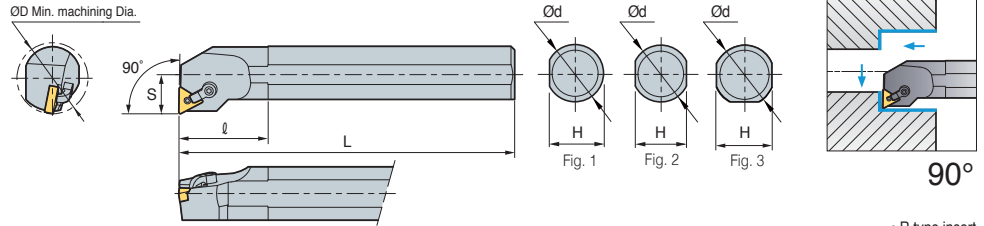

• R type insert (mm)

Designation	ØD	Ød	H	L	S	ℓ	Insert	Clamp	Clamp Screw	Shim	Shim Pin	Wrench	Fig.
S25R-MTFNR/L-16	32	25	23	200	17	40	TN□□1604□□	CDH7N1	DHA10-32-19	-	SP3D3	HW23.8L	3
S32S-MTFNR/L-16	40	32	30	250	22	50							
S40T-MTFNR/L-16	50	40	38	300	27	60	TN□□1604□□	CDH7N1	DHA10-32-19	-	SP3D3	HW23.8L	1
A25R-MTFNR/L-16	32	25	24	200	17	40							
A32S-MTFNR/L-16	40	32	30	250	22	50		CDH7N1	DHA10-32-19	ST32D	SP3D	HW19.8L	3

➔ Applicable inserts B53~B59

MVUNR/L



VN□□

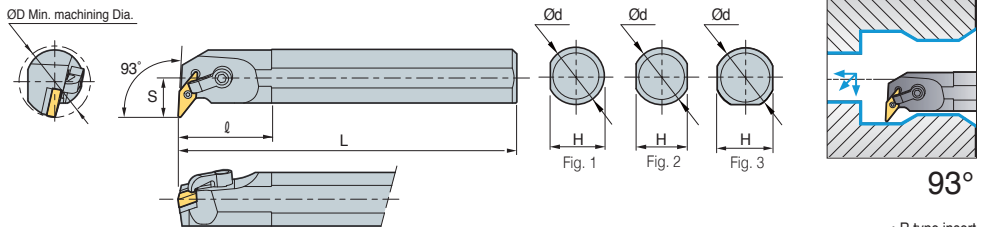

• R type insert (mm)

Designation	ØD	Ød	H	L	S	ℓ	Insert	Clamp	Clamp Screw	Shim	Shim Pin	Wrench	Fig.
S32S-MVUNR/L-16	40	32	30	250	22	50	VN□□1604□□	CDH8N2	DHA5/16-28	SV32D	SP3D	HW39.7L	3
S40T-MVUNR/L-16	50	40	38	300	27	60							
A32S-MVUNR/L-16	40	32	30	250	22	50	VN□□1604□□	CDH8N2	DHA5/16-28	SV32D	SP3D	HW39.7L	3
A40T-MVUNR/L-16	50	40	38	300	27	60							

➔ Applicable inserts B60~B61

MWLNR/L

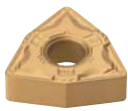

WN□□

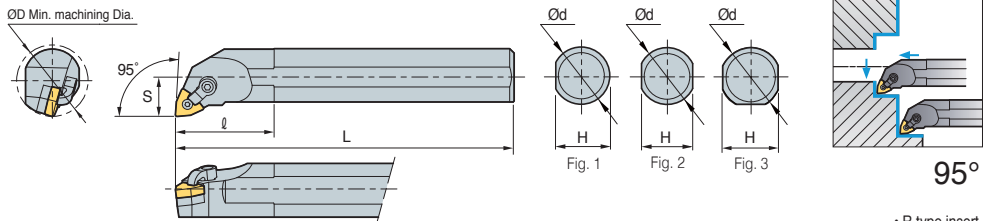

• R type insert (mm)

Designation	ØD	Ød	H	L	S	ℓ	Insert	Clamp	Clamp Screw	Shim	Shim Pin	Wrench	Fig.			
S25R-MWLNR/L-06	32	25	23	200	17	40	WN□□0604□□	CDH7N	DHA10/32-19	-	SP3D3	HW23.8L	3			
S32S-MWLNR/L-06	40	32	30	250	22	50								SW32D	SP3D	HW19.8L
S40T-MWLNR/L-06	50	40	38	300	27	60								SW32D	SP3D	HW19.8L
S25R-MWLNR/L-08	32	25	23	200	17	40	WN□□0804□□	CDH6N	DHA1/4-21	-	SP4DS	HW31.8L	3			
S32S-MWLNR/L-08	40	32	30	250	22	50								SW43D	SP4D	HW23.8L
S40T-MWLNR/L-08	50	40	38	300	27	60								SW43D	SP4D	HW23.8L
A25R-MWLNR/L-06	32	25	24	200	17	40	WN□□0604□□	CDH7N	DHA10/32-19	-	SP3D3	HW31.8L	1			
A32S-MWLNR/L-06	40	32	31	250	22	50								SW32D	SP3D	HW19.8L
A25R-MWLNR/L-08	32	25	24	200	17	40	WN□□0804□□	CDH6N	DHA1/4-21	-	SP4DS	HW31.8L	1			
A32S-MWLNR/L-08	40	32	31	250	22	50								SW43D	SP4D	HW23.8L

➔ Applicable inserts B62~B65



SCLCR/L

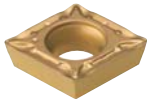

CC□□

ØD Min. machining Dia.

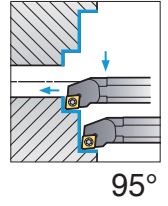
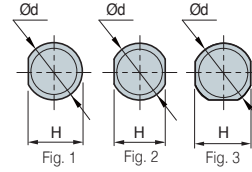
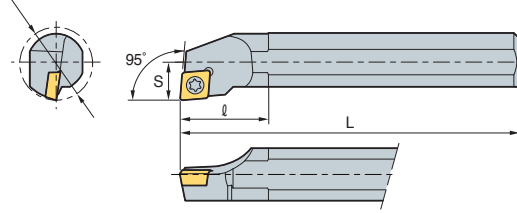

95°

• R type insert (mm)

Steel shank type

Designation	ØD	Ød	H	L	S	l	Insert	Screw	Shim	Shim Screw	Wrench	Fig.
S08K-SCLCR/L-06	11	8	7.2	125	6	12	CC□□0602□□	FTKA02555			TW07	2
S10K-SCLCR/L-06	13	10	9	125	7	16		FTKA02565	-	-	TW07P	
S10M-SCLCR/L-06	13	10	9	150	7	16						
S12M-SCLCR/L-06	16	12	11	150	9	20						
S16R-SCLCR/L-06	20	16	14	200	11	25	CC□□09T3□□	FTGA03508	-	-	TW15P	2
S12M-SCLCR/L-09	16	12	11	150	9	20		FTGA03510			TW15P	
S16R-SCLCR/L-09	20	16	14	200	11	25						
S20S-SCLCR/L-09	25	20	18	250	13	32						
S25R-SCLCR/L-09	32	25	23	200	17	40	CC□□1204□□	FTGA0411F	-	-	TW15P	3
S25R-SCLCR/L-12	32	25	23	200	17	40		FTGA0411F	SC42S	SHXN0610F	HW40L TW15P	
S32S-SCLCR/L-12	40	32	30	250	22	50						
S40T-SCLCR/L-12	50	40	38	300	27	60						
A08F-SCLCR/L-06	11	8	7.6	80	6	12	CC□□0602□□	FTKA02555	-	-	TW07P	1
A10H-SCLCR/L-06	13	10	9.5	100	7	16		FTKA02565	-	-	TW07P	
A12K-SCLCR/L-06	16	12	11.5	125	9	20	CC□□09T3□□	FTGA03508	-	-	TW15P	1
A12K-SCLCR/L-09	16	12	11.5	125	9	20						
A16M-SCLCR/L-09	20	16	15	150	11	25						
A20Q-SCLCR/L-09	25	20	19	180	13	32						
A25R-SCLCR/L-09	32	25	24	200	17	40	CC□□1204□□	FTGA0411F	-	-	TW15P	1
A25R-SCLCR/L-12	32	25	24	200	17	40		FTGA0411F	SC42S	SHXN0610F	HW40L,TW15P	
A32S-SCLCR/L-12	40	32	31	250	22	50						

Carbide shank type

Designation	ØD	Ød	H	L	S	Insert	Screw	Wrench	Fig.
C04G-SCLCR/L-03	5	4	3.8	90	2.5	CC□T0301□□	FTNA01633	TW06P	1
C05H-SCLCR/L-03	6	5	4.4	100	3				
C06H-SCLCR/L-04	7	6	5.4	100	3.5	CC□T0401□□	FTNA0238	TW06P	1
C07K-SCLCR/L-04	8	7	6.4	125	4				
C08K-SCLCR/L-06	10	8	7	125	5	CC□T0602□□	FTKA02555	TW07P	2
C10K-SCLCR/L-06	12	10	9	125	6				
C10M-SCLCR/L-06	12	10	9	150	6				
C12M-SCLCR/L-06	14	12	11	150	7				
C12Q-SCLCR/L-06	14	12	11	180	7				
C12M-SCLCR/L-09	15	12	11	150	8				
C12Q-SCLCR/L-09	15	12	11	180	8	CC□T09T3□□	FTGA03508	TW15P	2
C16R-SCLCR/L-09	20	16	15	200	10				
C16S-SCLCR/L-09	20	16	15	250	10				
C20R-SCLCR/L-09	25	20	18	200	13				
C20S-SCLCR/L-09	25	20	18	250	13				
C25T-SCLCR/L-12	32	25	23	300	17				
E06H-SCLCR/L-04	7	6	5.4	100	3.5	CC□T0401□□	FTNA0238	TW06P	1
E07K-SCLCR/L-04	8	7	6.4	125	4				
E08K-SCLCR/L-06	10	8	7	125	5	CC□T0602□□	FTKA02555	TW07P	2
E10K-SCLCR/L-06	12	10	9	125	6				
E10M-SCLCR/L-06	12	10	9	150	6				
E12M-SCLCR/L-06	14	12	11	150	7				
E12Q-SCLCR/L-06	14	12	11	180	7				
E12M-SCLCR/L-09	15	12	11	150	8				
E12Q-SCLCR/L-09	15	12	11	180	8	CC□T09T3□□	FTGA03508	TW15P	2
E16R-SCLCR/L-09	20	16	15	200	11				
E16S-SCLCR/L-09	20	16	15	250	10				
E20R-SCLCR/L-09	25	20	18	200	13				
E20S-SCLCR/L-09	25	20	19	250	13				
E25T-SCLCR/L-12	32	25	23	300	17				

Applicable inserts B66~B68



SCLPR/L

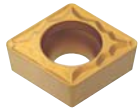

CP□□

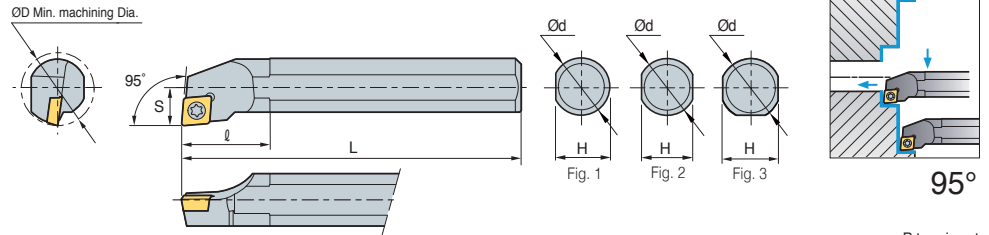

Steel shank type

• R type insert (mm)

Designation	Stock		ØD	Ød	H	L	S	ℓ	Insert	Screw	Wrench	Fig.
	R	L										
S10M-SCLPR/L-08	●		13	10	9	150	7	16	CP□□0802□□	FTNA0305	TW09P	2
S12M-SCLPR/L-08	●		16	12	11	150	9	20		FTNA0307	TW09P	
S16N-SCLPR/L-09	●		20	16	14	160	11	25	CP□□0903□□	FTNA0408	TW15P	2
S16R-SCLPR/L-09	●		20	16	14	200	11	25				
S20N-SCLPR/L-09	●		25	20	18	160	13	32				
S20S-SCLPR/L-09	●		25	20	18	250	13	32				3
A10H-SCLPR/L-08			12	10	9.65	100	6	-	CP□□0802□□	FTNA0305	TW09P	1
A12K-SCLPR/L-08			16	12	11.5	125	9	20		FTNA0307	TW09P	
A16M-SCLPR/L-09			20	16	15.5	150	10	25	CP□□0903□□	FTNA0408	TW15P	1
A20Q-SCLPR/L-09			25	20	19	180	13	32				3

● : Stock item

Carbide shank type

(mm)

Designation	Stock		ØD	Ød	H	L	S	Insert	Screw	Wrench	Fig.
	R	L									
C10K-SCLPR/L-08	●		12	10	9	125	6	CP□T0802□□	FTNA0305	TW09P	2
C10M-SCLPR/L-08	●		12	10	9	150	6		FTNA0306	TW09P	
C12M-SCLPR/L-08	●		15	12	11	150	7.5	CP□T0903□□	FTNA0408	TW15P	2
C12Q-SCLPR/L-08	●		15	12	11	180	7.5				
C12M-SCLPR/L-09	●		15	12	11	150	8				
C12Q-SCLPR/L-09	●		15	12	11	180	8				
C16R-SCLPR/L-09	●		20	16	15	200	10	CP□T0802□□	FTNA0305	TW09P	2
C16S-SCLPR/L-09	●		20	16	15	250	10				
C20R-SCLPR/L-09	●		25	20	18	200	13				
C20S-SCLPR/L-09	●		25	20	18	250	13	CP□T0903□□	FTNA0407	TW09P	2
E10K-SCLPR/L-08			12	10	9	125	6				
E10M-SCLPR/L-08			12	10	9	150	6				
E12M-SCLPR/L-08			15	12	11	150	7.5	CP□T0802□□	FTNA0305	TW09P	2
E12Q-SCLPR/L-08			15	12	11	180	7.5				
E12M-SCLPR/L-09			15	12	11	150	8				
E12Q-SCLPR/L-09			15	12	11	180	8				
E16R-SCLPR/L-09			20	16	15	200	10	CP□T0903□□	FTNA0408	TW15P	2
E16S-SCLPR/L-09			20	16	15	250	10				
E20R-SCLPR/L-09			25	20	18	200	13				
E20S-SCLPR/L-09	●		25	20	18	250	13				

● : Stock item

➔ Applicable inserts B70



SDQCR/L

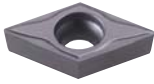

DC□□

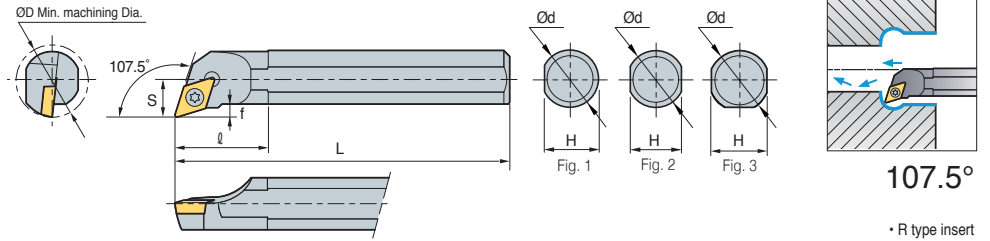

Steel shank type

Designation	ØD	Ød	H	L	S	ℓ	Insert	Screw	Wrench	Fig.
S10M-SDQCR/L-07	13	10	9	150	7	16	DC□□0702□□	FTKA02555	TW07P	2
S12M-SDQCR/L-07	16	12	11	150	9	20		FTKA02565	TW07P	
S16R-SDQCR/L-07	20	16	14	200	11	25		DC□□11T3□□	FTGA03508	TW15P
S16R-SDQCR/L-11	20	16	14	200	11	25	FTGA03510		TW15P	3
S20S-SDQCR/L-11	25	20	18	250	13	32	DC□□0702□□		FTKA02555	TW07P
S25R-SDQCR/L-11	32	25	23	200	17	40		FTKA02565	TW07P	1
A10H-SDQCR/L-07	13	10	9.5	100	7	16	DC□□11T3□□	FTGA03508	TW15P	1
A12K-SDQCR/L-07	16	12	11.5	125	9	20		FTGA03510	TW15P	1
A16M-SDQCR/L-11	20	16	15	150	11	25	DC□□0702□□	FTKA02555	TW07P	2
A20Q-SDQCR/L-11	25	20	19	180	13	32		FTKA02565	TW07P	
A25R-SDQCR/L-11	32	25	24	200	17	40	DC□□11T3□□	FTGA03508	TW15P	2
								FTGA03510	TW15P	

Carbide shank type

Designation	ØD	Ød	H	L	S	Insert	Screw	Wrench	Fig.
C08K-SDQCR/L-07	10	8	7	125	6	DC□T0702□□	FTKA02555	TW07P	2
C10K-SDQCR/L-07	13	10	9	125	7		FTKA02565	TW07P	
C12M-SDQCR/L-07	16	12	11	150	9		DC□T11T3□□	FTGA03508	TW15P
C16R-SDQCR/L-07	20	16	15	200	11	FTGA03510		TW15P	
C16R-SDQCR/L-11	20	16	15	200	11	DC□T0702□□		FTKA02555	TW07P
C20R-SDQCR/L-11	25	20	18	200	13		FTKA02565	TW07P	
C20S-SDQCR/L-11	25	20	18	250	13	DC□T11T3□□	FTGA03508	TW15P	2
E08K-SDQCR/L-07	10	8	7	125	6		FTGA03510	TW15P	
E10K-SDQCR/L-07	13	10	9	125	7	DC□T0702□□	FTKA02555	TW07P	2
E12M-SDQCR/L-07	16	12	11	150	9		FTKA02565	TW07P	
E16R-SDQCR/L-07	20	16	15	200	11	DC□T11T3□□	FTGA03508	TW15P	2
E16R-SDQCR/L-11	20	16	15	200	11		FTGA03510	TW15P	
E20R-SDQCR/L-11	25	20	18	200	13	DC□T0702□□	FTKA02555	TW07P	2
E20S-SDQCR/L-11	25	20	19	250	13		FTKA02565	TW07P	

Applicable inserts B71~B73, B92



SDUCR/L



DC□□

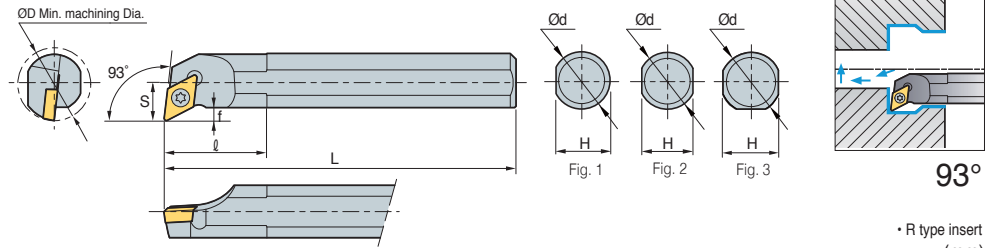

Steel shank type

* R type insert (mm)

Designation	ØD	Ød	H	L	S	l	Insert	Screw	Wrench	Fig.
S10M-SDUCR/L-07	13	10	9	150	7	16	DC□□0702□□	FTKA02555	TW07P	2
S12M-SDUCR/L-07	16	12	11	150	9	20		FTKA02565	TW07P	2
S16R-SDUCR/L-07	20	16	14	200	11	25		DC□□11T3□□	FTGA03508	TW15P
S16R-SDUCR/L-11	20	16	14	200	11	25	FTGA03510		TW15P	3
S20S-SDUCR/L-11	25	20	18	250	13	32	DC□□0702□□		FTKA02555	TW07P
S25R-SDUCR/L-11	32	25	23	200	17	40		FTKA02565	TW07P	1
S32S-SDUCR/L-11	40	32	30	250	22	50		FTGA03508	TW15P	1
A25R-SDUCR/L-11	32	25	24	200	17	40	FTGA03510	TW15P	1	

Carbide shank type

(mm)

Designation	ØD	Ød	H	L	S	Insert	Screw	Wrench	Fig.	
C10K-SDUCR/L-07	13	10	9	125	7	DC□T0702□□	FTKA02555	TW07P	2	
C10M-SDUCR/L-07	13	10	9	150	7		FTKA02565	TW07P		
C12M-SDUCR/L-07	16	12	11	150	9		DC□T11T3□□	FTGA03508		TW15P
C12Q-SDUCR/L-07	16	12	11	180	9			FTGA03510		TW15P
C16R-SDUCR/L-07	20	16	15	200	11			DC□T0702□□		FTKA02555
C16S-SDUCR/L-07	20	16	15	250	11	FTKA02565	TW07P			
C16R-SDUCR/L-11	20	16	15	200	11	DC□T11T3□□	FTGA03508		TW15P	
C16S-SDUCR/L-11	20	16	15	250	11		FTGA03510		TW15P	
C20R-SDUCR/L-11	25	20	18	200	13		DC□T0702□□		FTKA02555	TW07P
C20S-SDUCR/L-11	25	20	18	250	13	FTKA02565		TW07P		
C25T-SDUCR/L-11	32	25	23	300	17	DC□T11T3□□		FTGA03508	TW15P	
E10K-SDUCR/L-07	13	10	9	125	7			FTGA03510	TW15P	
E10M-SDUCR/L-07	13	10	9	150	7			DC□T11T3□□	FTGA03508	TW15P
E12M-SDUCR/L-07	16	12	11	150	9	DC□T0702□□	FTKA02555		TW07P	
E12Q-SDUCR/L-07	16	12	11	180	9		FTKA02565		TW07P	
E16R-SDUCR/L-07	20	16	15	200	11		DC□T11T3□□		FTGA03508	TW15P
E16S-SDUCR/L-07	20	16	15	250	11	FTGA03510			TW15P	
E16R-SDUCR/L-11	20	16	15	200	11	DC□T0702□□		FTKA02555	TW07P	2
E16S-SDUCR/L-11	20	16	15	250	11		FTKA02565	TW07P		
E20R-SDUCR/L-11	25	20	18	200	13		DC□T11T3□□	FTGA03508	TW15P	
E20S-SDUCR/L-11	25	20	18	250	13	FTGA03510		TW15P		
E25T-SDUCR/L-11	32	25	23	300	17					

Applicable inserts B71~B73, B92



SDZCR/L



DC□□

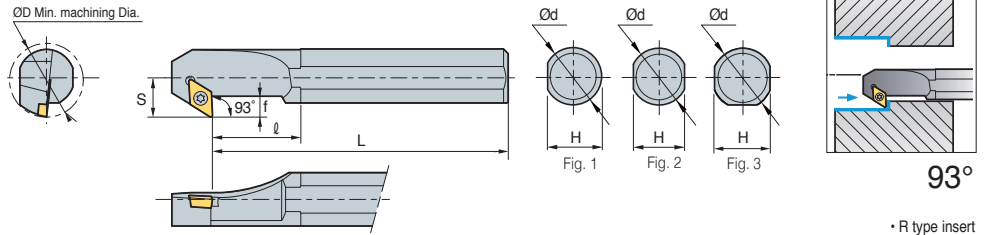

93°

• R type insert (mm)

Designation	ØD	Ød	H	L	S	l	f	Insert	Screw	Shim	Shim Screw	Wrench	Fig.
S16R-SDZCR/L-07	20	16	14	200	11	25	6.5	DC□□0702□□	FTKA02565	-	-	TW07P	2
S20S-SDZCR/L-07	25	20	18	250	13	32	7.5		-	-	-	-	-
S25R-SDZCR/L-11	32	25	23	200	17	40	9	DC□□11T3□□	FTGA03510	-	-	TW15P	3
S32S-SDZCR/L-11	40	32	30	250	22	50	11		FTGA03512	SD32S	SHXN0509F	TW15P, HW35L	
S40T-SDZCR/L-11	50	40	38	300	27	60	11		FTGA03510	-	-	TW15P	1
A25R-SDZCR/L-11	32	25	24	200	17	40	9		FTGA03512	SD32S	SHXN0509F	TW15P, HW35L	3
A32S-SDZCR/L-11	40	32	30	250	22	50	11						

➔ Applicable inserts B71~B73, B92

SSKCR/L



SC□□

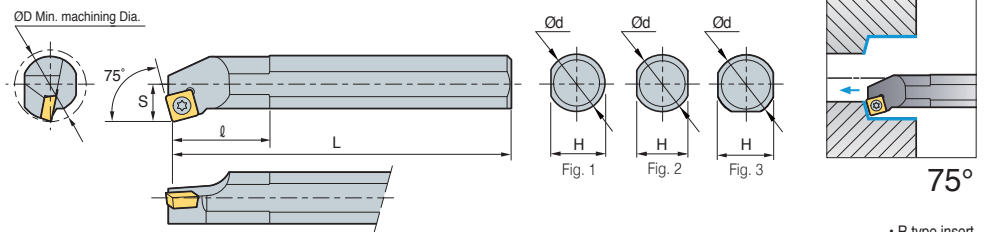

75°

• R type insert (mm)

Designation	ØD	Ød	H	L	S	l	Insert	Screw	Shim	Shim Screw	Wrench	Fig.
S12M-SSKCR/L-09	16	12	11	150	9	20	SC□□09T3□□	FTGA03507	-	-	TW15P	2
S16R-SSKCR/L-09	20	16	14	200	11	25		FTGA03508	-	-	TW15P	
S20S-SSKCR/L-09	25	20	18	250	13	32	SC□□1204□□	FTGA0411F	-	-	TW15P	3
S25R-SSKCR/L-12	32	25	23	200	17	40		FTGA0411F	SS42S	SHXN0610F	TW15P, HW40L	
S32S-SSKCR/L-12	40	32	30	250	22	50						
A12K-SSKCR/L-09	16	12	11.5	125	9	20	SC□□09T3□□	FTGA03507	-	-	TW15P	1
A16M-SSKCR/L-09	20	16	15	150	11	25		FTGA03508	-	-	TW15P	
A20Q-SSKCR/L-09	25	20	19	180	13	32	SC□□1204□□	FTGA0411F	-	-	TW15P	3
A25R-SSKCR/L-12	32	25	24	200	17	40		FTGA0411F	SS42S	SFXN0610F	TW15P, HW40L	
A32S-SSKCR/L-12	40	32	30	250	22	50						

➔ Applicable inserts B74~B75, B94

SSKPR/L



SP□□

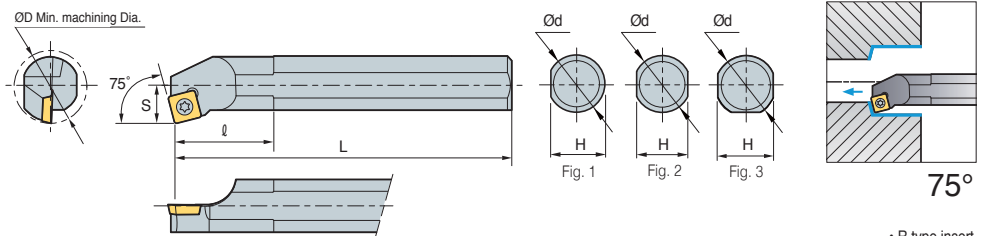

75°

• R type insert (mm)

Designation	ØD	Ød	H	L	S	l	Insert	Screw	Wrench	Fig.
S12M-SSKPR/L-09	16	12	11	150	9	20	SP□□09T3□□	FTNA0307	TW09P	2
S16N-SSKPR/L-09	20	16	14	160	11	25				
S16R-SSKPR/L-09	20	16	14	200	11	25				
S20N-SSKPR/L-09	25	20	18	160	13	32				
S20S-SSKPR/L-09	25	20	18	250	13	32	SP□□09T3□□	FTNA0307	TW09P	1
A12K-SSKPR/L-09	16	12	11.5	125	9	20				
A16M-SSKPR/L-09	20	16	15	150	11	25				
A20Q-SSKPR/L-09	25	20	19	180	13	32				

➔ Applicable inserts B76~B77

• Use left handed insert for right handed holder



STFCR/L



TC□□

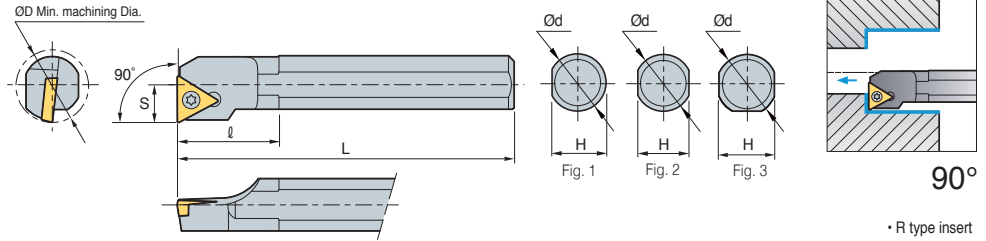

Steel shank type

• R type insert (mm)

Designation	ØD	Ød	H	L	S	ℓ	Insert	Screw	Shim	Shim Screw	Wrench	Fig.
S10M-STFCR/L-09	13	10	9	150	7	16	TC□□0902□□	FTKA02206	-	-	TW06P	2
S12M-STFCR/L-09	16	12	11	150	9	20	TC□□1102□□	FTKA02565	-	-	TW07P	2
S12M-STFCR/L-11	16	12	11	150	9	20						
S16R-STFCR/L-11	20	16	14	200	11	25	TC□□16T3□□	FTGA03510	-	-	TW15P	2
S20S-STFCR/L-11	25	20	18	250	13	32						3
S20S-STFCR/L-16	25	20	18	250	13	32	TC□□16T3□□	FTGA03512	ST32S	SHXN0509F	TW15P, HW35L	3
S25R-STFCR/L-16	32	25	23	200	17	40						3
S32S-STFCR/L-16	40	32	30	250	22	50	TC□□0902□□	FTKA02206	-	-	TW06P	1
S40T-STFCR/L-16	50	40	38	300	27	60						
A10H-STFCR/L-09	13	10	9.5	100	7	16	TC□□1102□□	FTKA02565	-	-	TW07P	1
A12K-STFCR/L-09	16	12	11.5	125	9	20						
A12K-STFCR/L-11	16	12	11.5	125	9	20	TC□□16T3□□	FTKA03510	-	-	TW15P	1
A16M-STFCR/L-11	20	16	15	150	11	25						
A20Q-STFCR/L-11	25	20	19	180	13	32	TC□□16T3□□	FTGA03512	ST32S	SHXN0509F	TW15P, HW35L	3
A25R-STFCR/L-16	32	25	24	200	17	40						
A32S-STFCR/L-16	40	32	30	250	22	50						

Carbide shank type

(mm)

Designation	ØD	Ød	H	L	S	Insert	Screw	Wrench	Fig.
C08K-STFCR/L-09	10	8	7	125	5	TC□T0902□□	FTKA02206	TW06P	2
C10K-STFCR/L-09	12	10	9	125	6				
C10K-STFCR/L-11	12	10	9	125	6	TC□T1102□□	FTKA02565	TW07P	
C12M-STFCR/L-11	15	12	11	150	8				
C16R-STFCR/L-11	20	16	15	200	10				
C20R-STFCR/L-11	25	20	18	200	13				
C20S-STFCR/L-11	25	20	18	250	13	TC□T16T3□□	FTGA03510	TW15P	
C20R-STFCR/L-16	25	20	18	200	13				
C20S-STFCR/L-16	25	20	18	250	13	TC□T0902□□	FTKA02206	TW06P	
E08K-STFCR/L-09	10	8	7	125	5				
E10K-STFCR/L-09	12	10	9	125	6	TC□T1102□□	FTKA02565	TW07P	2
E10K-STFCR/L-11	12	10	9	125	6				
E12M-STFCR/L-11	15	12	11	150	8				
E16R-STFCR/L-11	20	16	15	200	11				
E20R-STFCR/L-11	25	20	18	200	13	TC□T16T3□□	FTGA03510	TW15P	
E20S-STFCR/L-11	25	20	18	250	13				
E20R-STFCR/L-16	25	20	18	200	13				
E20S-STFCR/L-16	25	20	19	250	13				

Applicable inserts B79~B80, B95



STFPR/L



TP□□

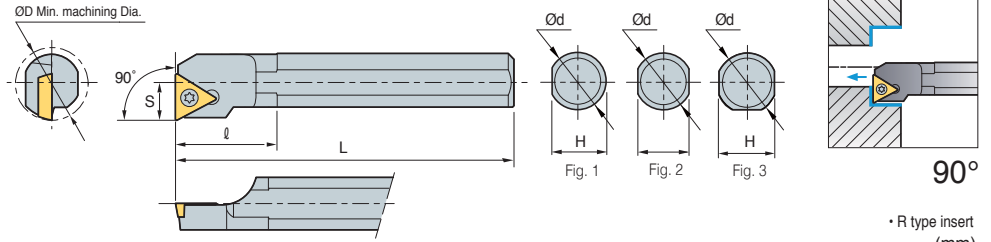

Steel shank type

Designation	ØD	Ød	H	L	S	ℓ	Insert	Screw	Wrench	Fig.
S10M-STFPR/L-11	13	10	9	150	7	16	TP□□1103□□	FTGA03507	TW15P	2
S12M-STFPR/L-11	16	12	11	150	9	20		FTGA03508	TW15P	2
S16N-STFPR/L-11	20	16	14	160	11	25				
S16R-STFPR/L-11	20	16	14	200	11	25	TP□□1604□□	FTGA0411F	TW15P	2
S20N-STFPR/L-16	25	20	18	160	13	32				
S20S-STFPR/L-16	25	20	18	250	13	32				
A10H-STFPR/L-11	13	10	9.5	100	7	16	TP□□1103□□	FTGA03507	TW15P	1
A12K-STFPR/L-11	16	12	11	125	9	20		FTGA03508	TW15P	1
A16M-STFPR/L-11	20	16	15	150	11	25				
A20Q-STFPR/L-16	25	20	19	180	13	32	TP□□1604□□	FTGA0411F	TW15P	1

Carbide shank type

Designation	ØD	Ød	H	L	S	Insert	Screw	Wrench	Fig.		
C08K-STFPR/L-08	10	8	7	125	5	TP□T1103□□	FTNA02205	TW06P	2		
C10K-STFPR/L-11	12	10	9	125	6		FTNA0305	TW09P			
C10M-STFPR/L-11	12	10	9	150	6						
C12M-STFPR/L-11	15	12	11	150	8		FTNA0307	TW09P			
C12Q-STFPR/L-11	15	12	11	180	8						
C16R-STFPR/L-11	20	16	15	200	10						
C16S-STFPR/L-11	20	16	15	250	10		TP□T1604□□	FTNA0408		TW15P	
C20R-STFPR/L-11	25	20	18	200	13						
C20S-STFPR/L-11	25	20	18	250	13						
C20R-STFPR/L-16	25	20	18	200	13	TP□T1103□□	FTNA02205	TW06P	2		
C20S-STFPR/L-16	25	20	18	250	13						
C25T-STFPR/L-16	32	25	23	300	17						
E08K-STFPR/L-08	10	8	7	125	5					FTNA0305	TW09P
E10K-STFPR/L-11	12	10	9	125	6						
E10M-STFPR/L-11	12	10	9	150	6					FTNA0307	TW09P
E12M-STFPR/L-11	15	12	11	150	8						
E12Q-STFPR/L-11	15	12	11	180	8						
E16R-STFPR/L-11	20	16	15	200	10					TP□T1604□□	FTNA0408
E16S-STFPR/L-11	20	16	15	250	10						
E20R-STFPR/L-11	25	20	18	200	13						
E20S-STFPR/L-11	25	20	18	250	13	TP□T1604□□	FTNA0408	TW15P			
E20R-STFPR/L-16	25	20	18	200	13						
E20S-STFPR/L-16	25	20	18	250	13						
E25T-STFPR/L-16	32	25	23	300	17						

Applicable inserts B81~B83

Use left handed insert for right handed holder



STWPR/L



TP□□

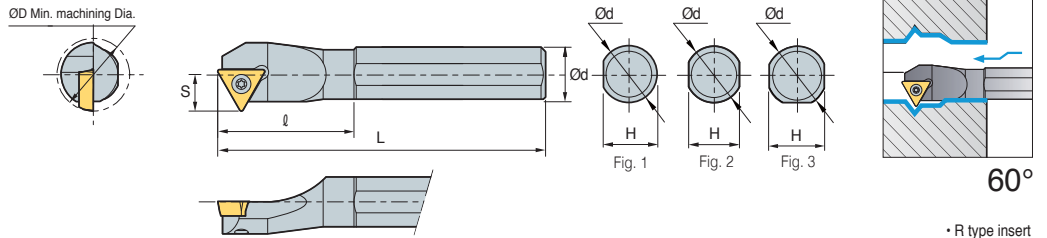

• R type insert (mm)

Designation	ØD	Ød	H	L	S	l	Insert	Screw	Wrench	Fig.
S10M-STWPR/L-11	13	10	7	150	7	16	TPGH1102□□	FTNA0305	TW09P	2
S12M-STWPR/L-11	16	12	9	150	9	20	TPGH1103□□	FTNA0306	TW09P	
S16Q-STWPR/L-11	20	16	14	180	11	25	TPMT1103□□			
S20R-STWPR/L-11	25	20	18	200	13	32				

↻ Applicable inserts B81~B83

SVJCR/L



VC□□

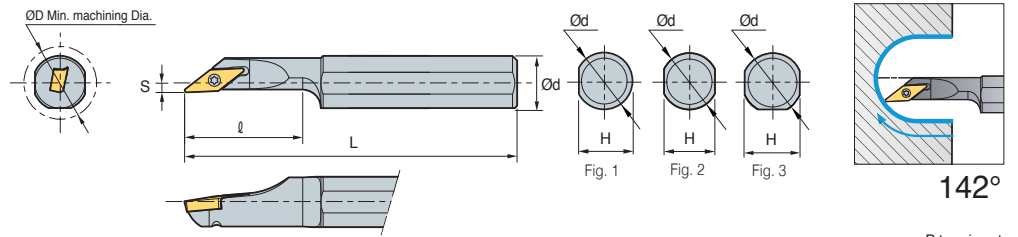

• R type insert (mm)

Designation	ØD	Ød	H	L	S	l	Insert	Screw	Wrench	Fig.
S12M-SVJCR/L-08	16	12	11	150	9	20	VCMT0802□□	FTNA0204	TW06P	2
S16Q-SVJCR/L-08	20	16	14	180	11	25				

↻ Applicable inserts B86~B87, B97

SVQBR/L



VB□□

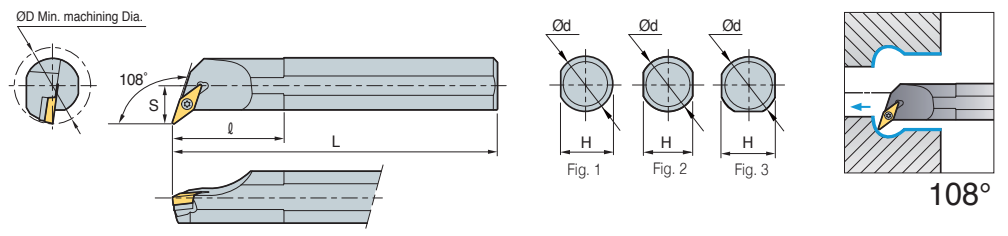

• R type insert (mm)

Designation	ØD	Ød	H	L	S	l	Insert	Screw	Shim	Shim Screw	Wrench	Fig.
S32S-SVQBR/L-16	40	32	30	250	22	50	VB□□1604□□	FTGA03512	SV32S	SHXN0509F	TW15P HW35L	3
S40T-SVQBR/L-16	50	40	38	300	27	60						
A32S-SVQBR/L-16	40	32	30	250	22	50						

↻ Applicable inserts B84~B85, B96

B Screw on System

SVQCR/L



VC□□

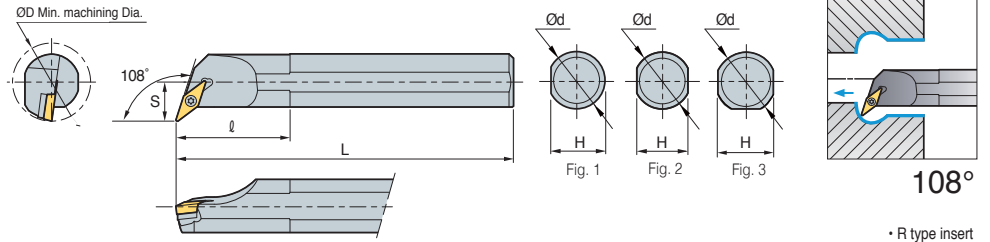

• R type insert (mm)

Designation	ØD	Ød	H	L	S	ℓ	Insert	Screw	Shim	Shim Screw	Wrench	Fig.
S16R-SVQCR/L-11	20	16	14	200	11	25	VC□□1103□□	FTKA02565	-	-	TW07P	2
S20S-SVQCR/L-11	25	20	18	250	13	32						3
S25R-SVQCR/L-11	32	25	23	200	17	40						3
S20S-SVQCR/L-13	25	20	18	250	13	32	VC□□1303□□	FTKA0307	-	-	TW07P	2
S25R-SVQCR/L-13	32	25	23	200	17	40						3
S25R-SVQCR/L-16	32	25	23	200	17	40	VC□□1604□□	FTGA03510	-	-	TW15P	3
S32S-SVQCR/L-16	40	32	30	250	22	50						
S40T-SVQCR/L-16	50	40	38	300	27	60						FTGA03512

➔ Applicable inserts B86~B87, B97

SVUBR/L



VB□□

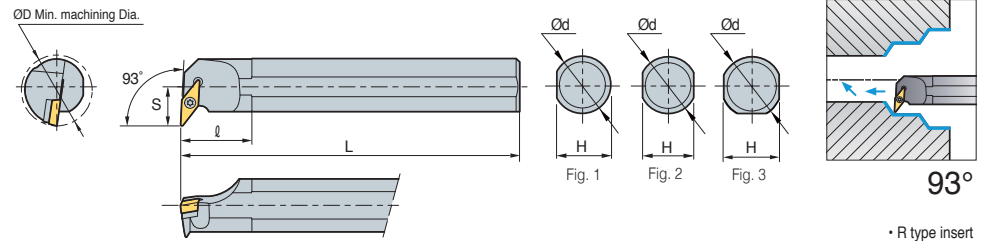

• R type insert (mm)

Designation	ØD	Ød	H	L	S	ℓ	Insert	Screw	Shim	Shim Screw	Wrench	Fig.
S32S-SVUBR/L-16	40	32	30	250	22	50	VB□□1604□□	FTGA03512	SV32S	SHXN0509F	TW15P HW35L	3
S40T-SVUBR/L-16	50	40	38	300	27	60						
A32S-SVUBR/L-16	40	32	30	250	22	50						

➔ Applicable inserts B84~B85, B96

SVUCR/L



VC□□

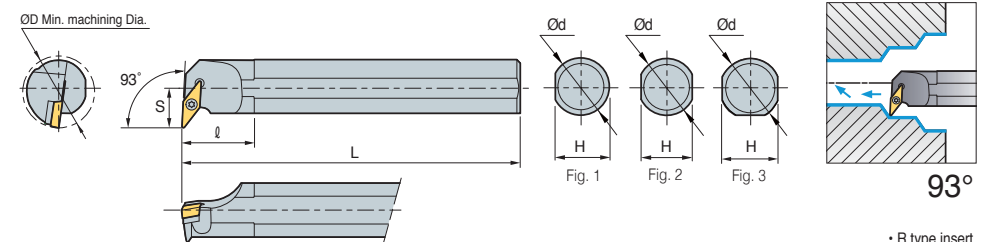

• R type insert (mm)

Designation	ØD	Ød	H	L	S	ℓ	Insert	Screw	Shim	Shim Screw	Wrench	Fig.
S16R-SVUCR/L-11	20	16	14	200	11	25	VC□□1103□□	FTKA02565	-	-	TW07P	2
S20S-SVUCR/L-11	25	20	18	250	13	32						3
S25T-SVUCR/L-11	32	25	23	300	17	40						3
S20S-SVUCR/L-13	25	20	18	250	13	32	VC□□1303□□	FTKA0307	-	-	TW09P	2
S25R-SVUCR/L-13	32	25	23	200	17	40						3
S25R-SVUCR/L-16	32	25	23	200	17	40	VC□□1604□□	FTGA03510	-	-	TW15P	3
S32S-SVUCR/L-16	40	32	30	250	22	50						
S40T-SVUCR/L-16	50	40	38	300	27	60						FTGA03512

➔ Applicable inserts B86~B87, B97



SWLCR/L



WC□□

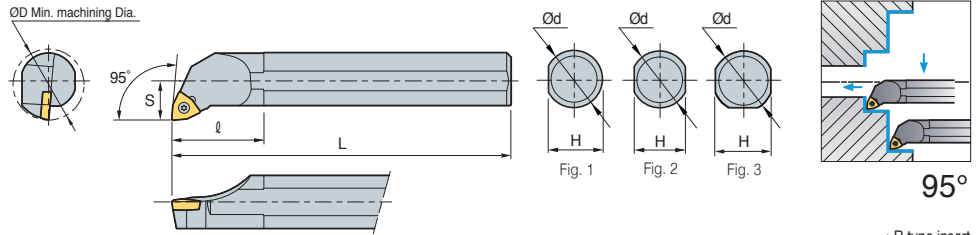

• R type insert (mm)

Designation	ØD	Ød	H	L	S	l	Insert	Screw	Wrench	Fig.
S25R-SWLCR/L-08	32	25	23	200	17	40	WC□□0804□□	FTGA0411F	TW15P	3
S32S-SWLCR/L-08	40	32	30	250	22	50				
A25R-SWLCR/L-08	32	25	24	200	17	40	WC□□0804□□	FTGA0411F	TW15P	1
A32S-SWLCR/L-08	40	32	30	250	22	50				3

SCLCR/L

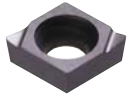

CCET

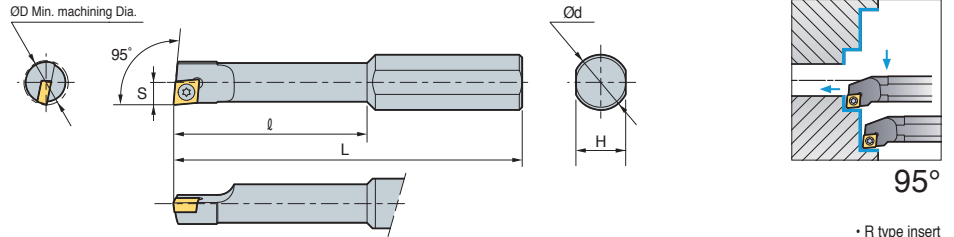

• R type insert (mm)

Designation	ØD	Ød	H	L	S	ℓ	Insert	Screw	Wrench
S10H-SCLCR/L-0305	5	10	9	100	2.5	25	CCET 0301□□	FTNA01633	TW06P
S10H-SCLCR/L-0306	6	10	9	100	3.0	25			
S10J-SCLCR/L-0407	7	10	9	110	3.5	30	CCET 0401□□	FTNA0238	TW06P
S10J-SCLCR/L-0408	8	10	9	110	4.0	30			

↻ Applicable inserts B66

• Use left handed insert for right handed holder

STUBR/L



TB□□

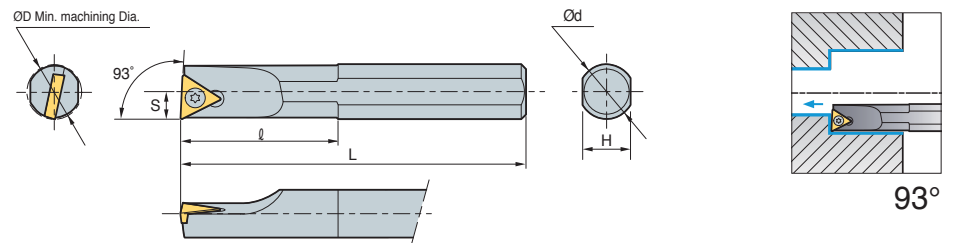

• R type insert (mm)

↻ Steel shank type

Designation	ØD	Ød	H	L	S	ℓ	Insert	Screw	Wrench
S08K-STUBR/L-06	8	8	7	125	4	30	TB□□0601□□R/L	FTNA0204	TW06P
A08F-STUBR/L-06	8	8	7.5	80	4	30			

↻ Carbide shank type

Designation	ØD	Ød	H	L	S	ℓ	Insert	Screw	Wrench
C08K-STUBR/L-06	10	8	7	125	5	TB□T0601□□	FTNA0204	TW06P	
C10K-STUBR/L-06	12	10	9	125	6				
E08K-STUBR/L-06	10	8	7	125	5	TB□T0601□□	FTNA0204	TW06P	
E10K-STUBR/L-06	12	10	9	125	6				

↻ Applicable inserts B78

• Use left handed insert for right handed holder

STLBR/L



TB□□

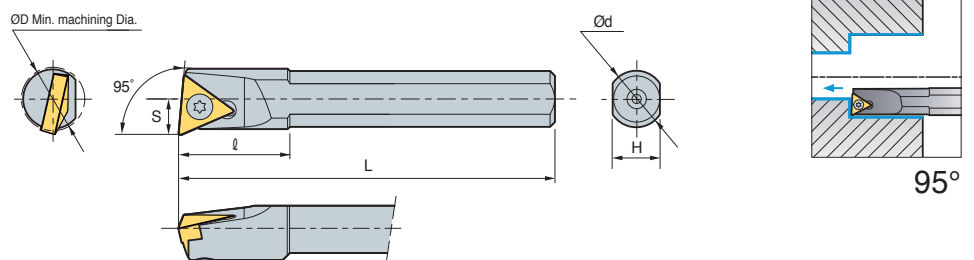

• R type insert (mm)

↻ Steel shank type

Designation	ØD	Ød	H	L	S	ℓ	Insert	Screw	Wrench
S06H-STLBR/L-06-SP	8	6	5	100	3.8	12	TB□□0601□□R/L	FTNA0204	TW06P

↻ Applicable inserts B78

• Use left handed insert for right handed holder



STUPR/L



TP□□

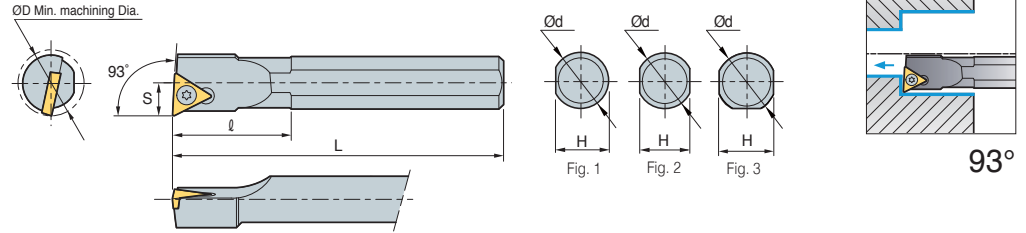

Steel shank type

• R type insert (mm)

Designation	ØD	Ød	H	L	S	l	Insert	Screw	Wrench	Fig.
S08K-STUPR/L-08	10	8	7	125	4	18	TP□□0802□□R/L	FTNA02205	TW06P	2
A08F-STUPR/L-08	10	8	7.5	80	4	18				

Carbide shank type

(mm)

Designation	ØD	Ød	H	L	S	l	Insert	Screw	Wrench	Fig.
C08K-STUPR/L-08	10	8	7	125	5		TP□□T0802□□	FTNA02205	TW06P	2
C10K-STUPR/L-11	12	10	9	125	6			FTNA0305	TW09P	
C10M-STUPR/L-11	12	10	9	150	6		TP□□T1103□□	FTNA0307	TW09P	
C12M-STUPR/L-11	15	12	11	150	8					
C12Q-STUPR/L-11	15	12	11	180	8					
C16R-STUPR/L-11	20	16	15	200	10					
C16S-STUPR/L-11	20	16	15	250	10		TP□□T1604□□	FTNA0408	TW15P	
C20R-STUPR/L-11	25	20	18	200	13					
C20S-STUPR/L-11	25	20	18	250	13		TP□□T0802□□	FTNA02205	TW06P	
C20R-STUPR/L-16	25	20	18	200	13					
C20S-STUPR/L-16	25	20	18	250	13		TP□□T1103□□	FTNA0307	TW09P	
C25T-STUPR/L-16	32	25	23	300	17					
E08K-STUPR/L-08	10	8	7	125	5					
E10K-STUPR/L-11	12	10	9	125	6					
E10M-STUPR/L-11	12	10	9	150	6					
E12M-STUPR/L-11	15	12	11	150	8					
E12Q-STUPR/L-11	15	12	11	180	8					
E16R-STUPR/L-11	20	16	15	200	10					
E16S-STUPR/L-11	20	16	15	250	10					
E20R-STUPR/L-11	25	20	18	200	13					TP□□T1604□□
E20S-STUPR/L-11	25	20	18	250	13					
E20R-STUPR/L-16	25	20	18	200	13		TP□□T1604□□	FTNA0408	TW15P	
E20S-STUPR/L-16	25	20	18	250	13					
E25T-STUPR/L-16	32	25	23	300	17					

Applicable inserts B81~B83

• Use left handed insert for right handed holder



SWUBR/L

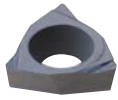

WB□T

ØD Min. machining Dia.

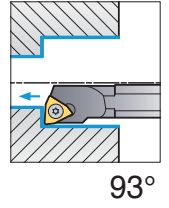
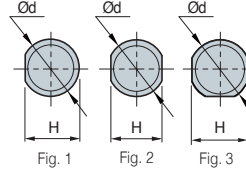
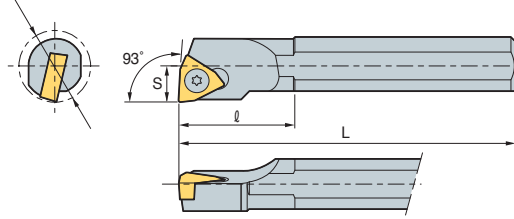

93°

• R type insert (mm)

Steel shank type

Designation	ØD	Ød	H	L	S	ℓ	Insert	Screw	Wrench	Fig
S05H-SWUBR/L-02	5.5	5	4.5	100	2.75	-	WBGT 0201□□R/L	FTNA0203	TW06P	2
S08K-SWUBR/L-02	8	8	7	125	4	30		FTNA02033		
S08K-SWUBR/L-S3	10	8	7	125	5	18	WBGT S302□□R/L	FTNA02205		
A08F-SWUBR/L-02	8	8	7.5	80	4	30	WBGT 0201□□R/L	FTNA0203		
A08F-SWUBR/L-S3	10	8	7.5	80	5	16	WBGT S302□□R/L	FTNA02205		

Carbide shank type

Designation	ØD	Ød	H	L	S	ℓ	Insert	Screw	Wrench	Fig
C05H-SWUBR/L-02	6	5	4.4	100	3		WB□T0201□□	FTNA0203	TW06P	1
C06H-SWUBR/L-02	7	6	5.4	100	3.5					
C08K-SWUBR/L-02	9	8	7	125	4.5			FTNA02033	TW06P	2
C08K-SWUBR/L-S3	10	8	7	125	4.5		WB□TS301□□	FTNA02205	TW06P	
E06H-SWUBR/L-02	7	6	5.4	100	3.5		WB□T0201□□	FTNA0203	TW06P	1
E08K-SWUBR/L-02	9	8	7	125	4.5			FTNA02033	TW06P	2
E08K-SWUBR/L-S3	10	8	7	125	5		WB□TS301□□	FTNA02205	TW06P	

Applicable inserts B89

• Use left handed insert for right handed holder



※ See page B136 for applicable sleeves

2 sides restraint - side and taper part

HSK Tooling System [For Multi-task Machines]

- 2 sides restraint - side and taper part
- Toughness guaranteed for static and dynamic movements
- Precision guaranteed on shaft and repeat directions
- Suitable at high speeds
- Suitable for small work pieces
- Coolant Nozzle is easily adjustable

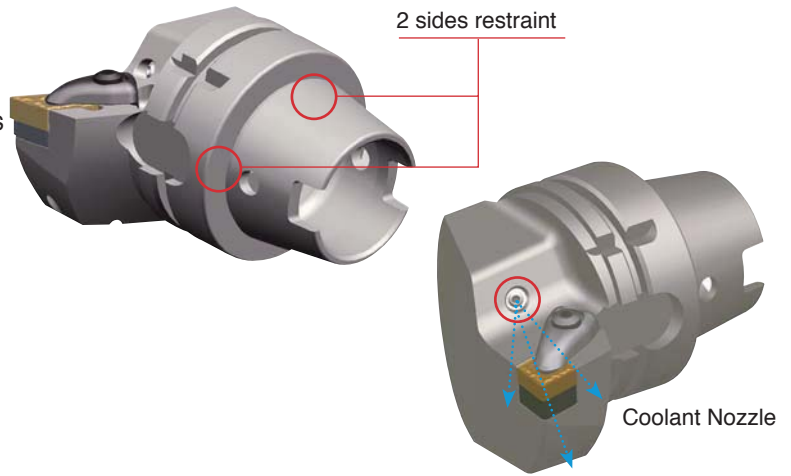

HSK tooling code system

C: 80° Diamond		D: 55° Diamond		N = 0°		DX: 65	
S: 90° Square		T: 60° Triangle		B = 5°		H: 100	
V: 35° Diamond		W: 80° Hexagon				L: 140	
Insert Shape		Clearance angle of insert		Length of tool holder			
H63T D C L N R DX - 12							
Taper design & size	Clamping Type	Holder Style		Hand	Cutting edge Length		
ICTM = HSK standard	D: Double Clamp M: Multi Clamp P: Lever Lock S: Screw On W: Wedge Clamp			R: Right L: Left N: No Hand			

ICTM (Interface committee for turning mill)

• Interface for Multi-task machines turning tool, which is tooling system based on ICTM standard from 17 major Japanese companies cooperation and is compatible with conventional HSK-A type and common to Multi-task machines and machining centers

Tolerance of keyway has been improved: HSK-T63

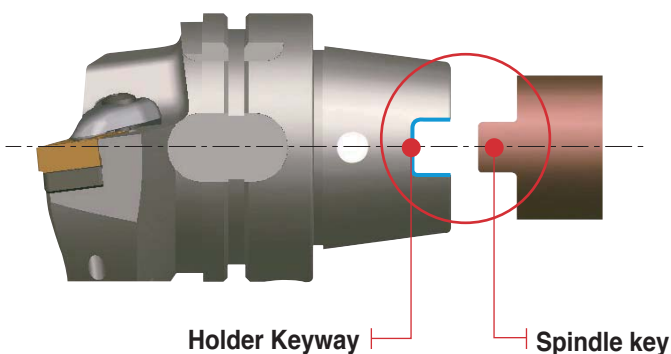

Tolerance comparison (Example)

Remarks	Maximum Tolerance	Minimum Tolerance
ICTM STANDARD HSK-T63	0.075	0.035
ISO STANDARD HSK-A63	0.33	0.08

(mm)

B Technical Information for KM Tooling System

3 Face Binding - Superior precision

KM Tooling System [For Multi-task Machines]

- 3 Face binding / Superior precision
- Flexible clamping system / Superior rigidity
- Various size & style
- Appropriate for turning & milling
- Adjustable coolant direction with coolant nozzle

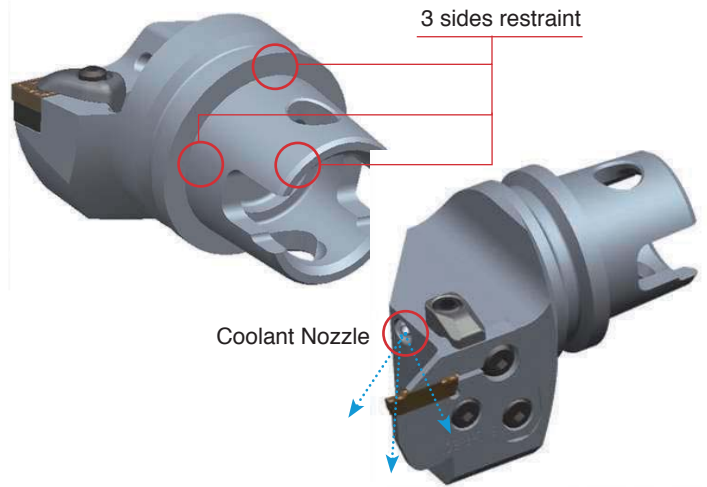

☛ KM tooling code system

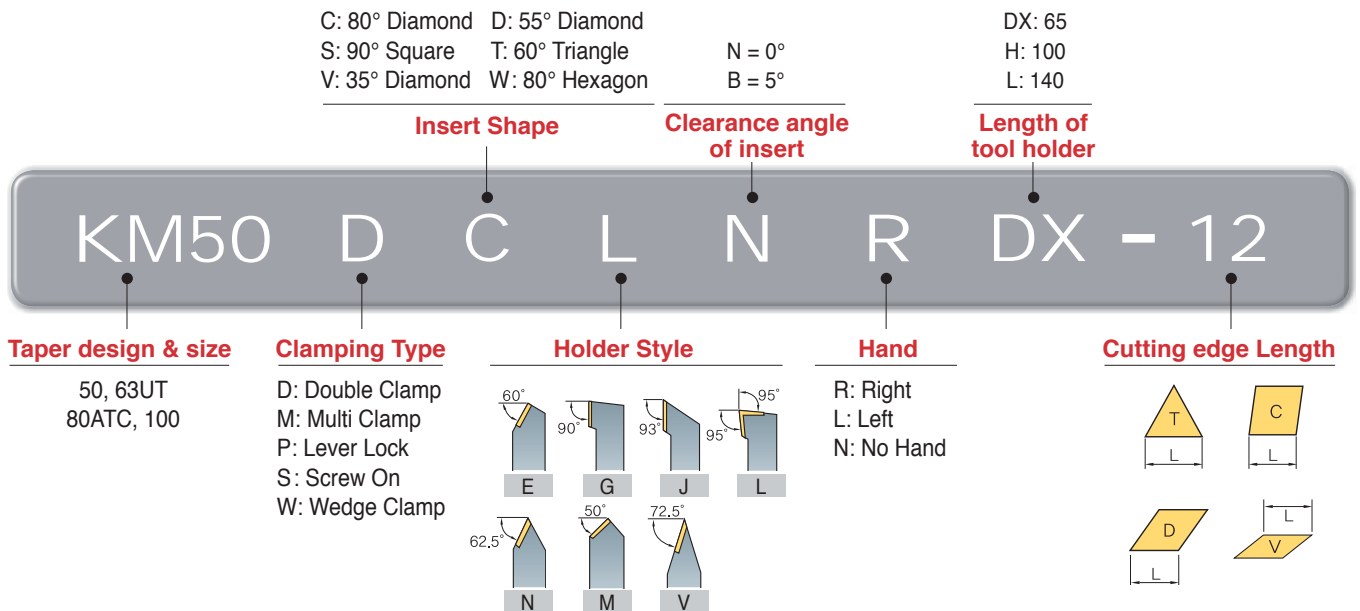

☛ Multi-tasking machine

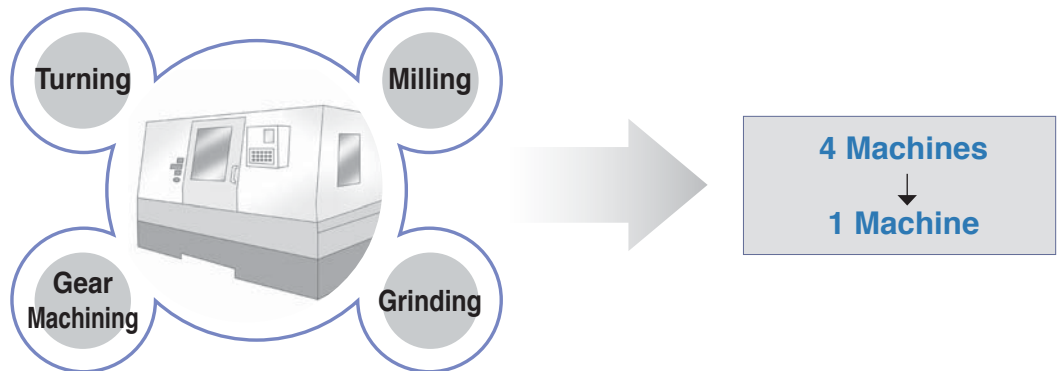

KM Tooling system is superior for wide application.

External Process Internal Process Grooving Process Drill Process Parting-off Process

KM50, KM63UT, KM80, KM100 Standard and Special type can be produced.

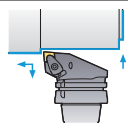
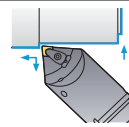
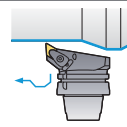
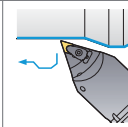
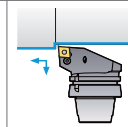
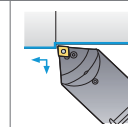
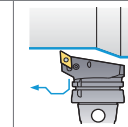
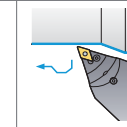

Index for HSK Tooling System

Cutting Shape								
Designation	H63T-DCLNR/L-DX12	H63T-DCMNN-H/L12	H63T-DDJNR/L-DX15	H63T-DDNNN-H/L15	H63T-PCLNR/L-DX12	H63T-PCMNN-H/L12	H63T-PDJNR/L-DX15	H63T-PDNNN-H/L15
Approach angle	95°	95°	93°	107.5°	95°	95°	93°	107.5°
Page	B220	B220	B220	B220	B221	B221	B221	B221
Turning	●	●	●	●	●	●	●	●
Copying			●	●			●	●
Facing	●	●	●	●	●	●	●	●
Back turning	●	●	●	●	●	●	●	●
Internal turning								

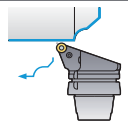
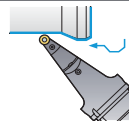
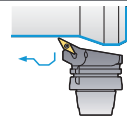
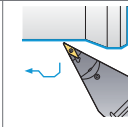
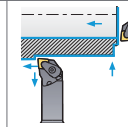
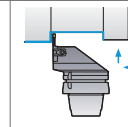
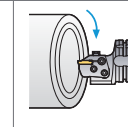
Cutting Shape								
Designation	H63T-PRGCR-DX12	H63T-PRDCN-H/L12	H63T-SVPBR/L-DX16	H63T-SVVBH-H/L16	H63T-A25K/A32L-DCLNR/L-12	H63T-MCFR/L	H63T-MCHR/L	
Approach angle	-	-	117.5°	117.5°	95°	-	-	
Page	B222	B222	B222	B222	B224	B224	B223	
Turning	●	●	●	●	●	●		
Copying	●	●	●	●	●	●		
Facing	●	●	●	●	●	●	●	
Back turning	●	●	●	●	●	●		
Internal turning					●			

Index for KM Tooling System

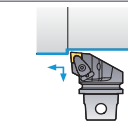
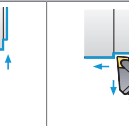
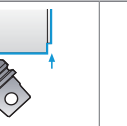
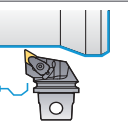
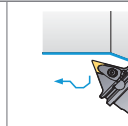
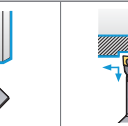
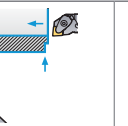
Cutting Shape							
Designation	KM50-DCLNR/L-C12 KM63UT-DCLNR/L-D12	KM50-DCMNN-C12 KM63UT-DCMNN-D12	KM50-DDJNR/L-C15(-3) KM63UT-DCJNR/L-D15(-3)	KM50-DDNNN-C15(-3) KM63UT-DDNNN-D15(-3)	KM50-A25K-DCLNR/L-12 KM50-A32K-DCLNR/L-12 KM63UT-A25K-DCLNR/L-12 KM63UT-A32L-DCLNR/L-12	KM50-PCLNR/L-C12 KM63UT-PCLNR/L-D12	
Approach angle	95°	95°	93°	107.5°	95°	95°	
Page	B226	B226	B226	B227	B229	B227	
Turning	●	●	●	●	●	●	
Copying			●	●			
Facing	●	●	●	●	●	●	
Back turning	●	●	●	●	●	●	
Internal turning					●		

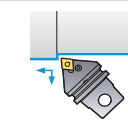
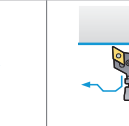
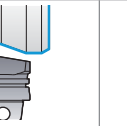
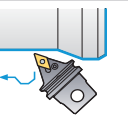
Cutting Shape						
Designation	KM50-PCMNN-C12 KM63UT-PCMNN-D12	KM50-PDJNR/L-C15(-3) KM63UT-PDJNR/L-D15(-3)	KM50-PDNNN-C15(-3) KM63UT-PDNNN-D15(-3)	KM50-MCHR/L KM63UT-MCHR/L		
Approach angle	95°	93°	107.5°	-		
Page	B227	B228	B228	B228		
Turning	●	●	●	●		
Copying		●	●	●		
Facing	●	●	●			
Back turning	●	●	●	●		
Internal turning						

DCLNR/L



CN□□

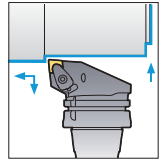
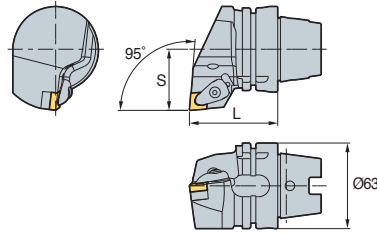

95°

• R type insert
(mm)

Designation	L	S	Insert	Clamp	Screw	Shim	Shim Screw	Spring	Nozzle	Plug	Wrench	Coolant Pipe
H63T-DCLNR/L-DX12	65	45	CN□□1204□□	CVH4	CHX0518	SC44V	FTKA0410	SPR0714	CN0605	-	HW30P	CP63T

↻ Applicable inserts B28~B35

DCMNN

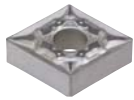

CN□□

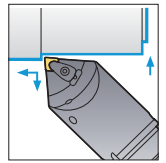
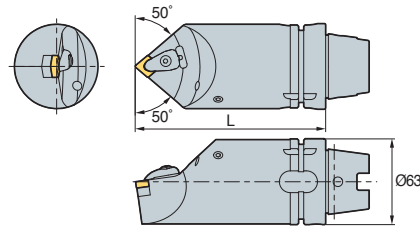

95°

(mm)

Designation	L	Insert	Clamp	Screw	Shim	Shim Screw	Spring	Nozzle	Plug	Wrench	Coolant Pipe
H63T-DCMNN-H12	100	CN□□1204□□	CVH4	CHX0518	SC44V	FTKA0410	SPR0714	CN0605	KHA0808	HW30P	CP63T
H63T-DCMNN-L12	140										

↻ Applicable inserts B28~B35

DDJNR/L



DN□□

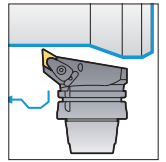
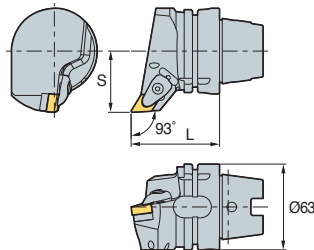

93°

• R type insert
(mm)

Designation	L	S	Insert	Clamp	Screw	Shim	Shim Screw	Spring	Nozzle	Plug	Wrench	Coolant Pipe
H63T-DDJNR/L-DX15	65	45	DN□□1506□□	CVH4	CHX0518	SD43V	FTKA0410	SPR0714	CN0605	-	HW30P	CP63T
H63T-DDJNR/L-DX15-3	65	45	DN□□1504□□			SD44V						

↻ Applicable inserts B36~B42

DDNNN



DN□□

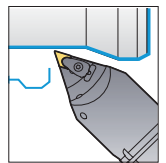
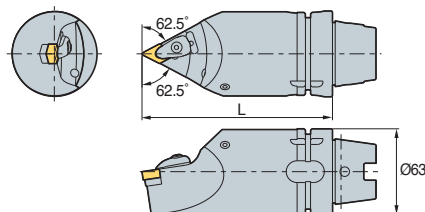

107.5°

(mm)

Designation	L	Insert	Clamp	Screw	Shim	Shim Screw	Spring	Nozzle	Plug	Wrench	Coolant Pipe
H63T-DDNNN-H15	100	DN□□1506□□	CVH4	CHX0518	SD43V	FTKA0410	SPR0714	CN0605	KHA0808	HW30P	CP63T
H63T-DDNNN-L15	140										
H63T-DDNNN-H15-3	100	DN□□1504□□	CVH4	CHX0518	SD44V	FTKA0410	SPR0714	CN0605	KHA0808	HW30P	CP63T
H63T-DDNNN-L15-3	140										

↻ Applicable inserts B36~B42



PCLNR/L

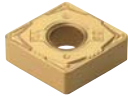

CN□□

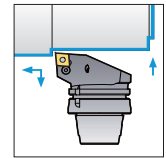
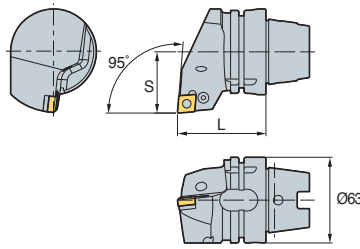

95°

• R type insert
(mm)

Designation	L	S	Insert	Lever	Screw	Shim	Shim Pin	Punching	Nozzle	Plug	Wrench	Coolant Pipe
H63T-PCLNR/L-DX12	65	45	CN□□1204□□	LV4N	VHX0820N	SC42N	SP4N	LSPS4	CN0605	-	HW30L	CP63T

↻ Applicable inserts B28~B35

PCMNN

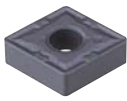

CN□□

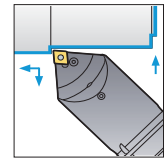
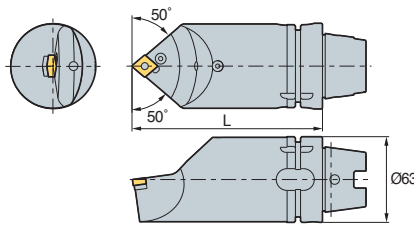

95°

(mm)

Designation	L	Insert	Lever	Screw	Shim	Shim Pin	Punching	Nozzle	Plug	Wrench	Coolant Pipe
H63T-PCMNN-H12	100	CN□□1204□□	LV4N	VHX0820N	SC42N	SP4N	LSPS4	CN0605	KHA0808	HW30L	CP63T
H63T-PCMNN-L12	140										

↻ Applicable inserts B28~B35

PDJNR/L



DN□□

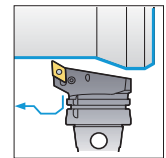
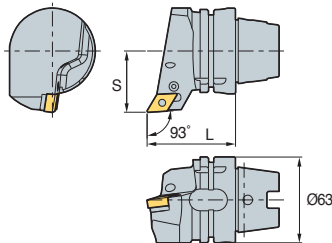

95°

• R type insert
(mm)

Designation	L	S	Insert	Lever	Screw	Shim	Shim Pin	Punching	Nozzle	Plug	Wrench	Coolant Pipe
H63T-PDJNR/L-DX15	65	45	DN□□1506□□	LV4BN	VHX0821N	SD42N	SP4N	LSPS4	CN0605	-	HW30L	CP63T
H63T-PDJNR/L-DX15-3	65	45	DN□□1504□□			SD43N						

↻ Applicable inserts B36~B42

PDNNN



DN□□

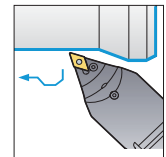
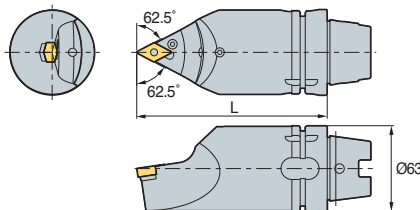

107.5°

(mm)

Designation	L	Insert	Lever	Screw	Shim	Shim Pin	Punching	Nozzle	Plug	Wrench	Coolant Pipe
H63T-PDNNN-H15	100	DN□□1506□□	LV4BN	VHX0821N	SD42N	SP4N	LSPS4	CN0605	KHA0808	HW30L	CP63T
H63T-PDNNN-L15	140										
H63T-PDNNN-H15-3	100	DN□□1504□□	LV4BN	VHX0821N	SD43N	SP4N	LSPS4	CN0605	KHA0808	HW30L	CP63T
H63T-PDNNN-L15-3	140										

↻ Applicable inserts B36~B42

PRGCR/L



RCMX1204M0

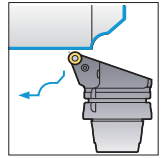
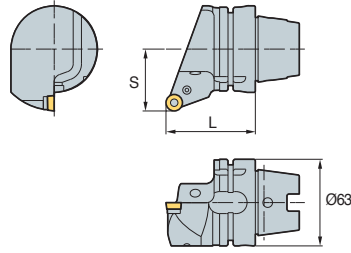

• R type insert (mm)

Designation	L	S	Insert	Lever	Screw	Shim	Shim Pin	Punching	Nozzle	Plug	Wrench	Coolant Pipe
H63T-PRGCR/L-DX12	65	45	RCMX1204M0	LR12	VHX0617	SR12	SP3	LSPS3	CN0605	-	HW25L	CP63T

↻ Applicable inserts B74

PRDCN



RCMX1204M0

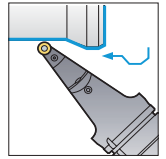
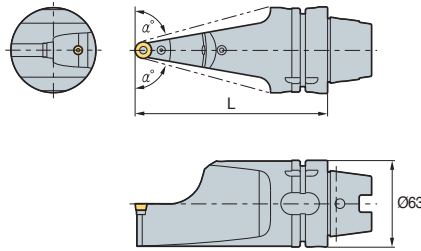

(mm)

Designation	L	α°	Insert	Lever	Screw	Shim	Shim Pin	Punching	Nozzle	Plug	Wrench	Coolant Pipe
H63T-PRDCN-H12	100	69	RCMX1204M0	LR12	VHX0617	SR12	SP3	LSPS3	CN0605	-	HW25L	CP63T
H63T-PRDCN-L12	140	75										

↻ Applicable inserts B74

SVPBR/L



VB□T

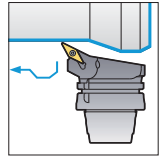
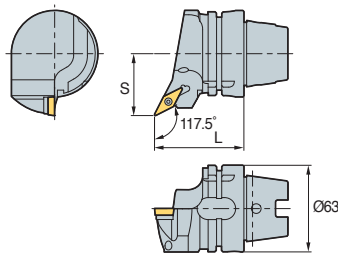

117.5°

• R type insert (mm)

Designation	L	S	Insert	Screw	Shim Screw	Shim	Nozzle	Plug	Wrench	Wrench	Coolant Pipe
H63T-SVPBR/L-DX16	65	45	VB□T1604□□	FTGA03512	SHXN0509F	SV32S	CN0605	-	TW15P	HW32L	CP63T

↻ Applicable inserts B84~B85, B96

SVVBN

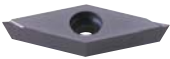

VB□T

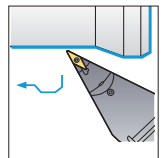
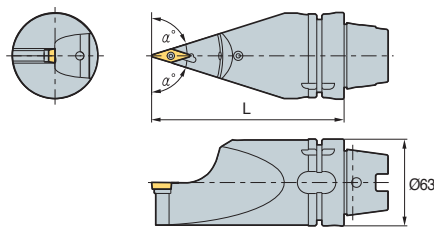

117.5°

(mm)

Designation	L	α°	Insert	Screw	Shim Screw	Shim	Nozzle	Plug	Wrench	Wrench	Coolant Pipe
H63T-SVVBN-H16	100	66.5	VB□T1604□□	FTGA03512	SHXN0509F	SV32S	CN0605	KHA0808	TW15P	HW32L	CP63T
H63T-SVVBN-L16	140	72.5									

↻ Applicable inserts B84~B85, B96



MCHR/L



MGMN / MGMR/L
MGGN / MRMN

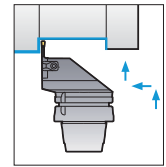
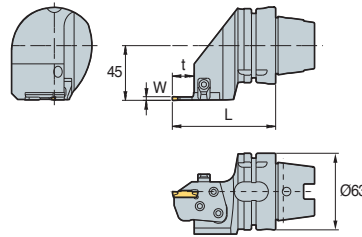

• R type insert
(mm)

Designation	L	t	W	T-MAX	Insert	Cartridge	Clamp	Clamp Screw	Hinge Screw	Screw	Nozzle	Plug	Wrench	Coolant Pipe
H63T-MCHR/L	85	18	3	16	MGMN	MCER/L3-T16	CHX8N	DHA0818F	RHA0613	FHGA0618	CN0605	-	HW40L	CP63T
	85	18	4	16	MGMR/L	MCER/L4-T16								
	89	22	5	20	MGGN	MCER/L5-T20								
	89	22	6	20	MRMN	MCER/L6-T20								

MCER/L (Cartridge)



MGMN / MGMR/L
MGGN / MRMN

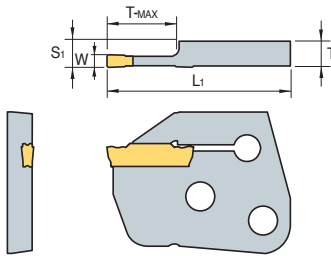

• R type insert
(mm)

Designation	L	L1	S1	T-MAX	Insert		Tool holders	
					W	Designation		
MCER/L	3-T16	6.00	44.5	6.35	16	3	MGMN	H63T-MCHR/L
	4-T16	5.97	44.5	6.35	16	4	MGMR/L	
	5-T20	5.87	48.5	6.35	20	5	MGGN	
	6-T20	5.82	48.5	6.35	20	6	MGMN	

➔ Applicable inserts C27~C29

MCHR/L



MFMN300
MGMN400

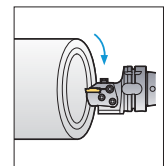
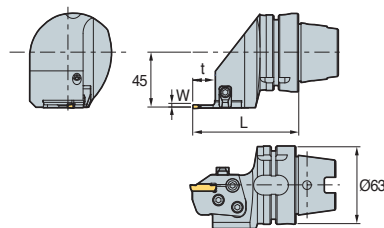

• R type insert
(mm)

Designation	L	t	W	T-MAX	Insert	Cartridge	Clamp	Clamp Screw	Hinge Screw	Screw	Nozzle	Plug	Wrench	Coolant Pipe
H63T-MCHR/L	85	18	3	16	MFMN300	MCFR/L3-24/35-T16	CHX8N	DHA0818F	RHA0613	FHGA0618	CN0605	-	HW40L	
	85	18	3	16		MCFR/L3-29/40-T16								
	85	18	3	16		MCFR/L3-34/50-T16								
	85	18	3	16		MCFR/L3-44/70-T16								
	85	18	3	16		MCFR/L3-64/99-T16								
	85	18	3	16	MGMN400	MCFR/L4-44/60-T16								
	85	18	3	16	MCFR/L4-60/120-T16									
	85	18	3	16	MCFR/L4-112/200-T16									

MCFR/L (Cartridge)

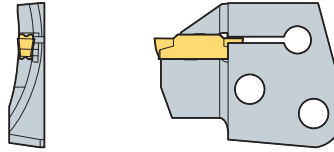
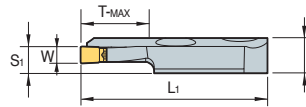

• R type insert (mm)

Designation	T	L1	S1	T-MAX	Insert		Tool holders
					W	Designation	
MCFR/L3-	24/35-T16	8.00	44.5	6.35	16	3	H63T-MCHR/L
	29/40-T16	8.00	44.5	6.35	16	3	
	34/50-T16	8.00	44.5	6.35	16	3	
	44/70-T16	8.00	44.5	6.35	16	3	
	64/99-T16	8.00	44.5	6.35	16	3	
MCFR/L4-	44/60-T16	7.97	44.5	6.35	16	4	
	60/120-T16	7.97	44.5	6.35	16	4	
	112/200-T16	7.97	44.5	6.35	16	4	

➔ Applicable inserts C27~C29

DCLNR/L

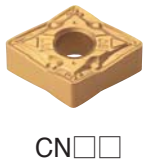

ØD Min. machining Dia.

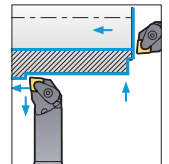
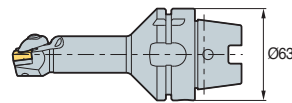
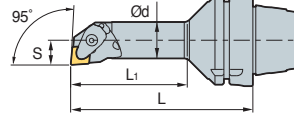
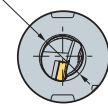

95°

• R type insert (mm)

Designation	ØD	Ød	L	L1	S	Insert	Clamp	Screw	Shim	Shim Screw	Spring	Nozzle	Plug	Wrench	Coolant Pipe
H63T-A25K-DCLNR/L-12	32	25	125	80	17	CN□□1204□□	CVH4	CHX0518	SC42V	FTKA0410	SPR0714	CN0605	-	HW30P	CP63T
H63T-A32L-DCLNR/L-12	40	32	140	98	22										

➔ Applicable inserts B28~B35

Blank Tool

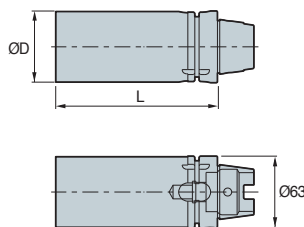

Fig. 1

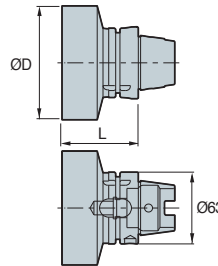

Fig. 2

(mm)

Designation	ØD	L	Fig.	Coolant Pipe
HSK-T63-BL62-102	62	102	1	CP63T
HSK-T63-BL62-142	62	142	2	
HSK-T63-BL100-67	100	67	1	
HSK-T63-BL120-70	120	70	2	



EV2525R/L-112

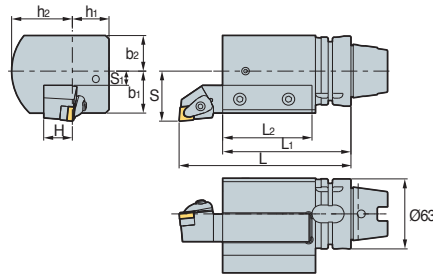

- Holder information
- Holder size: 25 x 25
- Before setting the holder, please cut the holder length to 115 mm.

• R type insert (mm)

Designation	L	L1	L2	H	h1	h2	S	S1	b1	b2	Screw	Plug	Nozzle	Wrench	Coolant Pipe
EV2525R/L-112	150	112	77	25	32	53	45	12.75	37.75	32	KHA1231	KHA0808	CN0605	HW50L	CP63T

EV2525R/L-115

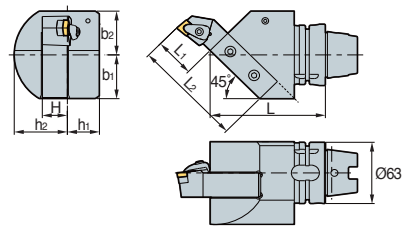

- Holder information
- Holder size: 25 x 25
- Before setting the holder, please cut the holder length to 110 mm.

• R type insert (mm)

Designation	L	L1	L2	H	h1	h2	b1	b2	Screw	Plug	Nozzle	Wrench	Coolant Pipe
EV2525R/L-115	115	40	110	25	32	53	45	45	KHA1231	KHA0808	CN0605	HW50L	CP63T

EV2020R/L-105-3

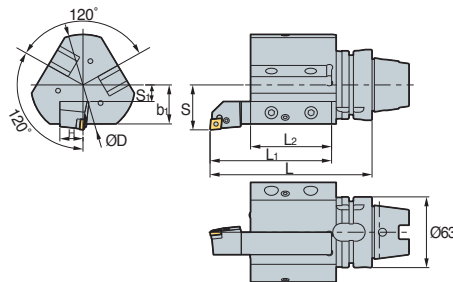

- Holder information
- Holder size: 20 x 20
- Before setting the holder, please cut the holder length to 105 mm.

• R type insert (mm)

Designation	L	L1	L2	H	ØD	S	S1	B1	Screw	Plug	Nozzle	Wrench	Coolant Pipe
EV2020R/L-105-3	140	105	70	20	90	40	15	35	KHA1231	KHA0808	CN0605	HW50L	CP63T

B○○○-○○○

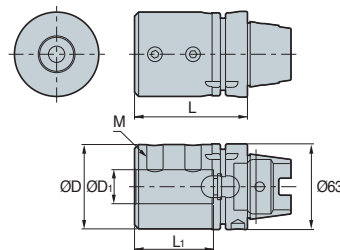

• R type insert (mm)

Designation	ØD	D1	L	L1	M	Screw	Wrench	Coolant Pipe
B08-65	28	8	65	40	M8	KHA1218	HW50L	CP63T
B10-70	35	10	70	45	M8			
B12-70	42	12	70	45	M8			
B16-75	48	16	75	50	M10			
B20-75	52	20	75	50	M10			
B25-83	62	25	83	58	M12			
B32-87	62	32	87	62	M12			
B40-97	65	40	97	72	M16			

DCLNR/L



CN□□

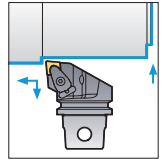
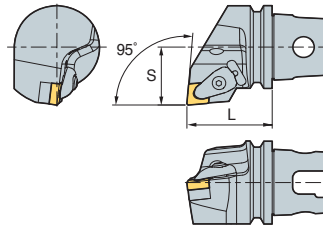

95°

• R type insert
(mm)

Designation	L	S	Insert	Clamp	Screw	Shim	Shim Screw	Spring	Nozzle	Plug	Wrench
KM50-DCLNR/L-C12	50	35	CN□□1204□□	CVH4	CHX0518	SC44V	FTKA0410	SPR0714	CN0605	-	HW30P
KM63UT-DCLNR/L-D12	60	43									

↻ Applicable inserts B28~B35

DCMNN



CN□□

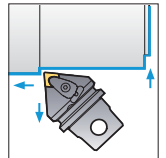
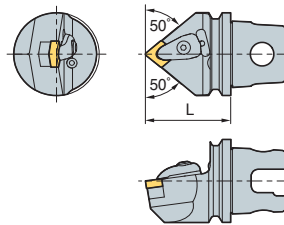

95°

(mm)

Designation	L	Insert	Clamp	Screw	Shim	Shim Screw	Spring	Nozzle	Plug	Wrench
KM50-DCMNN-C12	50	CN□□1204□□	CVH4	CHX0518	SC44V	FTKA0410	SPR0714	CN0605	KHA0808	HW30P
KM63UT-DCMNN-D12	60									

↻ Applicable inserts B28~B35

DDJNR/L



DN□□

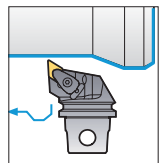
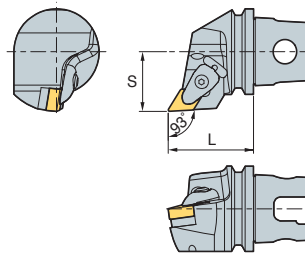

93°

• R type insert
(mm)

Designation	L	S	Insert	Clamp	Screw	Shim	Shim Screw	Spring	Nozzle	Plug	Wrench
KM50-DDJNR/L-C15	50	35	DN□□1506□□	CVH4	CHX0518	SD43V	FTKA0410	SPR0714	CN0605	-	HW30P
KM50-DDJNR/L-C15-3	50	35	DN□□1504□□	CVH4	CHX0518	SD44V	FTKA0410	SPR0714	CN0605	-	HW30P
KM63UT-DDJNR/L-D15	60	43	DN□□1506□□	CVH4	CHX0518	SD43V	FTKA0410	SPR0714	CN0605	-	HW30P
KM63UT-DDJNR/L-D15-3	60	43	DN□□1504□□	CVH4	CHX0518	SD44V	FTKA0410	SPR0714	CN0605	-	HW30P

↻ Applicable inserts B36~B42



DDNNN



DN□□

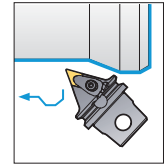
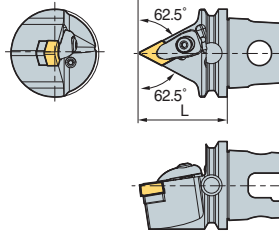

117.5°

(mm)

Designation	L	Insert	Clamp	Screw	Shim	Shim Screw	Spring	Nozzle	Plug	Wrench
KM50-DDNNN-C15	50	DN□□1506□□	CVH4	CHX0518	SD43V	FTKA0410	SPR0714	CN0605	KHA0808	HW30P
KM50-DDNNN-C15-3	50	DN□□1504□□	CVH4	CHX0518	SD44V	FTKA0410	SPR0714	CN0605	KHA0808	HW30P
KM63UT-DDNNN-D15	60	DN□□1506□□	CVH4	CHX0518	SD43V	FTKA0410	SPR0714	CN0605	KHA0808	HW30P
KM63UT-DDNNN-D15-3	60	DN□□1504□□	CVH4	CHX0518	SD44V	FTKA0410	SPR0714	CN0605	KHA0808	HW30P

↻ Applicable inserts B36~B42

PCLNR/L



CN□□

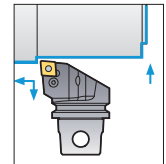
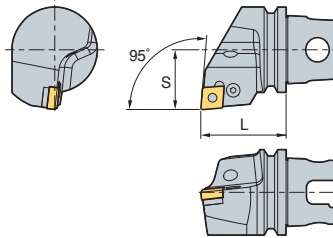

95°

• R type insert
(mm)

Designation	L	S	Insert	Lever	Screw	Shim	Shim Pin	Punching	Nozzle	Plug	Wrench
KM50-PCLNR/L-C12	50	35	CN□□1204□□	LV4N	VHX0820N	SC42N	SP4N	LSPS4	CN0605	-	HW30L
KM63UT-PCLNR/L-D12	60	43									

↻ Applicable inserts B28~B35

PCMNN

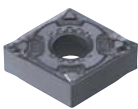

CN□□

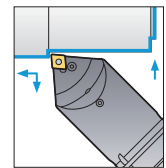
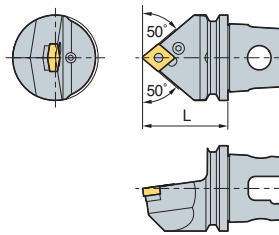

95°

(mm)

Designation	L	Insert	Lever	Screw	Shim	Shim Pin	Punching	Nozzle	Plug	Wrench
KM50-PCMNN-C12	50	CN□□1204□□	LV4N	VHX0820N	SC42N	SP4N	LSPS4	CN0605	KHA0808	HW30L
KM63UT-PCMNN-D12	60									

↻ Applicable inserts B28~B35

PDJNR/L



DN□□

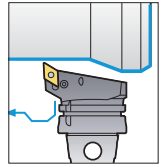
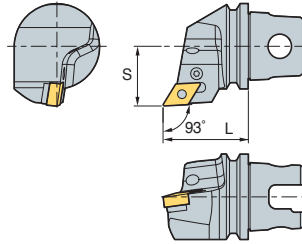

93°

• R type insert
(mm)

Designation	L	S	Insert	Lever	Screw	Shim	Shim Pin	Punching	Nozzle	Plug	Wrench
KM50-PDJNR/L-C15	50	35	DN□□1506□□	LV4BN	VHX0821N	SD42N	SP4N	LSPS4	CN0605	-	HW30L
KM50-PDJNR/L-C15-3	50	35	DN□□1504□□	LV4BN	VHX0821N	SD43N	SP4N	LSPS4	CN0605	-	HW30L
KM63UT-PDJNR/L-D15	60	43	DN□□1506□□	LV4BN	VHX0821N	SD42N	SP4N	LSPS4	CN0605	-	HW30L
KM63UT-PDJNR/L-D15-3	60	43	DN□□1504□□	LV4BN	VHX0821N	SD43N	SP4N	LSPS4	CN0605	-	HW30L

➔ Applicable inserts B36~B42

PDNNN



DN□□

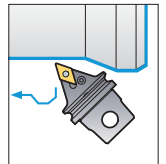
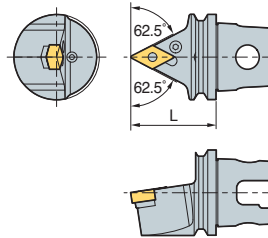

107.5°

(mm)

Designation	L	Insert	Lever	Screw	Shim	Shim Pin	Punching	Nozzle	Plug	Wrench
KM50-PDNNN-C15	50	DN□□1506□□	LV4BN	VHX0821N	SD42N	SP4N	LSPS4	CN0605	KHA0808	HW30L
KM50-PDNNN-C15-3	50	DN□□1504□□	LV4BN	VHX0821N	SD43N	SP4N	LSPS4	CN0605	KHA0808	HW30L
KM63UT-PDNNN-D15	60	DN□□1506□□	LV4BN	VHX0821N	SD42N	SP4N	LSPS4	CN0605	KHA0808	HW30L
KM63UT-PDNNN-D15-3	60	DN□□1504□□	LV4BN	VHX0821N	SD43N	SP4N	LSPS4	CN0605	KHA0808	HW30L

➔ Applicable inserts B36~B42

MCHR/L



MGMN / MGMR/L
MGGN / MRMN

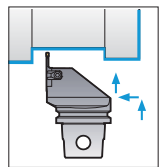
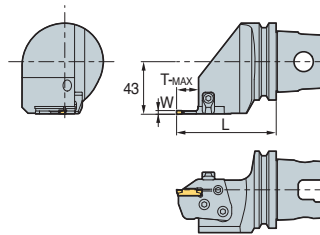

• R type insert
(mm)

Designation	S	L	t	W	T-MAX	Insert	Cartridge	Clamp	Clamp Screw	Hinge Screw	Screw	Nozzle	Plug	Wrench
KM50-MCHR/L	35	72.5	18	3	16	MGMN MGMR/L	MCER/L3-T16	CHX8N	DHA0818F	RHA0613	FHGA0618	CN0605	-	HW40L
	35	72.5	18	4	16		MCER/L4-T16							
	35	76.5	22	5	20		MCER/L5-T20							
	35	76.5	22	6	20		MCER/L6-T20							
KM63UT-MCHR/L	43	81.5	18	3	16	MGGN MRMN	MCER/L3-T16	CHX8N	DHA0818F	RHA0613	FHGA0618	CN0605	-	HW40L
	43	81.5	18	4	16		MCER/L4-T16							
	43	85.5	22	5	20		MCER/L5-T20							
	43	85.5	22	6	20		MCER/L6-T20							

➔ Applicable inserts C27~C29



MCER/L (Cartridge)



MGMN / MGMR/L
MGGN / MRMN

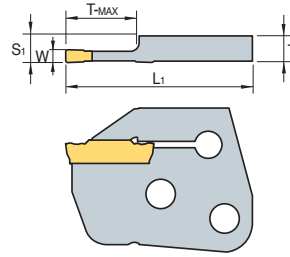

• R type insert (mm)

Designation	T	L1	S1	T-MAX	Insert		Tool holders	
					W	Designation		
MCER/L	3-T16	6.00	44.5	6.35	16	3	MGMN	H-63T-MCHR/L
	4-T16	5.97	44.5	6.35	16	4	MGMR/L	
	5-T20	5.87	48.5	6.35	20	5	MGGN	
	6-T20	5.82	48.5	6.35	20	6	MRMN	

➔ Applicable inserts C27~C29

KM○○-DCLNR/L

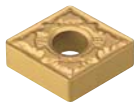

CN□□

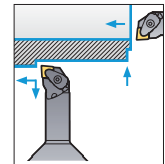
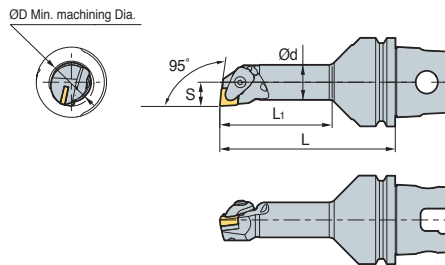

95°

• R type insert (mm)

Designation	ØD	Ød	L	L1	S	Insert	Clamp	Screw	Shim	Shim Screw	Spring	Nozzle	Plug	Wrench
KM50-A25K-DCLNR/L-12	32	25	125	80	17	CN□□1204□□								
KM50-A32L-DCLNR/L-12	40	32	140	98	22									
KM63UT-A25K-DCLNR/L-12	32	25	125	80	17									
KM63UT-A32L-DCLNR/L-12	40	32	140	98	22									

➔ Applicable inserts B28~B35

Blank Tool

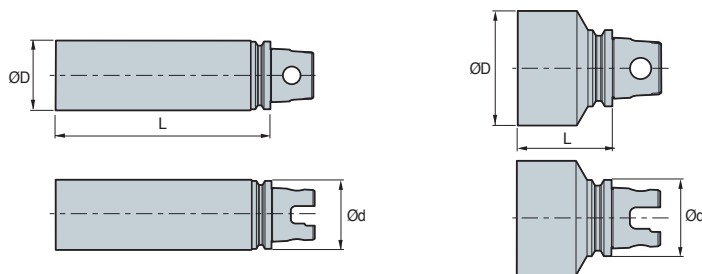

Fig. 1

Fig. 2

(mm)

Designation	ØD	L	Ød	Fig.
KM50-BL7562	45	62	50	1
KM50-BL10562	105	62	50	2
KM63UT-BL65200	65	200	50	1
KM63UT-BL115150	115	150	50	2



B Cartridge Code System (ISO)

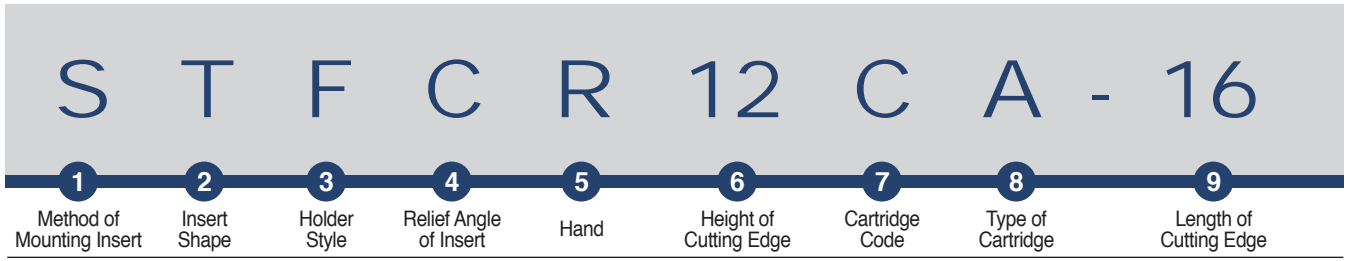

1 Method of Mounting Insert
S T F C R 12 C A - 16

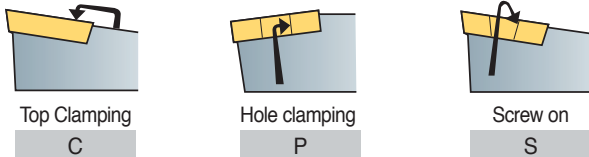

Top Clamping (C) Hole clamping (P) Screw on (S)

2 Insert Shape
S T F C R 12 C A - 16

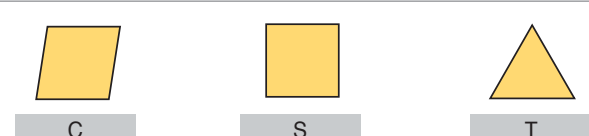

C S T

3 Holder Style
S T F C R 12 C A - 16

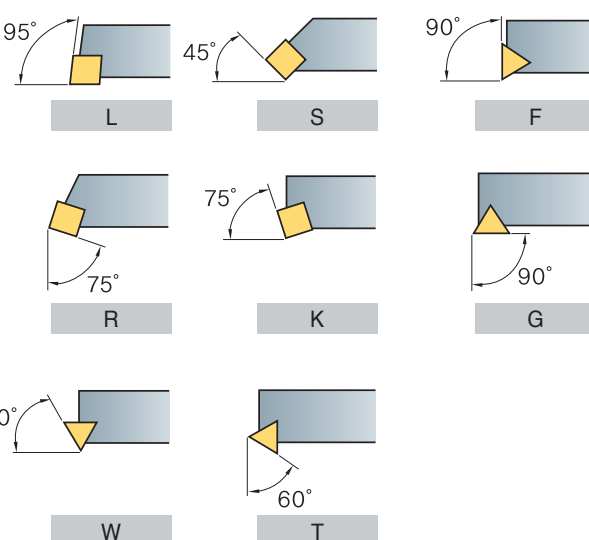

L S F R K G W T

4 Relief Angle of Insert
S T F C R 12 C A - 16

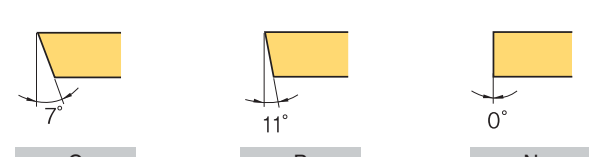

C P N

5 Hand
S T F C R 12 C A - 16

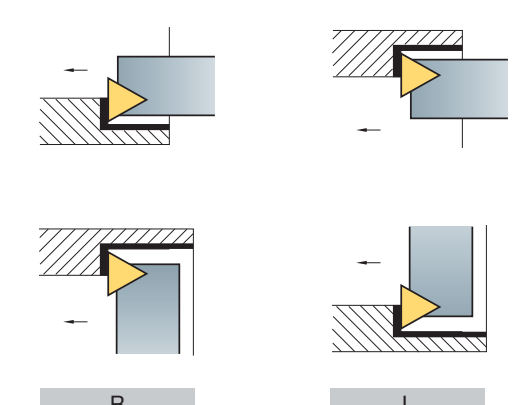

R L

6 Height of Cutting Edge
S T F C R 12 C A - 16

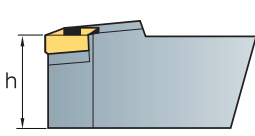

h

7 Cartridge Code
S T F C R 12 C A - 16

C (Cartridge)

8 Type of Cartridge
S T F C R 12 C A - 16

A (ISO5611)

9 Length of Cutting Edge
S T F C R 12 C A - 16

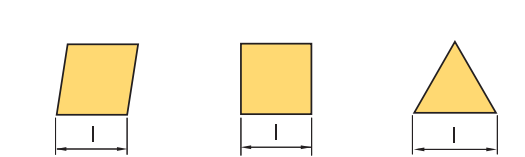

l l l

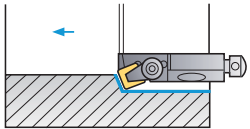
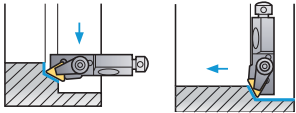
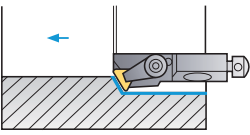
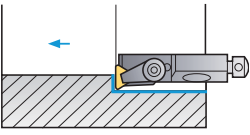
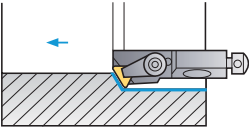
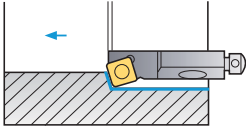
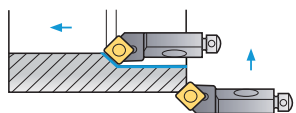
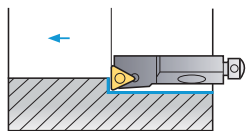
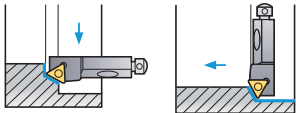
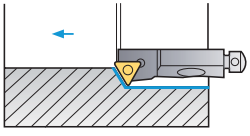

	Cutting Shape	Turning	Copying	Facing	Chamfering	Applicable inserts	Page	
Clamp on System	CSKPR/L 	10CA-09 12CA-12	●				SP□R 0903□□ 1203□□	B232
	CTTPR/L 	10CA-11 12CA-16	●				TP□R 1103□□ 1603□□	B233
	CTWPR/L 	10CA-11 12CA-16	●				TP□R 1103□□ 1603□□	B2233
	CTFPR/L 	10CA-11 12CA-16	●		●		TP□R 1103□□ 1603□□	B232
	CTSPR/L 	10CA-11 12CA-16	●				TP□R 1103□□ 1603□□	B232
Screw on System	SSKCR/L 	10CA-09 12CA-12	●				SC□T 09T3□□ 1204□□	B234
	SSSCR/L 	10CA-09 12CA-12	●			●	SC□T 09T3□□ 1204□□	B234
	STFCR/L 	10CA-11 12CA-16	●		●		TC□T 1102□□ 16T3□□	B234
	STTCR/L 	10CA-11 12CA-16	●		●		TC□T 1102□□ 16T3□□	B235
	STWCR/L 	10CA-11 12CA-16	●				TC□T 1102□□ 16T3□□	B235



B Clamp on System

CSKPR/L

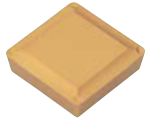

SP□R

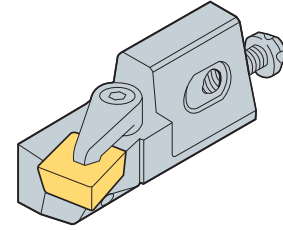
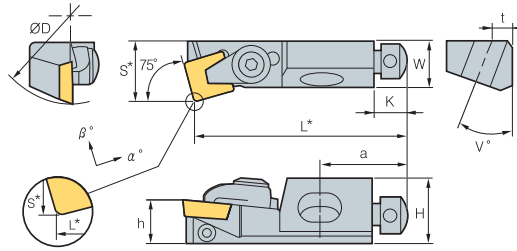

• R type insert (mm)

Designation	ØD	H	W	L*	S*	h	K	α°	β°	a	t	v°	Insert
CSKPR/L 10CA-09	40	15	11	50	14	10	8	6	0	20	5	20	SP□R 0903 □□ 1203 □□
12CA-12	50	20	15	55	20	12	8	6	0	20	6	20	

➔ Applicable inserts B76~B77 • a base Insert : r = 0.8 D = ØD Min. machining Dia.

Parts	Clamp	Axial Adjust Screw	Radial Adjust Screw	MountingScrew	Washer	Wrench	Wrench
CSKPR/L 10CA-09	CA05R	AZ0508F	KHA0408	RHA0620	WA0602	TW 15P	HW20L
12CA-12	CA06R	AZ0508F	KHA0412	RHA0625	WA0602	TW 15P	HW20L

CTFPR/L



TP□R

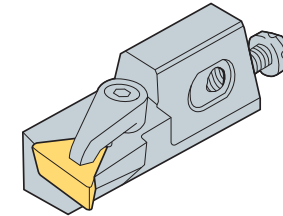
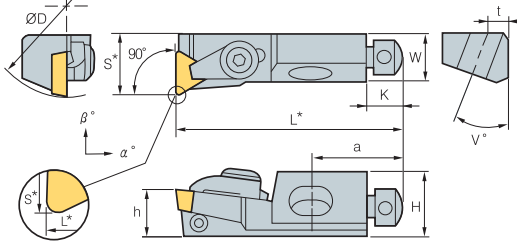

• R type insert (mm)

Designation	ØD	H	W	L*	S*	h	K	α°	β°	a	t	v°	Insert
CTFPR/L 10CA-11	40	15	11	50	14	10	8	6	0	20	5	20	TP□R 1103 □□ 1603 □□
12CA-16	50	20	15	55	20	12	8	6	0	20	6	20	

➔ Applicable inserts B81~B83 • a base Insert : r = 0.4 (l = 11) r = 0.8 (l = 16) D = ØD Min. machining Dia.

Parts	Clamp	Axial Adjust Screw	Radial Adjust Screw	MountingScrew	Washer	Wrench	Wrench
CTFPR/L 10CA-11	CA05R	AZ0508F	KHA0408	RHA0620	WA0602	TW25L	HW20L
12CA-16	CA06R	AZ0508F	KHA0412	RHA0625	WA0602	TW30L	HW20L

CTSPR/L



TP□R

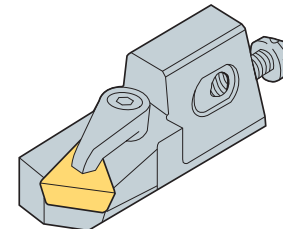
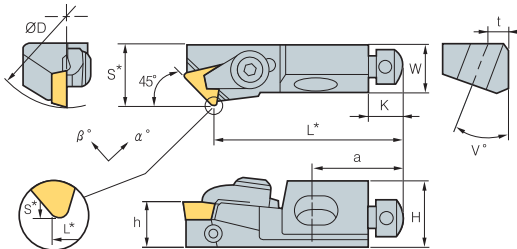

• R type insert (mm)

Designation	ØD	H	W	L*	S*	h	K	α°	β°	a	t	v°	Insert
CTSPR/L 10CA-11	40	15	11	44	14	10	8	4	0	20	5	20	TP□R 1103 □□ 1603 □□
12CA-16	50	20	15	47	20	12	8	5	0	20	6	20	

➔ Applicable inserts B81~B83 • a base Insert : r = 0.4 (l = 11) r = 0.8 (l = 16) D = ØD Min. machining Dia.

Parts	Clamp	Axial Adjust Screw	Radial Adjust Screw	MountingScrew	Washer	Wrench	Wrench
CTSPR/L 10CA-11	CA05R	AZ0508F	KHA0408	RHA0620	WA0602	TW25L	HW20L
12CA-16	CA06R	AZ0508F	KHA0412	RHA0625	WA0602	TW30L	HW20L



CTTPR/L



TP□R

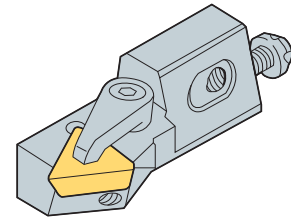
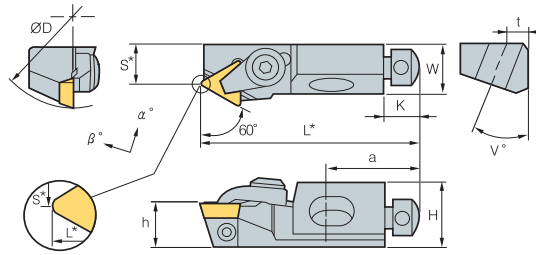

• R type insert (mm)

Designation	ØD	H	W	L*	S*	h	K	α°	β°	a	t	v°	Insert
CTTPR/L 10CA-11	40	15	11	50	9	10	8	5	0	20	5	20	TP□R 1103□□ 1603□□
12CA-16	50	20	15	55	20	12	8	5	0	20	6	20	

↻ Applicable inserts **B81~B83** · a base Insert : r = 0.8 D = ØD Min. machining Dia.

Parts	Clamp	Axial Adjust Screw	Radial Adjust Screw	MountingScrew	Washer	Wrench	Wrench
CTTPR/L 10CA-11	CA05R	AZ0508F	KHA0408	RHA0620	WA0602	TW25L	HW20L
12CA-16	CA06R	AZ0508F	KHA0412	RHA0625	WA0602	TW30L	HW20L

CTWPR/L



TP□R

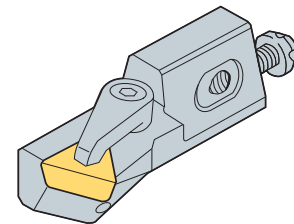
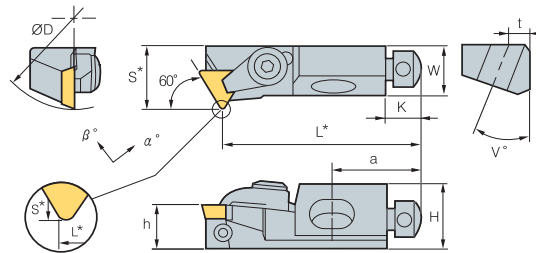

• R type insert (mm)

Designation	ØD	H	W	L*	S*	h	K	α°	β°	a	t	v°	InsertInsert
CTWPR/L 10CA-11	40	15	11	44	14	10	8	5	0	20	5	20	TP□R 1103 □□ 1603 □□
12CA-16	50	20	15	47	20	12	8	5	0	20	6	20	

↻ Applicable inserts **B81~B83** · a base Insert : r = 0.8 D = ØD Min. machining Dia.

Parts	Clamp	Axial Adjust Screw	Radial Adjust Screw	MountingScrew	Washer	Wrench	Wrench
CTWPR/L 10CA-11	CA05R	AZ0508F	KHA0408	RHA0620	WA0602	TW25L	HW20L
12CA-16	CA06R	AZ0508F	KHA0412	RHA0625	WA0602	TW30L	HW20L



SSKCR/L

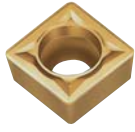

SC□□

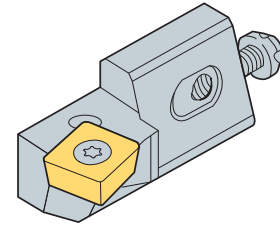
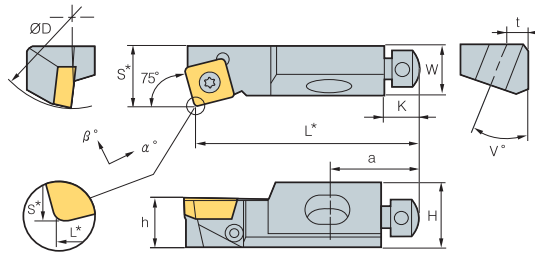

• R type insert (mm)

Designation	ØD	H	W	L*	S*	h	K	α°	β°	a	t	v°	Insert
SSKCR/L 10CA-09	40	15	11	50	14	10	8	0	-4	20	5	20	SC□□ 09T3□□
12CA-12	50	20	15	55	20	12	8	0	-4	20	6	20	SC□□ 1204□□

↻ Applicable inserts B74~B75, B94

• a base Insert : r = 0.8 D = ØD Min. machining Dia.

Parts	Screw	Axial Adjust Screw	Radial Adjust Screw	MountingScrew	Washer	Wrench	Wrench
SSKCR/L 10CA-09	FTGA03508	AZ0508F	KHA0408	RHA0620	WA0602	TW 15P	HW20L
12CA-12	FTGA0411F	AZ0508F	KHA0412	RHA0625	WA0602	TW 15P	HW20L

SSSCR/L



SC□□

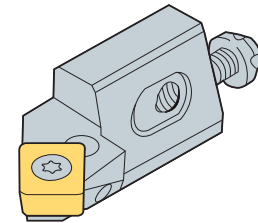
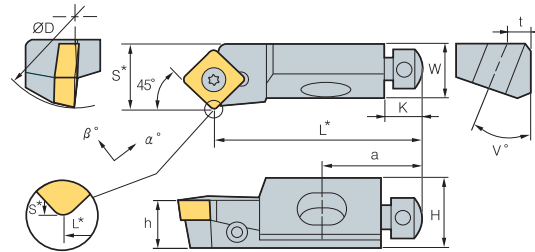

• R type insert (mm)

Designation	ØD	H	W	L*	S*	h	K	α°	β°	a	t	v°	Insert
SSSCR/L 10CA-09	40	15	11	44	14	10	8	-5	0	20	5	20	SC□□ 09T3□□
12CA-12	50	20	15	47	20	12	8	-5	0	20	6	20	SC□□ 1204□□

↻ Applicable inserts B74~B75, B94

• a base Insert : r = 0.8 D = ØD Min. machining Dia.

Parts	Screw	Axial Adjust Screw	Radial Adjust Screw	MountingScrew	Washer	Wrench	Wrench
SSSCR/L 10CA-09	FTGA03508	AZ0508F	KHA0408	RHA0620	WA0602	TW 15P	HW20L
12CA-12	FTGA0411F	AZ0508F	KHA0412	RHA0625	WA0602	TW 15P	HW20L

STFCR/L

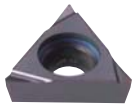

TC□□

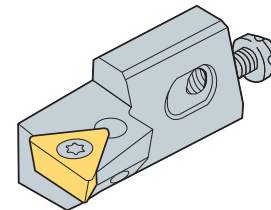
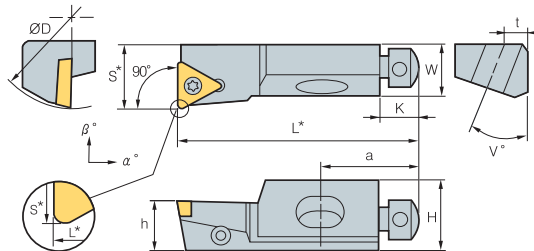

• R type insert (mm)

Designation	ØD	H	W	L*	S*	h	K	α°	β°	a	t	v°	Insert
STFCR/L 10CA-11	40	15	11	50	14	10	8	0	-3	20	5	20	TC□□ 1102□□
12CA-16	50	20	15	55	20	12	8	0	-3	20	6	20	TC□□ 16T3□□

↻ Applicable inserts B79~B80, B95

• a base Insert : r = 0.4 (l=11) r = 0.8 (l=16) D = Min. machining Dia.

Parts	Screw	Axial Adjust Screw	Radial Adjust Screw	MountingScrew	Washer	Wrench	Wrench
STFCR/L 10CA-11	FTKA02565	AZ0508F	KHA0408	RHA0620	WA0602	TW 15P	HW20L
12CA-16	FTKA03508	AZ0508F	KHA0412	RHA0625	WA0602	TW 15P	HW20L



STTCR/L

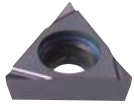

TC□□

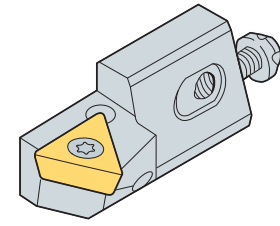
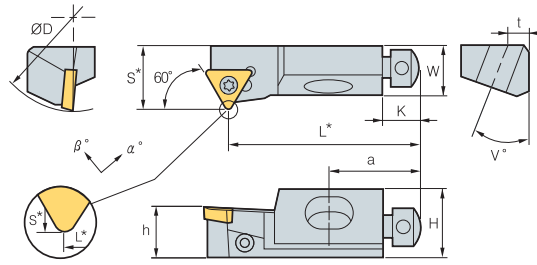

• R type insert (mm)

Designation	ØD	H	W	L*	S*	h	K	α°	β°	a	t	v°	Insert
STTCR/L 10CA-11	40	15	11	50	9	10	8	-5	0	20	5	20	TC□□ 1102□□
12CA-16	50	20	15	47	20	12	8	-3	0	20	6	20	TC□□ 16T3□□

↻ Applicable inserts B79~B80, B95

• a base Insert : r = 0.4 (l=11) r = 0.8 (l=16) D = Min. machining Dia.

Parts	Screw	Axial Adjust Screw	Radial Adjust Screw	MountingScrew	Washer	Wrench	Wrench
STTCR/L 10CA-11	FTKA02565	AZ0508F	KHA0408	RHA0620	WA0602	TW 07P	HW20L
12CA-16	FTKA03508	AZ0508F	KHA0412	RHA0625	WA0602	TW 15P	HW20L

STWCR/L



TC□□

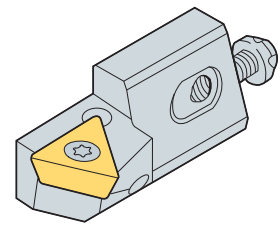
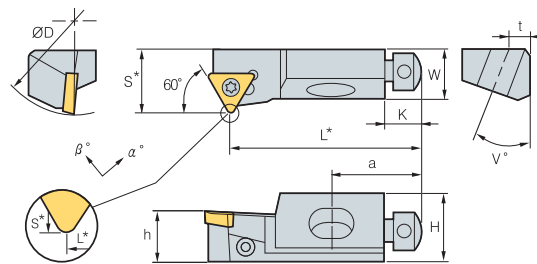

• R type insert (mm)

Designation	ØD	H	W	L*	S*	h	K	α°	β°	a	t	v°	Insert
STWCR/L 10CA-11	40	15	11	44	14	10	8	0	-4	20	5	20	TC□□ 1102□□
12CA-16	50	20	15	47	20	12	8	-5	0	20	6	20	TC□□ 16T3□□

↻ Applicable inserts B79~B80, B95

• a base Insert : r = 0.4 (l=11) r = 0.8 (l=16) D = Min. machining Dia.

Parts	Screw	Axial Adjust Screw	Radial Adjust Screw	MountingScrew	Washer	Wrench	Wrench
STWCR/L 10CA-11	FTKA02565	AZ0508F	KHA0408	RHA0620	WA0602	TW 15P	HW20L
12CA-16	FTKA03508	AZ0508F	KHA0412	RHA0625	WA0602	TW 15P	HW20L



C

MULTI-FUNCTIONAL TOOLS

Korloy Multi-functional tools can be used for machining in grooving, parting-off, facing and forming applications. Its design ensures superior machinability and productivity.



Application Example

- C02 Application Example
- C04 Technical Information for Multi-Functional Tools Series

KGT

- C07 Technical Information for KGT
- C12 Available Insert for KGT
- C14 KGT Holder
- C24 KGT Blade for Parting off

KGT/MGT

- C25 Technical Information for MGT
- C27 Available Insert for MGT
- C30 MGT Holder
- C35 MGT Holder (Face Grooving)
- C38 Technical Information for KGT/MGT Cartridge
- C39 KGT/MGT Cartridge Holder
- C40 KGT Cartridge
- C41 MGT Cartridge

MGT Aluminum Wheel Series

- C42 Technical Information for MGT Aluminum Wheel
- C43 Available Insert for MGT Aluminum Wheel
- C44 MGT Aluminum Wheel

TB/TB-M

- C46 Technical Information for TB/TB-M
- C50 Available Insert for TB/TB-M
- C53 TB/TB-M Holder

K Notch

- C54 Technical Information for K Notch
- C56 Available Insert for K Notch
- C58 K Notch Holder

Saw Man

- C59 Technical Information for Saw Man
- C60 Saw Man

Saw Man-X

- C62 Technical Information for Saw Man-X
- C64 Saw Man-X

Fine Tools

- C65 Technical Information for Fine Tools
- C66 Available Insert for Fine Tools
- C67 Fine Tools Holder

Grooving/Parting off

- C68 IGH
- C68 DBH
- C69 GFT
- C69 GFIP
- C70 GH
- C70 GFIK
- C71 EH
- C71 PH

Special Order Form

- C72 Special Order Form for MGT
- C73 Special Order Form for V-Pulley Insert

C Application Example

For external machining









KGEUR/L	MGEUR/L	TBH	K Notch	PH	GH	GFT	DBH	KGEHR/L	MGEHR/L
Width: 2.5 T-MAX: 3.0	Width: 3.0~8.0 T-MAX: 3.0~5.0	Width: 1.25~4.5 T-MAX: 1.5~5.0	Width: 0.75~6.3 T-MAX: 0~6.5	Width: 3.0~5.0 ØD-MAX: 30~50	Width: 1.23~4.28 T-MAX: 1.5~4.0	Width: 1.1~8.0 T-MAX: 2.1~9.0	Width: 3.0~8.0 T-MAX: 14	Width: 2.0~8.0 T-MAX: 17~20	Width: 1.5~8.0 T-MAX: 10~28
KRMN KRGN	MRMN MRGN	TB TB-M	KNG KNGP KNR KNRP KNB	POB	GO GS	GW BF	DC DB	KGGN KGMN KGMR/L KRMN	MGGN MGMN MGMR MRGN MRMN









For internal machining

NFTIH	GFIK	GFIP	IGH	KGIVR/L	MGIVR/L	KGIUR/L	MGIUR/L
Width: 0.75~4.02 T-MAX: 1.3~4.6	Width: 2.0~8.0 T-MAX: 2.0~8.0	Width: 1.1~8.0 T-MAX: 2.1~9.0	Width: 1.25~2.8 T-MAX: 1.5~2.3	Width: 2.0~4.0 T-MAX: 7.0~8.0	Width: 1.5~8.0 T-MAX: 4.0~10	Width: 3.0 T-MAX: 3.0	Width: 3.0~8.0 T-MAX: 3.5~6.5
NFTG NFTF NFTT	GR	GW BF	IG	KGMI KGMN KRMN KGGN	MRMN MGGN MRGN	KRMN KRGN	MRMN







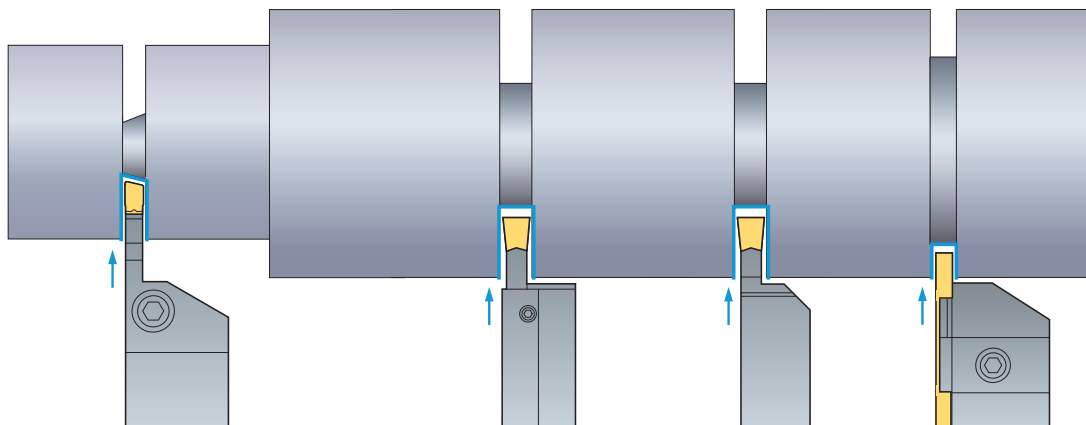

For face grooving

KGEVR/L	MGEVR/L
Width: 3.0~4.0 T-MAX: 4.0~8.0	Width: 1.5~8.0 T-MAX: 3.0~9.0
 KGMN  KGGN  KRMN  KRGN	 MGMN  MGGN  MRMN  MRGN

FGHH/FGVH	MGFHR/L, MGFVR/L	KGFHR/L, KGFVR/L
Width: 3.0~5.0 T-MAX: 12~25	Width: 3.0~4.0 T-MAX: 10~15	Width: 4.0 T-MAX: 20
 FGD  FGM  FMM	 MGMN  MFMN	 KGMN  KRMN  KGGN  KRGN

For parting off

KGEHR/L	MGEHR/L	KSPB	SPB-(S)	KGTB	PH
Width: 3.0 T-MAX: 20	Width: 2.0~5.0 T-MAX: 10~28	Width: 2.0~6.0 ØD-MAX: 35~125	Width: 2.0~6.0 ØD-MAX: 35~125	Width: 1.5~8.0 ØD-MAX: 26~120	Width: 3.0~5.0 ØD-MAX: 30~50
 KGMR/L	 MGMR/L	 KSP	 SP	 KGMN  KGGN-S-R	 POB

Turning and Grooving

Selection of insert

- Feed rate
 - Decide maximum feed rate after considering the insert's characteristics and machine capabilities ($F_{max} = W \times 0.075$)
 - Max feed rate should not be larger than the corner radius of the insert
 - In grooving applications, chip evacuation problems can be remedied by using step feed methods at small intervals
- Depth of cut
 - The minimum depth of cut should be bigger than corner radius of insert
 - When deciding on the max depth of cut please consider the machine's cutting load
 - Depending on the shape of the insert, deflection of work piece and clearance angle can be changed

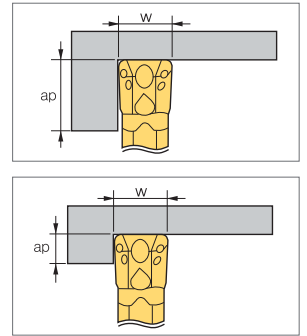

Notice for turning

- KGT/MGT tools are designed to incur side cutting force from its clearance angle; this feature gives you advantage over a standard ISO insert
- The standard MGT insert also provides a "wiper" effect to improve surface roughness

Notice for finishing (offset need final quality)

- After desired diameter is grooved, continuous turning operation might cause some deflection of the workpiece. In these cases follow the given formula, offsetting these factors enables the desired diameter that you want
- To eliminate the difference in the machined diameter by utilizing the clearance angle (which is commonly generated during the final turning operation) follow the directions above when machining
To obtain a good surface roughness without offsetting in an application follows the directions below
 - 1) Groove to the desired diameter
 - 2) Pull the tool backs a total distance of $\theta/2$
 - 3) Continue the external turning operation to desired diameter

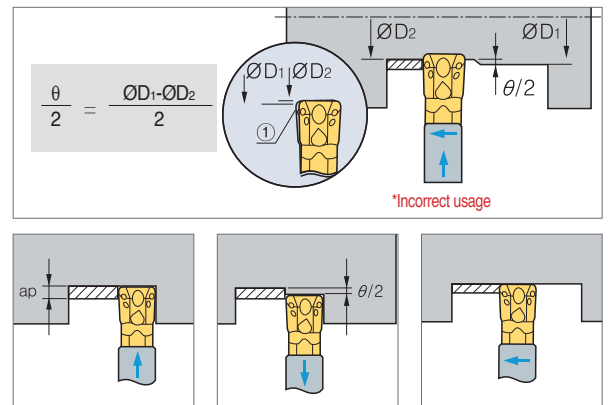

Notice for MGT turning applications

- KGT/MGT tools are available for grooving and turning as a multifunctional tool. When using a M.G.T tool keep in mind that the tool imitates a standard ISO turning application. The application uses a positive clearance angle where a tool's cutting force and depth of cut are all applied in an application. This might create normal wear on the insert, after turning, a grooving process might not meet the desired diameter on the work piece. To off set this, adjust the tool 0.004 inches and return to the original position of the grooving application

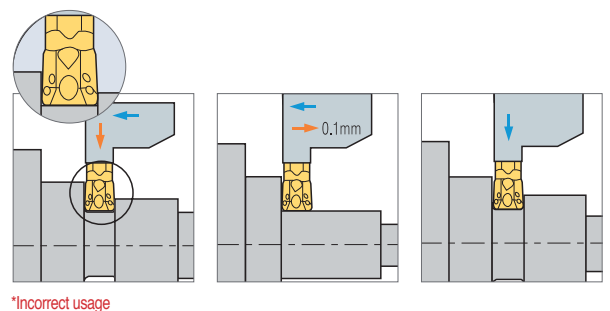

Machining workpiece with a radius bigger than the insert's corner radius

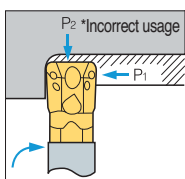

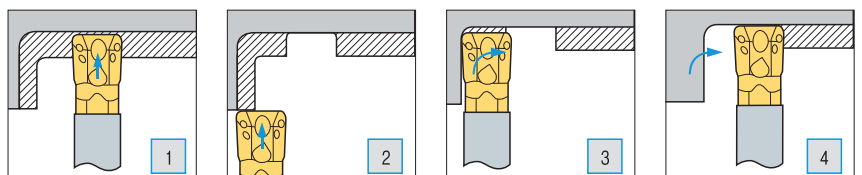

Stabilize your tool pressure. KGT/MGT tools create a cutting load when machining a workpiece with a radius larger than the corner radius of insert (shown in the picture). The unequal cutting force might initially break the insert or holder

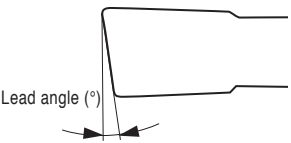

Parting off & Grooving

Insert

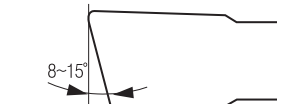
Lead angle applications	Lead angle 0° (Neutral)	Lead angle 4°~8°	Lead angle 8°~15°
			
<ul style="list-style-type: none"> • 4°- Pipe (Tubing and hollow bar) • 6°- Pipe and solid bar • 8°- Solid bar • 15°- Small diameter Solid bar 	<ul style="list-style-type: none"> • Parting off on solid bar type • Occurring the center stub when parting off • Prevent to be deflected workpiece by cutting direction during parting off • Available for use deep parting depth 	<ul style="list-style-type: none"> • Reduce the center stub when parting off on solid bar type • Reduce the burr when parting off on tubing or hollow bar type 	<ul style="list-style-type: none"> • Parting off on small diameter and hollow bar type • Reduce the burr and center stub when parting off on small diameter solid bar type
<p>※ Available Inserts: MGMR/L□□□ - □□ - LP/RP, KGMR/L□□□ - □□ - PS/PT (Lead angle) (Lead angle)</p>			

Selection of Insert

- To properly match the insert and cutting condition, the following factors should be considered
 - Width of insert
 - Chip breaker
 - Grade and nose R
- The relationship between the cutting width and cutting depth
 - Neutral type, inserts with a 0-degree lead angle are best when used an applications maximum depth of cut
 - In general alloy steel, the maximum depth of cut = $W \times 0.8$
- Insert with lead angle
 - To reduce burrs, we recommend using insert with a lead angle.
 - Insert that have larger lead angles reduce burrs but will also decreases tool life
 - In the case where burrs are acceptable, we recommend using a neutral type insert



Setting of holders

- The cutting position should be exactly mounted on machined axis in order to create a perpendicular direction or 90 to minimize vibration

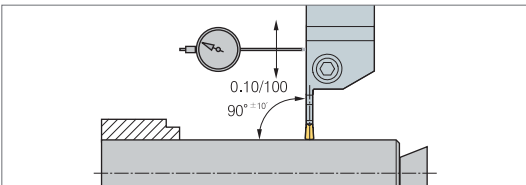

Setting of parting off

- The edge height of an insert should be set within ± 0.1 mm based on the center line
 - Parting off should be done as close to the chuck as possible to minimize vibration

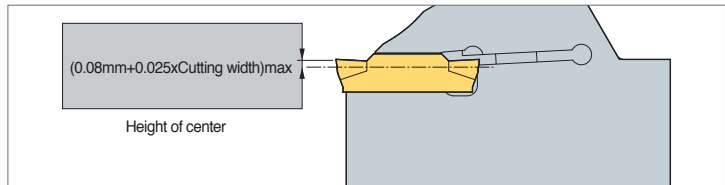

Notice

- Keep a consistent cutting speed and feed
- Use proper amounts of coolant for better performance
- Properly clean the insert pocket before mounting insert

Usage

- If insert is worn, immediately replace with a new insert. This is to prevent the damage on the workpiece
- If the holder seat is worn or damaged replace with a new one immediately for stable clamping
- Do not grind or regrind the holder seat

Selection of chip breaker

- Our chip breakers are designed to narrow chips during grooving operations. Narrow chips usually offer the following advantages
- Decreases friction between chips and the workpiece. This usually gives a better surface roughness finish
- With better chip flow, a machinist is able to increase feed rates due to a reduced cutting load

Face grooving tools

For shallow grooving

- Economical tools utilizing a double ended cutting edge system
- Newly designed chip breakers that help ensure chip control for various face grooving applications
- Korloy face grooving tools provide various holder line-ups to give you more options and benefits

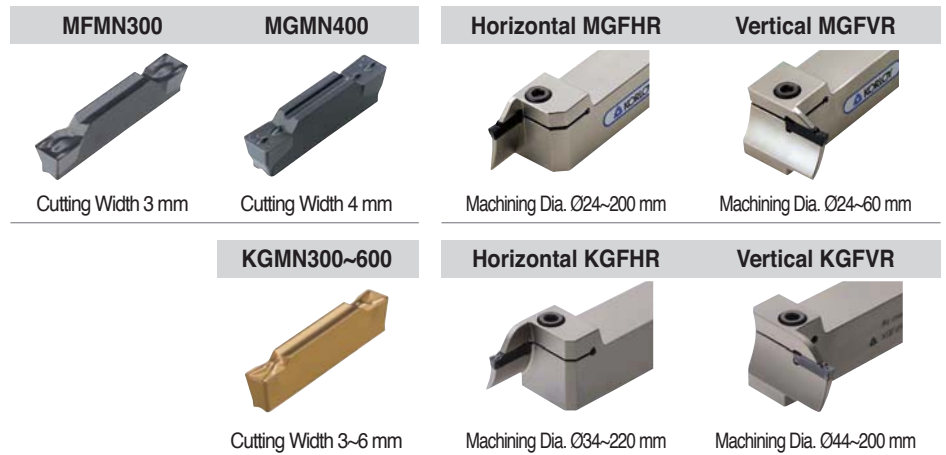

For deep grooving

- These tools are suitable for deep grooving with a single cutting edge (T_{max} 25 mm)
- A variety of chip breakers enable a machinist to apply a wide range of functions in machining
- A variety of holders ensures multiple application ranges

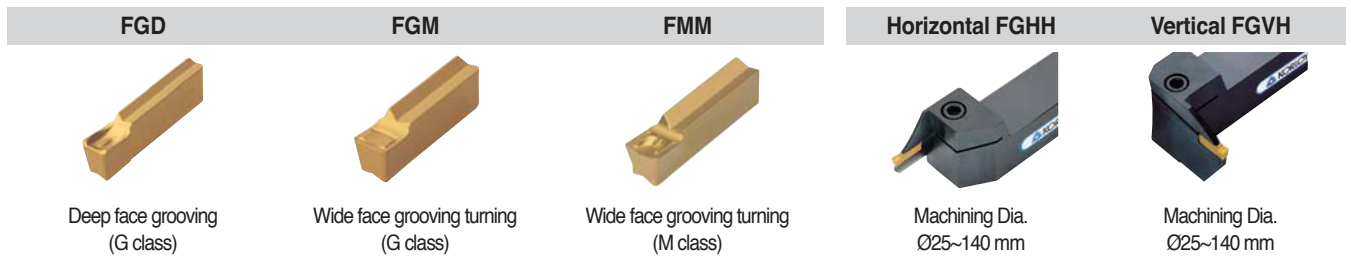

Selection system of holder

- Follow these 3 simple directions to choose the right insert and holder for your application

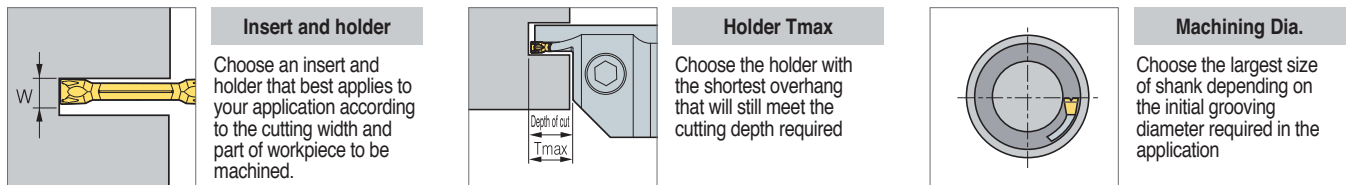

Notice: To minimize chattering, use the shortest holder according to T_{max} .

Optimization of face grooving

Roughing: When face grooving decreases the cutting speed 40% below a normal face turning operation

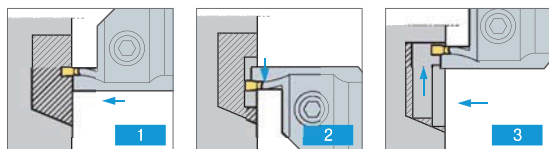

- Grooving at the initial diameter
- Face turning away from center
- Face turning to center

Finishing: When face grooving decreases the cutting speed 40% below a normal face turning operation

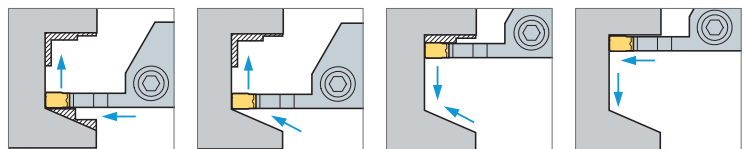

- Grooving at the initial diameter to the final cutting depth and face turning away from center
- Radius operation toward final dimension at the bottom
- Face turning to center
- Grooving for the right dimension you want

Notice for face grooving

- Before machining, check and adjust the following holder position

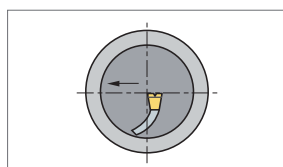

- Check the cutting edge height at the center of the workpiece
- Machine towards the center and check for burrs

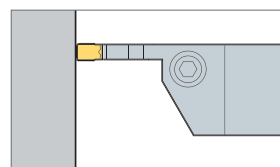

- For better surface roughness, set up the insert in order to perpendicular at center line

Multi-functional machining with strong clamping system and new technology

KGT

- Double-sided inserts of KGT reduces machining cost
- Strong clamping system ensures stable and accurate machining
- New grade and new technology provide superior tool life
- Various tooling solutions of the KGT improve productivity
- The foreside and clearance face of the KGT insert having cutting edges are optimal for grooving, parting-off, turning and facing with reducing processing time
- Three-dimensional chip breaker ensures excellent chip control in various applications
- The KGT inserts with various chip breakers are available for wide application range
- Special cutting edges are available for quotation

Insert code system

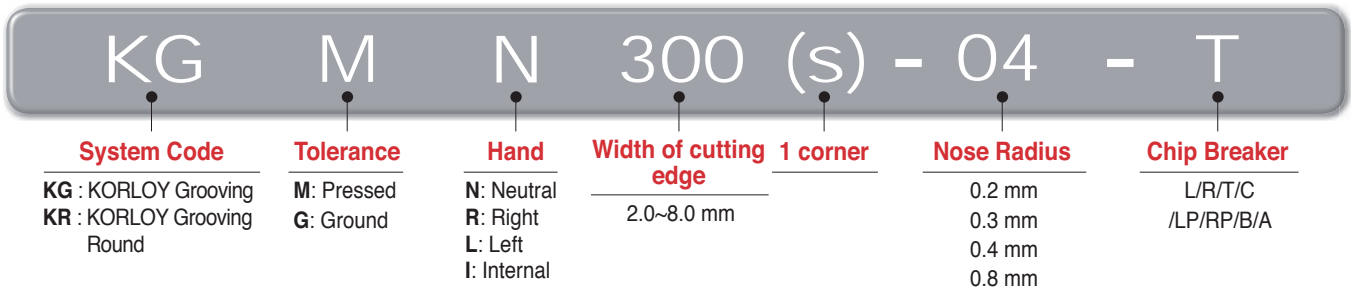



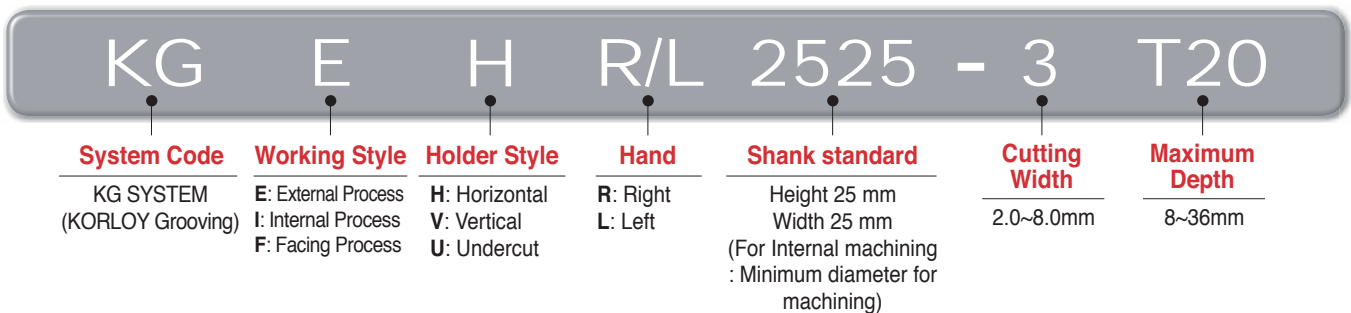



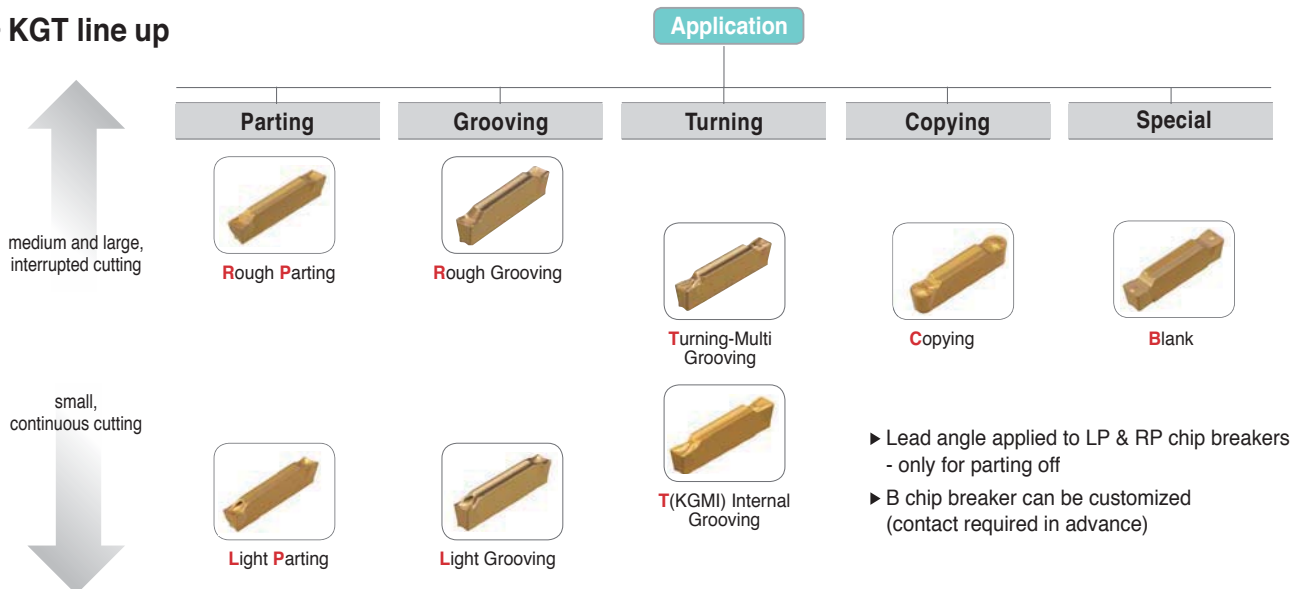



Holder code system



KGT line up



Recommended insert

Designation	Geometry	Picture	Application									
			For external machining			For face grooving		For Internal machining		Copying	For relief	Special machining
			Parting	Grooving	Turning	Grooving	Turning	Grooving	Turning	Copying	Relieving	Special
KGMN	L Light Grooving		○	◎		○						
	R Rough Grooving		○	◎		○						
	T Turning-Multi Grooving		○	◎	◎	◎	◎					
KGMI	T Internal Grooving							◎	◎			
KRMN	C Copying									◎	◎	
KGMRL	LP Light Parting		◎									
	RP Rough Parting		◎									
KGGN	B Blank			○								◎
	A Aluminum Grooving		○	◎	○							
KRGN	A Aluminum Profiling									◎	◎	
KRMI	C Copying									◎	◎	

◎ First choice, ○ Second choice

Features

Front View



- Strong clamping → Higher machining reliability
- Self-centering → Higher accuracy
- Anti-chattering design → Fine surface finish

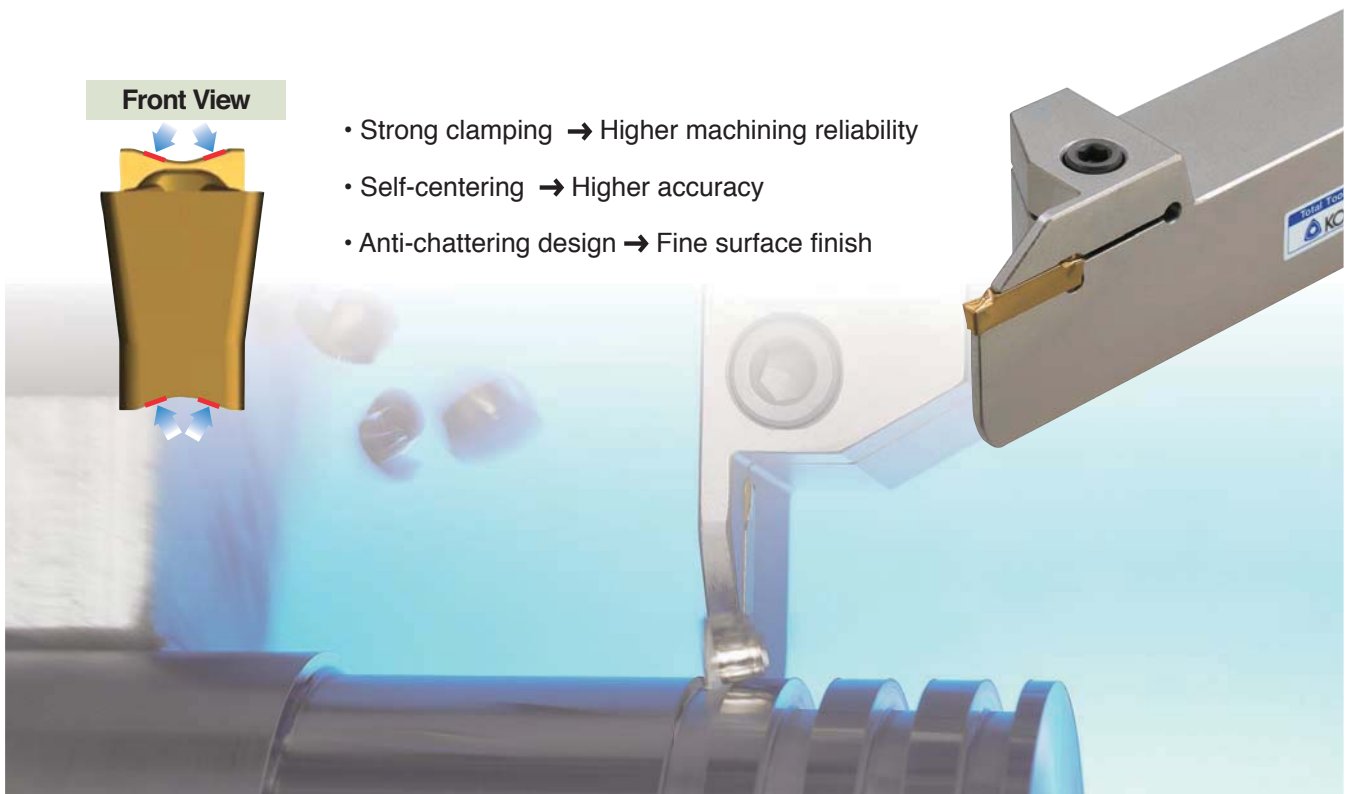

C/B guide

L For **L**ight Grooving

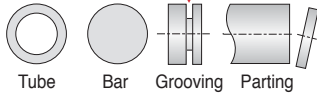

- Sharp cutting edge
- Low feed machining
- Small diameter component
- Low carbon steel
- Alloy steel
- Stainless

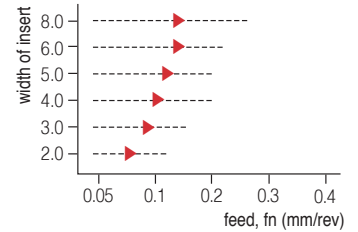

R For **R**ough Grooving

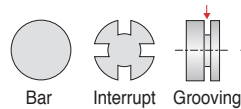
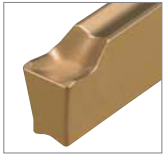

- Strong cutting edge
- High feed machining
- Interrupted cutting
- Carbon steel
- Alloy steel
- Stainless
- Cast iron

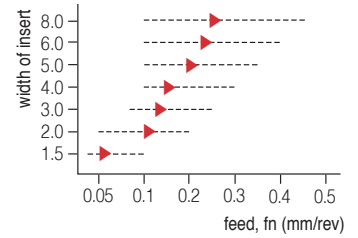

T For **T**urning and Multi Grooving

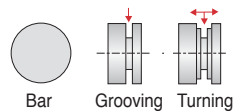

- Sharp cutting edge
- Improved chip control
- Turning & grooving machining
- Carbon steel
- Alloy steel
- Stainless
- Cast iron

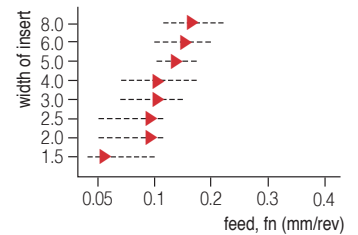

C For **C**opying and Relief

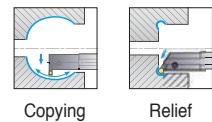

- Improved chip control
- Copying
- Relief
- Carbon steel
- Alloy steel
- Stainless
- Cast iron

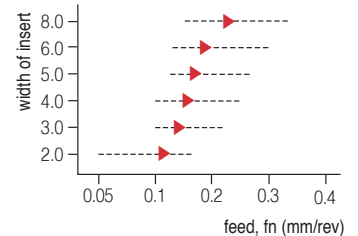

LP For **L**ight **P**arting

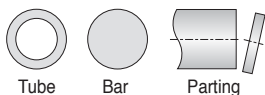

- Sharp cutting edge
- Low feed machining
- Small diameter component
- Right/left handed
- Low carbon steel
- Carbon steel
- Alloy steel
- Stainless

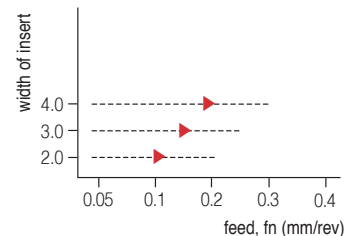

RP For **R**ough **P**arting

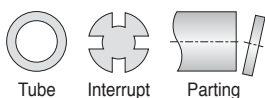

- Strong cutting edge
- High feed machining
- Interrupted cutting
- Right/left handed
- Carbon steel
- Alloy steel
- Cast iron

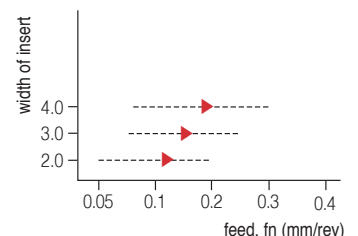

C Technical Information for KGT

B For Precision Grooving

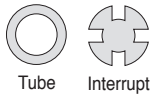

- Ground insert
- Precise tolerance
- Various cutting edge length, Nose R

- Carbon steel
- Alloy steel
- Stainless
- Cast iron

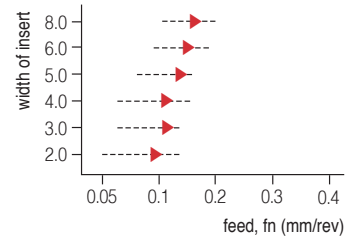

A For Aluminum Grooving



- Sharp cutting edge
- Precise tolerance

- Aluminum alloy
- Copper alloy

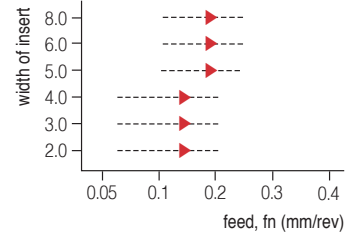

Grades for recommended application range

Workpiece	Grade	Order of recommended grade	Recommended cutting speed (m/min)					
			50	100	150	200	800	
P Steel Alloy Steel	PC5300	1		70	120			
	NC3225	2			130	220		
	NC5330	3			120	200		
	PC5300	1	60	105				
	NC3225	2			130	200		
	NC5330	3		90	180			
M Stainless steel	PC5300	1		70	120			
	PC9030	2		70	115			
	NC5330	3		75	125			
K Cast iron	PC5300	1	55	90				
	NC5330	2		95	160			
N Non-ferrous metal	H01	1				200	790	
S HRSA	PC5300	1	20	35				



Performance evaluation

Multi-function machining

Turning + Grooving repetition

Optimized geometry for turning + grooving - High efficiency.

- **Workpiece** SM45C
- **Cutting condition**
 - vc = 170 (m/min)
 - fn = 0.15 (mm/rev)
 - ap = 2 mm
 - W = 3 mm
 - wet
- **Designation** KGMN300-04-T (PC5300)

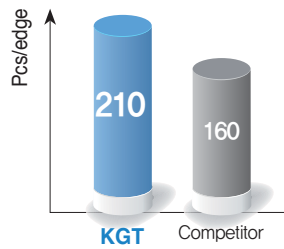

30% Up

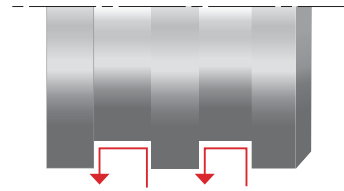

Grooving

Shoulder Grooving

Tough geometry for interrupted and deep grooving.

- **Workpiece** SUS304
- **Cutting condition**
 - vc = 120 (m/min)
 - fn = 0.12 (mm/rev)
 - ap = 5 mm
 - W = 4 mm
 - wet
- **Designation** KGMN400-03-R (PC5300)

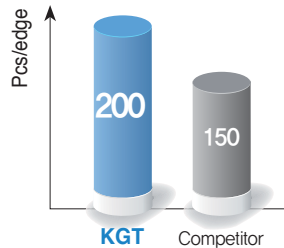

30% Up

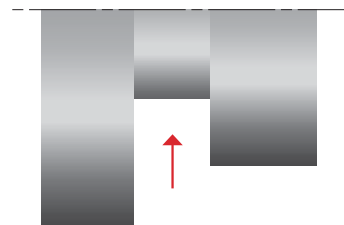

Shaft machining

Grooving (Roughing) & Turning (Finishing)

Excellent chip control for higher efficiency.

- **Workpiece** SCM440
- **Cutting condition**
 - vc = 150 (m/min)
 - fn = 0.15 (mm/rev)
 - ap = 5 mm
 - W = 3 mm x 3
 - wet
- **Designation** KGMN300-04-T (PC5300)

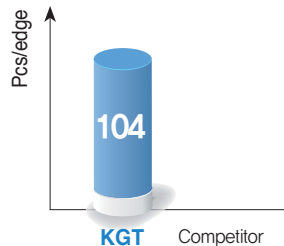

30% Up

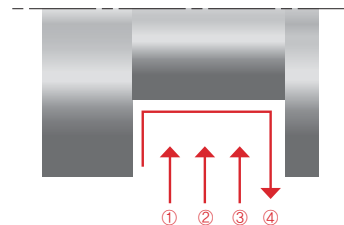

Parting off

Pipe Parting-off

Exclusive parting-off chip breaker for longer tool life. / Sharp geometry for less burr.

- **Workpiece** SUS304
- **Cutting condition**
 - vc = 140 (m/min)
 - fn = 0.15 (mm/rev)
 - ap = 2 mm
 - W = 3 mm
 - wet
- **Designation** KGMR300-6D-LP (PC5300)

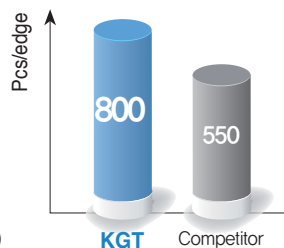



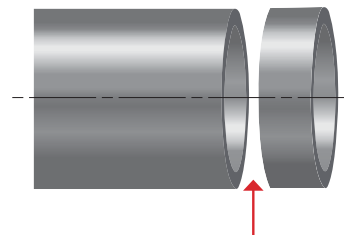





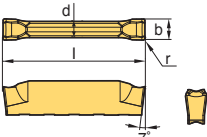

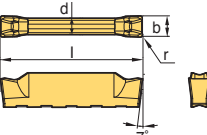

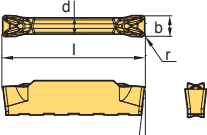

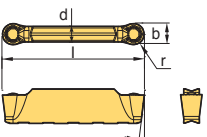
45% Up

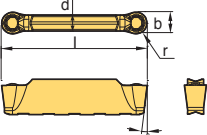

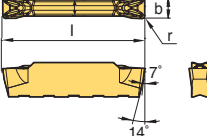
C Available Insert for KGT

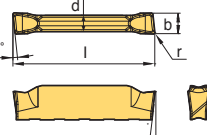
Insert

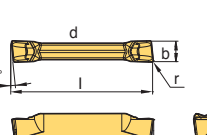









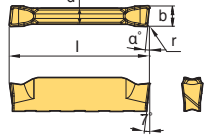

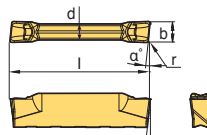
Application	Picture	Designation	Coated						Dimensions (mm)					Configuration	Page		
			NC3215	NC3225	NC5330	NC6315	PC5300	PC9030	b	r	l	d	α°				
Grooving		KGMN 200-02-L 300-02-L 400-02-L 500-03-L 600-03-L		●	●		●	●	2.0	0.2	20	1.7	-		C14~21 C23		
				●	●		●	●	3.0	0.2	20	2.3	-				
				●	●		●	●	4.0	0.2	20	3.3	-				
				●	●		●	●	5.0	0.3	25	4.1	-				
				●	●		●	●	6.0	0.3	25	5.1	-				
Grooving · Parting off		KGMN 150-015-R 200-02-R 300-02-R 400-03-R 500-03-R 600-03-R 800-04-R		●	●		●		1.5	0.15	16	1.2	-		C14~21 C23		
				●	●		●	●	2.0	0.2	20	1.7	-				
				●	●		●	●	3.0	0.2	20	2.3	-				
				●	●		●	●	4.0	0.3	20	3.3	-				
					●		●		5.0	0.3	25	4.1	-				
					●		●		6.0	0.3	25	5.1	-				
					●		●		8.0	0.4	30	6.1	-				
Grooving · Turning		KGMN 150-015-T 200-02-T 250-02-T 300-02-T 04-T 400-04-T 08-T 500-04-T 08-T 600-04-T 08-T 800-08-T		●	●	●	●		1.5	0.15	16	1.2	-		C14~21 C23		
				●	●	●	●	●	2.0	0.2	20	1.7	-				
				●	●		●		2.5	0.2	20	2.0	-				
				●	●	●	●	●	3.0	0.2	20	2.3	-				
				●	●	●	●	●	4.0	0.4	20	3.3	-				
				●	●	●	●	●	4.0	0.8	20	3.3	-				
				●	●	●	●	●	5.0	0.4	25	4.1	-				
				●	●	●	●	●	5.0	0.8	25	4.1	-				
				●	●	●	●	●	6.0	0.4	25	5.1	-				
				●	●	●	●	●	6.0	0.8	25	5.1	-				
				●		●	●		8.0	0.8	30	6.1	-				
Relief Profiling		KRMN 200-C 300-C 400-C 500-C 600-C 800-C		●	●	●	●		2.0	1.0	20	1.7	-		C14~22		
				●	●		●		3.0	1.5	20	2.2	-				
				●	●	●	●		4.0	2.0	20	3.2	-				
				●	●	●	●		5.0	2.5	25	4.0	-				
				●	●	●	●		6.0	3.0	25	5.0	-				
Profiling		KRMI 200-C 300-C 400-C							2.0	1.0	20	1.7	-		C23		
										3.0	1.5	20	2.2			-	
										4.0	2.0	20	3.2			-	
Grooving · Internal		KGMI 200-02-T 300-04-T 400-04-T					●		2.0	0.2	20	1.7	-		C23		
							●		3.0	0.4	20	2.3	-				
							●		4.0	0.4	20	3.3	-				
Parting off (Right handed)		KGMR 200-6D-LP 8D-LP 15D-LP 300-6D-LP 15D-LP 400-4D-LP 15D-LP 500-4D-LP			●		●		2.0	0.2	20	1.7	6		C14 C16		
							●		●		2.0	0.2	20			1.7	8
						●		●		2.0	0.2	20	1.7			15	
						●		●		3.0	0.2	20	2.3			6	
						●		●		3.0	0.2	20	2.3			15	
						●		●		4.0	0.3	20	3.3			4	
Parting off (Right handed)		KGMR 200-6D-RP 8D-RP 15D-RP 300-6D-RP 15D-RP 400-4D-RP 15D-RP 500-4D-RP			●		●		2.0	0.2	20	1.7	6		C14 C16		
							●		●		2.0	0.2	20			1.7	8
						●		●		2.0	0.2	20	1.7			15	
						●		●		3.0	0.2	20	2.3			6	
						●		●		3.0	0.2	20	2.3			15	
						●		●		4.0	0.3	20	3.3			4	

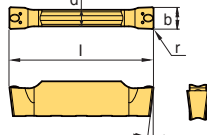
* You can grind the chip breaker, 'B' as any shape you want. If you want any special shape of chip breaker, please contact your distributor.

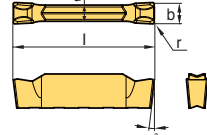
● : Stock item

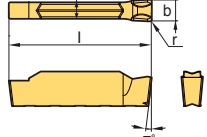

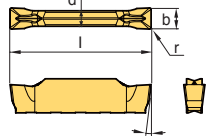
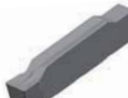
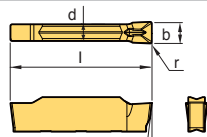
Insert

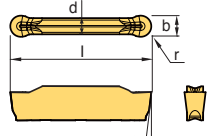
Application	Picture	Designation	Coated				Uncoated		Dimensions (mm)					Configuration	Page
			NC3215	NC5330	PC5300	PC9030	H01	H05	b	r	l	d	α°		
Parting off (Left handed)		KGML 200-6D-LP							2.0	0.2	20	1.7	6		C14 C16
		15D-LP							2.0	0.2	20	1.7	15		
		300-6D-LP							3.0	0.2	20	2.3	6		
		15D-LP							3.0	0.2	20	2.3	15		
		400-4D-LP							4.0	0.2	20	3.3	4		
		15D-LP						4.0	0.2	20	3.3	15			
Parting off (Left handed)		KGML 200-6D-RP							2.0	0.2	20	1.7	6		C14 C16
		15D-RP							2.0	0.2	20	1.7	15		
		300-6D-RP							3.0	0.2	20	2.3	6		
		15D-RP							3.0	0.2	20	2.3	15		
		400-4D-RP							4.0	0.2	20	3.3	4		
		15D-RP						4.0	0.2	20	3.3	15			
Grooving(Ground insert)		KGGN 265-015-B							2.65	0.15	20	2.3	-		C14 C16~18
		300-020-B							3.0	0.20	20	2.3	-		
		040-B							3.0	0.40	20	2.3	-		
		315-015-B							3.15	0.15	20	2.3	-		
		400-040-B							4.0	0.40	20	3.3	-		
		080-B							4.0	0.80	20	3.3	-		
		415-015-B							4.15	0.15	20	3.3	-		
		478-055-B							4.78	0.55	20	3.3	-		
		500-080-B							5.0	0.80	25	4.1	-		
		515-015-B							5.15	0.15	25	4.1	-		
		600-080-B							6.0	0.80	25	5.1	-		
		120-B						6.0	1.20	25	5.1	-			
		800-080-B						8.0	0.80	30	6.1	-			
		120-B						8.0	1.20	30	6.1	-			
Grooving · Parting off (Ground insert)		KGGN 200-02-R							2.0	0.2	20	1.7	-		C14~21
		300-02-R							3.0	0.2	20	2.3	-		
		400-03-R							4.0	0.3	20	3.3	-		
		500-03-R							5.0	0.3	25	4.1	-		
		600-03-R							6.0	0.3	25	5.1	-		
		800-04-R							8.0	0.4	30	6.1	-		
Grooving · Parting off (Single insert)		KGGN 200S-02-R							2.0	0.2	19.9	1.7	-		C24
		300S-02-R			●				3.0	0.2	19.9	2.3	-		
		400S-03-R			●				4.0	0.3	19.9	3.3	-		
		500S-03-R			●				5.0	0.3	24.9	4.1	-		
		600S-03-R			●				6.0	0.3	24.9	5.1	-		
		800S-04-R			●				8.0	0.4	24.9	6.1	-		
Aluminum Grooving		KGGN 200-02-A					●		2.0	0.2	20	1.7	-		C14~21
		300-02-A					●		3.0	0.2	20	2.3	-		
		400-04-A					●		4.0	0.4	20	3.3	-		
		500-04-A					●		5.0	0.4	25	4.1	-		
		600-04-A					●		6.0	0.4	25	5.1	-		
Aluminum Grooving (Single insert)		KGGN 200S-02-A							2.0	0.2	20	1.7	-		C24
		300S-02-A							3.0	0.2	20	2.3	-		
		400S-04-A							4.0	0.4	20	3.3	-		
		500S-04-A							5.0	0.4	25	4.1	-		
		600S-04-A							6.0	0.4	25	5.1	-		
Aluminum Grooving		KRGN 300-A					●		3.0	1.5	20	2.3	-		C14~21
		400-A					●		4.0	2.0	20	3.3	-		
		500-A					●		5.0	2.5	25	4.1	-		
		600-A					●		6.0	3.0	25	5.1	-		
		800-A					●		8.0	4.0	30	6.1	-		

• You can grind the chip breaker, 'B' as any shape you want. If you want any special shape of chip breaker, please contact your distributor.

● : Stock item



KGEHR/L

For grooving, turning, parting off, and relief machining



KGGN
 KGMR/L
 KRGN

KGMN
 KRMN

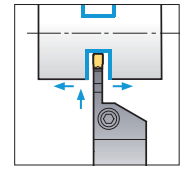
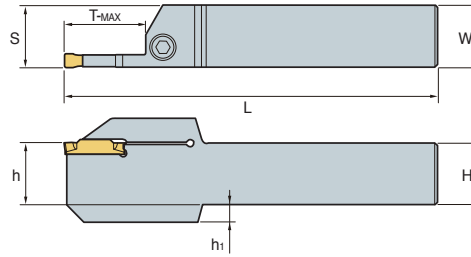
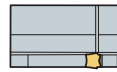

• R type insert (mm)

Designation		H = (h)	W	L	S	h ₁	T-MAX	Inserts	Screw	Wrench
KGEHR/L	1616-1.5-T14	16	16	100	16.2	-	14	KGMN150-□-□	MHA0512	HW40L
	2020-1.5-T14	20	20	125	20.2	-	14			
	2525-1.5-T14	25	25	150	25.2	-	14			
	1212-2-T08	12	12	100	12.2	-	8	KGMN200-□-□ KGMR/L200-□-□ KRMN200-C KGGN200-□-□	MHA0512	HW40L
	1616-2-T08	16	16	100	16.2	-	8			
	2020-2-T08	20	20	125	20.2	-	8			
	2525-2-T08	25	25	150	25.2	-	8			
	1616-2-T12	16	16	100	16.2	-	12			
	2020-2-T12	20	20	125	20.2	-	12			
	2525-2-T12	25	25	150	25.2	-	12			
	1616-2-T17	16	16	100	16.2	-	17			
	2020-2-T17	20	20	125	20.2	-	17			
	2525-2-T17	25	25	150	25.2	-	17			
	1616-2.5-T17	16	16	100	16.3	-	17	KGMN250-□-□	MHA0512	HW40L
	2020-2.5-T17	20	20	125	20.3	-	17			
	2525-2.5-T17	25	25	150	25.3	-	17			
	1616-3-T10	16	16	100	16.4	-	10	KGMN300-□-□ KGMR/L300-□-□ KRMN300-C KGGN300-□-□ KRGN300-□	MHA0512	HW40L
	2020-3-T10	20	20	125	20.4	-	10			
	2525-3-T10	25	25	150	25.4	-	10			
	3232-3-T10	32	32	170	32.4	-	10			
	1616-3-T13	16	16	100	16.4	-	13			
	2020-3-T13	20	20	125	20.4	-	13			
	2525-3-T13	25	25	150	25.4	-	13			
	1616-3-T20	16	16	100	16.4	-	20			
	2020-3-T20	20	20	125	20.4	-	20			
	2525-3-T20	25	25	150	25.4	-	20			
	3232-3-T20	32	32	170	32.4	-	20	KGMN400-□-□ KGMR/L400-□-□ KRMN400-C KGGN400-□-□ KRGN400-□	BHA0616	HW50L
	2525-3-T25	25	25	150	25.4	-	25			
1616-4-T10	16	16	100	16.4	-	10				
2020-4-T10	20	20	125	20.4	-	10				
2525-4-T10	25	25	150	25.4	-	10				
3232-4-T10	32	32	150	32.4	-	10				
1616-4-T15	16	16	100	16.4	-	15				
2020-4-T15	20	20	125	20.4	-	15				
2525-4-T15	25	25	150	25.4	-	15				
1616-4-T20	16	16	100	16.4	-	20				
2020-4-T20	20	20	125	20.4	-	20				
2525-4-T20	25	25	150	25.4	-	20				
3232-4-T20	32	32	170	32.4	-	20				
1616-4-T25	16	16	100	16.4	-	25				
2020-4-T25	20	20	125	20.4	-	25				
2525-4-T25	25	25	150	25.4	-	25				

↻ Applicable inserts C12~C13



KGEHR/L

For grooving, turning, parting off, and relief machining



KGGN KGMN
KGMR/L KRMN
KRGN

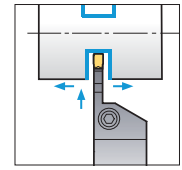
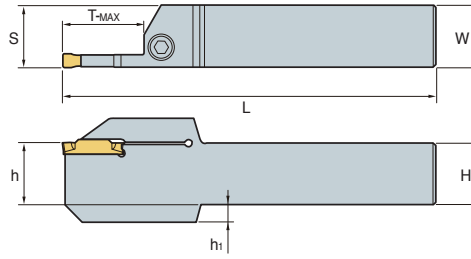
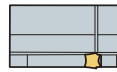

• R type insert
(mm)

Designation		H = (h)	W	L	S	h ₁	T-MAX	Inserts	Screw	Wrench		
KGEHR/L	2020-5-T12	20	20	125	20.5	-	12	KGMN500-□-□ KRMN500-C KGGN500-□-□ KRGN500-□	BHA0616	HW50L		
	2525-5-T12	25	25	150	25.5	-	12					
	2020-5-T15	20	20	125	20.55	-	15					
	2525-5-T15	25	25	150	25.55	-	15					
	3232-5-T15	32	32	170	32.55	-	15					
	2020-5-T20	20	20	125	20.5	-	20					
	2525-5-T20	25	25	150	25.5	-	20					
	3232-5-T20	32	32	170	32.5	-	20					
	2525-5-T32	25	25	150	25.5	7	32				BHA0620	HW50L
	2020-6-T12	20	20	125	20.5	-	12				KGMN600-□-□ KRMN600-C KGGN600-□-□ KRGN600-□	BHA0616
	2525-6-T12	25	25	150	25.5	-	12					
	2525-6-T15	25	25	150	25.55	-	15					
	3232-6-T15	32	32	170	32.55	-	15					
	2020-6-T20	20	20	125	20.5	-	20					
	2525-6-T20	25	25	150	25.5	-	20					
	3232-6-T20	32	32	170	32.5	-	20					
	2525-6-T32	25	25	150	25.5	7	32	BHA0620	HW50L			
	2525-8-T16	25	25	150	26	-	16	KGMN800-□-□ KRMN800-C KGGN800-□-□ KRGN800-□	BHA0616	HW50L		
	3232-8-T16	32	32	170	33.05	-	16					
	2525-8-T25	25	25	150	26	-	25					
3232-8-T25	32	32	170	33	-	25						
2525-8-T36	25	25	150	26	7	36	BHA0620				HW50L	
3232-8-T36	32	32	170	33	-	36						

➔ Applicable inserts C12~C13

KGEHR/L-D00A (Auto Tool)

For grooving, turning, parting off machining



KGGN KGMN
KGMR/L KRMN

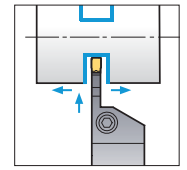
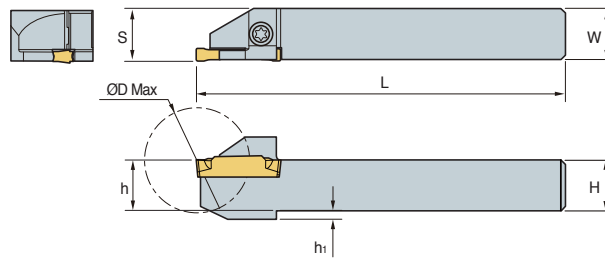

• R type insert

(mm)

Designation	H = (h)	W	L	S	h ₁	ØD Max	Inserts	Screw	Wrench	
KGEHR/L	1010-2-D20A	10	10	125	10.2	2	20	KGMN200-□-□ KGMR/L200-□-□ KRMN200-C KGGN200-□-□		
	1212-2-D25A	12	12	125	12.2	2	25			
	1414-2-D25A	14	14	125	14.2	-	25			
	1616-2-D32A	16	16	125	16.2	-	32			
	1212-3-D25A	12	12	125	12.4	2	25			
	1616-3-D32A	16	16	125	16.4	-	32			
								ETNA0412	TW15L	

↻ Applicable inserts C12~C13

KGEHR/L-D00B (Auto Tool)

For grooving, turning, parting off machining



KGGN KGMN
KRMN KGMR/L

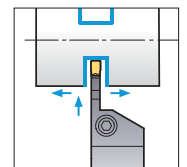
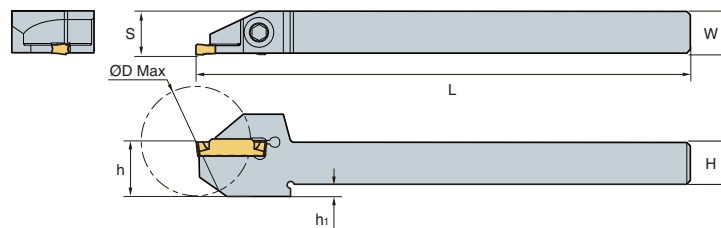

• R type insert

(mm)

Designation	H = (h)	W	L	S	h ₁	ØD Max	Inserts	Screw	Wrench	
KGEHR/L	1010-2-D30B	10	10	140	10.2	6.6	30	KGMN200-□-□ KGMR/L200-□-□ KRMN200-C KGGN200-□-□		
	1212-2-D25B	12	12	140	12.5	3.5	25			
	1212-2-D30B	12	12	140	12.2	3.5	30			
	1616-2-D25B	16	16	140	16.2	-	25			
	1616-2-D32B	16	16	140	16.2	-	32			
	1212-3-D25B	12	12	140	12.4	3.5	25			
	1212-3-D32B	12	12	140	12.4	3.5	32			
	1616-3-D25B	16	16	140	16.4	-	25			
	1616-3-D32B	16	16	140	16.4	-	32			

↻ Applicable inserts C12~C13



KGEHR/L-T00

For grooving, turning, face grooving machining



KG MN KR MN
KG GN KR GN

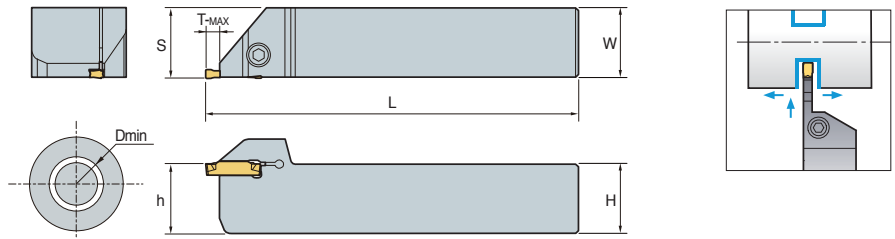

• R type insert
(mm)

Designation		H = (h)	W	L	S	ØD Min	T-MAX	Inserts	Screw	Wrench
KGEHR/L	1616-3-T00	16	16	100	16.4	80	4.8	KG MN300-□-□ KR MN300-C KG GN300-□-□ KR GN300-□	MHA0512	HW40L
	2020-3-T00	20	20	125	20.4	80	4.8			
	2525-3-T00	25	25	150	25.4	80	4.8			
	1616-4-T00	16	16	100	16.4	80	4.8	KG MN400-□-□ KR MN400-C KG GN400-□-□ KR GN400-□	BHA0616	HW50L
	2020-4-T00	20	20	125	20.4	80	4.8			
	2525-4-T00	25	25	150	25.4	80	4.8			
	2020-6-T00	20	20	125	20.5	80	6.0	KG MN600-□-□ KR MN600-C KG GN600-□-□ KR GN600-□	BHA0616	HW50L
	2525-6-T00	25	25	150	25.5	80	6.0			

↻ Applicable inserts C12~C13

KGEVR/L-T00

For grooving, turning, face grooving machining



KGMN
KRGV

KRMN
KGGN

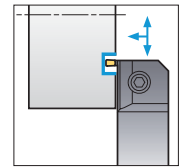
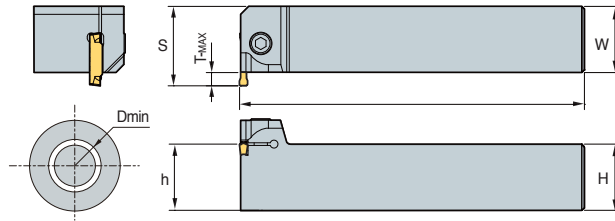

• R type insert

Designation		H = (h)	W	L	S	ØD Min	T-MAX	Inserts	Screw	Wrench
KGEVR/L	2020-1.5 -T00	20	20	125	23.5	120	3	KGMN150-□-□	MHA0512	HW40L
	2525-1.5 -T00	25	25	150	28.5	120	3			
	3232-1.5 -T00	32	32	170	35.5	120	3			
KGEVR/L	2020-2 -T00	20	20	125	23.5	120	3	KGMN200-□-□ KRMN200-C KGGN200-□-□-□	MHA0512	HW40L
	2525-2 -T00	25	25	150	28.5	120	3			
	3232-2 -T00	32	32	170	35.5	120	3			
KGEVR/L	2020-2.5 -T00	20	20	125	24.5	80	4	KGMN250-□□	MHA0512	HW40L
	2525-2.5 -T00	25	25	150	29.5	80	4			
	3232-2.5 -T00	32	32	170	36.5	80	4			
KGEVR/L	2020-3-T00	20	20	125	25	80	4.8	KGMN300-□-□ KRMN300-C KGGN300-□-□	MHA0512	HW40L
	2525-3-T00	25	25	150	30	80	4.8			
	3232-3 -T00	32	32	170	37	80	4.8			
KGEVR/L	2020-4-T00	20	20	125	25	80	4.8	KGMN400-□-□ KRMN400-C KGGN400-□-□	BHA0616	HW50L
	2525-4-T00	25	25	150	30	80	4.8			
	3232-4 -T00	32	32	170	37	80	4.8			
KGEVR/L	2020-5 -T00	20	20	125	29.5	60	6	KGMN500-□-□ KRMN500-C KGGN500-□-□	BHA0616	HW50L
	2525-5 -T00	25	25	150	31.5	60	6			
	3232-5 -T00	32	32	170	38.5	60	6			
KGEVR/L	2020-6 -T00	20	20	125	26.5	60	6	KGMN600-□-□ KRMN600-C KGGN600-□-□	BHA0616	HW50L
	2525-6-T00	25	25	150	31.5	80	6			
	3232-6 -T00	32	32	170	38.5	60	6			
KGEVR/L	2525-8 -T00	25	25	150	33.5	50	8	KGMN800-□-□ KRMN800-C KGGN800-□-□	BHA0616	HW50L
	3232-8 -T00	32	32	170	38.5	50	8			

↻ Applicable inserts C12~C13

KGEUR/L



KRMN
KRGN

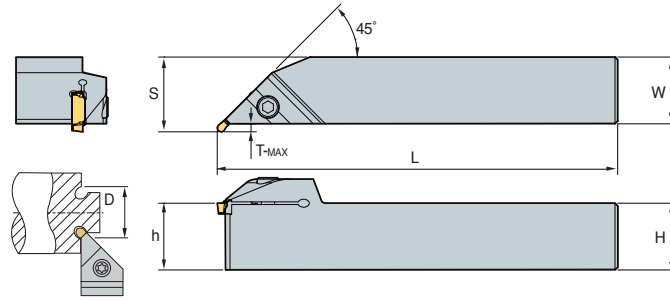

For relief machining

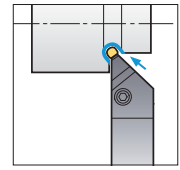

• R type insert
(mm)

Designation		H = (h)	W	L	S	ØD Min	T-MAX	Inserts	Screw	Wrench
KGEUR/L	1616-3	16	16	100	19	40	2.8	KRMN300-C KRGN300-□	MHA0512	HW40L
	2020-3	20	20	125	23	40	2.8			
	2525-3	25	25	150	28	40	2.8			
	3232-3	32	32	170	35	40	2.8	KRMN400-C KRGN400-□	BHA0616	HW50L
	1616-4	16	16	100	19	40	2.8			
	2020-4	20	20	125	23	40	2.8			
	2525-4	25	25	150	28	40	2.8	KRMN500-C KRGN500-□	BHA0616	HW50L
	3232-4	32	32	170	35	40	2.8			
	2020-5	20	20	125	23.5	50	3.3			
	2525-5	25	25	150	28.5	50	3.3	KRMN600-C KRGN600-□	BHA0616	HW50L
	3232-5	32	32	170	35.5	50	3.3			
	2020-6	20	20	125	23.5	50	3.3			
	2525-6	25	25	150	28.5	50	3.3	KRMN800-C KRGN800-□	BHA0616	HW50L
	3232-6	32	32	170	35.5	50	3.3			
	2525-8	25	25	150	28.5	65	3.3			
	3232-8	32	32	170	35.5	65	3.3			

↻ Applicable inserts C12~C13

KGFR/L



KG MN
KG GN KR MN
 KR GN

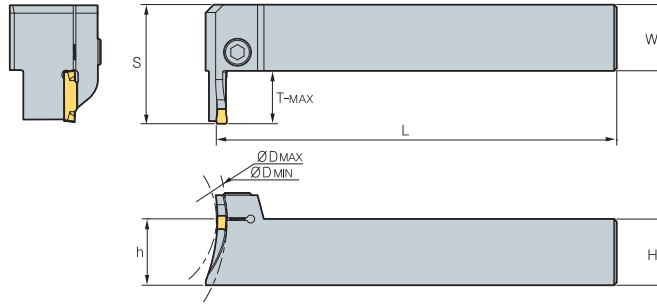

For face grooving machining

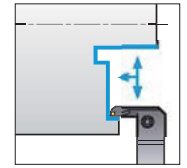

• R type insert

(mm)

Designation	H = (h)	W	L	S	T-MAX	ØD		Inserts	Screw	Wrench	
						Min	Max				
KGFVR/L 325-34/50-T10	25	25	150	36	10	34	50	KG MN300-□-□ KR MN300-C KG GN300-□-□ KR GN300-□	MHA0512	HW40L	
	44/60-T15	25	25	150	41	15	44	60			
	54/85-T15	25	25	150	41	15	54	85			
425-32/50-T15	25	25	150	41	15	32	50	KG MN400-□-□ KR MN400-C KG GN400-□-□ KR GN400-□	BHA0616	HW50L	
	42/60-T15	25	25	150	41	15	42				60
	44/70-T20	25	25	150	45.5	20	44				70
	52/85-T15	25	25	150	41	15	52				85
	60/120-T20	25	25	150	45.5	20	60				120
525-50/80-T20	25	25	150	46	20	50	80	KG MN500-□-□ KR MN500-C KG GN500-□-□ KR GN500-□	BHA0616	HW50L	
	70/110-T20	25	25	150	46	20	70				110
	100/150-T20	25	25	150	46	20	100				150
	140/200-T20	25	25	150	46	20	140				200
	200-T20	25	25	150	46	20	200				∞
625-48/85-T20	25	25	150	46	20	48	85	KG MN600-□-□ KR MN600-C KG GN600-□-□ KR GN600-□	BHA0616	HW50L	
	73/150-T20	25	25	150	46	20	73				150
	138/250-T20	25	25	150	46	20	138				250
	250-T20	25	25	150	46	20	250				∞

↻ Applicable inserts C12~C13

KGFHR/L

For face grooving machining



KGMN
KGGN KRMN
KRGN

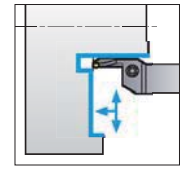
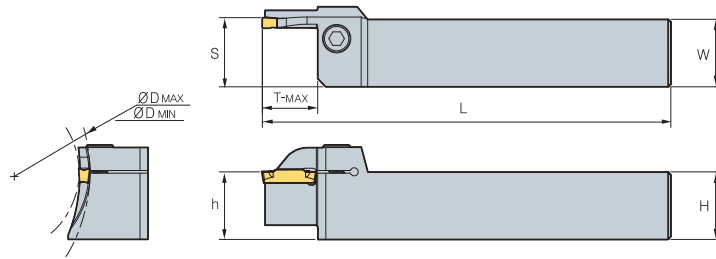

• R type insert
(mm)

Designation	H = (h)	W	L	S	T-MAX	ØD		Inserts	Screw	Wrench	
						Min	Max				
KGFHR/L 320-34/50-T10	20	20	150	20.5	10	34	50	KGMN300-□-□ KRMN300-C KGGN300-□-□ KRGN300-□	MHA0512	HW40L	
	44/70-T15	20	20	150	20.5	15	44				70
	64/100-T15	20	20	150	20.5	15	64				100
325-34/50-T10	25	25	150	25.5	10	34	50	KGMN300-□-□ KRMN300-C KGGN300-□-□ KRGN300-□	MHA0512	HW40L	
	44/70-T15	25	25	150	25.5	15	44				70
	64/100-T15	25	25	150	25.5	15	64				100
420-34/50-T16	20	20	150	20.5	16	34	50	KGMN400-□-□ KRMN400-C KGGN400-□-□ KRGN400-□	BHA0616	HW50L	
	42/70-T16	20	20	150	20.5	42	70				
	62/120-T16	20	20	150	20.5	62	120				
	112/200-T16	20	20	150	20.5	112	200				
425-34/50-T20	25	25	150	25.6	20	34	50	KGMN400-□-□ KRMN400-C KGGN400-□-□ KRGN400-□	BHA0616	HW50L	
	40/60-T10	25	25	150	25.6	40	60				
	44/70-T20	25	25	150	25.6	44	70				
	84/92-T20	25	25	150	25.6	84	92				
	60/120-T20	25	25	150	25.6	60	120				
	112/200-T20	25	25	150	25.6	112	200				
	200-T20	25	25	150	25.6	200	∞				
525-50/80-T15	25	25	150	25.6	15	50	80	KGMN500-□-□ KRMN500-C KGGN500-□-□ KRGN500-□	BHA0616	HW50L	
	50/80-T25	25	25	150	25.6	50	80				
	70/110-T15	25	25	150	25.6	70	110				
	70/110-T25	25	25	150	25.6	70	110				
	100/150-T25	25	25	150	25.6	100	150				
	140/200-T25	25	25	150	25.6	140	200				
	190/220-T10	25	25	150	25.6	10	190				200
625-170/190-T10	25	25	150	25.6	10	170	190	KGMN600-□-□ KRMN600-C KGGN600-□-□ KRGN600-□	BHA0616	HW50L	
	190/220-T10	25	25	150	25.6	10	190				200

↻ Applicable inserts C12~C13

KGIUR/L

For relief machining



KRMN
KRGN

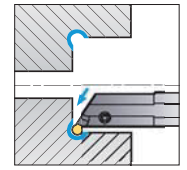
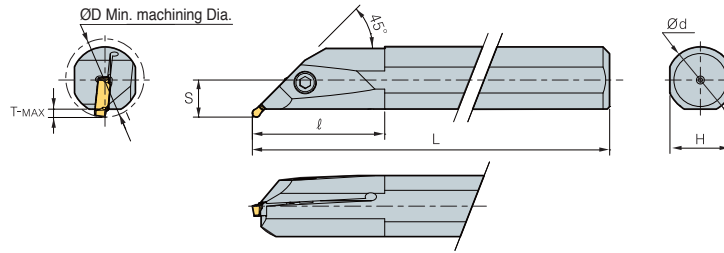

• R type insert
(mm)

Designation		ØD	Ød	L	ℓ	T-MAX	H	S	Inserts	Screw	Wrench
KGIUR/L	3520-3	35	20	150	45	3.5	18	13	KRMN300-C KRGN300-□	MHA0512	HW40L
	4025-3	40	25	200	50	3.5	23	15.5			
	5032-3	50	32	250	65	3.5	30	19			
	3520-4	35	20	150	45	3.5	18	13	KRMN400-C KRGN400-□	MHA0512	HW40L
	4025-4	40	25	200	50	3.5	23	15.5			
	5032-4	50	32	250	65	3.5	30	19			
	4025-5	40	25	200	50	3.5	23	15.5	KRMN500-C KRGN500-□	MHA0512	HW40L
	5032-5	50	32	250	65	3.5	30	19			
	4025-6	40	25	200	50	3.5	23	15.5	KRMN600-C KRGN600-□	MHA0512	HW40L
	5032-6	50	32	250	65	3.5	30	19			
	4025-8	40	25	200	50	3.5	23	18.5	KRMN800-C KRGN800-□	MHA0512	HW40L
	5032-8	50	32	250	65	3.5	30	22			

↻ Applicable inserts C12~C13

KGIVR/L

For grooving, turning and profil machining

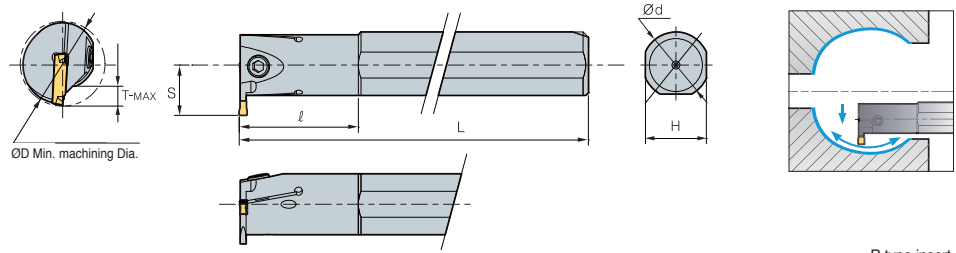

KGMI
KGGN
KRMN

KGMN
KRMI

• R type insert
(mm)

Designation		ØD	Ød	L	ℓ	T-MAX	H	S	Inserts	Screw	Wrench
KGIVR/L	2016-1.5	20	16	125	35	4	15	12	KGMN150-□-□	MHB0410	HW30L
	2520-1.5	25	20	150	45	6	18	15.5		MHB0410	
	3225-1.5	32	25	200	45	7	23	19		MHA0512	HW40L
	2516-2	25	16	125	35	6.5	15	14	KGMI200-□-T KRMI200-C	MHB0410	HW30L
	2520-2	25	20	150	45	6.5	18	15.5		MHB0512	HW40L
	3225-2	32	25	200	45	7	23	19	KGMN250-□-□	MHB0410	HW30L
	2516-2.5	25	16	125	35	6.5	15	14		MHB0410	HW30L
	2520-2.5	25	20	150	45	6.5	18	15.5		MHA0512	HW40L
	3225-2.5	32	25	200	45	7	23	19	KGMI300-□-T KRMI300-C	MHB0410	HW30L
	2520-3	25	20	150	45	6.5	18	15.5		MHA0512	HW40L
	3225-3	32	25	200	45	7	23	19		BHA0616	HW50L
	4032-3	40	32	250	55	7.5	30	22.5	KGMI400-□-T KRMI400-C	MHB0410	HW30L
	2520-4	25	20	150	45	6.5	18	15.5		MHA0512	HW40L
	3225-4	32	25	200	45	7	23	19		BHA0616	HW50L
	4032-4	40	32	250	55	7.5	30	22.5	KGMN500-□-□ KRMN500-C	MHA0512	HW40L
	3225-5	32	25	200	45	7.5	23	19.5		KGGN500-□-R KGGN500-□-A	BHA0616
4032-5	40	32	250	55	8.5	30	23.5	KGMN600-□-□ KRMN600-C	MHA0512	HW40L	
3225-6	32	25	200	45	7.5	23	19.5		KGGN600-□-R KGGN600-□-A	BHA0616	HW50L
4032-6	40	32	250	55	8.5	30	23.5	KGMN800-□-□ KRMN800-C	MHA0512	HW40L	
3225-6	32	25	200	45	7.5	23	19.5		KGGN800-□-R	BHA0616	HW50L
4032-8	40	32	250	55	8.5	30	23.5	KGMN800-□-□ KRMN800-C	MHA0512	HW40L	
4540-8	45	40	300	70	8.5	37	26.5		KGGN800-□-R	BHA0616	HW50L

➡ Applicable inserts C12~C13

• 200, 300, 400 inserts : Internal inserts, KGMI or KRMI

KGT Blade for Parting off

Features

- Parting application with the use of existing KGT inserts
- Economical machining with a double sided insert
- Specially designed slot for strong and stable clamping
- Easy change of insert with the use of exclusive wrench

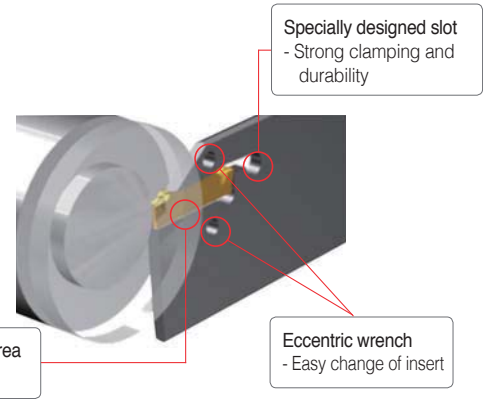

Holder Code system



How to clamp insert

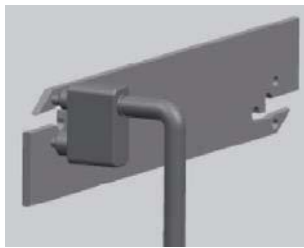

① Insert the pin of wrench into the hole of blade.

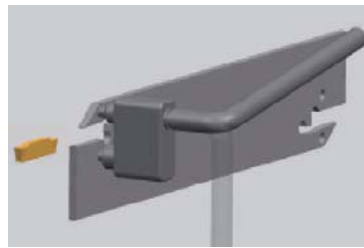

② Clamp the insert on its seat after turning the handle to 45°~160° for loosening the seat.

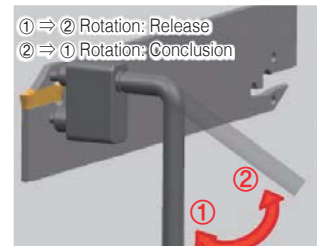

③ Finish clamp by removing the wrench after moving it back to its original state.

KGTB

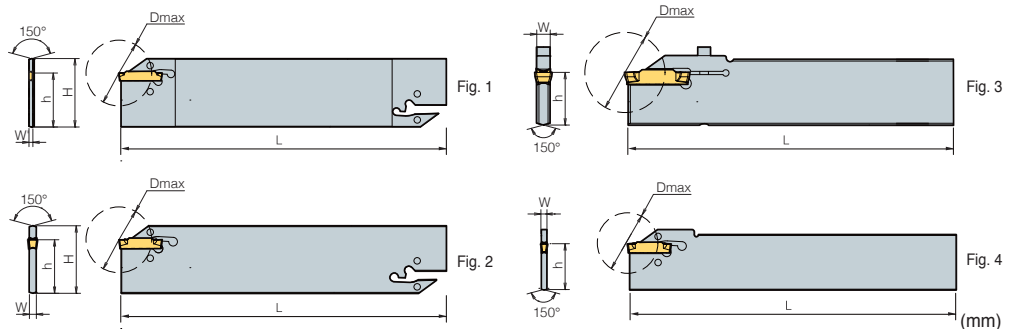

Designation	H	W	W'	L	h	ØD Max ⁽²⁾	ØD Max ⁽³⁾	Inserts	Wrench	Fig
KGTB 1526S	26	2.4	1.0	150	21	-	26	KG□□150-□-□	EW1203 (Separately ordered)	4
1532	32	2.4	1	150	25	-	26	KG□□150-□-□		1
2026S	26	2.4	1.8	150	21	50	39	KG□□200-□-□ KG□□200S-□-R ⁽⁴⁾		4
2032	32	2.4	1.8	150	25	50	39	KG□□200-□-□ KG□□200S-□-R ⁽⁴⁾		1
3026S	26	2.4	-	150	21	100	39	KG□□300-□-□ KG□□300S-□-R ⁽⁴⁾		4
3032	32	2.4	-	150	25	100	39	KG□□300-□-□ KG□□300S-□-R ⁽⁴⁾		2
4026S	26	3.2	-	150	21	100	39	KG□□400-□-□ KG□□400S-□-R ⁽⁴⁾		4
4032	32	3.2	-	150	25	100	39	KG□□400-□-□ KG□□400S-□-R ⁽⁴⁾		2
5032	32	4	-	150	25	120	49	KG□□500-□-□ KG□□500S-□-R ⁽⁴⁾		2
6032	32	5.2	-	150	25	120	49	KG□□600-□-□ KG□□600S-□-R ⁽⁴⁾		2
8032S⁽¹⁾	32	6.2	-	150	25	80	59	KG□□800-□-□ KG□□800S-□-R ⁽⁴⁾	HW30L	3

Applicable inserts C12~C13

⁽¹⁾ Screw clamping ⁽²⁾ 1 corner use ⁽³⁾ 2 corner use ⁽⁴⁾ 1 corner insert



Inserts are offered with two edges, for better economical machining

MGT Series

- Inserts are offered with two edges, for better economical machining
- Multi-function operations - Reduce cycle time & increase productivity with the ability to groove, turn, face or copy in an application
- Shorten time & save on tool cost - Korloy's MGT system allows a machinist to apply one tool against many applications, reducing the number of tools
- Flat Cutting Edge - MGT tools have a flat geometry on its cutting edge to ensure excellent surface finishes. Even in high Feed applications by using a wiper function, Korloy ensures excellent surface finishes in roughing operations











Insert code system

MG	M	N	300	- 04 -	T
System Code	Tolerance	Hand	Cutting Edge Width	Nose Radius (Nose R)	Chip Breaker
MG: Multi Grooving MR: Multi Grooving Round	M: Pressed G: Ground	N: Neutral R: Right L: Left I: Internal	1.5~8.0 mm	0.2 mm 0.3 mm 0.4 mm 0.8 mm	L/R/T/M/ PS/PT/A

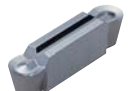
Holder code system

MG	E	H	R/L	2525	- 3	T15
System Code	Application	Holder Type	Hand	Shank Size	Cutting Width	Maximum Depth of Cut
MG: Multi Grooving	E: External machining I: Internal machining	H: Horizontal V: Vertical U: Undercut	R: Right L: Left	Height: 25 mm Width: 25 mm (For internal machining: Minimum diameter)	1.5~8.0 mm	15~25 mm

Geometry of chip breaker

<p>MGM(G)N-M</p>  <ul style="list-style-type: none"> • Specially designed chip breaker allows a smoother chip flow versus conventional flat-top geometries through the use of a central chip breaker • Specially placed convex dots assists with chip control in external machining, for a smoother chip flow • Chip breaker designed for turning & grooving applications 	<p>MGMN-G</p>  <ul style="list-style-type: none"> • Specially designed chip breaker allows narrower chips to promote better chip flow • Specially designed for grooving applications 	<p>MRMN-M</p>  <ul style="list-style-type: none"> • Full radius geometry for applications that require profiling • Available for relief machining 	<p>MFMN300</p>  <ul style="list-style-type: none"> • Specially designed chip breaker allows narrower chips to promote better chip flow • Chip breaker specially designed for face-grooving
<p>MRGN-A</p>  <ul style="list-style-type: none"> • Specially designed high positive geometry, ideal for machining aluminum • The chip breaker's super buffed, high rake angle allows optimal chip flow of aluminum 	<p>MGMR-PS</p>  <ul style="list-style-type: none"> • Sharply designed cutting edge. • Recommended in machining low carbon steel and stainless steel • Specially designed chip breaker allows narrower chips to promote better chip flow. • Able to machine Feed rates and small diameter cutting 	<p>MGMR-PT</p>  <ul style="list-style-type: none"> • Stronger cutting edge with a negative land for tougher applications • Able to machine at Feed rates as high and bar stock • Chip breaker design helps narrow chips for better flow 	<p>MGGN-A</p>  <ul style="list-style-type: none"> • Smooth chip flow • Reduced build up on cutting edge
<p>MGMN-L</p>  <ul style="list-style-type: none"> • Sharp cutting edge • Low cutting resistance • For auto CNC machine • For small Dia. processing 	<p>MGMN-R</p>  <ul style="list-style-type: none"> • Strong cutting edge • For high feed rate processing 	<p>MGMN-T</p>  <ul style="list-style-type: none"> • For turning & grooving • Reduced chip width & smooth chip control by dot designed on the top corner 	

Parting off (MGMN/MGMR/L)

Workpiece	Cutting Speed (vc = m/min)									Feed (fn = mm/rev)					
	CVD				PVD				Uncoated	Cutting width (mm)					
	NC3120	NC3030	NCM325	NC5330	PC230	PC8110	PC5300	PC6510	ST30A	2	3	4	5	6	
SM□□C	80~180			80~180	80~180						0.02~0.15	0.03~0.20	0.08~0.30	0.10~0.40	0.12~0.50
SCM	70~150	70~150	70~150	70~150	70~150						0.02~0.15	0.03~0.20	0.08~0.30	0.10~0.40	0.12~0.50
GC/GCD				50~100				50~100	50~100		0.05~0.12	0.10~0.25	0.10~0.30	0.10~0.35	0.10~0.40
STS			50~120	50~120		50~120	60~140				0.02~0.10	0.03~0.15	0.08~0.25	0.10~0.35	0.12~0.40
Non-ferrous metal (Al, Copper)									200~450		0.05~0.10	0.05~0.20	0.05~0.25	0.05~0.30	0.05~0.35

Facing (FGD/FGM/FMM/MFMN/MGMN)

Workpiece	Cutting Speed (vc = m/min)							Feed (fn = mm/rev)		
	CVD				PVD		Uncoated	Cutting width (mm)		
	NC6110	NC3030	NC5330	NC3120	PC215K	PC8110 / PC5300	H01	3	4	5
SM□□C			100~160	100~160				0.05~0.10	0.05~0.12	0.05~0.15
SCM		50~130	50~130	50~130			200~800	0.05~0.10	0.05~0.12	0.05~0.15
GC/GCD	120~150		120~150		120~150			0.05~0.10	0.05~0.12	0.05~0.15
STS			60~150			60~150		0.05~0.10	0.05~0.12	0.05~0.15
Non-ferrous metal (Al, Copper)								0.05~0.15	0.08~0.15	0.08~0.15

Grooving, Turning (MGMN/MRMN)

Workpiece	Cutting Speed (vc = m/min)										Feed (fn = mm/rev)					
	CVD			PVD			Cermet		Uncoated		Cutting width (mm)					
	NC3120	NC3030	NC5330	PC215K	PC5300	PC230	CN20	CT10	ST30A	ST20	0.5~1.0	1.0~2.0	2~3	3~4	4~5	6~8
SM□□C	80~200		80~200		80~180	80~200	80~120	80~120		80~120	0.03~0.08	0.04~0.09	0.05~0.1	0.05~0.12	0.05~0.15	0.05~0.2
SCM	80~180	80~180	80~180		80~160	80~180	80~120		80~120	80~120	0.03~0.07	0.04~0.08	0.05~0.08	0.05~0.1	0.05~0.12	0.05~0.15
GC/GCD			60~130		60~130						0.03~0.07	0.04~0.08	0.05~0.08	0.05~0.1	0.05~0.10	0.05~0.12
STS			60~100	60~100					60~100		0.03~0.08	0.04~0.09	0.05~0.10	0.05~0.12	0.05~0.12	0.05~0.15
Non-ferrous metal (Al, Copper)				150~300					150~400		0.05~0.12	0.05~0.15	0.05~0.15	0.08~0.15	0.08~0.15	0.10~0.20



Insert







Application	Picture	Designation	Coated							Uncoated	Dimensions (mm)					Configuration	Page			
			NC3120	NC3225	NC3225	NC5330	NC6315	PC5300	PC8110	PC9030	H01	b	r	l	d			t		
Face Grooving	FGD	FGD	300R-03									3.0	0.3	15.0	2.0	4.0		C36		
			400R-04										4.0	0.4	15.0	3.0		4.5	C37	
			500R-04											5.0	0.4	15.0		4.0	5.0	
	FGM	FGM	300R-03										3.0	0.3	15.0	2.0	4.0		C36	
			400R-04										4.0	0.4	15.0	3.0	4.5		C37	
			500R-04											5.0	0.4	15.0	4.0		5.0	
	FMM	FMM	300R-03							●			3.0	0.3	15.0	2.0	3.91		C36	
			400R-04										4.0	0.4	15.0	3.0	3.96		C37	
			500R-04											5.0	0.4	15.0	4.0		4.42	
Face Grooving	MFMN	MFMN	300						●			3.0	0.2	18.0	2.0	3.0		C35 C41		
Grooving · Turning	MGGN-M	MGGN-M	300-02-M									3.0	0.2	21.0	2.35	4.8		C30		
			04-M										3.0	0.4	21.0	2.35		4.8	C32	
			08-M											3.0	0.8	21.0		2.35	4.8	C34
			400-02-M											4.0	0.2	21.0		3.3	4.8	C41
			04-M											4.0	0.4	21.0		3.3	4.8	
			08-M											4.0	0.8	21.0		3.3	4.8	
			500-02-M											5.0	0.2	26.0		4.1	5.8	
			04-M											5.0	0.4	26.0		4.1	5.8	
			08-M											5.0	0.8	26.0		4.1	5.8	
			600-02-M											6.0	0.2	26.0		5.0	5.8	
			04-M											6.0	0.4	26.0		5.0	5.8	
			08-M											6.0	0.8	26.0		5.0	5.8	
Grooving	MGMN-G	MGMN-G	MGMN	150-G		●	●			●	●	●	1.5	0.15	16.0	1.2	3.5		C30	
			200-G	●	●	●				●	●	●	2.0	0.2	16.0	1.6	3.5		C32	
			250-G		●	●					●	●	●	2.5	0.2	18.5	2.0		3.85	C34
			300-G	●	●	●	●				●	●	●	3.0	0.3	21.0	2.35		4.8	C41
			400-G	●							●	●	●	4.0	0.3	21.0	3.3		4.8	
			500-G									●	●	5.0	0.5	26.0	4.1		5.8	
			600-G										●	6.0	0.8	26.0	5.0		5.8	
Grooving · Turning	MGMN-M	MGMN-M	MGMN	200-M	●	●	●	●		●	●	●	2.0	0.2	16.0	1.6	3.5		C30	
			250-M	●	●	●				●	●	●	2.5	0.2	18.5	2.0	3.85		C32	
			300-02-M				●							3.0	0.2	21.0	2.35		4.8	C34
			300-M	●	●	●	●	●	●	●	●	●	●	3.0	0.4	21.0	2.35		4.8	C41
			350-03-M											3.5	0.3	21.0	2.9		4.8	
			400-02-M											4.0	0.2	21.0	3.3		4.8	
			400-M	●	●	●	●	●	●	●	●	●	●	4.0	0.4	21.0	3.3		4.8	
			500-04-M											5.0	0.4	26.0	4.1		5.8	
			500-M	●	●	●	●	●				●	●	5.0	0.8	26.0	4.1		5.8	
			600-M	●	●	●	●	●						6.0	0.8	26.0	5.0		5.8	
800-M				●							8.0	0.8	31.0	6.0	6.5					

●: Stock item

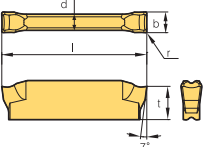

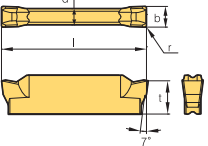
C Available Insert for MGT

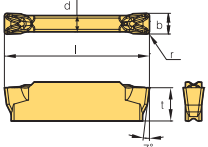

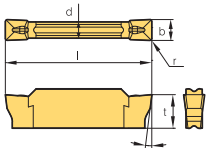





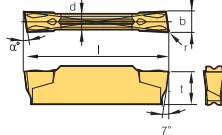

Insert

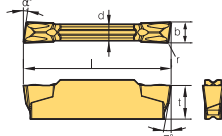
Application	Picture	Designation	Coated							Uncoated		Dimensions (mm)						Configuration	Page	
			NC3120	NC3225	NC3030	NC5330	NC6315	PC5300	PC8100	PC9030	H01	H05	b	r	l	d	t			α°
Grooving		MGML	200-02-L									2.0	0.2	16	1.60	3.5	-		C30 C32 C34 C35	
			04-L										2.0	0.4	20	1.7	3.5			-
			250-02-L										2.5	0.2	18.5	2.0	3.85			-
			300-02-L										3.0	0.2	21	2.35	4.8			-
			04-L										3.0	0.4	20	2.3	4.0			-
			400-02-L										4.0	0.2	21	3.3	4.8			-
			04-L										4.0	0.4	20	3.3	4.0			-
			500-03-L										5.0	0.3	26	4.1	5.82			-
04-L										5.0	0.4	26	4.1	5.8	-					
Grooving · Parting off		MGML-R	150-015-R									1.5	0.15	16	1.2	3.35	-		C30 C32 C34 C35	
			200-02-R										2.0	0.2	16	1.60	3.5			-
			04-R										2.0	0.4	20	1.7	3.5			-
			250-02-R										2.5	0.2	18.5	2.0	3.89			-
			300-02-R										3.0	0.2	21	2.35	4.8			-
			04-R										3.0	0.4	20	2.3	4.0			-
			400-02-R										4.0	0.2	21	3.3	4.8			-
			04-R										4.0	0.4	20	3.3	4.0			-
500-04-R										5.0	0.4	26	4.1	5.8	-					
08-R										5.0	0.4	26	4.1	5.94	-					
600-04-R										6.0	0.4	26	5.0	5.94	-					
08-R										6.0	0.8	26	5.0	5.94	-					
Grooving · Turning		MGML-T	150-015-T									1.5	0.15	16	1.2	3.5	-		C30 C32 C34 C35	
			200-T										2.0	0.2	16	1.60	3.5			-
			300-T										3.0	0.4	21	2.35	4.8			-
			400-T										4.0	0.4	21	3.3	4.8			-
			500-04-T										5.0	0.4	26	4.1	5.82			-
			500-T										5.0	0.8	26	4.1	5.8			-
			600-08-T										6.0	0.8	26	5.0	5.81			-
Grooving		MGML-A	300-02-A									3.0	0.2	21	2.35	4.8	-		C28 C30 C32 C41	
			04-A										3.0	0.4	21	2.35	4.8			-
			08-A										3.0	0.8	21	2.35	4.8			-
			400-02-A										4.0	0.2	21	3.3	4.8			-
			04-A										4.0	0.4	21	3.3	4.8			-
			08-A										4.0	0.8	21	3.3	4.8			-
			500-02-A										5.0	0.2	26	4.1	5.8			-
			04-A										5.0	0.4	26	4.1	5.8			-
08-A										5.0	0.8	26	4.1	5.8	-					

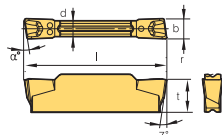
● : Stock item

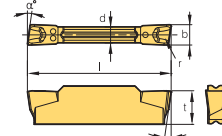

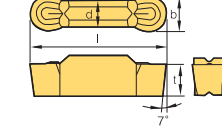
Insert

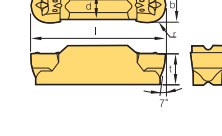
Application	Picture	Designation	Coated							Uncoated		Dimensions (mm)						Configuration	Page	
			NC3030	NC3120	NC3225	NC5330	NC6315	PC5300	PC8100	PC9030	H01	H05	b	r	l	d	t			α°
Parting off	MGMR-PS 	MGMR 300-6D-PS										3.0	0.2	21	2.35	4.8	6		C30 C32	
		8D-PS											3.0	0.2	21	2.35	4.8			5
		15D-PS											3.0	0.2	21	2.35	4.8			15
		400-4D-PS											4.0	0.3	21	3.30	4.8			4
		500-4D-PS											5.0	0.3	26	4.10	5.8			4
Parting off	MGML-PS 	MGML 300-6D-PS										3.0	0.2	21.0	2.35	4.8	6			
		8D-PS										3.0	0.2	21.0	2.35	4.8	5			
		15D-PS										3.0	0.2	21.0	2.35	4.8	15			
Parting off	MGMR-PT 	MGMR 200-6D-PT										2.0	0.2	16	1.60	3.6	6		C30 C32	
		300-6D-PT										3.0	0.2	21	2.35	4.8	6			
		8D-PT				●						3.0	0.2	21	2.35	4.8	8			
		15D-PT										3.0	0.2	21	2.35	4.8	15			
		400-4D-PT										4.0	0.3	21	3.30	4.8	4			
		500-4D-PT										5.0	0.3	26	4.10	5.8	4			
Parting off	MGML-PT 	MGML 200-6D-PT										2.0	0.2	16	1.60	3.6	6			
		300-6D-PT					●				3.0	0.2	21	2.35	4.8	6				
		8D-PT									3.0	0.2	21	2.35	4.8	8				
		15D-PT									3.0	0.2	21	2.35	4.8	15				
		400-4D-PT									4.0	0.3	21	3.30	4.8	4				
		500-4D-PT									5.0	0.3	26	4.10	5.8	4				
Aluminum	MRGN-A 	MRGN 300-A										3.0	1.5	21.0	2.35	4.8	-		C30 C31 C33 C34	
		400-A								●	4.0	2.0	21.0	3.30	4.8	-				
		500-A									●	5.0	2.5	26.0	4.10	5.8	-			
		600-A									●	6.0	3.0	26.0	5.0	5.8	-			
		800-A									●	8.0	4.0	31.0	6.0	6.5	-			
Reliefing Profiling	MRMN-M 	MRMN 200-M	●	●	●							2.0	1.0	16.0	1.50	3.5	-		C30 ~34 C41	
		300-M	●	●	●	●				●	●	3.0	1.5	21.0	2.35	4.8	-			
		400-M	●	●	●	●					●	4.0	2.0	21.0	3.3	4.8	-			
		500-M	●							●		5.0	2.5	26.0	4.1	5.8	-			
		600-M	●		●	●						6.0	3.0	26.0	5.0	5.8	-			
		800-M	●			●						8.0	4.0	31.0	6.0	6.5	-			

● : Stock item



MGEHR/L

For grooving, turning, parting off, relief, profil machining

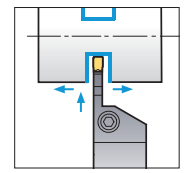
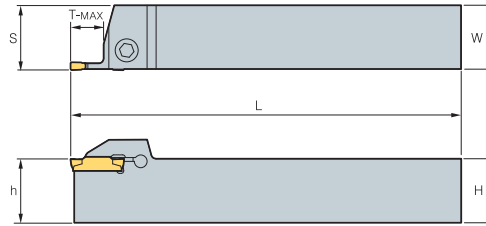

MGMN
MGGN
MRGN

MGMR
MRMN

• R type insert

(mm)

Designation	H = (h)	W	L	S	T-MAX	Inserts	Screw	Wrench
MGEHR/L 1616-1.5	16	16	100	16.2	14	MGMN150-G	LTX0514	TW20L
2020-1.5	20	20	125	20.2	14			
2525-1.5	25	25	150	25.2	14			
1212-2	12	12	100	14.25	14	MGMN200-G MGMN200-M MGMR200-□□-□□	MHA0512	HW40L
1616-2	16	16	100	16.25	14			
2020-2	20	20	125	20.25	14			
2525-2	25	25	150	25.25	14	MGMN250-G MGMN250-M	MHA0512	HW40L
1616-2.5	16	16	100	16.30	16			
2020-2.5	20	20	125	20.30	16			
2525-2.5	25	25	150	25.30	16	MGMN300-M/T MGGN300-□□-M MRMN300-M MGMR300-□□-□□ MGMN300-□□-L/R	BHA0616	HW50L
1616-3	16	16	100	16.35	18			
2020-3-T10	20	20	125	20.4	10			
2020-3	20	20	125	20.4	18	MGMN400-M/T MGGN400-□□-M MRMN400-M MGMR400-□□-□□ MGMN400-□□-L/R	BHA0616	HW50L
2525-3-T10	25	25	150	25.4	10			
2525-3	25	25	150	25.4	18			
3232-3-T10	32	32	170	32.4	10	MGMN500-M/T MGGN500-□□-M MRMN500-M MGMR500-□□-□□ MGMN500-□□-L/R	BHA0616	HW50L
3232-3	32	32	170	32.4	18			
2020-4-T10	20	20	125	20.4	10			
2020-4	20	20	125	20.4	18	MGMN600-M MGGN600-□□-M MRMN600-M	BHA0616	HW50L
2525-4-T10	25	25	150	25.4	10			
2525-4	25	25	150	25.4	18			
3232-4-T10	32	32	170	32.4	10	MRMN800-M MGMN800-M	BHA0616	HW50L
3232-4	32	32	170	32.4	18			
2020-5-T15	20	20	150	20.5	15			
2020-5	20	20	150	20.5	23	MRMN800-M MGMN800-M	BHA0616	HW50L
2525-5-T15	25	25	150	25.5	15			
2525-5	25	25	150	25.5	23			
3232-5-T15	32	32	170	32.5	15	MRGN600-A	BHA0616	HW50L
3232-5	32	32	170	32.5	23			
2020-6-T15	20	20	125	20.6	15			
2020-6	20	20	125	20.6	23	MRGN800-A	BHA0616	HW50L
2525-6-T15	25	25	150	25.6	15			
2525-6	25	25	150	25.6	23			
3232-6-T15	32	32	170	32.6	15	MRGN800-A	BHA0616	HW50L
3232-6	32	32	170	32.6	23			
2525-8-T15	25	25	150	26.1	15			
2525-8	25	25	150	26.1	28	MRGN800-A	BHA0616	HW50L
3232-8-T15	32	32	170	33.1	16			
3232-8	32	32	170	33.1	28			
2525-6A-T15	25	25	150	25.6	15	MRGN800-A	BHA0616	HW50L
2525-6A	25	25	150	25.6	23			
3232-6A-T15	32	32	170	32.6	15			
3232-6A	32	32	170	32.6	23	MRGN800-A	BHA0616	HW50L
2525-8A-T15	25	25	150	26.1	16			
2525-8A	25	25	150	26.1	28			
3232-8A-T15	32	32	170	33.1	15	MRGN800-A	BHA0616	HW50L
3232-8A	32	32	170	33.1	28			

Applicable inserts C27~C29



MGEUR/L

For relief, profil machining



MRMN
MRGN

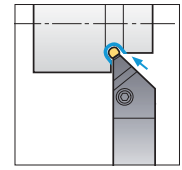
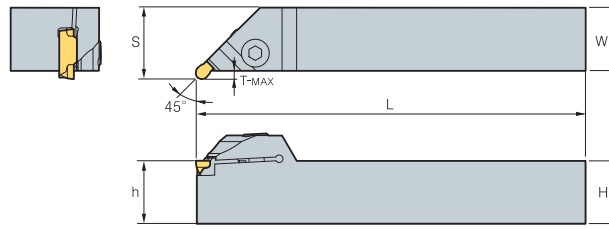

• R type insert
(mm)

Designation	H = (h)	W	L	S	T-MAX	Inserts	Screw	Wrench	
MGEUR/L 2020-3	20	20	125	23	3	MRMN300-M	BHA0616	HW50L	
	2525-3	25	25	150	28				3
	3232-3	32	32	170	35				3
2020-4	20	20	125	23	3	MRMN400-M			
	2525-4	25	25	150	28				3
	3232-4	32	32	170	35				3
2020-5	20	20	125	24	4	MRMN500-M			
	2525-5	25	25	150	29				4
	3232-5	32	32	170	36				4
2020-6	20	20	125	24	4	MRMN600-M			
	2525-6	25	25	150	29				4
	3232-6	32	32	170	36				4
2525-8	25	25	150	30	5	MRMN800-M			
3232-8	32	32	170	37	5	MRMN800-M			
2525-6A	25	25	150	29	4	MRGN600-A			
3232-6A	32	32	170	36	4	MRGN600-A			
2525-8A	25	25	150	30	5	MRGN800-A			
3232-8A	32	32	170	37	5	MRGN800-A			

➔ Applicable inserts C27~C29

● : Stock item



MGEVR/L

For grooving, turning, profil machining

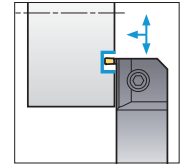
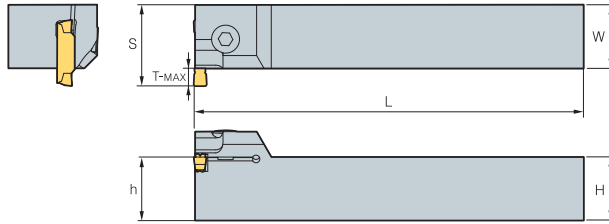

MGMN MGN
MRMN MRGN

• R type insert

(mm)

Designation	H = (h)	W	L	S	T-MAX	Min. machining Dia. (ØD)	Inserts	Screw	Wrench
MGEVR/L 2020-1.5	20	20	125	23	3	85	MGMN150-G	LTX0514	TW20L
	2525-1.5	25	25	150	28	3			
	3232-1.5	32	32	170	35	3			
2020-2	20	20	125	23.5	3.5	65	MGMN200-M MGMN200-G		
2525-2	25	25	150	28.5	3.5	65			
3232-2	32	32	170	35.5	3.5	65			
2020-2.5	20	20	125	24	4	65	MGMN250-M MGMN250-G		
2525-2.5	25	25	150	29	4	65			
3232-2.5	32	32	170	36	4	65			
2020-3	20	20	125	25.5	5	75	MGMN300-M/T MGGN300-□□-M MRMN300-M MGMN300-□□-L/R		
2525-3	25	25	150	30.5	5	75			
3232-3	32	32	170	37.5	5	75			
2020-4	20	20	125	25.5	5	70	MGMN400-M/T MGGN400-□□-M MRMN400-M MGMN400-□□-L/R	BHA0616	HW50L
2525-4	25	25	150	30.5	5	70			
3232-4	32	32	170	37.5	5	70			
2020-5	20	20	125	27	7	75	MGMN500-M/T MGGN500-□□-M MRMN500-M MGMN500-□□-L/R		
2525-5	25	25	150	32	7	75			
3232-5	32	32	170	39	7	75			
2020-6	20	20	125	27	7	70	MGMN600-M MGGN600-□□-M MRMN600-M		
2525-6	25	25	150	32	7	70			
3232-6	32	32	170	39	7	70			
2525-8	25	25	150	34	9	50	MRMN800-M MGMN800-M		
3232-8	32	32	170	41	9	50			
2525-6A	25	25	150	32	7	70	MRGN600-A		
3232-6A	32	32	170	39	7	70			
2525-8A	25	25	150	34	9	45	MRGN800-A		
3232-8A	32	32	170	41	9	45			

↻ Applicable inserts C27~C29

MGIUR/L

For relief, profil machining



MRMN
MRGN

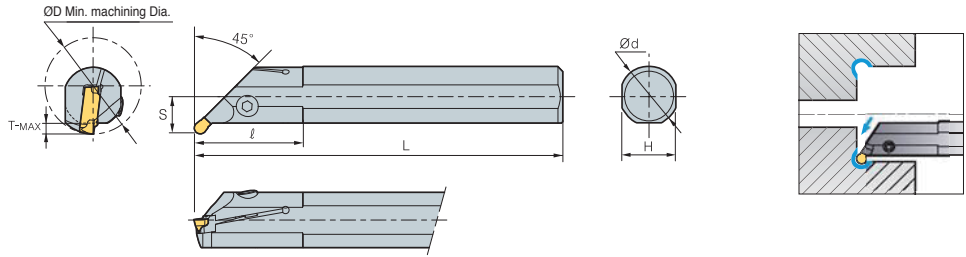

• R type insert
(mm)

Designation	ØD	Ød	L	ℓ	T-MAX	H	S	Inserts	Screw	Wrench	
MGIUR/L 3520-3	35	20	150	45	3.5	18	13	MRMN300-M	MHA0512	HW40L	
	4025-3	40	25	200	45	3.5	23				15.5
	5032-3	50	32	250	65	3.5	30				19
3520-4	35	20	150	45	3.5	18	13	MRMN400-M	MHA0512	HW40L	
	4025-4	40	25	200	45	3.5	23				15.5
	5032-4	50	32	250	65	3.5	30				19
4025-5	40	25	200	45	3.5	23	15.5	MRMN500-M	BHA0616 BHA0620		
	5032-5	50	32	250	65	3.5	30				19
4025-6	40	25	200	45	3.5	23	19	MRMN600-M	BHA0616 BHA0620		
	5032-6	50	32	250	65	3.5	30				19
4025-8	40	25	200	45	6.5	23	15.5	MRMN800-M	BHA0616 BHA0620	HW50L	
	5032-8	50	32	250	65	6.5	30				19
4025-6A	40	25	200	45	3.5	23	15.5	MRGN600-A	BHA0616 BHA0620		
	5032-6A	50	32	250	65	3.5	30				19
4025-8A	40	25	200	45	5.0	23	18.5	MRGN800-A	BHA0616 BHA0620		
	5032-8A	50	32	250	65	6.5	30				22

➔ Applicable inserts C27~C29



MGIVR/L

For grooving, turning, profil machining

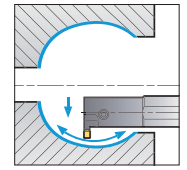
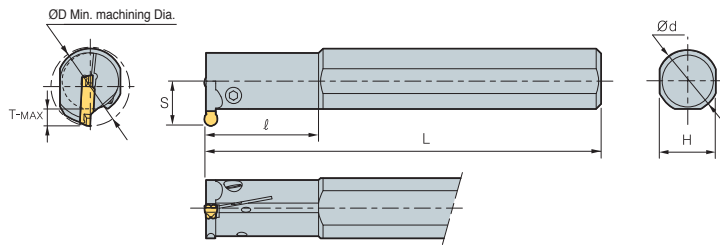

MGMN MRMN
MGGN MRGN

• R type insert

(mm)

Designation	ØD	Ød	L	l	T-MAX	H	S	Inserts	Screw	Wrench
MGIVR/L	2016-1.5	20	16	125	35	3.5	15	MGMN150-G	MHB0310	HW25L
	2520-1.5	25	20	150	45	3.5	18		MHA0512	HW40L
	2925-1.5	29	25	200	45	3.5	23	MGMN200-G	MHB0310	HW25L
	2016-2	20	16	125	35	4.5	15		MGMN200-M	MHA0512
	2520-2	25	20	150	45	4.5	18	MRMN200-M	MHB0310	HW25L
	2925-2	29	25	200	45	4.5	23		MHA0512	HW40L
	2016-2.5	20	16	125	35	4.5	15	MGMN250-G	MHB0310	HW25L
	2520-2.5	25	20	150	45	4.5	18		MGMN250-M	MHA0512
	2925-2.5	29	25	200	45	4.5	23	MGMN300-M/G/T MGGN300-□□-M MRMN300-M MGMN300-□□-L/R	MHA0512	HW40L
	2520-3	25	20	150	45	5	18			
	2520-3-T7	25	20	150	49.3	7	18	MGMN400-M/G/T MGGN400-□□-M MRMN400-M MGMN400-□□-L/R	MHA0512	HW40L
	3125-3	31	25	200	45	6	23			
	3125-3-T10	31	25	200	45	10	23	MGMN500-M/G/T MGGN500-□□-M MRMN500-M MGMN500-□□-L/R	BHA0616	BHA0620
	3732-3	37	32	250	65	6	30			
	3732-3-T12	37	32	250	65	12	30	MGMN600-MG MGGN600-□□-M MRMN600-M	BHA0616	BHA0620
	2520-4	25	20	150	45	6	18			
	2520-4-T7	25	20	150	45	7	18	MRMN800-M MGMN800-M	BHA0620	HW50L
	3125-4	31	25	200	45	6	23			
	3125-4-T10	31	25	200	45	10	23	MRGN600-A	BHA0616	BHA0620
	3732-4	37	32	250	65	6	30			
	3732-4-T12	37	32	250	65	12	30	MRGN800-A	BHA0616	BHA0620
	3125-5	31	25	200	45	8	23			
	3732-5	37	32	250	65	8	30	MRGN800-A	BHA0616	BHA0620
	3125-6	31	25	200	45	8	23			
	3732-6	37	32	250	65	8	30	MRGN800-A	BHA0616	BHA0620
	3732-8	37	32	250	65	10	30			
	4540-8	45	40	300	70	10	37	MRGN800-A	BHA0616	BHA0620
	3125-6A	31	25	200	45	8	23			
	3732-6A	37	32	250	65	8	30	MRGN800-A	BHA0616	BHA0620
	3732-8A	37	32	250	65	10	30			
	4540-8A	45	40	300	70	10	37			

Applicable inserts C27~C29



MGFHR/L

For face grooving machining



MFMN
MGMN

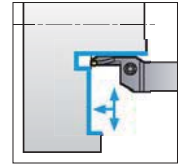
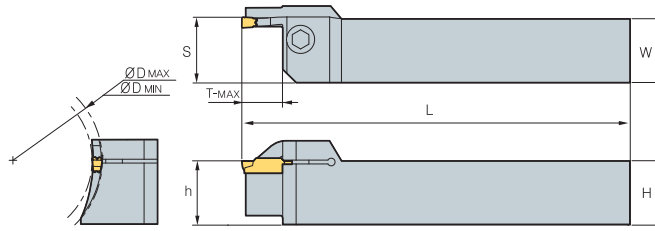

• R type insert
(mm)

Designation	H = (h)	W	L	S	T-MAX	ØD		Inserts	Screw	Wrench	
						Min	Max				
MGFHR/L	325-24/35-T10	25	25	150	25.6	10	24	35	MFMN300	BHA0616	HW50L
	29/40-T10	25	25	150	25.6	10	29	40			
	34/50-T10	25	25	150	25.6	10	34	50			
	44/70-T10	25	25	150	25.6	10	44	70			
	64/99-T10	25	25	150	25.6	10	64	99			
	425-42/63-T15	25	25	150	25.6	15	42	63			
	62/120-T15	25	25	150	25.6	15	62	120			
112/200-T15	25	25	150	25.6	15	112	200	MGMN400-M/T MGMN400-□□-L/R			

➔ Applicable inserts C27~C29

MGFVR/L

For face grooving machining



MFMN
MGMN

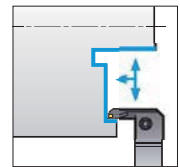
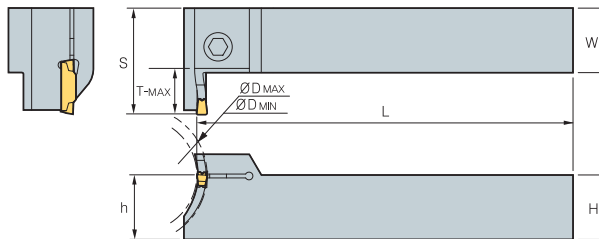

• R type insert
(mm)

Designation	H = (h)	W	L	S	T-MAX	ØD		Inserts	Screw	Wrench	
						Min	Max				
MGFVR/L	325-24/35-T10	25	25	150	36	10	24	35	MFMN300	MHA0512	HW40L
	29/40-T10	25	25	150	36	10	29	40			
	34/50-T10	25	25	150	36	10	34	50			
	44/70-T10	25	25	150	36	10	44	70			
	64/99-T10	25	25	150	36	10	64	99			
	425-44/60-T15	25	25	150	41	15	44	60			
	60/120-T15	25	25	150	41	15	60	120			
112/200-T15	25	25	150	41	15	112	200	MGMN400-M/T MGMN400-□□-L/R			

➔ Applicable inserts C27~C29

C MGT Holder (Face Grooving)

FGHH

For face grooving, turning machining

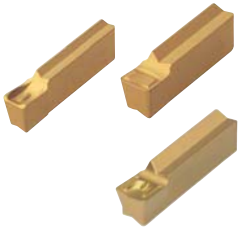

FGD FGM FMM

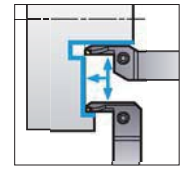
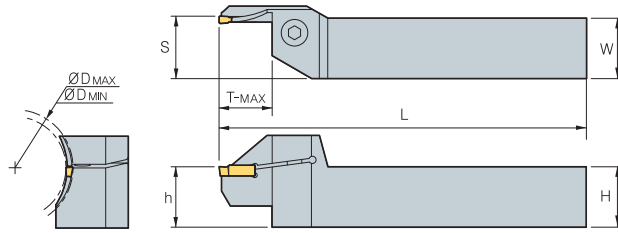

• R type insert

(mm)

Designation	H = (h)	W	L	S	T-MAX	ØD		Inserts	Screw	Wrench	
						Min	Max				
FGHH 320R - 25/30	20	20	125	20.6	12	25	30	FMM300R-03	BHA0616	HW50L	
	30/35	20	20	125	20.6	12	30				35
	35/48	20	20	125	20.6	12	35				48
	48/60	20	20	125	20.6	22	48	60			FGD300R-03 FGM300R-03
	60/75	20	20	125	20.6	22	60	75			
	75/100	20	20	125	20.6	22	75	100			
	100/140	20	20	125	20.6	22	100	140			
325R - 25/30	25	25	150	25.6	12	25	30	FMM300R-03			
	30/35	25	25	150	25.6	12	30		35		
	35/48	25	25	150	25.6	12	35		48		
	48/60	25	25	150	25.6	22	48	60	FGD300R-03 FGM300R-03		
	60/75	25	25	150	25.6	22	60	75			
	75/100	25	25	150	25.6	22	75	100			
	100/140	25	25	150	25.6	22	100	140			
420R - 25/30	20	20	125	20.6	12	25	30	FMM400R-04			
	30/35	20	20	125	20.6	12	30		35		
	35/48	20	20	125	20.6	12	35		48		
	48/60	20	20	125	20.6	25	48	60	FGD400R-04 FGM400R-04		
	60/75	20	20	125	20.6	25	60	75			
	75/100	20	20	125	20.6	25	75	100			
	100/140	20	20	125	20.6	25	100	140			
425R - 25/30	25	25	150	25.6	12	25	30	FMM400R-04			
	30/35	25	25	150	25.6	12	30		35		
	35/48	25	25	150	25.6	12	35		48		
	48/60	25	25	150	25.6	25	48	60	FGD400R-04 FGM400R-04		
	60/75	25	25	150	25.6	25	60	75			
	75/100	25	25	150	25.6	25	75	100			
	100/140	25	25	150	25.6	25	100	140			
520R - 25/30	20	20	125	20.6	12	25	30	FMM500R-04			
	30/35	20	20	125	20.6	12	30		35		
	35/40	20	20	125	20.6	20	35		40		
	40/48	20	20	125	20.6	20	40		48		
	48/60	20	20	125	20.6	25	48	60	FGD500R-04 FGM500R-04		
	60/75	20	20	125	20.6	25	60	75			
	75/100	20	20	125	20.6	25	75	100			
525R - 25/30	20	20	125	20.6	25	100	140	FMM500R-04			
	25	25	150	25.6	12	25	30				
	30/35	25	25	150	25.6	12	30		35		
	35/40	25	25	150	25.6	20	35	40	FGD500R-04 FGM500R-04		
	40/48	25	25	150	25.6	20	40	48			
	48/60	25	25	150	25.6	25	48	60			
	60/75	25	25	150	25.6	25	60	75			
75/100	25	25	150	25.6	25	75	100	FGD500R-04 FGM500R-04			
100/140	25	25	150	25.6	25	100	140				

↻ Applicable inserts C27~C29



C

Multi functional Tools

FGVH

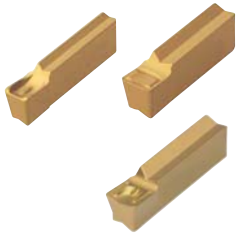

FGD FGM FMM

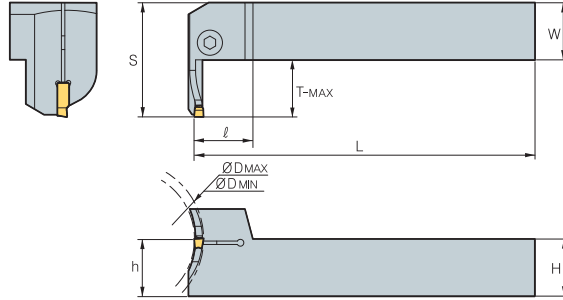

For face grooving, turning machining

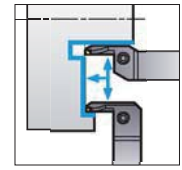

• R type insert
(mm)

Designation	H = (h)	W	L	S	T-MAX	ØD		Inserts	Screw	Wrench	
						Min	Max				
FGVH 320R - 25/30	30/35	20	20	125	20.6	12	25	30	FMM300R-03	BHA0616	HW50L
	35/48	20	20	125	20.6	12	35	48			
	48/60	20	20	125	20.6	22	48	60			
	60/75	20	20	125	20.6	22	60	75			
	75/100	20	20	125	20.6	22	75	100			
	100/140	20	20	125	20.6	22	100	140			
	325R - 25/30	25	25	150	25.6	12	25	30			
325R - 30/35	30/35	25	25	150	25.6	12	30	35	FGD300R-03 FGM300R-03		
	35/48	25	25	150	25.6	12	35	48			
	48/60	25	25	150	25.6	22	48	60			
	60/75	25	25	150	25.6	22	60	75			
	75/100	25	25	150	25.6	22	75	100			
420R - 25/30	30/35	25	25	150	25.6	12	25	30	FMM400R-04		
	35/48	25	25	150	25.6	12	35	48			
	48/60	25	25	150	25.6	25	48	60			
	60/75	25	25	150	25.6	25	60	75			
	75/100	25	25	150	25.6	25	75	100			
	100/140	25	25	150	25.6	25	100	140			
420R - 30/35	30/35	20	20	125	20.6	12	25	30	FMM400R-04		
	35/48	20	20	125	20.6	12	35	48			
	48/60	20	20	125	20.6	25	48	60			
	60/75	20	20	125	20.6	25	60	75			
	75/100	20	20	125	20.6	25	75	100			
	100/140	20	20	125	20.6	25	100	140			
425R - 25/30	30/35	25	25	150	25.6	12	25	30	FMM400R-04		
	35/48	25	25	150	25.6	12	35	48			
	48/60	25	25	150	25.6	25	48	60			
	60/75	25	25	150	25.6	25	60	75			
	75/100	25	25	150	25.6	25	75	100			
	100/140	25	25	150	25.6	25	100	140			
520R - 25/30	30/35	25	25	150	25.6	12	25	30	FMM500R-04		
	35/40	25	25	150	25.6	20	35	40			
	40/48	25	25	150	25.6	20	40	48			
	48/60	25	25	150	25.6	25	48	60			
	60/75	25	25	150	25.6	25	60	75			
	75/100	25	25	150	25.6	25	75	100			
	100/140	25	25	150	25.6	25	100	140			
520R - 30/35	30/35	20	20	125	20.6	12	25	30	FMM500R-04		
	35/40	20	20	125	20.6	20	35	40			
	40/48	20	20	125	20.6	20	40	48			
	48/60	20	20	125	20.6	25	48	60			
	60/75	20	20	125	20.6	25	60	75			
	75/100	20	20	125	20.6	25	75	100			
525R - 25/30	30/35	25	25	150	25.6	12	25	30	FMM500R-04		
	35/40	25	25	150	25.6	20	35	40			
	40/48	25	25	150	25.6	20	40	48			
	48/60	25	25	150	25.6	25	48	60			
	60/75	25	25	150	25.6	25	60	75			
	75/100	25	25	150	25.6	25	75	100			
525R - 30/35	30/35	20	20	125	20.6	12	25	30	FMM500R-04		
	35/40	20	20	125	20.6	20	35	40			
	40/48	20	20	125	20.6	20	40	48			
	48/60	20	20	125	20.6	25	48	60			
	60/75	20	20	125	20.6	25	60	75			
	75/100	20	20	125	20.6	25	75	100			
525R - 40/48	40/48	25	25	150	25.6	20	40	48	FGD500R-04 FGM500R-04		
	48/60	25	25	150	25.6	25	48	60			
	60/75	25	25	150	25.6	25	60	75			
	75/100	25	25	150	25.6	25	75	100			
	100/140	25	25	150	25.6	25	100	140			
	140/180	25	25	150	25.6	25	140	180			

➔ Applicable inserts C27~C29

C Technical Information for KGT/MGT Cartridge

KGT/MGT cartridge

Features

- Compatible and Economical due to divided cartridge & exclusive holder system from existing single body system
- Interchangeable cartridge
 - Various assembly depends on working style
 - Reduce cutting tool costs by over 30%
 - Setting with upper clamp & side screw
- Strong & Stable setting force
 - Simultaneous assembly of insert & cartridge
 - Easy assembly & tool exchange
- Stable assembly system
 - Simple & Superior setting force

Stable Assembly thanks to double screw & clamp

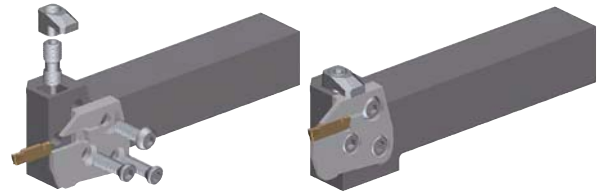

Simple & Strong Setting

Holder code system

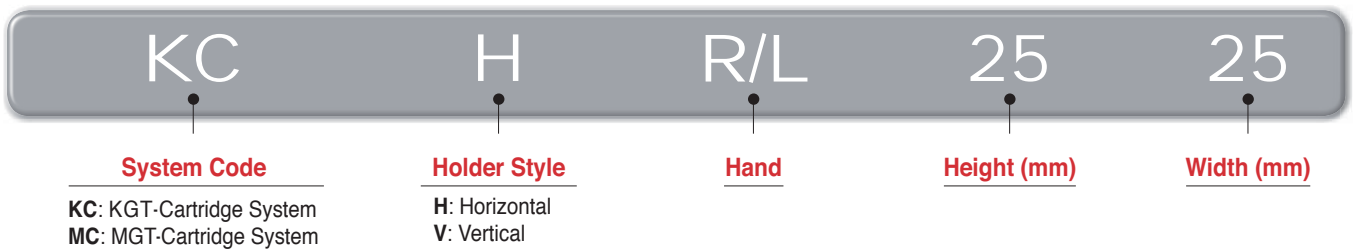

Holder

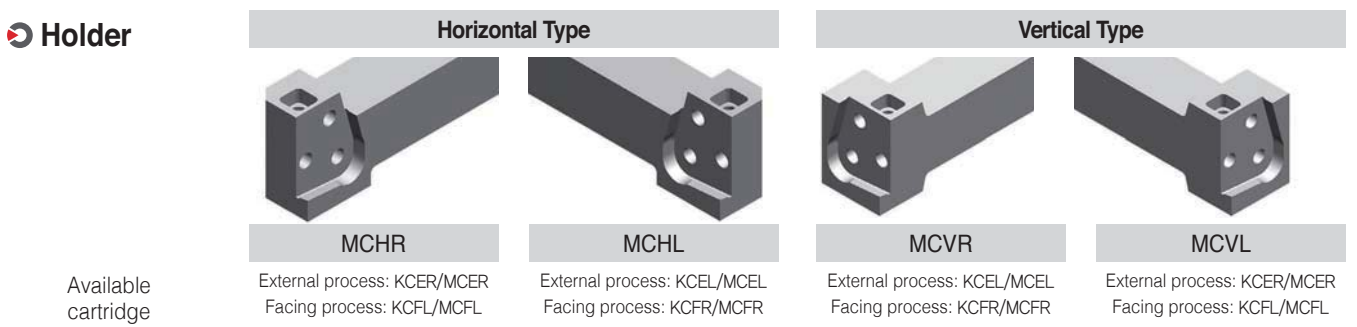

Cartridge code system

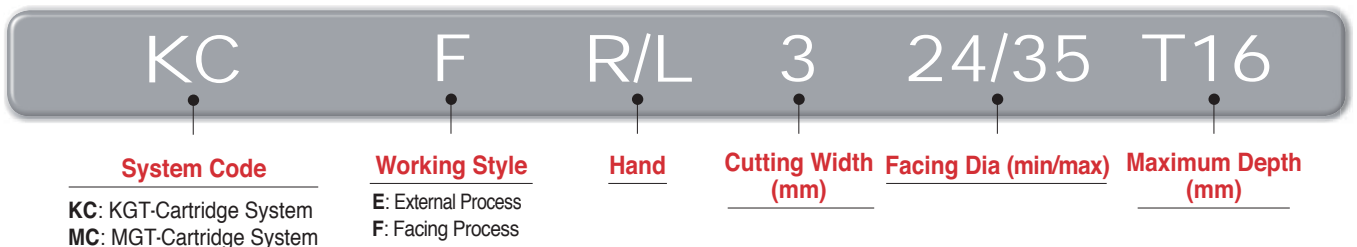

Cartridge



MCHR/L (Holder)

For grooving, turning, parting off, relief, profil machining



MCER/L
MCFR/L

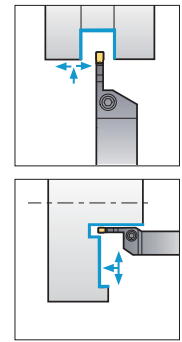
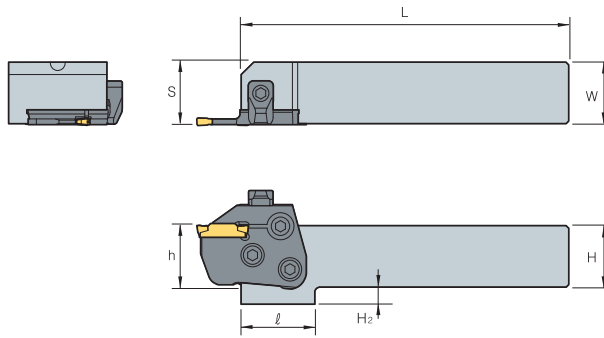

• R type insert

(mm)

Designation	H = (h)	W	L	S	ℓ	H ₂	Cartridge	Clamp	Clamp Screw	Hinge Screw	Clamping Screw	Wrench	
MCHR/L	2020	20	20	133	20.7	30	12	KCER/L, KCFR/L MCER/L, MCFR/L					
	2525	25	25	133	25.7	30	7						
	3232	32	32	153	32.7	-	-						

➔ Applicable cartridge C40~C41

MCVR/L (Holder)

For face grooving, turning machining



MCER/L
MCFR/L

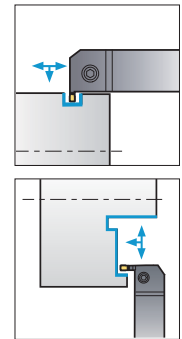
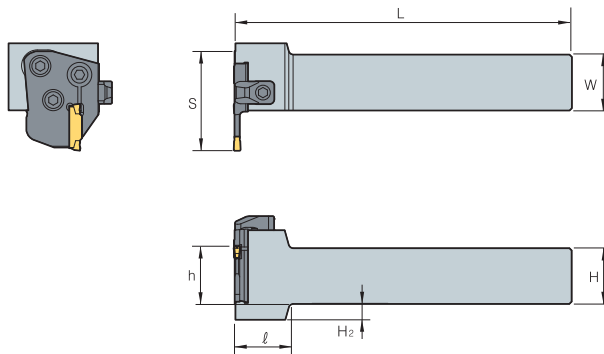

• R type insert

(mm)

Designation	H = (h)	W	L	S	ℓ	H ₂	Cartridge	Clamp	Clamp Screw	Hinge Screw	Clamping Screw	Wrench	
MCVR/L	2020	20	20	150	38	30	12	KCER/L, KCFR/L MCER/L, MCFR/L					
	2525	25	25	150	43	30	7						
	3232	32	32	170	50	-	-						

➔ Applicable cartridge C40~C41

KCER/L (Cartridge)

For grooving, turning, parting off, relief, profil machining



KGMM
KGGN

KGMR/L
KRMN

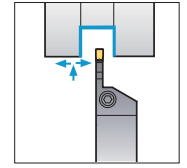
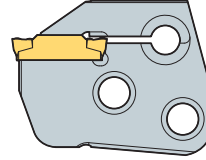
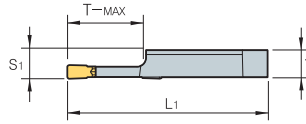

• R type insert
(mm)

Designation	T	L ₁	S ₁	T-MAX	Inserts		Holder
					Width	Designation	
KCER/L	3-T16	5.97	44.5	6.35	16	3	MCVR/L MCHR/L
	4-T16	5.97	44.5	6.35	16	4	
	5-T20	5.87	48.5	6.35	20	5	
	6-T20	5.82	48.5	6.35	20	6	

➔ Applicable inserts C27~C29

KCFR/L (Cartridge)

For face grooving, turning machining



KGMM
KGMI

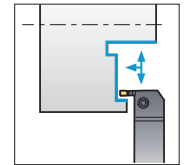
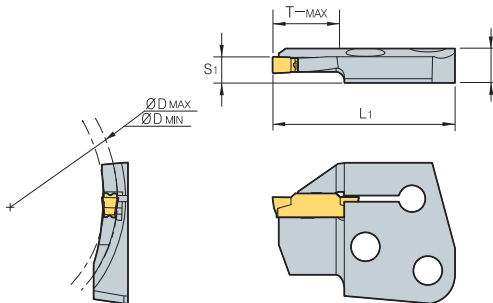

• R type insert
(mm)

Designation	T	L ₁	S ₁	T-MAX	ØD		Width	Inserts		Holder
					Min	Max		Designation		
KCFR/L	3-34/50-T16	8.35	44.5	6.35	16	34	50	3	KGMM KRMN KGGN	MCVR/L MCHR/L
	44/70-T16	8.35	44.5	6.35	16	44	70			
	64/99-T16	8.35	44.5	6.35	16	64	99			
	4-44/60-T16	8.35	44.5	6.35	16	44	60			
	60/120-T16	8.35	44.5	6.35	16	60	120			
	112/200-T16	8.35	44.5	6.35	16	112	200			

➔ Applicable inserts C27~C29

MCER/L (Cartridge)

For grooving, turning, parting off, relief, profil machining



MGMN MGMR
MGGN MRMN

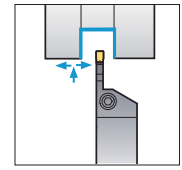
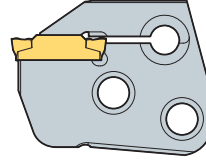
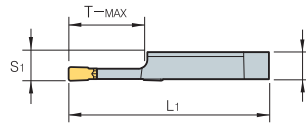

• R type insert
(mm)

Designation	T	L ₁	S ₁	T-MAX	Inserts		Holder
					Width	Designation	
MCER/L	3-T16	6.00	44.5	6.35	16	3	MGMN MGMR/L MGGN MRMN
	4-T16	5.97	44.5	6.35	16	4	
	5-T20	5.87	48.5	6.35	20	5	
	6-T20	5.82	48.5	6.35	20	6	

↻ Applicable inserts C27~C29

MCFR/L (Cartridge)

For face grooving, turning machining



MFNM
MGMN

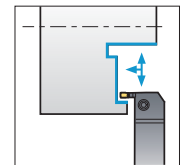
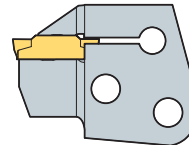
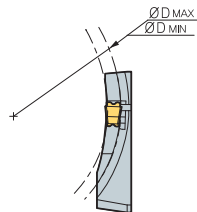
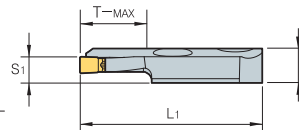

• R type insert
(mm)

Designation	T	L ₁	S ₁	T-MAX	ØD		Inserts		Holder
					Min	Max	Width	Designation	
MCFR/L	3-24/35-T16	8.00	44.5	6.35	16	24	35	3	MFNM300
	29/40-T16	8.00	44.5	6.35	16	29	40	3	
	34/50-T16	8.00	44.5	6.35	16	34	50	3	
	44/70-T16	8.00	44.5	6.35	16	44	70	3	
	64/99-T16	8.00	44.5	6.35	16	64	99	3	
4-	44/60-T16	7.97	44.5	6.35	16	44	60	4	MGMN400
	60/120-T16	7.97	44.5	6.35	16	60	120	4	
	112/200-T16	7.97	44.5	6.35	16	112	200	4	

↻ Applicable inserts C27~C29

MGT - Machining aluminum wheels

Features

- Optimally designed inserts for aluminum wheel machining
- Longer tool life when matched with the best grade for application
- Unique clamping mechanism places a strong clamp over the insert
- A variety of insert types for multi application functions





Insert code system

MR	G	N	6	-	A
System Code	Tolerance	Hand	Cutting Edge Width		Chip Breaker
MR: Multi Grooving Round shape MV: Multi Grooving V shape	G: Ground	N: Neutral	6 mm, 8 mm		A/AM/AP/A5

Holder code system

MG	E	H	R/L	25N	-	8	A	-	MR
System Code	Application	Holder Type	Hand	Shank Size	Cutting Width	Chip Breaker	Insert Type		
MG: Multi Grooving	E: External machining I: Internal machining	H: Horizontal V: Vertical U: Undercut X: Special	R: Right L: Left	Height: 25 mm Width: 25 mm (For internal machining: Minimum diameter)	1.5~8.0 mm	A/AM/ AP/A5	MR: ROUND shape MV: V shape		

Various insert types

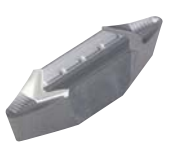
MRGN-A (For general)	MRGN-A5 (For copying)	MRGN-AM (Medium finishing)	MRGN-AP (PCD)	MVGN-A (For fine finishing)
				
High rake angle, Sharp cutting edge	Reinforced clamping force	For ductile cast iron	Improved chip control	High rake and relief angle

MRGN type : Full "Round" geometry

New clamping system

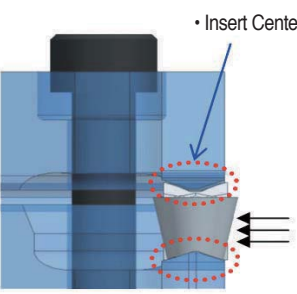

• Insert Centering

Before tightening

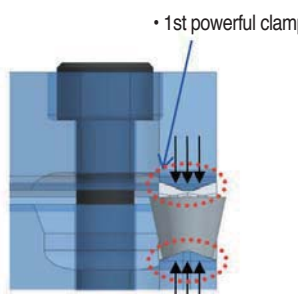

• 1st powerful clamping

After tightening

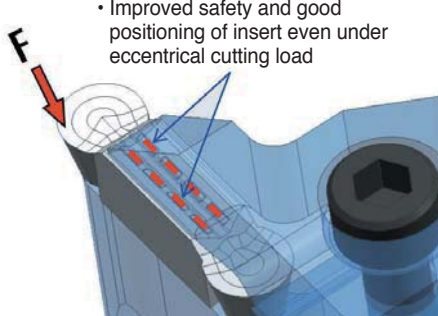

• Improved safety and good positioning of insert even under eccentric cutting load

• Reinforcing the clamping force due to radius designed on the top & bottom side of insert and convex "DOT" on the top of insert

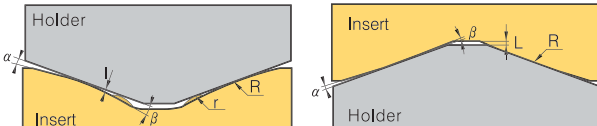

Application of aluminum wheels

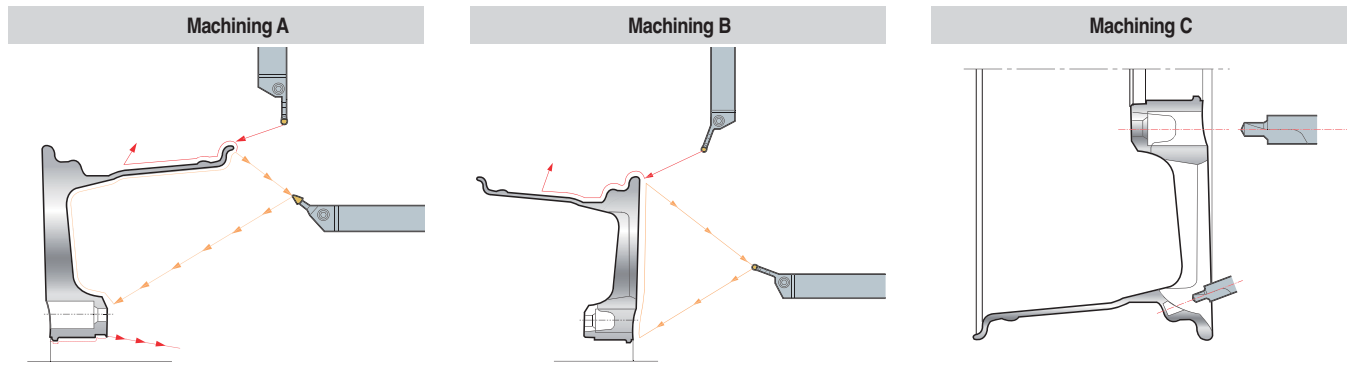

Recommended cutting condition

Workpiece		Hardness Brinell (HB)	kc (MPa)	vc (m/min)	fn (mm/rev)
Aluminum alloy (Forged)	Unhardened	50 ~ 70	500 ~ 600	1,000 ~ 2,500	0.1 ~ 0.6
	Hardened	90 ~ 110	700 ~ 900	300 ~ 1,000	0.1 ~ 0.5
Aluminum alloy (Cast)	Unhardened	70 ~ 80	700 ~ 800	300 ~ 1,000	0.1 ~ 0.5
	Hardened	80 ~ 110	800 ~ 950	200 ~ 600	0.1 ~ 0.4
Copper alloy		90 ~ 110	700 ~ 900	300 ~ 800	0.1 ~ 0.5
Magnesium alloy		70 ~ 80	700 ~ 800	300 ~ 1,000	0.1 ~ 0.5

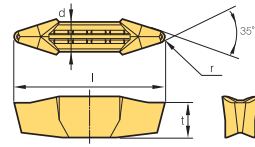
Insert

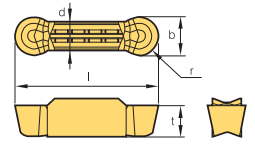
Application	Picture	Designation	Coated	Uncoated	Dimensions (mm)					Configuration	Page	
			DP150	G10	b	r	l	d	t			
For Aluminum Wheel	 MVGN	MVGN									C45	
		8N-A-R1.2			-	1.2	30.0	6.0	6.9			
		8N-A-R1.6			-	1.6	30.0	6.0	6.9			
	 MRGN-A	MRGN	6N-A		●	6.0	3.0	26.0	5.0	5.9		C44 C45
			6N-AM			6.0	3.0	26.0	5.0	5.9		
			6N-AP			6.0	3.0	26.0	5.0	5.9		
			6N-A5		●	6.0	3.0	26.0	5.0	5.9		
			8N-A			8.0	4.0	30.0	6.0	6.5		
			8N-AM			8.0	4.0	30.0	6.0	6.5		
			8N-AP			8.0	4.0	30.0	6.0	6.5		
		8N-A5		●	8.0	4.0	30.0	6.0	6.5			

●: Stock item



MGEHR/L



MRGN

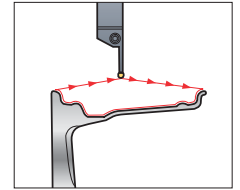
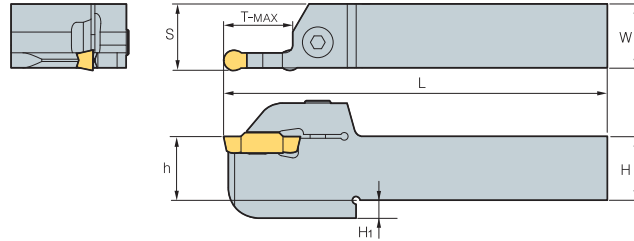

• R type insert (mm)

Designation	H = (h)	H1	W	L	S	T-MAX	Inserts	Screw	Wrench
MGEHR/L 25N-6A	25	7	25	150	25.55	23.5	MRGN6N-A/AP/AM	BHA0620	HW50L
32N-6A	32	8	32	150	32.55	27			
25N-8A	25	7	25	150	25.55	23.5	MRGN8N-A/AP/AM		
32N-8A	32	8	32	150	32.55	27			
25N-6A5	25	7	25	150	25.55	23.5	MRGN6N-A5		
32N-6A5	32	8	32	150	32.55	27	MRGN8N-A5		
25N-8A5	25	7	25	150	25.55	23.5			
32N-8A5	32	8	32	150	32.55	27			

➔ Applicable inserts C43

MGEHR/L-15



MRGN

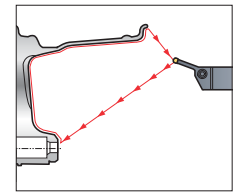
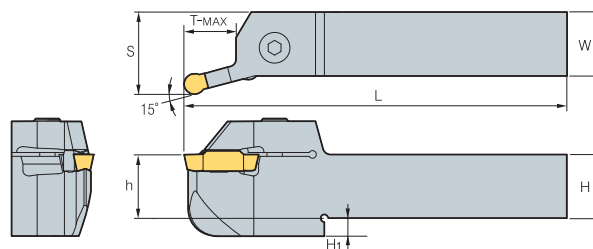

• R type insert (mm)

Designation	H = (h)	H1	W	L	S	T-MAX	Inserts	Screw	Wrench
MGEHR/L 25N-6A-15	25	7	25	150	32.2	20	MRGN6N-A/AP/AM	BHA0620	HW50L
32N-6A-15	32	8	32	150	39.2	25			
25N-8A-15	25	7	25	150	32.2	20	MRGN8N-A/AP/AM		
32N-8A-15	32	8	32	150	39.2	25			
25N-6A5-15	25	7	25	150	32.2	20	MRGN6N-A5		
32N-6A5-15	32	8	32	150	39.2	25	MRGN8N-A5		
25N-8A5-15	25	7	25	150	32.2	20			
32N-8A5-15	32	8	32	150	39.2	25			

➔ Applicable inserts C43

MGIUR/L-MR



MRGN

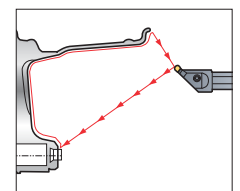
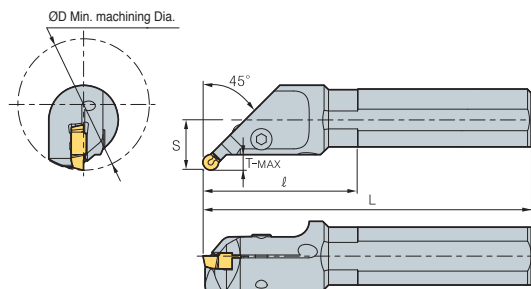

• R type insert (mm)

Designation	ØD	Ød	L	ℓ	T-MAX	H	S	Inserts	Screw	Wrench
MGIUR/L 6832-8A-MR	68	32	170	65	7	30	26	MRGN8N-A/AM/AP	BHA0620	HW50L
6832-8A5-MR	68	32	170	65	7	30	26	MRGN8N-A5		

➔ Applicable inserts C43



MGIXR/L-MR



MRGN

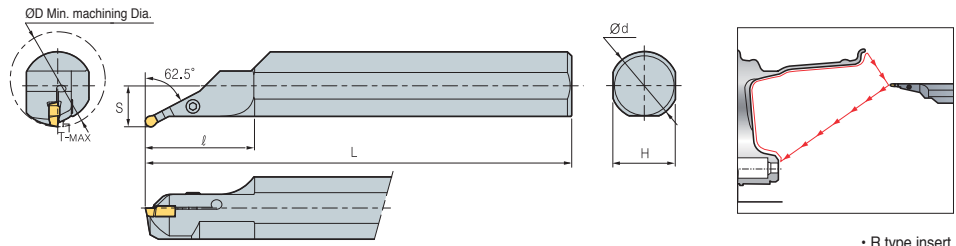

• R type insert
(mm)

Designation	ØD	Ød	L	l	T-MAX	H	S	Inserts	Screw	Wrench
MGIXR/L 7050-8A-MR	70	50	350	80	5.5	46	30.2	MRGN8N-A/AM/AP	BHA0620	HW50L
7050-8A5-MR	70	50	350	80	5.5	46	30.2	MRGN8N-A5		

➔ Applicable inserts C43

MGEXR/L



MVGN

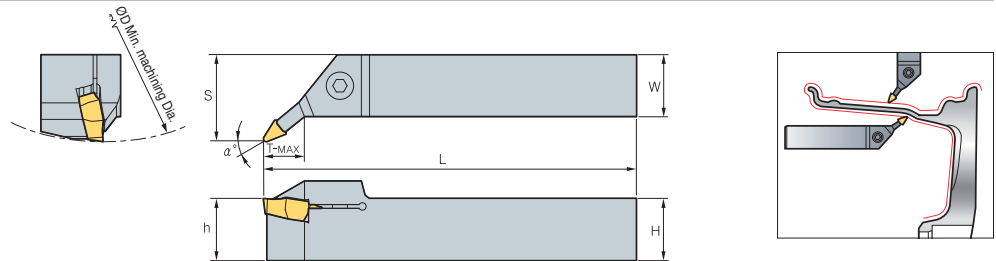

• R type insert
(mm)

Designation	H = (h)	W	L	S	T-MAX	α°	Inserts	Screw	Wrench
MGEXR/L 25N-8A-5V	25	25	150	29	23.5	5	MVGN8N-A-R1.2	BHA0620	HW50L
25N-8A-22.5V	25	25	150	35	27	22.5	MVGN8N-A-R1.6		

➔ Applicable inserts C43

MGIUR/L-MV



MVGN

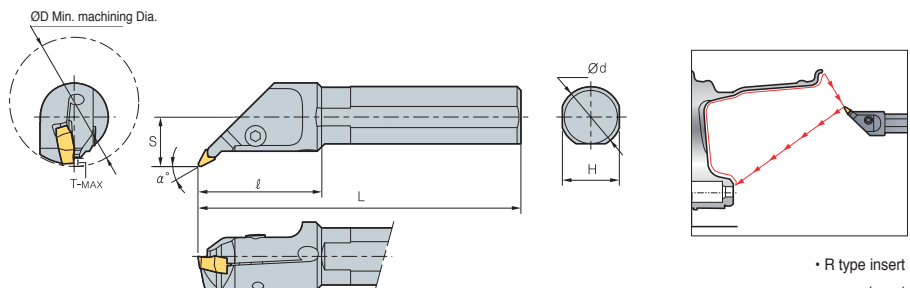

• R type insert
(mm)

Designation	ØD	Ød	L	l	T-MAX	H	S	α°	Inserts	Screw	Wrench
MGIUR/L 6832-8A-MV	68	32	170	65	4.5	30	26	27.5	MVGN8N-A-R1.2	BHA0620	HW50L
									MVGN8N-A-R1.6		

➔ Applicable inserts C43

C Technical Information for TB/TB-M

Economical 3-corner insert for high precision grooving

TB/TB-M

- Economical 3-corner insert for grooving
- Various cutting edge size ranging from 1.25~4.5mm
- High accuracy ground insert ensures high precision machining
- Stable chip control optimized for automated grooving process

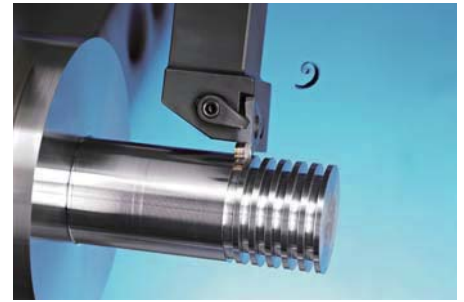

Insert code system

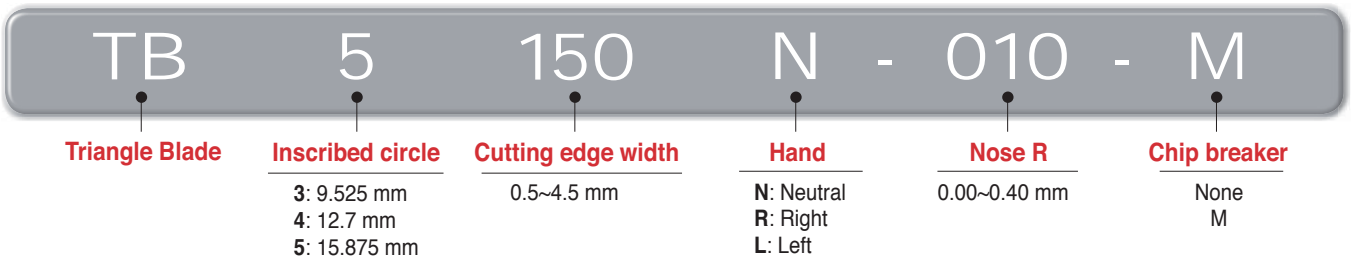

Holder code system

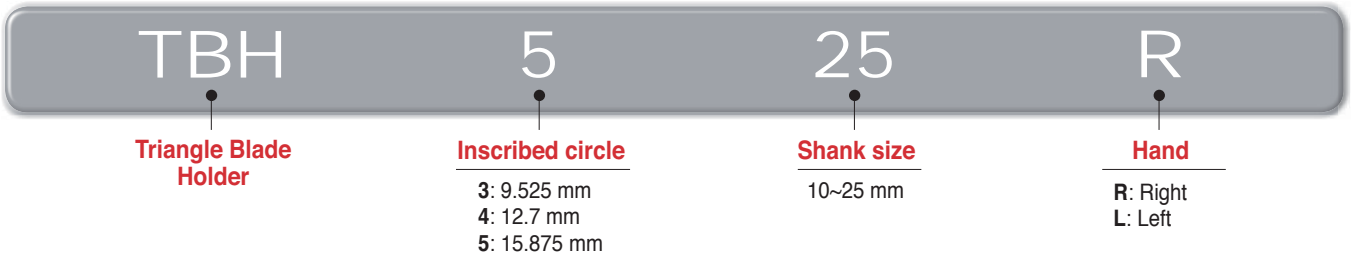

TB/TB-M

Specification	TB3000R/L, TB4000R/L	TB4000R-M	TB5000N-000-M	
Designation	TB3125R/L~TB3430R/L (Inscribed circle of 9.525 mm) TB4125R/L~TB4430R/L (Inscribed circle of 12.7 mm)	TB4150R-M~TB4450R-M (Inscribed circle of 12.7 mm)	TB5050N-000-M~TB5318-020-M (Inscribed circle of 15.875 mm)	
Insert shape				
Features	Chip breaker	Ground chip breaker	Pressed chip breaker	
	Hand	Right/Left-handed	Right-handed	Neutral
	Cutting edge width (b)	TB3000: 1.25~4.3 mm TB4000: 1.25~4.5 mm	1.5~4.5 mm	0.5~3.18 mm
	Depth of cut (T-MAX)	TB3000: ~3.5 mm TB4000: ~5.0 mm	~5.0 mm	~6.5 mm
	Shape	○	X	X
	Cutting edge width	○	○	○
Chip breaker shape				
Application range	P	P, M, K	P, M, K	
Grade	CN2000, PC5300	CN2000, PC5300	PC5300	



🔗 TB-M chip breaker

- Minimized cutting force at high speed and high feed → Smooth chip evacuation outside each groove
- High precision cutting performance → Exceptional surface finish and accurate dimensions
- Excellent chip flow and cutting results → Ideal for automated and unmanned productionw

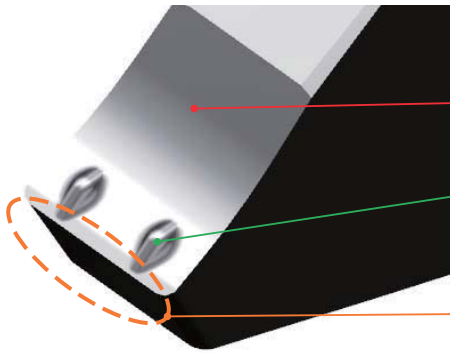

TB5-M Chip breaker

- **Lowered back area:** reduced load of chip evacuation due to minimizing chip friction
- **Beveled protruding dot:** made regular sized chip curls good chip flow out of the groove by reducing the chip width minimized load for chip evacuation in high depth of cut
- **Land:** prevented chipping and increased stability in interrupted machining
- **Use:** for grooving with T-MAX 6.5mm below, parting and interrupted machining

Designation	TB5050N-M ~ TB5120N-M	TB5140N-M ~ TB5178N-M	TB5196N-M ~ TB5239N-M	TB5247N-M ~ TB5287N-M	TB5300N-M ~ TB5318N-M
Shape					
Cutting edge width (b)	0.5~1.2 mm	1.40~1.78 mm	1.96~2.39 mm	2.47~2.87 mm	3.0~3.18 mm

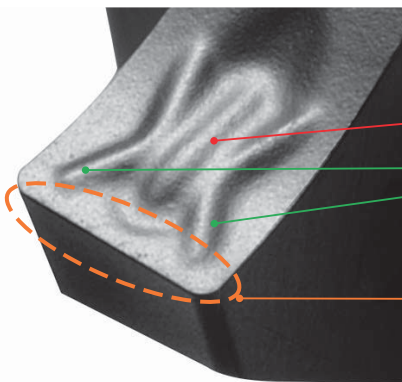

TB4-M Chip breaker

- **Second protruding dot:** stable chip curl control
- **Main protruding dot:** making regular sized chip curl good chip flow out of the groove by reducing the chip width good chip control in turning and chamfering
- **Sharp cutting edge:** increased machinability
- **Use:** for grooving with T-MAX 4.5mm below and turning

Designation	TB4150R-M ~ TB4185R-M	TB4200R-M ~ TB4228R-M	TB4300R-M ~ TB4350R-M	TB4400R-M ~ TB4450R-M
Shape				
Cutting edge width (b)	1.5~1.85 mm	2.0~2.8 mm	3.0~3.5 mm	4.0~4.5 mm

C Technical Information for TB/TB-M

Guide for TB

(mm)

TB				TB3 / TB4	TB4-M	TB5-M
Recommended machining method						
Cutting edge width W	Depth of cut T-MAX			Recommended feed rate (mm/rev)		
	TB3/TB4	TB4-M	TB5-M			
0.50	-	-	2.5	-	-	●
0.80	-	-	1.6	-	-	●
1.00	-	-	3.5	-	-	●
1.04	-	-	2.0	-	-	●
1.20	-	-	2.0	-	-	●
1.25	2.0	-	2.0	●	-	-
1.40	2.0	-	6.5	●	-	●
1.45	2.0	-	-	●	-	-
1.47	-	-	6.5	-	-	●
1.50	3.5	3.5	6.5	●	●	●
1.57	-	-	6.5	-	-	●
1.70	-	-	6.5	-	-	●
1.75	3.5	3.5	-	●	●	-
1.78	-	-	6.5	-	-	●
1.85	3.5	3.5	-	●	●	-
1.96	-	-	6.5	-	-	●
2.00	3.5	3.5	6.5	●	●	●
2.15	3.5	3.5	-	●	●	-
2.22	6.5	-	6.5	-	-	●
2.30	3.5	3.5	6.5	●	●	●
2.39	-	-	6.5	-	-	●
2.47	-	-	6.5	-	-	●
2.50	4.0	4.0	6.5	●	●	●
2.65	4.0	4.0	6.5	●	●	-
2.70	-	-	6.5	-	-	●
2.80	4.0	4.0	-	●	●	-
2.87	-	-	6.5	-	-	●
3.00	4.0	4.0	6.5	●	●	●
3.15	-	-	6.5	-	-	●
3.18	-	-	6.5	-	-	●
3.30	4.0	-	-	●	-	-
3.50	5.0	5.0	-	●	●	-
4.00	5.0	5.0	-	●	●	-
4.30	5.0	5.0	-	●	●	-
4.50	5.0	5.0	-	●	●	-

● : Stock item

Recommended cutting conditions

Workpiece		CN2000 (Cermet)			PC5300 (Coated)		
		Min	Recommended	Max.	Min	Recommended	Max.
P	SM□□C type	100	160	220	80	140	200
	SCM type	100	150	200	80	130	180
M	STS type	-	-	-	40	80	150
K	GC, GCD type	-	-	-	80	130	180

Recommended cutting speed, vc (m/min)

Recommended cutting range

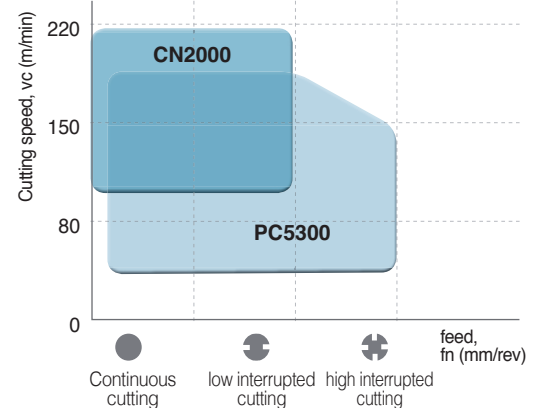

C

Multi functional Tools

➤ TB5-M machining range

- There is a limit to cutting diameters of TB5-M when depth of cuts are over 5 mm
(e.g. When cutting with a TB5200N-020-M insert at the depth of 6.2 mm, Ø60 D-MAX is available)
- N.L = No limit

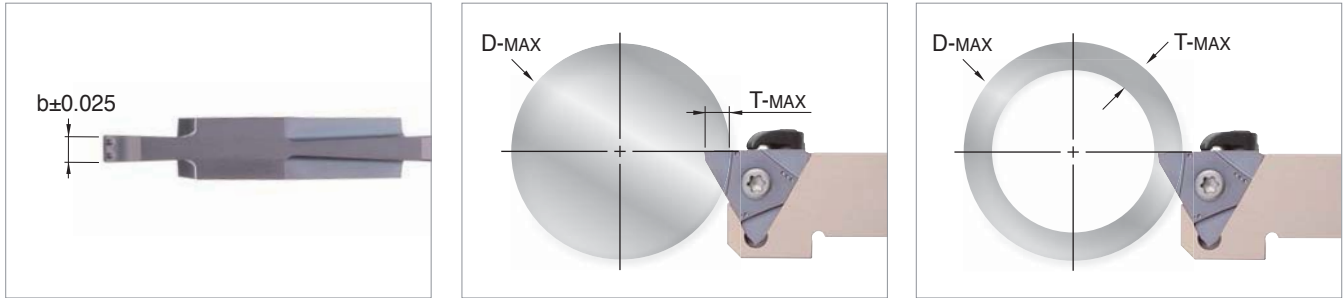



(mm)

Designation	b	r	g (T-MAX)	ØD-MAX									
				T≤3.0	T≤3.5	T≤4.0	T≤4.5	T≤5.0	T≤5.5	T≤6.0	T≤6.4	T≤6.5	
TB 5050N- 000-M	0.50	0.00	1.0	-	-	-	-	-	-	-	-	-	-
004-M	0.50	0.04	2.5	-	-	-	-	-	-	-	-	-	-
5080N- 000-M	0.80	0.00	1.6	-	-	-	-	-	-	-	-	-	-
5100N- 006-M	1.00	0.06	3.5	-	-	-	-	-	-	-	-	-	-
5104N- 000-M	1.04	0.00	2.0	-	-	-	-	-	-	-	-	-	-
5120N- 000-M	1.20	0.00	2.0	-	-	-	-	-	-	-	-	-	-
5140N- 000-M	1.40	0.00	6.5	N.L	N.L	N.L	N.L	N.L	Ø300	Ø170	Ø60	Ø40	
5147N- 000-M	1.47	0.00	6.5	N.L	N.L	N.L	N.L	N.L	Ø300	Ø170	Ø60	Ø40	
5150N- 010-M	1.50	0.10	6.5	N.L	N.L	N.L	N.L	N.L	Ø300	Ø170	Ø60	Ø40	
015-M	1.50	0.15	6.5	N.L	N.L	N.L	N.L	N.L	Ø300	Ø170	Ø60	Ø40	
5157N- 015-M	1.57	0.15	6.5	N.L	N.L	N.L	N.L	N.L	Ø300	Ø170	Ø60	Ø40	
5170N- 010-M	1.70	0.10	6.5	N.L	N.L	N.L	N.L	N.L	Ø300	Ø170	Ø60	Ø40	
5178N- 018-M	1.78	0.18	6.5	N.L	N.L	N.L	N.L	N.L	Ø300	Ø170	Ø60	Ø40	
5196N- 015-M	1.96	0.15	6.5	N.L	N.L	N.L	N.L	N.L	Ø300	Ø170	Ø60	Ø40	
5200N- 020-M	2.00	0.20	6.5	N.L	N.L	N.L	N.L	N.L	Ø300	Ø170	Ø60	Ø40	
5222N- 015-M	2.22	0.15	6.5	N.L	N.L	N.L	N.L	N.L	Ø300	Ø170	Ø60	Ø40	
5230N- 020-M	2.30	0.20	6.5	N.L	N.L	N.L	N.L	N.L	Ø300	Ø170	Ø60	Ø40	
5239N- 015-M	2.39	0.15	6.5	N.L	N.L	N.L	N.L	N.L	Ø300	Ø170	Ø60	Ø40	
5247N- 020-M	2.47	0.20	6.5	N.L	N.L	N.L	N.L	N.L	Ø300	Ø170	Ø60	Ø40	
5250N- 020-M	2.50	0.20	6.5	N.L	N.L	N.L	N.L	N.L	Ø300	Ø170	Ø60	Ø40	
5270N- 010-M	2.70	0.10	6.5	N.L	N.L	N.L	N.L	N.L	Ø300	Ø170	Ø60	Ø40	
5287N- 020-M	2.87	0.20	6.5	N.L	N.L	N.L	N.L	N.L	Ø300	Ø170	Ø60	Ø40	
5300N- 000-M	3.00	0.00	6.5	N.L	N.L	N.L	N.L	N.L	Ø300	Ø170	Ø60	Ø40	
5300N- 020-M	3.00	0.20	6.5	N.L	N.L	N.L	N.L	N.L	Ø300	Ø170	Ø60	Ø40	
040-M	3.00	0.40	6.5	N.L	N.L	N.L	N.L	N.L	Ø300	Ø170	Ø60	Ø40	
5315N- 015-M	3.15	0.15	6.5	N.L	N.L	N.L	N.L	N.L	Ø300	Ø170	Ø60	Ø40	
5318N- 020-M	3.18	0.20	6.5	N.L	N.L	N.L	N.L	N.L	Ø300	Ø170	Ø60	Ø40	

C Available Insert for TB/TB-M

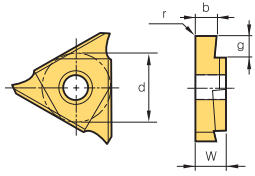

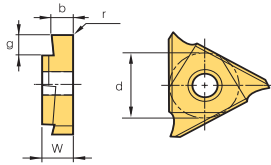
Insert

Picture	Designation	Cermet	Coated	Dimensions (mm)					Configuration
		CN2000	PC5300	b	g (T-MAX)	r	w	d	
	TB (Right-handed)								
	3125R			1.25	1.5	0.2	4.76	9.525	
	3145R			1.45	1.5	0.2	4.76	9.525	
	3175R			1.75	2.5	0.2	4.76	9.525	
	3185R			1.85	2.5	0.2	4.76	9.525	
	3200R			2.00	2.5	0.2	4.76	9.525	
	3230R			2.30	3.5	0.3	4.76	9.525	
	3280R			2.80	3.5	0.3	4.76	9.525	
	3330R			3.30	3.5	0.3	4.76	9.525	
	3430R			4.30	3.5	0.4	4.76	9.525	
	4125R	●	●	1.25	2.0	0.2	4.76	12.7	
	4145R	●	●	1.45	2.0	0.2	4.76	12.7	
	4150R	●	●	1.50	3.5	0.2	4.76	12.7	
	4175R	●	●	1.75	3.5	0.2	4.76	12.7	
	4185R	●	●	1.85	3.5	0.2	4.76	12.7	
	4200R	●	●	2.00	3.5	0.2	4.76	12.7	
	4215R	●	●	2.15	3.5	0.2	4.76	12.7	
	4230R	●	●	2.30	3.5	0.2	4.76	12.7	
	4250R	●	●	2.50	4.0	0.3	4.76	12.7	
	4265R	●	●	2.65	4.0	0.3	4.76	12.7	
	4280R	●	●	2.80	4.0	0.3	4.76	12.7	
	4300R	●	●	3.00	4.0	0.3	4.76	12.7	
	4330R	●	●	3.30	4.0	0.3	4.76	12.7	
	4350R	●	●	3.50	5.0	0.3	4.76	12.7	
4400R	●	●	4.00	5.0	0.4	4.76	12.7		
4430R	●	●	4.30	5.0	0.4	4.76	12.7		
4450R	●	●	4.50	5.0	0.4	4.76	12.7		
	TB (Left-handed)								
	3125L			1.25	1.5	0.2	4.76	9.525	
	3145L			1.45	1.5	0.2	4.76	9.525	
	3175L			1.75	2.5	0.2	4.76	9.525	
	3185L			1.85	2.5	0.2	4.76	9.525	
	3200L			2.00	2.5	0.2	4.76	9.525	
	3230L			2.30	3.5	0.3	4.76	9.525	
	3280L			2.80	3.5	0.3	4.76	9.525	
	3330L			3.30	3.5	0.3	4.76	9.525	
	3430L			4.30	3.5	0.4	4.76	9.525	
	4125L			1.25	2.0	0.2	4.76	12.7	
	4145L			1.45	2.0	0.2	4.76	12.7	
	4150L			1.50	3.5	0.2	4.76	12.7	
	4175L			1.75	3.5	0.2	4.76	12.7	
	4185L			1.85	3.5	0.2	4.76	12.7	
	4200L			2.00	3.5	0.2	4.76	12.7	
	4215L			2.15	3.5	0.2	4.76	12.7	
	4230L			2.30	3.5	0.2	4.76	12.7	
	4250L			2.50	4.0	0.3	4.76	12.7	
	4265L			2.65	4.0	0.3	4.76	12.7	
	4280L			2.80	4.0	0.3	4.76	12.7	
	4300L			3.00	4.0	0.3	4.76	12.7	
	4330L			3.30	4.0	0.3	4.76	12.7	
	4350L			3.50	5.0	0.3	4.76	12.7	
4400L			4.00	5.0	0.4	4.76	12.7		
4430L			4.30	5.0	0.4	4.76	12.7		
4450L			4.50	5.0	0.4	4.76	12.7		

● : Stock item

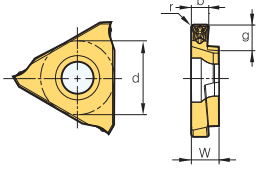

Insert

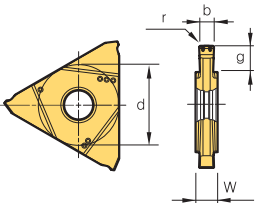
Picture	Designation	Cermet		Coated		Dimensions (mm)					Configuration
		CN2000	PC5300	b	g (T-MAX)	r	w	d			
	TB (Right-handed)	4150R-M	●	●	1.50	3.5	0.20	4.76	12.7		
	4175R-M	●	●	1.75	3.5	0.20	4.76	12.7			
	4185R-M	●	●	1.85	3.5	0.20	4.76	12.7			
	4200R-M	●	●	2.00	3.5	0.20	4.76	12.7			
	4215R-M	●	●	2.15	3.5	0.20	4.76	12.7			
	4230R-M	●	●	2.30	3.5	0.20	4.76	12.7			
	4250R-M	●	●	2.50	4.0	0.30	4.76	12.7			
	4265R-M	●	●	2.65	4.0	0.30	4.76	12.7			
	4280R-M	●	●	2.80	4.0	0.30	4.76	12.7			
	4300R-M	●	●	3.00	4.0	0.30	4.76	12.7			
	4330R-M	●	●	3.30	4.0	0.30	4.76	12.7			
	4350R-M	●	●	3.50	5.0	0.30	4.76	12.7			
	4400R-M	●	●	4.00	5.0	0.40	4.76	12.7			
	4430R-M	●	●	4.30	5.0	0.40	4.76	12.7			
	4450R-M	●	●	4.50	5.0	0.40	4.76	12.7			
	TB (Neutral)	5050N-000-M		●	0.50	1.0	0.00	4.50	15.875		
	5050N-004-M			●	0.50	2.5	0.04	4.50	15.875		
	5080N-000-M			●	0.80	1.6	0.00	4.50	15.875		
	5100N-006-M			●	1.00	3.5	0.06	4.50	15.875		
	5104N-000-M			●	1.04	2.0	0.00	4.50	15.875		
	5120N-000-M			●	1.20	2.0	0.00	4.50	15.875		
	5140N-000-M			●	1.40	6.5	0.00	4.50	15.875		
	5147N-000-M			●	1.47	6.5	0.00	4.50	15.875		
	5150N-010-M			●	1.50	6.5	0.10	4.50	15.875		
	5150N-015-M			●	1.50	6.5	0.15	4.50	15.875		
	5157N-015-M			●	1.57	6.5	0.15	4.50	15.875		
	5170N-010-M			●	1.70	6.5	0.10	4.50	15.875		
	5178N-018-M			●	1.78	6.5	0.18	4.50	15.875		
	5196N-015-M			●	1.96	6.5	0.15	4.50	15.875		
	5200N-020-M			●	2.00	6.5	0.20	4.50	15.875		
	5222N-015-M			●	2.22	6.5	0.15	4.50	15.875		
	5230N-020-M			●	2.30	6.5	0.20	4.50	15.875		
	5239N-015-M			●	2.39	6.5	0.15	4.50	15.875		
	5247N-020-M			●	2.47	6.5	0.20	4.50	15.875		
	5250N-020-M			●	2.50	6.5	0.20	4.50	15.875		
	5270N-010-M			●	2.70	6.5	0.10	4.50	15.875		
	5287N-020-M			●	2.87	6.5	0.20	4.50	15.875		
	5300N-000-M			●	3.00	6.5	0.00	4.50	15.875		
	5300N-020-M			●	3.00	6.5	0.20	4.50	15.875		
	5300N-040-M			●	3.00	6.5	0.40	4.50	15.875		
5315N-015-M			●	3.15	6.5	0.15	4.50	15.875			
5318N-020-M			●	3.18	6.5	0.20	4.50	15.875			

● : Stock item

C Available Insert for TB/TB-M

Insert

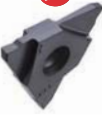
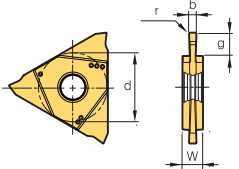
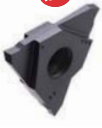
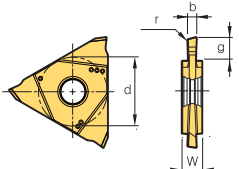
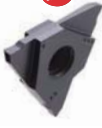
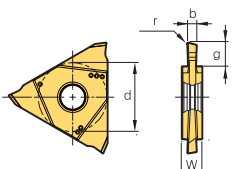
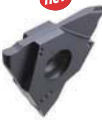
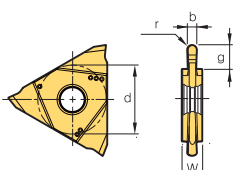
Shape	Designation	Cermet	Coated	Dimensions (mm)						ShapeShape
		CN2000	PC5300	b	g (T-MAX)	r	a°	w	d	
 (Neutral)	TB 5050N-004-P			0.50	1.0	0.04	-	4.50	15.875	
	5100N-010-P			1.00	3.5	0.10	-	4.50	15.875	
	5150N-010-P			1.50	6.5	0.10	-	4.50	15.875	
	-020-P			1.50	6.5	0.20	-	4.50	15.875	
	5200N-010-P			2.00	6.5	0.10	-	4.50	15.875	
	-020-P			2.00	6.5	0.20	-	4.50	15.875	
	5239N-015-P			2.39	6.5	0.15	-	4.50	15.875	
	5250N-020-P			2.50	6.5	0.20	-	4.50	15.875	
	5300N-020-P			3.00	6.5	0.20	-	4.50	15.875	
 (Neutral, Right cutting)	TB 5100N-6DR-P			1.00	3.5	0.05	6	4.50	15.875	
	15DR-P			1.00	3.5	0.05	15	4.50	15.875	
	5150N-6DR-P			1.50	6.5	0.05	6	4.50	15.875	
	15DR-P			1.50	6.5	0.05	15	4.50	15.875	
	5200N-6DR-P			2.00	6.5	0.10	6	4.50	15.875	
	15DR-P			2.00	6.5	0.10	15	4.50	15.875	
 (Neutral, Left cutting)	TB 5100N-6DL-P			1.00	3.5	0.05	6	4.50	15.875	
	15DL-P			1.00	3.5	0.05	15	4.50	15.875	
	5150N-6DL-P			1.50	6.5	0.05	6	4.50	15.875	
	15DL-P			1.50	6.5	0.05	15	4.50	15.875	
	5200N-6DL-P			2.00	6.5	0.10	6	4.50	15.875	
	15DL-P			2.00	6.5	0.10	15	4.50	15.875	
 (Neutral, Round shape)	TB 5157N-079-P			1.57	6.5	0.79	-	4.50	15.875	
	5200N-100-P			2.00	6.5	1.00	-	4.50	15.875	
	5239N-120-P			2.39	6.5	1.20	-	4.50	15.875	
	5300N-150-P			3.00	6.5	1.50	-	4.50	15.875	



TBH



TB3000R/L
TB4000R-M

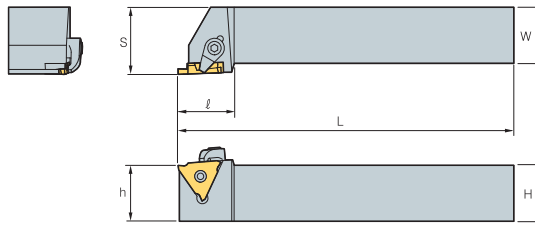
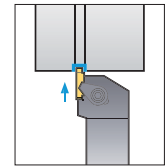

Fig. 1



• R type insert



TB5000N-000-M

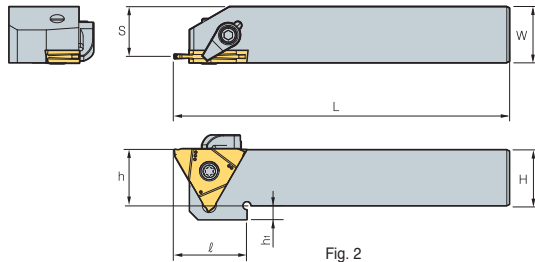

Fig. 2

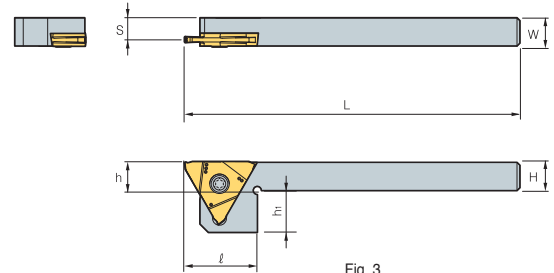

Fig. 3

(mm)

Designation	Dimensions						Applicable insert	Clamp	Clamp screw	Screw	Wrench	Fig.	
	H = (h)	W	L	ℓ	h ₁	S							
TBH	320R/L-23	20	20	125	25.5	-	25	CS6R1	DHA0617	-	HW30L	1	
	320R/L-33	20	20	125	25.5	-	25						
	320R/L-43	20	20	125	25.5	-	25						
	325R/L-23	25	25	150	25.5	-	30						
	325R/L-33	25	25	150	25.5	-	30						
	325R/L-43	25	25	150	25.5	-	30						
	420R/L-23	20	20	125	25.5	-	25						
	420R/L-33	20	20	125	25.5	-	25						
	420R/L-45	20	20	125	25.5	-	25						
	425R/L-23	25	25	150	25.5	-	30						
	425R/L-33	25	25	150	25.5	-	30						
425R/L-45	25	25	150	25.5	-	30							
TBH	510R/L	10	10	125	25	15	7.8	TB5050~5318N	-	-	FTNA0512	TW20L	3
	512R/L	12	12	125	25	13	9.8						
	516R/L	16	16	125	26	9	13.8						
	520R/L	20	20	125	26	5	17.8						
	525R/L	25	25	150	-	-	22.8						
								CS6R1	DHA0617	FTNA0516	HW30L, TW20L	2	



C Technical Information for K Notch

The Solution for High-Precision Grooving

K Notch

KORLOY GROOVING TOOL

- KORLOY clamping system offers high rigidity for high precision machining
- High-quality cutting edge ensuring long tool life and excellent machinability
- Provides various cutting edge widths for a wide range of selection

Insert code system

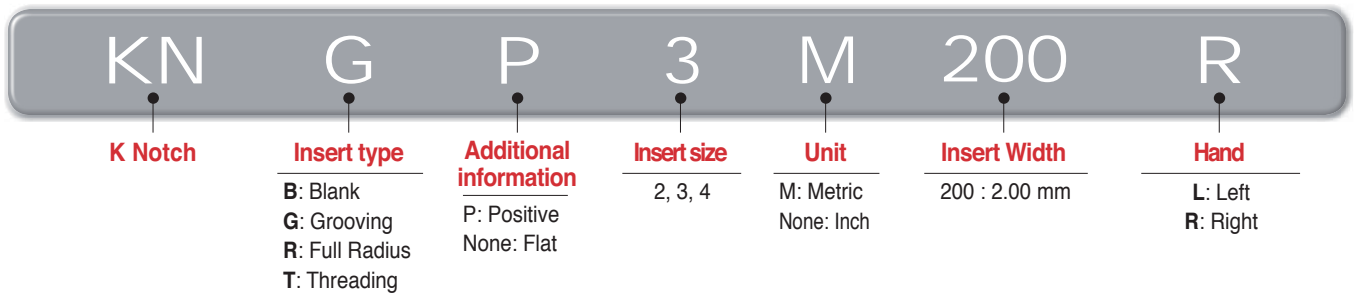

Holder code system

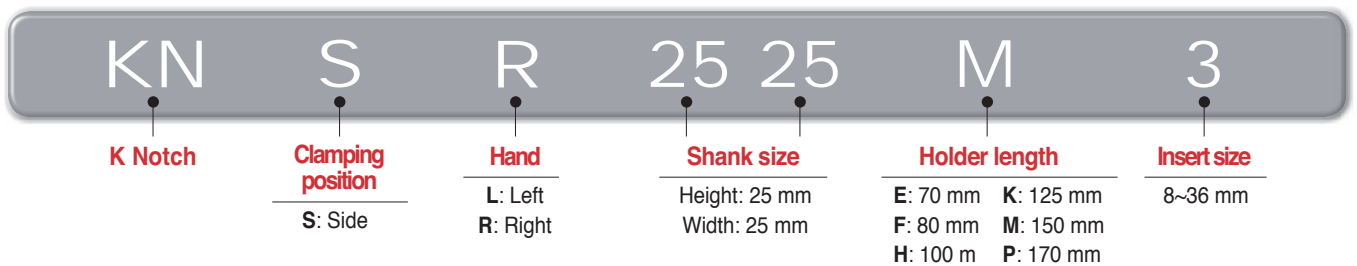

Features of holder

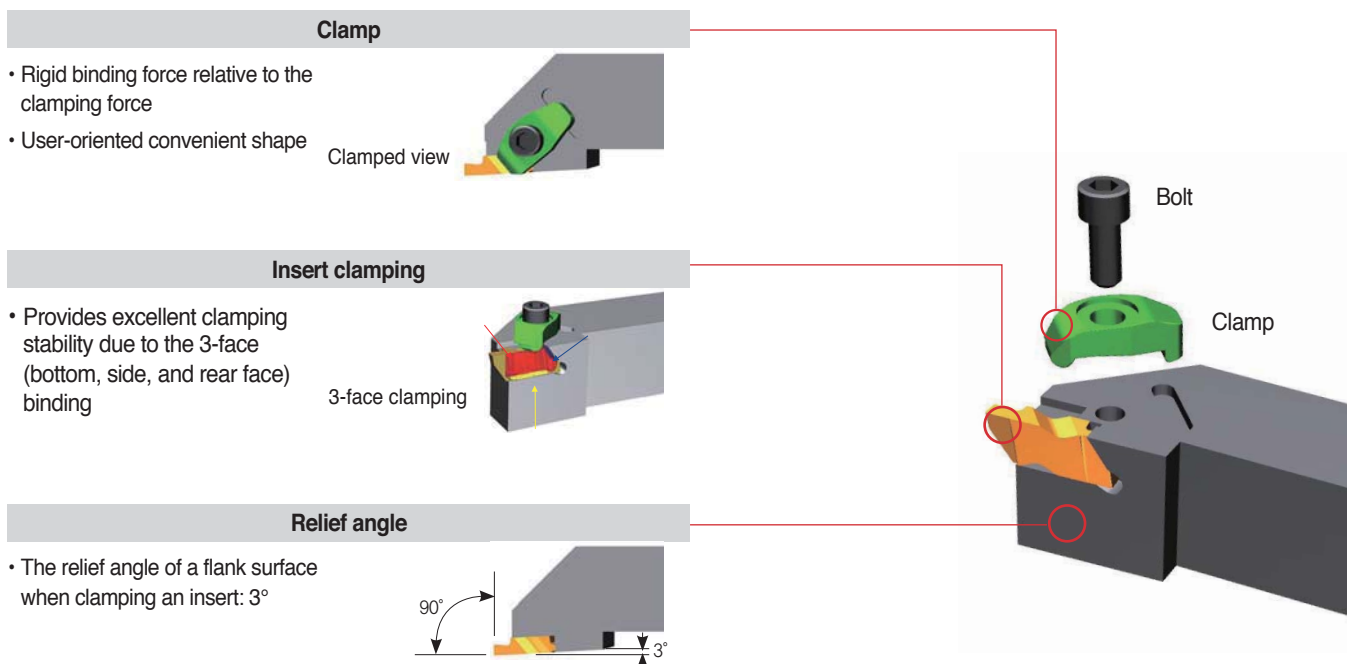

Features of insert

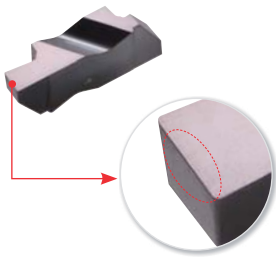

[Edge preparation]

High-quality edge preparation

- Cutting edges in uniform quality
- Long tool life

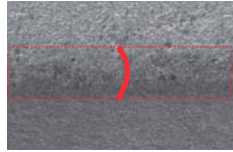

[Competitor]

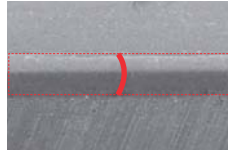

[K Notch]

Mirror-like rake surface

- Improved resistance to welding and chipping
- Improved surface finish of workpieces



[K Notch]

Recommended feed per insert type



Type		KNG	KNGP	KNR	KNRP	KNB
Insert shape						
Cutting-edge						
Application		General grooving	General grooving	Turning profiling	Turning profiling	Blank
Recommended workpiece	1st	P, K	M, N, S	P, K	M, N, S	-
	2nd	M, N, S	P, K	M, N, S	P, K	-
Recommended feed, f_n (mm/rev)	P	0.10 - 0.28	0.08 - 0.25	0.10 - 0.28	0.08 - 0.25	-
	M	0.10 - 0.25	0.08 - 0.25	0.10 - 0.25	0.08 - 0.25	-
	K	0.10 - 0.28	0.08 - 0.25	0.10 - 0.28	0.08 - 0.25	-
	N	0.01 - 0.30	0.01 - 0.30	0.01 - 0.30	0.01 - 0.30	-
	S	0.05 - 0.15	0.05 - 0.15	0.05 - 0.15	0.05 - 0.15	-

Recommended cutting speed per grade

Workpiece	Grade	Recommended cutting speed, v_c (m/min)					
		50	100	200	300	600	
P	Steel		80	200			
	Alloy steel	60	160				
M	Stainless steel		80	130			
			80	160			
K	Cast iron		90	200			
N	Non-ferrous metal			150		600	
S	Heat-resistant alloy	35	65				

C Available Insert for K Notch

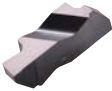
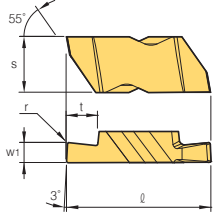
Insert (Metric)

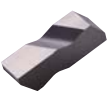
Application	Picture	Designation	Coated			Dimensions										Configuration	
			PC5300	PC8110	Uncoated	mm					inch						
						s	w ₁	r	t	ℓ	s	w ₁	r	t	ℓ		
Flat Top		KNG 2M	150R				5.56	1.50	0.19	2.79	13.030	0.219	0.059	0.0075	0.11	0.513	
			200R				5.56	2.00	0.19	2.79	13.030	0.219	0.079	0.0075	0.11	0.513	
			250R				5.56	2.50	0.19	2.79	13.030	0.219	0.098	0.0075	0.11	0.513	
		3M	150R	●	●		8.74	1.50	0.19	1.91	22.709	0.344	0.059	0.0075	0.075	0.894	
			200R	●	●		8.74	2.00	0.19	2.79	22.709	0.344	0.079	0.0075	0.11	0.894	
			250R	●	●		8.74	2.50	0.19	3.81	22.709	0.344	0.098	0.0075	0.15	0.894	
			300R	●	●		8.74	3.00	0.19	3.81	22.709	0.344	0.118	0.0075	0.15	0.894	
		4M	500R				11.51	5.00	0.20	6.35	28.663	0.453	0.197	0.0079	0.25	1.128	
			600R				11.51	6.00	0.20	6.35	28.663	0.453	0.236	0.0079	0.25	1.128	
			400R	●	●		8.74	4.00	0.19	3.81	22.709	0.344	0.157	0.0075	0.15	0.894	
		C/B Ground		KNGP 2M	150R				5.56	1.50	0.19	2.79	13.030	0.219	0.059	0.0075	
200R							5.56	2.00	0.19	2.79	13.030	0.219	0.079	0.0075	0.11	0.513	
250R							5.56	2.50	0.19	2.79	13.030	0.219	0.098	0.0075	0.11	0.513	
3M	150R			●	●		8.74	1.50	0.19	1.91	22.709	0.344	0.059	0.0075	0.075	0.894	
	200R			●	●		8.74	2.00	0.19	2.79	22.709	0.344	0.079	0.0075	0.11	0.894	
	250R			●	●		8.74	2.50	0.19	3.81	22.709	0.344	0.098	0.0075	0.15	0.894	
	300R			●	●		8.74	3.00	0.19	3.81	22.709	0.344	0.118	0.0075	0.15	0.894	
4M	500R						11.51	5.00	0.20	6.35	28.663	0.453	0.197	0.0079	0.25	1.128	
	600R						11.51	6.00	0.20	6.35	28.663	0.453	0.236	0.0079	0.25	1.128	
	400R			●	●		8.74	4.00	0.19	3.81	22.709	0.344	0.157	0.0075	0.15	0.894	
Blank				KNB	2R				5.56	3.81	-	-	13.030	0.219	0.150	-	-
		3R					8.74	4.95	-	-	22.709	0.344	0.195	-	-	0.894	
		4R					11.51	6.48	-	-	28.663	0.453	0.255	-	-	1.128	

● : Stock item



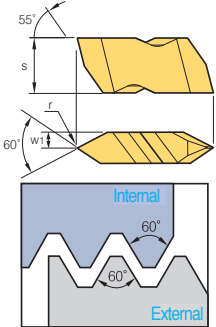

Insert (Threading)

Application	Picture	Designation	Coated		Dimensions							Configuration		
			PC5300	PC8110	mm			inch			Pitch (External)			
					s	w ₁	r	s	w ₁	r	mm		tpi	
Partial Profiling 60°		KNT	2R			5.56	3.81	0.10	0.219	0.150	0.004	0.70-3.00	8-36	
			3R			8.74	4.95	0.17	0.344	0.195	0.007	1.25-4.00	6-20	
			4R			11.51	6.48	0.17	0.453	0.255	0.007	1.25-6.25	4-20	

● : Stock item

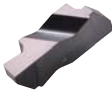
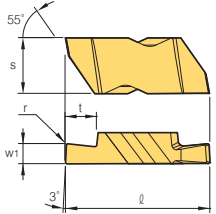

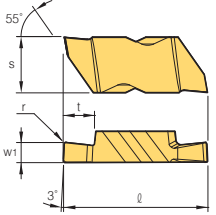
Insert (Inch)

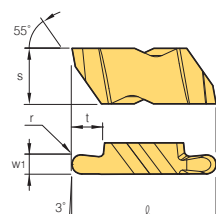
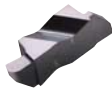
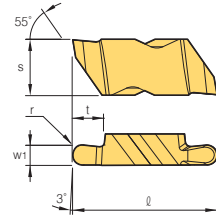
Application	Picture	Designation	Coated		Dimensions										Configuration
			PC5300	PC8110	mm					inch					
					s	w1	r	t	ℓ	s	w1	r	t	ℓ	
Flat Top		KNG	2031R		5.56	0.79	0.09	1.27	13.030	0.219	0.031	0.0035	0.05	0.513	
			2041R		5.56	1.04	0.09	1.27	13.030	0.219	0.041	0.0035	0.05	0.513	
			2047R		5.56	1.19	0.09	1.27	13.030	0.219	0.047	0.0035	0.05	0.513	
			2058R		5.56	1.47	0.19	1.27	13.030	0.219	0.058	0.0075	0.05	0.513	
			2062R		5.56	1.57	0.19	2.79	13.030	0.219	0.062	0.0075	0.11	0.513	
			2094R		5.56	2.39	0.19	2.79	13.030	0.219	0.094	0.0075	0.11	0.513	
			2125R		5.56	3.18	0.19	2.79	13.030	0.219	0.125	0.0075	0.11	0.513	
			3047R		8.74	1.19	0.19	1.91	22.709	0.344	0.047	0.0075	0.075	0.894	
			3062R	● ●	8.74	1.57	0.19	2.39	22.709	0.344	0.062	0.0075	0.094	0.894	
			3072R		8.74	1.83	0.19	2.39	22.709	0.344	0.072	0.0075	0.094	0.894	
			3078R	● ●	8.74	1.98	0.19	2.39	22.709	0.344	0.078	0.0075	0.094	0.894	
			3088R		8.74	2.24	0.19	2.39	22.709	0.344	0.088	0.0075	0.094	0.894	
			3094R		8.74	2.39	0.19	3.81	22.709	0.344	0.094	0.0075	0.15	0.894	
			3097R	● ●	8.74	2.46	0.32	3.81	22.709	0.344	0.097	0.0125	0.15	0.894	
			3105R		8.74	2.67	0.19	3.81	22.709	0.344	0.105	0.0075	0.15	0.894	
			3110R		8.74	2.79	0.32	3.81	22.709	0.344	0.110	0.0125	0.15	0.894	
			3122R		8.74	3.10	0.19	3.81	22.709	0.344	0.122	0.0075	0.15	0.894	
			3125R	● ●	8.74	3.18	0.19	3.81	22.709	0.344	0.125	0.0075	0.15	0.894	
			3142R		8.74	3.61	0.32	3.81	22.709	0.344	0.142	0.0125	0.15	0.894	
			3156R	● ●	8.74	3.96	0.19	3.81	22.709	0.344	0.156	0.0075	0.15	0.894	
			3178R		8.74	4.52	0.19	3.81	22.709	0.344	0.178	0.0075	0.15	0.894	
			3185R		8.74	4.70	0.57	3.81	22.709	0.344	0.185	0.0225	0.15	0.894	
			3189R	● ●	8.74	4.80	0.57	3.81	22.709	0.344	0.189	0.0225	0.15	0.894	
			4125R	● ●	11.51	3.18	0.19	3.81	28.663	0.453	0.125	0.0075	0.15	1.128	
4189R		11.51	4.80	0.57	6.35	28.663	0.453	0.189	0.0225	0.25	1.128				
4213R		11.51	5.41	0.19	6.35	28.663	0.453	0.213	0.0075	0.25	1.128				
4219R		11.51	5.56	0.57	6.35	28.663	0.453	0.219	0.0225	0.25	1.128				
4250R		11.51	6.35	0.57	6.35	28.663	0.453	0.250	0.0225	0.25	1.128				
Round C/B Ground		KNGP	2031R		5.56	0.79	0.09	1.27	13.030	0.219	0.031	0.0035	0.05	0.513	
			2062R		5.56	1.57	0.19	2.79	13.030	0.219	0.062	0.0075	0.11	0.513	
			2125R		5.56	3.18	0.19	2.79	13.030	0.219	0.125	0.0075	0.11	0.513	
			3088R		8.74	2.24	0.19	2.39	22.709	0.344	0.088	0.0075	0.094	0.894	
			3125R	● ●	8.74	3.18	0.19	3.81	22.709	0.344	0.125	0.0075	0.15	0.894	
			3156R	● ●	8.74	3.96	0.19	3.81	22.709	0.344	0.156	0.0075	0.15	0.894	
			3189R		8.74	4.80	0.57	3.81	22.709	0.344	0.189	0.0225	0.15	0.894	
			4189R		11.51	4.80	0.57	6.35	28.663	0.453	0.189	0.0225	0.25	1.128	
Round Flat Top		KNR	2031R		5.56	1.57	0.79	2.79	13.030	0.219	0.062	0.031	0.11	0.513	
			2047R		5.56	2.39	1.19	2.79	13.030	0.219	0.094	0.047	0.11	0.513	
			3031R	● ●	8.74	1.57	0.79	2.39	22.709	0.344	0.062	0.031	0.094	0.894	
			3047R	● ●	8.74	2.39	1.19	3.81	22.709	0.344	0.094	0.047	0.15	0.894	
			3062R	● ●	8.74	3.18	1.59	3.81	22.709	0.344	0.125	0.0625	0.15	0.894	
			3078R	● ●	8.74	3.96	1.98	3.81	22.709	0.344	0.156	0.078	0.15	0.894	
			3094R	● ●	8.74	4.78	2.39	3.81	22.709	0.344	0.188	0.094	0.15	0.894	
			4125R		11.51	6.35	3.18	6.35	28.663	0.453	0.250	0.125	0.25	1.128	
Round C/B Ground		KNRP	2031R		5.56	1.57	0.79	2.79	13.030	0.219	0.062	0.031	0.11	0.513	
			2047R		5.56	2.39	1.19	2.79	13.030	0.219	0.094	0.047	0.11	0.513	
			3031R	● ●	8.74	1.57	0.79	2.39	22.709	0.344	0.062	0.031	0.094	0.894	
			3047R	● ●	8.74	2.39	1.19	3.81	22.709	0.344	0.094	0.047	0.15	0.894	
			3062R	● ●	8.74	3.18	1.59	3.81	22.709	0.344	0.125	0.0625	0.15	0.894	
			3078R	● ●	8.74	3.96	1.98	3.81	22.709	0.344	0.156	0.078	0.15	0.894	
			3094R	● ●	8.74	4.78	2.39	3.81	22.709	0.344	0.188	0.094	0.15	0.894	
			4125R		11.51	6.35	3.18	6.35	28.663	0.453	0.250	0.125	0.25	1.128	

● : Stock item



KNSR

For grooving, profil machining

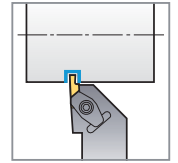
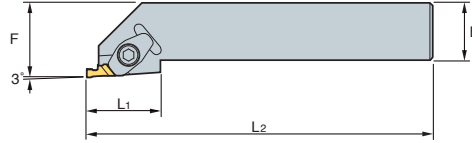
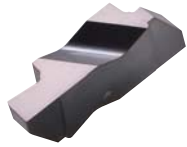

R type insert

KNG KNGP KNT
KNR KNRP KNB

Designation	mm					inch					Insert	Clamp	Screw	Wrench	
	H	B	F	L1	L2	H	B	F	L1	L2					
KNSR	1010E2	10	10	14	19	70	0.394	0.394	0.551	0.748	2.756	KNG2□ KNGP2□ KNR2□ KNB2R KNT2R	CM74	MHB3010	HW25L
	1212F2	12	12	16	19	80	0.472	0.472	0.630	0.748	3.150				
	1616H2	16	16	20	19	100	0.630	0.630	0.787	0.748	3.937				
	2020K2	20	20	25	19	125	0.787	0.787	0.984	0.748	4.921				
	2525M2	25	25	32	19	150	0.984	0.984	1.260	0.748	5.906				
	2020K3	20	20	25	32	125	0.787	0.787	0.984	1.260	4.921	KNG3□ KNGP3□ KNR3□ KNRP3□ KNB3R KNT3R	CM72LP	MHA0512	HW40L
	2525M3	25	25	32	32	150	0.984	0.984	1.260	1.260	5.906				
	3225P3	32	32	32	32	170	1.260	1.260	1.260	1.260	6.693				
	3232P3	32	32	40	32	170	1.260	1.260	1.575	1.260	6.693				
	2525M4	25	25	32	35	150	0.984	0.984	1.260	1.378	5.906	KNG4□ KNGP4□ KNR4□ KNB4R KNT4R	CM72LP	MHA0512	HW40L
3225P4	32	32	32	35	170	1.260	1.260	1.260	1.378	6.693					
3232P4	32	32	40	35	170	1.260	1.260	1.575	1.378	6.693					

For deep hole grooving/parting off

Saw Man

Features of parting insert

- Possible to machine a wide range of workpieces such as steel, cast iron, stainless steel, etc.
- Extended tool life due to low resistance rake angle
- Minimized burr due to minimal Nose R
- Various lead angle available
- Narrow chip curl due to dots on rake surface of insert

Workpiece	Cutting Speed (vc = m/min)									Feed (fn = mm/rev)					
	CVD				PVD				Uncoateds	Cutting width (mm)					
	NC3120	NC3030	NCM325	NC5330	PC230	PC8110	PC5300	PC6510	ST30A	2	3	4	5	6	
SM□□C	80~180			80~180	80~180						0.02~0.15	0.03~0.20	0.08~0.30	0.10~0.4	0.12~0.50
SCM	70~150	70~150	70~150	70~150	70~150						0.02~0.15	0.03~0.20	0.08~0.30	0.10~0.4	0.12~0.50
GC/GCD				50~100				50~100	50~100		0.05~0.12	0.10~0.25	0.10~0.30	0.10~0.35	0.10~0.40
STS			50~120	50~120		50~120	60~140				0.02~0.10	0.03~0.15	0.08~0.25	0.10~0.35	0.12~0.40
Non-ferrous metal (Al, Copper)									200~450		0.05~0.10	0.05~0.20	0.05~0.25	0.05~0.30	0.05~0.35

Insert

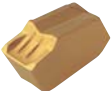
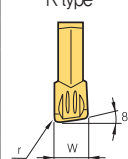
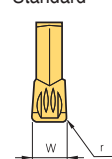
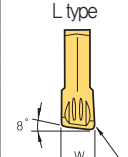
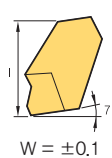
Application	Picture	Designation	Coated										Uncoated	Dimensions (mm)			Configuration
			NC3120	NC3225	NC3030	NCM325	NC5330	PC3035	PC8105	PC8110	PC5300	PC9030	ST30A	W	l	r	
Parting tools		SP 160												1.6	7.8	0.16	   
		180												1.8	9.3	0.16	
		200		●	●	●	●			●	●	●		2.2	9.3	0.2	
		200R			●							●		2.2	9.3	0.2	
		200L										●		2.2	9.3	0.2	
		300		●	●	●	●	●		●	●	●	●	3.1	11.3	0.2	
		300R			●	●	●			●				3.1	11.3	0.2	
		300L				●								3.1	11.3	0.2	
		400		●	●	●	●	●		●	●	●		4.1	11.3	0.25	
		400R				●				●				4.1	11.3	0.25	
		400L				●								4.1	11.3	0.25	
		500				●	●	●		●	●			5.1	11.4	0.3	
		500R												5.1	11.4	0.3	
		500L												5.1	11.4	0.3	
		600				●		●				●		6.4	11.4	0.35	
		600R												6.4	11.4	0.35	
		600L												6.4	11.4	0.35	
800												8.0	14.06	0.4			
900												9.6	14.06	0.45			

● : Stock item



SPB/SPB-S (Blades)



SP

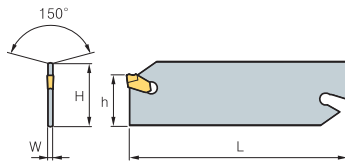

Fig. 1

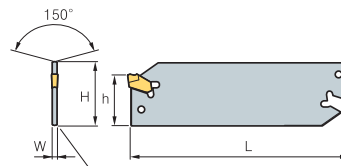
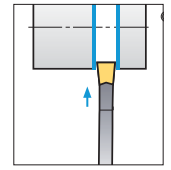





Fig. 2



(mm)

Designation	H	W	L	h	Inserts	Wrench		Fig.	
									
SPB	226	26	1.6	110	21	SP200, 200R/L	SW50L	-	1
	232	32	1.6	150	25	SP200, 200R/L			
	326	26	2.4	110	21	SP300, 300R/L			
	332	32	2.4	150	25	SP300, 300R/L			
	426	26	3.2	110	21	SP400, 400R/L			
	432	32	3.2	150	25	SP400, 400R/L			
	526	26	4.0	110	21	SP500, 500R/L			
	532	32	4.0	150	25	SP500, 500R/L			
	626	26	5.2	110	21	SP600, 600R/L			
	632	32	5.2	150	25	SP600, 600R/L			
SPB-S	226-S	26	1.6	110	21	SP200, 200R/L	-	SW15S (Separately ordered)	2
	232-S	32	1.6	150	25	SP200, 200R/L			
	326-S	26	2.4	110	21	SP300, 300R/L			
	332-S	32	2.4	150	25	SP300, 300R/L			
	426-S	26	3.2	110	21	SP400, 400R/L			
	432-S	32	3.2	150	25	SP400, 400R/L			
	526-S	26	4.0	110	21	SP500, 500R/L			
	532-S	32	4.0	150	25	SP500, 500R/L			
	626-S	26	5.2	110	21	SP600, 600R/L			
	632-S	32	5.2	150	25	SP600, 600R/L			
	832-S	32	6.8	150	25	SP800			
	932-S	32	8	150	25	SP900			
	8526-S	52.6	6.8	150	45	SP800			
	9526-S	52.6	8	150	45	SP900			

 Applicable inserts C59

SMBB (Block)



SPB□□□(-S)
KGTB□□□32

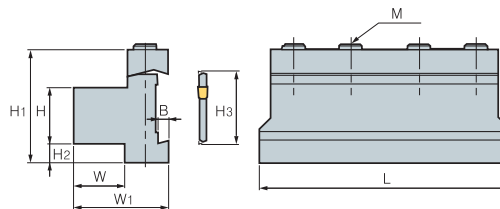

(mm)

Designation	H	W	H3	L	H1	H2	W1	B	M	Blades	Wrench
											
SMBB	1626	16	12	26	86	43	13	30	5.3	3-M6	HW50L
	2026	20	19	26	86	43	9	38	5.3	3-M6	
	2032	20	19	32	100	50	13	38	5.3	4-M6	
	2526	25	23	26	86	43	4	42	5.3	4-M6	
	2532	25	23	32	110	50	8	42	5.3	4-M6	
	3232	32	30	32	110	54	5	48	5.3	4-M6	
	40526	40	41	52.6	130	81.73	22	66	8	4-M8	

 Applicable inserts C59



SPH/SPH-S (Holder)

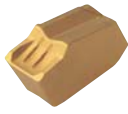

SP

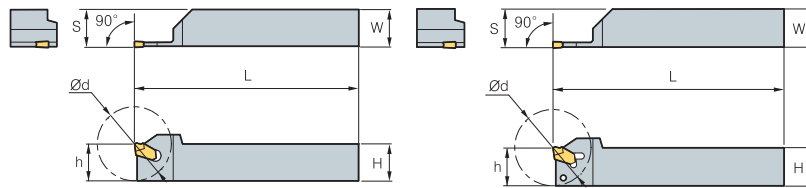
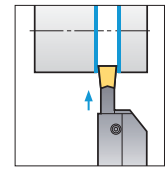





Fig. 1

Fig. 2



• R type insert
(mm)

Designation	H = (h)	W	L	Ød	S	Inserts	Wrench		Fig.	
										
SPH	316R/L	16	16	100	32	16.3	SP300, 300R/L	SW50L	-	1
	320R/L	20	20	120	40	20.3	SP300, 300R/L			
	325R/L	25	25	150	50	25.3				
	420R/L	20	20	120	50	20.4	SP400, 400R/L			
	425R/L	25	25	150	60	25.4	SP500, 500R/L			
	520R/L	20	20	120	60	20.5	SP300, 300R/L			
	525R/L	25	25	150	70	25.5	SP500, 500R/L			
SPH	316R/L-S	16	16	100	32	16.3	SP300, 300R/L	-	SW15S (Separately ordered)	2
	320R/L-S	20	20	120	40	20.3	SP300, 300R/L			
	325R/L-S	25	25	150	50	25.3	SP300, 300R/L			
	420R/L-S	20	20	120	50	20.4	SP400, 400R/L			
	425R/L-S	25	25	150	60	25.4	SP400, 400R/L			
	520R/L-S	20	20	120	60	20.5	SP500, 500R/L			
	525R/L-S	25	25	150	70	25.5	SP500, 500R/L			

 Applicable inserts C59

C Technical Information for Saw Man-X

A solution for parting and deep grooving

Saw Man-X

- Stable machining in deep grooving applying clamping system with strong three-way V-Rail
- Improved clamping precision and convenient replacing of inserts with using the exclusive wrench

Holder (Blade) Code system

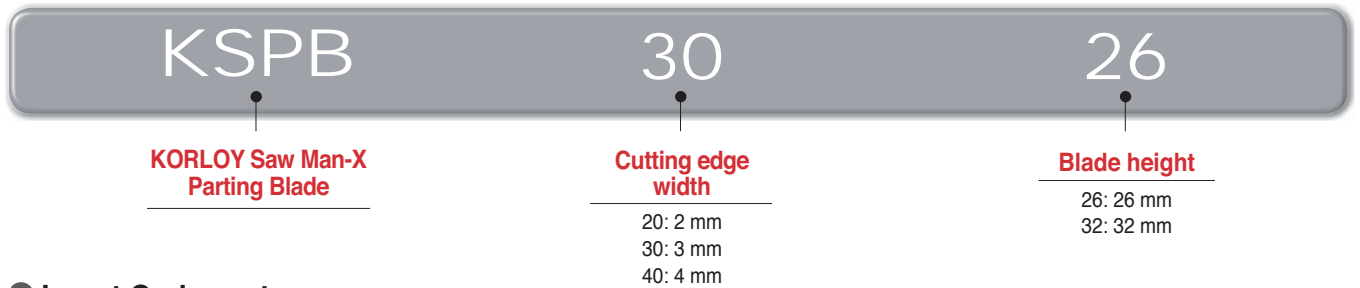

Insert Code system

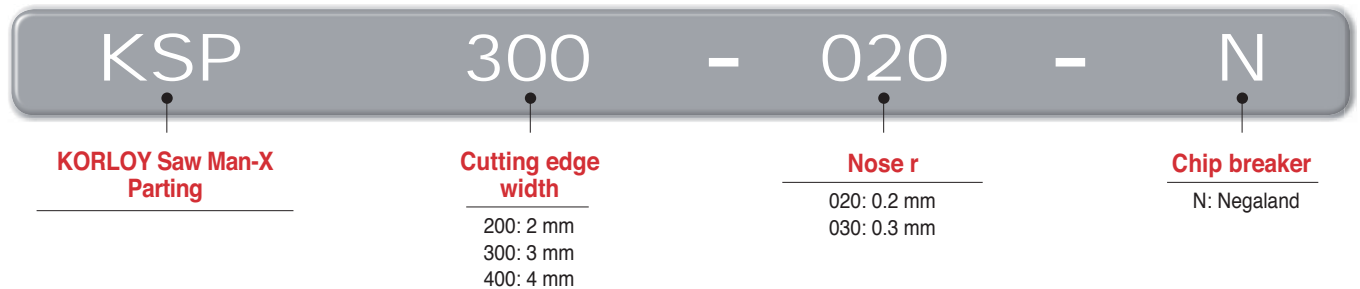

Features

- Three-way V-Rail – More stable clamping system
- New treatment on cutting edge – Better quality of machining and longer tool life
- Superior chip breaker – Better chip control
- Exclusive wrench – More convenient clamping system

Three-way V-RAIL

- An insert is tightly clamped in the tip seat.
- Minimized vibration during the machining increases stability.
- Stable high speed, high feed and high depth of cut machining is available.

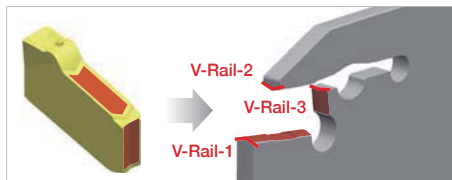

Exclusive wrench

- The exclusive wrench having the principle of CAM for the Saw Man-X
- More convenient clamping system

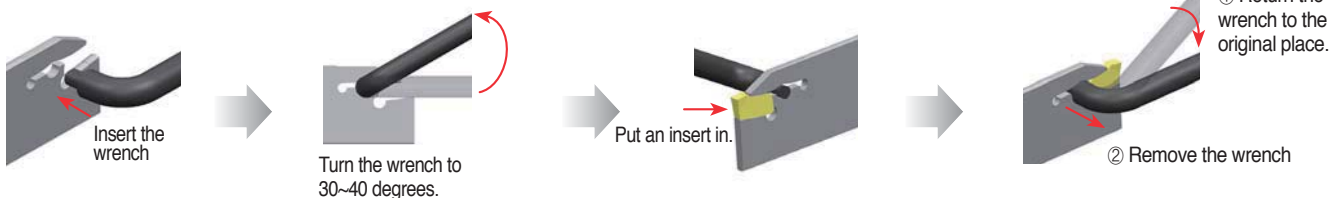

Features of chip breaker

- The design of chip breaker and its bump in the back area realize better chip evacuation
- The chip breaker with negaland is used universally.

Coolant path and guide for chip evacuation

- Inner coolant holder is available
- Guide for chip evacuation

Negaland

- Applying for various workpieces
- Stable in interrupted cutting and machining with high depth of cut

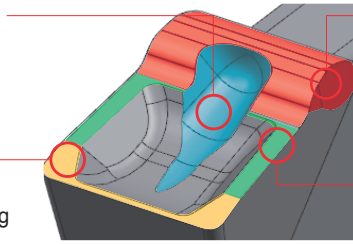

The second chip breaker in the back area

- Better chip control in machining of workpiece with a bigger diameter
- Preventing damage to holder from chip evacuation

Strong land on flank

- Smaller diameter of chip curl makes better chip control
- Higher rigidity of insert

Recommended cutting conditions

Workpiece					Grade	Cutting conditions	
ISO	Workpiece	KS	AISI	ISO (DIN)*		vc (m/min)	fn (mm/rev)
P	Carbon steel	SM45C	1045	C45ww	PC5300	80-200	0.08-0.28
					PC3035	80-220	0.08-0.28
	Alloy steel	SCM440	4140	42CrMo4 (42CrMo4)*	PC5300	80-160	0.08-0.25
					PC3035	80-180	0.08-0.25
M	Stainless steel	STS304	304	X5CrNi18-9 (X2CrNi19-11)*	PC5300	80-190	0.06-0.20
		STS316	316	X5CrNiMo17-12-2	PC5300	80-190	0.06-0.20
K	Gray cast iron	GC250	No35B	250 (GG25)*	PC8110	100-220	0.10-0.28
					PC5300	100-200	0.10-0.28
	Nodular graphite cast iron	GCD500	80-55-06	450-10	PC8110	80-200	0.10-0.25
S	HRSA	Inconel 718	7718	15156-3	PC8110	35-65	0.05-0.15
					PC5300	25-55	0.05-0.15

Cutting edge width and T-MAX by items

◎: First recommendation ○: Second recommendation

Shape	Cutting edge width (mm)	T-MAX (mm)					No. of corner	Machining				Features
		2	4	6	8	130		External diameter	Internal diameter	Cross section	Parting	
Saw Man-X new	2	5	10	20	30	130	1	○			◎	• Self clamping • Deep grooving
MGT, KGT	1.5	5	10	20	30	130	2	◎	○	○	○	• Various machining • Wide range of machining
TB	1.25	5	10	20	30	130	3	◎			○	• Precise ground class • Optimally automatic machining
Auto tools	Blade type	0.7	2.0	6.0	8.3	130	2	◎			○	• For swiss-type lathe (blade) • Small deliberate component machining
	Multi-functional type	1.0	4.0	6.0	8.5	130	2	◎			○	• For swiss-type lathe (multifunctional) • Small deliberate component machining
K Notch	0.75	5	10	20	6.3	130	2	◎				• Strong clamping system • Highly qualified cutting edge

Insert

(mm)

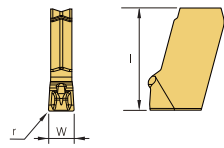
Application	Picture	Designation	Coated			W	r	L	Configuration
			PC3035	PC5300	PC8110				
Parting		KSP 200-020-N	●	●	●	2.0	0.20	11.0	
		300-020-N	●	●	●	3.0	0.20	12.0	
		400-025-N	●	●	●	4.0	0.25	12.5	
		500-025-N				5.0	0.25	13.5	
		600-035-N				6.0	0.35	14.5	

●: Stock item

KSPB (Blade) new



KSP

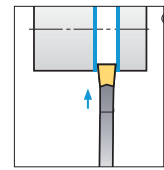
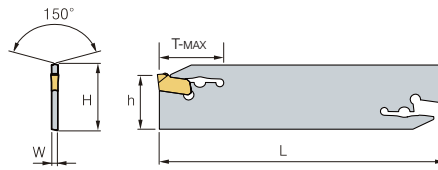

(mm)

Designation		Cutting edge width	H	W	L	h	T-MAX	Wrench
KSPB	2026	2mm	26	1.6	110	21	25	 CW08
	2032	2mm	32	1.6	150	25	26	
	3026	3mm	26	2.4	110	21	36	
	3032	3mm	32	2.4	150	25	60	
	4026	4mm	26	3.2	110	21	36	
	4032	4mm	32	3.2	150	25	60	
	5026	5mm	26	4.0	110	21	40	
	5032	5mm	32	4.0	150	25	60	
	6026	6mm	26	5.2	110	21	60	
	6032	6mm	32	5.2	150	25	60	

 Applicable inserts **C63**

SMBB (Block)

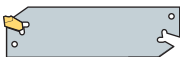

KSPB□□□□
 SPB□□□(-S)
 KGTB□□□□

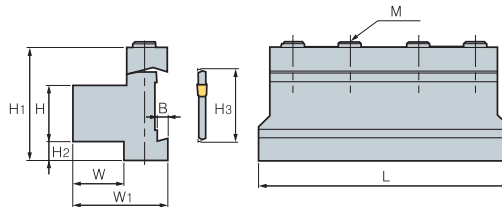

(mm)

Designation		H	W	H3	L	H1	H2	W	B	M	Wrench
SMBB	1626	16	12	26	86	43	13	30	5.3	3-M6	 HW50L
	2026	20	19	26	86	43	9	38	5.3	3-M6	
	2032	20	19	32	100	50	13	38	5.3	4-M6	
	2526	25	23	26	86	43	4	42	5.3	4-M6	
	2532	25	23	32	110	50	8	42	5.3	4-M6	
	3232	32	30	32	110	54	5	48	5.3	4-M6	

 Applicable inserts **C63**

Six kinds of inserts can be used in one holder for various operations

Fine Tools

- Strong clamping system and specially designed insert are suitable for small diameter machining
- Six kinds of inserts can be clamped in one holder for various operations
- Guaranteed long tool life due to good toughness substrate with new TiAlN
- High accuracy ground insert ensures high precision machining



➤ **Application range** • Internal grooving, Profiling, Threading and Boring at Ø8 mm~Ø16 mm

➤ **Features**

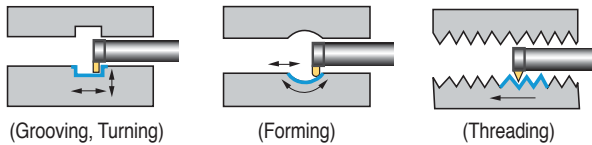

➤ **Code system**

NFTIH 08 3 12 - S

Minimum Diameter Overhang (ℓ/ØD) Shank Dia. Shank Type

S: Steel, C: Carbide

➤ **Recommended cutting condition**

Workpiece	Grade	Cutting Condition				
		Min. machining Dia. (ØDmin)				
			Ø8	Ø11	Ø14	Ø16
Carbon steel	◎	vc(m/min)	30~80	30~100	30~100	30~100
		fn(mm/rev)	0.01~0.04	0.01~0.05	0.02~0.05	0.02~0.06
Alloy steel	◎	vc(m/min)	30~80	30~100	30~100	30~100
		fn(mm/rev)	0.01~0.02	0.01~0.04	0.02~0.04	0.02~0.05
Cast iron	○	vc(m/min)	30~80	30~100	30~100	30~100
		fn(mm/rev)	0.01~0.05	0.01~0.05	0.02~0.05	0.02~0.05
Non-ferrous alloy	○	vc(m/min)	70~150	100~150	100~150	100~150
		fn(mm/rev)	0.02~0.06	0.02~0.06	0.02~0.06	0.02~0.06

- Note**
- In case of chattering, reduce the cutting speed and feed
 - To find the optimal cutting conditions, advise to gradually increase from the lowest cutting condition of the above recommendation
 - In case of the unilateral grooving depth over 1 mm, work to the step feed rate

➤ **Clamping system**

Screw

Insert

R Type

L Type

Grooving

L Type Forming insert"/>

Forming

L Type Threading insert"/>

Threading

Holder

Shank (Cemented carbide or Steel)

Overhang (3D, 4D, 5D)

• Available R/L type insert with one holder

Stable clamping according to the tripod structure



R Type

L Type

No-Spin-System design for strong clamping

C Available Insert for Fine Tools

Insert

Application	Picture	Designation	Coated		Dimensions (mm)								Configuration	
			PC5300		ØD	b	r	S	g	Ød ₂	t	Pitch		f
			R	L										
Grooving		NFTG 08075R/L	●		8	0.75	-	7.75	1.3	5.9	3.85	-	-	
		08085R/L	●		8	0.85	-	7.75	1.3	5.9	3.85	-	-	
		08095R/L	●		8	0.95	-	7.75	1.3	5.9	3.85	-	-	
		08121R/L	●		8	1.21	-	7.75	1.3	5.9	3.85	-	-	
		08141R/L	●		8	1.41	-	7.75	1.3	5.9	3.85	-	-	
		08152R/L	●		8	1.52	-	7.75	1.3	5.9	3.85	-	-	
		08171R/L	●		8	1.71	-	7.75	1.3	5.9	3.85	-	-	
		08202R/L	●		8	2.02	-	7.75	1.3	5.9	3.85	-	-	
		11075R/L	●		11	0.75	-	10.7	1.8	8.0	4.9	-	-	
		11085R/L	●		11	0.85	-	10.7	1.8	8.0	4.9	-	-	
		11095R/L	●		11	0.95	-	10.7	1.8	8.0	4.9	-	-	
		11121R/L	●		11	1.21	-	10.7	2.6	8.0	4.9	-	-	
		11141R/L	●		11	1.41	-	10.7	2.6	8.0	4.9	-	-	
		11152 R/L	●		11	1.52	-	10.7	2.6	8.0	4.9	-	-	
		11171R/L	●		11	1.71	-	10.7	2.6	8.0	4.9	-	-	
		11202R/L	●		11	2.02	-	10.7	2.6	8.0	4.9	-	-	
		11202R/L-02	●		11	2.02	0.2	10.7	2.6	8.0	4.9	-	-	
		11252R/L	●		11	2.52	-	10.7	2.6	8.0	4.9	-	-	
		11302R/L	●		11	3.02	-	10.7	2.6	8.0	4.9	-	-	
		14075R/L	●		14	0.75	-	13.5	1.8	9.0	5.85	-	-	
		14085R/L	●		14	0.85	-	13.5	1.8	9.0	5.85	-	-	
		14095R/L	●		14	0.95	-	13.5	1.8	9.0	5.85	-	-	
		14121R/L	●		14	1.21	-	13.5	4.3	9.0	5.85	-	-	
		14141R/L	●		14	1.41	-	13.5	4.3	9.0	5.85	-	-	
		14152R/L	●		14	1.52	-	13.5	4.3	9.0	5.85	-	-	
		14171R/L	●		14	1.71	-	13.5	4.3	9.0	5.85	-	-	
		14202R/L	●		14	2.02	-	13.5	4.3	9.0	5.85	-	-	
		14252R/L	●		14	2.52	-	13.5	4.3	9.0	5.85	-	-	
		14302R/L	●		14	3.02	-	13.5	4.3	9.0	5.85	-	-	
		16075R/L	●		16	0.75	-	15.7	1.8	11	5.8	-	-	
		16085R/L	●		16	0.85	-	15.7	1.8	11	5.8	-	-	
		16095R/L	●		16	0.95	-	15.7	1.8	11	5.8	-	-	
		16121R/L	●		16	1.21	-	15.7	4.6	11	5.8	-	-	
		16141R/L	●		16	1.41	-	15.7	4.6	11	5.8	-	-	
		16171R/L	●		16	1.71	-	15.7	4.6	11	5.8	-	-	
		16202R/L	●		16	2.02	-	15.7	4.6	11	5.8	-	-	
16252R/L	●		16	2.52	-	15.7	4.6	11	5.8	-	-			
16302R/L	●		16	3.02	-	15.7	4.6	11	5.8	-	-			
16352R/L	●		16	3.52	-	15.7	4.6	11	5.8	-	-			
16402R/L	●		16	4.02	-	15.7	4.6	11	5.8	-	-			
Threading		NFTT 0805MR/L	●		8	-	-	7.75	-	6	3.85	0.5	1.0	
		0810MR/L	●		8	-	-	7.75	-	6	3.85	1.0	1.0	
		0815MR/L	●		8	-	-	7.75	-	6	3.85	1.5	1.2	
		1110MR/L	●		11	-	-	10.7	-	8	4.9	1.0	1.2	
		1115MR/L	●		11	-	-	10.7	-	8	4.9	1.5	1.2	
		1120MR/L	●		11	-	-	10.7	-	8	4.9	2.0	1.2	
		1125MR/L	●		11	-	-	10.7	-	8	4.9	2.5	1.2	
		1410MR/L	●		14	-	-	13.5	-	9	5.85	1.0	1.2	
		1415MR/L	●		14	-	-	13.5	-	9	5.85	1.5	1.2	
		1420MR/L	●		14	-	-	13.5	-	9	5.85	2.0	1.2	
		1425MR/L	●		14	-	-	13.5	-	9	5.85	2.5	1.2	
		1610MR/L	●		16	-	-	15.7	-	11	5.8	1.0	1.2	
		1615MR/L	●		16	-	-	15.7	-	11	5.8	1.5	1.2	
		1620MR/L	●		16	-	-	15.7	-	11	5.8	2.0	1.2	
		1625MR/L	●		16	-	-	15.7	-	11	5.8	2.5	1.2	
		1630MR/L	●		16	-	-	15.7	-	11	5.8	3.0	1.5	
		1635MR/L	●		16	-	-	15.7	-	11	5.8	3.5	1.6	
1640MR/L	●		16	-	-	15.7	-	11	5.8	4.0	1.8			

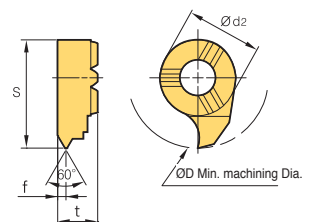
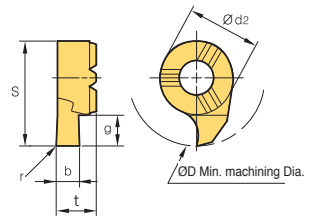

● : Stock item



C

Multi functional Tools

Insert

Application	Picture	Designation	Coated		Dimensions (mm)							Configuration
			PC5300		D	b	r	S	g	Ød ₂	t	
			R	L								
Profiling		NFTF 08082R/L	●		8	0.82	0.41	7.75	1.3	5.9	3.85	
		08122R/L	●		8	1.22	0.61	7.75	1.3	5.9	3.85	
		08182R/L	●		8	1.82	0.91	7.75	1.3	5.9	3.85	
		11082R/L	●		11	0.82	0.41	10.7	2.6	8	4.9	
		11122R/L	●		11	1.22	0.61	10.7	2.6	8	4.9	
		11182R/L	●		11	1.82	0.91	10.7	2.6	8	4.9	
		11202R/L	●		11	2.02	1.01	10.7	2.6	8	4.9	
		11302R/L	●		11	3.02	1.51	10.7	2.6	8	4.9	
		14122R/L	●		14	1.22	0.61	13.5	4.3	9	5.85	
		14182R/L	●		14	1.82	0.91	13.5	4.3	9	5.85	
		14202R/L	●		14	2.02	1.01	13.5	4.3	9	5.85	
		14222R/L	●		14	2.22	1.11	13.5	4.3	9	5.85	
		14302R/L	●		14	3.02	1.51	13.5	4.3	9	5.85	
		16182R/L	●		16	1.82	0.91	15.7	4.6	11	5.8	
		16222R/L	●		16	2.22	1.11	15.7	4.6	11	5.8	
		16302R/L	●		16	3.02	1.51	15.7	4.6	11	5.8	
		16402R/L	●		16	4.02	2.01	15.7	4.6	11	5.8	

● : Stock item

NFTIH



NFTF
NFTT
NFTG

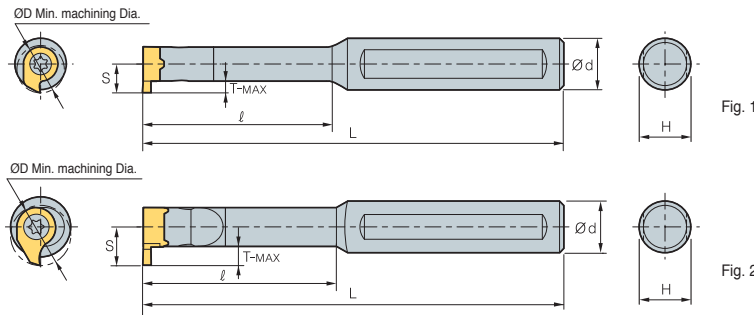

• For NFTIH14~.
• R type insert

(mm)

Designation	ØD	Ød	L	ℓ	T-MAX	H	S	Inserts		Screw	Screw	Fig.
								NFTG: Grooving	NFTT: Threading			
NFTIH 08206C	8	6	65	-	1.0	4	4.8			PTKA02508	TW08P	1
08212C	8	12	70	16	1.0	10	4.8	NFTG08□□□R/L				
08312C	8	12	80	24	1.0	10	4.8	NFTT08□□□R/L				
08312S	8	12	80	24	1.0	10	4.8	NFTF08□□□R/L				
08412C	8	12	90	32	1.0	10	4.8					
08512C	8	12	100	40	1.0	10	4.8					
NFTIH 11208C	11	8	80	-	2.3	7	6.7			PTKA03510	TW15P	2
11212C	11	12	75	22	2.3	11	6.7	NFTG11□□□R/L				
11312C	11	12	95	33	2.3	11	6.7	NFTT11□□□R/L				
11312S	11	12	95	33	2.3	11	6.7	NFTF11□□□R/L				
11412C	11	12	110	44	2.3	11	6.7					
11512C	11	12	120	55	2.3	11	6.7					
NFTIH 14012C	14	12	75	20	4.0	11	9.0			PTKA0412	TW15P	2
14016C	14	16	75	20	4.0	15	9.0	NFTG14□□□R/L				
14112C	14	12	100	34	4.0	11	9.0	NFTT14□□□R/L				
14116C	14	16	100	34	4.0	15	9.0	NFTF14□□□R/L				
14212C	14	12	110	45	4.0	11	9.0					
14216C	14	16	110	45	4.0	15	9.0					
NFTIH 16312C	16	12	130	64	4.0	11	9.0			PTKA0512	TW20P	2
16312S	16	12	130	48	4.3	11	10.2	NFTG16□□□R/L				
16412C	16	12	130	64	4.3	11	10.2	NFTT16□□□R/L				
16512C	16	12	150	80	4.3	11	10.2	NFTF16□□□R/L				
16316C	16	16	130	48	4.3	15	10.2					
16416C	16	16	130	64	4.3	15	10.2					
16516C	16	16	150	80	4.3	15	10.2					

↻ Applicable inserts C66 ~ C67



C Grooving Tools

IGH For internal grooving



IG

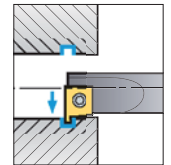
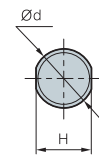
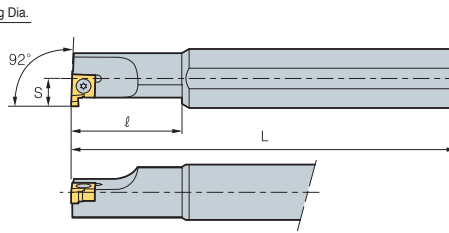
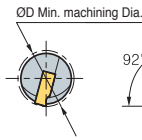

• R type insert
(mm)

Designation	ØD	Ød	H	L	ℓ	S	Inserts	Screw	Wrench
IGH	214R/L	14	16	15	150	25	IG125~280	FTKA02565	TW07P
	216R/L	16	16	15	150	30			
	220R/L	20	20	18	200	40			

➤ Applicable inserts C68

➤ Insert

Application	Picture	Designation	Coated			Uncoated			Dimensions (mm)					Configuration	
			NC3215	NC3120	NC3225	H01	G10	ST30A	b	g	t	d	d ₁		
Internal grooving		IG	125					●	1.25	1.5	3.18	6.35	2.8		
			145					●	1.45	1.5	3.18	6.35	2.8		
			175						●	1.75	1.5	3.18	6.35		2.8
			200						●	2.0	2.3	3.18	6.35		2.8
			230						●	2.3	2.3	3.18	6.35		2.8
			280						●	2.8	2.3	3.18	6.35		2.8

● : Stock item

DBH For deep and wide grooving



DB DC

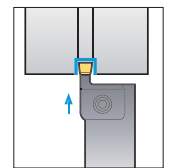
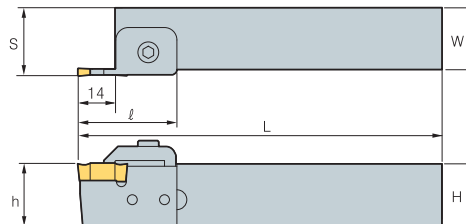

• R type insert
(mm)

Designation	H = (h)	W	L	ℓ	S		Inserts		Clamp	Clamp Screw	Screw	Locator	Wrench	
					*	**	*	**						
DBH	320R/L	20	20	150	40	22.3	22.8	DB300	DB400	CGH5R1	MHA0512	MHB0410	LD34	HW30L HW40L
	325R/L	25	25	150	40	27.3	27.8	DC300	DC400					
	520R/L	20	20	150	40	23.8	24.3	DB500	DB600					
	525R/L	25	25	150	40	28.8	29.3	DC500						
	720R/L	20	20	150	40	25.8	26.3							
	725R/L	25	25	150	40	30.8	31.3	DB700	DB800					

➤ Applicable inserts C68

➤ Insert

Application	Picture	Designation	Cermet	Coated			Uncoated		Dimensions (mm)				Configuration
			CN2000	NC3215	NC3120	NC3225	H01	G10	b	l	t	r	
Grooving		DB	300						3.0	20	7.5	0.2	
			400						4.0	20	7.5	0.2	
			500						5.0	20	7.5	0.2	
			600						6.0	20	7.5	0.2	
			700						7.0	20	7.5	0.2	
		DC	800						8.0	20	7.5	0.2	
			300						3.0	20	7.5	0.2	
			400						4.0	20	7.5	0.25	
			500						5.0	20	7.5	0.3	

● : Stock item



C

Multi functional Tools

GFT For External grooving



GW BF

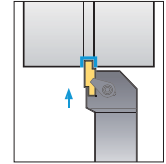
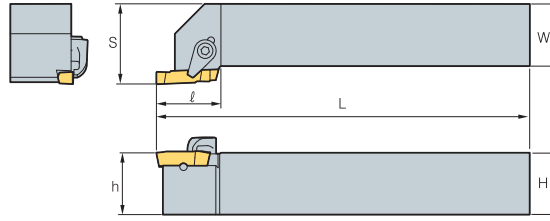

• R type insert

Designation	H = (h)	W	L	l	S	Inserts	Clamp	Screw	Pin	Wrench						
GFT	320R/L	20	20	125	23.5	25	GW110~300R/L,BF3	CS5R1	DHA0514	PN0310	HW25L					
	325R/L	25	25	150	23.5	32										
	525R/L	25	25	150	25.5	32						GW315~500R/L,BF5	CS6R1	DHA0617	PN0310	HW30L
	825R/L	25	25	150	28.5	32						GW600~800R/L,BF8	CS8R1	DHA0820	PN0314	HW40L

➔ Applicable inserts C69 • Use right-hand insert for left-hand holder

GFIP For Internal grooving



BF GW

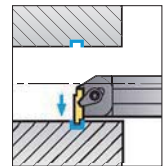
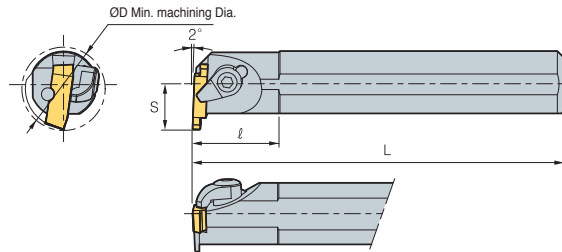

• R type insert

Designation	ØD	Ød	H	L	l	S	Inserts	Clamp	C-ring	Screw	Pin	Wrench	
GFIP	316R/L	20	16	15	150	17	GW110~300R/L,BF3	CH5R2	CR04	CHX0513	PN0310	HW25L	
	320R/L	26	20	18	150	22							
	325R/L	32	25	23	200	22							17
	340R/L	50	40	37	300	32	27	GW315~500R/L,BF5	CH6R2	CR05	CHX0616	PN0310	HW30L
	525R/L	32	25	23	200	22	17						
	540R/L	50	40	37	300	32	27						
	840R/L	50	40	37	300	32	27						

➔ Applicable inserts C69 • Use right-hand insert for left-hand holder

Insert

Application	Picture	Designation	Uncoated		Dimensions (mm)						Configuration	
			ST30A		b	g	W	l	t	r		
Blank		BF	-3	●			3.1	16.4	5.26	-		
			-5			5.1	22.4	6.26	-			
			-8			8.1	27.4	7.26	-			
Grooving		GW	110R/L	●	●	1.1	2.1	3.1	16	5.0	0.2	
			130R/L	●	●	1.3	2.3	3.1	16	5.0	0.2	
			160R/L	●	●	1.6	2.6	3.1	16	5.0	0.2	
			185R/L	●	●	1.85	2.9	3.1	16	5.0	0.2	
			215R/L	●	●	2.15	3.2	3.1	16	5.0	0.2	
			265R/L	●	●	2.65	3.7	3.1	16	5.0	0.2	
			300R/L	●	●	3.0	4.0	3.1	16	5.0	0.2	
			315R/L	●	●	3.15	4.2	5.1	22	6.0	0.3	
			415R/L		●	4.15	5.2	5.1	22	6.0	0.3	
			500R/L			5.0	6.0	5.1	22	6.0	0.3	
			600R/L			6.0	7.0	8.1	27	7.0	0.3	
			800R/L			8.0	9.0	8.1	27	7.0	0.3	

● : Stock item



C Grooving Tools

GH For O-ring grooving Snap-ring grooving



GO GS

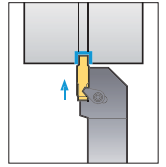
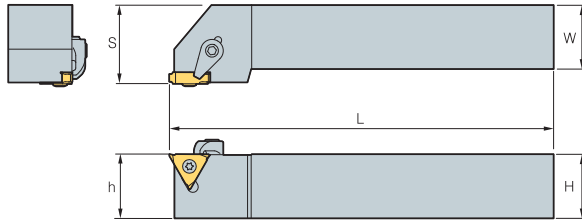

• R type insert

(mm)

Designation	H = (h)	W	L	S	Inserts	Clamp	Clamp Screw	Screw	Wrench	
GH	2020R/L-3	20	20	125	22	GS125~280	CS6R1	DHA0617	PTMA03508	TW09P-HW30L
	2525R/L-3	25	25	150	27	GO250				
	2020R/L-4	20	20	125	21	GS330 / 430				
	2525R/L-4	25	25	150	26	GO320 / 410				

Insert

➔ Applicable inserts C70

Application	Picture	Designation	Coated			Uncoated			Dimensions (mm)					Configuration
			NC3120	NC3225		H01	ST20	ST30A	b	g	W	r	d	
Grooving(Narrow · O-ring · Snap-ring)		GO 250						2.5	1.5	3.3	0.35	9.525		
		320						3.2	2.0	3.8	0.35	9.525		
		410						4.1	2.5	4.5	0.65	9.525		
		GS 125					●	1.23	1.5	2.5	0.2	9.525		
		145					●	1.43	1.5	2.5	0.2	9.525		
		175					●	1.73	2.0	2.5	0.2	9.525		
		185						1.83	2.0	2.5	0.2	9.525		
		200					●	2.03	2.5	2.5	0.2	9.525		
		230					●	2.28	3.5	2.8	0.2	9.525		
		280						2.78	3.5	3.3	0.3	9.525		
330						3.28	4.0	3.8	0.3	9.525				
430						4.28	4.0	4.5	0.4	9.525				

● : Stock item

GFIK For Relieving



GR

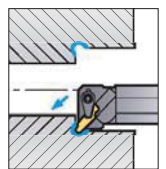
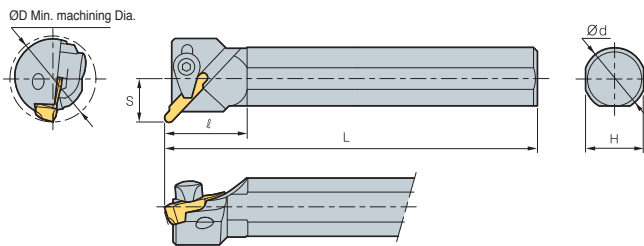

• R type insert

(mm)

Designation	ØD	Ød	H	L	l	S	Inserts	Clamp	C-ring	Screw	Pin	Wrench	
GFIK	316R/L	22	16	15	150	21.5	11	GR3□□	CH5R2	CR04	CHX0513	PN0310	HW25L
	325R/L	32	25	23	200	21.5	17		CS5R1	-	DHA0514	PN0310	HW25L
	340R/L	50	40	37	300	35.4	27	GR5□□	CS6R1	-	DHA0617	PN0314	HW30L
	525R/L	32	25	23	200	27.5	17		GR8□□	-	DHA0820	PN0314	HW40L
	540R/L	50	40	37	300	39.5	27						
	840R/L	50	40	37	300	41.8	27						

Insert

➔ Applicable inserts C70

Application	Picture	Designation	Coated			Uncoated			Dimensions (mm)					Configuration
			NC3120	NC3225		H01	ST20	ST30A	b	g	W	l	t	
Relieving		GR 310R						2.0	2.0	3.1	15.9	5.0	1.0	
		315R						3.0	2.9	3.1	15.9	5.0	1.5	
		520R						4.0	4.0	5.1	21.9	6.0	2.0	
		525R						5.0	5.0	5.1	21.8	6.0	2.5	
		830R						6.0	6.0	8.1	26.8	7.0	3.0	
		840R						8.0	8.0	8.1	26.7	7.0	4.0	

● : Stock item



C

Multi functional Tools

EH Regrinding type insert



ESB

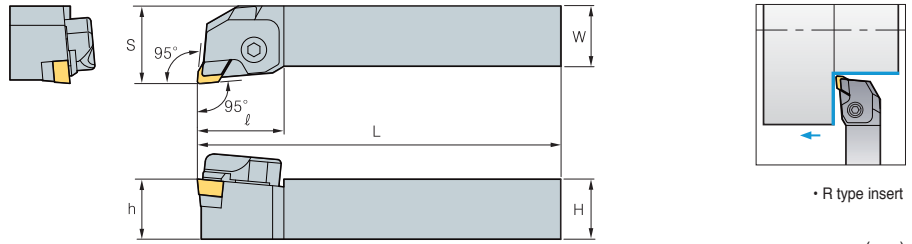

• R type insert

(mm)

Designation	H = (h)	W	L	ℓ	S	Inserts	Clamp	Clamp Screw	Chip Breaker	Shim	Shim Screw	Wrench
EH 620R	20	20	125	36	27	ESB34						
EH 625R	25	25	150	36	32							

➔ Applicable inserts C71

Insert

Application	Picture	Designation	Uncoated		Dimensions (mm)			Configuration
			ST10	ST20	W	l	t	
General Machining		ESB 34			9.525	30.0	6.35	

●: Stock item

PH For Parting off Deep grooving



POB

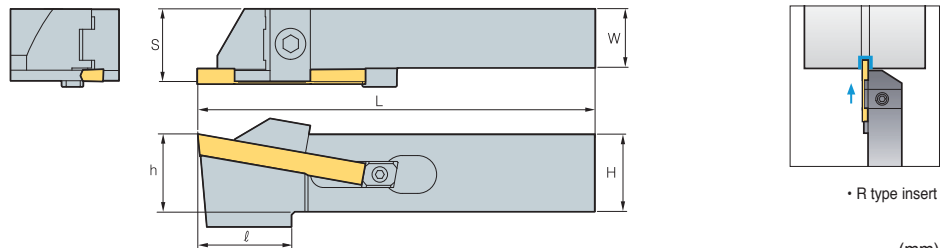

• R type insert

(mm)

Designation	H	W	L	ℓ	S	h	Max (Ø)	Inserts	Clamp	Clamp Screw	Stopper	Stopper Screw	Wrench
PH 320R/L	19	19	150	34	22.25	19	30	POB300					
PH 325R/L	25	19	150	34	22.25	25	40						
PH 420R/L	19	19	150	34	23.5	19	30	POB400					
PH 425R/L	25	19	150	34	23.5	25	40						
PH 520R/L	19	19	150	34	24.4	19	50	POB500					
PH 525R/L	25	19	150	34	24.4	25	50						

➔ Applicable inserts C71

Insert

Application	Picture	Designation	Uncoated		Dimensions (mm)			Configuration
			ST10	ST20	W	l	t	
Grooving - Parting off		POB 300		●	3.0	55	6.0	
		POB 400		●	4.0	55	7.0	
		POB 500		●	5.0	55	8.0	

●: Stock item

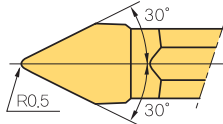
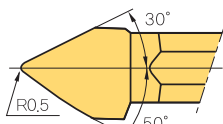
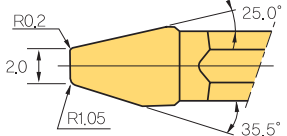
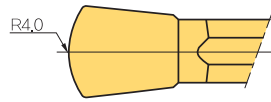
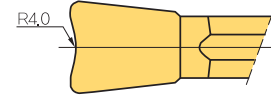
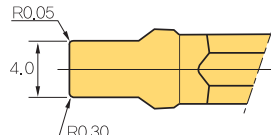
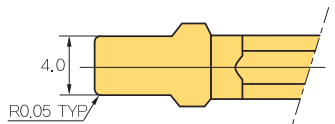
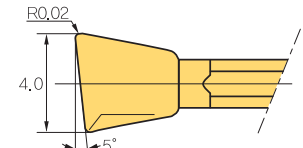
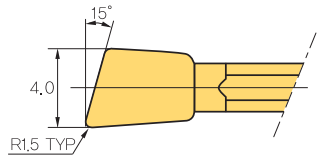
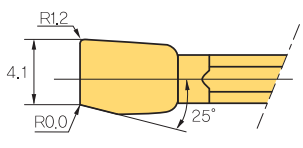

C Special Order Form for MGT

Code system	Configuration
<p>M F G N 4 - 0.5R - 30D</p> <p>① ② ③ ④ ⑤ ⑥ ⑦</p> <p>① Multi ② Forming ③ Grinding ④ Feed Direction ⑤ Clamp part: 4 mm ⑥ Nose Radius: 0.5 ⑦ Degree: 30°</p>	 <p>Ex) MFGN4-0.5R-30D</p>
<p>MFGN4 - 0.5R - L 50 D - R 30D</p> <p>① ② ③ ④ ⑤ ⑥</p> <p>① Refer to No. 1 ② Nose Radius: 0.5 ③ Left ④ Degree: 50° ⑤ Right ⑥ Degree > 30°</p>	 <p>Ex) MFGN4-0.5R-L50D-R30D</p>
<p>MFGN4 - 2.0 - R 020 250 - L 105 335</p> <p>① ② ③ ④ ⑤ ⑥ ⑦ ⑧</p> <p>① Refer to No. 1 ② Width of cutting edge: 2.0mm ③ Right ④ Nose Radius: 0.20 ⑤ Degree: 25.0° ⑥ Left ⑦ Nose Radius: 1.05 ⑧ Degree: 35.5°</p>	 <p>Ex) MFGN4-2.0-R020250-L105335</p>
<p>MFGN5 - 4.0R F</p> <p>① ② ③</p> <p>① Refer to No. 1 ② Radius: 4.0 ③ Front(Concave)</p>	 <p>Ex) MFGN5-4.0RF</p>
<p>MFGN5 - 4.0R B</p> <p>① ② ③</p> <p>① Refer to No. 1 ② Radius: 4.0 ③ Back(Concave)</p>	 <p>Ex) MFGN5-4.0RB</p>
<p>MFGN5 - 4.0 - R 005 - L 030</p> <p>① ② ③ ④ ⑤ ⑥</p> <p>① Refer to No. 1 ② Width of cutting edge: 4.0 mm ③ Right ④ Nose Radius: 0.05 ⑤ Left ⑥ Nose Radius : 0.30</p>	 <p>Ex) MFGN5-4.0-R005-L030</p>
<p>MFGN5 - 4.0 - 0.05 R</p> <p>① ② ③</p> <p>① Refer to No. 1 ② Width of cutting edge: 4.0 mm ③ Nose Radius: 0.05</p>	 <p>Ex) MFGN5-4.0-0.05R</p>
<p>MFG R 5 - 4.0 - 5D - R 002 - L 115</p> <p>① ② ③ ④ ⑤ ⑥ ⑦ ⑧ ⑨</p> <p>① Refer to No. 1 ② Right ③ Clamp part: 5mm ④ Width of cutting edge: 4.0mm ⑤ Lead angle: 5° ⑥ Right ⑦ Nose Radius: 0.02 ⑧ Left ⑨ Nose Radius: 1.15</p>	 <p>Ex) MFGR5-4.0-5D-R002-L115</p>
<p>MFG L 5 - 4.0 - 15D - 1.5R</p> <p>① ② ③ ④ ⑤ ⑥</p> <p>① Refer to No. 1 ② Left ③ Clamp part: 5 mm ④ Width of cutting edge: 4.0 mm ⑤ Lead angle: 15° ⑥ Right Nose Radius: 1.5</p>	 <p>Ex) MFG L 5-4.0-15D-1.5R</p>
<p>MFG R 5 - 4.10 - 25D - R012 - L000</p> <p>① ② ③ ④ ⑤ ⑥ ⑦</p> <p>① Refer to No. 1 ② Right ③ Clamp part: 5mm ④ Width of cutting edge: 4.1mm ⑤ Degree: 25° ⑥ Right Nose Radius: 1.2 ⑦ Left Nose Radius: 0.0</p>	 <p>Ex) MFG R 5-4.10-25D-R012-L000</p>



Code system

KP 27 064 - R0.425 N3

KORLOY PULLEY

ØD

W

R1

No. of flutes

Ex)

I.C	T	R	Z
Ø 15.875	6.4	0.425	3

► Special types are available for quotation

Insert for machining of pulley

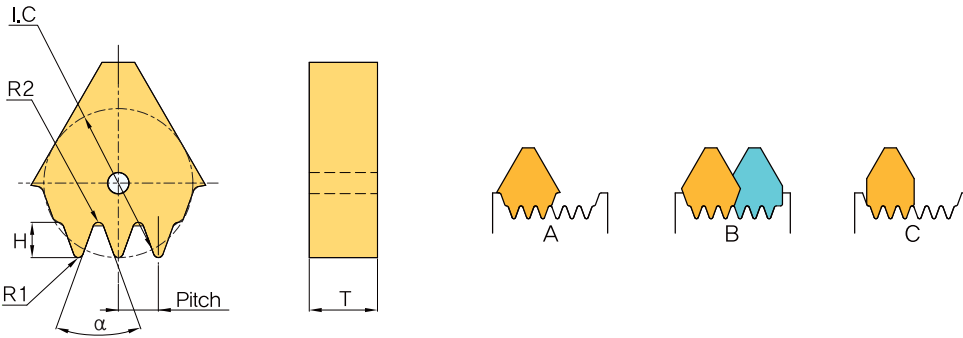

Specifications	Standard designation
----------------	----------------------

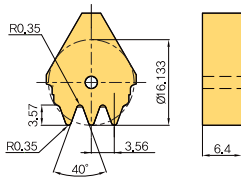

KP27064-R0.35-N3
(Former: DF356-3B)

Specifications	Standard designation
----------------	----------------------

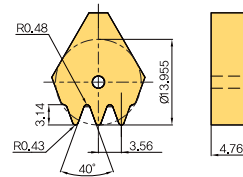

KP27064-R0.43-N3
(Former: DF356-3SR)

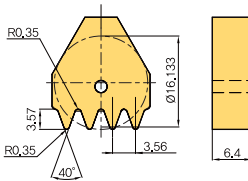

KP27064-R0.35-N4
(Former: DF356-4B)

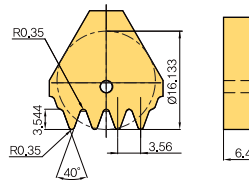

KP27064-R0.35-N4-A
(Former: DF356-4X)

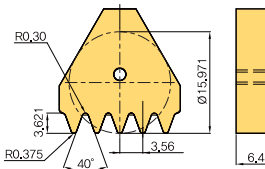

KP27064-R0.375-N5
(Former: DF356-5B)

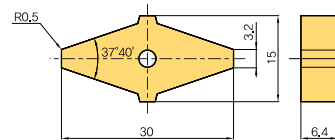

UF320

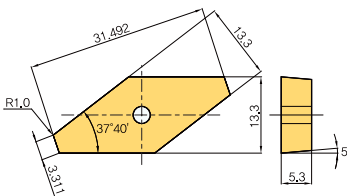

VF13M522

D

THREADING

Korloy threading tools are available for machining various shapes of thread at various pitches while ensuring high quality performances



Threading Code System

- D02 Threading Holder Code System
- D02 Threading Insert Code System

Technical information for Threading

- D03 Technical Information for Threading
- D09 Threading Insert with Chip Breaker

Thread Inserts

- D10 Partial Profile 60°
- D11 Partial Profile 55°
- D12 ISO Metric
- D16 American UN
- D18 With Worth
- D22 British Standard Pipe Thread
- D22 National Pipe Thread
- D23 National Pipe Thread-Dry seal
- D23 Round DIN 405
- D24 Trapez DIN 103
- D24 American ACME
- D25 Stub ACME
- D26 UNJ (Unified Constant Thread)
- D28 American Buttress (ABUT)
- D28 British Buttress (BBUT)
- D29 Metric Buttress (SAGE)/API
- D30 API Buttress Casing (BUT)
- D30 API Round Casing & Tubing (APIRD)
- D30 Extreme Line Casing (EL)

Thread Holders

- D31 External Holder
- D32 Internal Holder
- D33 Vertical Type Holder

Thread Milling

- D34 Technical Information for Thread Milling
- D44 Thread Milling Inserts
- D49 Thread Milling Holder

Solid Threading Endmills

- D50 Technical Information for Solid Threading Endmills
- D51 Solid Threading Endmills

TAP

- D61 Technical Information for Tap
- D65 Carbide Tap
- D69 HSS Tap



D Threading Code System

Threading holder code system



1 Holder type
E R H 10 (N) - 11 (C)
 E: For External I: For Internal

2 Hand of insert
E R H 10 (N) - 11 (C)
 R: Right handed L: Left handed

3 Name
E R H 10 (N) - 11 (C)
 H: Holder

4 Height of shank
E R H 10 (N) - 11 (C)

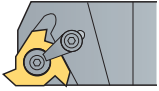

- External
8, 10, 12, 16, 20,
25, 32, 40, 50

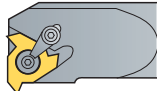

- Internal
10, 12, 13, 16, 20,
25, 32, 49, 50, 60

* Refer to the specification for shank diameter information

6 Insert size (mm)
E R H 10 (N) - 11 (C)

11: d = 6.35
16: d = 9.525
22: d = 12.7
27: d = 15.875

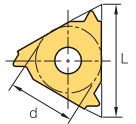

5 Shim
E R H 10 (N) - 11 (C)
 No code: Shim required
 N: No shim required

7 Clamping system
E R H 10 (N) - 11 (C)
 No code: Screw on system
 C: Clamp on system

Threading insert code system

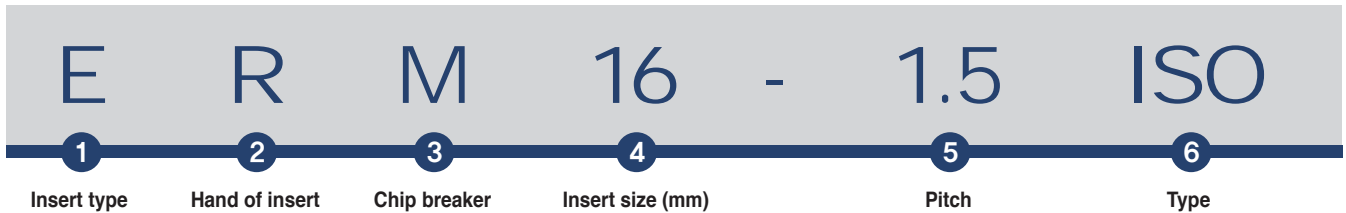

1 Insert type
E R M 16 - 1.5 ISO
 E: External thread I: Internal thread

2 Hand of insert
E R M 16 - 1.5 ISO
 R: Right handed L: Left handed

3 Chip breaker
E R M 16 - 1.5 ISO
 M: With chip breaker

4 Insert size (mm)
E R M 16 - 1.5 ISO

11: d = 6.35
16: d = 9.525
22: d = 12.7
27: d = 15.875

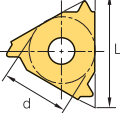

Insert shape

<ER/IR>

<ERM/IRM>

5 Pitch
E R M 16 - 1.5 ISO

Full profile		Partial profile	
mm	tpi	mm	tpi
0.35-6.0	72-3	A 0.5-1.5	48-16
		AG 0.5-3.0	48-8
		G 1.75-3.0	14-8
		N 3.5-5.0	7-5
		Q 5.5-6.0	4.5-4

6 Type
E R M 16 - 1.5 ISO

Partial profile 60°
 Partial Profile 55°
 ISO Metric (Full Profile)
 American UN (Full Profile) UN, UNC, UNF, UNEF
 Whitworth (Full Profile) BSW, BSF, BSP
 British Standard Pipe thread (Full Profile) BSPT
 National Pipe Thread (Full Profile) NPT
 National Pipe Threads-Dryseal (Full Profile) NPTF
 Round DIN 405
 Trapez DIN 103
 American ACME
 Stub ACME
 UNJ
 American Buttress
 British Buttress
 Metric Buttress-Sagengewinde
 API
 API Buttress Casing
 API Round Casing & Tubing
 EL-Extreme Line Casing



Special features

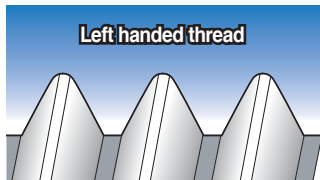
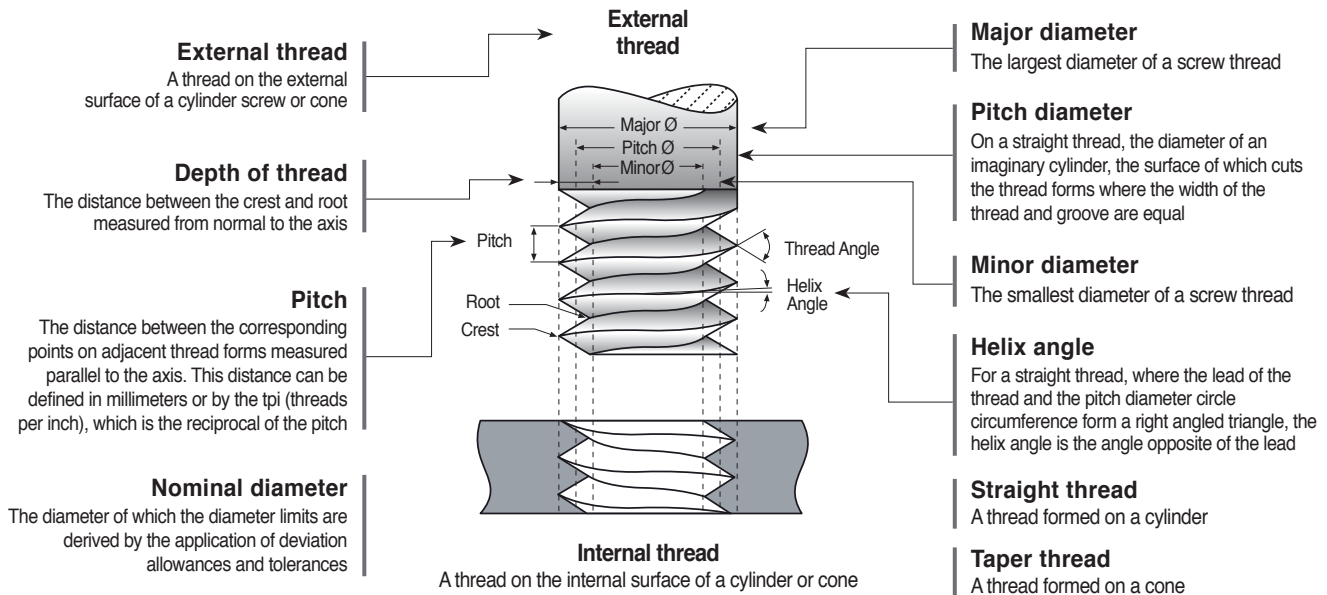

A thread which, when viewed axially, winds in a counter clockwise and receding direction. All left handed threads are designated LH



A thread which, when viewed axially, winds in a clockwise and receding direction. Threads are always right handed unless they are specified

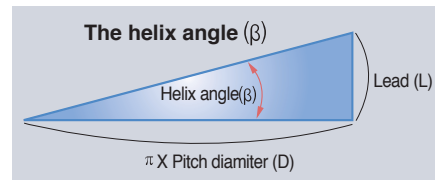

For a straight thread, where the lead of the thread and the pitch diameter circle circumference form a right angled triangle, the helix angle is the angle opposite of the lead

Machining a multi-start thread

- A thread in which the lead is an integral multiple, greater than one, of the pitch. A multi-start thread permits a more rapid advance without a coarser (larger) thread form

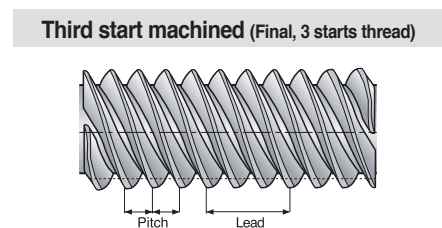
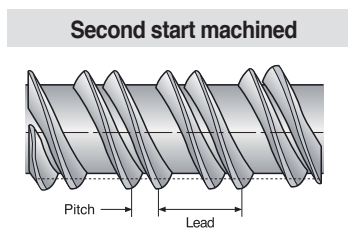
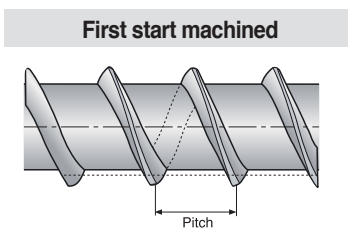

Insert profile style

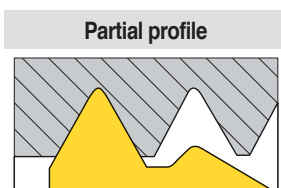

The V partial profile insert cuts without topping the outer diameter of the thread. The same insert can be used for a range of different thread pitches which have a common thread angle

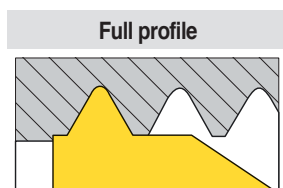

The full profile insert will form a complete thread profile including the crest. For every thread pitch and standard, a separate insert is required

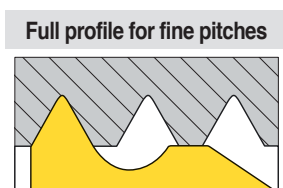

The full profile for Fine Pitches will form a complete thread. The topping of the outer diameter is generated by second tooth

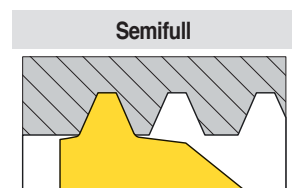

The Semi profile insert will form a complete thread including crest radius but without topping the outer diameter. Mainly used for trapezoidal profiles

Thread turning method

Thread	Inserts & Tool holder	Rotation	Feed direction	Helix method	Drawing no.
Right Hand Externa	EX RH	Counter clockwise	Towards chuck	Regular	1
	EX LH	Clockwise	From chuck	Reversed	2
Right Hand Internal	IN LH	Counter clockwise	Towards chuck	Regular	3
	IN LH	Clockwise	From chuck	Reversed	4
Left Hand External	EX LH	Clockwise	Towards chuck	Regular	5
	EX RH	Counter clockwise	From chuck	Reversed	6
Left Hand Internal	IN LH	Clockwise	Towards chuck	Regular	7
	IN RH	Counter clockwise	From chuck	Reversed	8

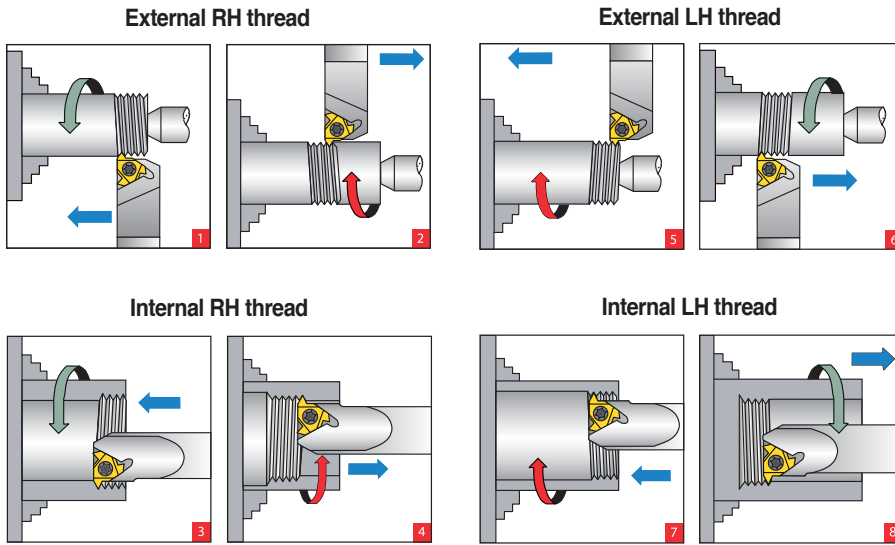

Calculating the helix angle (β)

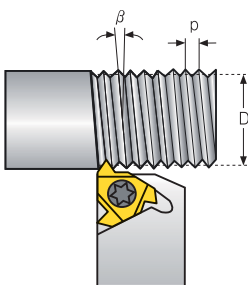

- The helix angle is calculated by the following formula:



$$\beta = \tan^{-1} \frac{P \times N}{\pi \times D}$$

- β: Helix angle (°)
- P: Pitch (mm)
- N: No. of starts
- D: Pitch diameter (mm)
- Lead = P x N

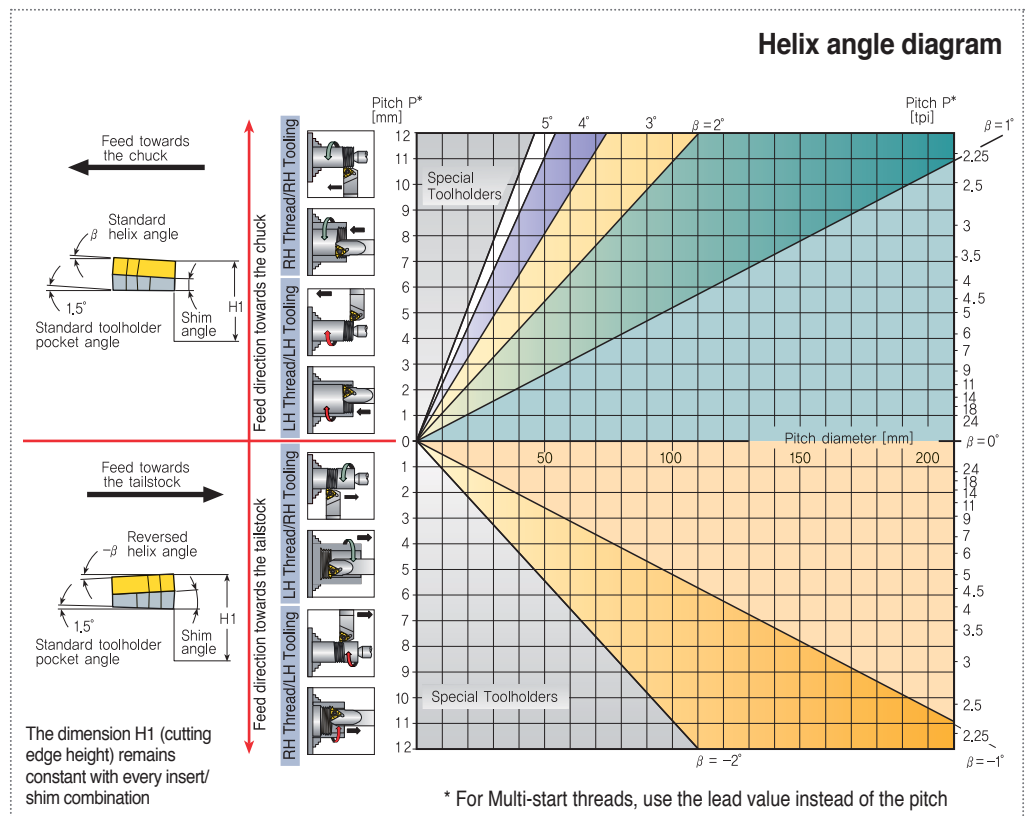
- The helix angle can also be found from the diagram below

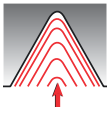
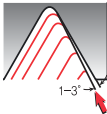

Thread infeed method

Infeed	Application
 Radial infeed	<ul style="list-style-type: none"> When the pitch is smaller than 16 tpi For material with short chips For work with hardened material <p>➔ Radial infeed is the simplest and quickest method. The feed is perpendicular to the turning axis, and both flanks of the insert perform the cutting operation. Radial infeed is recommended in 3 cases.</p>
 Flank infeed (modified)	<ul style="list-style-type: none"> When the thread pitch is greater than 16 tpi. Using the radial method, the effective cutting edge length is too large, resulting in chatter. For TRAPEZ and ACME. The radial method results in three cutting edges, making chip flow very difficult. <p>➔ Flank infeed is recommended in the following cases.</p>
 Alternate flank infeed	<ul style="list-style-type: none"> This method divides the load equally on both flanks, resulting in equal wear along the cutting edges. Alternate flank infeed requires more complicated programming, and is not available on all lathes. <p>➔ Use of the alternate flank method is recommended especially in large pitches and for materials with long chips.</p>

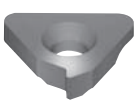
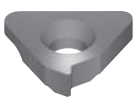

Shim

Standard shim	ATE (External) ATI (Through)		Helix angle 1.5°	Insert size	d	9.525		12.7		15.875	
					L	16		22		27	
				Holder	ER(L)H	IR(L)H	ER(L)H	IR(L)H	ER(L)H	IR(L)H	
				Ordering code	ATE16	ATI16	ATE22	ATI22	ATE27	ATI27	
 		<p>※ Standard shim has lead angle 1.5°</p>									

Application grade

Grade	Features	Available insert type
PC5300	Universal grade <ul style="list-style-type: none"> For chip breaker type only Stable machining on a wide application due to fine-grained carbide substrate with balanced heat resistance and toughness Excellent wear resistance and oxidation resistance due to TiN coating film. Outstanding performance on high speed machining 	ERM/IRM (Insert with Chip breaker)
PC3030T	Specialized grade for threading inserts <ul style="list-style-type: none"> A tough sub-micron substrate with TiAlN coating provides good fracture toughness and excellent wear resistance Outstanding performance on STS and hard to cut materials 	ER/IR (Ground insert)
PC9070	Specialized grade for threading inserts <ul style="list-style-type: none"> Strong wear resistance in stainless machining thanks to multilayer PVD coatings 	E/IR (Ground insert)

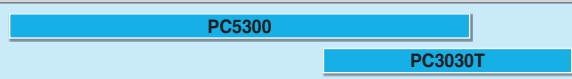
Recommended cutting speed as per workpiece (vc)

Workpiece		
P	Carbon steel, Alloy steel, Cast Steel	
M	Stainless steel, Heat resistant steel, Titanium alloy steel	
K	Carbon Iron, Aluminum, Cast Steel, Copper	

D Technical Information for Threading

Recommended cutting speed as per workpiece (vc)

Workpiece			Hardness brinell (HB)	vc (m/min)		
				PC3030T	PC9070	PC5300
P	Carbon steel	Low carbon (C=0.1-0.25 %)	125	115~190		110~190
		Medium carbon (C=0.25-0.55 %)	150	100~175		100~165
		High carbon (C=0.55-0.85 %)	170	90~155		90~155
	Low alloy steel (alloying elements ≤ 5%)	Non-hardened	180	100~180		100~180
		Hardened	275	75~140		75~140
		Hardened	350	70~135		70~135
	High alloy steel (alloying elements > 5%)	Annealed	200	80~120		80~120
		Hardened	325	50~100		50~100
Cast steel	Low alloy (alloying elements <5%)	200	70~130		70~130	
	High alloy (alloying elements >5%)	225	60~120		60~120	
M	Stainless steel ferritic	Non-hardened	200	70~130	70~150	70~130
		Hardened	330	50~95	60~125	50~95
	Stainless steel austenitic	Austenitic	180	80~120	90~160	80~120
		Super austenitic	200	30~100	40~120	30~100
	Stainless steel cast ferritic	Non-hardened	200	90~120	90~150	90~120
		Hardened	330	65~110	65~120	65~110
	Stainless steel cast austenitic	Austenitic	200	85~110	85~120	85~110
		Hardened	330	60~100	60~110	60~100
	High temperature alloy	Annealed (Iron based)	200	45~60		45~60
		Aged (Iron based)	280	30~50		30~50
		Annealed (Nickel or Cobalt based)	250	20~30		20~30
		Aged (Nickel or Cobalt based)	350	15~25		15~25
Titanium alloy	99.5% pure Titanium	400Rm	140~170		140~170	
	Titanium alloy	1050Rm	50~70		50~70	
K	Extra hard steel	Hardened & tempered	55HRC	45~60		45~60
	Malleable cast iron	Ferritic (short chips)	130	70~120		70~120
		Pearlitic (long chips)	230	70~120		70~120
	Gray cast iron	Low tensile strength	180	70~130		70~130
		High tensile strength	260	60~100		60~100
	Nodular SG iron	Ferritic	160	125~160		125~160
		Pearlitic	260	90~120		90~120
	Aluminum alloy wrought	Non-aging	60	100~250		100~250
		Aged	100	80~180		80~180
	Aluminum alloy	Cast	75	200~400		200~400
		Cast & aged	90	200~280		200~280
		Cast Si 13-22%	130	60~150		60~180
Copper and copper alloy	Brass	90	80~120		80~210	
	Bronze and non-leaded copper	100	80~120		80~210	

Calculation of n [RPM]

$$n = \frac{vc \times 1000}{\pi \times D} \quad vc = \frac{\pi \times D \times n}{1000}$$

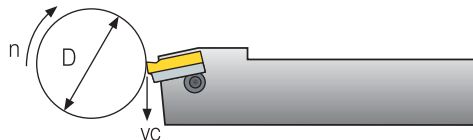

n: Revolution Per Minute [min⁻¹]
vc: Cutting Speed [m/min]
D: Workpiece Diameter [mm]

Number of passes

Pitch	mm	0.50	0.75	1.00	1.25	1.50	1.75	2.00	2.50	3.00	3.50	4.00	4.50	5.00	5.50	6.00	8.00
	tpi	48	32	24	20	16	14	12	10	8	7	6	5.5	5	4.5	4	3
No. of passes		4~6	4~7	4~8	5~9	6~10	7~12	7~12	8~14	9~16	10~18	11~18	11~19	12~20	12~20	12~20	15~24

※ One cutting depth is calculated by total cutting depth divided into machining times
ex) ER16-1.5ISO, hmin 0.92: If 10 times machining, one cutting depth is 0.092 (0.92/10)



Step by step thread turning

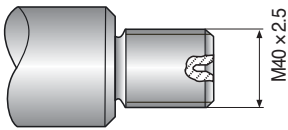

Application

- Thread: External right hand ISO metric M40x2.5
- Material: 4140 (25 HRC)

1 Choose the thread turning method

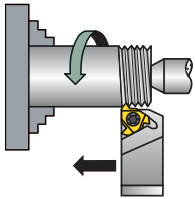

Feed direction towards the chuck was chosen
Therefore an external right hand insert and an external right hand holder will be used

3 Choose the tool holder

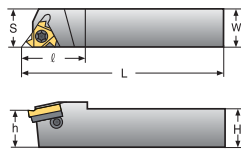

Chosen tool holder: ERH 25-16

Insert size	Ordering code	Dimensions (mm)				
		d	H=h	W	S	L
9.525	ERH25-16	25	25	25	153.6	30

2 Choose the insert size

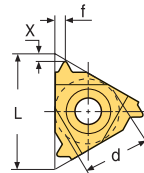

Chosen insert: ER16-2.5 ISO

Insert size	Pitch	Ordering code	Shim		Tool holder
			d	mm	
9.525	2.5	ER16-2.5ISO	ATE16	ATE16	ERH□□-16

4 Determine the helix angle

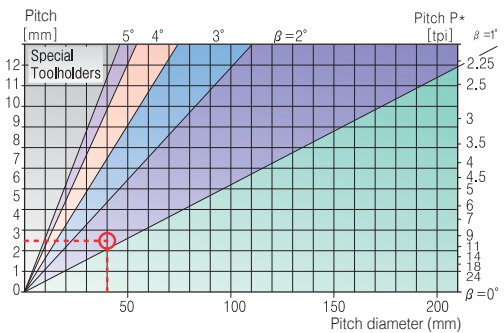

From the table, using a pitch of 2.5 mm (10 tpi) and a workpiece diameter of 40 mm (1.57"), we find the helix angle to be 1.5°

5 Choose the correct shim

Resultant Helix angle		1.5°
Insert size	d	9.525
	L	16
Ordering code		ATE16

6 Choose the carbide grade and cutting speed

Workpiece	HB	vc (m/min)	
		PC3030T	
P Low alloy steel (alloying elements ≤ 5%)	Non-hardened	180	85~145
	Hardened	275	75~140
	Hardened	350	70~135

- Carbide grade chosen: PC3030T
- Cutting speed: 140 m/min

7 Determine the number of passes

Pitch	mm	1.50	1.75	2.00	2.50	3.00	3.50	4.00
	tpi	16	14	12	10	8	7	6
No. of passes		6~10	7~12	7~12	8~14	9~16	10~18	11~18

- Carbide grade chosen: PC3030T
- Cutting speed: 140 m/min

8 Summary

Thread type	ISO M40 x 2.5 External right hand
1. Feed direction	Towards the chuck
2. Insert and grade	ER16-2.5ISO, PC3030T
3. Tool holder	ERH25-16
4. Helix angle	1.5°
5. Shim	ATE16
6. Cutting speed	140 m/min
7. Number of passes	10

D Technical Information for Threading

➤ Cutting condition depending on







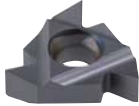
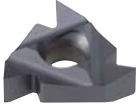

Workpiece	Material type		Coolant	Coolant type		
	Material dimension			Holders	Holder cross section area	
	Diameter and length chipflow character				Holder overhang	
	Material hardness				Through coolant option	
Thread application	External or internal		Shank type: Carbide, alloy,	Shank type: Carbide, alloy,		
	Profile shape			Insert	Carbide implant grade	
	Surface finish				Profile shape: Pitch and depth	
Machine	Machine stability		Nose radius			
	Max. RPM		Chip breaker style			
	Clamping system stability					

➤ Trouble shooting

Problem	Possible cause	Solution
Increased flank wear	Cutting speed too high ➤ Depth of cut too low/too many passes ➤ Unsuitable carbide grade ➤ Insufficient cooling ➤	Reduce cutting speed/use coated insert Increase the depth of cut per pass Use a coated carbide grade Increase coolant flow rate
Uneven cutting edge wear	Incorrect helix angle ➤ Wrong infeed method ➤	Choose the correct shim Use the alternating flank infeed method
Extreme plastic deformation	Depth of cut too large ➤ Insufficient cooling ➤ Cutting speed too high ➤ Unsuitable carbide grade ➤ Nose radius too small ➤	Decrease depth of cut/ increase number of passes Increase coolant flow rate Reduce cutting speed Use a tougher carbide Use an insert with a larger radius, if possible
Cutting edge breakage	Depth of cut too large ➤ Extreme plastic deformation ➤ Insufficient cooling ➤ Unsuitable carbide grade ➤ Instability ➤	Decrease depth of cut/ increase number of passes. Use a tougher carbide Increase flow rate and/ or correct flow direction Use a tougher carbide Check stability of the system
Built-up edge	Incorrect cutting speed ➤ Unsuitable carbide grade ➤	Change the cutting speed Use a coated carbide
Thread profile is too shallow	The tool is not at the workpiece axis height ➤ Insert is not machining the thread crest ➤ Worn insert ➤	Change tool height Measure the workpiece diameter Change the cutting edge sooner
Poor surface quality	Too low cutting speed ➤ Wrong shim ➤ Flank infeed method is not appropriate ➤	Increase cutting speed Choose correct shim Use the alternate flank or radial infeed method

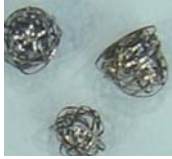
Threading insert with chip breaker

- Features**
- Economical insert
 - Good toughness and high accuracy as ground type inserts
 - Exclusive insert design improves chip control
 - New grade for general application of various kinds of workpieces

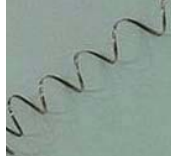
Type	Ground insert		Insert with a chip breaker			
C/B Code	None		None		U	
Designation	ER16-1.5ISO		ERM16-1.5ISO		ERM16-1.5ISO-U	
Machining	External	Internal	External	Internal	External	Internal
Insert Shape						
Chip Shape						
Class	P, M, K, N, S		P, M, K		P, M, K	
Application	G-Class		M-Class		M-Class	
Features	<ul style="list-style-type: none"> • Groove-shaped chip breaker with superior chip evacuation lowers cutting load • Enables high precision machining • Applicable for machining of various shapes of threads • Applicable for machining of various workpieces 		<ul style="list-style-type: none"> • Unique 3 dimensional chip breaker improves machinability with good chip control • Excellent cutting edge treatment technology ensures high precision sharp cutting edge 		<ul style="list-style-type: none"> • Groove-shaped chip breaker with superior chip evacuation lowers cutting load • Reduces machining pass by 10-30% • Excellent cutting edge treatment achieves high precision sharp cutting edge 	

Application examples

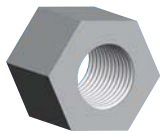
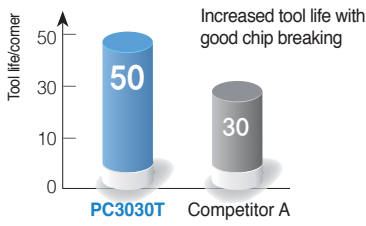
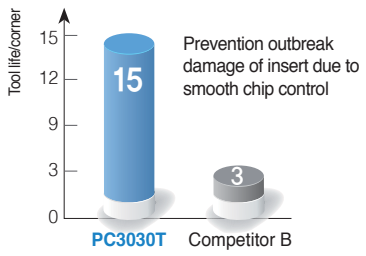
KORLOY		ERM16-1.5ISO [PC3030T]	IRM16-2.0ISO [PC3030T]
Competitor tools		ER16-1.5ISO [A-Maker]	IR16-2.0ISO [B-Maker]
Workpiece	Material	SCM440	STS304
	Figure		
Cutting condition	Cutting speed (m/min)	63	120
	Pass	8	9
	Machining	Radial infeed	Radial infeed
	Pitch	1.5	2.0
Coolant		Wet	Wet
Result		 <p>50 30</p> <p>PC3030T Competitor A</p>	 <p>15 3</p> <p>PC3030T Competitor B</p>

Partial profile 60°

Type	Designation (Right)	PC3030T	PC9070T	Designation (Left)	PC3030T	PC9070T	Pitch		Dimensions (mm)					Picture
							(mm)	(tpi)	d	L	r	x	f	
External	ER 11-A60	●	●	EL 11-A60	●		0.5~1.5	48~16	6.35	11	0.05	0.8	0.9	
	16-A60	●	●	16-A60	●		0.5~1.5	48~16	9.525	16	0.05	0.8	0.9	
	16-G60	●		16-G60	●		1.75~3.0	14~8	9.525	16	0.27	1.2	1.7	
	16-AG60	●	●	16-AG60	●		0.5~3.0	48~8	9.525	16	0.08	1.2	1.7	
	22-N60	●	●	22-N60	●		3.5~5.0	7~5	12.7	22	0.53	1.7	2.5	
	27-Q60	●	●	27-Q60	●		5.5~6.0	4.5~4	15.875	27	0.64	2.1	3.1	
Internal	IR 11-A60	●	●	IL 11-A60	●	●	0.5~1.5	48~16	6.35	11	0.05	0.8	0.9	
	16-A60	●		16-A60	●		0.5~1.5	48~16	9.525	16	0.05	0.8	0.9	
	16-G60	●		16-G60	●		1.75~3.0	14~8	9.525	16	0.16	1.2	1.7	
	16-AG60	●	●	16-AG60	●		0.5~3.0	48~8	9.525	16	0.05	1.2	1.7	
	22-N60	●	●	22-N60	●		3.5~5.0	7~5	12.7	22	0.30	1.7	2.5	
	27-Q60	●	●	27-Q60			5.5~6.0	4.5~4	15.875	27	0.30	1.8	2.7	

Applicable holders D31, D32

● Stock item

Partial profile 60° (M chip breaker)

Type	Designation (Right)	PC3030T	PC5300	Designation (Left)	PC3030T	Pitch		Dimensions (mm)					Picture	
						(mm)	(tpi)	d	L	r	x	f		
External	ERM 16-A60	●					0.5~1.5	48~16	9.525	16	0.05	0.8	0.9	
	16-G60	●					1.75~3.0	14~8	9.525	16	0.27	1.2	1.7	
	16-AG60	●					0.5~3.0	48~8	9.525	16	0.08	1.2	1.7	
	22-N60	●					3.5~5.0	7~5	12.7	22	0.53	1.7	2.5	
Internal	IRM 11-A60	●					0.5~1.5	48~16	6.35	11	0.08	0.8	0.9	
	16-A60	●					0.5~1.5	48~16	9.525	16	0.08	0.8	0.9	
	16-G60	●					1.75~3.0	14~8	9.525	16	0.12	1.2	1.7	
	16-AG60	●					0.5~3.0	48~8	9.525	16	0.08	1.2	1.7	
	22-N60	●					3.5~5.0	7~5	12.7	22	0.30	1.7	2.5	

Applicable holders D31, D32

● Stock item

Partial profile 60° (U chip breaker) new

Type	Designation (Right)	PC3030T	PC5300	Designation (Left)	PC3030T	Pitch		Dimensions (mm)					Picture	
						(mm)	(tpi)	d	L	r	x	f		
External	ERM 16-AG60-U						0.5~3.0	48~8	9.525	16	0.08	1.2	1.7	
Internal	IRM 16-AG60-U						0.5~3.0	48~8	9.525	16	0.08	1.2	1.7	

Applicable holders D31, D32

● Stock item



Partial profile 55°

Type	Designation (Right)	PC3030T	PC9070T	Designation (Left)	PC3030T	PC9070T	Pitch		Dimensions (mm)					Picture
							(mm)	(tpi)	d	L	r	x	f	
External	ER 11-A55	●		EL 11-A55			0.5~1.5	48~16	6.35	11	0.05	0.8	0.9	
	16-A55	●		16-A55	●		0.5~1.5	48~16	9.525	16	0.05	0.8	0.9	
	16-G55	●		16-G55			1.75~3.0	14~8	9.525	16	0.21	1.2	1.7	
	16-AG55	●		16-AG55	●		0.5~3.0	48~8	9.525	16	0.07	1.2	1.7	
	22-N55	●		22-N55			3.5~5.0	7~5	12.7	22	0.43	1.7	2.5	
	27-Q55	●		27-Q55			5.5~6.0	4.5~4	15.875	27	0.60	2.0	2.9	
Internal	IR 11-A55	●		IL 11-A55	●		0.5~1.5	48~16	6.35	11	0.05	0.8	0.9	
	16-A55	●		16-A55			0.5~1.5	48~16	9.525	16	0.05	0.8	0.9	
	16-G55	●		16-G55			1.75~3.0	14~8	9.525	16	0.21	1.2	1.7	
	16-AG55	●		16-AG55	●		0.5~3.0	48~8	9.525	16	0.07	1.2	1.7	
	22-N55	●		22-N55			3.5~5.0	7~5	12.7	22	0.43	1.7	2.5	
	27-Q55	●		27-Q55			5.5~6.0	4.5~4	15.875	27	0.60	2.0	2.9	

Applicable holders D31, D32

● Stock item

Partial profile 55° (M chip breaker)

Type	Designation (Right)	PC3030T	PC5300	Designation (Left)	PC3030T	Pitch		Dimensions (mm)					Picture
						(mm)	(tpi)	d	L	r	x	f	
External	ERM 16-A55	●				0.5~1.5	48~16	9.525	16	0.08	0.8	0.9	
	16-G55	●				1.75~3.0	14~8	9.525	16	0.21	1.2	1.7	
	16-AG55	●				0.5~3.0	48~8	9.525	16	0.07	1.2	1.7	
	22-N55	●				3.5~5.0	7~5	12.7	22	0.43	1.7	2.5	
Internal	IRM 11-A55	●				0.5~1.5	48~16	6.35	11	0.08	0.8	0.9	
	16-A55	●				0.5~1.5	48~16	9.525	16	0.05	0.8	0.9	
	16-G55	●				1.75~3.0	14~8	9.525	16	0.08	1.2	1.7	
	16-AG55	●				0.5~3.0	48~8	9.525	16	0.08	1.2	1.7	
	22-N55	●				3.5~5.0	7~5	12.7	22	0.43	1.7	2.5	

Applicable holders D31, D32

● Stock item

Partial profile 55° (U chip breaker) new

Type	Designation (Right)	PC3030T	PC5300	Designation (Left)	PC3030T	Pitch		Dimensions (mm)					Picture
						(mm)	(tpi)	d	L	r	x	f	
External	ERM 16-AG55-U					0.5~3.0	48~8	9.525	16	0.07	1.2	1.7	
Internal	IRM 16-AG55-U					0.5~3.0	48~8	9.525	16	0.08	1.2	1.7	

Applicable holders D31, D32

● Stock item

ISO Metric

Type	Designation (Right)	PC3030T	PC9070T	Designation (Left)	PC3030T	PC9070T	Pitch (mm)	Dimensions (mm)					Picture
								d	L	hmin	X	f	
External	ER 11-0.35ISO	●		EL 11-0.35ISO			0.35	6.35	11	0.21	0.8	0.4	
	11-0.4ISO	●		11-0.4ISO			0.4	6.35	11	0.25	0.7	0.4	
	11-0.45ISO	●		11-0.45ISO			0.45	6.35	11	0.28	0.7	0.4	
	11-0.5ISO			11-0.5ISO			0.5	6.35	11	0.31	0.6	0.4	
	11-0.6ISO			11-0.6ISO			0.6	6.35	11	0.37	0.6	0.6	
	11-0.7ISO	●		11-0.7ISO			0.7	6.35	11	0.43	0.6	0.6	
	11-0.75ISO			11-0.75ISO			0.75	6.35	11	0.46	0.6	0.6	
	11-0.8ISO	●		11-0.8ISO			0.8	6.35	11	0.49	0.6	0.6	
	11-1.0ISO	●		11-1.0ISO			1.0	6.35	11	0.61	0.7	0.7	
	11-1.25ISO	●	●	11-1.25ISO			1.25	6.35	11	0.77	0.8	0.9	
	11-1.5ISO	●		11-1.5ISO	●		1.5	6.35	11	0.92	0.8	1.0	
	11-1.75ISO	●		11-1.75ISO			1.75	6.35	11	1.07	0.8	1.1	
	16-0.35ISO			16-0.35ISO			0.35	9.525	16	0.21	0.8	0.4	
	16-0.4ISO			16-0.4ISO			0.4	9.525	16	0.25	0.7	0.4	
	16-0.45ISO	●		16-0.45ISO			0.45	9.525	16	0.28	0.7	0.4	
	16-0.5ISO	●		16-0.5ISO	●		0.5	9.525	16	0.31	0.6	0.4	
	16-0.6ISO	●		16-0.6ISO			0.6	9.525	16	0.37	0.6	0.6	
	16-0.7ISO	●		16-0.7ISO			0.7	9.525	16	0.43	0.6	0.6	
	16-0.75ISO	●		16-0.75ISO			0.75	9.525	16	0.46	0.6	0.6	
	16-0.8ISO	●	●	16-0.8ISO			0.8	9.525	16	0.49	0.6	0.6	
	16-1.0ISO	●	●	16-1.0ISO	●		1.0	9.525	16	0.61	0.7	0.7	
	16-1.25ISO	●	●	16-1.25ISO	●		1.25	9.525	16	0.77	0.8	0.9	
	16-1.5ISO	●	●	16-1.5ISO	●		1.5	9.525	16	0.92	0.8	1.0	
	16-1.75ISO	●	●	16-1.75ISO			1.75	9.525	16	1.07	0.9	1.2	
	16-2.0ISO	●	●	16-2.0ISO	●		2.0	9.525	16	1.23	1.0	1.3	
	16-2.5ISO	●	●	16-2.5ISO	●		2.5	9.525	16	1.53	1.1	1.5	
	16-3.0ISO	●	●	16-3.0ISO	●		3.0	9.525	16	1.84	1.2	1.6	
	22-3.5ISO	●	●	22-3.5ISO	●		3.5	12.7	22	2.15	1.6	2.3	
	22-4.0ISO	●	●	22-4.0ISO	●		4.0	12.7	22	2.45	1.6	2.3	
	22-4.5ISO	●	●	22-4.5ISO			4.5	12.7	22	2.78	1.7	2.4	
	22-5.0ISO	●	●	22-5.0ISO	●		5.0	12.7	22	3.07	1.7	2.5	
	27-5.5ISO			27-5.5ISO			5.5	15.875	27	3.37	1.9	2.7	
	27-6.0ISO		●	27-6.0ISO			6.0	15.875	27	3.68	2.0	2.9	

Applicable holders D31

●: Stock item

ISO Metric (M chip breaker)

Type	Designation (Right)	PC3030T	PC5300	Designation (Left)	PC3030T	Pitch (mm)	Dimensions (mm)					Picture
							d	L	hmin	X	f	
External	ERM 16-1.0ISO	●				1.0	9.525	16	0.61	0.7	0.7	
	16-1.25ISO					1.25	9.525	16	0.77	0.8	0.9	
	16-1.5ISO	●				1.5	9.525	16	0.93	0.8	1.0	
	16-1.75ISO	●				1.75	9.525	16	1.09	0.9	1.2	
	16-2.0ISO	●				2.0	9.525	16	1.25	1.0	1.3	
	16-2.5ISO	●				2.5	9.525	16	1.55	1.1	1.5	
	16-3.0ISO	●				3.0	9.525	16	1.87	1.2	1.6	

➔ Applicable holders D31

● Stock item

ISO Metric (U chip breaker) **new**

Type	Designation (Right)	PC3030T	PC5300	Designation (Left)	PC3030T	Pitch (mm)	Dimensions (mm)					Picture
							d	L	hmin	X	f	
External	ERM 16-1.5ISO-U					1.5	9.525	16	0.93	0.8	1.0	
	16-2.0ISO-U					2.0	9.525	16	1.25	1.0	1.3	

➔ Applicable holders D31

● Stock item

ISO Metric

Type	Designation (Right)	PC3030T	PC9070T	Designation (Left)	PC3030T	PC9070T	Pitch (mm)	Dimensions (mm)					Picture
								d	L	hmin	X	f	
Internal	IR 11-0.35ISO	●		IL 11-0.35ISO			0.35	6.35	11	0.20	0.8	0.3	
	11-0.4ISO	●		11-0.4ISO			0.4	6.35	11	0.23	0.8	0.4	
	11-0.45ISO	●		11-0.45ISO			0.45	6.35	11	0.26	0.8	0.4	
	11-0.5ISO	●		11-0.5ISO	●		0.5	6.35	11	0.29	0.6	0.4	
	11-0.6ISO	●		11-0.6ISO			0.6	6.35	11	0.35	0.6	0.6	
	11-0.7ISO	●		11-0.7ISO			0.7	6.35	11	0.40	0.6	0.6	
	11-0.75ISO	●		11-0.75ISO	●		0.75	6.35	11	0.43	0.6	0.6	
	11-0.8ISO			11-0.8ISO			0.8	6.35	11	0.46	0.6	0.6	
	11-1.0ISO	●	●	11-1.0ISO			1.0	6.35	11	0.58	0.6	0.7	
	11-1.25ISO	●	●	11-1.25ISO	●		1.25	6.35	11	0.72	0.8	0.9	
	11-1.5ISO	●	●	11-1.5ISO	●	●	1.5	6.35	11	0.87	0.8	1.0	
	11-1.75ISO	●	●	11-1.75ISO			1.75	6.35	11	1.01	0.9	1.1	
	11-2.0ISO	●	●	11-2.0ISO	●		2.0	6.35	11	1.15	0.9	1.1	
	11-2.5ISO	●		11-2.5ISO	●		2.5	6.35	11	1.44	0.8	1.1	
	16-0.35ISO	●		16-0.35ISO			0.35	9.525	16	0.20	0.8	0.3	
	16-0.4ISO	●		16-0.4ISO			0.4	9.525	16	0.23	0.8	0.4	
	16-0.45ISO	●		16-0.45ISO			0.45	9.525	16	0.26	0.8	0.4	
	16-0.5ISO	●		16-0.5ISO			0.5	9.525	16	0.29	0.6	0.4	
	16-0.6ISO			16-0.6ISO			0.6	9.525	16	0.35	0.6	0.6	
	16-0.7ISO	●		16-0.7ISO			0.7	9.525	16	0.40	0.6	0.6	
	16-0.75ISO	●		16-0.75ISO			0.75	9.525	16	0.43	0.6	0.6	
	16-0.8ISO	●		16-0.8ISO			0.8	9.525	16	0.46	0.6	0.6	
	16-1.0ISO	●	●	16-1.0ISO			1.0	9.525	16	0.58	0.6	0.7	
	16-1.25ISO	●	●	16-1.25ISO			1.25	9.525	16	0.72	0.8	0.9	
	16-1.5ISO	●	●	16-1.5ISO	●		1.5	9.525	16	0.87	0.8	1.0	
	16-1.75ISO	●	●	16-1.75ISO			1.75	9.525	16	1.01	0.9	1.2	
	16-2.0ISO	●	●	16-2.0ISO	●		2.0	9.525	16	1.15	1.0	1.3	
	16-2.5ISO	●	●	16-2.5ISO	●		2.5	9.525	16	1.44	1.1	1.5	
	16-3.0ISO	●	●	16-3.0ISO	●		3.0	9.525	16	1.73	1.1	1.5	
	22-3.5ISO	●	●	22-3.5ISO			3.5	12.7	22	2.02	1.6	2.3	
	22-4.0ISO	●	●	22-4.0ISO	●		4.0	12.7	22	2.31	1.6	2.3	
	22-4.5ISO	●	●	22-4.5ISO			4.5	12.7	22	2.60	1.6	2.4	
	22-5.0ISO	●	●	22-5.0ISO			5.0	12.7	22	2.89	1.6	2.3	
	27-5.5ISO	●		27-5.5ISO			5.5	15.875	27	3.17	1.6	2.3	
	27-6.0ISO	●		27-6.0ISO			6.0	15.875	27	3.46	1.8	2.5	

➔ Applicable holders D32

●: Stock item

ISO Metric (M chip breaker)

Type	Designation (Right)	PC3030T	PC5300	Designation (Left)	PC3030T	Pitch	Dimensions (mm)					Picture
						(mm)	d	L	hmin	X	f	
Internal	IRM 11-1.5ISO	●				1.5	6.35	11	0.85	0.8	1.0	
	16-1.0ISO	●				1.0	9.525	16	0.58	0.6	0.7	
	16-1.25ISO					1.25	9.525	16	0.72	0.8	0.9	
	16-1.5ISO	●				1.5	9.525	16	0.85	0.8	1.0	
	16-1.75ISO					1.75	9.525	16	1.01	0.9	1.2	
	16-2.0ISO	●				2.0	9.525	16	1.12	1.0	1.3	
	16-2.5ISO	●				2.5	9.525	16	1.44	1.1	1.5	
	16-3.0ISO	●				3.0	9.525	16	1.69	1.1	1.5	

➔ Applicable holders D32

● Stock item

ISO Metric (U chip breaker) new

Type	Designation (Right)	PC3030T	PC5300	Designation (Left)	PC3030T	Pitch	Dimensions (mm)					Picture
						(mm)	d	L	hmin	X	f	
Internal	IRM 16-1.5ISO-U					1.5	9.525	16	0.85	0.8	1.0	
	16-2.0ISO-U					2.0	9.525	16	1.12	1.0	1.3	

➔ Applicable holders D32

● Stock item

American UN (UN, UNC, UNF, UNEF, UNS)

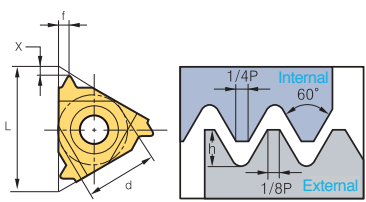
Type	Designation (Right)	PC3030T	PC9070T	Designation (Left)	PC3030T	PC9070T	Pitch (tpi)	Dimensions (mm)					Picture
								d	L	hmin	X	f	
External	ER 11-72UN	●		EL 11-72UN			72	6.35	11	0.22	0.8	0.4	
	11-64UN	●		11-64UN			64	6.35	11	0.24	0.8	0.4	
	11-56UN	●		11-56UN			56	6.35	11	0.28	0.7	0.4	
	11-48UN	●		11-48UN			48	6.35	11	0.32	0.6	0.6	
	11-44UN	●		11-44UN			44	6.35	11	0.35	0.6	0.6	
	11-40UN	●		11-40UN			40z	6.35	11	0.39	0.6	0.6	
	11-36UN	●		11-36UN			36	6.35	11	0.43	0.6	0.6	
	11-32UN	●		11-32UN			32	6.35	11	0.49	0.6	0.6	
	11-28UN	●		11-28UN			28	6.35	11	0.56	0.6	0.7	
	11-27UN	●		11-27UN			27	6.35	11	0.58	0.7	0.8	
	11-24UN	●		11-24UN			24	6.35	11	0.65	0.7	0.8	
	11-20UN	●		11-20UN			20	6.35	11	0.78	0.8	0.9	
	11-18UN	●		11-18UN			18	6.35	11	0.87	0.8	1.0	
	11-16UN	●		11-16UN			16	6.35	11	0.97	0.9	1.1	
	11-14UN	●		11-14UN			14	6.35	11	1.11	0.9	1.1	
	16-72UN			16-72UN			72	9.525	16	0.22	0.8	0.4	
	16-64UN			16-64UN			64	9.525	16	0.24	0.8	0.4	
	16-56UN			16-56UN			56	9.525	16	0.28	0.7	0.4	
	16-48UN			16-48UN			48	9.525	16	0.32	0.6	0.6	
	16-44UN			16-44UN			44	9.525	16	0.35	0.6	0.6	
	16-40UN			16-40UN			40	9.525	16	0.39	0.6	0.6	
	16-36UN			16-36UN			36	9.525	16	0.43	0.6	0.6	
	16-32UN	●		16-32UN			32	9.525	16	0.49	0.6	0.6	
	16-28UN			16-28UN			28	9.525	16	0.56	0.6	0.7	
	16-27UN	●		16-27UN			27	9.525	16	0.58	0.7	0.8	
	16-24UN	● ●		16-24UN			24	9.525	16	0.65	0.7	0.8	
	16-20UN	● ●		16-20UN			20	9.525	16	0.78	0.8	0.9	
	16-18UN	● ●		16-18UN	●		18	9.525	16	0.87	0.8	1.0	
	16-16UN	● ●		16-16UN	●		16	9.525	16	0.97	0.9	1.1	
	16-14UN	● ●		16-14UN			14	9.525	16	1.11	1.0	1.2	
	16-13UN			16-13UN			13	9.525	16	1.20	1.0	1.3	
	16-12UN	● ●		16-12UN			12	9.525	16	1.30	1.1	1.4	
	16-11.5UN	●		16-11.5UN			11.5	9.525	16	1.35	1.1	1.5	
	16-11UN	● ●		16-11UN			11	9.525	16	1.42	1.1	1.5	
	16-10UN	● ●		16-10UN			10	9.525	16	1.56	1.1	1.5	
	16-9UN	●		16-9UN			9	9.525	16	1.73	1.2	1.7	
	16-8UN	● ●		16-8UN			8	9.525	16	1.95	1.2	1.6	
	22-7UN			22-7UN			7	12.7	22	2.22	1.6	2.3	
	22-6UN	●		22-6UN			6	12.7	22	2.60	1.6	2.3	
	22-5UN	●		22-5UN			5	12.7	22	3.12	1.7	2.5	
	27-4.5UN			27-4.5UN			4.5	15.875	27	3.46	1.9	2.7	
	27-4UN			27-4UN			4	15.875	27	3.89	2.1	3.0	

Applicable holders D31

● Stock item

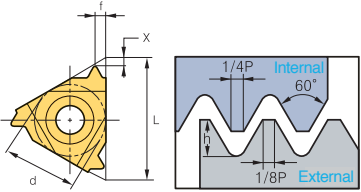

American UN (UN, UNC, UNF, UNEF, UNS)

Type	Designation (Right)	PC3030T	PC9070T	Designation (Left)	PC3030T	PC9070T	Pitch (tpi)	Dimensions (mm)					Picture
								d	L	hmin	X	f	
Internal	IR 11-72UN			IL 11-72UN			72	6.35	11	0.20	0.8	0.3	
	11-64UN			11-64UN			64	6.35	11	0.23	0.8	0.4	
	11-56UN			11-56UN			56	6.35	11	0.26	0.7	0.4	
	11-48UN			11-48UN			48	6.35	11	0.31	0.6	0.6	
	11-44UN			11-44UN			44	6.35	11	0.33	0.6	0.6	
	11-40UN			11-40UN			40	6.35	11	0.37	0.6	0.6	
	11-36UN			11-36UN			36	6.35	11	0.41	0.6	0.6	
	11-32UN			11-32UN			32	6.35	11	0.46	0.6	0.6	
	11-28UN			11-28UN			28	6.35	11	0.52	0.6	0.7	
	11-27UN			11-27UN			27	6.35	11	0.54	0.7	0.8	
	11-24UN			11-24UN			24	6.35	11	0.61	0.7	0.8	
	11-20UN		●	11-20UN			20	6.35	11	0.73	0.8	0.9	
	11-18UN	●		11-18UN			18	6.35	11	0.81	0.8	1.0	
	11-16UN		●	11-16UN			16	6.35	11	0.92	0.9	1.1	
	11-14UN			11-14UN			14	6.35	11	1.05	0.9	1.1	
	11-12UN		●	11-12UN			12	6.35	11	1.22	0.8	1.1	
	11-11UN	●		11-11UN	●		11	6.35	11	1.33	0.8	1.1	
	16-72UN			16-72UN			72	9.525	16	0.20	0.8	0.3	
	16-64UN			16-64UN			64	9.525	16	0.23	0.8	0.4	
	16-56UN			16-56UN			56	9.525	16	0.26	0.7	0.4	
	16-48UN			16-48UN			48	9.525	16	0.31	0.6	0.6	
	16-44UN			16-44UN			44	9.525	16	0.33	0.6	0.6	
	16-40UN			16-40UN			40	9.525	16	0.37	0.6	0.6	
	16-36UN			16-36UN			36	9.525	16	0.41	0.6	0.6	
	16-32UN			16-32UN			32	9.525	16	0.51	0.6	0.6	
	16-28UN	●		16-28UN			28	9.525	16	0.52	0.6	0.7	
	16-27UN			16-27UN			27	9.525	16	0.54	0.7	0.8	
	16-24UN			16-24UN			24	9.525	16	0.61	0.7	0.8	
	16-20UN	●		16-20UN			20	9.525	16	0.73	0.8	0.9	
	16-18UN		●	16-18UN			18	9.525	16	0.81	0.8	1.0	
	16-16UN	●	●	16-16UN			16	9.525	16	0.92	0.9	1.1	
	16-14UN	●		16-14UN			14	9.525	16	1.05	0.9	1.2	
	16-13UN			16-13UN			13	9.525	16	1.13	1.0	1.3	
	16-12UN	●	●	16-12UN			12	9.525	16	1.22	1.1	1.4	
	16-11.5UN	●		16-11.5UN			11.5	9.525	16	1.28	1.1	1.5	
	16-11UN	●	●	16-11UN			11	9.525	16	1.33	1.1	1.5	
	16-10UN	●		16-10UN	●		10	9.525	16	1.47	1.1	1.5	
	16-9UN	●	●	16-9UN			9	9.525	16	1.63	1.2	1.7	
	16-8UN	●	●	16-8UN	●		8	9.525	16	1.83	1.2	1.5	
	22-7UN			22-7UN			7	12.7	22	2.09	1.6	2.3	
	22-6UN			22-6UN			6	12.7	22	2.44	1.6	2.3	
	22-5UN			22-5UN			5	12.7	22	2.93	1.7	2.3	
	27-4.5UN			27-4.5UN			4.5	15.875	27	3.26	1.9	2.4	
	27-4UN			27-4UN			4	15.875	27	3.67	2.1	2.7	

➔ Applicable holders D32

● Stock item

Whitworth (BSW, BSF, BSP, BSB)

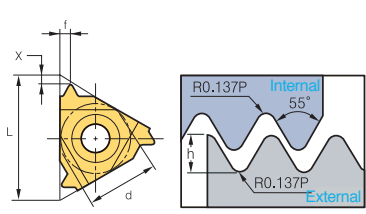
Type	Designation (Right)	PC3030T	PC9070T	Designation (Left)	PC3030T	PC9070T	Pitch (tpi)	Dimensions (mm)					Picture
								d	L	hmin	X	f	
External	ER 11-72W	●		EL 11-72W			72	6.35	11	0.23	0.7	0.4	
	11-60W	●		11-60W			60	6.35	11	0.27	0.7	0.4	
	11-56W	●		11-56W			56	6.35	11	0.29	0.7	0.4	
	11-48W	●		11-48W			48	6.35	11	0.34	0.6	0.6	
	11-40W	●		11-40W			40	6.35	11	0.41	0.6	0.6	
	11-36W	●		11-36W			36	6.35	11	0.45	0.6	0.6	
	11-32W	●		11-32W			32	6.35	11	0.51	0.6	0.6	
	11-28W	●		11-28W			28	6.35	11	0.58	0.6	0.7	
	11-26W	●		11-26W			26	6.35	11	0.63	0.7	0.8	
	11-24W	●		11-24W			24	6.35	11	0.68	0.7	0.8	
	11-22W	●		11-22W			22	6.35	11	0.74	0.8	0.9	
	11-20W	●		11-20W			20	6.35	11	0.81	0.8	0.9	
	11-19W			11-19W			19	6.35	11	0.86	0.8	1.0	
	11-18W	●		11-18W			18	6.35	11	0.90	0.8	1.0	
	11-16W	●		11-16W			16	6.35	11	1.02	0.9	1.1	
	11-14W			11-14W			14	6.35	11	1.16	1.0	1.2	
	16-72W	●		16-72W			72	9.525	16	0.23	0.7	0.4	
	16-60W	●		16-60W			60	9.525	16	0.27	0.7	0.4	
	16-56W	●		16-56W			56	9.525	16	0.29	0.7	0.4	
	16-48W	●		16-48W			48	9.525	16	0.34	0.6	0.6	
	16-40W	●		16-40W			40	9.525	16	0.41	0.6	0.6	
	16-36W	●		16-36W			36	9.525	16	0.45	0.6	0.6	
	16-32W	●		16-32W			32	9.525	16	0.51	0.6	0.6	
	16-30W	●		16-30W			30	9.525	16	0.55	0.6	0.7	
	16-28W	●	●	16-28W			28	9.525	16	0.58	0.6	0.7	
	16-26W	●		16-26W			26	9.525	16	0.63	0.7	0.8	
	16-24W	●		16-24W			24	9.525	16	0.68	0.7	0.8	
	16-22W	●		16-22W			22	9.525	16	0.74	0.8	0.9	
	16-20W	●		16-20W			20	9.525	16	0.81	0.8	0.9	
	16-19W	●	●	16-19W			19	9.525	16	0.86	0.8	1.0	
	16-18W	●		16-18W			18	9.525	16	0.90	0.8	1.0	
	16-16W	●		16-16W			16	9.525	16	1.02	0.9	1.1	
	16-14W	●	●	16-14W			14	9.525	16	1.16	1.0	1.2	
	16-12W	●		16-12W			12	9.525	16	1.36	1.1	1.4	
	16-11W	●	●	16-11W			11	9.525	16	1.48	1.1	1.5	
	16-10W	●		16-10W			10	9.525	16	1.63	1.1	1.5	
	16-9W	●		16-9W			9	9.525	16	1.81	1.2	1.7	
	16-8W	●		16-8W			8	9.525	16	2.03	1.2	1.5	
	22-7W	●		22-7W			7	12.7	22	3.32	1.6	2.3	
	22-6W	●		22-6W	●		6	12.7	22	2.71	1.6	2.3	
	22-5W	●		22-5W			5	12.7	22	3.25	1.7	2.4	
	27-4.5W	●		27-4.5W			4.5	15.875	27	3.61	1.8	2.6	
	27-4W			27-4W			4	15.875	27	4.07	2.0	2.9	

Applicable holders D31

●: Stock item

Whitworth (M chip breaker) **new**

Type	Designation (Right)	PC3030T	PC5300	Designation (Left)	PC3030T	Pitch (tpi)	Dimensions (mm)					Picture
							d	L	hmin	X	f	
External	ERM 16-11W	●				14	9.525	16	1.16	1.0	1.2	
	16-14W	●				11	9.525	16	1.48	1.1	1.5	
	16-19W	●					19	9.525	16	0.86	0.8	

↻ Applicable holders D31

● Stock item

Whitworth (U chip breaker) **new**

Type	Designation (Right)	PC3030T	PC5300	Designation (Left)	PC3030T	Pitch (tpi)	Dimensions (mm)					Picture
							d	L	hmin	X	f	
External	ERM 16-14W-U					14	9.525	16	1.16	1.0	1.2	
	16-11W-U					11	9.525	16	1.48	1.1	1.5	

↻ Applicable holders D31

● Stock item

Whitworth (BSW, BSF, BSP, BSB)

Type	Designation (Right)	PC3030T	PC9070T	Designation (Left)	PC3030T	PC9070T	Pitch (tpi)	Dimensions (mm)					Picture
								d	L	hmin	X	f	
Internal	IR 11-72W	●		IL 11-72W			72	6.35	11	0.23	0.7	0.4	
	11-60W	●		11-60W			60	6.35	11	0.27	0.7	0.4	
	11-56W	●		11-56W			56	6.35	11	0.29	0.7	0.4	
	11-48W	●		11-48W			48	6.35	11	0.34	0.6	0.6	
	11-40W	●		11-40W			40	6.35	11	0.41	0.6	0.6	
	11-36W	●		11-36W			36	6.35	11	0.45	0.6	0.6	
	11-32W	●		11-32W			32	6.35	11	0.51	0.6	0.6	
	11-28W	●		11-28W			28	6.35	11	0.58	0.6	0.7	
	11-26W	●		11-26W			26	6.35	11	0.63	0.7	0.8	
	11-24W	●		11-24W			24	6.35	11	0.68	0.7	0.8	
	11-22W	●		11-22W			22	6.35	11	0.74	0.8	0.9	
	11-20W			11-20W			20	6.35	11	0.81	0.8	0.9	
	11-19W	●	●	11-19W	●		19	6.35	11	0.86	0.8	1.0	
	11-18W	●		11-18W	●		18	6.35	11	0.90	0.8	1.0	
	11-16W	●		11-16W	●		16	6.35	11	1.02	0.9	1.1	
	11-14W	●		11-14W	●		14	6.35	11	1.16	0.9	1.1	
	11-12W	●		11-12W	●		12	6.35	11	1.32	0.9	1.2	
	16-72W	●		16-72W			72	9.525	16	0.23	0.7	0.4	
	16-60W	●		16-60W			60	9.525	16	0.27	0.7	0.4	
	16-56W	●		16-56W			56	9.525	16	0.29	0.7	0.4	
	16-48W	●		16-48W			48	9.525	16	0.34	0.6	0.6	
	16-40W	●		16-40W			40	9.525	16	0.41	0.6	0.6	
	16-36W	●		16-36W			36	9.525	16	0.45	0.6	0.6	
	16-32W	●		16-32W			32	9.525	16	0.51	0.6	0.6	
	16-30W	●		16-30W			30	9.525	16	0.55	0.6	0.7	
	16-28W	●		16-28W			28	9.525	16	0.58	0.6	0.7	
	16-26W	●		16-26W			26	9.525	16	0.63	0.7	0.8	
	16-24W	●		16-24W			24	9.525	16	0.68	0.7	0.8	
	16-22W	●		16-22W			22	9.525	16	0.74	0.8	0.9	
	16-20W	●		16-20W			20	9.525	16	0.81	0.8	0.9	
	16-19W	●		16-19W			19	9.525	16	0.86	0.8	1.0	
	16-18W	●		16-18W			18	9.525	16	0.90	0.8	1.0	
	16-16W			16-16W			16	9.525	16	1.02	0.9	1.1	
	16-14W	●	●	16-14W			14	9.525	16	1.16	1.0	1.2	
	16-12W	●		16-12W			12	9.525	16	1.36	1.1	1.4	
	16-11W	●	●	16-11W			11	9.525	16	1.48	1.1	1.5	
	16-10W	●		16-10W			10	9.525	16	1.63	1.1	1.5	
	16-9W	●		16-9W			9	9.525	16	1.81	1.2	1.7	
	16-8W	●		16-8W			8	9.525	16	2.03	1.2	1.5	
	22-7W			22-7W			7	12.7	22	3.32	1.6	2.3	
	22-6W	●		22-6W			6	12.7	22	2.71	1.6	2.3	
	22-5W	●		22-5W			5	12.7	22	3.25	1.7	2.4	
	27-4.5W	●		27-4.5W			4.5	15.875	27	3.61	1.8	2.6	
	27-4W	●		27-4W			4	15.875	27	4.07	2.0	2.9	

Applicable holders D32

●: Stock item



Whitworth (M chip breaker) **new**

Type	Designation (Right)	PC3030T	PC5300	Designation (Left)	PC3030T	Pitch (tpi)	Dimensions (mm)					Picture
							d	L	hmin	X	f	
Internal	IRM 16-14W					14	9.525	16	1.16	1.0	1.2	
	16-11W	●				11	9.525	16	1.48	1.1	1.5	

➔ Applicable holders D32

● Stock item

Whitworth (U chip breaker) **new**

Type	Designation (Right)	PC3030T	PC5300	Designation (Left)	PC3030T	Pitch (tpi)	Dimensions (mm)					Picture
							d	L	hmin	X	f	
Internal	IRM 16-14W-U					14	9.525	16	1.16	1.0	1.2	
	16-11W-U					11	9.525	16	1.48	1.1	1.5	

➔ Applicable holders D32

● Stock item

British Standard Pipe Thread (BSPT)

Type	Designation (Right)	PC3030T	PC9070T	Designation (Left)	PC3030T	PC9070T	Pitch (tpi)	Dimensions (mm)					Picture
								d	L	hmin	X	f	
External	ER 11-28BSPT			EL 11-28BSPT			28	6.35	11	0.58	0.6	0.6	
	11-19BSPT			11-19BSPT			19	6.35	11	0.86	0.8	0.9	
	11-14BSPT			11-14BSPT			14	6.35	11	1.16	0.9	1.0	
	16-28BSPT			16-28BSPT			28	9.525	16	0.58	0.6	0.6	
	16-19BSPT	●	●	16-19BSPT			19	9.525	16	0.86	0.8	0.9	
	16-14BSPT		●	16-14BSPT			14	9.525	16	1.16	1.0	1.2	
	16-11BSPT	●	●	16-11BSPT			11	9.525	16	1.48	1.1	1.5	
Internal	IR 11-28BSPT			IL 11-28BSPT			28	6.35	11	0.58	0.6	0.6	
	11-19BSPT		●	11-19BSPT			19	6.35	11	0.86	0.8	0.9	
	11-14BSPT		●	11-14BSPT			14	6.35	11	1.16	0.9	1.0	
	16-28BSPT			16-28BSPT			28	9.525	16	0.58	0.6	0.6	
	16-19BSPT	●	●	16-19BSPT			19	9.525	16	0.86	0.8	0.9	
	16-14BSPT	●	●	16-14BSPT			14	9.525	16	1.16	1.0	1.2	
	16-11BSPT		●	16-11BSPT			11	9.525	16	1.48	1.1	1.5	

Applicable holders D31, D32

●: Stock item

National Pipe Thread (NPT)

Type	Designation (Right)	PC3030T	PC9070T	Designation (Left)	PC3030T	PC9070T	Pitch (tpi)	Dimensions (mm)					Picture
								d	L	hmin	X	f	
External	ER 11-27NPT	●		EL 11-27NPT			27	6.35	11	0.66	0.7	0.8	
	11-18NPT	●		11-18NPT			18	6.35	11	1.01	0.8	1.0	
	11-14NPT	●		11-14NPT			14	6.35	11	1.33	0.8	1.0	
	16-27NPT	●		16-27NPT			27	9.525	16	0.66	0.7	0.8	
	16-18NPT	●	●	16-18NPT			18	9.525	16	1.01	0.8	1.0	
	16-14NPT	●	●	16-14NPT			14	9.525	16	1.33	0.9	1.2	
	16-11.5NPT	●		16-11.5NPT			11.5	9.525	16	1.64	1.1	1.5	
	16-8NPT	●		16-8NPT			8	9.525	16	2.42	1.3	1.8	
Internal	IR 11-27NPT	●		IL 11-27NPT			27	6.35	11	0.66	0.7	0.8	
	11-18NPT	●		11-18NPT			18	6.35	11	1.01	0.8	1.0	
	11-14NPT	●	●	11-14NPT	●		14	6.35	11	1.33	0.8	1.0	
	16-27NPT	●		16-27NPT			27	9.525	16	0.66	0.7	0.8	
	16-18NPT	●		16-18NPT			18	9.525	16	1.01	0.8	1.0	
	16-14NPT	●	●	16-14NPT			14	9.525	16	1.33	0.9	1.2	
	16-11.5NPT	●	●	16-11.5NPT	●		11.5	9.525	16	1.64	1.1	1.5	
	16-8NPT			16-8NPT	●		8	9.525	16	2.42	1.3	1.8	

Applicable holders D31, D32

●: Stock item



National Pipe Threads-Dryseal (NPTF)

Type	Designation (Right)	PC3030T	PC9070T	Designation (Left)	PC3030T	PC9070T	Pitch (tpi)	Dimensions (mm)					Picture
								d	L	hmin	X	f	
External	ER 11-27NPTF			EL 11-27NPTF			27	6.35	11	0.64	0.7	0.8	
	11-18NPTF			11-18NPTF			18	6.35	11	1.00	0.8	1.0	
	11-14NPTF			11-14NPTF			14	6.35	11	1.35	0.8	1.0	
	16-27NPTF			16-27NPTF			27	9.525	16	0.64	0.7	0.8	
	16-18NPTF	●		16-18NPTF			18	9.525	16	1.00	0.8	1.0	
	16-14NPTF			16-14NPTF			14	9.525	16	1.35	0.9	1.2	
	16-11.5NPTF			16-11.5NPTF			11.5	9.525	16	1.63	1.1	1.5	
	16-8NPTF			16-8NPTF	●		8	9.525	16	2.38	1.3	1.8	
Internal	IR 11-27NPTF			IL 11-27NPTF			27	6.35	11	0.64	0.7	0.8	
	11-18NPTF			11-18NPTF			18	6.35	11	1.00	0.8	1.0	
	11-14NPTF			11-14NPTF			14	6.35	11	1.35	0.8	1.0	
	16-27NPTF			16-27NPTF			27	9.525	16	0.64	0.7	0.8	
	16-18NPTF			16-18NPTF			18	9.525	16	1.00	0.8	1.0	
	16-14NPTF			16-14NPTF			14	9.525	16	1.35	0.9	1.2	
	16-11.5NPTF			16-11.5NPTF			11.5	9.525	16	1.63	1.1	1.5	
	16-8NPTF			16-8NPTF			8	9.525	16	2.38	1.3	1.8	

➔ Applicable holders D31, D32

● Stock item

Round DIN 405

Type	Designation (Right)	PC3030T	PC9070T	Designation (Left)	PC3030T	PC9070T	Pitch (tpi)	Dimensions (mm)					Picture
								d	L	hmin	X	f	
External	ER 16-10RD			EL 16-10RD			10	9.525	16	1.27	1.1	1.2	
	16-8RD	●		16-8RD			8	9.525	16	1.59	1.4	1.3	
	16-6RD	●		16-6RD			6	9.525	16	2.12	1.5	1.7	
	22-6RD			22-6RD			6	12.7	22	2.12	1.5	1.7	
	22-4RD	●		22-4RD			4	12.7	22	3.18	2.2	2.3	
	27-4RD			27-4RD			4	15.875	27	3.18	2.2	2.3	
Internal	IR 16-10RD			IL 16-10RD			10	9.525	16	1.27	1.1	1.2	
	16-8RD			16-8RD			8	9.525	16	1.59	1.4	1.4	
	16-6RD	●		16-6RD			6	9.525	16	2.12	1.4	1.5	
	22-6RD			22-6RD			6	12.7	22	2.12	1.5	1.7	
	22-4RD	●		22-4RD			4	12.7	22	3.18	2.2	2.3	
	27-4RD			27-4RD			4	15.875	27	3.18	2.2	2.3	

➔ Applicable holders D31, D32

● Stock item

Trapez DIN 103 (TR)

Type	Designation (Right)	PC3030T	PC9070T	Designation (Left)	PC3030T	PC9070T	Pitch (mm)	Dimensions (mm)					Picture
								d	L	hmin	X	f	
External	ER 11-1.5TR	●		EL 11-1.5TR	●		1.5	6.35	11	0.90	0.8	0.9	
	16-1.5TR			16-1.5TR			1.5	9.525	16	0.90	1.0	1.1	
	16-2.0TR	●		16-2.0TR	●		2.0	9.525	16	1.25	1.1	1.3	
	16-3.0TR	●	●	16-3.0TR	●		3.0	9.525	16	1.75	1.3	1.5	
	22-4.0TR	●	●	22-4.0TR	●		4.0	12.7	22	2.25	1.7	1.9	
	22-5.0TR	●	●	22-5.0TR	●		5.0	12.7	22	2.75	2.1	2.5	
	27-6.0TR	●	●	27-6.0TR	●		6.0	15.875	27	3.50	2.3	2.7	
Internal	IR 11-1.5TR			IL 11-1.5TR	●		1.5	6.35	11	0.90	0.8	0.9	
	16-1.5TR	●		16-1.5TR	●		1.5	9.525	16	0.90	1.0	1.1	
	16-2.0TR	●		16-2.0TR	●		2.0	9.525	16	1.25	1.1	1.3	
	16-2.5TR	●		16-2.5TR	●		2.5	9.525	16	1.53	1.2	1.4	
	16-3.0TR	●		16-3.0TR	●		3.0	9.525	16	1.75	1.3	1.5	
	22-4.0TR	●	●	22-4.0TR	●		4.0	12.7	22	2.25	1.7	1.9	
	22-5.0TR	●	●	22-5.0TR	●		5.0	12.7	22	2.75	2.1	2.5	
	27-6.0TR	●	●	27-6.0TR	●		6.0	15.875	27	3.50	2.3	2.7	

Applicable holders D31, D32

● Stock item

American ACME (ACME)

Type	Designation (Right)	PC3030T	PC9070T	Designation (Left)	PC3030T	PC9070T	Pitch (tpi)	Dimensions (mm)					Picture
								d	L	hmin	X	f	
External	ER 11-16ACME			EL 11-16ACME			16	6.35	11	0.92	1.0	1.1	
	16-16ACME			16-16ACME			16	9.525	16	0.92	1.0	1.1	
	16-14ACME			16-14ACME			14	9.525	16	1.03	1.0	1.2	
	16-12ACME			16-12ACME			12	9.525	16	1.19	1.1	1.2	
	16-10ACME	●		16-10ACME			10	9.525	16	1.52	1.3	1.4	
	16-8ACME			16-8ACME			8	9.525	16	1.84	1.4	1.5	
	16-6ACME			16-6ACME			6	9.525	16	2.37	1.7	1.9	
	22-6ACME	●		22-6ACME	●		6	12.7	22	2.37	1.8	2.1	
	22-5ACME	●		22-5ACME	●		5	12.7	22	2.79	2.0	2.3	
	27-4ACME			27-4ACME			4	15.875	27	3.43	2.4	2.7	
Internal	IR 11-16ACME			IL 11-16ACME			16	6.35	11	0.92	0.9	0.9	
	16-16ACME			16-16ACME			16	9.525	16	0.92	1.0	1.1	
	16-14ACME			16-14ACME			14	9.525	16	1.03	1.1	1.2	
	16-12ACME			16-12ACME			12	9.525	16	1.19	1.2	1.3	
	16-10ACME			16-10ACME			10	9.525	16	1.52	1.2	1.3	
	16-8ACME	●		16-8ACME			8	9.525	16	1.84	1.4	1.5	
	16-6ACME			16-6ACME			6	9.525	16	2.37	1.7	1.9	
	22-6ACME	●		22-6ACME			6	12.7	22	2.37	1.8	2.1	
	22-5ACME	●		22-5ACME			5	12.7	22	2.79	2.0	2.3	
	27-4ACME	●		27-4ACME			4	15.875	27	3.43	2.3	2.6	

Applicable holders D31, D32

● Stock item



Stub ACME (STACME)

Type	Designation (Right)	PC3030T	PC9070T	Designation (Left)	PC3030T	PC9070T	Pitch (tpi)	Dimensions (mm)					Picture
								d	L	hmin	X	f	
External	ER 11-16STACME			EL 11-16STACME			16	6.35	11	0.60	1.0	1.0	
	16-16STACME			16-16STACME			16	9.525	16	0.60	1.0	1.0	
	16-14STACME			16-14STACME			14	9.525	16	0.67	1.1	1.1	
	16-12STACME			16-12STACME			12	9.525	16	0.76	1.2	1.2	
	16-10STACME			16-10STACME			10	9.525	16	1.02	1.2	1.3	
	16-8STACME			16-8STACME			8	9.525	16	1.21	1.4	1.5	
	16-6STACME			16-6STACME			6	9.525	16	1.52	1.7	1.8	
	22-6STACME			22-6STACME			6	12.7	22	1.52	1.7	1.8	
	22-5STACME			22-5STACME			5	12.7	22	1.78	2.1	2.3	
	27-4STACME			27-4STACME			4	15.875	27	2.16	2.3	2.4	
	27-3STACME			27-3STACME			3	15.875	27	2.79	2.9	2.9	
	Internal	IR 11-16STACME			IL 11-16STACME			16	6.35	11	0.60	1.0	
16-16STACME				16-16STACME			16	9.525	16	0.60	1.0	1.0	
16-14STACME				16-14STACME			14	9.525	16	0.67	1.1	1.1	
16-12STACME				16-12STACME			12	9.525	16	0.76	1.1	1.2	
16-10STACME				16-10STACME			10	9.525	16	1.02	1.2	1.3	
16-8STACME				16-8STACME			8	9.525	16	1.21	1.4	1.5	
16-6STACME				16-6STACME			6	9.525	16	1.52	1.7	1.8	
22-6STACME				22-6STACME			6	12.7	22	1.52	1.7	1.8	
22-5STACME				22-5STACME			5	12.7	22	1.78	2.1	2.3	
27-4STACME				27-4STACME			4	15.875	27	2.16	2.3	2.4	
27-3STACME				27-3STACME			3	15.875	27	2.79	2.9	2.9	

↻ Applicable holders D31, D32

● Stock item

UNJ (Unified constant thread)

Type	Designation (Right)	PC3030T	PC9070T	Designation (Left)	PC3030T	PC9070T	Pitch (tpi)	Dimensions (mm)					Picture
								d	L	hmin	X	f	
External	ER 11-48UNJ			EL 11-48UNJ			48	6.35	11	0.31	0.6	0.5	
	11-44UNJ			11-44UNJ			44	6.35	11	0.33	0.6	0.6	
	11-40UNJ			11-40UNJ			40	6.35	11	0.37	0.6	0.6	
	11-36UNJ			11-36UNJ			36	6.35	11	0.41	0.6	0.6	
	11-32UNJ			11-32UNJ			32	6.35	11	0.46	0.6	0.7	
	11-28UNJ			11-28UNJ			28	6.35	11	0.52	0.7	0.7	
	11-24UNJ	●		11-24UNJ			24	6.35	11	0.61	0.7	0.8	
	11-20UNJ			11-20UNJ			20	6.35	11	0.73	0.8	0.9	
	11-18UNJ			11-18UNJ			18	6.35	11	0.81	0.8	1.0	
	11-16UNJ			11-16UNJ			16	6.35	11	0.92	0.9	1.1	
	11-14UNJ			11-14UNJ			14	6.35	11	1.05	1.0	1.2	
	16-48UNJ			16-48UNJ			48	9.525	16	0.31	0.6	0.5	
	16-44UNJ			16-44UNJ			44	9.525	16	0.33	0.6	0.6	
	16-40UNJ			16-40UNJ			40	9.525	16	0.37	0.6	0.6	
	16-36UNJ			16-36UNJ			36	9.525	16	0.41	0.6	0.6	
	16-32UNJ	●		16-32UNJ			32	9.525	16	0.46	0.6	0.7	
	16-28UNJ	●		16-28UNJ			28	9.525	16	0.52	0.7	0.7	
	16-24UNJ	●		16-24UNJ			24	9.525	16	0.61	0.7	0.8	
	16-20UNJ	●		16-20UNJ			20	9.525	16	0.73	0.8	0.9	
	16-18UNJ			16-18UNJ			18	9.525	16	0.81	0.8	1.0	
	16-16UNJ	●		16-16UNJ			16	9.525	16	0.92	0.9	1.1	
	16-14UNJ			16-14UNJ			14	9.525	16	1.05	1.0	1.2	
	16-13UNJ			16-13UNJ			13	9.525	16	1.13	1.0	1.3	
	16-12UNJ	●		16-12UNJ			12	9.525	16	1.22	1.1	1.3	
	16-11UNJ			16-11UNJ			11	9.525	16	1.33	1.2	1.5	
	16-10UNJ			16-10UNJ	●		10	9.525	16	1.47	1.2	1.5	
	16-9UNJ			16-9UNJ			9	9.525	16	1.63	1.3	1.7	
	16-8UNJ			16-8UNJ			8	9.525	16	1.83	1.2	1.6	
	22-7UNJ			22-7UNJ			7	12.7	22	2.09	1.7	2.3	
	22-6UNJ			22-6UNJ			6	12.7	22	2.44	1.7	2.3	
	22-5UNJ			22-5UNJ			5	12.7	22	2.93	1.8	2.5	
	27-4.5UNJ			27-4.5UNJ			4.5	15.875	27	3.26	2.0	2.7	
	27-4UNJ			27-4UNJ			4	15.875	27	3.67	2.2	3.0	

➔ Applicable holders D31

●: Stock item

UNJ (Unified constant thread)

Type	Designation (Right)	PC3030T	PC9070T	Designation (Left)	PC3030T	PC9070T	Pitch (tpi)	Dimensions (mm)					Picture
								d	L	hmin	X	f	
Internal	IR 11-48UNJ			IL 11-48UNJ			48	6.35	11	0.28	0.6	0.5	
	11-44UNJ			11-44UNJ			44	6.35	11	0.30	0.6	0.6	
	11-40UNJ			11-40UNJ			40	6.35	11	0.33	0.6	0.6	
	11-36UNJ			11-36UNJ			36	6.35	11	0.37	0.6	0.6	
	11-32UNJ			11-32UNJ			32	6.35	11	0.42	0.6	0.7	
	11-28UNJ			11-28UNJ			28	6.35	11	0.47	0.7	0.7	
	11-24UNJ			11-24UNJ			24	6.35	11	0.55	0.7	0.8	
	11-20UNJ			11-20UNJ			20	6.35	11	0.66	0.8	0.9	
	11-18UNJ			11-18UNJ			18	6.35	11	0.74	0.8	1.0	
	11-16UNJ			11-16UNJ			16	6.35	11	0.83	0.9	1.1	
	11-14UNJ			11-14UNJ			14	9.525	11	0.95	1.0	1.2	
	16-48UNJ			16-48UNJ			48	9.525	16	0.28	0.6	0.5	
	16-44UNJ			16-44UNJ			44	9.525	16	0.30	0.6	0.6	
	16-40UNJ			16-40UNJ			40	9.525	16	0.33	0.6	0.6	
	16-36UNJ			16-36UNJ			36	9.525	16	0.37	0.6	0.6	
	16-32UNJ			16-32UNJ			32	9.525	16	0.42	0.6	0.7	
	16-28UNJ			16-28UNJ			28	9.525	16	0.47	0.7	0.7	
	16-24UNJ			16-24UNJ			24	9.525	16	0.55	0.7	0.8	
	16-20UNJ			16-20UNJ			20	9.525	16	0.66	0.8	0.9	
	16-18UNJ			16-18UNJ			18	9.555	16	0.74	0.8	1.0	
	16-16UNJ			16-16UNJ			16	9.525	16	0.83	0.9	1.1	
	16-14UNJ			16-14UNJ			14	9.525	16	0.95	1.0	1.2	
	16-13UNJ			16-13UNJ			13	9.525	16	1.02	1.0	1.3	
	16-12UNJ			16-12UNJ	●		12	9.525	16	1.11	1.1	1.3	
	16-11UNJ			16-11UNJ			11	9.525	16	1.21	1.2	1.5	
	16-10UNJ			16-10UNJ			10	9.525	16	1.33	1.2	1.5	
	16-9UNJ			16-9UNJ			9	9.525	16	1.48	1.3	1.7	
	16-8UNJ			16-8UNJ			8	9.525	16	1.66	1.2	1.6	
	22-7UNJ			22-7UNJ			7	12.7	22	1.90	1.7	2.3	
	22-6UNJ			22-6UNJ			6	12.7	22	2.21	1.7	2.3	
	22-5UNJ			22-5UNJ			5	12.7	22	2.66	1.8	2.5	
	27-4.5UNJ			27-4.5UNJ			4.5	15.875	27	2.95	2.0	2.7	
	27-4UNJ			27-4UNJ			4	15.875	27	3.32	2.2	3.0	

➤ Applicable holders D32

● Stock item

American Buttress (ABUT)

Type	Designation (Right)	PC3030T	PC9070T	Designation (Left)	PC3030T	PC9070T	Pitch (tpi)	Dimensions (mm)					Picture
								d	L	hmin	X	f	
External	ER 11-20ABUT			EL 11-20ABUT			20	6.35	11	0.84	1.0	1.4	
	11-16ABUT			11-16ABUT			16	6.35	11	1.05	1.3	1.9	
	16-20ABUT	●		16-20ABUT			20	9.525	16	0.84	1.0	1.4	
	16-16ABUT			16-16ABUT			16	9.525	16	1.05	1.3	1.9	
	16-12ABUT			16-12ABUT			12	9.525	16	1.40	1.4	2.0	
	16-10ABUT			16-10ABUT			10	9.525	16	1.68	1.5	2.3	
	22-8ABUT			22-8ABUT			8	12.7	22	2.10	2.0	3.2	
	22-6ABUT			22-6ABUT			6	12.7	22	2.80	2.2	3.5	
Internal	IR 11-20ABUT			IL 11-20ABUT			20	6.35	11	0.84	1.0	1.4	
	11-16ABUT			11-16ABUT			16	6.35	11	1.05	1.3	1.9	
	16-20ABUT	●		16-20ABUT			20	9.525	16	0.84	1.0	1.4	
	16-16ABUT			16-16ABUT			16	9.525	16	1.05	1.3	1.9	
	16-12ABUT			16-12ABUT			12	9.525	16	1.40	1.4	2.0	
	16-10ABUT	●		16-10ABUT			10	9.525	16	1.68	1.5	2.3	
	22-8ABUT			22-8ABUT			8	12.7	22	2.10	2.0	3.2	
	22-6ABUT			22-6ABUT			6	12.7	22	2.80	2.2	3.5	

➔ Applicable holders D31, D32

● Stock item

British Buttress (BBUT)

Type	Designation (Right)	PC3030T	PC9070T	Designation (Left)	PC3030T	PC9070T	Pitch (tpi)	Dimensions (mm)					Picture
								d	L	hmin	X	f	
External	ER 16-16BBUT	●		EL 16-16BBUT			16	9.525	16	0.80	1.1	1.6	
	16-12BBUT			16-12BBUT			12	9.525	16	1.07	1.4	2.1	
	16-10BBUT			16-10BBUT			10	9.525	16	1.28	1.4	2.2	
	16-8BBUT	●		16-8BBUT			8	9.525	16	1.61	1.6	2.5	
	22-8BBUT			22-8BBUT			8	12.7	22	1.61	1.6	2.5	
Internal	IR 16-16BBUT	●		IL 16-16BBUT			16	9.525	16	0.80	1.1	1.6	
	16-12BBUT			16-12BBUT			12	9.525	16	1.07	1.4	2.1	
	16-10BBUT			16-10BBUT			10	9.525	16	1.28	1.4	2.2	
	16-8BBUT			16-8BBUT			8	9.525	16	1.61	1.6	2.5	
	22-8BBUT			22-8BBUT			8	12.7	22	1.61	1.6	2.5	

➔ Applicable holders D31, D32

● Stock item



Metric Buttress (SAGE)

Type	Designation (Right)	PC3030T	PC9070T	Designation (Left)	PC3030T	PC9070T	Pitch (mm)	Dimensions (mm)					Picture
								d	L	hmin	X	f	
External	ER 16-2.0SAGE			EL 16-2.0SAGE			2.0	9.525	16	1.74	1.47	2.08	
	22-2.0SAGE			22-2.0SAGE			2.0	12.7	22	1.74	1.47	2.08	
	22-3.0SAGE	●		22-3.0SAGE			3.0	12.7	22	2.60	1.79	2.60	
	27-4.0SAGE	●		27-4.0SAGE			4.0	15.875	27	3.55	1.93	3.20	
Internal	IR 16-2.0SAGE	●		IL 16-2.0SAGE			2.0	9.525	16	1.50	1.52	2.2	
	22-3.0SAGE			22-3.0SAGE			3.0	12.7	22	2.25	1.66	2.9	
	27-4.0SAGE	●		27-4.0SAGE			4.0	5/8	27	3.09	2.12	3.2	

➔ Applicable holders D31, D32

● Stock item

API

Type	Designation (Right)	PC3030T	PC9070T	Designation (Left)	PC3030T	PC9070T	Pitch (tpi)	Dimensions (mm)					Picture
								d	L	hmin	X	f	
External	ER 22-4API382	●		EL 22-4API382			4	12.7	22	3.09	2.1	2.8	
	22-4API383			22-4API383			4	12.7	22	3.08	2.1	2.8	
	22-4API502	●		22-4API502			4	12.7	22	3.75	2.0	2.9	
	22-4API503	●		22-4API503			4	12.7	22	3.74	2.0	2.9	
	22-5API403			22-5API403			5	12.7	22	2.99	1.8	2.6	
	22-6API551			22-6API551			6	12.7	22	1.41	2.6	2.0	
	27-4API382			27-4API382			4	15.875	27	3.09	2.1	2.8	
	27-4API383			27-4API383			4	15.875	27	3.08	2.1	2.8	
	27-4API502			27-4API502			4	15.875	27	3.75	2.1	3.1	
	27-4API503	●		27-4API503			4	15.875	27	3.74	2.1	3.1	
	27-5API403			27-5API403			5	15.875	27	2.99	1.9	2.7	
Internal	IR 22-4API382			IL 22-4API382			4	12.7	22	3.09	2.1	2.8	
	22-4API383			22-4API383			4	12.7	22	3.08	2.1	2.8	
	22-4API502	●		22-4API502			4	12.7	22	3.75	2.1	3.1	
	22-4API503			22-4API503			4	12.7	22	3.74	2.0	2.9	
	22-5API403	●		22-5API403			5	12.7	22	2.99	1.8	2.6	
	22-6API551	●		22-6API551			6	12.7	22	1.41	2.6	2.0	
	27-4API382			27-4API382			4	15.875	27	3.09	2.1	2.8	
	27-4API383	●		27-4API383			4	15.875	27	3.08	2.1	2.8	
	27-4API502	●		27-4API502			4	15.875	27	3.75	2.1	3.1	
	27-4API503	●		27-4API503			4	15.875	27	3.74	2.1	3.1	
	27-5API403	●		27-5API403			5	15.875	27	2.99	1.9	2.7	

➔ Applicable holders D31, D32

● Stock item

API Buttress Casing (BUT)

Type	Designation (Right)	PC3030T	PC9070T	Designation (Left)	PC3030T	PC9070T	Pitch (tpi)	Dimensions (mm)					Picture	
								IPF	d	L	hmin	X		f
External	ER 22-5BUT75			EL 22-5BUT75			5	0.75	12.7	22	1.55	3.1	1.9	
	22-5BUT1			22-5BUT1			5	1	12.7	22	1.55	3.1	1.9	
Internal	IR 22-5BUT75			IL 22-5BUT75			5	0.75	12.7	22	1.55	2.8	1.9	
	22-5BUT1	●		22-5BUT1			5	1	12.7	22	1.55	2.8	1.9	

Applicable holders D31, D32

● Stock item

API Round Casing & Tubing (APIRD)

Type	Designation (Right)	PC3030T	PC9070T	Designation (Left)	PC3030T	PC9070T	Pitch (tpi)	Dimensions (mm)					Picture
								d	L	hmin	X	f	
External	ER 16-10APIRD	●		EL 16-10APIRD			10	9.525	16	1.41	1.2	1.4	
	16-8APIRD	●		16-8APIRD			8	9.525	16	1.81	1.3	1.5	
Internal	IR 16-10APIRD	●		IL 16-10APIRD			10	9.525	16	1.41	1.2	1.4	
	16-8APIRD	●		16-8APIRD			8	9.525	16	1.81	1.3	1.5	

Applicable holders D31, D32

● Stock item

Extreme Line Casing (EL)

Type	Designation (Right)	PC3030T	PC9070T	Designation (Left)	PC3030T	PC9070T	Pitch (tpi)	Dimensions (mm)					Picture	
								IPF	d	L	hmin	X		f
External	ER 22-6EL15			EL 22-6EL15			6	1.5	12.7	22	1.21	1.9	1.9	
	22-5EL125			22-5EL125			5	1.25	12.7	22	1.71	2.3	2.4	
Internal	IR 22-6EL15			IL 22-6EL15			6	1.5	12.7	22	1.39	1.8	1.9	
	22-5EL125			22-5EL125			5	1.25	12.7	22	1.91	2.2	2.4	

Applicable holders D31, D32

● Stock item



ER(L)H

(Screw on system)

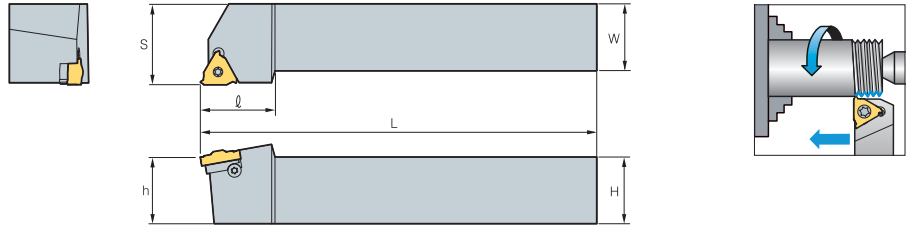

Righthand drawing

(mm)

Designation	Inscribed circle	H	W	L	S	H	ℓ	Insert screw	Shim screw	Screw RH	Screw LH	Wrench	
ER(L)H	08N-11	6.35	8	8	136.4	11	8	17.5					
	10N-11	6.35	10	10	70.0	11	10	17.5	ST11N	-	-	-	TW08P
	12N-11	6.35	12	12	80.0	12	12	17.5					
	12N-16	9.525	12	12	83.2	16	12	22	ST16N	-	-	-	TW10P
	09-16	9.525	9.52	9.52	63.6	16	9.52	20.5					
	12-16	9.525	12	12	83.2	16	12	22					
	16-16	9.525	16	16	100.0	16	16	20.5					
	20-16	9.525	20	20	128.6	20	20	30	ST16	STA16	ATE16	ATI22	TW10P
	25-16	9.525	25	25	153.6	25	25	30					
	32-16	9.525	32	32	173.6	32	32	30					
	25-22	12.7	25	25	155.7	25	25	36					
	32-22	12.7	32	32	175.7	32	32	36	ST22	STA22	ATE22	ATI22	TW20P
	40-22	12.7	40	40	205.7	40	40	36					
	25-27	15.875	25	25	151.6	32	25	35					
	32-27	15.875	32	32	176.6	32	32	40					
	40-27	15.875	40	40	206.6	40	40	40	ST27	STA27	ATE27	ATI27	TW25L
50-27	15.875	50	50	256.6	50	50	40						

↻ Applicable inserts D10~D13, D16, D18, D19, D22, D23~D26

• Helix angle is 1.5° for all holders

• No shim needed for N type holder

ER(L)H-C

(Clamp on system)

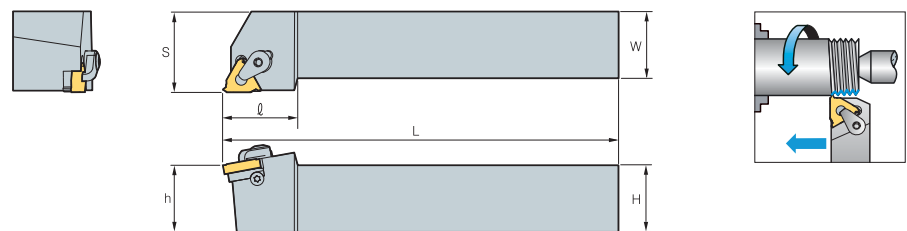

Righthand drawing

(mm)

Designation	Inscribed circle	H	W	L	S	H	ℓ	Shim screw	Clamp	Screw RH	Screw LH	Wrench	
ER(L)H	20-16C	9.525	20	20	128.6	20	20	30					
	25-16C	9.525	25	25	153.6	25	25	30	STA16	CTH16	ATE16	ATI16	TW10P
	32-16C	9.525	32	32	173.6	32	32	30					TW15P
	25-22C	12.7	25	25	155.7	25	25	36					
	32-22C	12.7	32	32	175.7	32	32	36	STA22	CTH22	ATE22	ATI22	TW20P
	40-22C	12.7	40	40	205.7	40	40	36					
	25-27C	15.875	25	25	151.6	25	25	35					
	32-27C	15.875	32	32	176.6	32	32	40					
	40-27C	15.875	40	40	206.6	40	40	40	STA27	CTH27	ATE27	ATI27	TW25L
	50-27C	15.875	50	50	256.6	50	50	40					

↻ Applicable inserts D10~D13, D16, D18, D19, D22, D23~D26

• Helix angle is 1.5° for all holders

IR(L)H (Screw on system)

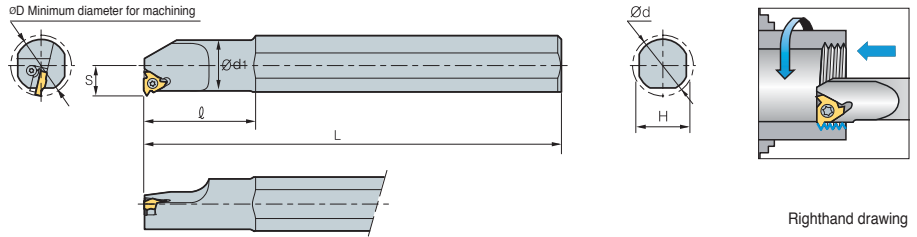

Righthand drawing
(mm)

Designation	Inscribed circle	ØD	Ød	Ød ₁	H	L	S	ℓ	Insert screw	Shim screw	Screw RH	Screw LH	Wrench
IR(L)H	10DN-11	6.35	13	10	10.0	9.5	100	7.3	-	-	-	-	-
	10N-11	6.35	13	20	10.0	18.0	180	7.3	ST11N	-	-	-	TW08P
	13N-11	6.35	16	20	13.0	18.0	180	8.9	-	-	-	-	-
	13N-16	9.525	17	20	12.7	18.0	180	10.3	-	-	-	-	-
	16N-16	9.525	20	20	16.0	18.0	180	11.5	ST16N	-	-	-	TW10P
	16DN-16	9.525	20	16	16.0	15.2	150	11.3	-	-	-	-	-
	20-16	9.525	24	20	20.0	18.0	180	13.4	-	-	-	-	-
	25-16	9.525	29	32	25.0	29.0	250	16.3	-	-	-	-	-
	25D-16	9.525	29	25	24.5	22.6	200	16.1	ST16	STA16	ATI16	ATE16	TW10P
	32-16	9.525	36	32	32.0	29.0	250	19.6	-	-	-	-	-
	40-16	9.525	44	40	40.0	36.0	300	23.8	-	-	-	-	-
	20N-22	12.7	27	20	20.0	18.0	180	15.6	ST22N	-	-	-	TW20P
	25-22	12.7	32	32	25.0	29.0	250	17.4	-	-	-	-	-
	25D-22	12.7	32	25	24.6	22.6	200	17.2	-	-	-	-	-
	32-22	12.7	39	32	32.0	29.0	250	21.5	ST22	STA22	ATI22	ATE22	TW20P
	40-22	12.7	47	40	40.0	36.0	300	25.8	-	-	-	-	-
32-27	15.875	40	32	32.0	29.0	250	22.4	-	-	-	-	-	
40-27	15.875	48	40	40.0	36.0	300	26.4	-	-	-	-	-	
50-27	15.875	58	50	50.0	45.0	350	31.4	-	-	-	-	-	
60-27	15.875	69	60	60.0	54.0	400	36.4	ST27	STA27	ATI27	ATE27	TW25L	

➔ Applicable inserts D10, D11, D14, D15, D17, D20~D25, D27~D30 • Helix angle is 1.5° for all holders • No shim needed for N type holder

IR(L)H-C (Clamp on system)

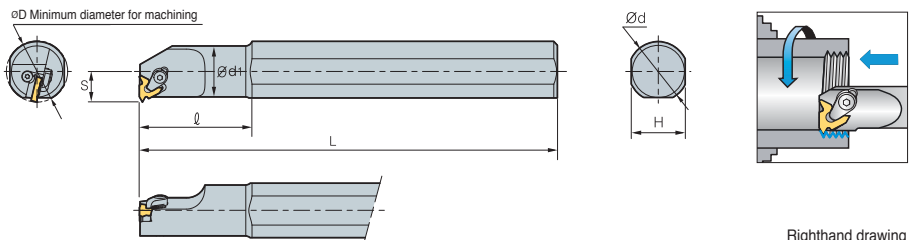

Righthand drawing
(mm)

Designation	Inscribed circle	ØD	Ød	Ød ₁	H	L	S	ℓ	Shim screw	Clamp	Screw RH	Screw LH	Wrench
IR(L)H	20-16C	9.525	24	20	20.0	18.0	13.4	50	-	-	-	-	-
	25-16C	9.525	29	32	25.0	28.0	250	16.3	-	-	-	-	-
	25D-16C	9.525	29	25	24.6	22.6	200	16.1	STA16	CTH16	ATI16	ATE16	TW10P TW15P
	32-16C	9.525	36	32	32.0	29.0	250	19.6	-	-	-	-	-
	40-16C	9.525	44	40	40.0	36.0	300	23.8	-	-	-	-	-
	25-22C	12.7	32	32	25.0	29.0	250	17.4	-	-	-	-	-
	25D-22C	12.7	32	25	24.6	22.6	200	17.2	-	-	-	-	-
	32-22C	12.7	39	32	32.0	29.0	250	21.5	STA22	CTH22	ATI22	ATE22	TW20P
	40-22C	12.7	47	40	40.0	36.0	300	25.8	-	-	-	-	-
	32-27C	15.875	40	32	32.0	29.0	250	22.4	-	-	-	-	-
	40-27C	15.875	48	40	40.0	36.0	300	26.4	-	-	-	-	-
	50-27C	15.875	58	50	50.0	45.0	350	31.4	-	-	-	-	-
	60-27C	15.875	69	60	60.5	54.0	400	36.4	STA27	CTH27	ATI27	ATE27	TW25L

➔ Applicable inserts D10, D11, D14, D15, D17, D20~D25, D27~D30 • Helix angle is 1.5° for all holders

VTH



VETR

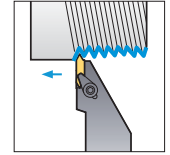
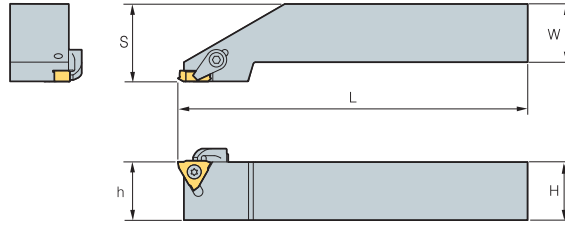

Righthand drawing
(mm)

Designation	H = (h)	W	L	S	Insert	Clamp	Clamp screw	Screw	Wrench	
VTH	2020R	20	20	125	26.4	VETR	CS6R1	DHA0617	FTKA03510	TW15P, HW30L
	2525R	25	25	150	33.4					
	3225R	32	25	170	33.4					

Vertical type thread insert

Picture	Designation	Cermet	Uncoated	Dimensions			Configuration
		CN20	ST10	Pitch (mm)	θ	f	
	VETR 080			0.8	60°	1.4	 d : 9.525 t : 4.76
	100		●	1.0	60°	1.4	
	125			1.25	60°	1.4	
	150		●	1.5	60°	1.2	
	175			1.75	60°	1.2	
	200		●	2.0	60°	1.2	
	250			2.5	60°	1.4	
	300		●	3.0	60°	1.6	
	150F	●	●	0.8~1.5	60°	1.4	
	300F	●	●	1.5~3.0	60°	1.6	

● : Stock item

D Technical Information for Thread Milling

Thread milling holders code system

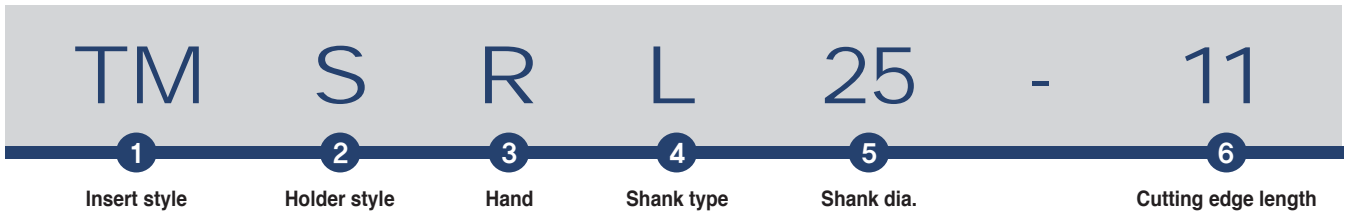

<p>1 Insert style</p> <p>TM S R L 25 - 11</p> <p>Thread Milling Holder</p>	<p>3 Hand</p> <p>TM S R L 25 - 11</p> <p>R: Right Hand L: Left Hand</p>	<p>5 Shank dia.</p> <p>TM S R L 25 - 11</p> <p>25: 25.0</p>						
<p>2 Holders style</p> <p>TM S R L 25 - 11</p> <p>S: Shank Type</p>	<p>4 Shank type</p> <p>TM S R L 25 - 11</p> <p>None: Standard L: Long Type T: Taper Type</p>	<p>6 Cutting edge length</p> <p>TM S R L 25 - 11</p> <table border="0"> <tr> <td>10: 10.4</td> <td>22: 22</td> </tr> <tr> <td>11: 11</td> <td>27: 27</td> </tr> <tr> <td>16: 16</td> <td>38: 38.5</td> </tr> </table>	10: 10.4	22: 22	11: 11	27: 27	16: 16	38: 38.5
10: 10.4	22: 22							
11: 11	27: 27							
16: 16	38: 38.5							

Thread milling inserts code system

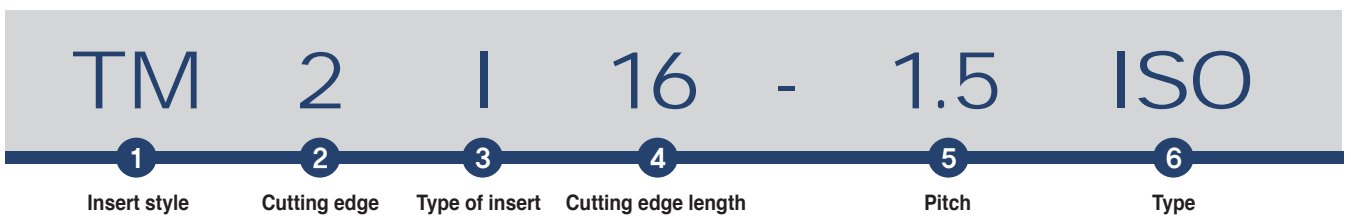

<p>1 Insert style</p> <p>TM 2 I 16 - 1.5 ISO</p> <p>Thread Milling Holder</p>	<p>4 Cutting edge length</p> <p>TM 2 I 16 - 1.5 ISO</p> <p>10: 10.4 11: 11 16: 16 22: 22 27: 27 38: 38.5</p>	<p>6 Type</p> <p>TM 2 I 16 - 1.5 ISO</p> <p>ISO Metric American UN (UNC, UNF, UNEF) UNJ Whit Worth (BSW, BSF, BSP, BSB) National Pipe Thread (NPT) National Pipe Thread (NPTF) British Standard Pipe Thread (BSPT)</p>
<p>2 Cutting edge</p> <p>TM 2 I 16 - 1.5 ISO</p> <p>None: 1 cutting edge 2: 2 cutting edge</p>	<p>5 Pitch</p> <p>TM 2 I 16 - 1.5 ISO</p> <p>mm: 0.5~6.0 tpi: 48~6</p>	
<p>3 Type of insert</p> <p>TM 2 I 16 - 1.5 ISO</p> <p>I: Internal E: External EI: External & Internal</p>		



Thread milling

➤ The right tool for the job

Small diameter type

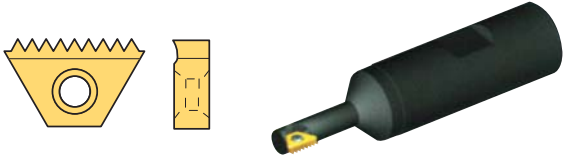

Tool holder: TMSR **Insert:** TM L = 10.4 mm
For small bore diameters down to 9.5 mm

Standard type

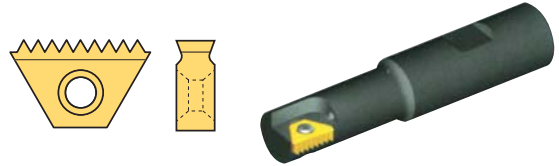

Tool holder: TMSR **Insert:** TM2
For standard length threads

Long type



Tool holder: TMSR **Insert:** TM2
For long or remote threads

Tapered type

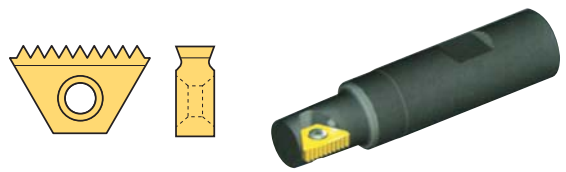

Tool holder: TMSR **Insert:** TM2 (BSPT, NPT, NPTF)
For standard length threads

➤ Thread milling methods

External threading

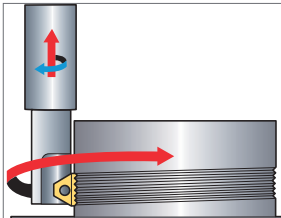

Right handed thread
conventional milling

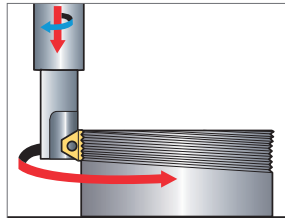

Left handed thread
down milling

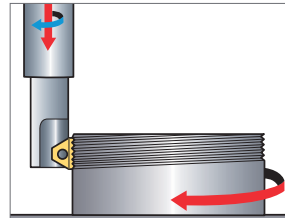

Right handed thread
down milling

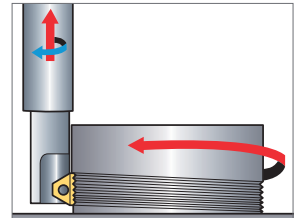

Left handed thread
conventional milling

Internal threading

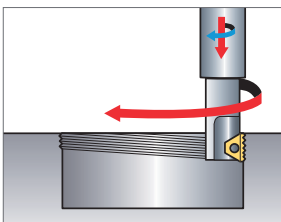

Right handed thread
down milling

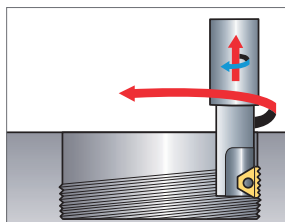

Left handed thread
conventional milling

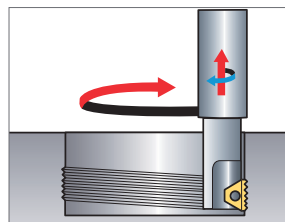

Right handed thread
conventional milling

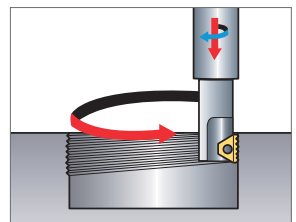

Left handed thread
down milling

D Technical Information for Thread Milling

Tooling recommendation for given internal thread specification

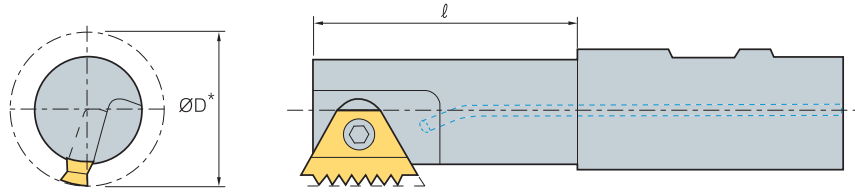

ISO

Pitch (mm)	Nominal dia. (mm)	Holder	Insert	l-Tool holder overhang	D-Tool cutting dia.*	Min.Thread depth (Profile depth)
0.75	11	TMSR 12-10	TM2I 10-0.75ISO	12.0	9.0	0.43
	12-14	TMSR 12-10	TM2I 10-1.0ISO	12.0	9.0	
1.0	15-18	TMSR 12-11	TM2I 11-1.0ISO	12.0	11.5	0.58
	20	TMSR 16-16	TM2I 16-1.0ISO	22.0	17.0	
	22	TMSR 20-22	TM2I 22-1.0ISO	29.0	19.0	
	24	TMSR 20-16	TM2I 16-1.0ISO	43.0	20.0	
	25-28	TMSRL 25-16	TM2I 16-1.0ISO	25.0	22.0	
	1.25	14	TMSR 12-10	TM2I 10-1.25ISO	12.0	
1.5	14-15	TMSR 12-10	TM2I 10-1.5ISO	12.0	9.0	0.87
	16-20	TMSR 12-11	TM2I 11-1.5ISO	12.0	11.5	
	22	TMSR 16-16	TM2I 16-1.5ISO	22.0	17.0	
	24	TMSR 20-22	TM2I 22-1.5ISO	29.0	19.0	
	25-26	TMSR 20-16	TM2I 16-1.5ISO	43.0	20.0	
	27-30	TMSRL 25-16	TM2I 16-1.5ISO	25.0	22.0	
	35-42	TMSR 25-27	TM2I 27-1.5ISO	52.0	30.0	
	45	TMSR 32-27	TM2I 27-1.5ISO	58.0	37.0	
2.0	22	TMSRT 16-16	TM2I16-2.0ISO	22.0	15.5	1.15
	24	TMSR 16-16	TM2I 16-2.0ISO	22.0	17.0	
	25	TMSR 20-22	TM2I 22-2.0ISO	29.0	19.0	
	27	TMSR 20-16	TM2I 16-2.0ISO	43.0	20.0	
	28-32	TMSRL 25-16	TM2I 16-2.0ISO	25.0	22.0	
	39-42	TMSR 25-27	TM2I 27-2.0ISO	52.0	30.0	
	45-48	TMSR 32-27	TM2I 27-2.0ISO	58.0	37.0	
3.0	42-48	TMSR 25-27	TM2I 27-3.0ISO	52.0	30.0	1.73
	50-52	TMSR 32-27	TM2I 27-3.0ISO	58.0	37.0	
	45-52	TMSR 25-27	TM2I 27-4.0ISO	52.0	30.0	
4.0	55	TMSR 32-38	TM2I 38-4.0ISO	55.0	35.0	2.31
	56-58	TMSR 32-27	TM2I 27-4.0ISO	58.0	37.0	
	60-65	TMSR 40-38	TM2I 38-4.0ISO	65.0	46.0	
	5.0	48-52	TMSR 32-38	TM2I 38-5.0ISO	55.0	
5.5	56	TMSR 32-38	TM2I 38-5.5ISO	55.0	35.0	3.17
	60	TMSR 40-38	TM2I 38-5.5ISO	65.0	46.0	
6.0	64-68	TMSR 40-38	TM2I 38-6.0ISO	65.0	46.0	3.46

• The recommended holder is the largest for the given thread specification
 * Holder with smaller or equal cutting diameters (D2) can also be used

Tooling recommendation for given internal thread specification

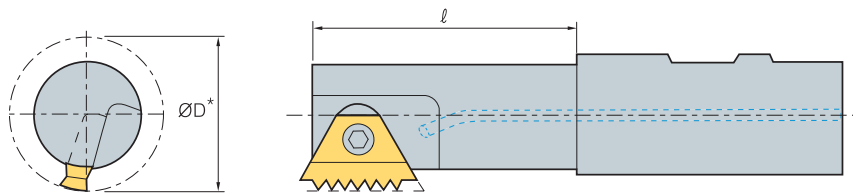

UN

Pitch (tpi)	Nominal dia. (inch)	Holder	Insert	ℓ-Tool holder overhang	D-Tool cutting dia.*	Min.Thread depth (Profile depth)
32	7/16-1/2	TMSR 12-10	TMI 10-32UN	12.0	9.0	0.46
	9/16-11/16	TMSR 12-11	TM2I 11-32UN	12.0	11.5	
	3/4-13/16	TMSR 16-16	TM2I 16-32UN	22.0	17.0	
	7/8-15/16	TMSR 20-16	TM2I 16-32UN	43.0	20.0	
28	1	TMSR 25-16	TM2I 16-32UN	25.0	22.0	0.52
	7/16-1/2	TMSR 12-10	TMI 10-28UN	12.0	9.0	
	9/16-3/4	TMSR 12-11	TM2I 11-28UN	12.0	11.5	
	13/16-7/8	TMSR 16-16	TM2I 16-28UN	22.0	17.0	
	15/16	TMSR 20-16	TM2I 16-28UN	43.0	20.0	
24	1-1 1/8	TMSRL 25-16	TM2I 16-28UN	25.0	22.0	0.61
	9/16-11/16	TMSR 12-11	TM2I 11-24UN	12.0	11.5	
20	1/2-9/16	TMSR 12-10	TMI 10-20UN	12.0	9.0	0.73
	5/8-13/16	TMSR 12-11	TM2I 11-20UN	12.0	11.5	
	7/8	TMSR 16-16	TM2I 16-20UN	22.0	17.0	
	15/16-1	TMSR 20-16	TM2I 16-20UN	43.0	20.0	
	1 1/16-1 1/8	TMSRL 25-16	TM2I 16-20UN	25.0	22.0	
	1 3/8-1 5/8	TMSR 25-27	TM2I 27-20UN	52.0	30.0	
18	1 11/16-1 13/16	TMSR 32-27	TM2I 27-20UN	28.0	37.0	0.81
	5/8	TMSR 12-11	TM2I 11-18UN	12.0	11.5	
	1 1/16-1 3/16	TMSRL 25-16	TM2I 16-18UN	25.0	22.0	
	1 7/16-1 5/8	TMSR 25-27	TM2I 27-18UN	52.0	30.0	
16	1 11/16	TMSR 32-27	TM2I 27-18UN	58.0	37.0	0.92
	11/16-13/16	TMSR 12-11	TM2I 11-16UN	12.0	11.5	
	7/8-15/16	TMSR 16-16	TM2I 16-16UN	22.0	17.0	
	1	TMSR 20-16	TM2I 16-16UN	43.0	20.0	
	1 1/16-1 3/16	TMSRL 25-16	TM2I 16-16UN	25.0	22.0	
	1 7/16-1 5/8	TMSR 25-27	TM2I 27-16UN	52.0	30.0	
14	1 11/16-1 7/8	TMSR 32-27	TM2I 27-16UN	58.0	37.0	1.05
	7/8	TMSR 12-11	TM2I 11-14UN	12.0	11.5	
12	7/8	TMSRT 16-16	TM2I 16-12UN	22.0	15.5	1.22
	15/16	TMSR 16-16	TM2I 16-12UN	22.0	17.0	
	1	TMSR 20-22	TM2I 22-12UN	29.0	19.0	
	1 1/16	TMSR 20-16	TM2I 16-12UN	43.0	20.0	
	1 1/8-1 1/4	TMSRL 25-16	TM2I 16-12UN	25.0	22.0	
	1 1/2-1 11/16	TMSR 25-27	TM2I 27-12UN	52.0	30.0	
	1 3/4-1 15/16	TMSR 32-27	TM2I 27-12UN	58.0	37.0	
8	1 11/16-1 15/16	TMSR 25-27	TM2I 27-8UN	52.0	30.0	1.83
	2-1 1/8	TMSR 32-27	TM2I 27-8UN	58.0	37.0	
6	2-2 1/8	TMSR 25-27	TM2I 27-6UN	52.0	30.0	2.44
	2 1/4	TMSR 32-27	TM2I 27-6UN	58.0	37.0	
	2 3/8-2 1/2	TMSR 40-38	TM2I 38-6UN	65.0	46.0	
4.5	2-2 1/4	TMSR 32-38	TM2I 38-4.5UN	55.0	35.0	3.26
4	2 1/2	TMSR 40-38	TM2I 38-4UN	65.0	46.0	3.67

• The recommended holder is the largest for the given thread specification
 * Holder with smaller or equal cutting diameters (D2) can also be used

D Technical Information for Thread Milling

Tooling recommendation for given internal thread specification

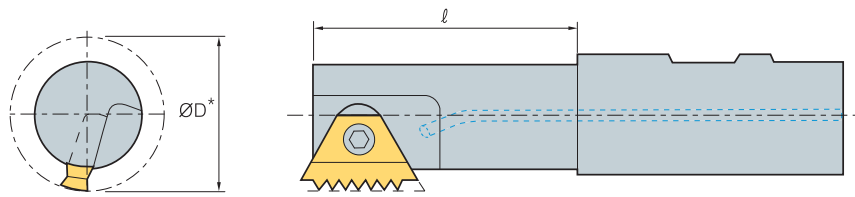

UNJ

Pitch (tpi)	Nominal dia. (inch)	Holder	Insert	ℓ-Tool holder overhang	D-Tool cutting dia.*	Min.Thread depth (Profile depth)
24	9/16-11/16	TMSR 12-11	TM2I 11-24UNJ	12.0	11.5	0.55
20	1/2	TMSR 12-10	TMI 10-20UNJ	12.0	9.0	0.66
	3/4-13/16	TMSR 12-11	TM2I 11-20UNJ	12.0	11.5	
	7/8	TMSR 16-16	TM2I 16-20UNJ	22.0	17.0	
	15/16-1	TMSR 20-16	TM2I 16-20UNJ	43.0	20.0	
18	5/8	TMSR 12-11	TM2I 11-18UNJ	12.0	11.5	0.74
	1 1/16-1 3/16	TMSRL 25-16	TM2I 16-18UNJ	25.0	22.0	
16	11/16-13/16	TMSR 12-11	TM2I 11-16UNJ	12.0	11.5	0.83
	7/8-15/16	TMSR 16-16	TM2I 16-16UNJ	22.0	17.0	
	1	TMSR 20-16	TM2I 16-16UNJ	43.0	20.0	
	1 1/16-1 3/16	TMSRL 25-16	TM2I 16-16UNJ	25.0	22.0	
	1 7/16-1 5/8	TMSR 25-27	TM2I 27-16UNJ	52.0	30.0	
	1 11/16-1 7/8	TMSR 32-27	TM2I 27-16UNJ	58.0	37.0	
14	7/8	TMSR 12-11	TM2I 11-14UNJ	12.0	11.5	0.95
12	7/8	TMSRT 16-16	TM2I 16-12UNJ	22.0	15.5	1.11
	15/16-1	TMSR 16-16	TM2I 16-12UNJ	22.0	17.0	
	1 1/16	TMSR 20-16	TM2I 16-12UNJ	43.0	20.0	
	1 1/8-1 1/4	TMSRL 25-16	TM2I 16-12UNJ	25.0	22.0	
	1 1/2-1 11/16	TMSR 25-27	TM2I 27-12UNJ	52.0	30.0	
	1 3/4-1 15/16	TMSR 32-27	TM2I 27-12UNJ	58.0	37.0	

W

Pitch (tpi)	Nominal dia. (inch)	Holder	Insert	ℓ-Tool holder overhang	D-Tool cutting dia.*	Min.Thread depth (Profile depth)
26	1/2-9/16	TMSR 12-10	TMEI 10-26W	12.0	9.0	0.63
	5/8-3/4	TMSR 12-11	TM2EI 11-26 W	12.0	11.5	
	13/16-7/8	TMSR 16-16	TM2EI 16-26W	22.0	17.0	
	15/16-1	TMSR 20-16	TM2EI 16-26W	43.0	20.0	
20	1 1/16-1 1/8	TMSRL 25-16	TM2EI 16-26W	25.0	22.0	0.81
	9/16	TMSR 12-10	TM2EI 10-20W	12.0	9.0	
	5/8-13/16	TMSR 12-11	TM2EI 11-20W	12.0	11.5	
	7/8-15/16	TMSR 16-16	TM2EI 16-20W	22.0	17.0	
	1	TMSR 20-16	TM2EI 16-20W	43.0	20.0	
16	1 1/16-1 3/16	TMSRL 25-16	TM2EI 16-20W	25.0	22.0	1.02
	13/16	TMSR 16-16	TM2EI 16-16W	22.0	15.5	
	7/8-15/16	TMSR 16-16	TM2EI 16-16W	22.0	17.0	
	1-1 1/16	TMSR 20-16	TM2EI 16-16W	43.0	20.0	
	1 1/8-1 1/4	TMSRL 25-16	TM2EI 16-16W	25.0	22.0	
	1.4-1 5/8	TMSR 25-27	TM2EI 27-16W	52.0	30.0	
12	1 3/4-1.9	TMSR 32-27	TM2EI 27-16W	28.0	37.0	1.36
	1 1/2-1 3/4	TMSR 25-27	TM2EI 27-12W	52.0	30.0	
8	1 7/8-1.9	TMSR 25-27	TM2EI 27-12W	58.0	37.0	2.03
	2.1-2 1/8	TMSR 32-27	TM2EI 27-8W	52.0	30.0	
6	2	TMSR 25-27	TM2EI 27-8W	58.0	37.0	2.32
	2.1-2 1/8	TMSR 25-27	TM2EI 27-7W	52.0	30.0	
	2 1/4	TMSR 32-38	TM2EI 38-6W	52.0	30.0	
	2 3/8-2.6	TMSR 32-27	TM2EI 27-6W	55.0	35.0	
5	2 5/8-2 3/4	TMSR 40-38	TM2EI 27-6W	58.0	37.0	2.71
	3	TMSR 40-38	TM2EI 38-6W	65.0	46.0	
4.5	3 1/2	TMSR 40-38	TM2EI 38-5W	65.0	46.0	3.25
			TM2EI 38-4.5W	65.0	46.0	3.61

* The recommended holder is the largest for the given thread specification
 * Holder with smaller or equal cutting diameters (D2) can also be used



Tooling recommendation for given internal thread specification

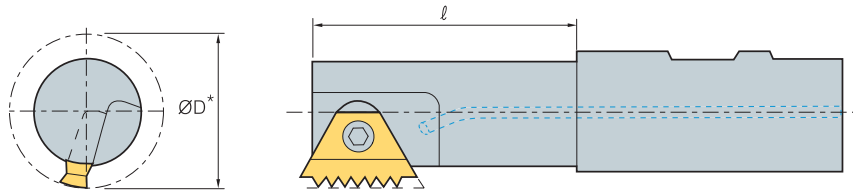

BSPT

Pitch (tpi)	Nominal dia. (inch)	Holder	Insert	Ø-Tool holder overhang	D-Tool cutting dia.*	Min.Thread depth (Profile depth)
19	3/8	TMSR 21-11	TM2EI 11-19 BSPT	20.0	11.5	0.86
14	1/2-3/4	TMSRT 16-11	TM2EI 16-14 BSPT	22.0	15.5	1.16
11	1-1 1/4	TMSRT 20-16	TM2EI 16-11 BSPT	23.0	19.0	1.48
	1 1/2	TMSR 25-27	TM2EI 27-11 BSPT	52.0	30.0	
	2-6	TMSRT 32-27	TM2EI 27-11 BSPT	58.0	37.0	

NPT

Pitch (tpi)	Nominal dia. (inch)	Holder	Insert	Ø-Tool holder overhang	D-Tool cutting dia.*	Min.Thread depth (Profile depth)
14	1/2	TMSRT 16-16	TM2EI 16-14 NPT	22.0	15.5	1.33
	3/4	TMSRT 20-16	TM2EI 16-14 NPT	23.0	19.0	
11.5	1	TMSRT 20-16	TM2EI 16-11.5 NPT	23.0	19.0	1.64
	1 1/4	TMSR 25-27	TM2EI 27-11.5 NPT	52.0	30.0	
	1 1/2-2	TMSRT 32-27	TM2EI 27-11.5 NPT	58.0	37.0	
8	2 1/2	TMSRT 32-27	TM2EI 27-8 NPT	58.0	37.0	2.42
	3-24	TMSR 40-38	TM2EI 38-8 NPT	65.0	46.0	

NPTF

Pitch (tpi)	Nominal dia. (inch)	Holder	Insert	Ø-Tool holder overhang	D-Tool cutting dia.*	Min.Thread depth (Profile depth)
14	1/2	TMSRT 16-16	TM2EI 16-14 NPTF	22.0	15.5	1.35
	3/4	TMSRT 20-16	TM2EI 16-14 NPTF	23.0	19.0	
11.5	1	TMSRT 20-16	TM2EI 16-11.5 NPTF	23.0	19.0	1.63
	1 1/2	TMSR 25-27	TM2EI 27-11.5 NPTF	52.0	30.0	
	2	TMSRT 32-27	TM2EI 27-11.5 NPTF	58.0	37.0	
8	2 1/2	TMSRT 32-27	TM2EI 27-8 NPTF	58.0	37.0	2.38
	3	TMSR 40-38	TM2EI 38-8 NPTF	65.0	46.0	

* The recommended holder is the largest for the given thread specification
 * Holder with smaller or equal cutting diameters (D2) can also be used

Minimum bore diameters for thread milling

Pitch		0.5	0.6	0.7	0.75 0.80	0.9	1.0	1.25	1.5	1.75	2.0	-	2.5	3.0	3.5	4.0	4.5	5.0	5.5	-	6.0	-	
	tpi	48	44	36	32	28	26 24	20 19	18 16	14	13 12	11.5 11	10	9 8	7	6	-	5	-	4.5	-	4	
Holder designation	diameter	Minimum diameter for machining																					
TMSR 12-10	9.0	9.5	9.7	9.9	10.0	10.4	10.7	11.4	12.0														
TMSR 20-10	9.0	9.5	9.7	9.9	10.0	10.4	10.7	11.4	12.0														
TMSR 12-11	11.5	12.0	12.2	12.4	12.5	12.9	13.2	13.9	14.5	15.1													
TMSR 20-11	11.5	12.0	12.2	12.4	12.5	12.9	13.2	13.9	14.5	15.1													
TMSRL 25-11	11.5	12.0	12.2	12.4	12.5	12.9	13.2	13.9	14.5	15.1													
TMSRT 16-16	15.5	16.0	16.2	16.4	16.5	16.9	17.2	17.9	18.5	19.0	19.5	20.0											
TMSR 16-16	17.0	17.6	17.8	18.0	18.2	18.7	19.0	19.6	20.0	20.5	21.0	21.5											
TMSR 16-22	17.0	17.6	17.8	18.0	18.2	18.7	19.0	19.6	20.0	20.5	21.0	21.5											
TMSR 20-22	19.0	19.7	20.0	20.2	20.4	20.8	21.0	21.6	22.0	22.5	23.0	23.5											
TMSRT 20-16	19.0	19.7	20.0	20.2	20.4	20.8	21.0	21.6	22.0	22.5	23.0	23.5											
TMSR 20-16	20.0	20.7	21.0	21.2	21.4	21.8	22.0	22.6	23.0	23.5	24.0	24.5											
TMSRW 25-22	22.0	22.7	23.0	23.2	23.4	23.8	24.0	24.6	25.0	25.5	26.0	26.5											
TMSRL 25-22	22.0	22.7	23.0	23.2	23.4	23.8	24.0	24.6	25.0	25.5	26.0	26.5											
TMSRL 25-16	22.0	22.7	23.0	23.2	23.4	23.8	24.0	24.6	25.0	25.5	26.0	26.5											
TMSR 25-27	30.0	30.7	31.0	31.2	31.4	31.8	32.0	32.8	33.5	34.1	34.6	35.6	36.6	39.0	42.0	45.0	48.0						
TMSRL 25-27	30.0	30.7	31.0	31.2	31.4	31.8	32.0	32.8	33.5	34.1	34.6	35.6	36.6	39.0	42.0	45.0	48.0						
TMSR 32-38	35.0								38.5	39.1	39.6	40.6	42.0	44.0	47.0	50.0	53.4	42.5	50.0	44.6	57.5	56.6	
TMSR 32-27	37.0	38.0	38.2	38.4	38.6	39.1	39.5	40.4	41.0	41.5	42.0	43.0	44.0	46.5	49.0	52.0	55.5						
TMSRL 32-27	37.0	38.0	38.2	38.4	38.6	39.1	39.5	40.4	41.0	41.5	42.0	43.0	44.0	46.5	49.0	52.0	55.5						
TMSRT 32-27	37.0	38.0	38.2	38.4	38.6	39.1	39.5	40.0	41.0	41.5	42.0	43.0	44.0	46.5	49.0	52.0	55.5						
TMSR 40-38	46.0								49.5	50.1	50.6	51.6	53.0	55.0	55.2	55.6	55.0	52.5	54.0	54.5	57.5	56.6	
TMSRL 40-38	46.0								49.5	50.1	50.6	51.6	53.0	55.0	55.2	55.6	55.0	52.5	54.0	54.5	57.5	56.6	

- In order to perform a thread milling operation, a milling machine with three-axis control capability of helical interpolation is required
- Helical interpolation is a CNC function producing tool movement along a helical path. This helical motion combines circular movement in one plane with a simultaneous linear motion in a plane perpendicular to the first. For example, the path from point A to point B (Fig.A) on the envelope of the cylinder combines a circular movement in the x-y plane with a linear displacement in the z direction
- On most CNC systems this function can be executed in two different ways:

- G02: Helical interpolation in a clockwise direction
- G03: Helical interpolation in a counter-clockwise direction

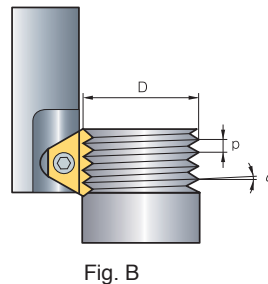
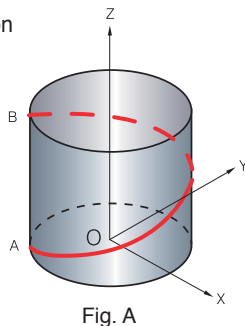

- The thread milling operation (Fig. B) consists of circular rotation of the tool around its own axis together with an orbiting motion along the bore or workpiece circumference. During one such orbit, the tool will shift vertically one pitch length. These movements combined with the insert geometry create the required thread form. There are three acceptable ways of approaching the workpiece with the tool to initiate production of the thread:

1. Tangential Arc Approach
2. Radial Approach
3. Tangential Line Approach



Tangential arc approach

- With this method, the tool enters and exits the workpiece smoothly. No marks are left on the workpiece and there is no vibration, even with harder materials. Although it requires slightly more complex programming than the radial approach (see below), this is the method recommended for machining the highest quality threads

Internal thread

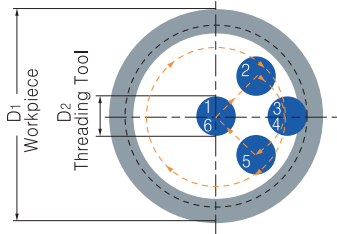

External thread

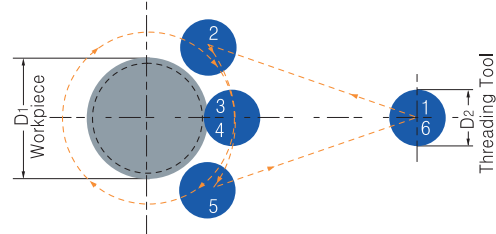

- 1-2: rapid approach
- 2-3: tool entry along tangential arc, with simultaneous feed along z-axis
- 3-4: helical movement during one full orbit (360°)
- 4-5: tool exit along tangential arc, with continuing feed along z-axis
- 5-6: rapid return

Radial approach

- This is the simplest method. There are two characteristics worth nothing about the radial approach:
 - A. a small vertical mark may be lift at the entry (and exit) point. This is of no significance to the thread itself
 - B. when using this method with very hard materials, there may be a tendency of the tool to vibrate as it approaches the full cutting depth
- Note: Radial feed during entry to the full profile depth should only be 1/3 of the subsequent circular feed

Internal thread

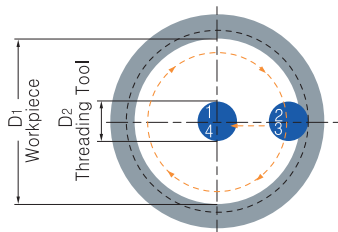

External thread

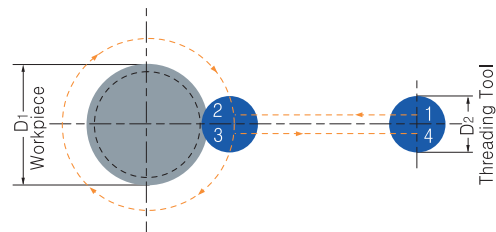

- 1-2: radial entry
- 2-3: helical movement during one full orbit (360°)
- 3-4: radial exit

Tangential line approach

- This method is very simple, and has all of the advantages of the tangential arc method. However, it is applicable only with external threads

External thread

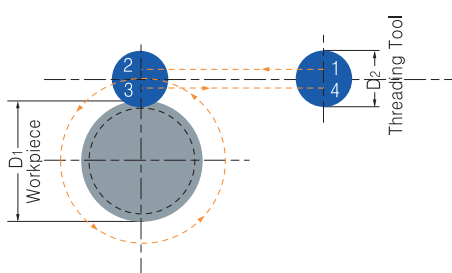

- 1-2: radial entry with simultaneous feed along z axis
- 2-3: helical movement during one full orbit (360°)
- 3-4: radial exit

Preparing for the thread milling operation

➤ Calculation of rotational velocity and feed at the cutting edge

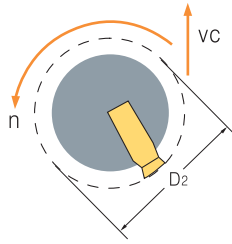

$$n = \frac{vc \times 1000}{\pi \times D_2}$$

$$vc = \frac{n \times \pi \times D_2}{1000}$$

$$F_1 = n \times z \times f_n$$

- n:** Rotational Velocity (min⁻¹)
- vc:** Cutting Speed (m/min)
- D2:** Tool holder Cutting Dia. (mm)
- F1:** Real Feed rate at the Cutting edges (mm/min)
- z:** No. of Cutting Edges
- fn:** Feed per Root per Rotation (mm/rev)

➤ Calculation of feed rates at the tool center line



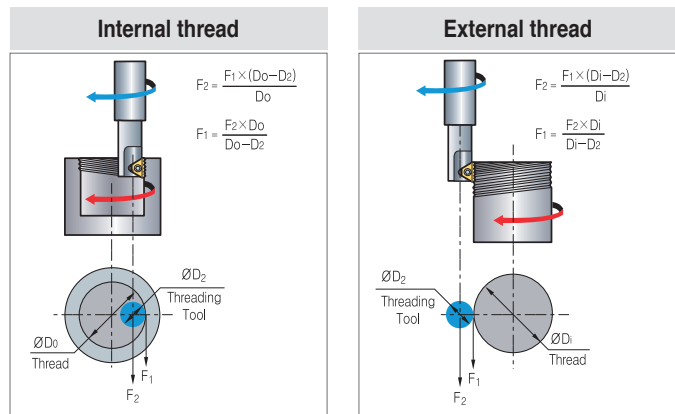

- On most CNC machines, the feed rate required for programming is that of the center-line of the tool. When dealing with linear tool movement, the feed rate at the cutting edge and the center line are identical, but with circular tool movement this is not the case. The equations define the relationship between feed rates at the cutting edge and at the tool center line.



➤ Grades and applications

- Grade: PC9570T
- Application: First Choice for steel and cast iron. A tough sub-micron substrate with TiCN coating. Provides good fracture toughness and excellent wear resistance.

➤ Trouble shooting

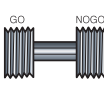
Problem	Possible	Solution
 Increased insert flank wear	Cutting speed too high> Chip is too thin> Insufficient coolant>	Reduce cutting speed/use coated insert Increase feed rate Increase coolant flow rate
 Chipping of cutting edge	Chip is too thick> Vibration>	Reduce feed rate/Use the tangential arc method Increase RPM Check stability
 Material built-up on the cutting edge	Incorrect cutting speed> Unsuitable carbide grade>	Change cutting speed Use a coated carbide grade
 Chatter/vibration	Feed rate is too high> Profile is too deep> Thread length is too long>	Reduce the feed. Execute two passes, each with increased cutting depth/ Execute two passes, each cutting only half the thread length Execute two passes, each cutting only half the thread length
 Insufficient thread accuracy	Tool deflection>	Reduce feed rate/Execute a "zero" cut

Recommended cutting condition

Workpiece		Hardness brinell (HB)	vc (m/min)		Feed fz (mm/t)		
			Grade		Indexable insert	Solid endmill	
			PC9570T	PC9070M			
P	Unalloyed steel	Low carbon (C+0.1-0.25%)	125	100~210	80~250	0.05~0.3	0.03~0.15
		Medium carbon (C = 0.25-0.55%)	150	100~180	80~230	0.05~0.25	0.03~0.1
		High carbon (C = 0.55-0.85%)	170	100~170	80~200	0.05~0.2	0.03~0.08
	Low alloy steel (alloying elements≤5%)	Non-hardened	180	90~160	60~180	0.05~0.25	0.03~0.1
		Hardened	275	80~150	60~170	0.05~0.2	0.03~0.07
		Hardened	350	70~140	60~160	0.05~0.15	0.01~0.03
	High alloy steel	Annealed	200	60~130	40~100	0.05~0.2	0.03~0.05
		Hardened	325	70~110	30~80	0.05~0.1	0.01~0.03
	Cast steel	Low alloy (alloying elements<5%)	200	100~170	80~250	0.05~0.15	0.03~0.1
		High alloy (alloying elements>5%)	225	70~120	60~170	0.05~0.1	0.01~0.03
M	Stainless steel ferritic	Non-hardened	200	100~170	60~150	0.05~0.15	0.04~0.1
		Hardened	330	100~170	60~120	0.05~0.1	0.01~0.05
	Stainless steel Austenitic	Austenitic	180	70~140	60~140	0.05~0.15	0.04~0.1
		Super austenitic	200	70~140	60~130	0.05~0.1	0.04~0.1
	Stainless steel cast ferritic	Non-hardened	200	70~140	60~160	0.05~0.15	0.04~0.1
		Hardened	330	70~140	60~110	0.05~0.1	0.03~0.05
	Stainless steel cast austenitic	Austenitic	200	70~120	60~150	0.05~0.15	0.04~0.1
		Hardened	330	70~120	60~100	0.05~0.1	0.03~0.05
	High temperature alloys	Annealed (Iron based)	200	20~45	30~60	0.05~0.1	0.04~0.1
		Aged (Iron based)	280	20~30	20~50	0.02~0.05	0.01~0.03
		Annealed (Nickel or Cobalt based)	250	15~20	15~35	0.02~0.05	0.01~0.03
		Aged (Nickel or Cobalt based)	350	10~15	15~30	0.02~0.05	0.01~0.03
	Titanium alloys	Pure 99.5 Ti	400Rm	70~140	40~80	0.02~0.05	0.03~0.05
		α+β alloys	1050Rm	20~50	20~50	0.02~0.05	0.03~0.05
K	Extra hard steel	Hardened & tempered	55HrC	20~45	15~45	0.01~0.03	0.005~0.01
	Malleable cast iron	Ferritic (short chips)	130	60~130	70~160	0.02~0.08	0.01~0.03
		Pearlitic (long chips)	230	60~120	60~150	0.02~0.05	0.03~0.05
	Grey cast iron	Low tensile strength	180	60~130	70~160	0.05~0.15	0.05~0.1
		High tensile strength	260	60~100	40~120	0.05~0.1	0.03~0.05
	Nodular SG iron	Ferritic	160	60~125	40~110	0.05~0.15	0.05~0.1
		Pearlitic	260	50~90	40~100	0.05~0.1	0.03~0.05
	Aluminum alloys Wrought	Non-aging	60	100~250	200~300	0.1~0.4	0.1~0.25
		Aged	100	100~180	150~250	0.1~0.3	0.1~0.2
	Aluminum alloys	Cast	75	150~400	100~200	0.1~0.3	0.1~0.2
		Cast & aged	90	150~280	120~220	0.05~0.25	0.1~0.15
Cast Si 13-22%		130	80~150	200~300	0.1~0.3	0.1~0.2	
Copper and copper alloys	Brass	90	120~210	200~300	0.1~0.3	0.1~0.25	
	Bronze and non-leaded copper	100	120~210	150~250	0.05~0.25	0.1~0.2	

Example

- At tool entry, set the Feed fz (mm/tooth) to 70% lower than the threading Feed
- Threading Feed: 0.3 (mm/t)
- Tool entry Feed: 0.09 (mm/t)

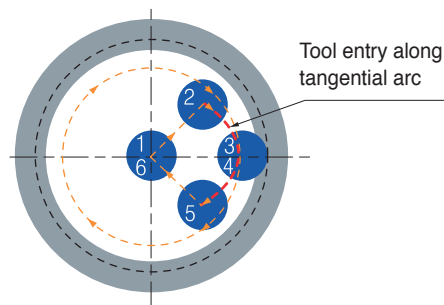

D Thread Milling Inserts

ISO Metric

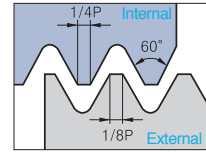
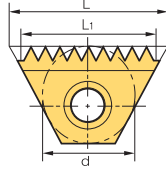

Defined by: R262 (DIN 13)
Tolerance class: 6g/6H

(mm)

External/Internal

Insert size		Pitch (mm)	Designation				L ₁	Tooth	Tool holder		
d	L		External	PC9570T	Internal	PC9570T					
6.0	10.4	0.5	-		TMI	10-0.5ISO	●	10.0	20	TMSR-10	
		0.75	-			10-0.75ISO		9.75	13		
		1.0	-			10-1.0ISO	●	9.0	9		
		1.25	-			10-1.25ISO		8.75	7		
		1.5	-			10-1.5ISO		9.0	6		
6.35	11	0.5	-		TM2I	11-0.5ISO		10.0	20	TMSR-11	
		0.75	TM2E	11-0.75ISO		11-0.75ISO	●	10.5	14		
		1.0		11-1.0ISO		11-1.0ISO	●	10.0	10		
		1.25		11-1.25ISO		-		10.0	8		
		1.25		-		11-1.25ISO		8.75	7		
		1.5		11-1.5ISO		-		9.0	6		
		1.5		-		11-1.5ISO	●	10.5	7		
9.525	16	0.5	-		TM2I	16-0.5ISO		15.0	30	TMSR-16	
		0.75	TM2E	16-0.75ISO		16-0.75ISO		15.0	20		
		0.8		-		16-0.8ISO		14.4	18		
		1.0		16-1.0ISO		-		14.0	14		
		1.0		-		16-1.0ISO		15.0	15		
		1.25		16-1.25ISO		16-1.25ISO		15.0	12		
		1.5		16-1.5ISO		16-1.5ISO	●	15.0	10		
		1.75		16-1.75ISO		16-1.75ISO		14.0	8		
		2.0		16-2.0ISO		16-2.0ISO	●	14.0	7		
9.525B	22	1.0	TM2E	22-1.0ISO		TM2I	22-1.0ISO		22.0	22	TMSR-22
		1.25		22-1.25ISO		22-1.25ISO		21.25	17		
		1.5		22-1.5ISO		22-1.5ISO	●	21.0	14		
		1.75		22-1.75ISO		22-1.75ISO		21.0	12		
		2.0		22-2.0ISO	●	22-2.0ISO	●	22.0	11		
15.875	27	1.0	TM2E	27-1.0ISO		TM2I	27-1.0ISO		26.0	26	TMSR-27
		1.25		27-1.25ISO		27-1.25ISO		25.0	20		
		1.5		27-1.5ISO		27-1.5ISO	●	25.5	17		
		1.75		27-1.75ISO		27-1.75ISO		24.5	14		
		2.0		27-2.0ISO		27-2.0ISO	●	24.0	12		
		2.5		27-2.5ISO		27-2.5ISO		25.0	10		
		3.0		27-3.0ISO		27-3.0ISO	●	24.0	8		
		3.5		27-3.5ISO		27-3.5ISO		24.5	7		
		4.0		27-4.0ISO		27-4.0ISO	●	24.0	6		
4.5		27-4.5ISO		27-4.5ISO		22.5	5				
19.05B	38.5	1.5	TM2E	38-1.5ISO		TM2I	38-1.5ISO		36.0	24	TMSR-38
		2.0		38-2.0ISO		38-2.0ISO		36.0	18		
		3.0		38-3.0ISO		38-3.0ISO		36.0	12		
		4.0		38-4.0ISO		38-4.0ISO		32.0	8		
		4.5		38-4.5ISO		38-4.5ISO		31.5	7		
		5.0		38-5.0ISO		38-5.0ISO		30.0	6		
		5.5		38-5.5ISO		38-5.5ISO		33.0	6		
6.0		38-6.0ISO		38-6.0ISO		30.0	5				

↻ Applicable holders D49

All inserts except TMI10 code have 2 cutting edges

●: Stock item



D

Threading

American UN

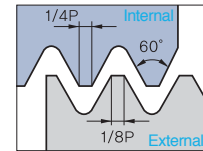
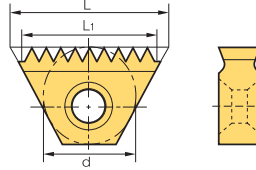
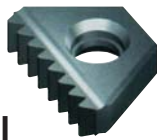

Defined by: ANSI B1.1.74
Tolerance class: Class 2A/2B

(mm)

External/Internal

Insert size		Pitch (tpi)	Designation				L1	Tooth	Tool holder		
d	L		External	PC9570T	Internal	PC9570T					
6.0	10.4	32	-		TMI	10-32UN		9.53	12	TMSR-10	
		28	-			10-28UN		9.07	10		
		24	-			10-24UN		9.53	9		
		20	-			10-20UN		8.89	7		
		18	-			10-18UN		8.47	6		
		16	-			10-16UN		7.94	5		
6.35	11	48	-		TM2I	11-48UN		10.05	19	TMSR-11	
		40	-			11-40UN		10.16	16		
		32	-			11-32UN		10.32	13		
		28	TM2E	11-28UN			11-28UN		9.98		11
		27		11-27UN			11-27UN		10.35		11
		24		11-24UN			11-24UN		9.53		9
		20		11-20UN			11-20UN		10.16		8
		18		11-18UN			11-18UN		9.88		7
		16		11-16UN			11-16UN		9.53		6
		14		11-14UN			11-14UN		9.07		5
9.525	16	40	-		TM2I	16-40UN		14.61	40	TMSR-16	
		32	-			16-32UN		15.08	32		
		28	TM2E	16-28UN			16-28UN		14.51		28
		27		16-27UN			16-27UN		14.11		27
		24		16-24UN			16-24UN		14.82		24
		20		16-20UN			16-20UN		13.97		20
		18		16-18UN			16-18UN		14.11		18
		16		16-16UN			16-16UN	●	14.29		16
		14		16-14UN			16-14UN		14.51		14
		13		16-13UN			16-13UN		13.68		13
		12		16-12UN			16-12UN	●	14.82		12
		11.5		16-11.5UN			16-11.5UN		13.25		11.5
		9.525B	22	24	TM2E	22-24UN		TM2I	22-24UN		
20				22-20UN			22-20UN		21.59	17	
18				22-18UN			22-18UN		21.17	15	
16				22-16UN			22-16UN		20.64	13	
14				22-14UN			22-14UN		21.77	12	
13				22-13UN			22-13UN		21.49	11	
12				22-12UN			22-12UN		21.17	10	
15.875	27	24	TM2E	27-24UN		TM2I	27-24UN		25.40	24	TMSR-27
		20		27-20UN			27-20UN		25.40	20	
		18		27-18UN			27-18UN		25.40	18	
		16		27-16UN			27-16UN		25.40	16	
		14		27-14UN			27-14UN		25.40	14	
		13		27-13UN			27-13UN		25.40	13	
		12		27-12UN			27-12UN		25.40	12	
		11.5		27-11.5UN			27-11.5UN		24.30	11	
		11		27-11UN			27-11UN		25.40	11	
		10		27-10UN			-		22.86	9	
		10		-			27-10UN		25.40	10	
		9		27-9UN			27-9UN		22.58	8	
		8		27-8UN			27-8UN		22.23	7	
		7		27-7UN			-		21.77	6	
		7		-			27-7UN		25.40	7	
		6		27-6UN			-		21.17	5	
6		-			27-6UN		25.40	6			
19.05	38.5	6	TM2E	38-6UN		TM2I	38-6UN		38.87	8	TMSR-38
		5		38-5UN			38-5UN		30.48	6	
		4.5		38-4.5UN			38-4.5UN		33.87	6	
		4		38-4UN			38-4UN		31.75	5	

➔ Applicable holders **D49**

All inserts except TMI10 code have 2 cutting edges

● Stock item

D Thread Milling Inserts

UNJ (Unified constant thread)

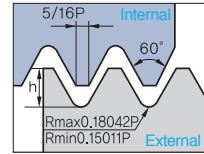
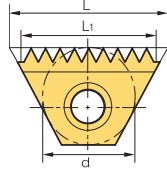

Defined by: MIL-S-8879C
Tolerance class: 3A/3B

External/Internal

(mm)

Insert size		Pitch (tpi)	Designation				L ₁	Tooth	Tool holder	
d	L		External	PC9570T	Internal	PC9570T				
6.0	10.4	24	-		TMI	10-24UNJ	9.53	9	TMSR-10	
		20	-			10-20UNJ	8.89	7		
		18	-			10-18UNJ	8.47	6		
		16	-			10-16UNJ	9.53	8		
6.35	11	24	TM2E	11-24UNJ		TM2I	11-24UNJ	9.53	9	TMSR-11
		20		11-20UNJ			11-20UNJ	10.16	8	
		18		-			11-18UNJ	9.88	7	
		16		11-16UNJ			11-16UNJ	9.53	6	
		14		11-14UNJ			11-14UNJ	9.07	5	
9.525	16	24	TM2E	16-24UNJ		TM2I	16-24UNJ	14.82	14	TMSR-16
		20		16-20UNJ			16-20UNJ	13.97	11	
		18		16-18UNJ			16-18UNJ	14.11	10	
		16		16-16UNJ			16-16UNJ	14.29	9	
		14		16-14UNJ			16-14UNJ	14.51	8	
		13		16-13UNJ			-	13.68	7	
		12		16-12UNJ			16-12UNJ	14.82	7	
15.875	27	16	TM2E	27-16UNJ		TM2I	27-16UNJ	25.40	16	TMSR-27
		12		27-12UNJ			27-12UNJ	25.40	12	
		11		27-11UNJ			27-11UNJ	25.40	11	

↻ Applicable holders **D49**

All inserts except TMI10 code have 2 cutting edges

● Stock item



D

Threading

Whitworth (BSW, BSF, BSP, BSB)

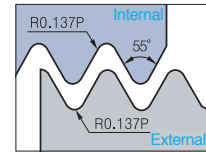
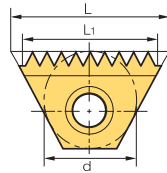

External/Internal

BSW Defined by: B.S.84:1956, DIN 259, ISO228/1: 1982
 BSP Defined by: B.S.2779: 1956
 Tolerance class: BSW-Medium class A, BSP-Medium class

Insert size		Pitch (tpi)	Designation		PC9570T	L ₁	Tooth	Tool holder
d	L		External+Internal					
6.0	10.4	28	TMEI	10-28W		9.07	10	TMSR-10
		26		10-26W		8.79		
		24		10-24W		9.53		
		20		10-20W		8.89		
		19		10-19W		9.36		
6.35	11	28	TM2EI	11-28W		9.98	11	TMSR-11
		26		11-26W		9.77		
		24		11-24W		9.53		
		20		11-20W		10.16		
		19		11-19W		9.36		
		14		11-14W		9.07		
9.525	16	26	TM2EI	16-26W		14.65	15	TMSR-16
		24		16-24W		14.82		
		20		16-20W		13.97		
		19		16-19W		14.71		
		18		16-18W		14.11		
		16		16-16W		14.29		
		14		16-14W		14.51		
		12		16-12W		14.82		
9.525B	22	24	TM2EI	22-24W		21.17	20	TMSR-22
		20		22-20W		21.59		
		19		22-19W		21.39		
		18		22-18W		21.17		
		16		22-16W		20.64		
		14		22-14W		21.77		
		12		22-12W		21.17		
		11		22-11W		20.78		
15.875	27	16	TM2EI	27-16W		25.4	16	TMSR-27
		14		27-14W		25.4		
		12		27-12W		23.28		
		11		27-11W		23.09		
		10		27-10W		25.40		
		9		27-9W		22.58		
		8		27-8W		22.23		
		7		27-7W		21.77		
19.05B	38.5	11	TM2EI	38-11W		34.64	15	TMSR-38
		6		38-6W		33.87		
		5		38-5W		30.48		
		4.5		38-4.5W		33.87		
		-		38-15W		-		

➔ Applicable holders **D49**

All inserts except TM10 code have 2 cutting edges

● Stock item

D Thread Milling Inserts

NPT

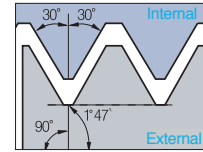
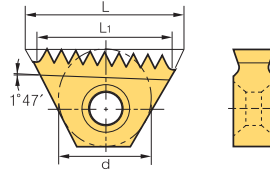

Defined by: USAS B2.1: 1968
Tolerance class: Standard NPT

External/Internal

Insert size		Pitch (tpi)	Designation		PC9570T	L ₁	Tooth	Tool holder	
d	L		External+Internal					RH	LH
9.525	16	18	TM2E	16-18NPT *		14.11	10	TMSRT-16	TMSLT-16
		14	TM2EI	16-14NPT		14.51	8		
		11.5		16-11.5NPT		13.25	6		
9.525B	22	14	TM2EI	22-14NPT		21.77	12	TMSRT-22	TMSLT-22
15.875	27	11.5	TM2EI	27-11.5NPT	●	24.30	11	TMSR-27	TMSL-27
		8		27-8NPT	●	22.23	7		
19.05B	38.5	11.5	TM2EI	38-11.5NPT		35.34	16	TMSR-38	TMSL-38
		8		38-8NPT		31.75	10		

➔ Applicable holders D49

* TM2E16-18NPT is for external threading

● Stock item

NPTF

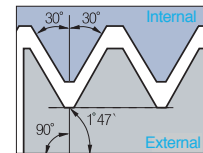
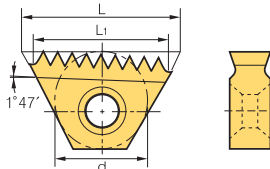

Defined by: ANSI 1.20.3-1976
Tolerance class: Standard NPTF

External/Internal

Insert size		Pitch (tpi)	Designation		PC9570T	L ₁	Tooth	Tool holder	
d	L		External+Internal					RH	LH
9.525	16	14	TM2EI	16-14NPTF	●	14.51	8	TMSRT - 16	TMSLT - 16
		11.5		16-11.5NPTF		13.25	6		
9.525B	22	14	TM2EI	22-14NPTF		21.77	12	TMSRT - 22	TMSLT - 22
		11.5		22-11.5NPTF		19.88	9		
15.875	27	11.5	TM2EI	27-11.5NPTF		24.30	11	TMSR - 27	TMSL - 27
		8		27-8NPTF		22.23	7		
19.05B	38.5	11.5	TM2EI	38-11.5NPTF		35.34	16	TMSR - 38	TMSL - 38
		8		38-8NPTF		31.75	10		

➔ Applicable holders D49

● Stock item

BSPT

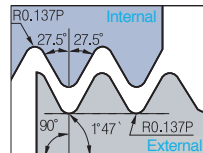
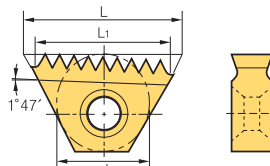

Defined by: B.S 21: 1985
Tolerance class: Standard BSPT

External/Internal

Insert size		Pitch (tpi)	Designation		PC9570T	L ₁	Tooth	Tool holder	
d	L		External+Internal					RH	LH
6.35	11	19	TM2EI	11-19BSPT		9.36	7	TMSR - 10	TMSL - 10
9.525	16	14	TM2EI	16-14BSPT		14.51	8	TMSRT - 16	TMSLT - 16
		11		16-11BSPT		13.85	6		
15.875	27	11	TM2EI	27-11BSPT		23.09	10	TMSR - 27	TMSL - 27

➔ Applicable holders D49

● Stock item



Standard Type

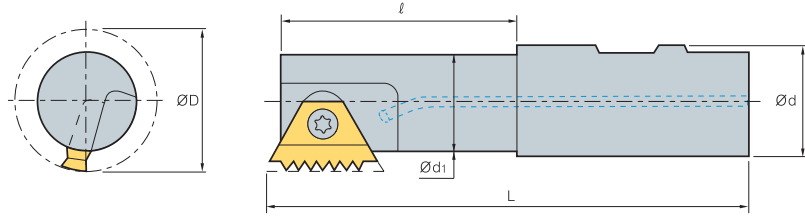

(mm)

Insert size d	Designation	ØD	Ød	Ød ₁	ℓ	L	Screw	Wrench
6.0	TMSR 12-10	9.0	12	6.8	12.0	69.0	STM10	TW07P
	20-10	9.0	20	6.8	17.0	84.0		
6.35	TMSR 12-11	11.5	12	8.9	12.0	70.0	STM11	TW08P
	20-11	11.5	20	8.9	20.0	85.0		
9.525	TMSR 16-16	17.0	16	13.6	22.0	90.0	STM1622	TW10P
	20-16	20.0	20	16.6	43.0	95.0		
9.525B	TMSR 16-22	17.0	16	13.5	29.0	79.5	STM1622	TW10P
	20-22	19.0	20	15.5	29.0	81.5		
	25-22	19.0	25	15.5	30.0	92.3		
	TMSRW 25-22	22.0	25	18.5	30.0	90.8		
15.875	TMSR 25-27	30.0	25	24.0	52.0	110.0	STM27	TW25L
	TMSL 25-27	30.0	25	24.0	52.0	110.0		
	TMSR 32-27	37.0	32	31.0	58.0	120.0		
19.05	TMSR 32-38	35.0	32	27.0	53.0	115.0	STM38	TW30L
	40-38	46.0	40	38.0	63.0	135.0		

↻ Applicable inserts D44~48

Long Type

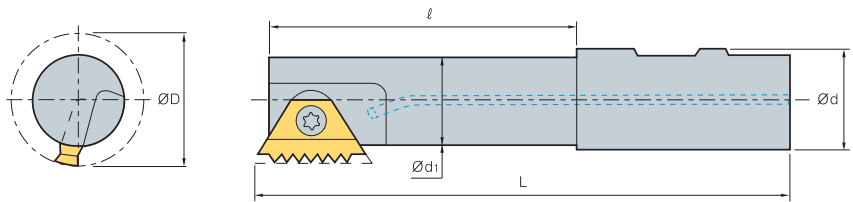

(mm)

Insert size d	Designation	ØD	Ød	Ød ₁	ℓ	L	Screw	Wrench
6.35	TMSRL 25-11	11.5	25	8.9	17.0	125.0	STM11	TW08P
9.525B	TMSRL 25-16	22.0	25	18.6	25.0	125.0	STM1622	TW10P
9.525B	TMSRL 20-22	19.0	20	15.5	44.0	96.5	STM1622	TW10P
	25-22	22.0	25	18.6	63.5	125.0		
15.875	TMSRL 25-27	30.0	25	24.0	92.0	150.0	STM27	TW25L
	32-27	37.0	32	31.0	98.0	160.0		
19.05B	TMSRL 40-38	46.0	40	38.0	93.0	168.0	STM38	TW30L

↻ Applicable inserts D44~48

Tapered Type

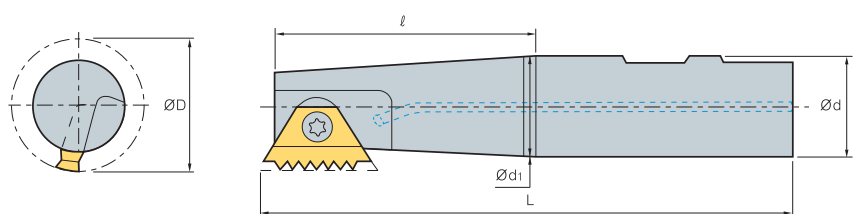

(mm)

Insert size d	Designation	ØD	Ød	Ød ₁	ℓ	L	Screw	Wrench
9.525	TMSRT 16-16	15.5	16	12.5	22.0	90.0	STM1622	TW10P
	20-16	19.0	20	15.0	23.0	85.0	STMT16	
9.525B	TMSRT 16-22	17.0	16	13.5	29.0	79.5	STM1622	TW10P
	20-22	19.0	20	15.5	29.0	81.5		
15.875	TMSRT 32-27	37.0	32	31.0	58.0	120.0	STM27	TW25L

↻ Applicable inserts D44~48

Solid threading endmills code system

STM D 3T 03 012 L034 - I 0.35 ISO

1 Type 2 Flute style 3 No. of flutes 4 Shank dia. 5 Cutting dia. 6 Cutting edge length 7 Type of tool 8 Pitch 9 Type

1 Type
STM D 3T 03 012 L034 - I 0.35 ISO
Solid Threading Endmill

4 Shank dia.
STM D 3T 03 012 L034 - I 0.35 ISO
03: 3.0

8 Pitch
STM D 3T 03 012 L034 - I 0.35 ISO
mm: 0.35~3.0 tpi: 72~12

2 Flute style
STM D 3T 03 012 L034 - I 0.35 ISO
HC: Heli Cool
HCR: Heli Radial Cooling
HCC: Heli Cool Chamfering
HCD: Heli Cool C/F & Drilling
D: Deep Threading

5 Cutting dia.
STM D 3T 03 012 L034 - I 0.35 ISO
012: 1.20

6 Cutting edge length
STM D 3T 03 012 L034 - I 0.35 ISO
L034: 3.4

9 Type
STM D 3T 03 012 L034 - I 0.35 ISO
ISO Metric
American UN
Cutting edge Length UNJ
Whit Worth (BSW, BSF, BSP, BSB)
National Pipe Thread (NPT)
National Pipe Thread (NPTF)
British Standard Pipe Thread (BSPT)

3 No. of flutes
STM D 3T 03 012 L034 - I 0.35 ISO
3T: 3 Flutes 2L: 4 Flutes, Left Flutes

7 Type of tool
STM D 3T 03 012 L034 - I 0.35 ISO
I: Internal

TM-INFO User guide

CNC Program composition
TM-INFO composes CNC program for thread milling process in a short time

- ▶ Multilingual
- ▶ Window operation

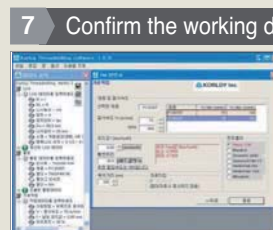
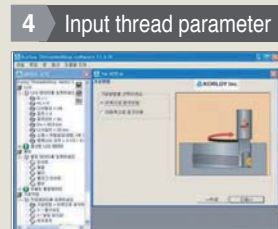
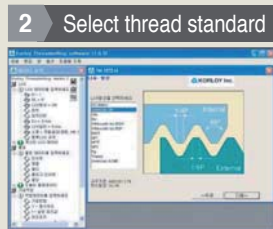
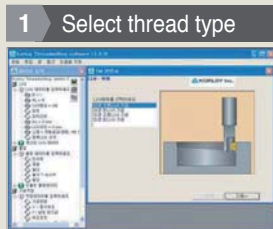

download
Pls. visit our web-site to download.
<http://www.korloy.com>

ISO Metric

Helical flutes with thru-hole coolant

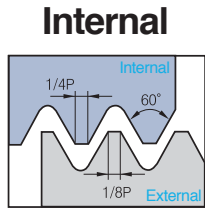

Defined by: R262 (DIN 13)
Tolerance class: 6H

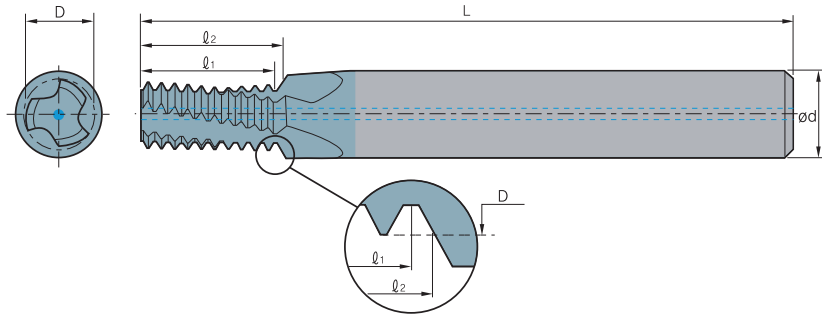

($l_2 \leq 1.5 \times \text{Thread Diameter}$)

Thread		Pitch (mm)	Designation	PC9070M	Dimensions (mm)					No. of flute	Tooth	*Bore dia. mm
M Coarse	M Fine				Internal	Ød	D	L	l ₁			
M3x0.5	M3.5~M16x0.5	0.5	STMHC 04024L04-I0.50ISO		4	2.40	45	4.5	4.7	3	9	2.5
M4x0.7		0.7	04031L06-I0.70ISO		4	3.15	45	6.3	6.6	3	9	3.3
M5x0.8		0.8	04039L07-I0.80ISO		4	3.90	45	7.2	7.6	3	9	4.2
M6x1.0	M8~M40x1.0	1.0	06048L09-I1.00ISO		6	4.80	57	9.0	9.5	3	9	5.0
M8x1.25		1.25	08065L13-I1.25ISO		8	6.50	61	12.5	13.1	3	10	6.8
M10x1.5	M12~M48x1.5	1.5	10082L15-I1.50ISO		10	8.20	73	15.0	15.7	3	10	8.5
M12x1.75		1.75	10099L18-I1.75ISO		10	9.90	73	17.5	18.4	4	10	10.2
M14x2.0	M17~M80x2.0	2.0	12116L21-I2.00ISO		12	11.60	73	20.0	21.0	4	10	12.0
M16x2.0	M17~M80x2.0	2.0	14136L25-I2.00ISO		14	13.60	92	24.0	25.0	4	12	14.0

($l_2 \leq 2 \times \text{Thread Diameter}$)

Thread		Pitch (mm)	Designation	PC9070M	Dimensions (mm)					No. of flute	Tooth	*Bore dia. mm
M Coarse	M Fine				Internal	Ød	D	L	l ₁			
M3x0.5	M3.5~M16x0.5	0.5	STMHC 04024L06-I0.50ISO		4	2.40	45	6.0	6.2	3	12	2.5
	M4x0.5	0.5	04032L08-I0.50ISO		4	3.20	45	8.0	8.2	3	16	3.5
	M5x0.5	0.5	06042L10-I0.50ISO		6	4.20	57	10.0	10.2	3	20	4.5
M4x0.7		0.7	04031L08-I0.70ISO		4	3.15	45	8.4	8.7	3	12	3.3
	M6x0.75	0.75	06050L12-I0.75ISO		6	5.00	57	12.0	12.4	3	16	5.3
M5x0.8		0.8	04039L10-I0.80ISO		4	3.90	45	10.4	10.8	3	13	4.2
M6x1.0	M8~M40x1.0	1.0	06048L12-I1.00ISO	●	6	4.80	57	12.0	12.5	3	12	5.0
	M8x1.0	1.0	08067L16-I1.00ISO		8	6.70	61	16.0	16.5	3	16	7.0
	M10x1.0	1.0	10087L20-I1.00ISO		10	8.70	73	20.0	20.5	3	20	9.0
	M12x1.0	1.0	12107L24-I1.00ISO	●	12	10.70	73	24.0	24.5	4	24	11.0
M8x1.25		1.25	08065L16-I1.25ISO	●	8	6.50	61	16.2	16.9	3	13	6.8
	M10x1.25	1.25	10085L20-I1.25ISO	●	10	8.50	73	20.0	20.6	3	16	8.8
M10x1.5	M12~M48x1.5	1.5	10082L20-I1.50ISO	●	10	8.20	73	19.5	20.2	3	13	8.5
	M12x1.5	1.5	10099L24-I1.50ISO	●	10	9.90	73	24.0	24.7	4	16	10.5
	M14x1.5	1.5	12119L29-I1.50ISO		12	11.90	80	28.5	29.2	4	19	12.5
	M16x1.5	1.5	14139L32-I1.50ISO		14	13.90	92	31.5	32.2	4	21	14.5
M12x1.75		1.75	10099L25-I1.75ISO		10	9.90	73	24.5	25.4	4	14	10.2
M14x2.0	M17~M80x2.0	2.0	12116L29-I2.00ISO		12	11.60	80	28.0	29.0	4	14	12.0
M16x2.0	M17~M80x2.0	2.0	14136L33-I2.00ISO		14	13.60	92	32.0	33.0	4	16	14.0
M18x2.5		2.5	16148L36-I2.50ISO		16	14.80	92	35.0	36.2	4	14	15.5
M 20x2.5		2.5	18171L41-I2.50ISO		18	17.10	102	40.0	41.2	4	16	17.5
M 24x3.0		3.0	20199L49-I3.00ISO		20	19.90	102	48.0	49.5	4	16	21.0

* Bore Diameter applies to smallest thread Dia

Maximum thread length = $l_2 - \frac{\text{Pitch}}{4}$

●: Stock item

D Solid Threading Endmills

American UN

Helical flutes with thru-hole coolant

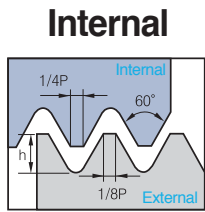

Defined by: ANSI B1.1.74
Tolerance class: 2B

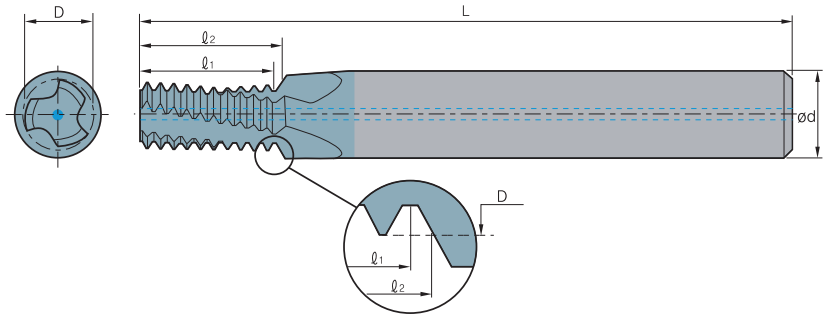

($l_2 \leq 1.5 \times \text{Thread Diameter}$)

Thread			Pitch (tpi)	Designation	PC9070M	Dimensions (mm)					No. of flute	Tooth	*Bore dia. mm	
UNC	UNF	UNEF				Internal	Ød	D	L	l ₁				l ₂
No.10~24	5/16", 3/8"x24	9/16"~11/16"x24	24	STMHC	04035L07-I24UNC		4	3.58	45	7.4	7.9	3	7	3.8
No.10~24	5/16", 3/8"x24	9/16"~11/16"x24	24		06041L08-I24UNC		6	4.15	57	8.5	9.0	3	8	4.5
1/4"x20	7/16", 1/2"x20	3/4"~1"x20	20		06048L09-I20UNC		6	4.88	57	8.9	9.5	3	7	5.2
5/16"x18	9/16", 5/8"x18	11/16"~1 11/16"x18	18		08061L11-I18UNC		8	6.15	61	11.3	12.0	3	8	6.5
3/8"x16	3/4"x16		16		08076L15-I16UNC		8	7.65	61	14.3	15.1	3	9	8.0
7/16"x14	7/8"x14		14		10090L17-I14UNC		10	9.00	73	16.3	17.2	3	9	9.3
1/2"x13			13		12104L20-I13UNC		12	10.35	73	19.5	20.5	4	10	10.8
9/16"x12	1"~1 1/2"x12		12		12118L22-I12UNC		12	11.80	73	21.2	22.2	4	10	12.3

($l_2 \leq 2 \times \text{Thread Diameter}$)

Thread			Pitch (tpi)	Designation	PC9070M	Dimensions (mm)					No. of flute	Tooth	*Bore dia. mm	
UNC	UNF	UNEF				Internal	Ød	D	L	l ₁				l ₂
	No.10~32	No. 12~3/8"x32	32	STMHC	04038L09-I32UNF		4	3.80	45	9.5	9.9	3	12	4.0
		No. 12~3/8"x32	32		06044L11-I32UNEF		6	4.40	57	11.1	11.5	3	14	4.7
	No.12, 1/4"x28	7/16"; 1/2"x28	28		06043L11-I28UNF		6	4.30	57	10.9	11.3	3	12	4.6
	1/4"x28	7/16"; 1/2"x28	28		06052L13-I28UNF		6	5.15	57	12.7	13.1	3	14	5.5
		7/16"; 1/2"x28	28		10099L22-I28UNEF		10	9.90	73	21.8	22.2	3	24	10.2
No.10~24	5/16", 3/8"x24	9/16"~11/16"x24	24		04035L10-I24UNC		4	3.58	45	9.5	10.0	3	9	3.8
No.12~24	5/16", 3/8"x24	9/16"~11/16"x24	24		06041L11-I24UNC		6	4.15	57	10.6	11.1	3	10	4.5
	5/16", 3/8"x24	9/16"~11/16"x24	24		08066L16-I24UNF		8	6.68	61	15.9	16.4	3	15	6.8
	3/8"x24	9/16"~11/16"x24	24		10082L19-I24UNF		10	8.20	73	19.0	19.6	3	18	8.5
		9/16"~11/16"x24	24		14129L29-I24UNEF		14	12.90	92	28.6	29.1	4	27	13.2
1/4"x20	7/16", 1/2"x20	3/4"~1"x20	20		06048L13-I20UNC		6	4.88	57	12.7	13.3	3	10	5.2
	7/16", 1/2"x20	3/4"~1"x20	20		10096L22-I20UNF		10	9.60	73	21.6	22.2	3	17	9.8
	1/2"x20	3/4"~1"x20	20	12111L26-I20UNF		12	11.10	80	25.4	26.0	3	20	11.5	
		3/4"~1"x20	20	18174L38-I20UNEF		18	17.40	102	38.1	38.7	4	30	17.8	
5/16"x18	9/16", 5/8"x18	11/16"~1 11/16"x18	18	08061L16-I18UNC		8	6.15	61	15.5	16.2	3	11	6.5	
	9/16", 5/8"x18	11/16"~1 11/16"x18	18	14125L28-I18UNF		14	12.50	92	28.2	28.9	4	20	12.8	
	5/8"x18	11/16"~1 11/16"x18	18	16141L31-I18UNF		16	14.10	92	31.0	31.7	4	22	14.5	
3/8"x16	3/4"x16		16	08076L19-I16UNC		8	7.65	61	19.0	19.8	3	12	8.0	
	3/4"x16		16	18170L38-I16UNF		18	17.00	102	38.1	38.8	4	24	17.5	
7/16"x14	7/8"x14		14	10090L22-I14UNC		10	9.00	73	21.8	22.7	3	12	9.3	
	7/8"x14		14	20199L44-I14UNF		20	19.90	102	43.5	44.4	4	24	20.5	
1/2"x13			13	12104L26-I13UNC		12	10.35	80	25.4	26.4	4	13	10.8	
9/16"x12	1"~1 1/2"x12		12	12118L28-I12UNC		12	11.80	80	27.5	28.6	4	13	12.3	
	1"~1 1/2"x12		12	20199L51-I12UNF		20	19.90	102	50.8	51.9	4	24	23.5	
5/8"x11			11	14131L33-I11UNC		14	13.10	92	32.3	33.5	4	14	13.5	
3/4"x10			10	16159L39-I10UNC		16	15.90	92	38.1	39.4	4	15	16.5	
7/8"x9			9	20190L46-I9UNC		20	19.00	102	45.2	46.6	4	16	19.5	
1"x8			8	20199L52-I8UNC		20	19.90	102	50.8	52.4	4	16	22.0	

* Bore Diameter applies to smallest thread Dia

Maximum thread length = $l_2 - \frac{\text{Pitch}}{4}$

● Stock item



D

Threading

Whitworth

Helical flutes with thru-hole coolant

External/Internal

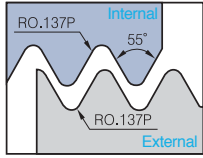

Defined by: B.S.84: 1956,
DIN 259, ISO228/1: 1982
Tolerance class: Medium class A

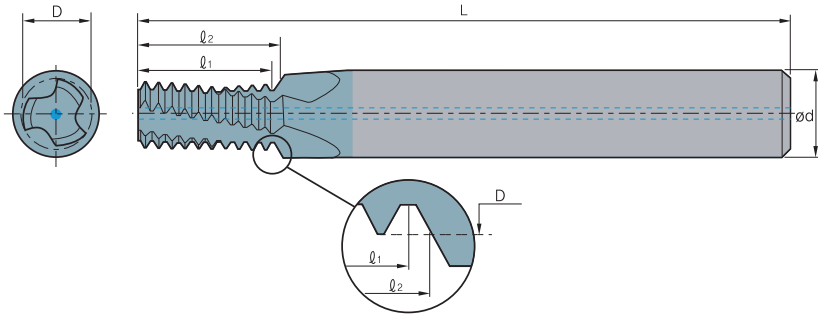

($l_2 \leq 2 \times \text{Thread Diameter}$)

Thread		Pitch (tpi)	Designation		PC9070M	Dimensions (mm)					No. of flute z	Tooth zt	*Bore dia. mm
BSW	BSF		External/Internal			Ød	D	L	l1	l2			
	1/4"×26	26	STMHC	06050L13-EI26BSF		6	5.00	57	12.7	13.2	3	13	5.3
	5/16"×22	22		08063L16-EI22BSF		8	6.35	61	16.2	16.7	3	14	6.7
1/4"×20	3/8"×20	20		06044L13-EI20BSW		6	4.45	57	12.7	13.3	3	10	5.0
	3/8"×20	20		08076L19-EI20BSF		8	7.65	61	19.0	19.7	3	15	8.2
5/16"×18	7/16"×18	18		06058L16-EI18BSW		6	5.85	57	15.5	16.2	3	11	6.5
	7/16"×18	18		10092L23-EI18BSF		10	9.20	73	22.6	23.3	3	16	9.7
3/8"×16	1/2", 9/16"×16	16		08072L19-EI16BSW		8	7.20	61	19.0	19.8	3	12	7.9
	1/2", 9/16"×16	16		12105L26-EI16BSF		12	10.50	80	25.4	26.2	4	16	11.1
	9/16"×16	16		14122L29-EI16BSF		14	12.15	92	28.6	29.4	4	18	12.6
7/16"×14	5/8", 11/16"×14	14		10085L22-EI14BSW		10	8.50	73	21.8	22.7	3	12	9.2
	5/8", 11/16"×14	14		14134L31-EI14BSF		14	13.40	92	30.8	31.7	4	17	14.0
	11/16"×14	14		16150L35-EI14BSF		16	15.00	92	34.5	35.4	4	19	15.6
1/2"×12	3/4"×12	12		10096L26-EI12BSW		10	9.65	73	25.4	26.5	3	12	10.5
9/16"×12	3/4"×12	12		12113L28-EI12BSW		12	11.25	80	27.5	28.6	4	13	12.1
	3/4"×12	12		18162L39-EI12BSF		18	16.20	102	38.1	39.2	4	18	16.8
5/8"×11	7/8"×11	11		14126L33-EI11BSW		14	12.60	92	32.3	33.5	4	14	13.4
11/16"×11		11		16142L35-EI11BSW		16	14.20	92	34.6	35.8	4	15	15.0

● Stock item

BSPT

Helical flutes with thru-hole coolant

External/Internal

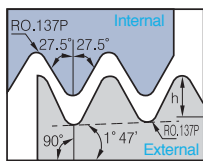

Defined by: B.S.21 : 1985
Tolerance class: Standard BSPT

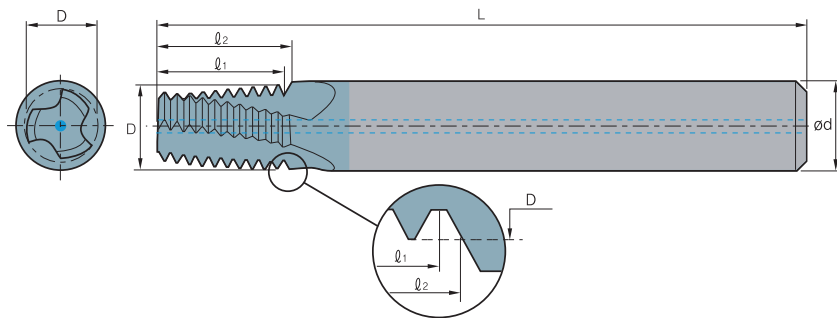

Thread		Pitch (tpi)	Designation		PC9070M	Dimensions (mm)					No. of flute z	Tooth zt	*Bore dia. mm
Standard			Internal			Ød	D	L	l1	l2			
1/16"×28	28	STMHC	06059L10-EI28BSPT		6	5.90	57	10.0	10.2	3	11	6.7	
1/8"×28	28		08076L10-EI28BSPT		8	7.65	61	10.0	10.2	3	11	8.7	
1/4"×19	19		10099L15-EI19BSPT		10	9.90	73	14.7	15.4	3	11	11.8	
3/8"×19	19		12111L15-EI19BSPT		12	11.15	73	14.7	15.4	4	11	15.2	
1/2", 3/4"×14	14		16142L22-EI14BSPT		16	14.25	92	21.8	22.7	4	12	19.0	
1", 1 1/2", 2", 2 1/2"×11	11		20196L28-EI11BSPT		20	19.60	102	27.7	28.9	4	12	30.7	

* Bore Diameter applies to smallest thread Dia

$$\text{Maximum thread length} = l_2 - \frac{\text{Pitch}}{4}$$

● Stock item

D Solid Threading Endmills

NPT

Helical flutes with thru-hole coolant

External/Internal

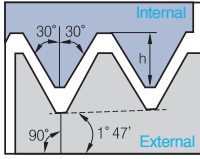

Defined by: USAS B2.1: 1968
Tolerance class: Standard NPT

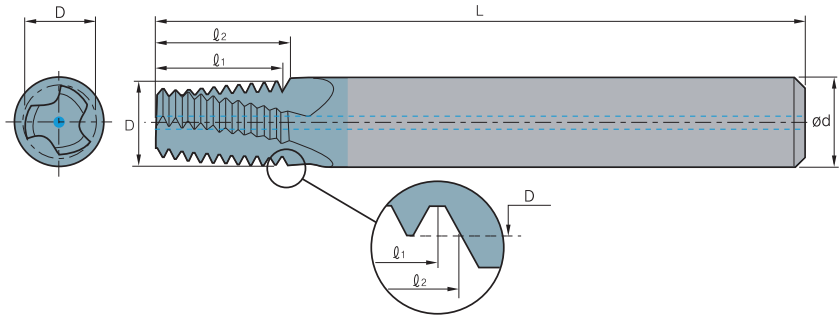

Thread Standard	Pitch (tpi)	Designation	PC9070M	Dimensions (mm)					No. of flute z	Tooth zt	*Bore dia. mm	
				Internal	Ød	D	L	l1				l2
1/16"×27	27	STMHC	●	06059L09-EI27NPT	6	5.90	57	9.4	9.9	3	10	6.3
1/8"×27	27		08076L09-EI27NPT	8	7.65	61	9.4	9.9	3	10	8.5	
1/4"×18	18		10099L14-EI18NPT	●	10	9.90	73	14.1	14.8	3	10	11.1
3/8"×18	18		12111L14-EI18NPT		12	11.15	73	14.1	14.8	4	10	14.5
1/2", 3/4"×14	14		16142L19-EI14NPT		16	14.25	92	18.1	19.0	4	10	17.7, 23.0
1", 1 1/4, 1 1/2", 2"×11.5	11.5		20196L23-EI11.5NPT		20	19.60	102	22.1	23.2	4	10	29.0, 37.7, 44.0, 56.0
2 1/2"×8 ; 3"×8	8		20196L33-EI8NPT		20	19.60	102	31.7	33.3	4	10	66.5, 82.1

NPTF

Helical flutes with thru-hole coolant

External/Internal

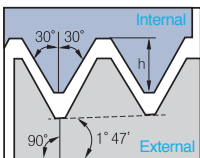

Defined by: ANSI 1.20.3-1976
Tolerance class: Standard NPTF

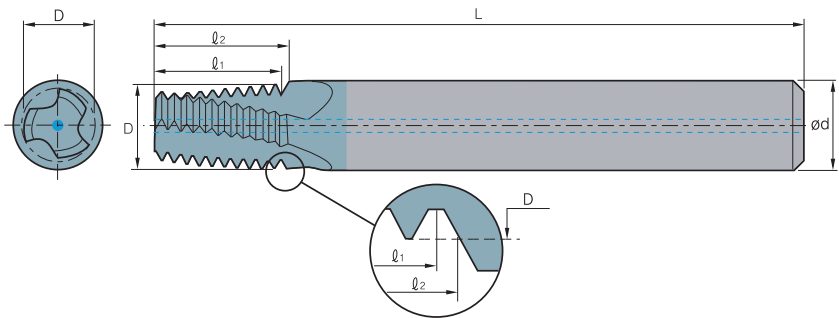

Thread Standard	Pitch (tpi)	Designation	PC9070M	Dimensions (mm)					No. of flute z	Tooth zt	*Bore dia. mm	
				Internal	Ød	D	L	l1				l2
1/16"×27	27	STMHC	●	06059L09-EI27NPTF	6	5.90	57	9.4	9.9	3	10	6.3
1/8"×27	27		08076L09-EI27NPTF		8	7.65	61	9.4	9.9	3	10	8.5
1/4"×18	18		10099L14-EI18NPTF		10	9.90	73	14.1	14.8	3	10	11.1
3/8"×18	18		12111L14-EI18NPTF		12	11.15	73	14.1	14.8	4	10	14.5
1/2", 3/4"×14	14		16142L19-EI14NPTF		16	14.25	92	18.1	19.0	4	10	17.7, 23.4
1", 1 1/4, 1 1/2", 2"×11.5	11.5		20196L23-EI11.5NPTF		20	19.60	102	22.1	23.2	4	10	29.0, 37.7, 43.7, 55.6
2 1/2"×8 ; 3"×8	8		20196L33-EI8NPTF		20	19.60	102	31.7	33.3	4	10	66.3, 82.1

* Bore Diameter applies to smallest thread Dia

$$\text{Maximum thread length} = l_2 - \frac{\text{Pitch}}{4}$$

●: Stock item



ISO Metric

Helical flutes with radial cooling

Internal

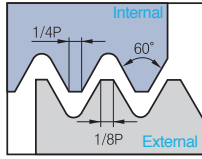

Defined by: R262 (DIN 13)
Tolerance class: 6H

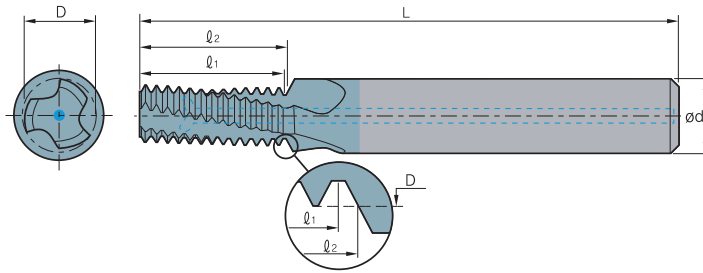

($l_2 \leq 2 \times \text{Thread Diameter}$)

Thread		Pitch (mm)	Designation	PC9070M	Dimensions (mm)					No. of flute	Tooth	*Bore dia. mm
M Coarse	M Fine				Internal	Ød	D	L	l ₁			
M6x1.0	M8~M40x1.0	1.0	STMHCR	06048L12-I1.00ISO	6	4.8	57	12.0	12.5	3	12	5.0
	M10x1.0	1.0		10087L20-I1.00ISO	10	8.7	73	20.0	20.5	3	20	9.0
	M12x1.0	1.0		12107L24-I1.00ISO	12	10.7	73	24.0	24.5	4	24	11.0
M8x1.25		1.25		08065L16-I1.25ISO	8	6.5	64	16.3	16.9	3	13	6.8
M10x1.5	M12~M48x1.5	1.5		10082L20-I1.50ISO	10	8.2	73	19.5	20.3	3	13	8.5
	M12x1.5	1.5		10099L24-I1.50ISO	10	9.9	73	24.0	24.8	4	16	10.5
	M14x1.5	1.5		12119L29-I1.50ISO	12	11.9	84	28.5	29.3	4	19	12.5
M12x1.75	M16x1.5	1.5		14139L32-I1.50ISO	14	13.9	84	31.5	32.3	4	21	14.5
		1.75		10099L25-I1.75ISO	10	9.9	73	24.5	25.4	4	14	10.2

ISO Metric

Helical flutes with thru-hole coolant-thru & Chamfer

Internal

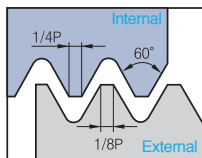

Defined by: R262 (DIN 13)
Tolerance class: 6H

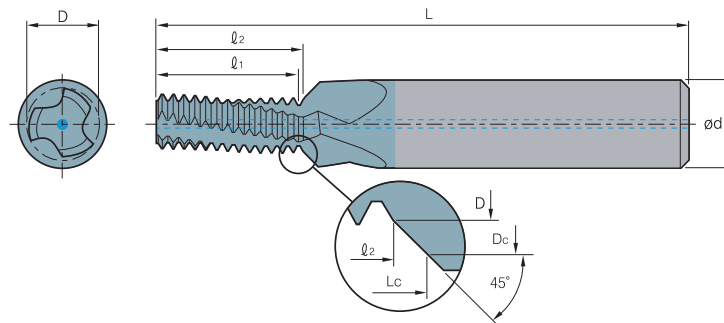

($l_2 \leq 2 \times \text{Thread Diameter}$)

Thread		Pitch (mm)	Designation	PC9070M	Dimensions (mm)							No. of flute	Tooth	*Bore dia. mm
M Coarse	M Fine				Internal	Ød	D	Dc	L	l ₁	l ₂			
M6x1.0	M8~M40x1.0	1.0	STMHCC	08048L12-I1.00ISO	8	4.8	6.3	61	12.0	12.5	13.3	3	12	5.0
	M10x1.0	1.0		12087L20-I1.00ISO	12	8.7	10.3	73	20.0	20.5	21.3	3	20	9.0
	M12x1.0	1.0		14107L24-I1.00ISO	14	10.7	12.3	80	24.0	24.5	25.3	4	24	11.0
M8x1.25		1.25		10065L16-I1.25ISO	10	6.5	8.3	73	16.3	16.9	17.8	3	13	6.8
M10x1.5	M12~M48x1.5	1.5		12082L20-I1.50ISO	12	8.2	10.3	80	19.5	20.3	21.3	3	13	8.5
	M12x1.5	1.5		14099L24-I1.50ISO	14	9.9	12.3	80	24.0	24.8	26.0	4	16	10.5
	M14x1.5	1.5		16119L29-I1.50ISO	16	11.9	14.3	92	28.5	29.3	30.5	4	19	12.5
M12x1.75	M16x1.5	1.5		18139L32-I1.50ISO	18	13.9	16.3	92	31.5	32.3	33.5	4	21	14.5
		1.75		14099L25-I1.75ISO	14	9.9	12.3	80	24.5	25.4	26.6	4	14	10.2

* Bore Diameter applies to smallest thread Dia

Maximum thread length = $l_2 - \frac{\text{Pitch}}{4}$

● Stock item

D Solid Threading Endmills

ISO Metric

Drill, Chamfer & Thread with thru-hole coolant

Internal

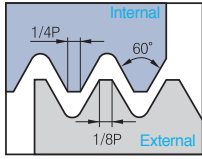

Defined by: R262 (DIN 13)
Tolerance class: 6H

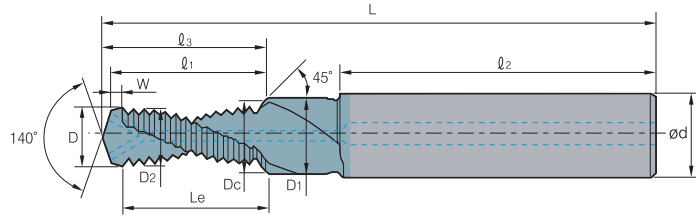

Thread	Pitch (mm)	Designation		PC9070M	Dimensions (mm)										No. of flute	Tooth	
		Internal			L	l ₃	l ₁	l ₂	W	Le	D	Ød	D ₁	D _c			D ₂
M6×1.0	1.0	STMHCD	IM6×1.0ISO-2D		62.0	14.5	13.7	36	1.0	12.7	5.0	8	6.6	6.3	4.85	2	11
M8×1.25	1.25		IM8×1.25ISO-2D		74.0	18.2	17.1	40	1.3	15.8	6.8	10	9.0	8.3	6.45	2	11
M10×1.5	1.5		IM10×1.5ISO-2D		79.0	23.4	22.1	45	1.5	20.6	8.5	12	11.0	10.3	8.08	2	12
M12×1.75	1.75		IM12×1.75ISO-2D		89.0	27.1	25.5	45	1.5	24.0	10.3	14	13.5	12.3	9.74	2	12

Thread	Pitch (mm)	Designation		PC9070M	Dimensions (mm)										No. of flute	Tooth	
		Internal			L	l ₃	l ₁	l ₂	W	Le	D	Ød	D ₁	D _c			D ₂
M6×1.0	1.0	STMHCD	IM6×1.0ISO-2.5D		62.0	16.5	15.7	36	1.0	14.7	5.0	8	6.6	6.3	4.85	2	13
M8×1.25	1.25		IM8×1.25ISO-2.5D		74.0	23.2	22.1	40	1.3	20.8	6.8	10	9.0	8.3	6.45	2	15
M10×1.5	1.5		IM10×1.5ISO-2.5D		79.0	27.9	26.6	45	1.5	25.1	8.5	12	11.0	10.3	8.08	2	15

Maximum thread length = $l_2 - \frac{\text{Pitch}}{4}$

●: Stock item



ISO Metric

Deep threading

Internal

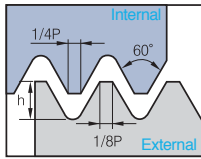

Defined by: R262 (DIN 13)
Tolerance class: 6H

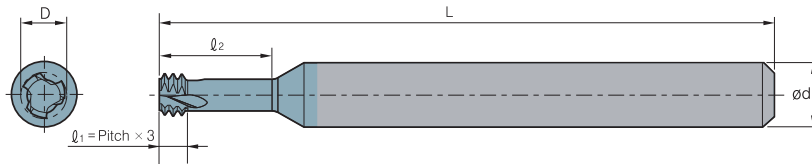

($l_2 \leq 2 \times \text{Thread Diameter}$)

Thread		Pitch (mm)	Designation	PC9070M	Dimensions (mm)				No. of flute	Tooth	*Bore dia. mm
M Coarse	M Fine				Ød	D	L	l ₂			
M1.6x0.35		0.35	STMD3T	03012L034-I0.35ISO	3	1.20	30	3.4	3	3	1.25
M2x0.4		0.4		06015L042-I0.4ISO	6	1.55	57	4.2	3	3	1.6
M2.2x0.45		0.45		06016L046-I0.45ISO	6	1.65	57	4.6	3	3	1.75
M2.5x0.45		0.45		06019L052-I0.45ISO	6	1.95	57	5.2	3	3	2.05
M3x0.5	M3.5~M16x0.5	0.5		06024L062-I0.5ISO	6	2.40	57	6.2	3	3	2.5
M3.5x0.6		0.6		06027L073-I0.6ISO	6	2.75	57	7.3	3	3	2.9
M4x0.7		0.7		06031L083-I0.7ISO	6	3.15	57	8.3	3	3	3.3
M5x0.8		0.8		06040L104-I0.8ISO	6	4.05	57	10.4	3	3	4.2
M6x1.0	M8~M40x1.0	1.0		06048L125-I1.0ISO	6	4.80	57	12.5	3	3	5.0
M8x1.25		1.25		08065L166-I1.25ISO	8	6.50	63	16.6	3	3	6.8
M10x1.5	M12~M48x1.50	1.5		10082L208-I1.50ISO	10	8.20	73	20.8	3	3	8.5
M12x1.75		1.75		10099L250-I1.75ISO	10	9.90	73	25.0	3	3	10.3

3d ($l_2 \leq 3 \times \text{Thread Diameter}$)

Thread		Pitch (mm)	Designation	PC9070M	Dimensions (mm)				No. of flute	Tooth	*Bore dia. mm
M Coarse	M Fine				Ød	D	L	l ₂			
M1.6x0.35		0.35	STMD3T	03012L050-I0.35ISO	3	1.20	30	5.0	3	3	1.25
M2x0.4		0.4		06015L062-I0.4ISO	6	1.55	57	6.2	3	3	1.6
M2.5x0.45		0.45		06019L077-I0.45ISO	6	1.95	57	7.0	3	3	2.05
M3x0.5	M3.5~M16x0.5	0.5		06024L092-I0.5ISO	6	2.40	57	9.2	3	3	2.5
M4x0.7		0.7		06031L123-I0.7ISO	6	3.15	57	12.3	3	3	3.3
M5x0.8		0.8		06040L154-I0.8ISO	6	4.05	57	15.4	3	3	4.2
M6x1.0	M8~M40x1.0	1.0		06048L185-I1.0ISO	6	4.80	57	18.5	3	3	5.0
M8x1.25		1.25		08065L246-I1.25ISO	8	6.50	63	24.6	3	3	6.8

* Bore Diameter applies to smallest thread Dia

Maximum thread length = $l_2 - \frac{\text{Pitch}}{4}$

● Stock item

American UN

Deep threading

Internal

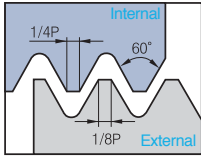

Defined by: ANSI B1.1.74
Tolerance class: 2B

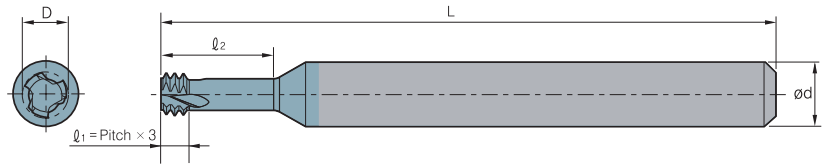

($\varnothing_2 \leq 2 \times \text{Thread Diameter}$)

Thread		Pitch (tpi)	Designation	PC9070M	Dimensions (mm)				No. of flute	Tooth	*Bore dia. mm
UNC	UNF				$\varnothing d$	D	L	\varnothing_2			
	No.1~72	72	STMD3T	06014L039-I72UN	6	1.45	57	3.9	3	3	1.6
No.1~64	No.2~64	64		06014L042-I64UN	6	1.40	57	4.2	3	3	1.5
No.2~56	No.3~56	56		06016L050-I56UN	6	1.65	57	5.0	3	3	1.8
No.3~48	No.4~48	48		06019L060-I48UN	6	1.90	57	6.0	3	3	2.1
No.4, No.5~40	No.6~40	40		06021L060-I40UN	6	2.10	57	6.0	3	3	2.3
No.5~40	No.6~40	40		06024L072-I40UN	6	2.45	57	7.2	3	3	2.6
	No.8~36	36		06033L087-I36UN	6	3.30	57	8.7	3	3	3.5
No.6, No.8~32	No.10~32	32		06025L074-I32UN	6	2.55	57	7.4	3	3	2.8
No.8~32	No.10~32	32		06032L100-I32UN	6	3.20	57	10.0	3	3	3.5
	1/4" x 28	28		06052L132-I28UN	6	5.25	57	13.2	3	3	5.5
No.10~24	5/16" x 24	24		06035L102-I24UN	6	3.58	57	10.2	3	3	3.9
	5/16" x 24	24		08066L165-I24UN	8	6.68	63	16.5	3	3	6.9
1/4" x 20	7/16" x 20	20		06048L134-I20UN	6	4.88	57	13.4	3	3	5.2
	7/16" x 20	20		10095L230-I20UN	10	9.55	73	23.0	3	3	9.9
3/8" x 16		16	08067L191-I16UN	8	6.70	63	19.1	3	3	8.0	
7/16" x 14		14	10090L233-I14UN	10	9.00	73	23.3	3	3	9.4	

($\varnothing_2 \leq 3 \times \text{Thread Diameter}$)

Thread		Pitch (tpi)	Designation	PC9070M	Dimensions (mm)				No. of flute	Tooth	*Bore dia. mm
UNC	UNF				$\varnothing d$	D	L	\varnothing_2			
	No.1~72	72	STMD3T	06014L057-I72UN	6	1.45	57	5.75	3	3	1.6
No.4, No.5~40	No.6~40	40		06021L090-I40UN	6	2.10	57	9.0	3	3	2.3
No.5~40	No.6~40	40		06024L100-I40UN	6	2.45	57	10.0	3	3	2.6
No.6, No.8~32	No.10~32	32		06025L110-I32UN	6	2.55	57	11.0	3	3	2.8
No.8~32	No.10~32	32		06032L130-I32UN	6	3.20	57	13.0	3	3	3.4
	1/4" 28	28		06052L196-I28UN	6	5.25	57	19.6	3	3	5.5
	5/16" x 24	24		08066L245-I24UN	8	6.68	63	24.5	3	3	6.9
1/4" x 20	7/16" x 20	20		06048L198-I20UN	6	4.88	57	19.8	3	3	5.1

* Bore Diameter applies to smallest thread Dia

$$\text{Maximum thread length} = \varnothing_2 - \frac{\text{Pitch}}{4}$$

● Stock item



ISO Metric

Deep threading for hard materials (~HRC62)

Internal

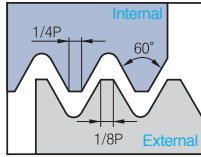

Defined by: R262 (DIN 13)
Tolerance class: 6H

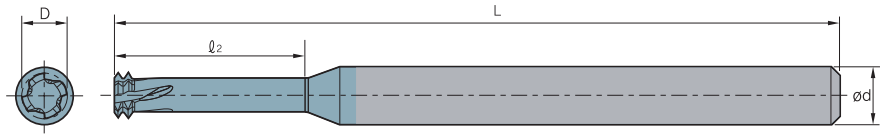

($l_2 \leq 2 \times \text{Thread Diameter}$)

Thread		Pitch (mm)	Designation	PC9070M	Dimensions (mm)				No. of flute	Tooth	*Bore dia. mm
M Coarse	M Fine				Internal	Ød	D	L			
M2x0.4		0.4	STMD2L	06015L042-I0.4ISO	6	1.55	76	4.60	4	2	1.6
M2.2x0.45		0.45		06016L046-I0.45ISO	6	1.65	76	5.05	4	2	1.8
M2.5x0.45		0.45		06019L052-I0.45ISO	6	1.95	76	5.65	4	2	2.05
M3x0.5	M3.5~M16x0.5	0.5		06024L062-I0.5ISO	6	2.40	76	6.75	4	2	2.55
M3.5x0.6		0.6		06027L073-I0.6ISO	6	2.75	76	7.90	4	2	2.95
M4x0.7		0.7		06031L083-I0.7ISO	6	3.15	76	9.05	4	2	3.35
M5x0.8		0.8		06040L104-I0.8ISO	6	4.05	76	11.20	4	2	4.3
M6x1.0	M8~M40x1.0	1.0		06048L125-I1.0ISO	6	4.80	76	13.50	4	2	5.1
M8x1.25		1.25		08065L166-I1.25ISO	8	6.50	80	17.85	4	2	6.8
M10x1.5	M12~M48x1.50	1.5		08079L208-I1.50ISO	8	7.90	80	22.30	4	2	8.6
M12x1.75		1.75		10099L250-I1.75ISO	10	9.90	101	26.75	4	2	10.4

($l_2 \leq 3 \times \text{Thread Diameter}$)

Thread		Pitch (mm)	Designation	PC9070M	Dimensions (mm)				No. of flute	Tooth	*Bore dia. mm
M Coarse	M Fine				Internal	Ød	D	L			
M2x0.4		0.4	STMD2L	06015L062-I0.4ISO	6	1.55	76	6.60	4	2	1.6
M2.2x0.45		0.45		06019L077-I0.45ISO	6	1.95	76	8.15	4	2	2.05
M3x0.5	M3.5~M16x0.5	0.5		06024L092-I0.5ISO	6	2.40	76	9.75	4	2	2.55
M4x0.7		0.7		06031L123-I0.7ISO	6	3.15	76	13.05	4	2	3.35
M5x0.8		0.8		06040L154-I0.8ISO	6	4.05	76	16.20	4	2	4.3
M6x1.0	M8~M40x1.0	1.0		06048L185-I1.0ISO	6	4.80	76	19.50	4	2	5.1
M8x1.25		1.25		08065L246-I1.25ISO	8	6.50	80	25.85	4	2	6.8

* Bore Diameter applies to smallest thread Dia

Maximum thread length = $l_2 - \frac{\text{Pitch}}{4}$

● Stock item

American UN

Deep threading for hard materials (~HRC62)

Internal

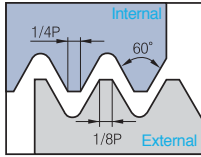

Defined by: ANSI B1.1.74
Tolerance class: 2B

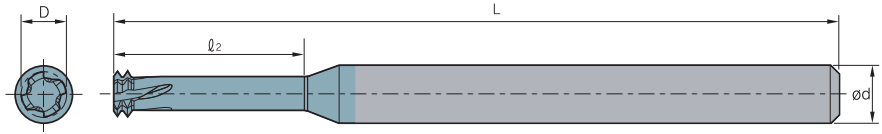

($l_2 \leq 2 \times \text{Thread Diameter}$)

Thread		Pitch (tpi)	Designation		PC9070M	Dimensions (mm)				No. of flute	Tooth	*Bore dia. mm
UNC	UNF		Internal			Ød	D	L	l ₂			
No.2~56	No.3~56	56	STMD2L	06016L050-I56UN	6	1.65	76	5.45	4	2	1.80	
No.3~48	No.4~48	48		06019L060-I48UN	6	1.90	76	6.53	4	2	2.10	
No.4~40 ; No.5~40	No.6~40	40		06021L060-I40UN	6	2.10	76	6.64	4	2	2.35	
No.5~40	No.6~40	40		06024L072-I40UN	6	2.45	76	7.84	4	2	2.65	
	No.8~36	36		06033L087-I36UN	6	3.30	76	9.41	4	2	3.55	
No.6~32 ; No.8~32	No.10~32	32		06025L074-I32UN	6	2.55	76	8.20	4	2	2.85	
No.8~32	No.10~32	32		06032L100-I32UN	6	3.20	76	10.79	4	2	3.50	
	1/4"×28	28		06052L132-I28UN	6	5.25	76	14.11	4	2	5.55	
No.10~24	5/16"×24	24		06035L102-I24UN	6	3.58	76	11.26	4	2	3.90	
	5/16"×24	24		08066L165-I24UN	8	6.68	76	17.56	4	2	7.00	
1/4"×20	7/16"×20	20		06048L134-I20UN	6	4.88	76	14.67	4	2	5.20	
	7/16"×20	20		10095L230-I20UN	10	9.55	101	24.27	4	2	9.90	
3/8"×16		16		08076L197-I16UN	8	7.65	80	21.29	4	2	8.00	
7/16"×14		14		10090L233-I14UN	10	9.00	101	25.11	4	2	9.50	
1/2"×13		13		10099L256-I13UN	10	9.90	101	27.55	4	2	10.90	

($l_2 \leq 3 \times \text{Thread Diameter}$)

Thread		Pitch (tpi)	Designation		PC9070M	Dimensions (mm)				No. of flute	Tooth	*Bore dia. mm
UNC	UNF		Internal			Ød	D	L	l ₂			
No.4~40, No.5~40	No.6~40	40	STMD2L	06021L090-I40UN	6	2.10	76	9.64	4	2	2.35	
No.5~40	No.6~40	40		06024L100-I40UN	6	2.45	76	10.64	4	2	2.65	
No.6~32, No.8~32	No.10~32	32		06025L110-I32UN	6	2.55	76	11.79	4	2	2.85	
No.8~32	No.10~32	32		06032L130-I32UN	6	3.20	76	13.79	4	2	3.50	
	1/4"×28	28		06052L196-I28UN	6	5.25	76	20.51	4	2	5.55	
	5/16"×24	24		08066L245-I24UN	8	6.68	80	25.56	4	2	7.00	
1/4"~20	7/16"×20	20		06048L198-I20UN	6	4.88	76	21.07	4	2	5.20	
7/16"×14		14		10090L335-I14UN	10	9.00	101	35.31	4	2	9.50	

* Bore Diameter applies to smallest thread Dia

Maximum thread length = $l_2 - \frac{\text{Pitch}}{4}$

● Stock item



High performance carbide tap and HSS tap

TAP

- Highly durable carbide tap and HSS tap
- A variety of taps including point taps, spiral taps, straight taps, roll taps, and more to meet a wide range of requirements, available for JIS and DIN standards in metric threads
- Custom orders can be made for powder HSS and taps under M3

Features

- Carbide type and HSS type
 - Carbide Taps: High toughness substrate
 - HSS: High vanadium substrate
- Applicable to various workpiece forms
 - A wide selection composed of point taps, spiral taps, straight taps, roll taps and more
- Metric threads standardized
 - JIS, DIN standard and special tools
- Broad line-ups per type and size
 - A wide choice with various types and sizes



Code system

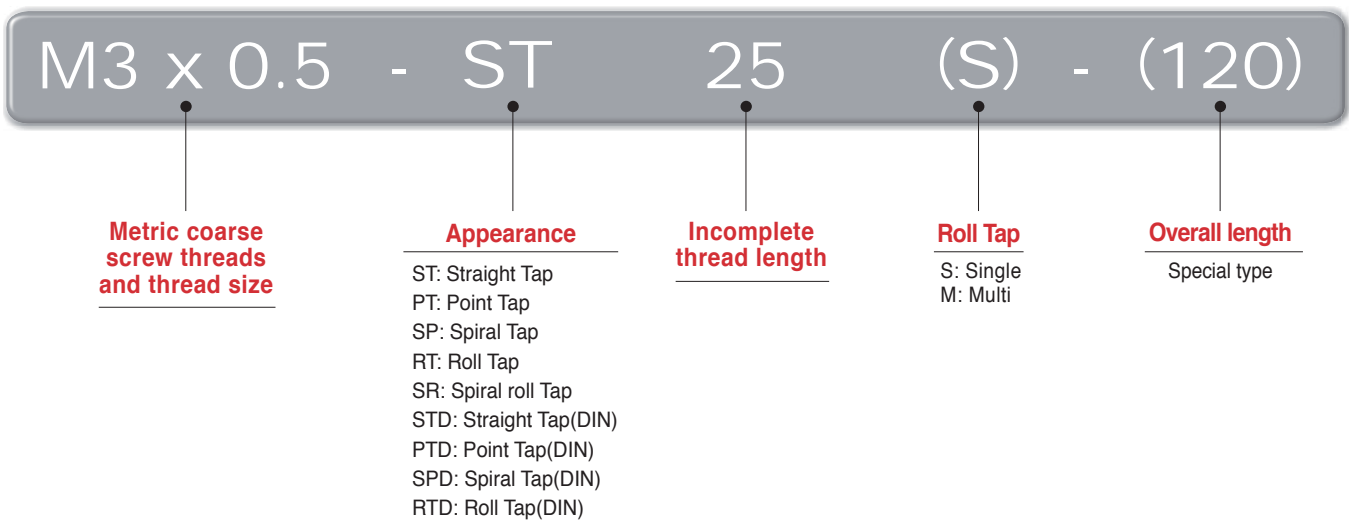





Grade system

Carbide Tap		HSS Tap	
FN30T	Carbide, Uncoated	HN30T	HSS, Uncoated
PC20T	Carbide, TiN coating	HC20T	HSS, TiN coating
PC10T	Carbide, TiCN coating	HC10T	HSS, TiCN coating
-	-	HH30T	HSS, Steam Oxide



D Technical Information for Tap

Carbide tap

Tap type		Picture	Features	Grade	Size
ST	Straight tap		<ul style="list-style-type: none"> • For through holes and mass production • For cast iron, medium carbon steel and non-ferrous metal 	FN30T	M3~M12
				PC10T	M3~M12
				PC20T	M3~M12
SP	Spiral tap		<ul style="list-style-type: none"> • For blind holes • Better chip evacuation through flutes 	FN30T	M3~M12
				PC10T	M3~M12
RT	Roll tap		<ul style="list-style-type: none"> • For non-ferrous metal • For through holes and blind holes 	FN30T	M3~M12
				PC10T	M3~M12
SR	Spiral roll tap		<ul style="list-style-type: none"> • For non-ferrous metal, Al and magnesium 	FN30T	M3~M6
				PC10T	M3~M6

HSS tap

Tap type		Picture	Features	Grade	Size
ST	Straight tap		<ul style="list-style-type: none"> • For through holes and mass production • For cast iron, medium carbon steel and non-ferrous metal 	HN30T	M3~M20
				HC20T	M3~M20
				HC10T	M3~M20
				HH30T	M3~M20
PT	Point tap		<ul style="list-style-type: none"> • For through holes and mass production • Similar shape to the straight type but specialized with easier chip evacuation 	HN30T	M3~M20
				HC20T	M3~M20
				HC10T	M3~M20
				HH30T	M3~M20
SP	Spiral tap		<ul style="list-style-type: none"> • For blind holes • Chip evacuation through flutes 	HN30T	M3~M20
				HC20T	M3~M20
				HC10T	M3~M20
				HH30T	M3~M24
RT	Roll tap		<ul style="list-style-type: none"> • For non-ferrous metal • For through holes and blind holes 	HN30T	M3~M12
				HC20T	M3~M12
				HC10T	M3~M12
SR	Spiral roll tap		<ul style="list-style-type: none"> • For non-ferrous metal, Al and magnesium 	HN30T	M3~M6
				HC20T	M3~M6
				HC10T	M3~M6



Recommended cutting speeds and cutting fluid

- For machining cold/hot forging steel and sintered ferrous alloy in high feed, high depth of cut and highly interrupted conditions
- Excellent resistance to chipping, fracture and thermal cracks
- Improved surface finish due to optimized cutting edges

ISO	Workpiece		Cutting speed, vc (m/min)					Cutting fluid			
			Straight tap	Spiral tap	Point tap	Carbide tap	Roll tap	Insoluble	Water soluble emulsion	Semi dry	Dry
P	Low carbon steel	≤ 0.25 %C	8~13	8~13	15~25	-	8~13	◎	○	△	△
	Medium carbon steel	0.25~0.45 %C	7~12	7~12	10~15	-	7~10	◎	○	△	△
	High carbon steel	≥ 0.45 %C	6~9	6~9	8~13	-	5~8	◎	○	△	△
	Alloy steel	SCM	7~12	7~12	10~15	-	5~8	◎	△	△	△
	Quenched and tempered steel	25~45HRC	3~5	3~5	4~6	-	-	◎	△	-	-
	Tool steel	SKD	6~9	6~9	7~10	-	-	◎	-	-	-
	Cast steel	SCM	6~11	6~11	10~15	-	-	◎	○	-	-
M	Stainless steel	SUS	4~7	5~8	8~13	-	5~10	◎	○	-	-
	Precipitation hardened stainless steel	SUS630 SUS631	3~5	3~5	4~6	-	-	◎	-	-	-
K	Cast iron	GC	10~15	-	-	10~20	-	◎	○	○	○
	Ductile cast iron	GCD	7~12	7~12	10~20	10~20	-	◎	○	○	-
N	Copper	Cu	6~9	6~11	7~12	10~20	7~12	○	○	-	-
	Brass, brass-cast	Bs Bsc	10~15	10~20	15~25	15~25	7~12	○	○	○	○
	Bronze, bronze-cast	PB PBC	6~11	6~11	10~20	10~20	7~12	○	○	-	-
	Rolled aluminum	Al	10~20	10~20	15~25	-	10~20	◎	○	△	-
	Aluminum-cast, alloyed	AC ACD	10~15	10~15	15~20	10~20	10~25	◎	○	△	-
	Magnesium-cast, alloyed	MC	7~12	7~12	10~15	10~20	-	◎	○	○	-
	Zinc-cast, alloyed	ZDC	1~12	7~12	10~15	10~20	7~12	◎	○	△	-
	Thermosetting plastics	Bakelite phenol epoxy	10~20	-	-	15~25	-	-	○	○	○
Thermoplastics	Nylon vinyl chloride	10~20	10~15	10~20	10~20	-	-	○	○	○	

◎ Recommended ○ Applicable △ Usable - unusable

D Technical Information for Tap

Recommended drill diameter [On 2nd class thread basis]

[Straight tap & Spiral tap]

Thread size	Drill diameter		
	Min	Recommended	Max
M3X0.5	2.459	2.5	2.599
M4X0.7	3.242	3.3	3.422
M5X0.8	4.134	4.2	4.334
M6X1.0	4.917	5.0	5.153
M8X1.25	6.647	6.8	6.912
M10X1.25	8.647	8.8	8.912
M10X1.5	8.376	8.5	8.676
M12X1.0	10.917	11.0	11.153
M12X1.25	10.647	10.8	10.912
M12X1.5	10.376	10.5	10.676

Thread size	Drill diameter		
	Min	Recommended	Max
M12X1.75	10.106	10.3	10.441
M14X1.5	12.376	12.5	12.676
M14X2.0	11.835	12.0	12.21
M16X1.5	14.376	14.5	14.676
M16X2.0	13.835	14.0	14.21
M18X1.5	16.376	16.5	16.676
M18X2.5	15.294	15.5	15.744
M20X1.5	18.376	18.5	18.676
M20X2.5	17.294	17.5	17.744
-	-	-	-

[Roll tap]

Thread size	Drill diameter		
	Min	Recommended	Max
M3X0.5	2.76	2.8	2.81
M4X0.7	3.65	3.7	3.7
M5X0.8	4.59	4.6	4.66
M6X1.0	5.48	5.5	5.57
M8X1.25	7.34	7.4	7.41
M10X1.25	9.34	9.4	9.41

Thread size	Drill diameter		
	Min	Recommended	Max
M10X1.5	9.18	9.2	9.28
M12X1.0	11.48	11.5	11.57
M12X1.25	11.34	11.4	11.41
M12X1.5	11.18	11.2	11.28
M12X1.75	11.05	11.1	11.15
-	-	-	-

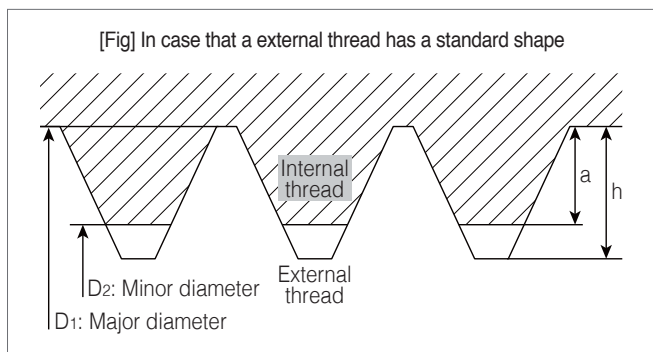

- Pre-hole diameter = D1: Major diameter
D2: Minor diameter
- $a = 1/2 \times (D1 - D2)$
- $h = \text{Height of fundamental triangle}$
- $\text{Rate of threading engagement} = a/h \times 100 (\%)$

$$\text{* Rate of threading engagement} = \frac{\text{Major diameter} - \text{Pre-hole diameter}}{2 \times (\text{Height of fundamental triangle})}$$

$$\text{* Pre-hole diameter} = d - 2 \times H \times \frac{\text{rate of threading engagement}}{100}$$

- d : Major diameter
- H (Rate of threading engagement's Height): $0.541266P$
- P : Pitch (mm)

* Recommended bottom hole diameters follow the JIS2 standard for a nut. (Nuts outside the JIS standard are excluded)

$$\text{* Drill diameter} = D - 0.0068 \times P \times 65$$

- D : Nominal diameter
- P : Pitch (mm)
- $65 = 65\%$ of the thread height

* Nut's bottom hole diameters outside the JIS standard are only for reference.

ST Straight Tap

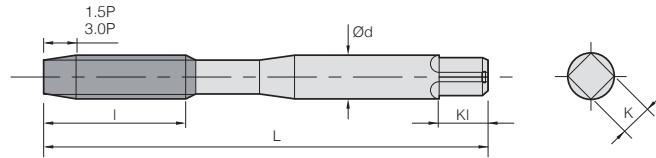

(mm)

Flutes	Designation		Thread size	L	l	d	K	Kl	Limits
	1.5P	3P							
3	M3X0.5-ST15	M3X0.5-ST30	M3X0.5	46	11	4.0	3.2	6	KH3
	M4X0.7-ST15	M4X0.7-ST30	M4X0.7	52	13	5.0	4.0	7	KH3
	M5X0.8-ST15	M5X0.8-ST30	M5X0.8	60	16	5.5	4.5	7	KH3
	M6X1.0-ST15	M6X1.0-ST30	M6X1.0	62	19	6.0	4.5	7	KH3
4	M8X1.0-ST15	M8X1.0-ST30	M8X1.0	70	22	6.2	5.0	8	KH3
	M8X1.25-ST15	M8X1.25-ST30	M8X1.25	70	22	6.2	5.0	8	KH4
	M10X1.0-ST15	M10X1.0-ST30	M10X1.0	75	24	7.0	5.5	8	KH3
	M10X1.25-ST15	M10X1.25-ST30	M10X1.25	75	24	7.0	5.5	8	KH4
	M10X1.5-ST15	M10X1.5-ST30	M10X1.5	75	24	7.0	5.5	8	KH4
	M12X1.0-ST15	M12X1.0-ST30	M12X1.0	82	29	8.5	6.5	9	KH3
	M12X1.25-ST15	M12X1.25-ST30	M12X1.25	82	29	8.5	6.5	9	KH4
	M12X1.5-ST15	M12X1.5-ST30	M12X1.5	82	29	8.5	6.5	9	KH4
	M12X1.75-ST15	M12X1.75-ST30	M12X1.75	82	29	8.5	6.5	9	KH5

* Ideal for mass tapping operations of general cast iron, ductile cast iron, brass-cast, thermosetting plastics, etc
 * Wear resistance highly improved by the use of TiCN, TiN coating for high efficiency tapping operations

Applicable workpiece range

Division	Carbon steel			Alloy steel	Quenched and tempered steel			Stainless steel	Tool steel	Cast steel	Cast iron	Ductile cast iron	Copper	Brass	Brass-cast	Bronze	Rolled aluminum	Aluminum-cast, alloyed	Magnesium-cast, alloyed	Zinc-cast, alloyed	Titanium alloy		Thermo-setting plastics	Thermo-plastics
	C ~0.25%	C0.25% ~0.45%	C 0.45%~		SCM	25-45 Hrc	45-55 Hrc														50-60 Hrc	SUS		
FN30T											◎	○		○	○	◎		○	○	○			◎	
PC10T											◎	○		○	○	◎		○	○	○			◎	
PC20T											◎	○		○	○	◎		○	○	○			◎	

SP Spiral Tap

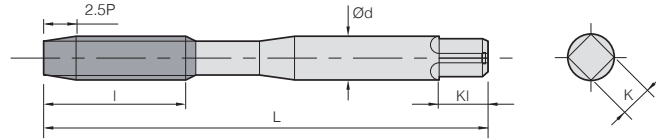

(mm)

Flutes	Designation	Thread size	L	l	d	K	Kl	Limits
	2.5P							
3	M3X0.5-SP25	M3X0.5	46	11	4.0	3.2	6	KH3
	M4X0.7-SP25	M4X0.7	52	13	5.0	4.0	7	KH3
	M5X0.8-SP25	M5X0.8	60	16	5.5	4.5	7	KH3
	M6X1.0-SP25	M6X1.0	62	19	6.0	4.5	7	KH3
	M8X1.0-SP25	M8X1.0	70	22	6.2	5.0	8	KH3
	M8X1.25-SP25	M8X1.25	70	22	6.2	5.0	8	KH4
	M10X1.0-SP25	M10X1.0	75	24	7.0	5.5	8	KH3
	M10X1.25-SP25	M10X1.25	75	24	7.0	5.5	8	KH4
	M10X1.5-SP25	M10X1.5	75	24	7.0	5.5	8	KH4
	M12X1.0-SP25	M12X1.0	82	29	8.5	6.5	9	KH3
	M12X1.25-SP25	M12X1.25	82	29	8.5	6.5	9	KH4
	M12X1.5-SP25	M12X1.5	82	29	8.5	6.5	9	KH4
M12X1.75-SP25	M12X1.75	82	29	8.5	6.5	9	KH5	

- * Ideal for making blind holes in quantity on general cast iron, ductile cast iron, brass-cast, thermosetting plastics, etc
- * Wear resistance highly improved by the use of TiCN coating for high efficiency tapping operations

Applicable workpiece range

Division	Carbon steel			Alloy steel	Quenched and tempered steel			Stainless steel	Tool steel	Cast steel	Cast iron	Ductile cast iron	Copper	Brass	Brass-cast	Bronze	Rolled aluminum	Aluminum-cast, alloyed	Magnesium-cast, alloyed	Zinc-cast, alloyed	Titanium alloy		Thermo-setting plastics	Thermo-plastics
	C ~0.25%	C0.25%~0.45%	C 0.45%~	SCM	25~45 HRC	45~55 HRC	50~60 HRC	SUS	SKD	SC	GC	GCD	Cu	Bs	BsC	PB	Al	AC ADC	MC	ZDC	Ti	Ni	-	-
FN30T											○	◎	◎	◎	◎	○	○	○	○	○				◎
PC10T											○	◎	◎	◎	◎	○	○	◎	◎	◎			○	◎



RT Roll Tap

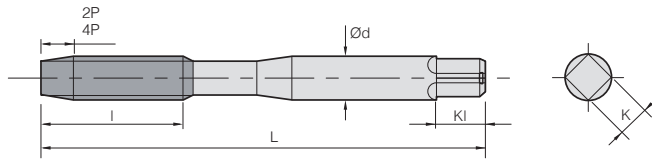

Carbide Uncoated FN30T TiCN PC10T

(mm)

Flutes	Designation		Thread size	L	l	d	K	Kl	Limits
	2P	4P							
1	M3X0.5-RT20(S)	-	M3X0.5	46	11	4.0	3.2	6	GH5
4	M3X0.5-RT20(M)	M3X0.5-RT40(M)	M3X0.5	46	11	4.0	3.2	6	GH5
1	M4X0.7-RT20(S)	-	M4X0.7	52	13	5.0	4.0	7	GH6
4	M4X0.7-RT20(M)	M4X0.7-RT40(M)	M4X0.7	52	13	5.0	4.0	7	GH6
1	M5X0.8-RT20(S)	-	M5X0.8	60	16	5.5	4.5	7	GH6
4	M5X0.8-RT20(M)	M5X0.8-RT40(M)	M5X0.8	60	16	5.5	4.5	7	GH6
1	M6X1.0-RT20(S)	-	M6X1.0	62	19	6.0	4.5	7	GH7
4	M6X1.0-RT20(M)	M6X1.0-RT40(M)	M6X1.0	62	19	6.0	4.5	7	GH7
1	M8X1.25-RT20(S)	-	M8X1.25	70	22	6.2	5.0	8	GH7
4	M8X1.25-RT20(M)	M8X1.25-RT40(M)	M8X1.25	70	22	6.2	5.0	8	GH7
1	M10X1.25-RT20(S)	-	M10X1.25	75	24	7.0	5.5	8	GH7
4	M10X1.25-RT20(M)	M10X1.25-RT40(M)	M10X1.25	75	24	7.0	5.5	8	GH7
1	M12X1.0-RT20(S)	-	M12X1.0	82	29	8.5	6.5	9	GH7
4	M12X1.0-RT20(M)	M12X1.0-RT40(M)	M12X1.0	82	29	8.5	6.5	9	GH7
1	M12X1.25-RT20(S)	-	M12X1.25	82	29	8.5	6.5	9	GH7
4	M12X1.25-RT20(M)	M12X1.25-RT40(M)	M12X1.25	82	29	8.5	6.5	9	GH7
1	M12X1.5-RT20(S)	-	M12X1.5	82	29	8.5	6.5	9	GH7
4	M12X1.5-RT20(M)	M12X1.5-RT40(M)	M12X1.5	82	29	8.5	6.5	9	GH7
1	M12X1.75-RT20(S)	-	M12X1.75	82	29	8.5	6.5	9	GH8
4	M12X1.75-RT20(M)	M12X1.75-RT40(M)	M12X1.75	82	29	8.5	6.5	9	GH8

- * For general use on both steels and non-ferrous metal
- * Wear resistance highly improved by the use of TiCN coating for high efficiency tapping operations
- * Ideal for making both through holes and blind holes on non-ferrous metals

Applicable workpiece range

Division	Carbon steel			Alloy steel	Quenched and tempered steel			Stainless steel	Tool steel	Cast steel	Cast iron	Ductile cast iron	Copper	Brass	Brass-cast	Bronze	Rolled aluminum	Aluminum-cast, alloyed	Magnesium-cast, alloyed	Zinc-cast, alloyed	Titanium alloy		Thermo-setting plastics	Thermo-plastics
	C ~0.25%	C0.25%~0.45%	C 0.45%~		SCM	25~45 Hrc	45~55 Hrc														50~60 Hrc	SUS		
FN30T													⊙	⊙	⊙		⊙	⊙		⊙				
PC10T	⊙	⊙	○	○				⊙					⊙	⊙	⊙		⊙	⊙		⊙				

SR Spiral Roll Tap

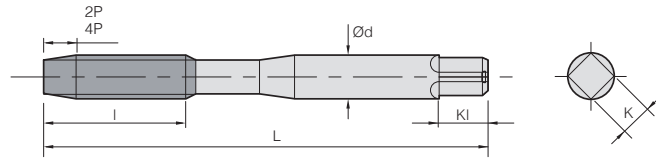

Carbide Uncoated FN30T TiCN PC10T

(mm)

Designation		Thread size	L	l	d	K	KI	Limits
2P	4P							
M3X0.5-SR20	M3X0.5-SR40	M3X0.5	46	18	4.0	3.2	6	GH6
M3.5X0.6-SR20	M3.5X0.6-SR40	M3.5X0.6	46	18	4.0	3.2	6	GH6
M4X0.7-SR20	M4X0.7-SR40	M4X0.7	52	20	5.0	4.0	7	GH7
M5X0.8-SR20	M5X0.8-SR40	M5X0.8	60	22	5.5	4.5	7	GH7
M6X1.0-SR20	M6X1.0-SR40	M6X1.0	62	24	6.0	4.5	7	GH7

- * For general use for tapping aluminum, magnesium and zinc as well as non-ferrous metal
- * Ideal for tapping steel, non-ferrous materials and stainless steel
- * Wear resistance highly improved by the use of TiCN coating for high efficiency tapping operations

Applicable workpiece range

Division	Carbon steel			Alloy steel	Quenched and tempered steel			Stainless steel	Tool steel	Cast steel	Cast iron	Ductile cast iron	Copper	Brass	Brass-cast	Bronze	Rolled aluminum	Aluminum-cast, alloyed	Magnesium-cast, alloyed	Zinc-cast, alloyed	Titanium alloy		Thermo-setting plastics	Thermo-plastics	
	C ~0.25%	C0.25% ~0.45%	C 0.45%~	SCM	25~45 HRC	45~55 HRC	50~60 HRC	SUS	SKD	SC	GC	GCD	Cu	Bs	BsC	PB	Al	AC ADC	MC	ZDC	Ti	Ni	-	-	
FN30T													⊙	⊙	⊙		⊙	⊙		⊙					
PC10T	⊙	⊙	○	○				⊙					⊙	⊙	⊙		⊙	⊙		⊙					



ST Straight Tap

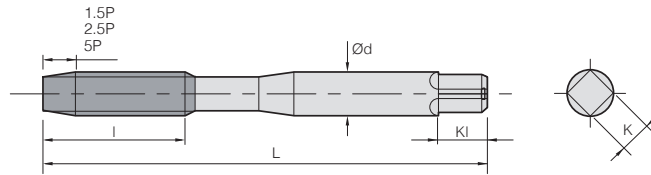

(mm)

Flutes	Designation			Thread size	L	l	d	K	KI	Limits
	1.5P	2.5P	5P							
3	M3X0.5-ST15	M3X0.5-ST25	M3X0.5-ST50	M3X0.5	46	11	4.0	3.2	6	KH2
	M4X0.7-ST15	M4X0.7-ST25	M4X0.7-ST50	M4X0.7	52	13	5.0	4.0	7	KH2
	M5X0.8-ST15	M5X0.8-ST25	M5X0.8-ST50	M5X0.8	60	16	5.5	4.5	7	KH2
	M6X1.0-ST15	M6X1.0-ST25	M6X1.0-ST50	M6X1.0	62	19	6.0	4.5	7	KH2
4	M8X1.25-ST15	M8X1.25-ST25	M8X1.25-ST50	M8X1.25	70	22	6.2	5.0	8	KH2
	M10X1.25-ST15	M10X1.25-ST25	M10X1.25-ST50	M10X1.25	75	24	7.0	5.5	8	KH2
	M10X1.5-ST15	M10X1.5-ST25	M10X1.5-ST50	M10X1.5	75	24	7.0	5.5	8	KH3
	M12X1.0-ST15	M12X1.0-ST25	M12X1.0-ST50	M12X1.0	82	29	8.5	6.5	9	KH2
	M12X1.25-ST15	M12X1.25-ST25	M12X1.25-ST50	M12X1.25	82	29	8.5	6.5	9	KH2
	M12X1.5-ST15	M12X1.5-ST25	M12X1.5-ST50	M12X1.5	82	29	8.5	6.5	9	KH3
	M12X1.75-ST15	M12X1.75-ST25	M12X1.75-ST50	M12X1.75	82	29	8.5	6.5	9	KH3
	M14X1.5-ST15	M14X1.5-ST25	M14X1.5-ST50	M14X1.5	88	30	10.5	8.0	11	KH3
	M14X2.0-ST15	M14X2.0-ST25	M14X2.0-ST50	M14X2.0	88	30	10.5	8.0	11	KH3
	M16X1.5-ST15	M16X1.5-ST25	M16X1.5-ST50	M16X1.5	95	32	12.5	10.0	13	KH3
	M16X2.0-ST15	M16X2.0-ST25	M16X2.0-ST50	M16X2.0	95	32	12.5	10.0	13	KH3
	M18X1.5-ST15	M18X1.5-ST25	M18X1.5-ST50	M18X1.5	100	37	14.0	11.0	14	KH3
	M18X2.5-ST15	M18X2.5-ST25	M18X2.5-ST50	M18X2.5	100	37	14.0	11.0	14	KH3
	M20X1.5-ST15	M20X1.5-ST25	M20X1.5-ST50	M20X1.5	105	37	15.0	12.0	15	KH3
	M20X2.5-ST15	M20X2.5-ST25	M20X2.5-ST50	M20X2.5	105	37	15.0	12.0	15	KH3

- * Ideal for making both through holes and blind holes on carbon steel, alloy steel and non-ferrous metal
- * Wear resistance highly improved by the use of TiN, TiCN, Steam oxide coating for high efficiency tapping operations
- * Built-up edges are prevented thanks to a reduced coefficient of friction gained by using porous cutting fluid of Fe³O₄
- * Ideal for tapping stainless steel, cast steel, carbon steel for machine structures, etc

Applicable workpiece range

Division	Carbon steel			Alloy steel	Quenched and tempered steel			Stainless steel	Tool steel	Cast steel	Cast iron	Ductile cast iron	Copper	Brass	Brass-cast	Bronze	Rolled aluminum	Aluminum-cast, alloyed	Magnesium-cast, alloyed	Zinc-cast, alloyed	Titanium alloy		Thermo-setting plastics	Thermo-plastics
	C ~0.25%	C 0.25%~0.45%	C 0.45%~		SCM	25-45 HRC	45-55 HRC														50-60 HRC	SUS		
HN30T		○										○		○	○	○	○	○	○	○				
HC20T	○	○	○	○	○									○	○	○	○	○	○	○				
HC10T	○	○	○	○	○									○	○	○	○	○	○	○				
HH30T	◎	◎	◎	◎	◎	◎	◎	○	○	○	○	○												

PT Point Tap

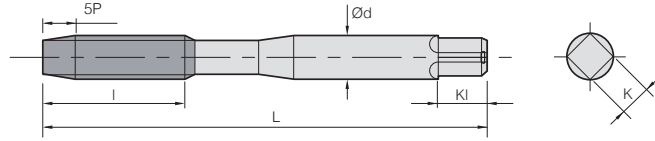

(mm)

Flutes	Designation	Thread size	L	l	d	K	KI	Limits
	5P							
3	M3X0.5-PT50	M3X0.5	46	11	4.0	3.2	6	KH2
	M4X0.7-PT50	M4X0.7	52	13	5.0	4.0	7	KH2
	M5X0.8-PT50	M5X0.8	60	16	5.5	4.5	7	KH2
	M6X1.0-PT50	M6X1.0	62	19	6.0	4.5	7	KH2
	M8X1.25-PT50	M8X1.25	70	22	6.2	5.0	8	KH3
	M10X1.25-PT50	M10X1.25	75	24	7.0	5.5	8	KH3
	M10X1.5-PT50	M10X1.5	75	24	7.0	5.5	8	KH3
	M12X1.0-PT50	M12X1.0	82	29	8.5	6.5	9	KH3
	M12X1.25-PT50	M12X1.25	82	29	8.5	6.5	9	KH3
	M12X1.5-PT50	M12X1.5	82	29	8.5	6.5	9	KH3
	M12X1.75-PT50	M12X1.75	82	29	8.5	6.5	9	KH4
	M14X1.5-PT50	M14X1.5	88	30	10.5	8.0	11	KH3
	M14X2.0-PT50	M14X2.0	88	30	10.5	8.0	11	KH4
	M16X1.5-PT50	M16X1.5	95	32	12.5	10.0	13	KH3
	M16X2.0-PT50	M16X2.0	95	32	12.5	10.0	13	KH4
	M18X1.5-PT50	M18X1.5	100	37	14.0	11.0	14	KH4
	M18X2.5-PT50	M18X2.5	100	37	14.0	11.0	14	KH4
M20X1.5-PT50	M20X1.5	105	37	15.0	12.0	15	KH4	
M20X2.5-PT50	M20X2.5	105	37	15.0	12.0	15	KH4	

- * Ideal for making through holes on carbon steel, alloy steel and non-ferrous metal
- * Wear resistance highly improved by the use of TiN, TiCN, Steam oxide coating for high efficiency tapping operations
- * Built-up edges are prevented thanks to a reduced coefficient of friction gained by using porous cutting fluid of Fe³O₄
- * Ideal for tapping stainless steel, cast steel, carbon steel for machine structures, etc

Applicable workpiece range

Division	Carbon steel			Alloy steel	Quenched and tempered steel			Stainless steel	Tool steel	Cast steel	Cast iron	Ductile cast iron	Copper	Brass	Brass-cast	Bronze	Rolled aluminum	Aluminum-cast, alloyed	Magnesium-cast, alloyed	Zinc-cast, alloyed	Titanium alloy		Thermo-setting plastics	Thermo-plastics
	C ~0.25%	C0.25%~0.45%	C 0.45%~	SCM	25~45 HRC	45~55 HRC	50~60 HRC	SUS	SKD	SC	GC	GCD	Cu	Bs	BsC	PB	Al	AC ADC	MC	ZDC	Ti	Ni	-	-
HN30T		○	○	◎							○	○	○	○	○	○	◎	○	○	○				○
HC20T	○	○	○	○				◎	○	○	○	○	○	○	○	○	○	○	○	○	○	○		○
HC10T	◎	◎	◎	○				○	○	○	○	○	○	○	○	○	○	○	○	○	○	○		○
HH30T	◎	◎	◎	◎	◎	◎	◎	○	○	○	○	○												



SP Spiral Tap

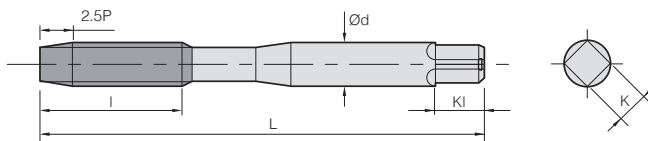

(mm)

Flutes	Designation	Thread size	L	l	d	K	KI	Limits
	2.5P							
3	M3X0.5-SP25	M3X0.5	46	11	4.0	3.2	6	KH2
	M4X0.7-SP25	M4X0.7	52	13	5.0	4.0	7	KH2
	M5X0.8-SP25	M5X0.8	60	16	5.5	4.5	7	KH2
	M6X1.0-SP25	M6X1.0	62	19	6.0	4.5	7	KH2
	M8X1.25-SP25	M8X1.25	70	22	6.2	5.0	8	KH2
	M10X1.25-SP25	M10X1.25	75	24	7.0	5.5	8	KH2
	M10X1.5-SP25	M10X1.5	75	24	7.0	5.5	8	KH2
	M12X1.0-SP25	M12X1.0	82	29	8.5	6.5	9	KH2
	M12X1.25-SP25	M12X1.25	82	29	8.5	6.5	9	KH2
	M12X1.5-SP25	M12X1.5	82	29	8.5	6.5	9	KH2
	M12X1.75-SP25	M12X1.75	82	29	8.5	6.5	9	KH2
	M14X1.5-SP25	M14X1.5	88	30	10.5	8.0	11	KH2
	M14X2.0-SP25	M14X2.0	88	30	10.5	8.0	11	KH2
4	M16X1.5-SP25	M16X1.5	95	32	12.5	10.0	13	KH2
	M16X2.0-SP25	M16X2.0	95	32	12.5	10.0	13	KH2
	M18X1.5-SP25	M18X1.5	100	37	14.0	11.0	14	KH2
	M18X2.5-SP25	M18X2.5	100	37	14.0	11.0	14	KH3
	M20X1.5-SP25	M20X1.5	105	37	15.0	12.0	15	KH3
	M20X2.5-SP25	M20X2.5	105	37	15.0	12.0	15	KH3

- * Ideal for making blind holes. Its flutes provide excellent chip evacuation in tapping carbon steel, alloy steel and non-ferrous materials
- * Wear resistance highly improved by the use of TiN, TiCN, Steam oxide coating for high efficiency tapping operations
- * Built-up edges are prevented thanks to a reduced coefficient of friction gained by using porous cutting fluid of Fe₃O₄
- * Ideal for tapping stainless steel, cast steel, carbon steel for machine structures, etc

Applicable workpiece range

Division	Carbon steel			Alloy steel	Quenched and tempered steel			Stainless steel	Tool steel	Cast steel	Cast iron	Ductile cast iron	Copper	Brass	Brass-cast	Bronze	Rolled aluminum	Aluminum-cast, alloyed	Magnesium-cast, alloyed	Zinc-cast, alloyed	Titanium alloy		Thermo-setting plastics	Thermo-plastics
	C ~0.25%	C 0.25%~0.45%	C 0.45%~		SCM	25-45 HRC	45-55 HRC														50-60 HRC	SUS		
HN30T		○		◎								○	○	○	○	○	○	○	○	○				○
HC20T	○	○	○	○				○	○	○		○	○	○	○	○	○	○	○	○	○	○		○
HC10T	○	◎	◎	○				○	○	○		○	○	○	○	○	○	◎	○	○	○	○		○
HH30T	◎	◎	◎	◎	◎	◎	◎	○	○	○	○	○												

RT Roll Tap

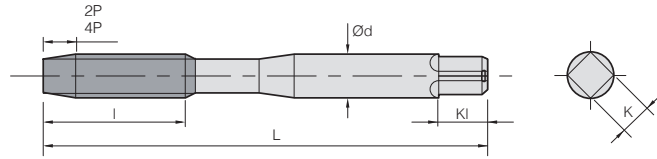

(mm)

Flutes	Designation		Thread size	L	l	d	K	KI	Limits
	2P	4P							
1	M3X0.5-RT20(S)	-	M3X0.5	46	11	4.0	3.2	6	GH5
4	M3X0.5-RT20(M)	M3X0.5-RT40(M)	M3X0.5	46	11	4.0	3.2	6	GH5
1	M4X0.7-RT20(S)	-	M4X0.7	52	13	5.0	4.0	7	GH6
4	M4X0.7-RT20(M)	M4X0.7-RT40(M)	M4X0.7	52	13	5.0	4.0	7	GH6
1	M5X0.8-RT20(S)	-	M5X0.8	60	16	5.5	4.5	7	GH6
4	M5X0.8-RT20(M)	M5X0.8-RT40(M)	M5X0.8	60	16	5.5	4.5	7	GH6
1	M6X1.0-RT20(S)	-	M6X1.0	62	19	6.0	4.5	7	GH7
4	M6X1.0-RT20(M)	M6X1.0-RT40(M)	M6X1.0	62	19	6.0	4.5	7	GH7
1	M8X1.25-RT20(S)	-	M8X1.25	70	22	6.2	5.0	8	GH7
4	M8X1.25-RT20(M)	M8X1.25-RT40(M)	M8X1.25	70	22	6.2	5.0	8	GH7
1	M10X1.25-RT20(S)	-	M10X1.25	75	24	7.0	5.5	8	GH7
4	M10X1.25-RT20(M)	M10X1.25-RT40(M)	M10X1.25	75	24	7.0	5.5	8	GH7
1	M10X1.5-RT20(S)	-	M10X1.5	75	24	7.0	5.5	8	GH7
4	M10X1.5-RT20(M)	M10X1.5-RT40(M)	M10X1.5	75	24	7.0	5.5	8	GH7
1	M12X1.0-RT20(S)	-	M12X1.0	82	29	8.5	6.5	9	GH7
4	M12X1.0-RT20(M)	M12X1.0-RT40(M)	M12X1.0	82	29	8.5	6.5	9	GH7
1	M12X1.25-RT20(S)	-	M12X1.25	82	29	8.5	6.5	9	GH7
4	M12X1.25-RT20(M)	M12X1.25-RT40(M)	M12X1.25	82	29	8.5	6.5	9	GH7
1	M12X1.5-RT20(S)	-	M12X1.5	82	29	8.5	6.5	9	GH7
4	M12X1.5-RT20(M)	M12X1.5-RT40(M)	M12X1.5	82	29	8.5	6.5	9	GH7
1	M12X1.75-RT20(S)	-	M12X1.75	82	29	8.5	6.5	9	GH8
4	M12X1.75-RT20(M)	M12X1.75-RT40(M)	M12X1.75	82	29	8.5	6.5	9	GH8

- * For general use for both steels and non-ferrous metal
- * Wear resistance highly improved by the use of TiN, TiCN coating for high efficiency tapping operations
- * Ideal for tapping non-ferrous alloys such as aluminum, zinc, copper, etc

Applicable workpiece range

Division	Carbon steel			Alloy steel	Quenched and tempered steel			Stainless steel	Tool steel	Cast steel	Cast iron	Ductile cast iron	Copper	Brass	Brass-cast	Bronze	Rolled aluminum	Aluminum-cast, alloyed	Magnesium-cast, alloyed	Zinc-cast, alloyed	Titanium alloy		Thermo-setting plastics	Thermo-plastics
	C ~0.25%	C0.25% ~0.45%	C 0.45%~		25~45 HrC	45~55 HrC	50~60 HrC														Ti	Ni		
HN30T													○	○	○	○	○	○	○	○	◎			
HC20T	○	○	○	○				◎	○	○		○	○	○	○									
HC10T	◎	◎	○	○				◎					◎	◎	◎		◎	◎		◎				



SR Spiral Roll Tap

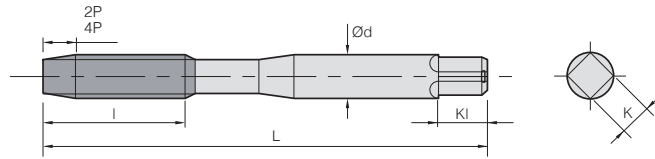

- HSSE
- Uncoated
HN30T
- TiN
HC20T
- TiCN
HC10T

(mm)

Designation		Thread size	L	l	d	K	KI	Limits
2P	4P							
M3X0.5-SR20	M3X0.5-SR40	M3X0.5	46	18	4.0	3.2	6	GH6
M3.5X0.6-SR20	M3.5X0.6-SR40	M3.5X0.6	48	18	4.0	3.2	6	GH6
M4X0.7-SR20	M4X0.7-SR40	M4X0.7	52	20	5.0	4.0	7	GH7
M5X0.8-SR20	M5X0.8-SR40	M5X0.8	60	22	5.5	4.5	7	GH7
M6X1.0-SR20	M6X1.0-SR40	M6X1.0	62	24	6.0	4.5	7	GH7

- * For general use for tapping aluminum, magnesium and zinc as well as non-ferrous metal
- * Wear resistance highly improved by the use of TiN, TiCN coating for high efficiency tapping operations
- * Ideal for tapping steel, non-ferrous materials and stainless steel

Applicable workpiece range

Division	Carbon steel			Alloy steel	Quenched and tempered steel			Stainless steel	Tool steel	Cast steel	Cast iron	Ductile cast iron	Copper	Brass	Brass-cast	Bronze	Rolled aluminum	Aluminum-cast, alloyed	Magnesium-cast, alloyed	Zinc-cast, alloyed	Titanium alloy		Thermo-setting plastics	Thermoplastics
	C ~0.25%	C0.25% ~0.45%	C 0.45%~		SCM	25-45 HRC	45-55 HRC														50-60 HRC	SUS		
HN30T													○	○	○	○	○			◎				
HC20T	○	○	○	○				◎	○	○		○	○	○										
HC10T	◎	◎	○	○				◎					◎	◎	◎		◎	◎		◎				

Milling Insert

- E02 Milling Insert Code System (ISO)
- E04 Milling Inserts
- E32 KORLOY Cutters
- E38 KORLOY Shanks
- E42 KORLOY Modular Adaptors

Face Milling Cutters

- E44 Mill-max/Mill-max Plus (E45, E51)
- E54 Technical Information for Mill-max Heavy
- E55 Mill-max Heavy
- E56 Turbo Mill
- E59 Double Mill
- E61 Technical Information for Power Buster
- E65 Power Buster
- E68 Technical Information for Rich Mill
- E89 Rich Mill
- E132 Technical Information for Aero Mill/
Aero Mill-Plus/Aero Mill-Mini
- E136 Aero Mill
- E137 Aero Mill-Plus
- E139 Aero Mill-Mini
- E141 PCD Face Cutter

Cutters for Molds

- E142 Technical Information for Alpha Mill-X
- E145 Alpha Mill-X
- E147 Technical Information for Alpha Mill/Alpha Mill Nick
- E154 Alpha Mill
- E183 Technical Information for BT/HSK Tooling System
- E184 BT Tooling System (Single-edge)
- E189 HSK Tooling System (Single-edge)
- E194 BT Tooling System (Multi-edge)
- E200 HSK Tooling System (Multi-edge)
- E205 BT Tooling System (Modular)
- E206 HSK Tooling System (Modular)
- E207 Technical Information for Future Mill/FMR P-Positive
- E222 Future Mill
- E248 FMR P-Positive
- E260 Technical Information for HFMD
- E264 HFMD
- E268 Technical Information for HFM
- E273 HFM
- E276 Technical Information for HRMDouble
- E281 HRMDouble
- E292 HRM
- E299 Tank Mill
- E300 Technical Information for TP2P
- E303 TP2P



Cutters for Molds

- E309 Technical Information for Laser Mill/GBE/BRE
- E318 Laser Mill
- E323 BFE
- E324 GBE
- E327 BRE
- E329 Technical Information for HAVE
- E331 HAVE (Single-edge/Multi-edge)
- E333 O-ring Cutter
- E335 Chamfer Tool (Multi-functional, Solid)
- E343 T-Cutter (TFE)

Milling Cutters for Aluminum

- E344 Technical Information for Pro-A Mill/Pro-X Mill/
Pro-L Mill/Pro-XL Mill/Pro-V Mil
- E354 Pro-A Mill
- E357 Pro-X Mill
- E363 Pro-L Mill
- E367 Pro-XL Mill
- E368 Pro-V Mill
- E371 Modular Adaptor (MAT)

Side Milling Cutters

- E373 Technical Information for Side Milling Cutters
- E375 Side Milling Cutter
- E379 Side Cutter
- E382 Wind Mill

Milling Cutter for Cast iron at high feed

- E386 Technical Information for High feed Cutter
- E388 Technical Information for Cube Mill
- E389 Technical Information for Couple Mill
- E391 Technical Information for Storm Mill
- E392 Technical Information for Shave Mill
- E394 Technical Information for Shave Mill-Ultra
- E395 High feed Cutter
- E397 Shave Mill
- E398 Shave Mill-Ultra

Detail Information of Milling Cutter and Arbor

- E400 Actual Designations of Milling Cutter and Arbor

Gear Tools

- E403 Technical Information for Gear Cutter Tools
- E404 Gear Cutter Table
- E405 Gear Cutter
- E413 Gear Cutter Order Form
- E414 Indexable HOB
- E415 Indexable HOB Order Form
- E416 Special Boring Tool Order Form

MILLING

Milling tools that provide the best quality and improve productivity for every customer needs.



E

E Milling Insert Code System (ISO)

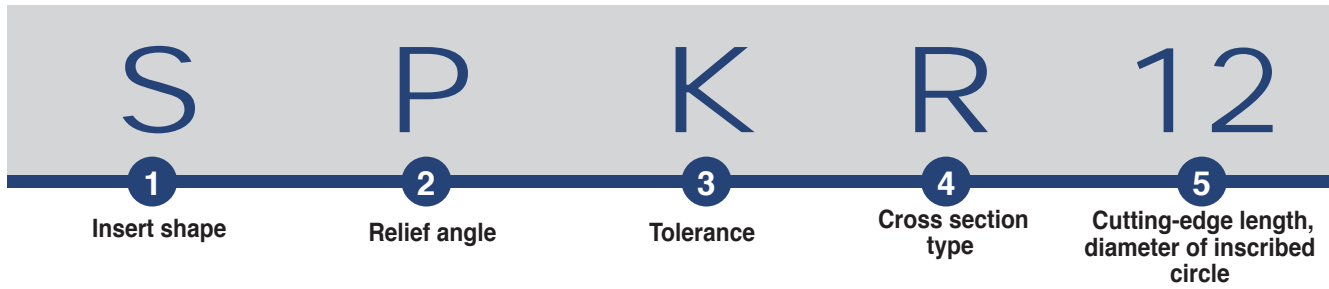

1 Insert shape

S P K R 12 03 ^{ED}08 S R - MX

2 Relief angle

S P K R 12 03 ^{ED}08 S R - MX

3 Tolerance

S P K R 12 03 ^{ED}08 S R - MX

d: Inscribed circle
t: Thickness
m: Refer to figure

■ Tolerance on C, E, H, M, O, P, R, S, T, W Insert Shape (exceptional case)

Class	(mm)			Tolerance on d		Tolerance on m	
	d	m	t	J, K, L, M, N	U	M, N	U
A	±0.025	±0.005	±0.025	6.35	±0.05 ±0.08	±0.08	±0.13
C	±0.025	±0.013	±0.025	9.525	±0.05 ±0.08	±0.08	±0.13
H	±0.013	±0.013	±0.025	12.7	±0.08 ±0.13	±0.13	±0.20
E	±0.025	±0.025	±0.025	15.875	±0.10 ±0.18	±0.15	±0.27
G	±0.025	±0.025	±0.13	19.05	±0.10 ±0.18	±0.15	±0.27
J	±0.05~±0.15	±0.005	±0.025	25.4	±0.13 ±0.25	±0.18	±0.38
K	±0.05~±0.15	±0.013	±0.025	Tolerance on D Insert Shape (exceptional case)			
L	±0.05~±0.15	±0.025	±0.025	d	Tolerance on d	Tolerance on m	
M	±0.05~±0.15	±0.08~±0.20	±0.13	6.35	±0.05	±0.11	
U	±0.08~±0.25	±0.13~±0.38	±0.13	9.525	±0.05	±0.11	
				12.7	±0.08	±0.15	
				15.875	±0.10	±0.18	
				19.05	±0.10	±0.18	

4 Cross section type

S P K R 12 03 ^{ED}08 S R - MX

5 Cutting-edge length, diameter of inscribed circle

S P K R 12 03 ^{ED}08 S R - MX

■ Metric system * Decimal integer constant

■ Inch system

· Use 1/32" unit for a insert having smaller I.C under 1/4"
· Use 1/8" unit for a insert having larger I.C over 1/4"

■ Cross over chart for "Metric" and "Inch" system

	06	09	11	16	22	27	33	44
	03	05	06	09	12	15	19	25
	04	06	07	11	15	19	23	31
	03	05	06	09	12	16	19	25
Inscribed circle	5/32"	7/32"	1/4"	3/8"	1/2"	5/8"	3/4"	1"
Inch system	5	7	2 (8)	3	4	5	6	8

* In case of rectangular and rhombic insert indicate cutting-edge length instead of inscribed circle.



03

ED
08

S

R - MX

6

Height of cutting-edge

7

Nose radius (Nose R)

8

Edge preparation

9

Hand

10

Chip breaker for milling

6 Height of cutting-edge

S P K R 12 03 ED 08 S R - MX

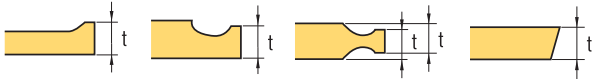

Symbol		Height of cutting-edge (t)	
Metric	Inch	mm	Inch
01	1 (2)	1.59	1/16
T0	1.125	1.79	9/128
T1	1.2	1.98	5/64
02	1.5 (3)	2.38	3/32
T2	1.75	2.78	7/64
03	2	3.18	1/8
T3	2.5	3.97	5/32
04	3	4.76	3/16
05	3.5	5.56	7/32
06	4	6.35	1/4
07	5	7.94	5/16
09	6	9.52	3/8
11	7	11.11	7/16
12	8 (16)	12.70	1/2

() Symbol for small size insert

8 Edge preparation

S P K R 12 03 ED 08 S R - MX

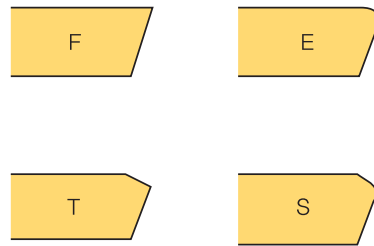

9 Hand

S P K R 12 03 ED 08 S R - MX

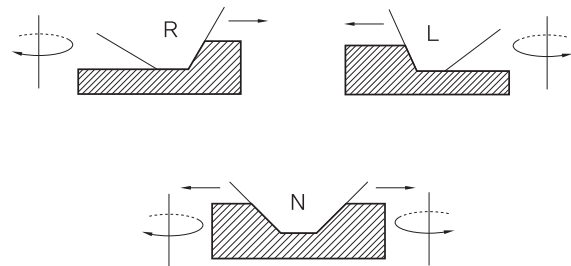

7 Nose radius (Nose R)

S P K R 12 03 ED 08 S R - MX

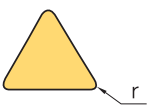

r		Symbol		r		Symbol	
mm	Inch	mm	Inch	mm	Inch	mm	Inch
00	0	0.0		12	3	1.2	3/64
02		0.2		15		1.5	
04	1	0.4	1/64	16	4	1.6	4/64
05		0.5		24	6	2.4	6/64
08	2	0.8	2/64	32	8	3.2	8/64
10		1.0		40		4.0	

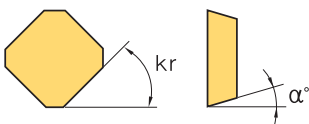

Parallel land	Relief angle
kr	α°
A - 45°	A - 3° F - 25°
D - 60°	B - 5° G - 30°
E - 75°	C - 7° N - 0°
F - 85°	D - 15° P - 11°
P - 90°	E - 20°
Z - Special	

10 Chip breaker for milling

S P K R 12 03 ED 08 S R - MX



MA MF MM MX



MF MM MR MA

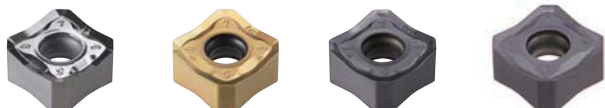









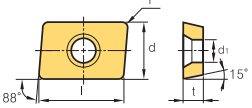

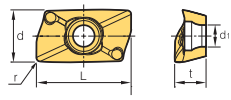

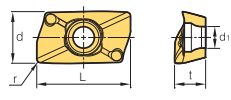

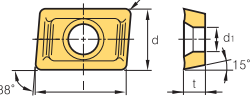

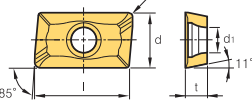

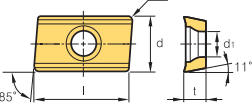
MA MF MM ML

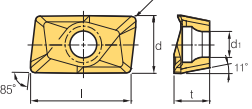
E Milling Inserts

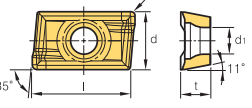
Workpiece	Steel	P												
	Stainless steel	M												
	Cast iron	K												
	Non-ferrous metal	N												
	Heat resistant alloy, Titanium alloy	S												
Hardened steel	H													

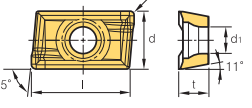
Machining types		
●	Continuous cutting	
◐	General cutting	
✳	Interrupted cutting	

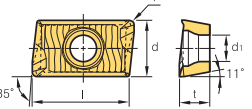





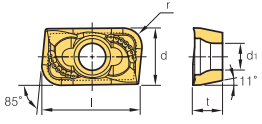
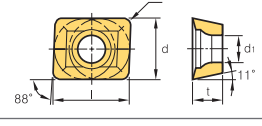

Inserts	Designation	Cermets		Coated										Uncoated		Dimensions (mm)					Geometries	Available tools			
		CN2000	CN30	NCM325	NCM335	NC5330	NCM535	NCM545	PC2010	PC3600	PC3700	PC6510	PC9530	PC9540	PC5300	PC5400	H01	H05	l	d			t	r	d ₁
	150308R																	15.0	9.525	3.18	0.8	4.5		-	
	150308SR																	15.0	9.525	3.18	0.8	4.5			
	150308TR	●																15.0	9.525	3.18	0.8	4.5			
	170608PESR-ML					●					●	●	●	●			19.650	10.843	6.529	0.8	4.5		E145~ E146		
	170604PESR-MM																19.650	10.843	6.529	0.4	4.5		E145~ E146		
	170608PESR-MM					●				●	●	●	●	●			19.650	10.843	6.529	0.8	4.5				
	170616PESR-MM														●	●	19.650	10.843	6.529	1.6	4.5				
	170620PESR-MM														●	●	19.650	10.843	6.529	2.0	4.5				
	150308R			●												●	15.0	9.525	3.18	0.8	4.5		E299		
	150308SR															●	15.0	9.525	3.18	0.8	4.5				
	150308TR															●	15.0	9.525	3.18	0.8	4.5				
	1604PDSR			●							●	●					16.4	9.525	4.76	0.8	4.4		E158 E170		
	1604PDFR-MA															●	●	16.4	9.525	4.76	0.2	4.4		E158 E170	
	160416FR-MA															●	●	16.4	9.525	4.76	1.6	4.4			
	1604PDFR-MA2															●	●	16.5	9.56	5.76	0.8	4.5		E158 E170	
	160416FR-MA2																	16.5	9.56	5.76	1.6	4.5			
	160432FR-MA2																	16.5	9.56	5.76	3.2	4.5			
	1604PDFR-MA3															●	●	16.4	9.525	5.0	0.8	4.4		E158 E170	
	160420FR-MA3																	16.0	9.525	5.0	2.0	4.4			
	1604PDSR-MF			●												●		16.4	9.525	5.0	0.8	4.4		E158 E170 E179	
	1604PDSR-MM			●	●						●	●	●	●			16.4	9.525	5.2	0.8	4.4		E158 E170 E179		

● : Stock item

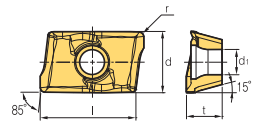

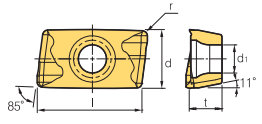
Workpiece	Steel	P											Machining types		
	Stainless steel	M													
Cast iron	K														
Non-ferrous metal	N														
Heat resistant alloy, Titanium alloy	S														
Hardened steel	H														

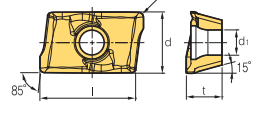
● Continuous cutting
 ● General cutting
 ✱ Interrupted cutting

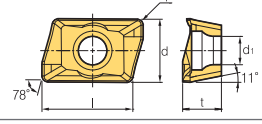
Inserts	Designation	Cermets		Coated										Uncoated		Dimensions (mm)					Geometries	Available tools				
		CN2000	CN30	NC5330	NCM535	NCM545	PC2505	PC2510	PC2010	PC3600	PC3700	PC6510	PC9530	PC9540	PC5300	PC5400	G10	H01	l	d			t	r	d ₁	
	160432R-MM1																	16.4	9.525	4.76	3.2	4.4		E158 E170		
	APLT	070304R																7.5	6.35	3.18	0.4	2.8			E299	
	0602PDFR-MA																	●	6	4.24	2.6	0.4	2.0		E154~157 E159	
	060208PDFR-MA																		●	6	4.24	2.6	0.8		2.0	E162~169
	0903PDFR-MA																		●	9.4	6.21	3.6	0.4		2.8	E171~172
	090308PDFR-MA																		●	9.4	6.21	3.6	0.8		2.8	E175~182
	11T3PDFR-MA																		●	11.2	6.467	3.6	0.5		2.9	E184~198
	11T308PDFR-MA																		●	11.2	6.467	3.6	0.8		2.9	E200~204
	160404PDFR-MA																		●	16.4	9.41	5.76	0.4		4.5	
	1604PDFR-MA																		●	16.4	9.41	5.76	0.8		4.5	
	180604PDFR-MA																		●	17.4	10.98	6.35	0.4		4.5	
	1806PDFR-MA																		●	17.4	10.98	6.35	0.8		4.5	
	180612PDFR-MA																		●	17.4	10.98	6.35	1.2		4.5	
	180616PDFR-MA																		●	17.4	10.98	6.35	1.6		4.5	
	180620PDFR-MA																		●	17.4	10.98	6.35	2.0		4.5	
180624PDFR-MA																		●	17.4	10.98	6.35	2.4	4.5			
180630R-MA																		●	17.4	10.98	6.35	3.0	4.5			
	11T3PDSR-MF			●						●	●	●						●	11.2	6.467	3.6	0.5	2.9		E156~157 E159~164 E168~169	
	1604PDSR-MF			●						●	●	●						●	16.4	9.41	5.76	0.8	4.5		E171~174	
	1806PDSR-MF			●						●	●	●						●	17.4	10.98	6.35	0.8	4.5		E176~177 E179, 182	
	180612PDSR-MF									●	●	●						●	17.4	10.98	6.35	1.2	4.5		E186~188 E191~193 E196, 198 E202~204	
	0903PDER-ML																	●	9.4	6.21	3.6	0.4	2.8		E155~157 E159	
	090308PDER-ML																	●	9.4	6.21	3.6	0.8	2.8		E162~164	
	11T3PDER-ML																	●	11.2	6.467	3.6	0.5	2.9		E166~169	
	11T308PDER-ML																	●	11.2	6.467	3.6	0.8	2.9		E171~172	
	160404PDER-ML																	●	16.4	9.41	5.76	0.4	4.5		E175~179	
	1604PDER-ML																	●	16.4	9.41	5.76	0.8	4.5		E181~182	
	180604PDER-ML																	●	17.4	10.98	6.35	0.4	4.5		E185~188	
	1806PDER-ML																	●	17.4	10.98	6.35	0.8	4.5		E190~193	
	180612PDER-ML																	●	17.4	10.98	6.35	1.2	4.5		E195~198	
	180616PDER-ML																	●	17.4	10.98	6.35	1.6	4.5		E201~204	
	180620PDER-ML																	●	17.4	10.98	6.35	2.0	4.5			
180624PDER-ML																	●	17.4	10.98	6.35	2.4	4.5				
180630R-ML																	●	17.4	10.98	6.35	3.0	4.5				
	060202PDSR-MM			●														●	6	4.24	2.6	0.2	2.0		E154~157 E159~169	
	0602PDSR-MM			●			●	●		●	●	●						●	6	4.24	2.6	0.4	2.0		E171~182	
	060208PDSR-MM			●														●	6	4.24	2.6	0.8	2.0		E184~199	
	060212R-MM			●														●	6	4.24	2.6	1.2	2.0		E200~204	
	060216R-MM *																	●	6	4.24	2.6	1.6	2.0			
	0903PDSR-MM			●			●	●		●	●	●						●	9.4	6.21	3.6	0.4	2.8			
	090308PDSR-MM			●						●	●	●						●	9.4	6.21	3.6	0.8	2.8			
	090312R-MM									●	●	●						●	9.4	6.21	3.6	1.2	2.8			
	090316R-MM			●						●	●	●						●	9.4	6.21	3.6	1.6	2.8			
	090320R-MM									●	●	●						●	9.2	6.21	3.6	2.0	2.8			
	090331R-MM *									●	●	●						●	9.2	6.21	3.6	3.1	2.8			
	090332R-MM *									●	●	●						●	9.2	6.21	3.6	3.2	2.8			

● : Stock item

Inserts marked with an asterisk (*) require a custom-made order for special holders.



Workpiece	Steel	P											Machining types				
	Stainless steel	M															
	Cast iron	K															
	Non-ferrous metal	N															
	Heat resistant alloy, Titanium alloy	S															
	Hardened steel	H															







●	Continuous cutting
⊙	General cutting
⊛	Interrupted cutting

Inserts	Designation	Cermets		Coated								Uncoated		PCD		Dimensions (mm)					Geometries	Available tools																																																																																																																																																																																																																																																																																																																																																																																																																																																																																																																																																																																																
		CN2000	CN30	NC5330	NCM535	NCM545	PC2505	PC2010	PC3600	PC3700	PC6510	PC9530	PC9540	PC5300	PC5400	H01	DP150	DP200	l	d			t	r	d ₁																																																																																																																																																																																																																																																																																																																																																																																																																																																																																																																																																																																													
	1204R-NAW															●		12.7	9.525	4.76	-	4.4		E136																																																																																																																																																																																																																																																																																																																																																																																																																																																																																																																																																																																														
	1204L-NAW																	12.7	9.525	4.76	-	4.4				1204R-XAW															●		12.7	9.525	4.76	-	4.4		E136	1204L-XAW																	12.7	9.525	4.76	-	4.4		1204R-XAF															●		12.7	9.525	4.76	-	4.4		E136	1204L-XAF																	12.7	9.525	4.76	-	4.4		1204R-XCF															●		12.7	9.525	4.76	-	4.4		E136	1204L-XCF																	12.7	9.525	4.76	-	4.4		1005-C0.5																	10	10	5.4	-	4.7		E375 E376	1305-C0.5																	12.7	10	5.4	-	4.7	1606-C0.5																	16	12	6.4	-	5.9		120408-MM									●								12.9	12.7	4.76	0.8	5.5		E343		060204-MM									●								6.4	6.35	2.38	0.4	2.75		E343	080308-MM									●								8.1	7.938	3.40	0.8	3.18	09T308-MM									●								9.7	9.525	3.97	0.8	4.4		090408FN																	9.0	15.875	4.76	0.8	-		E387	090408SN																	9.0	15.875	4.76	0.8	-	090408TN																	9.0	15.875	4.76	0.8	-	110412FN																	11.0	19.05	4.76	1.2	-	110412TN																	11.0	19.05	4.76	1.2	-		090408FN																	9.0	15.875	4.76	0.8	-		E387	090408SN																	9.0	15.875	4.76	0.8	-	090408EN																	9.0	15.875	4.76	0.8	-	110412FN																	11.0	19.05	4.76	1.2	-	110412TN																	11.0	19.05	4.76	1.2	-		090408-WC																	9.0	15.875	4.76	0.8	-		E387	110412-WC																	11.0	19.05
	1204R-XAW															●		12.7	9.525	4.76	-	4.4		E136																																																																																																																																																																																																																																																																																																																																																																																																																																																																																																																																																																																														
	1204L-XAW																	12.7	9.525	4.76	-	4.4				1204R-XAF															●		12.7	9.525	4.76	-	4.4		E136	1204L-XAF																	12.7	9.525	4.76	-	4.4		1204R-XCF															●		12.7	9.525	4.76	-	4.4		E136	1204L-XCF																	12.7	9.525	4.76	-	4.4		1005-C0.5																	10	10	5.4	-	4.7		E375 E376	1305-C0.5																	12.7	10	5.4	-	4.7		1606-C0.5																	16	12	6.4	-	5.9				120408-MM									●								12.9	12.7	4.76	0.8	5.5		E343		060204-MM									●								6.4	6.35	2.38	0.4	2.75		E343	080308-MM									●								8.1	7.938		3.40	0.8	3.18	09T308-MM									●								9.7	9.525			3.97	0.8	4.4		090408FN																	9.0	15.875	4.76	0.8	-		E387	090408SN																		9.0	15.875	4.76	0.8	-	090408TN																			9.0	15.875	4.76	0.8	-	110412FN																	11.0	19.05	4.76	1.2	-	110412TN																	11.0	19.05	4.76	1.2	-		090408FN																	9.0	15.875	4.76	0.8	-		E387	090408SN																		9.0	15.875	4.76	0.8	-	090408EN																			9.0	15.875	4.76	0.8	-	110412FN																	11.0	19.05	4.76	1.2	-	110412TN																	11.0	19.05	4.76	1.2	-		090408-WC																	9.0	15.875	4.76	0.8	-		E387	110412-WC																	11.0	19.05	4.76	1.2	-																																
	1204R-XAF															●		12.7	9.525	4.76	-	4.4		E136																																																																																																																																																																																																																																																																																																																																																																																																																																																																																																																																																																																														
	1204L-XAF																	12.7	9.525	4.76	-	4.4				1204R-XCF															●		12.7	9.525	4.76	-	4.4		E136	1204L-XCF																	12.7	9.525	4.76	-	4.4		1005-C0.5																	10	10	5.4	-	4.7		E375 E376	1305-C0.5																	12.7	10	5.4	-	4.7		1606-C0.5																	16	12	6.4	-	5.9				120408-MM									●								12.9	12.7	4.76	0.8	5.5		E343		060204-MM									●								6.4	6.35	2.38	0.4	2.75		E343	080308-MM									●								8.1	7.938	3.40	0.8	3.18		09T308-MM									●								9.7	9.525	3.97	0.8	4.4				090408FN																	9.0	15.875	4.76	0.8	-		E387	090408SN																	9.0	15.875	4.76	0.8	-		090408TN																	9.0	15.875	4.76	0.8	-			110412FN																		11.0	19.05	4.76	1.2	-	110412TN																			11.0	19.05	4.76	1.2	-		090408FN																	9.0	15.875	4.76	0.8	-		E387	090408SN																	9.0	15.875		4.76	0.8	-	090408EN																	9.0	15.875			4.76	0.8	-	110412FN																		11.0	19.05	4.76	1.2	-	110412TN																			11.0	19.05	4.76	1.2	-		090408-WC																	9.0	15.875	4.76	0.8	-		E387	110412-WC																	11.0	19.05	4.76	1.2	-																																																																									
	1204R-XCF															●		12.7	9.525	4.76	-	4.4		E136																																																																																																																																																																																																																																																																																																																																																																																																																																																																																																																																																																																														
	1204L-XCF																	12.7	9.525	4.76	-	4.4				1005-C0.5																	10	10	5.4	-	4.7		E375 E376	1305-C0.5																	12.7	10	5.4	-	4.7		1606-C0.5																	16	12	6.4	-	5.9				120408-MM									●								12.9	12.7	4.76	0.8	5.5		E343		060204-MM									●								6.4	6.35	2.38	0.4	2.75		E343	080308-MM									●								8.1	7.938	3.40	0.8	3.18		09T308-MM									●								9.7	9.525	3.97	0.8	4.4				090408FN																	9.0	15.875	4.76	0.8	-		E387	090408SN																	9.0	15.875	4.76	0.8	-		090408TN																	9.0	15.875	4.76	0.8	-			110412FN																	11.0	19.05	4.76	1.2	-		110412TN																	11.0	19.05	4.76	1.2	-				090408FN																	9.0	15.875	4.76	0.8	-		E387	090408SN																	9.0	15.875	4.76	0.8	-		090408EN																	9.0	15.875	4.76	0.8	-			110412FN																	11.0	19.05		4.76	1.2	-	110412TN																	11.0	19.05			4.76	1.2	-		090408-WC																	9.0	15.875	4.76	0.8	-		E387	110412-WC																	11.0	19.05	4.76	1.2	-																																																																																																																								
	1005-C0.5																	10	10	5.4	-	4.7		E375 E376																																																																																																																																																																																																																																																																																																																																																																																																																																																																																																																																																																																														
	1305-C0.5																	12.7	10	5.4	-	4.7																																																																																																																																																																																																																																																																																																																																																																																																																																																																																																																																																																																																
	1606-C0.5																	16	12	6.4	-	5.9				120408-MM									●								12.9	12.7	4.76	0.8	5.5		E343		060204-MM									●								6.4	6.35	2.38	0.4	2.75		E343	080308-MM									●								8.1	7.938	3.40	0.8	3.18	09T308-MM									●								9.7	9.525	3.97	0.8	4.4		090408FN																	9.0	15.875	4.76	0.8	-		E387	090408SN																	9.0	15.875	4.76	0.8	-	090408TN																	9.0	15.875	4.76	0.8	-	110412FN																		11.0	19.05	4.76	1.2	-	110412TN																			11.0	19.05	4.76	1.2	-		090408FN																	9.0	15.875	4.76	0.8	-		E387	090408SN																	9.0	15.875	4.76	0.8	-	090408EN																	9.0	15.875	4.76	0.8	-	110412FN																		11.0	19.05	4.76	1.2	-	110412TN																			11.0	19.05	4.76	1.2	-		090408-WC																	9.0	15.875	4.76	0.8	-		E387	110412-WC																	11.0	19.05	4.76	1.2	-																																																																																																																																																																																																									
	120408-MM									●								12.9	12.7	4.76	0.8	5.5		E343																																																																																																																																																																																																																																																																																																																																																																																																																																																																																																																																																																																														
	060204-MM									●								6.4	6.35	2.38	0.4	2.75		E343																																																																																																																																																																																																																																																																																																																																																																																																																																																																																																																																																																																														
	080308-MM									●								8.1	7.938	3.40	0.8	3.18																																																																																																																																																																																																																																																																																																																																																																																																																																																																																																																																																																																																
	09T308-MM									●								9.7	9.525	3.97	0.8	4.4				090408FN																	9.0	15.875	4.76	0.8	-		E387	090408SN																	9.0	15.875	4.76	0.8	-	090408TN																	9.0	15.875	4.76	0.8	-	110412FN																	11.0	19.05	4.76	1.2	-	110412TN																		11.0	19.05	4.76	1.2	-		090408FN																			9.0	15.875	4.76	0.8	-		E387	090408SN																	9.0	15.875	4.76	0.8	-	090408EN																	9.0	15.875	4.76	0.8	-	110412FN																	11.0	19.05	4.76	1.2	-	110412TN																		11.0	19.05	4.76	1.2	-		090408-WC																			9.0	15.875	4.76	0.8	-		E387	110412-WC																	11.0	19.05	4.76	1.2	-																																																																																																																																																																																																																																																																																																							
	090408FN																	9.0	15.875	4.76	0.8	-		E387																																																																																																																																																																																																																																																																																																																																																																																																																																																																																																																																																																																														
	090408SN																	9.0	15.875	4.76	0.8	-																																																																																																																																																																																																																																																																																																																																																																																																																																																																																																																																																																																																
	090408TN																	9.0	15.875	4.76	0.8	-																																																																																																																																																																																																																																																																																																																																																																																																																																																																																																																																																																																																
	110412FN																	11.0	19.05	4.76	1.2	-																																																																																																																																																																																																																																																																																																																																																																																																																																																																																																																																																																																																
	110412TN																	11.0	19.05	4.76	1.2	-				090408FN																	9.0	15.875	4.76	0.8	-		E387	090408SN																	9.0	15.875	4.76	0.8	-	090408EN																	9.0	15.875	4.76	0.8	-	110412FN																	11.0	19.05	4.76	1.2	-	110412TN																	11.0	19.05	4.76	1.2	-		090408-WC																	9.0	15.875	4.76	0.8	-		E387	110412-WC																	11.0	19.05	4.76	1.2	-																																																																																																																																																																																																																																																																																																																																																																																																																														
	090408FN																	9.0	15.875	4.76	0.8	-		E387																																																																																																																																																																																																																																																																																																																																																																																																																																																																																																																																																																																														
	090408SN																	9.0	15.875	4.76	0.8	-																																																																																																																																																																																																																																																																																																																																																																																																																																																																																																																																																																																																
	090408EN																	9.0	15.875	4.76	0.8	-																																																																																																																																																																																																																																																																																																																																																																																																																																																																																																																																																																																																
	110412FN																	11.0	19.05	4.76	1.2	-																																																																																																																																																																																																																																																																																																																																																																																																																																																																																																																																																																																																
	110412TN																	11.0	19.05	4.76	1.2	-				090408-WC																	9.0	15.875	4.76	0.8	-		E387	110412-WC																	11.0	19.05	4.76	1.2	-																																																																																																																																																																																																																																																																																																																																																																																																																																																																																																																																															
	090408-WC																	9.0	15.875	4.76	0.8	-		E387																																																																																																																																																																																																																																																																																																																																																																																																																																																																																																																																																																																														
	110412-WC																	11.0	19.05	4.76	1.2	-																																																																																																																																																																																																																																																																																																																																																																																																																																																																																																																																																																																																

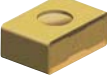
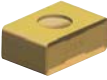
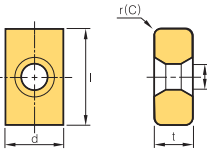
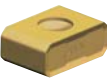
● : Stock item

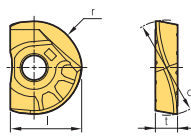
E Milling Inserts

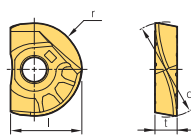

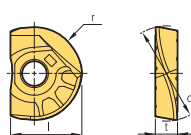
Workpiece	Steel	P	●	●	●	●	●	●	●	●	●	●	●	●	●	●	●	●	●	●	Machining types
	Stainless steel	M							●	●	●	●	●	●	●	●	●	●	●	●	
Cast iron	K			●	●	●	●	●	●	●	●	●	●	●	●	●	●	●	●	●	
Non-ferrous metal	N																				
Heat resistant alloy, Titanium alloy	S																				
Hardened steel	H																				

Inserts	Designation	Cermets		Coated											Uncoated		Dimensions (mm)					Geometries	Available tools	
		CN2000	CN30	NC5330	NCM535	NCM545	PC2505	PC2010	PC2015	PC210F	PC3700	PC6510	PC9530	PC9540	PC5400	ST30A	H01	l	d	t	r			d ₁
KEL-MF 	150608-MF																	15.88	15.23	6.35	0.8	-		E408
	150608-ML																	15.88	15.23	6.35	0.8	-		
KEL-QNN 	1506QNN-MF																	15.88	15.23	6.35	0.8	-		E391
	1506QNN-ML																	15.88	15.23	6.35	0.8	-		
KEL-ANN 	1506ANN-MF																	15.88	15.23	6.35	0.8	-		E391
	1506ANN-ML																	15.88	15.23	6.35	0.8	-		
LBH 	080									●								7.0	8	2.4	4.0	-		E319~ E322
	100									●								8.5	10	2.6	5.0	-		
	120									●								10.0	12	3.0	6.0	-		
	160									●								12.0	16	4.0	8.0	-		
	200									●								15.0	20	5.0	10.0	-		
	250									●								18.5	25	6.0	12.5	-		
	300									●								22.5	30	7.0	15.0	-		
	320									●								23.5	32	7.0	16.0	-		
330									●								24.0	33	7.0	16.5	-			
LBH-KF 	080-KF																	7.0	8	2.4	4.0	-		E318 E319
	100-KF									●								8.5	10	2.6	5.0	-		
	120-KF									●								10.0	12	3.0	6.0	-		
	130-KF									●								20.5	13	3.0	6.5	-		
	160-KF									●								12.0	16	4.0	8.0	-		
	170-KF									●								12.5	17	4.0	8.5	-		
	200-KF									●								15.0	20	5.0	10.0	-		
	210-KF									●								15.5	21	5.0	10.5	-		
	250-KF									●								18.5	25	6.0	12.5	-		
	300-KF									●								22.5	30	7.0	15.0	-		
	320-KF									●								23.5	32	7.0	16.0	-		
	330-KF									●								24.0	33	7.0	16.5	-		
LBH-KH 	080-KH									●								7.0	8	2.4	4.0	-		E318 E319
	100-KH									●	●							8.5	10	2.6	5.0	-		
	120-KH									●	●							10.0	12	3.0	6.0	-		
	130-KH									●	●							20.5	13	3.0	6.5	-		
	160-KH									●	●							12.0	16	4.0	8.0	-		
	170-KH									●	●							12.5	17	4.0	8.5	-		
	200-KH									●	●							15.0	20	5.0	10.0	-		
	210-KH									●	●							15.5	21	5.0	10.5	-		
	250-KH									●	●							18.5	25	6.0	12.5	-		
	260-KH									●	●							19.0	26	6.0	13.0	-		
	300-KH									●	●							22.5	30	7.0	15.0	-		
	320-KH									●	●							23.5	32	7.0	16.0	-		
330-KH									●	●							24.0	33	7.0	16.5	-			

● : Stock item

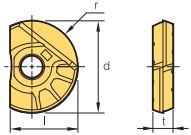

Workpiece	Steel	P											Machining types
	Stainless steel	M											
Cast iron	K											● Continuous cutting ● General cutting ✱ Interrupted cutting	
Non-ferrous metal	N												
Heat resistant alloy, Titanium alloy	S												
Hardened steel	H												

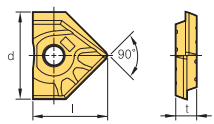
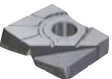
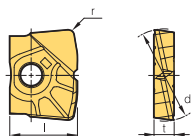
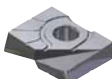
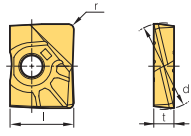
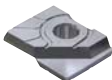
Inserts	Designation	Cermets		Coated										Uncoated		Dimensions (mm)					Geometries	Available tools		
		CN2000	CN30	NC5330	NCM535	NCM545	PC2505	PC2010	PC210F	PC3600	PC3700	PC6510	PC9530	PC9540	PC5300	PC5400	ST30A	H01	l	d			t	r
 LBS	080																	18.5	25	6.0	12.5	-		E319~ E322
	090																	19.0	26	6.0	13.0	-		
	100																	22.5	30	7.0	15.0	-		
	110																	23.0	31	7.0	15.5	-		
	120																	23.5	32	7.0	16.0	-		
	130																	7.0	8	2.4	4.0	-		
	160																	7.5	9	2.4	4.5	-		
	170																	8.5	10	2.6	5.0	-		
	200																	9.0	11	2.6	5.5	-		
	210																	10.0	12	3.0	6.0	-		
	250																	10.5	13	3.0	6.5	-		
	260																	12.0	16	4.0	8.0	-		
	300																	12.5	17	4.0	8.5	-		
	310																	15.0	20	5.0	10.0	-		
320																	15.5	21	5.0	10.5	-			
 LCF	160-D90																	13.7	16	4.0	-	-		E319~ E322
	200-D90																	17.0	20	5.0	-	-		
	250-D90																	21.5	25	6.0	-	-		
 LFH	100																	8.5	10	2.6	1.0	-		E319~ E322
	120																	10.0	12	3.0	1.0	-		
	160																	12.0	16	4.0	1.5	-		
	200																	15.0	20	5.0	1.5	-		
	250																	18.5	25	6.0	2.0	-		
	300																	22.5	30	7.0	2.0	-		
	320																	23.5	32	7.0	2.0	-		
 LRH	100-R05																	8.5	10	2.6	0.5	-		E319~ E322
	100-R10																	8.5	10	2.6	1.0	-		
	100-R20																	8.5	10	2.6	2.0	-		
	110-R05																	9.0	11	2.6	0.5	-		
	120-R05																	10.0	12	3.0	0.5	-		
	120-R10																	10.0	12	3.0	1.0	-		
	120-R20																	10.0	12	3.0	2.0	-		
	130-R05																	10.5	13	3.0	0.5	-		
	130-R10																	10.5	13	3.0	1.0	-		
	160-R05																	12.0	16	4.0	0.5	-		
	160-R10																	12.0	16	4.0	1.0	-		
	160-R20																	12.0	16	4.0	2.0	-		
	160-R30																	12.0	16	4.0	3.0	-		
	170-R05																	12.5	17	4.0	0.5	-		
	170-R10																	12.5	17	4.0	1.0	-		
	200-R05																	15.0	20	5.0	0.5	-		
	200-R10																	15.0	20	5.0	1.0	-		
	200-R20																	15.0	20	5.0	2.0	-		
	200-R30																	15.0	20	5.0	3.0	-		
	 LR (Special type)	210-R05																	15.5	21	5.0	0.5		
210-R10																		15.5	21	5.0	1.0	-		
250-R05																		18.5	25	6.0	0.5	-		
250-R10																		18.5	25	6.0	1.0	-		
250-R20																		18.5	25	6.0	2.0	-		
250-R30																		18.5	25	6.0	3.0	-		
260-R05																		19.0	26	6.0	0.5	-		
260-R10																		19.0	26	6.0	1.0	-		
300-R10																		22.5	30	7.0	1.0	-		
300-R20																		22.5	30	7.0	2.0	-		
300-R30																		22.5	30	7.0	3.0	-		
310-R05																		23.0	31	7.0	0.5	-		
320-R10																	23.5	32	7.0	1.0	-			
320-R20																	23.5	32	7.0	2.0	-			











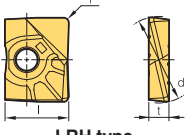
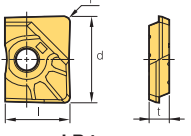

● : Stock item

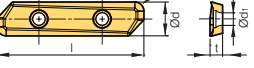
E Milling Inserts

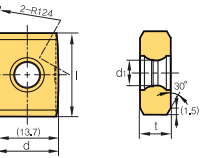
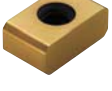
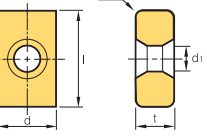
Workpiece	Steel	P	●	●	●	●	●	●	●	●	●	●	●	●	●	●	●	●	●	
	Stainless steel	M																		
	Cast iron	K		●	●	●	●	●	●	●	●	●	●	●	●	●	●	●	●	●
	Non-ferrous metal	N																		
	Heat resistant alloy, Titanium alloy	S																		
	Hardened steel	H																		

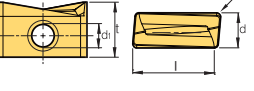
Machining types

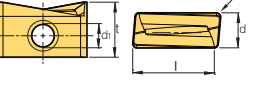

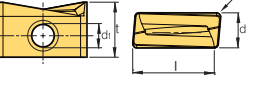







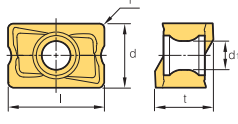

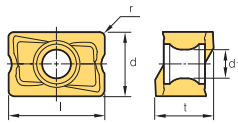
- Continuous cutting
- General cutting
- Interrupted cutting

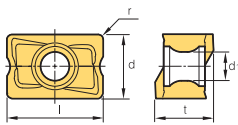
Inserts	Designation	Cermet		Coated									Uncoated		Dimensions (mm)					Geometries	Available tools			
		CN2000	CN30	NC5330	NCM535	NCM545	PC2505	PC2010	PC210F	PC3600	PC3700	PC6510	PC9530	PC9540	PC5300	PC5400	ST30A	H01	l			d	t	r
LRH  LR  (Special type)	320-R30								●									23.5	32	7.0	3.0	-	 LRH type  LR type	
	330-R05																	24.0	33	7.0	0.5	-		
	330-R10																	24.0	33	7.0	1.0	-		
	330-R20																	24.0	33	7.0	2.0	-		
	330-R30																	24.0	33	7.0	3.0	-		
LDET ^{new} 	650540PPFR-MA																	65	15	5.625	4.0	5.56	 E367	
	650550PPFR-MA																	65	15	5.625	5.0	5.56		
LNCS 	1907-C1.5-WC																	19.05	14.3	7	-	5.8	 E398 E399	
	1907-R3.0-WC																	19.05	14.3	7	-	5.8		
LNE 	324-R0.8																	15.9	9.525	6.35	0.8	4.4	 E405~ E409	
	324-C1.0																	15.9	9.525	6.35	1.0	4.4		
LNKT-MA ^{new} 	080404PNR-MA																	8.0	4.2	6.6	0.4	2.8	 E303~ E308	
	080408PNR-MA																	8.0	4.2	6.6	0.8	2.8		
	140608PNR-MA																	12.7	6.65	10.0	0.8	4.0		
	170704PNR-MA																	16.5	7.0	11.0	0.4	4.5		
	170708PNR-MA																	16.5	7.0	11.0	0.8	4.5		
	170712PNR-MA																	16.5	7.0	11.0	1.2	4.5		
	170716PNR-MA																	16.5	7.0	11.0	1.6	4.5		
	170720PNR-MA																	16.5	7.0	11.0	2.0	4.5		
LNKT-ML ^{new} 	080404PNR-ML																	8.0	4.2	6.6	0.4	2.8	 E303~ E308	
	080408PNR-ML																	8.0	4.2	6.6	0.8	2.8		
	140608PNR-ML																	12.7	6.65	10.0	0.8	4.0		
	170704PNR-ML																	16.5	7.0	11.0	0.4	4.5		
	170708PNR-ML										●				●			16.5	7.0	11.0	0.8	4.5		
	170712PNR-ML																	16.5	7.0	11.0	1.2	4.5		
	170716PNR-ML																	16.5	7.0	11.0	1.6	4.5		
	170720PNR-ML																	16.5	7.0	11.0	2.0	4.5		
LNKT-MM ^{new} 	080404PNR-MM																	8.0	4.2	6.6	0.4	2.8	 E303~ E308	
	080408PNR-MM																	8.0	4.2	6.6	0.8	2.8		
	140608PNR-MM																	12.7	6.65	10.0	0.8	4.0		
	170704PNR-MM																	16.5	7.0	11.0	0.4	4.5		
	170708PNR-MM																	16.5	7.0	11.0	0.8	4.5		
	170712PNR-MM																	16.5	7.0	11.0	1.2	4.5		
	170716PNR-MM																	16.5	7.0	11.0	1.6	4.5		
	170720PNR-MM																	16.5	7.0	11.0	2.0	4.5		

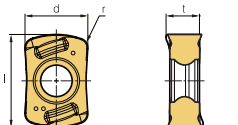
● : Stock item

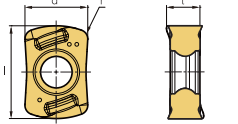

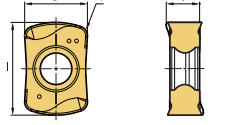
Workpiece	Steel	P	●	●	●	●	●	●	●	●	●	●	●	●	●	●	Machining types ● Continuous cutting ● General cutting ✱ Interrupted cutting
	Stainless steel	M															
	Cast iron	K															
	Non-ferrous metal	N															
	Heat resistant alloy, Titanium alloy	S															
	Hardened steel	H															

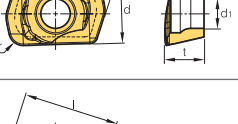





Inserts	Designation	Cermets		Coated										Uncoated		Dimensions (mm)					Geometries	Available tools		
		CN2000	CN30	NC5330	NCM535	NCM545	PC2505	PC2510	PC2010	PC3600	PC3700	PC6510	PC9530	PC9540	PC5300	PC5400	ST30A	H01	l	d			t	r
	100605PNR-MA																●	10.0	6.5	6.5	0.5	3.5		E95~96 E99~100 E103~ E107
	151004PNR-MA																●	15.0	10.0	10.0	0.4	4.5		
	151008PNR-MA																	●	15.0	10.0	10.0	0.8		
	LNMX 100605PNR-MF										●	●						10.0	6.5	6.5	0.5	3.5		E95 E96 E99 E100 E103~ E107
	100608PNR-MF									●	●							10.0	6.5	6.5	0.8	3.5		
	151004PNR-MF										●	●						15.0	10.0	10.0	0.4	4.5		
	151008PNR-MF			●							●	●						15.0	10.0	10.0	0.8	4.5		
	151016PNR-MF										●	●						15.0	10.0	10.0	1.6	4.5		
	LNEX 100605PNR-MF										●							10.0	6.5	6.5	0.5	3.5		
	100608PNR-MF										●	●						10.0	6.5	6.5	0.8	3.5		
	151004PNR-MF										●							15.0	10.0	10.0	0.4	4.5		
	151008PNR-MF										●							15.0	10.0	10.0	0.8	4.5		
	151016PNR-MF										●							15.0	10.0	10.0	1.6	4.5		
	LNMX 100605PNR-MM										●	●	●					10.0	6.5	6.5	0.5	3.5		E95~ E109
	100608PNR-MM										●	●						10.0	6.5	6.5	0.8	3.5		
	100605PNL-MM										●	●	●					10.0	6.5	6.5	0.5	3.5		
	151004PNR-MM										●	●						15.0	10.0	10.0	0.4	4.5		
	151008PNR-MM			●							●	●	●					15.0	10.0	10.0	0.8	4.5		
	151016PNR-MM										●	●						15.0	10.0	10.0	1.6	4.5		
	151008PNL-MM										●							15.0	10.0	10.0	0.8	4.5		
	LNEX 100605PNR-MM										●	●						10.0	6.5	6.5	0.5	3.5		
	100608PNR-MM										●							10.0	6.5	6.5	0.8	3.5		
	100605PNL-MM										●	●						10.0	6.5	6.5	0.5	3.5		
	151004PNR-MM										●							15.0	10.0	10.0	0.4	4.5		
	151008PNR-MM										●	●						15.0	10.0	10.0	0.8	4.5		
151016PNR-MM										●							15.0	10.0	10.0	1.6	4.5			
151008PNL-MM										●							15.0	10.0	10.0	0.8	4.5			
	060310R-MF								●			●						10.0	6.8	3.6	1	-		E264~ E267
	060310R-ML																	10.0	6.8	3.6	1	-		
	060310R-ML																	10.0	6.8	3.6	1	-		E264~ E267
	060310R-MM																	10.0	6.8	3.6	1	-		
	060310R-MM																	10.0	6.8	3.6	1	-		E264~ E267
	040210R										●	●						6.4	4.2	2.6	1.0	2.0		
	040220R										●	●						6.4	4.2	2.6	2.0	2.0		E273~ E275
	040210R										●	●						6.4	4.2	2.6	1.0	2.0		

● : Stock item

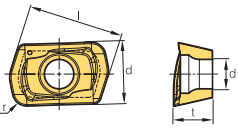
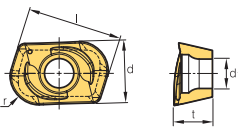

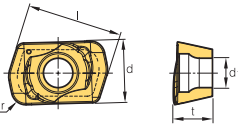
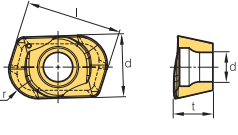
E Milling Inserts

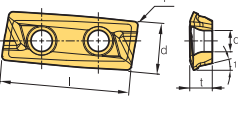
Workpiece	Steel	P	●	●	●	●	●	●	●	●	●	●	●	●	●	●	●	●	●	●	Machining types	
	Stainless steel	M																				● Continuous cutting ● General cutting ✦ Interrupted cutting
	Cast iron	K																				
	Non-ferrous metal	N																				
	Heat resistant alloy, Titanium alloy	S																				
Hardened steel	H																					

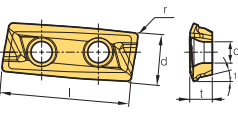
Inserts	Designation	Cermets		Coated									Uncoated		Dimensions (mm)					Geometries	Available tools				
		CN2000	CN30	NC5330	NCM535	NCM545	PC2505	PC2510	PC2010	PC3600	PC3700	PC6510	PC9530	PC9540	PC5300	PC5400	ST30A	H01	l			d	t	r	d ₁
 LPMT-MF	LPMT_040210R-MF																	6.4	4.2	2.6	1.0	2.0		E273~ E275	
	LPMT_040220R-MF																		6.4	4.2	2.6	2.0	2.0		E273~ E275
 LPMW	LPMW_040210R																	6.4	4.2	2.6	1.0	2.0		E273~ E275	
	LPMW_040220R																		6.4	4.2	2.6	2.0	2.0		E273~ E275
 LXET-MA	250404PEFR-32-MA																	25	10.775	4.76	0.4	4.5		E363~ E366	
	2504PEFR-32-MA																	●	25	10.775	4.76	0.8			4.5
	250412PEFR-32-MA																		25	10.775	4.76	1.2			4.5
	250416PEFR-32-MA																		25	10.775	4.76	1.6			4.5
	250404PEFR-40-MA																		25	10.618	4.76	0.4			4.5
	2504PEFR-40-MA																		25	10.618	4.76	0.8			4.5
	250412PEFR-40-MA																		25	10.618	4.76	1.2			4.5
	250416PEFR-40-MA																		25	10.618	4.76	1.6			4.5
	340504PEFR-50-MA																	●	34	13.765	5.56	0.4			5.56
	3405PEFR-50-MA																	●	34	13.765	5.56	0.8			5.56
	340512PEFR-50-MA																		34	13.765	5.56	1.2			5.56
	340516PEFR-50-MA																		34	13.765	5.56	1.6			5.56
	340504PEFR-63-MA																		34	13.803	5.56	0.4			5.56
	3405PEFR-63-MA																	●	34	13.803	5.56	0.8			5.56
340512PEFR-63-MA																		34	13.803	5.56	1.2	5.56			
340516PEFR-63-MA																		34	13.803	5.56	1.6	5.56			
 LXET-ML	250404PEER-32-ML																	25	10.775	4.76	0.4	4.5		E363~ E366	
	2504PEER-32-ML																		25	10.775	4.76	0.8			4.5
	250412PEER-32-ML																		25	10.775	4.76	1.2			4.5
	250416PEER-32-ML																		25	10.775	4.76	1.6			4.5
	250404PEER-40-ML																		25	10.618	4.76	0.4			4.5
	2504PEER-40-ML																		25	10.618	4.76	0.8			4.5
	250412PEER-40-ML																		25	10.618	4.76	1.2			4.5
	250416PEER-40-ML																		25	10.618	4.76	1.6			4.5
	340504PEER-50-ML																		34	13.765	5.56	0.4			5.56
	3405PEER-50-ML																	●	34	13.765	5.56	0.8			5.56
	340512PEER-50-ML																		34	13.765	5.56	1.2			5.56
	340516PEER-50-ML																		34	13.765	5.56	1.6			5.56
	340504PEER-63-ML																		34	13.803	5.56	0.4			5.56
	3405PEER-63-ML																		34	13.803	5.56	0.8			5.56
340512PEER-63-ML																		34	13.803	5.56	1.2	5.56			
340516PEER-63-ML																		34	13.803	5.56	1.6	5.56			

● : Stock item



Workpiece	Steel	P													Machining types					
	Stainless steel	M	●	●	●	●	●	●	●	●	●	●	●	●		●	●	●	●	●
Cast iron	K	●	●	●	●	●	●	●	●	●	●	●	●	●	●	●	●	●	●	●
Non-ferrous metal	N	●	●	●	●	●	●	●	●	●	●	●	●	●	●	●	●	●	●	●
Heat resistant alloy, Titanium alloy	S	●	●	●	●	●	●	●	●	●	●	●	●	●	●	●	●	●	●	●
Hardened steel	H	●	●	●	●	●	●	●	●	●	●	●	●	●	●	●	●	●	●	●

● Continuous cutting
 ● General cutting
 ✳ Interrupted cutting

Inserts	Designation	Cermet		Coated									Uncoated		Dimensions (mm)					Geometries	Available tools			
		CN2000	CN30	NCM325	NCM335	NC5330	NCM535	NCM545	PC2505	PC2010	PC3700	PC6510	PC9530	PC9540	PC5300	PC5400	ST30A	H01	l			d	t	r
MPMT	090308																	9.5	9.525	3.18	0.8	4.5		
	120408										●							12.7	12.7	4.76	0.8	5.5		
OFCN	0704SN																●	7.4	18	4.86	0.5	-		E60
	0704FN																	7.4	18	4.86	0.5	-		
	070408SN																	7.4	18	4.86	0.8	-		
	070408FN																	7.4	18	4.86	0.8	-		
	070408TN																		7.4	18	4.86	0.8		
OFCW	05T3SN																	5.2	12.7	3.85	0.5	4.4		E59
	05T3FN																	5.2	12.7	3.85	0.5	4.4		
	05T308FN																	5.2	12.7	3.85	0.8	4.4		
OFKR-MA	0704FN-MA																●	7.4	18	4.76	0.5	-		E60
	0704EN-MA																	7.4	18	4.76	0.5	-		
OFKR-MF	0704SN-MF			●	●													7.4	18	4.76	0.5	-		E60
	070408SN-MF																	7.4	18	4.76	0.8	-		
OFKR-MM	0704SN-MM			●	●						●	●	●		●			7.4	18	4.76	0.5	-		E60
	070408SN-MM			●														7.4	18	4.76	0.8	-		
OFKT-MA	05T3FN-MA																●	5.2	12.7	3.97	0.5	4.4		E59 E60
	05T3EN-MA																	5.2	12.7	3.97	0.5	4.4		
	0704FN-MA																●	7.4	18	4.76	0.5	5.8		
	0704EN-MA																	7.4	18	4.76	0.5	5.8		
OFKT-MF	05T3SN-MF																●	5.2	12.7	3.97	0.5	4.4		E59
	05T308SN-MF																	5.2	12.7	3.97	0.8	5.8		











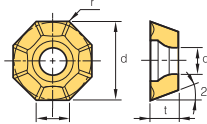

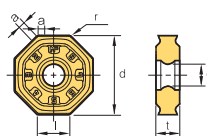

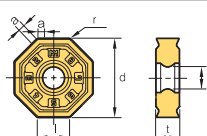

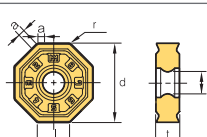
● : Stock item

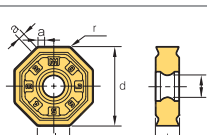
E Milling Inserts

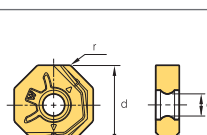
Workpiece	Steel	P	●	●	●	●	●	●	●	●	●	●	●	●	●	●	●	●	Machining types		
	Stainless steel	M		●	●	●	●	●	●	●	●	●	●	●	●	●	●	●	●	●	●
	Cast iron	K		●	●	●	●	●	●	●	●	●	●	●	●	●	●	●	●	●	●
	Non-ferrous metal	N																			
	Heat resistant alloy, Titanium alloy	S																			
Hardened steel	H																				

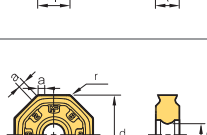
Machining types

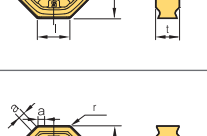
- Continuous cutting
- General cutting
- ✦ Interrupted cutting

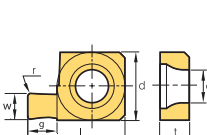
Inserts	Designation	Cermet		Coated										Uncoated		Dimensions (mm)								Geometries	Available tools			
		CN2000	CN30	NCM325	NC5330	NCM535	NCM545	PC2505	PC2010	PC3600	PC3700	PC6510	PC9530	PC9540	PC5300	PC5400	ST30A	H01	l	d	t	r	d ₁			a	W	g
OFKT-MM 	05T3SN-MM			●															5.2	12.7	3.97	0.5	4.4	-	-	-		E59
	05T308SN-MM																		5.2	12.7	3.97	0.8	4.4	-	-	-		E60
	0704SN-MM																		7.4	18	4.76	0.5	5.5	-	-	-		
ONHX-MF 	060608-MF																		6.6	16.0	6.0	0.8	5.6	-	-	-		E130
	080608-MF																		8.4	20.2	6.0	0.8	5.6	-	-	-		E131
	0606ANN-MF																		6.6	16.0	6.0	0.8	5.6	1.03	-	-		
	0806ANN-MF																		8.4	20.2	6.0	0.8	5.6	1.53	-	-		
ONHX-ML 	060608-ML																		6.6	16.0	6.0	0.8	5.6	-	-	-		E130
	080608-ML																		8.4	20.2	6.0	0.8	5.6	-	-	-		E131
ONHX-MM 	060608-MM																		6.6	16.0	6.0	0.8	5.6	-	-	-		E130
	080608-MM																		8.4	20.2	6.0	0.8	5.6	-	-	-		E131
	0606ANN-MM																		6.6	16.0	6.0	0.8	5.6	1.03	-	-		
	0806ANN-MM																		8.4	20.2	6.0	0.8	5.6	1.53	-	-		
ONHX-MA 	060608-MA																●	6.6	16.0	6.0	0.8	5.6	-	-	-		E130	
	080608-MA																●	8.4	20.2	6.0	0.8	5.6	-	-	-		E131	
ONHX-W 	060608-W																		6.5	16.0	6.0	0.8	5.6	-	-	-		E130
	080608-W																		8.2	20.2	6.0	0.8	5.6	-	-	-		E131
ONMX-MF 	060608-MF				●														6.6	16.0	6.0	0.8	5.6	-	-	-		E130
	080608-MF																		8.4	20.2	6.0	0.8	5.6	-	-	-		E131
	0606ANN-MF																		6.6	16.0	6.0	0.8	5.6	1.03	-	-		
	0806ANN-MF																		8.4	20.2	6.0	0.8	5.6	1.53	-	-		
ONMX-MM 	060608-MM				●														6.6	16.0	6.0	0.8	5.6	-	-	-		E130
	080608-MM																		8.4	20.2	6.0	0.8	5.6	-	-	-		E131
	0606ANN-MM																		6.6	16.0	6.0	0.8	5.6	1.03	-	-		
	0806ANN-MM																		8.4	20.2	6.0	0.8	5.6	1.53	-	-		
ORG 	265																		10	7	3.0	0.3	3.5	-	2.65	2.8		E334
	325																		10	7	3.0	0.3	3.5	-	3.25	2.8		
	405																		15	12	4.5	0.5	4.5	-	4.05	4.5		
	470																		15	12	4.5	0.5	4.5	-	4.70	4.5		

● : Stock item



Workpiece	Machining types										
	P	M	K	N	S	H	●	●	●	●	●
Steel	●	●	●	●	●	●	●	●	●	●	●
Stainless steel	●	●	●	●	●	●	●	●	●	●	●
Cast iron	●	●	●	●	●	●	●	●	●	●	●
Non-ferrous metal	●	●	●	●	●	●	●	●	●	●	●
Heat resistant alloy, Titanium alloy	●	●	●	●	●	●	●	●	●	●	●
Hardened steel	●	●	●	●	●	●	●	●	●	●	●

Inserts	Designation	Cermets										Coated										Uncoated		Dimensions (mm)						Geometries	Available tools
		CN2000	CN30	NC5330	NCM535	NCM545	PC2505	PC2010	PC210F	PC3600	PC3700	PC6510	PC9530	PC9540	PC5300	PC5400	ST30A	H01	l	d	t	r	d ₁	Cutter width							
	1223N									●								-	12.7	2.3	-	5.0	4.0		E379 E380						
	1225N									●								-	12.7	2.5	-	5.0	4.5								
	1230N																	-	12.7	3.0	-	5.0	5.0								
	1235N																	-	12.7	3.5	-	5.0	6.0								
	1240N																	-	12.7	4.0	-	5.0	7.0								
	1245N																	-	12.7	4.5	-	5.0	8.0								
	1250N																	-	12.7	5.0	-	5.0	9.0								
	1255N																	-	12.7	5.5	-	5.0	10.0								
	1260N																	-	12.7	6.0	-	5.0	11.0								
	1265N																	-	12.7	6.5	-	5.0	12.0								
	1270N																	-	12.7	7.0	-	5.0	13.0								
	1275N																	-	12.7	7.5	-	5.0	14.0								
	1285N																	-	12.7	8.5	-	5.0	16.0								
		1223N-C03																-	12.7	2.3	-	5.0	4.0				E379 E380				
1230N-C03																	-	12.7	3.0	-	5.0	5.0									
1235N-C03																	-	12.7	3.5	-	5.0	6.0									
1240N-C05																	-	12.7	4.0	-	5.0	7.0									
1245N-C05																	-	12.7	4.5	-	5.0	8.0									
1250N-C05																	-	12.7	5.0	-	5.0	9.0									
1255N-C05																	-	12.7	5.5	-	5.0	10.0									
1260N-C05																	-	12.7	6.0	-	5.0	11.0									
1265N-C05																	-	12.7	6.5	-	5.0	12.0									
1270N-C05																	-	12.7	7.0	-	5.0	13.0									
1275N-C05																-	12.7	7.5	-	5.0	14.0										
	16																15.8	16	3.5	8	-	-		E323							
	20																17.8	20	4	10	-	-									
	25																22.0	25	5	12.5	-	-									
	30																26.8	30	6	15	-	-									
	32																27.8	32	6	16	-	-									
	10T3M0-MA																●	-	10	3.97	-	3.85	-		E234 E235 E240 E241 E246						
	1204M0-MA																●	-	12	4.76	-	4.5	-								
	0501M0F																	-	5	1.59	-	2.3	-		E238 E239 E244 E245						
	0501M0E																●	-	5	1.59	-	2.3	-								
	0501M0S																	-	5	1.59	-	2.3	-								
	06T1M0F																	-	6	1.98	-	2.5	-								
	06T1M0E																●	-	6	1.98	-	2.5	-								
	06T1M0S																	-	6	1.98	-	2.5	-								
	0702M0F																	-	7	2.38	-	2.8	-								
	0702M0E																●	-	7	2.38	-	2.8	-								
	0702M0S																	-	7	2.38	-	2.8	-								
	0803M0F																	-	8	3.18	-	3.4	-								
	0803M0E																●	-	8	3.18	-	3.4	-								
	0803M0S																	-	8	3.18	-	3.4	-								
	1605M0F																	-	16	5.56	-	5.5	-								
	1605M0E																	-	16	5.56	-	5.5	-								
1605M0S																	-	16	5.56	-	5.5	-									
2006M0F																	-	20	6.35	-	5.5	-									
2006M0E																	-	20	6.35	-	5.5	-									
2006M0S																	-	20	6.35	-	5.5	-									
	10T3M0-MF																-	10	3.97	-	3.85	-		E234 E235 E240 E241 E246							
	1204M0-MF															●	-	12	4.76	-	4.5	-									
	1605M0-MF															●	-	16	5.56	-	5.5	-									

● : Stock item

E Milling Inserts







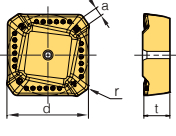
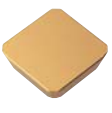
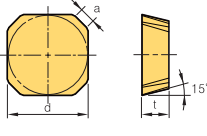

Workpiece	Machining types																						
	Steel	P	●	●	●	●	●	●	●	●	●	●	●	●	●	●	●	●	●	●	●	●	
Stainless steel	M	●																					
Cast iron	K	●																					
Non-ferrous metal	N	●																					
Heat resistant alloy, Titanium alloy	S	●																					
Hardened steel	H	●																					

Inserts	Designation	Cermets		Coated										Uncoated		Dimensions (mm)					Geometries	Available tools				
		CN2000	CN30	NCM325	NC5330	NCM535	NCM545	PC2505	PC3600	PC3700	PC6510	PC9530	PC9540	PC5300	PC5400	ST30A	H01	l	d	t			r	d ₁		
RDKT-ML	1605M0-ML																									E236 E242 E246
RDKT-MM	10T3M0-MM			●						●	●	●		●												E234~ E237 E239~ E246
	1204M0-MM			●						●	●	●		●												
	1605M0-MM									●	●	●		●												
	2006M0-MM									●	●	●		●												
RDKW	0501M0E									●																E238 E239 E244 E245
	06T1M0E									●																
	0702M0E									●																
	0803M0E									●																
REKR-MM	170400-MM																									E60
RPCT-MA	10T3M0-MA														●											E248~ E259
	1204M0-MA														●											
	1606M0-MA														●											
	2007M0-MA														●											
RPMT-MF	0803M0E-MF									●				●	●											E248~ E259
	10T3M0E-MF									●				●	●											
	1204M0E-MF									●				●	●											
	1606M0E-MF									●				●	●											
	2007M0E-MF									●				●	●											
RPET-ML	0803M0E-ML														●	●										E248~ E259
	10T3M0E-ML														●	●										
	1204M0E-ML														●	●										
	1606M0E-ML														●	●										
	2007M0E-ML														●	●										
RPMT-MM	0803M0S-MM									●	●			●	●											E248~ E259
	10T3M0S-MM									●	●	●		●	●											
	1204M0S-MM									●	●	●		●	●											
	1606M0S-MM									●	●	●		●	●											
	2007M0S-MM									●	●	●		●	●											
RPMW	0803M0E1									●	●			●	●											E248~ E259
	10T3M0E1									●	●			●	●											
	1204M0S1									●	●	●		●	●											
	1204M0S2									●	●	●		●	●											
	1606M0S1									●	●	●		●	●											
	2007M0S1									●	●	●		●	●											

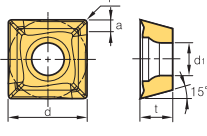
● : Stock item

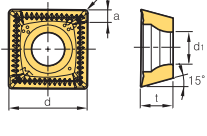

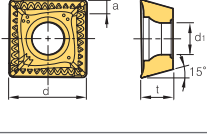
Workpiece	Machining types										
	P	M	K	N	S	H	●	●	●	●	●
Steel	●	●	●	●	●	●	●	●	●	●	●
Stainless steel	●	●	●	●	●	●	●	●	●	●	●
Cast iron	●	●	●	●	●	●	●	●	●	●	●
Non-ferrous metal	●	●	●	●	●	●	●	●	●	●	●
Heat resistant alloy, Titanium alloy	●	●	●	●	●	●	●	●	●	●	●
Hardened steel	●	●	●	●	●	●	●	●	●	●	●

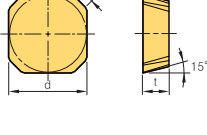
Inserts	Designation	Material											Dimensions (mm)						Geometries	Available tools					
		Cermets		Coated						Uncoated			l	d	t	r	d ₁	a							
		CN2000	CN30	NCM325	NCM335	NCM535	NCM545	PC3700	PC6510	PC9530	PC9540	PC5300	PD2000	PD1010	ST30A	G10	H01	H05							
SCKN 	220715DDSR-MM			●				●				●						-	22.0	7.0	1.5	-	2.5		E55
	280920DDSR-MM																	-	28.0	9.0	2.0	-	3.0		
SDCN 	42M														●			-	12.7	3.18	-	-	1.5		E44 E45 E56 E57
	42M-G														●			-	12.7	3.18	-	-	1.5		
	42MT	●	●												●			-	12.7	3.18	-	-	1.5		
	42MT-RH																	-	12.7	3.18	-	-	1.5		
	42MT-S20									●								-	12.7	3.18	-	-	1.5		
	53M														●			-	15.875	4.76	-	-	1.5		
	53M-G														●			-	15.875	4.76	-	-	1.5		
	53MT		●	●											●			-	15.875	4.76	-	-	1.5		
	53MT-RH																	-	15.875	4.76	-	-	1.5		
	53MT-S20									●								-	15.875	4.76	-	-	1.5		
	1203AEEN																	-	12.7	3.18	-	-	1.5		
	1203AEEN-RH																	-	12.7	3.18	-	-	1.43		
	1203AESN																	-	12.7	3.18	-	-	1.5		
	1203AESN-RH																	-	12.7	3.18	-	-	1.43		
1504AEEN																	-	15.875	4.76	-	-	1.5			
1504AEEN-RH									●		●						-	15.875	4.76	-	-	1.43			
1504AESN																	-	15.875	4.76	-	-	1.5			
1504AESN-RH									●								-	15.875	4.76	-	-	1.43			
SDET-MA 	09M402R-MA												●		●	●	-	9.525	3.923	0.2	4.0	1.2		E228~ E233	
	09M404R-MA														●	●	-	9.525	3.923	0.4	4.0	1.2			
	09M405R-MA															●	●	-	9.525	3.923	0.5	4.0			1.2
	130504R-MA												●		●	●	-	13.5	5.56	0.4	5.56	2.2			
SDET-MF 	09M405R-MF																-	9.525	4	0.5	4	1.2		E228~ E233	
	130508R-MF																-	13.5	5.56	0.8	5.56	2.2			
SDET-MM 	09M405R-MM																-	9.525	4	0.5	4	1.2		E228~ E233	
	130508R-MM																-	13.5	5.56	0.8	5.56	2.2			
SDKN-CM 	42MT-CM		●														-	12.7	3.18	-	-	1.5		-	

● : Stock item



E Milling Inserts

Workpiece	Material	Machining types												
		●	●	●	●	●	●	●	●	●	●	●	●	●
Steel	P	●	●	●	●	●	●	●	●	●	●	●	●	●
Stainless steel	M			●	●					●	●	●	●	
Cast iron	K			●	●	●				●	●	●	●	●
Non-ferrous metal	N												●	●
Heat resistant alloy, Titanium alloy	S											●	●	●
Hardened steel	H											●	●	●

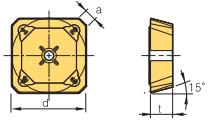
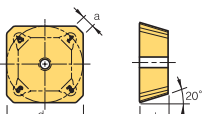
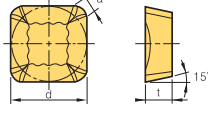
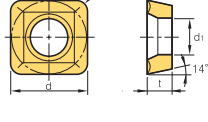
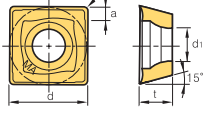
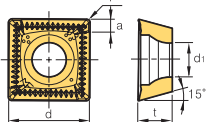
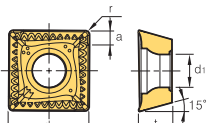
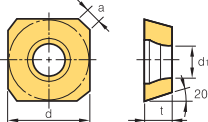
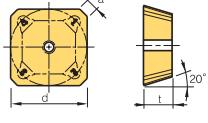
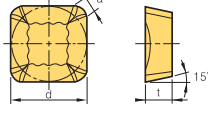
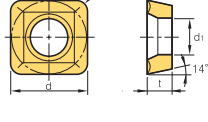
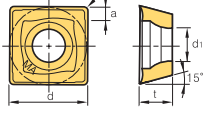
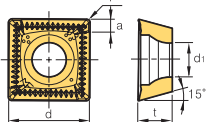
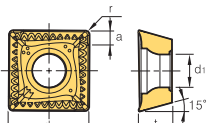
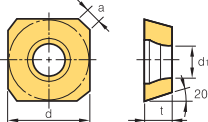
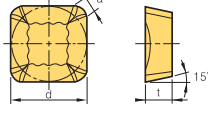
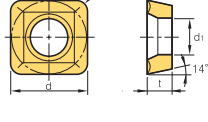
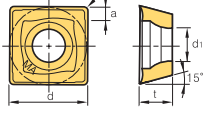
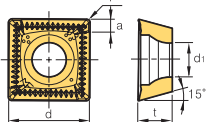
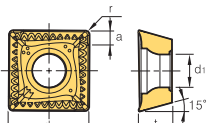
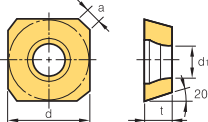
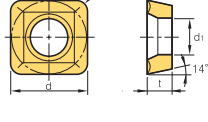
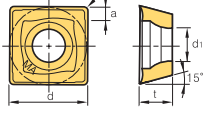
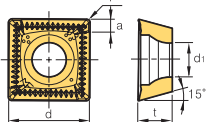
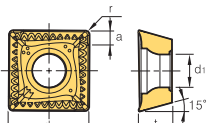
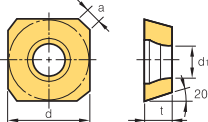
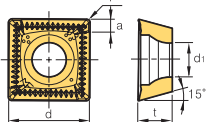
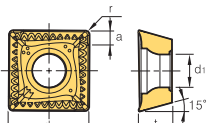
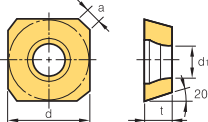
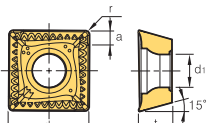
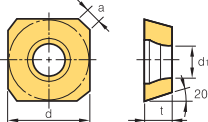
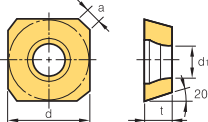
Inserts	Designation	Cermets		Coated								Uncoated		Dimensions (mm)						Geometries	Available tools																																																																																																																																																																																																																																																																																																																																																																																																																																																																																																																																																																																																																																																																																																																																															
		CN2000	CN30	NCM325	NCM335	NC5330	NCM535	NCM545	PC3600	PC3700	PC6510	PC9530	PC9540	PC5300	PC5400	ST30A	H01	H05	l			d	t	r	d ₁	a																																																																																																																																																																																																																																																																																																																																																																																																																																																																																																																																																																																																																																																																																																																																										
SDKN-MU	1203AESN-MU									●								-	12.7	3.18	-	-	2.08		E44 E45 E50 E51																																																																																																																																																																																																																																																																																																																																																																																																																																																																																																																																																																																																																																																																																																																																											
	1504AESN-MU									●								-	15.875	4.76	-	-	2.10			SDKN-SU	1203AESN-SU									●	●			●	●			-	12.7	3.18	-	-	2.08		E44 E45 E50 E51	1504AESN-SU									●	●			●	●			-	15.875	4.76	-	-	2.10	SDKR-MX	1203AESN-MX																	-	12.7	3.18	-	-	1.46		E44 E45 E50 E51	1203AETN-MX																	-	12.7	3.18	-	-	1.46	1203AEN-MX			●															-	12.7	3.18	-	-	1.46	1504AESN-MX				●														-	15.875	4.76	-	-	1.45	1504AETN-MX																		-	15.875	4.76	-	-	1.45	1504AEN-MX			●															-	15.875	4.76	-	-	1.45	SDMT-MM	090308-MM									●				●				-	9.525	3.18	0.8	4.4	-		E299 E327	SDXT-MA	09M405R-MA														●	●		-	9.525	4.0	0.5	4.0	1.2		E228~ E233	130508R-MA														●	●		-	13.5	5.56	0.8	5.56	2.2	SDXT-MF	09M403R-MF																	-	9.525	4.0	0.3	4.0	1.2		E228~ E233	09M403L-MF																	-	9.525	4.0	0.3	4.0	1.2	09M404R-MF																	-	9.525	4.0	0.4	4.0	1.2	09M404L-MF																	-	9.525	4.0	0.4	4.0	1.2	09M405R-MF			●							●	●	●	●	●	●			-	9.525	4.0	0.5	4.0	1.2	09M405L-MF										●	●	●	●	●	●			-	9.525	4.0	0.5	4.0	1.2	130508R-MF			●							●	●	●	●	●	●			-	13.5	5.56	0.8	5.56	2.2	SDXT-MM	09M405R-MM			●	●					●	●	●	●	●	●			-	9.525	4.0	0.5	4.0	1.2		E228~ E233	09M405L-MM									●	●							-	9.525	4.0	0.5	4.0	1.2	130508R-MM			●	●					●	●	●	●	●	●			-	13.5	5.56	0.8	5.56	2.2	130508L-MM									●	●	●	●	●	●			-	13.5	5.56	0.8	5.56	2.2	130538-MM										●	●	●	●	●			-	13.5	5.56	3.8	5.56	2.2	SECA	1204AFSN			●														-	12.7	4.76	-	5.56	2.66		-	1204AFTN			●						●	●							-	12.7	4.76	-	5.56	2.66	1204AFFN									●	●							-	12.7	4.76	-	5.56	2.66	1204AFEN									●	●							-	12.7	4.76	-	5.56	2.66	1504AFSN																	-	15.875	4.76	-	5.5	2.8	1504AFTN																	-	15.875	4.76	-	5.5	2.8	1504AFFN																	-	15.875	4.76
SDKN-SU	1203AESN-SU									●	●			●	●			-	12.7	3.18	-	-	2.08		E44 E45 E50 E51																																																																																																																																																																																																																																																																																																																																																																																																																																																																																																																																																																																																																																																																																																																																											
	1504AESN-SU									●	●			●	●			-	15.875	4.76	-	-	2.10			SDKR-MX	1203AESN-MX																	-	12.7	3.18	-	-	1.46		E44 E45 E50 E51	1203AETN-MX																	-	12.7	3.18	-	-	1.46		1203AEN-MX			●															-	12.7	3.18	-	-			1.46	1504AESN-MX				●														-	15.875	4.76	-	-	1.45	1504AETN-MX																		-	15.875	4.76	-	-	1.45	1504AEN-MX			●															-	15.875	4.76	-	-	1.45	SDMT-MM	090308-MM									●				●				-	9.525	3.18	0.8	4.4	-		E299 E327	SDXT-MA	09M405R-MA														●	●		-	9.525	4.0	0.5	4.0	1.2		E228~ E233	130508R-MA														●	●		-	13.5	5.56	0.8	5.56	2.2	SDXT-MF	09M403R-MF																	-	9.525	4.0	0.3	4.0	1.2		E228~ E233	09M403L-MF																	-	9.525	4.0		0.3	4.0	1.2	09M404R-MF																	-	9.525	4.0			0.4	4.0	1.2	09M404L-MF																	-	9.525	4.0	0.4	4.0	1.2	09M405R-MF			●							●	●	●	●	●	●			-	9.525	4.0	0.5	4.0	1.2	09M405L-MF										●	●	●	●	●	●			-	9.525	4.0	0.5	4.0	1.2	130508R-MF			●							●	●	●	●	●	●			-	13.5	5.56	0.8	5.56	2.2	SDXT-MM	09M405R-MM			●	●					●	●	●	●	●	●			-	9.525	4.0	0.5	4.0	1.2		E228~ E233	09M405L-MM									●	●								-	9.525	4.0	0.5	4.0	1.2	130508R-MM			●	●					●	●	●	●	●	●					-	13.5	5.56	0.8	5.56	2.2	130508L-MM									●	●	●	●	●	●			-	13.5	5.56	0.8	5.56	2.2	130538-MM										●	●	●	●	●			-	13.5	5.56	3.8	5.56	2.2	SECA	1204AFSN			●														-	12.7	4.76	-	5.56	2.66		-	1204AFTN			●						●	●								-	12.7	4.76	-	5.56	2.66	1204AFFN									●	●									-	12.7	4.76	-	5.56	2.66	1204AFEN									●	●							-	12.7	4.76	-	5.56	2.66	1504AFSN																	-	15.875	4.76	-	5.5	2.8	1504AFTN																	-	15.875	4.76	-	5.5	2.8	1504AFFN																	-	15.875	4.76	-	5.5	2.8																																		
SDKR-MX	1203AESN-MX																	-	12.7	3.18	-	-	1.46		E44 E45 E50 E51																																																																																																																																																																																																																																																																																																																																																																																																																																																																																																																																																																																																																																																																																																																																											
	1203AETN-MX																	-	12.7	3.18	-	-	1.46																																																																																																																																																																																																																																																																																																																																																																																																																																																																																																																																																																																																																																																																																																																																													
	1203AEN-MX			●															-	12.7	3.18	-	-				1.46																																																																																																																																																																																																																																																																																																																																																																																																																																																																																																																																																																																																																																																																																																																																									
	1504AESN-MX				●														-	15.875	4.76	-	-				1.45																																																																																																																																																																																																																																																																																																																																																																																																																																																																																																																																																																																																																																																																																																																																									
	1504AETN-MX																		-	15.875	4.76	-	-				1.45																																																																																																																																																																																																																																																																																																																																																																																																																																																																																																																																																																																																																																																																																																																																									
	1504AEN-MX			●															-	15.875	4.76	-	-			1.45	SDMT-MM	090308-MM									●				●				-	9.525	3.18	0.8	4.4	-		E299 E327	SDXT-MA	09M405R-MA														●	●		-	9.525	4.0	0.5	4.0	1.2		E228~ E233	130508R-MA														●	●		-	13.5	5.56	0.8	5.56	2.2	SDXT-MF	09M403R-MF																	-	9.525	4.0	0.3	4.0	1.2		E228~ E233	09M403L-MF																	-	9.525	4.0	0.3	4.0	1.2	09M404R-MF																	-	9.525	4.0	0.4	4.0	1.2	09M404L-MF																	-	9.525	4.0	0.4	4.0	1.2	09M405R-MF			●							●	●	●	●	●	●			-	9.525	4.0	0.5	4.0	1.2	09M405L-MF										●	●	●	●	●	●			-	9.525	4.0	0.5	4.0	1.2	130508R-MF			●								●	●	●	●	●	●			-	13.5	5.56	0.8	5.56	2.2	SDXT-MM	09M405R-MM					●	●					●	●	●	●	●	●			-	9.525	4.0	0.5	4.0	1.2		E228~ E233	09M405L-MM									●	●							-	9.525	4.0	0.5	4.0	1.2	130508R-MM			●	●					●	●	●	●	●	●			-	13.5	5.56	0.8	5.56	2.2	130508L-MM									●	●	●	●	●	●			-	13.5	5.56	0.8	5.56	2.2	130538-MM										●	●	●	●	●			-	13.5	5.56	3.8	5.56	2.2	SECA	1204AFSN			●														-	12.7	4.76	-	5.56	2.66		-	1204AFTN			●						●	●							-	12.7	4.76	-	5.56	2.66	1204AFFN									●	●							-	12.7	4.76	-	5.56	2.66	1204AFEN									●	●							-	12.7	4.76	-	5.56	2.66	1504AFSN																	-	15.875	4.76	-	5.5	2.8	1504AFTN																	-	15.875	4.76	-	5.5	2.8	1504AFFN																	-	15.875	4.76	-	5.5	2.8																																																																																																																																																																																											
SDMT-MM	090308-MM									●				●				-	9.525	3.18	0.8	4.4	-		E299 E327																																																																																																																																																																																																																																																																																																																																																																																																																																																																																																																																																																																																																																																																																																																																											
SDXT-MA	09M405R-MA														●	●		-	9.525	4.0	0.5	4.0	1.2		E228~ E233																																																																																																																																																																																																																																																																																																																																																																																																																																																																																																																																																																																																																																																																																																																																											
	130508R-MA														●	●		-	13.5	5.56	0.8	5.56	2.2			SDXT-MF	09M403R-MF																	-	9.525	4.0	0.3	4.0	1.2		E228~ E233	09M403L-MF																	-	9.525	4.0	0.3	4.0	1.2	09M404R-MF																	-	9.525	4.0	0.4	4.0	1.2	09M404L-MF																		-	9.525	4.0	0.4	4.0	1.2	09M405R-MF			●									●	●	●	●	●	●			-	9.525	4.0	0.5	4.0	1.2	09M405L-MF										●	●	●	●	●	●			-	9.525	4.0	0.5	4.0	1.2	130508R-MF			●							●	●	●	●	●	●			-	13.5	5.56	0.8	5.56	2.2	SDXT-MM	09M405R-MM			●	●					●	●	●	●	●	●			-	9.525	4.0	0.5	4.0	1.2		E228~ E233	09M405L-MM									●	●							-	9.525	4.0	0.5	4.0	1.2	130508R-MM			●	●					●	●	●	●	●	●			-	13.5	5.56	0.8	5.56	2.2	130508L-MM										●	●	●	●	●	●			-	13.5	5.56	0.8	5.56	2.2	130538-MM												●	●	●	●	●			-	13.5	5.56	3.8	5.56	2.2	SECA	1204AFSN			●														-	12.7	4.76	-	5.56	2.66		-	1204AFTN			●						●	●							-	12.7	4.76	-	5.56	2.66	1204AFFN									●	●							-	12.7	4.76	-	5.56	2.66	1204AFEN										●	●							-	12.7	4.76	-	5.56	2.66	1504AFSN																			-	15.875	4.76	-	5.5	2.8	1504AFTN																	-	15.875	4.76	-	5.5	2.8	1504AFFN																	-	15.875	4.76	-	5.5	2.8																																																																																																																																																																																																																																																																	
SDXT-MF	09M403R-MF																	-	9.525	4.0	0.3	4.0	1.2		E228~ E233																																																																																																																																																																																																																																																																																																																																																																																																																																																																																																																																																																																																																																																																																																																																											
	09M403L-MF																	-	9.525	4.0	0.3	4.0	1.2																																																																																																																																																																																																																																																																																																																																																																																																																																																																																																																																																																																																																																																																																																																																													
	09M404R-MF																	-	9.525	4.0	0.4	4.0	1.2																																																																																																																																																																																																																																																																																																																																																																																																																																																																																																																																																																																																																																																																																																																																													
	09M404L-MF																	-	9.525	4.0	0.4	4.0	1.2																																																																																																																																																																																																																																																																																																																																																																																																																																																																																																																																																																																																																																																																																																																																													
	09M405R-MF			●							●	●	●	●	●	●			-	9.525	4.0	0.5	4.0				1.2																																																																																																																																																																																																																																																																																																																																																																																																																																																																																																																																																																																																																																																																																																																																									
	09M405L-MF										●	●	●	●	●	●			-	9.525	4.0	0.5	4.0				1.2																																																																																																																																																																																																																																																																																																																																																																																																																																																																																																																																																																																																																																																																																																																																									
	130508R-MF			●							●	●	●	●	●	●			-	13.5	5.56	0.8	5.56			2.2	SDXT-MM	09M405R-MM			●	●					●	●	●	●	●	●			-	9.525	4.0	0.5	4.0	1.2		E228~ E233	09M405L-MM									●	●							-	9.525	4.0	0.5	4.0	1.2	130508R-MM			●	●					●	●	●	●	●	●			-	13.5	5.56	0.8	5.56	2.2	130508L-MM									●	●	●	●	●	●			-	13.5	5.56	0.8	5.56	2.2	130538-MM										●	●	●	●	●			-	13.5	5.56	3.8	5.56	2.2	SECA	1204AFSN			●														-	12.7	4.76	-	5.56	2.66		-	1204AFTN			●						●	●							-	12.7	4.76	-	5.56	2.66	1204AFFN									●	●							-	12.7	4.76	-	5.56	2.66	1204AFEN									●	●							-	12.7	4.76	-	5.56	2.66	1504AFSN																	-	15.875	4.76	-	5.5	2.8	1504AFTN																	-	15.875	4.76	-	5.5	2.8	1504AFFN																	-	15.875	4.76	-	5.5	2.8																																																																																																																																																																																																																																																																																																																																																																																																																																																
SDXT-MM	09M405R-MM			●	●					●	●	●	●	●	●			-	9.525	4.0	0.5	4.0	1.2		E228~ E233																																																																																																																																																																																																																																																																																																																																																																																																																																																																																																																																																																																																																																																																																																																																											
	09M405L-MM									●	●							-	9.525	4.0	0.5	4.0	1.2																																																																																																																																																																																																																																																																																																																																																																																																																																																																																																																																																																																																																																																																																																																																													
	130508R-MM			●	●					●	●	●	●	●	●			-	13.5	5.56	0.8	5.56	2.2																																																																																																																																																																																																																																																																																																																																																																																																																																																																																																																																																																																																																																																																																																																																													
	130508L-MM									●	●	●	●	●	●			-	13.5	5.56	0.8	5.56	2.2																																																																																																																																																																																																																																																																																																																																																																																																																																																																																																																																																																																																																																																																																																																																													
	130538-MM										●	●	●	●	●			-	13.5	5.56	3.8	5.56	2.2			SECA	1204AFSN			●														-	12.7	4.76	-	5.56	2.66		-	1204AFTN			●						●	●							-	12.7	4.76	-	5.56	2.66	1204AFFN									●	●							-	12.7	4.76	-	5.56	2.66	1204AFEN									●	●							-	12.7	4.76	-	5.56	2.66	1504AFSN																	-	15.875	4.76	-	5.5	2.8	1504AFTN																		-	15.875	4.76	-	5.5	2.8	1504AFFN																			-	15.875	4.76	-	5.5	2.8																																																																																																																																																																																																																																																																																																																																																																																																																																																																																																																																																																				
SECA	1204AFSN			●														-	12.7	4.76	-	5.56	2.66		-																																																																																																																																																																																																																																																																																																																																																																																																																																																																																																																																																																																																																																																																																																																																											
	1204AFTN			●						●	●							-	12.7	4.76	-	5.56	2.66																																																																																																																																																																																																																																																																																																																																																																																																																																																																																																																																																																																																																																																																																																																																													
	1204AFFN									●	●							-	12.7	4.76	-	5.56	2.66																																																																																																																																																																																																																																																																																																																																																																																																																																																																																																																																																																																																																																																																																																																																													
	1204AFEN									●	●							-	12.7	4.76	-	5.56	2.66																																																																																																																																																																																																																																																																																																																																																																																																																																																																																																																																																																																																																																																																																																																																													
	1504AFSN																	-	15.875	4.76	-	5.5	2.8																																																																																																																																																																																																																																																																																																																																																																																																																																																																																																																																																																																																																																																																																																																																													
	1504AFTN																	-	15.875	4.76	-	5.5	2.8																																																																																																																																																																																																																																																																																																																																																																																																																																																																																																																																																																																																																																																																																																																																													
1504AFFN																	-	15.875	4.76	-	5.5	2.8																																																																																																																																																																																																																																																																																																																																																																																																																																																																																																																																																																																																																																																																																																																																														









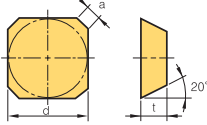

● : Stock item

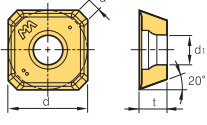

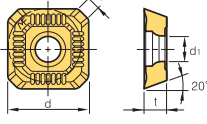
Workpiece	Steel	P	●	●	●	●	●	●	●	●	●	●	●
	Stainless steel	M	●	●	●	●	●	●	●	●	●	●	●
	Cast iron	K	●	●	●	●	●	●	●	●	●	●	●
	Non-ferrous metal	N								●	●	●	●
	Heat resistant alloy, Titanium alloy	S								●	●	●	●
	Hardened steel	H								●	●	●	●

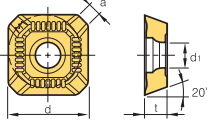
Machining types

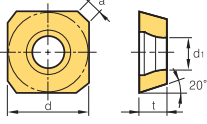
- Continuous cutting
- General cutting
- ✳ Interrupted cutting

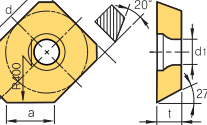
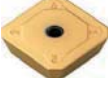
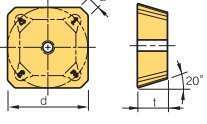
Inserts	Designation	Cermets		Coated							Uncoated			Dimensions (mm)						Geometries	Available tools				
		CN2000	CN30	NCM325	NCM335	PC3600	PC3700	PC6510	PC9530	PC9540	PC5300	PC5400	PD2000	PD1010	ST30A	G10	H01	H05	l			d	t	r	d ₁
SECN 	1203AFFN													●	●		-	12.7	3.18	-	-	-	2.36	 ● Shape of Edge - S20: STS - RH: Strengthened edge, STS	E46
	1203AFTN	●	●														-	12.7	3.18	-	-	-	2.36		E47
	1203AFEN																-	12.7	3.18	-	-	-	2.36		
	1203AFSN			●	●												-	12.7	3.18	-	-	-	2.36		
	1203AFEN-RH							●			●						-	12.7	3.18	-	-	-	2.36		
	1203AFSN-RH																-	12.7	3.18	-	-	-	2.36		
	1203AFTN-S20								●								-	12.7	3.18	-	-	-	2.36		
	1504AFFN															●	-	15.875	4.76	-	-	-	2.4		
	1504AFTN		●														-	15.875	4.76	-	-	-	2.4		
	1504AFEN																-	15.875	4.76	-	-	-	2.4		
	1504AFSN																-	15.875	4.76	-	-	-	2.4		
	1504AFEN-RH																-	15.875	4.76	-	-	-	2.4		
	1504AFSN-RH								●								-	15.875	4.76	-	-	-	2.4		
	1504AFTN-S20																-	15.875	4.76	-	-	-	2.4		
	SEET-MA 	0903AGFN-MA														●	●	-	9.525	3.18	-	3.4	2.11		 E222~ E227
14M4AGFN-MA														●	●		-	14.0	4.0	-	4.4	2.64			
SEET-MF 	0903AGSN-MF						●	●		●	●					-	9.525	3.18	-	3.4	2.11	 E222~ E227			
	14M4AGSN-MF						●	●		●	●					-	14.0	4.0	-	4.4	2.64				
SEET-MM 	0903AGSN-MM			●						●	●					-	9.525	3.18	-	3.4	2.11	 E222~ E227			
	14M4AGSN-MM			●		●	●	●		●	●					-	14.0	4.0	-	4.4	2.64				
SEEW 	0903AGTN															-	9.525	3.18	-	3.4	2.11	 E222~ E227			
	14M4AGTN															-	14.0	4.0	-	4.4	2.64				
SEEW-W 	14M4AGFN-W															-	14.0	4.0	-	4.4	8.5	 E223 E225 E227			
	14M4AGSN-W														●	-	14.0	4.0	-	4.4	8.5				
	14M4AGTN-W						●	●								-	14.0	4.0	-	4.4	8.5				
SEKN-SU 	1203AFSN-SU					●	●									-	12.7	3.18	-	1.98	-	 E46 E47			
	1504AFSN-SU					●	●			●						-	15.875	4.76	-	2.04	-				

● : Stock item



E Milling Inserts

Workpiece	Machining types										
	Steel	P	M	K	N	S	H	●	●	●	●
Steel	●	●	●	●	●	●	●	●	●	●	●
Stainless steel	●	●	●	●	●	●	●	●	●	●	●
Cast iron	●	●	●	●	●	●	●	●	●	●	●
Non-ferrous metal	●	●	●	●	●	●	●	●	●	●	●
Heat resistant alloy, Titanium alloy	●	●	●	●	●	●	●	●	●	●	●
Hardened steel	●	●	●	●	●	●	●	●	●	●	●

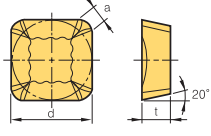
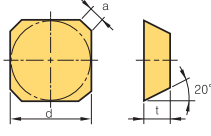
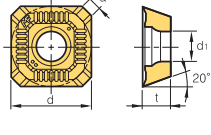
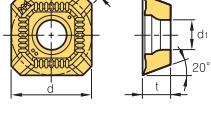
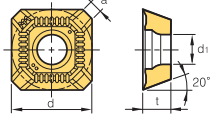
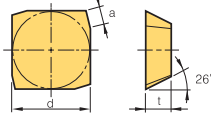
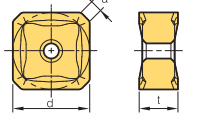
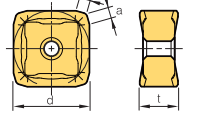
Inserts	Designation	Cermets		Coated										Uncoated		Dimensions (mm)					Geometries	Available tools		
		CN2000	CN30	NCM325	NCM335	NCM535	NCM545	PC2505	PC2010	PC3600	PC3700	PC6510	PC9530	PC9540	PC5300	PC5400	ST30A	H01	l	d			t	d ₁
SEKR-MX	1203AFSN-MX	●	●	●	●	●	●	●	●	●	●	●	●	●	●	●	●	-	12.7	3.18	-	2.3		E46 E47
	1504AFSN-MX	●	●	●	●	●	●	●	●	●	●	●	●	●	●	●	●	-	15.875	4.76	-	2.4		
SEMN	1204AZ	●	●	●	●	●	●	●	●	●	●	●	●	●	●	●	●	-	12.7	4.76	-	2.0		-
SEXT-MF	0903AGSN-MF	●	●	●	●	●	●	●	●	●	●	●	●	●	●	●	●	-	9.525	3.18	3.4	2.11		E222~ E227
	14M4AGSN-MF	●	●	●	●	●	●	●	●	●	●	●	●	●	●	●	●	-	14.0	4.0	4.4	2.64		
SEXT-MM	0903AGSN-MM	●	●	●	●	●	●	●	●	●	●	●	●	●	●	●	●	-	9.525	3.18	3.4	2.11		E222~ E227
	14M4AGSN-MM	●	●	●	●	●	●	●	●	●	●	●	●	●	●	●	●	-	14.0	4.0	4.4	2.64		
SEXT-MR	0903AGSN-MR	●	●	●	●	●	●	●	●	●	●	●	●	●	●	●	●	-	9.525	3.18	3.4	2.11		E222~ E227
	14M4AGSN-MR	●	●	●	●	●	●	●	●	●	●	●	●	●	●	●	●	-	14.0	4.0	4.4	2.64		
SFCN	1203EFR	●	●	●	●	●	●	●	●	●	●	●	●	●	●	●	●	-	12.7	3.18	-	2.5		E48
SNC(M)F-MF	SNCF 1206ANN-MF	●	●	●	●	●	●	●	●	●	●	●	●	●	●	●	●	-	12.7	6.6	-	2		E125 E126
	1507ANN-MF	●	●	●	●	●	●	●	●	●	●	●	●	●	●	●	●	-	15.875	7.35	-	2.1		
	SNMF 1206ANN-MF	●	●	●	●	●	●	●	●	●	●	●	●	●	●	●	●	-	12.7	6.6	-	2		
	1507ANN-MF	●	●	●	●	●	●	●	●	●	●	●	●	●	●	●	●	-	15.875	7.35	-	2.1		
SNC(M)F-MF	SNCF 1206ENN-MF	●	●	●	●	●	●	●	●	●	●	●	●	●	●	●	●	-	12.7	6.6	-	1.8		E127 E128
	1507ENN-MF	●	●	●	●	●	●	●	●	●	●	●	●	●	●	●	●	-	15.875	7.35	-	1.8		
	SNMF 1206ENN-MF	●	●	●	●	●	●	●	●	●	●	●	●	●	●	●	●	-	12.7	6.6	-	1.8		
	1507ENN-MF	●	●	●	●	●	●	●	●	●	●	●	●	●	●	●	●	-	15.875	7.35	-	1.8		

● : Stock item



Workpiece	Steel	P											Machining types				
	Stainless steel	M	●	●	●	●	●	●	●	●	●	●	●	●	●	●	●
Cast iron	K		●	●	●	●	●	●	●	●	●	●	●	●	●	●	●
Non-ferrous metal	N																
Heat resistant alloy, Titanium alloy	S																
Hardened steel	H																

● Continuous cutting
 ● General cutting
 ✳ Interrupted cutting



Inserts	Designation	Cermet		Coated								Uncoated		Dimensions (mm)							Geometries	Available tools					
		CN2000	CN30	NCM325	NC5330	NCM535	NCM545	PC2505	PC2010	PC3600	PC3700	PC6510	PC9530	PC9540	PC5300	PC5400	ST30A	H01	l	d			t	r	d ₁	a	b
SNC(M)F-MF	SNCF 1206QNN-MF										●							-	12.7	6.6	0.8	-	1	-			E127
	SNMF 1206QNN-MF										●							-	12.7	6.6	0.8	-	1	-			
SNC(M)F-MM	SNCF 1206ANN-MM																	-	12.7	6.6	-	-	2	-			E125 E126
	1507ANN-MM																	-	15.875	7.35	-	-	2.1	-			
	SNMF 1206ANN-MM																	-	12.7	6.6	-	-	2	-			
	1507ANN-MM																	-	15.875	7.35	-	-	2.1	-			
SNC(M)F-MM	SNCF 1206ENN-MM																	-	12.7	6.6	-	-	1.8	-			E127 E128
	1507ENN-MM																	-	15.875	7.35	-	-	1.8	-			
	SNMF 1206ENN-MM										●							-	12.7	6.6	-	-	1.8	-			
	1507ENN-MM																	-	15.875	7.35	-	-	1.8	-			
SNC(M)F-MM	SNCF 1206QNN-MM										●							-	12.7	6.6	0.8	-	1	-			E129
	SNMF 1206QNN-MM										●							-	12.7	6.6	0.8	-	1	-			
SNCN	1204ENN			●													●	-	12.7	4.76	-	-	1.4	1.0			E49
	1504ENN																	-	15.875	4.76	-	-	1.4	1.0			
SNEF	435										●							-	12.7	4.76	2.0	-	-	-			E395
	535																	-	15.875	4.76	2.0	-	-	-			
SNEU-MF	120420-MF										●							-	12.7	4.76	2.0	5.7	(2.3)	-			E397
SNEU-MF	1204ANN-MF																	-	12.7	4.76	-	5.7	(2.0)	-			E397

● : Stock item

E Milling Inserts

Workpiece	Steel	P	●	●	●	●	●	●	●	●	●	●	●	●	●	●	●	●	●	●	Machining types		
	Stainless steel	M	●	●	●	●	●	●	●	●	●	●	●	●	●	●	●	●	●	●			●
	Cast iron	K	●	●	●	●	●	●	●	●	●	●	●	●	●	●	●	●	●	●			●
	Non-ferrous metal	N	●	●	●	●	●	●	●	●	●	●	●	●	●	●	●	●	●	●			●
	Heat resistant alloy, Titanium alloy	S	●	●	●	●	●	●	●	●	●	●	●	●	●	●	●	●	●	●			●
Hardened steel	H	●	●	●	●	●	●	●	●	●	●	●	●	●	●	●	●	●	●	●	●		

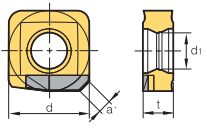
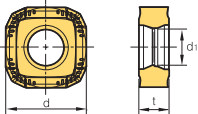
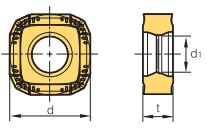
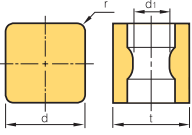
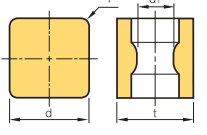
● Continuous cutting
 ● General cutting
 ✖ Interrupted cutting

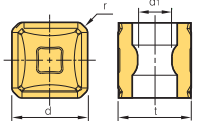
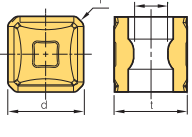
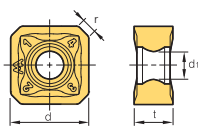
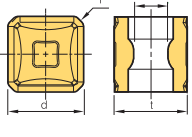
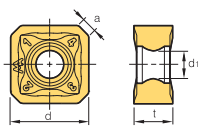
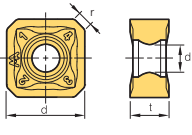
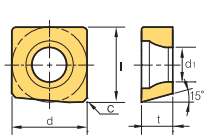
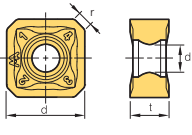
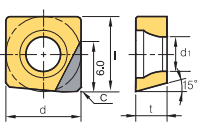
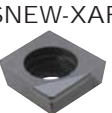
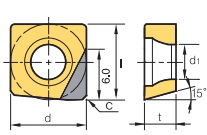
Inserts	Designation	Cermets		Coated										PCD		Dimensions (mm)						Geometries	Available tools				
		CN2000	CN30	NC5330	NCM535	NCM545	PC2505	PC2010	PC3600	PC3700	PC6510	PC9530	PC9540	PC5300	PC5400	H01	DP150	DP200	l	d	t			r	d _i	a	
	1204-TBW	●																	-	12.7	4.76	-	5.7	(2.1)		E397	
	1204R-WMF	●																	-	12.7	4.76	-	5.7	-		E397	
	101010	●								●									-	10	10	1.0	4.6	-		-	
	1010ZNN	●																	-	10	10	(1.0)	4.6	-			
	101010-CU1	●								●									-	10	10	1.0	4.6	-		-	
	1010ZNN-CU1	●																	-	10	10	(1.0)	4.6	-			
	121212-CU1	●																	-	12.7	12.7	1.2	5.6	-			
	1212ZNN-CU1	●																	-	12.7	12.7	(1.2)	5.6	-			
	1206ANN-MA	●															●		-	12.7	6.35	-	4.5	2.36		E115~	
	1206ENN-MA	●															●		-	12.7	6.35	-	5.2	1.82			
	1206QNN-MA	●															●		-	12.7	6.35	-	5.2	1.39			
	120612-MA	●															●		-	12.7	6.35	1.2	5.2	-			
	1206ANN-ML	●															●	●	-	12.7	6.35	-	4.5	2.36		E115~	
	1206ENN-ML	●															●	●	-	12.7	6.35	-	4.5	1.82			
	1206QNN-ML	●															●	●	-	12.7	6.35	-	4.5	1.39			
	120612-ML	●															●	●	-	12.7	6.35	1.2	4.5	-			
	1507ANN-ML	●															●	●	-	15.875	7.94	-	5.6	3.16			
	1507ENN-ML	●															●	●	-	15.875	7.94	-	5.6	2.66			
	09T3ADFR	●																●	9.525	9.525	3.97	-	4.4	-		E139 E140	
	09T3ADTR-NAF	●																●	9.525	9.525	3.97	-	4.4	-		E139	
	09T3ADTR-AW NAW: Wiper insert	●																●	9.525	9.525	3.97	-	4.4	-			
	09T3ADTR-XAF	●																●	9.525	9.525	3.97	-	4.4	-		E139	
	09T3ADTR-AW XAW: Wiper insert	●																●	9.525	9.525	3.97	-	4.4	-			

● : Stock item



E Milling Inserts

Workpiece	Steel	P	●	●	●	●	●	●	●	●	●	●	●	●	●	●	●	Machining types ● Continuous cutting ● General cutting ✳ Interrupted cutting
	Stainless steel	M	●	●	●	●	●	●	●	●	●	●	●	●	●	●	●	
	Cast iron	K	●	●	●	●	●	●	●	●	●	●	●	●	●	●	●	
	Non-ferrous metal	N	●	●	●	●	●	●	●	●	●	●	●	●	●	●	●	
	Heat resistant alloy, Titanium alloy	S	●	●	●	●	●	●	●	●	●	●	●	●	●	●	●	
Hardened steel	H	●	●	●	●	●	●	●	●	●	●	●	●	●	●	●		







Inserts	Designation	Cermets		Coated								Uncoated			Dimensions (mm)							Geometries	Available tools					
		CN2000	CN30	NCM325	NCM335	NCM535	NCM545	PC3600	PC3700	PC6510	PC9530	PC9540	PC5300	PC5400	ST30A	G10	H01	l	d	t	r			d ₁	a	b		
SNM(E)X-MM 	SNMX 1206ENN-MM					●	●	●	●	●	●	●	●	●			-	12.7	6.35	-	5.2	1.82	-				E119~ E122	
	1507ENN-MM					●	●	●	●	●	●	●	●	●			-	15.875	7.94	-	5.6	2.66	-					
	SNEX 1206ENN-MM																-	12.7	6.35	-	5.2	1.82	-					
	1507ENN-MM																-	15.875	7.94	-	5.6	2.66	-					
SNM(E)X-MM 	SNMX 1206QNN-MM					●	●	●	●	●	●	●	●	●			-	12.7	6.35	-	4.5	2.36	-				E123 E124	
	120612-MM																-	12.7	6.35	1.2	4.5	-	-					
	SNEX 1206QNN-MM																-	12.7	6.35	-	4.5	2.36	-					
	120612-MM																-	12.7	6.35	1.2	4.5	-	-					
SNEX-W 	1206ANN-W																-	12.7	6.35	-	4.5	7.6	-				E115 E116	
SPCN 	1203EDR	●	●	●										●	●	●	-	12.7	3.18	-	-	1.4	1.0				E50 E51	
	1203EDR-RH																-	12.7	3.18	-	-	1.4	1.0					
	1203EDL														●		-	12.7	3.18	-	-	1.4	1.0					
	1203EDR-G															●	-	12.7	3.18	-	-	1.4	1.0					
	1203EDR-RN																-	12.7	3.18	-	-	1.4	1.0					
	1203EDER-RH																	-	12.7	3.18	-	-	1.63	0.8				
	1203EDSR-RH																	-	12.7	3.18	-	-	1.63	0.8				
	1203EDTR-RH																	-	12.7	3.18	-	-	1.63	0.8				
	1203EDR-S20																	-	12.7	3.18	-	-	1.4	1.0				
	150412T																	-	15.875	4.76	1.2	-	-	-				
	1504EDR	●	●												●	●	-	15.875	4.76	-	-	1.4	1.0					
	1504EDR-RH																	-	15.875	4.76	-	-	1.4	1.0				
	1504EDSR																	-	15.875	4.76	-	-	1.4	1.0				
	1504EDL																	-	15.875	4.76	-	-	1.4	1.0				
	1504EDR-G																	-	15.875	4.76	-	-	1.4	1.0				
	1504EDR-RN	●																-	15.875	4.76	-	-	1.4	1.0				
	1504EDER-RH																	-	15.875	4.76	-	-	1.64	0.8				
	1504EDSR-RH																	-	15.875	4.76	-	-	1.64	0.8				
	1504EDTR-RH																	-	15.875	4.76	-	-	1.64	0.8				
1504EDR-S20																	-	15.875	4.76	-	-	1.4	1.0					
SPEN-WC 	120416-WC																-	12.7	4.76	1.6	-	-	-				E396	
	150412-WC																-	15.875	4.76	1.2	-	-	-					
	150416-WC																-	15.875	4.76	1.6	-	-	-					
	150420-WC																-	15.875	4.76	2.0	-	-	-					
	190424-WC																	-	19.05	4.76	2.4	-	-	-				
SPEX 	1203EDR-1																-	12.7	3.18	-	-	10.2	-				E50 E51	
	1203EDL-1																-	12.7	3.18	-	-	10.2	-					
	1504EDR-1																-	15.875	4.76	-	-	10.2	-					
	1504EDL-1																-	15.875	4.76	-	-	10.2	-					

● : Stock item

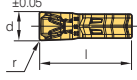
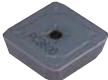
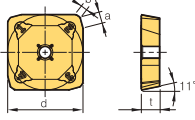
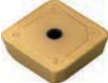
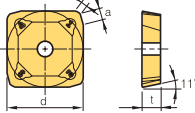

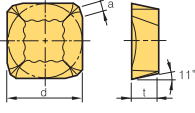
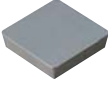
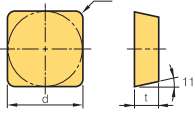
Workpiece	Steel	P											Machining types			
	Stainless steel	M														
Cast iron	K															
Non-ferrous metal	N															
Heat resistant alloy, Titanium alloy	S															
Hardened steel	H															

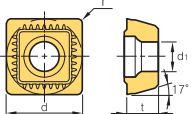
● Continuous cutting
 ● General cutting
 ✦ Interrupted cutting

Inserts	Designation	Cermet		Coated										Uncoated		Dimensions (mm)							Geometries	Available tools		
		CN2000	CN30	NCM325	NCM335	NC5330	NCM535	NCM545	PC3600	PC3700	PC6510	PC9530	PC9540	PC5300	PC5400	ST30A	G10	l	d	t	r	d ₁			a	b
SPFN 	200-N																8.8	2.2	-	0.2	-	-	-			E381
	300-N																9.8	3.0	-	0.2	-	-	-			
	400-N																9.8	4.0	-	0.25	-	-	-			
SPKN-MU 	1203EDSR-MU																-	12.7	3.18	-	-	0.86	1.87		E50 E51	
	1504EDSR-MU																-	15.875	4.76	-	-	0.84	1.92			
SPKN-SU 	1203EDSR-SU																-	12.7	3.18	-	-	1.66	0.92		E50 E51	
	1203EDSL-SU																-	12.7	3.18	-	-	1.66	0.92			
	1504EDSR-SU																-	15.875	4.76	-	-	1.62	0.93			
	1504EDSL-SU																-	15.875	4.76	-	-	1.62	0.93			
SPKR-MX 	1203EDSR-MX																-	12.7	3.18	-	-	1.4	-		E50 E51	
	1203EDSL-MX																-	12.7	3.18	-	-	1.4	-			
	1504EDR-MX																-	15.875	4.76	-	-	1.45	-			
	1504EDSR-MX																-	15.875	4.76	-	-	1.45	-			
SPMN 	120308																-	12.7	3.18	0.8	-	-	-		E338	
SPMT 	060304																-	6.35	3.18	0.4	2.8	-	-			
SPMT-KC 	110408-KC																-	11.5	4.8	0.8	4.5	-	-		E338	
	SPMT-MM 	120408-MM															-	12.7	4.76	0.8	5.6	-	-			
	120508-MMN																-	12.7	5.56	0.8	5.6	-	-			

● : Stock item

Workpiece	Steel	P											Machining types		
	Stainless steel	M													
Cast iron	K														
Non-ferrous metal	N														
Heat resistant alloy, Titanium alloy	S														
Hardened steel	H														









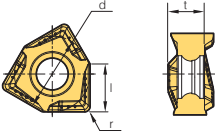

● Continuous cutting
 ● General cutting
 ✦ Interrupted cutting

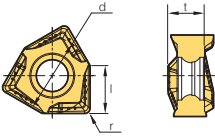
Inserts	Designation	Cemet		Coated										Dimensions (mm)								Geometries	Available tools				
		CN2000	CN30	NCM325	NCM335	NCM535	NCM545	PC2505	PC2510	PC3600	PC3700	PC6510	PC9530	PC9540	PC5300	PC5400	HO1	l	d	t	r			d ₁	a	b	f
TPKN-MU	2204PDSR-MU																	22.0	12.7	4.76	0.8	-	1.96	-		E53	
TPKN-SU	1603PDSL-SU																	16.5	9.525	3.18	1.0	-	1.70	-		E53	
	1603PDSR-SU																	16.5	9.525	3.18	1.0	-	1.70	-			
	2204PDSL-SU																	22.0	12.7	4.76	1.0	-	1.91	-			
	2204PDSR-SU																	22.0	12.7	4.76	1.0	-	1.91	-			
TPKR-MX	1603PDSN-MX																	16.5	9.525	3.18	-	-	1.2	1.2		E53	
	1603PDSR-MX																	16.5	9.525	3.18	-	-	1.2	0.7			
	1603PPR-MX																	16.5	9.525	3.18	-	-	1.2	1.0			
	1603PPSN-MX																	16.5	9.525	3.18	-	-	1.2	1.2			
	1603PPSR-MX																	16.5	9.525	3.18	-	-	1.2	1.0			
	2204PDR-MX																	22.0	12.7	4.76	1.0	-	1.4	-			
	2204PDSL-MX																	22.0	12.7	4.76	1.0	-	1.4	-			
	2204PPR-MX																	22.0	12.7	4.76	1.0	-	1.4	-			
TWX-KC	16R-KC																	16.5	9.52	3.97	0.8	4.45	-	-		E340	
	22R-KC																	22.0	12.7	4.76	0.8	4.45	-	-			
VCKT-MA	220530N-MA																	15.6	12.7	5.56	3.0	5.6	-	-		E354 E355	
VDKT-MA	11T210N-MA																	8.8	6.35	2.87	1.0	2.8	-	-		E356	
	11T220N-MA																	6.7	6.35	2.87	2.0	2.8	-	-			
WDKT-MH	080316ZDSR-MH																	-	8.0	3.18	1.6	3.3	-	-	1.8		E292~ E298
	10T320ZDSR-MH																	-	10.0	3.97	2.0	4.3	-	-	2.3		
	130520ZDSR-MH																	-	13.5	5.56	2.0	5.56	-	-	3.1		
	150625ZDSR-MH																	-	15.0	6.35	2.5	5.56	-	-	3.4		

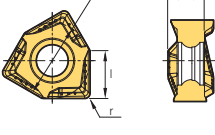
● : Stock item

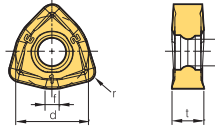
E Milling Inserts

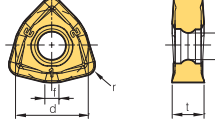
Workpiece	Steel	P	●	●	●	●	●	●	●	●	●	●	●	●	●	●	Machining types
	Stainless steel	M															
Cast iron	K																● Continuous cutting ● General cutting ● Interrupted cutting
Non-ferrous metal	N																
Heat resistant alloy, Titanium alloy	S																
Hardened steel	H																

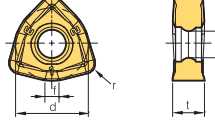
Inserts	Designation	Cermet		Coated								Uncoated		Dimensions (mm)						Geometries	Available tools						
		CN2000	CN30	NCM535	NCM545	PC2505	PC2510	PC2010	PC3600	PC3700	PC6510	PC9530	PC9540	PC5300	PC5400	ST30A	H01	l	d			t	r	d ₁	f		
	040304PNFR-MA															●	4.3	7.0	3.46	0.4	-	-		E110~ E114			
	040308PNFR-MA																●	4.3	7.0	3.46	0.8	-			-		
	040312PNFR-MA																●	4.3	7.0	3.46	1.2	-			-		
	040316PNFR-MA																●	4.3	7.0	3.46	1.6	-			-		
	080604PNFR-MA																●	8.2	13.0	6.4	0.4	-			-		
	080608PNFR-MA																●	8.2	13.0	6.4	0.8	-			-		
	080612PNFR-MA																●	8.2	13.0	6.4	1.2	-			-		
	080616PNFR-MA																●	8.2	13.0	6.4	1.6	-			-		
	080620PNFR-MA																●	8.2	13.0	6.4	2.0	-			-		
	040304PNER-ML																●	4.3	7.0	3.46	0.4	-	-		E110~ E114		
	040308PNER-ML																●	4.3	7.0	3.46	0.8	-	-				
	040312PNER-ML																●	4.3	7.0	3.46	1.2	-	-				
	040316PNER-ML																●	4.3	7.0	3.46	1.6	-	-				
	080604PNER-ML																●	8.2	13.0	6.4	0.4	-	-				
	080608PNER-ML																●	8.2	13.0	6.4	0.8	-	-				
	080612PNER-ML																●	8.2	13.0	6.4	1.2	-	-				
	080616PNER-ML																●	8.2	13.0	6.4	1.6	-	-				
	080620PNER-ML																●	8.2	13.0	6.4	2.0	-	-				
	040304PNSR-MM																●	4.3	7.0	3.46	0.4	-	-		E110~ E114		
	040308PNSR-MM																●	4.3	7.0	3.46	0.8	-	-				
	040312PNSR-MM																●	4.3	7.0	3.46	1.2	-	-				
	040316PNSR-MM																●	4.3	7.0	3.46	1.6	-	-				
	080604PNSR-MM																●	8.2	13.0	6.4	0.4	-	-				
	080608PNSR-MM																●	8.2	13.0	6.4	0.8	-	-				
	080612PNSR-MM																●	8.2	13.0	6.4	1.2	-	-				
	080616PNSR-MM																●	8.2	13.0	6.4	1.6	-	-				
	080620PNSR-MM																●	8.2	13.0	6.4	2.0	-	-				
	060312ZNN-MF																	-	6.35	3.18	1.2	2.86	1.2		E281~ E291		
	09T316ZNN-MF																		-	9.525	3.97	1.6	3.6			1.7	
	130520ZNN-MF																		-	12.7	5.56	2.0	4.7			2.5	
	160720ZNN-MF																		-	16.0	7.0	2.0	5.8			3.0	
	060312ZNN-ML																		-	6.35	3.18	1.2	2.86	1.2		E281~ E291	
	09T316ZNN-ML																			-	9.525	3.97	1.6	3.6			1.7
	130520ZNN-ML																			-	12.7	5.56	2.0	4.7			2.5
	160720ZNN-ML																			-	16.0	7.0	2.0	5.8			3.0
	060312ZNN-MM																		-	6.35	3.18	1.2	2.86	1.2		E281~ E291	
	09T316ZNN-MM																			-	9.525	3.97	1.6	3.6			1.7
	130520ZNN-MM																			-	12.7	5.56	2.0	4.7			2.5
	160720ZNN-MM																			-	16.0	7.0	2.0	5.8			3.0





● : Stock item

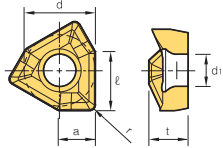

E Milling Inserts

Workpiece	Steel	P	●	●	●	●	●	●	●	●	●	●	●	●	●	●	Machining types			
	Stainless steel	M															●	●	●	
Cast iron	K		●	●	●	●	●	●	●	●	●	●	●	●	●	●	●	●	●	
Non-ferrous metal	N																●	●	●	
Heat resistant alloy, Titanium alloy	S																●	●	●	
Hardened steel	H																●	●	●	

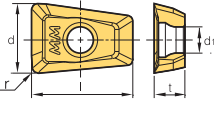
● Continuous cutting
 ● General cutting
 ● Interrupted cutting

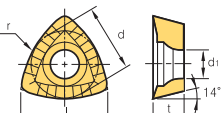





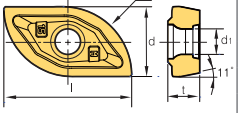

Inserts	Designation	Cermet		Coated								Uncoated		Dimensions (mm)						Geometries	Available tools			
		CN2000	CN30	NC5330	NCM535	NCM545	PC2505	PC2510	PC3600	PC3700	PC6510	PC9530	PC9540	PC5300	PC5400	ST30A	H01	l	d			t	r	d ₁
	060405PNER-ML								●	●	●	●	●	●	●		5.7	6.5	4.0	0.5	3.4	1.8		E89~ E94
	060408PNER-ML								●	●	●	●	●	●	●		5.7	6.5	4.0	0.8	3.4	1.8		
	080504PNER-ML									●	●	●	●	●	●		8.2	10.0	5.5	0.4	4.5	2.9		
	080508PNER-ML				●				●	●	●	●	●	●	●		8.2	10.0	5.5	0.8	4.5	2.9		
	080512PNER-ML																8.2	10.0	5.5	1.2	4.5	2.9		
	080516PNER-ML																8.2	10.0	5.5	1.6	4.5	2.9		
	080520PNER-ML																8.2	10.0	5.5	2.0	4.5	2.9		
	120608PNER-ML									●	●	●	●	●	●		12.0	13.0	6.5	0.8	5.5	3.5		
	120612PNER-ML																12.0	13.0	6.5	1.2	5.5	3.5		
	120616PNER-ML																12.0	13.0	6.5	1.6	5.5	3.5		
	120620PNER-ML																12.0	13.0	6.5	2.0	5.5	3.5		
		060405PNSR-MM								●	●	●	●	●	●	●		5.7	6.5	4.0	0.5	3.4		
060408PNSR-MM									●	●	●	●	●	●	●		5.7	6.5	4.0	0.8	3.4	1.8		
080504PNSR-MM										●	●	●	●	●	●		8.2	10.0	5.5	0.4	4.5	2.9		
080508PNSR-MM					●				●	●	●	●	●	●	●		8.2	10.0	5.5	0.8	4.5	2.9		
080512PNSR-MM																	8.2	10.0	5.5	1.2	4.5	2.9		
080516PNSR-MM																	8.2	10.0	5.5	1.6	4.5	2.9		
080520PNSR-MM																	8.2	10.0	5.5	2.0	4.5	2.9		
120604PNSR-MM																	12.0	13.0	6.5	0.4	5.5	3.5		
120608PNSR-MM										●	●	●	●	●	●		12.0	13.0	6.5	0.8	5.5	3.5		
120612PNSR-MM										●	●	●	●	●	●		12.0	13.0	6.5	1.2	5.5	3.5		
120616PNSR-MM									●	●	●	●	●	●		12.0	13.0	6.5	1.6	5.5	3.5			
120620PNSR-MM									●	●	●	●	●	●		12.0	13.0	6.5	2.0	5.5	3.5			
	0802ER-MM													●		8.5	5.9	2.38	0.8	-	-		E331 E332	
	1003ER-MM													●		10.5	7.25	3.18	0.8	-	-			
	13T3ER-MM													●		13.1	9	3.97	0.8	-	-			
	1604ER-MM													●		16.5	11.5	4.76	0.8	-	-			
	1805ER-MM													●		18	12.4	5.56	0.8	-	-			
	2006ER-MM													●		20.5	14.1	6.35	0.8	-	-			
	2507ER-MM													●		25.5	17.6	7.94	0.8	-	-			
	080310R-MM									●		●				8.4	6.73	3.2	10	2.8	-		E327	
	110312.5R-MM											●				10.6	8.5	3.65	12.5	2.8	-			
	130416R-MM										●		●			13.2	10.5	4.76	16	4.4	-			

● : Stock item

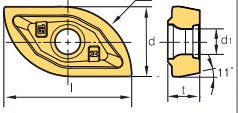

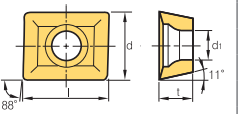

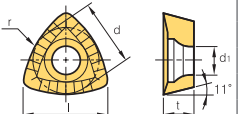

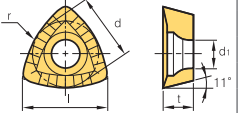









Workpiece	Steel	P											Machining types					
	Stainless steel	M																
Cast iron	K																	
Non-ferrous metal	N																	
Heat resistant alloy, Titanium alloy	S																	
Hardened steel	H																	

● Continuous cutting
 ● General cutting
 ✦ Interrupted cutting

Inserts	Designation	Cemet		Coated								Uncoated		Dimensions (mm)					Geometries	Available tools			
		CN2000	CN30	NC5330	NCM535	NCM545	PC2505	PC2510	PC3600	PC3700	PC6510	PC9530	PC9540	PC5300	PC5400	ST30A	H01	l			d	t	r
ZPET-MM  Internal	080M-MM																16	8.0	3.5	8	2.9		E326
	090M-MM																17.7	7.2	4.3	9	3.4		
	100M-MM																19	10.4	4.5	10	3.4		
	110M-MM																22.2	11.4	4.8	11	4.5		
	125M-MM																24	12.9	5.3	12.5	4.5		
	130M-MM																25.7	13.4	5.3	13	4.5		
	140M-MM																27.2	14.3	6.3	14	5.6		
	150M-MM																28	15.4	7	15	5.6		
	160M-MM																28.5	16.4	7	16	5.6		
	200M-MM																38	20.7	8	20	6.6		
250M-MM																48	25.9	9.5	25	8.6			
ZPET-MM  External	080S-MM																15	6.6	3.1	8	2.9		E326
	090S-MM																15.5	7.4	3.7	9	3.4		
	100S-MM																15.5	8.4	3.8	10	3.4		
	110S-MM																18.1	9	4.4	11	4.5		
	125S-MM																20.5	10.7	4.5	12.5	4.5		
	130S-MM																22.2	11	4.4	13	4.5		
	140S-MM																24.1	11.2	5.7	14	5.6		
	150S-MM																25	12.4	6.5	15	5.6		
	160S-MM																26	13.4	6.5	16	5.6		
	200S-MM																32	16.7	7	20	6.6		
250S-MM																40	20.7	8.5	25	8.6			
ZPMT-MM 	1504PPSR-MM																15.9	12.7	4.76	-	5.6		E199 E299
	1505PPSR-MMN																15.9	12.7	5.76	-	5.6		
ZPMT-R-MM 	160520R-MM																16.1	12.7	5.56	20	5.6		E328
	160525R-MM																16.9	12.7	5.56	25	5.6		
	160531.5R-MM																17.6	12.7	5.56	31.5	5.6		
ZPMT-R-MR 	160525R-MR																17.6	12.7	5.56	25	5.6		E327



















● : Stock item



Type	Cutter	Designation	Shape	A.A	Diameter range	Features	Application					Page
							Facing	Shouldering	Slotting	Copying	Ramping, Helical	
Cutters for face milling	Mill-max	ADN(M) 4000/5000+		45°	Ø80~Ø315	Excellent cutting-edge strength and chip flow	●					E44 E45
		AE(M) 4000/5000		45°	Ø80~Ø315	Low cutting load and good machinability	●					E46 E47
		EF(M) 4000	AI 	75°	Ø80~Ø315	High rake angle to prevents welding	●					E48
		EN(M) 4000		75°	Ø80~Ø315	Economical because double sided inserts applied	●					E49
		EPN(M) 4000/5000+		75°	Ø80~Ø315	Double posi rake angle and low cutting force	●					E50 E51
		PF(M) 4000	AI 	90°	Ø80~Ø315	High rake angle and good machinability	●	●	●			E52
		PPN(M) 4000		90°	Ø80~Ø315	Double posi rake angle and low cutting force	●	●	●			E53
	Mill-max Heavy	HDDCM 7000/9000 new		55°	Ø125~Ø315	Deep roughing availability thanks to highly rigid inserts	●					E55
	Turbo Mill	ADS 4000/5000		45°	Ø50~Ø63	Anti-vibration	●					E56 E57
		PES 2000/3000/ 4000		90°	Ø20~Ø63	High rake angle, Cutting efficiency	●	●	●			E58
	Double Mill	AFO(M)4000		45°	Ø80~Ø125	High rake angle low cutting force Economical (8 corners available)	●					E59
		AFO(M)5000			Ø80~Ø315							E60
	Power Buster	PBAC(M)5000		45°	Ø80~Ø315	Double-sided Insert High depth High feed roughing	●					E65
		PBZC(M)5000		90°	Ø80~Ø315		●					E66
		PBPCM6000 new			Ø80~Ø315		●	●				E67













AI Cutter for aluminum







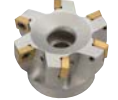





Type	Cutter	Designation	Shape	A.A	Diameter range	Features	Application					Page
							Facing	Shouldering	Slotting	Copying	Ramping, Helical	
Cutters for face milling	Aero Mill	APD(M) A type	 	90°	Ø80~Ø315	Aluminum cutter body suitable for high speed machining. Both cemented carbides and PCD inserts are available, G2.5 balance possible	●					E136
	Aero Mill - Plus	APD(M)-PB	 	90°	Ø80~Ø315	Prevent overload to the spindle bearings through weight reduction of the Al alloy body and enable high-speed processing	●					E137 E138
	Aero Mill-Mini	MAPDS	 	90°	Ø40~Ø63	Available with small Machining center-Carbide, PCD insert	●					E139
		MAPD	 	90°	Ø32~Ø40	Application-Balancing class G2.5	●					E140
	Rich Mill	RM8AC(M)4000 RMH8AC(M)4000		45°	Ø50~Ø400	8 corners available Double-sided insert for steel, cast iron, stainless steel, aluminum	●					E115 E116
							●					E117 E118
		RM8EC(M)4000 RMH8EC(M)4000		75°	Ø50~Ø400	8 corners available Double-sided insert for steel, cast iron	●					E119 E120
							●					E121 E122
		RM8QC(M)4000 RMH8QC(M)4000		88°	Ø63~Ø200	8 corners available Reduced cutting interruption at cast Iron	●					E123 E124
							●					E125 E126
		RMT8A(M) 4000/5000		45°	Ø80~Ø315	Easy insert change and good machinability due to latch clamping system 8 corners available Excellent surface finish	●					E127 E128
		RMT8E(M) 4000/5000		75°	Ø80~Ø315		●					E129
	RMT8Q(M) 4000		88°	Ø80~Ø315	●						E130 E131	
	RM16AC(M) 6000/8000		45°	Ø63~Ø400	16 corners available Wiper inserts can be applied for good surface finish Strong insert and powerful clamping	●					E130 E131	
	Cutters for molds	Rich Mill	RM3PC(M)3000 		90°	Ø40~Ø80	Perfect perpendicularity Strong clamping					
RM3PC(M)4000 			Ø40~Ø125			●		●	●	●	E90	
RM3PC(M)5000 			Ø80~Ø125								E91	

















 Cutter for aluminum



Type	Cutter	Designation	Shape	A.A	Diameter range	Features	Application					Page
							Facing	Shouldering	Slotting	Copying	Ramping, Helical	
Cutters for molds	Rich Mill	RM4PC(M)3000		90°	Ø40~Ø100	4 corners available High rake angle insert reduces cutting force. Excellent insert rigidity	●	●	●	●	E95 E96	
		Ø50~Ø160										
		RM4ZCM3000		90°	Ø40~Ø52	4 corners available In vertical machining, the maximum cutting depth for RM4Z3000: 9.00 mm, RM4Z4000: 14.0 mm	●	●	●	●	E108	
		Ø63~Ø100										
		RM6PC(M)-WN04 ^{new}		90°	Ø40~Ø63	Improved productivity and high-quality shouldering through high speed and high feed machining	●	●	●	●	E110	
		RM6PC(M)-WN08 ^{new}			Ø50~Ø125						E111	
	Alpha Mill-X	AMXCM ^{new}		90°	Ø40~Ø80	High rake angle cutting edge and chip breaker reduce cutting load and improve chip evacuation. High rigidity due to special design	●	●	●	●	●	E145
	Alpha Mill	AMC(M) 1000S/1500S/2000S		90°	Ø32~Ø100	3-dimensional shape and high rake angle lowers cutting load and ensures better chip evacuation Inner coolant system for better chip control increases tool life Wide size range of inserts enlarges application range. Various types of Alpha Mills available for high depth of cut and high feed machining	●	●	●	●	●	E154 ~E156
		AMC(M) 3000S/3000S-K /4000S		90°	Ø40~Ø200		E157 ~E159					
		AMC(M) 1000SE 2000SE 3000SE		75°	Ø40~Ø100		E160 E161					
		AMC(M) 2000M 3000M 4000M		90°	Ø50~Ø125		E162 E163 E164					
	Future Mill	FMAC(M)3000		45°	Ø50~Ø125	Accurate inserts and cutter, Excellent chip flow	●					E222
		Ø50~Ø200			E223							
		FMAC(M)3000A		45°	Ø63~Ø125	Excellent in high speed cutting and tapping center, low power machine due to light aluminum body	●					E224
		Ø63~Ø315			E225							
		FMPC(M)3000		90°	Ø50~Ø100	4 corners available various inserts can be applied to machine for different types of workpiece	●	●	●			E228
		Ø63~Ø125			E229							
		FMPC(M)3000A		90°	Ø63~Ø100	Excellent in high speed cutting and tapping center, low power machine due to light aluminum body	●	●	●			E230
Ø63~Ø315		E231										



























Type	Cutter	Designation	Shape	A.A	Diameter range	Features	Application					Page
							Facing	Shouldering	Slotting	Copying	Ramping, Helical	
Cutters for molds	Future Mill	FMRC(M)3000		-	Ø40~Ø100	4~8 corners available Double contact faces between insert & seat part of cutter for stable clamping Excellent rotating-free machining	●	●	●	●	●	E234
		FMRC(M)4000			Ø50~Ø125		E235					
		FMRC(M)5000		-	Ø50~Ø125		E236					
		FMRC(M)6000			Ø63~Ø160		E237					
	Future Mill P-positive	FMRC(M) ^{new} 3000 4000 5000 6000		-	Ø40~Ø250	Stable clamping system enables stable machining and productivity Varied product line-up ensures wide application range Optimal shape and grade with high hardness for hard-to-cut material machining.	●	●	●	●	●	E248 ~E251
	HFMD	HFMDCM-LN06 ^{new}		-	Ø32~Ø66	Double sided with 4 corners insert for small diameter machining For high feed and multi-functional machining Strong clamping realizes stable machining.	●	●	●		●	E266
	HRM	HRMC(M)13		15°	Ø50~Ø80	Powerful clamping by double clamping system 3 corners available high feed cutting with low cutting load	●	●	●		●	E292
		HRMC(M)15			Ø63~Ø160		E293					
	HRMD	HRMDC(M)09		14°	Ø40~Ø100	Double side insert with 6 corner High feed cutting with strong simple screw-on clamp	●	●	●		●	E281
		HRMDC(M)13			Ø50~Ø125		E282					
		HRMDC(M)16 ^{new}			Ø80~Ø315		E283					
	Tangen-Pro	TP2PC(M)-LN08 ^{new}		90°	Ø40~Ø63	High-quality results available even under harsh cutting conditions, thanks to the stable clamping force	●	●	●			E303
		TP2PC(M)-LN14 ^{new}			Ø40~Ø125		E304					
		TP2PC(M)-LN17 ^{new}			Ø40~Ø125		E305					
	BT/HSK Tooling System	BT30/40/50		90°	Ø10~Ø50	BT/HSK one solid type has been accepted to increase the precision Inner coolant system can also make it possible to evacuate the chip effectively High feed and high depth	●	●	●		●	E184 ~E188
		HSK63					E189 ~E193					
		BT30/40/50		90°	Ø16~Ø100	High feed and high depth	●	●	●			E194 ~E199
		HSK63/100					E200 ~E204					
		BT30/40/50-MAT		90°	Ø12~Ø40	Alpha Mill, Rich Mill, FMR, Laser Mill, HRM(D), Pro-A, Pro-X Modular head M06~M16 applicable	●	●	●	●	●	E205
		HSK63/100-MAT					E206					
BT50 HAT4000			90°	Ø50~Ø80	Head only replacement possible and higher efficiency by self assembly head	●	●	●			E199	

Type	Cutter	Designation	Shape	A.A	Diameter range	Features	Application					Page
							Facing	Shouldering	Slotting	Copying	Ramping, Helical	
Cutters for aluminum	Pro-A Mill	PAC(M) 2000/4000	 	90°	Ø40~Ø100	Buffered insert controls chip flow without built-up edge	●	●	●	●	●	E354
	Pro-X Mill	PAXC(M)5000	 	90°	Ø40~Ø125 Ø50~Ø125	Powerful clamping Excellent body rigidity for rectangular and curve machining	●	●	●	●	●	E357
		PAXC(M)6000										E358
	Pro-L Mill	PALC(M)	 	90°	Ø63	High helix and high depth of cut High perpendicularity Low cutting load	●	●	●	●	●	E363
Pro-V Mill	PAVCM-XD19 		90°	Ø40~Ø125	Exclusive milling tool for high speed aluminum machining with key to key way structure ensures stable clamping.	●	●	●	●	●	E368	
High feed cutter for cast iron	High feed cutter	PNH 4000/5000		90°	Ø125~Ø450	Wiper insert available Double negative rake angle Excellent surface finish	●					E395
		PPH 4000		90°	Ø125~Ø450	Square insert and wiper insert available Excellent surface finish	●					E396
	Shave Mill	SVM(M)4000		90°	Ø80~Ø315	Exclusive adjusting device of cutting-edge adjusts run-out easily.	●					E397
	Shave Mill-Ultra	SVUM6000		90°	Ø80~Ø315	Good rigidity and economical due to screw on simple type	●					E398
		SVUM6000-B		90°	Ø80~Ø315	Easy to handle the run-out due to Korloy exclusive high toughness cutting-edge special parts	●					E399
Indexable side cutter	Tangential type	Full-side cutter	TAFCP		-	Ø100~Ø315	Various cutting depth can be possible because of adjustable length control. Medium to Roughing based on strengthened edge		●	●		E375
			TAFCB		-	Ø100~Ø315		●	●	●	E375	
	Half-side cutter	TAHCP		-	Ø100~Ø315	●		●	●	E376		
		TAHCB		-	Ø100~Ø315	●		●	●	E376		

 Cutter for aluminum





Type	Cutter	Designation	Shape	A.A	Diameter range	Features	Application					Page	
							Facing	Shouldering	Slotting	Copying	Ramping, Helical		
Indexable side cutter	Radial type	Full-side cutter	RAFCP		-	Ø100~Ø315	Wide range of machining width with only one side cutter due to adjustable cutting-edge height Suitable for medium and finishing in narrow width side cutting due to good chip evacuation by 3-dimensional chip breaker		●	●			E377
			RAFCB		-	Ø100~Ø315		●	●	●		E377	
	Half-side cutter	RAHCP		-	Ø100~Ø315			●	●		E378		
		RAHCB		-	Ø100~Ø315	●		●	●		E378		
Side cutterz	-	SPP(M)		-	Ø80~Ø200	Economical by using pentagonal insert Suitable for narrow & deep grooving			●			E379	
		SPB(M)		-	Ø80~Ø200	Economical by using pentagonal insert Suitable for narrow & deep grooving			●		E380		
		SPS		-	Ø50~Ø200	For narrow and deep width grooving			●		E381		
	Full-side cutter	RM4PFCB		-	Ø80~Ø160	4 corner usage with double-sided insert can be economical			●		E97 E98		
		RM4PFCP		-	Ø80~Ø160				●		E101 E102		
	Half-side cutter	RM4PHCB		-	Ø80~Ø160	4 corner usage with double-sided insert can be economical			●		E99 E100		
		RM4PHCP		-	Ø80~Ø160				●		E103 E104		
	Wind Mill	WFSB(M)		-	Ø100~Ø250	The nose R shape of insert ensures long tool life. Wide applications with various widths and corner R sizes.	●	●	●		E384		
		WFSP(M)		-	Ø100~Ø250				●	●	E385		









Type	Cutter	Designation	Shape	A.A	Diameter range	Features	Application					Page
							Facing	Shouldering	Slotting	Copying	Ramping, Helical	
Cutters for face milling	Turbo Mill	ADS 4000/5000		45°	Ø50~Ø63	Uneven insert spacing prevents chattering	●					E56 E57
		PES 2000/3000/4000		90°	Ø20~Ø63	Good machinability due to the high rake angle	●	●	●			E58
Cutters for molds	Rich Mill	RM3PS3000 new		90°	Ø20~Ø40	Perfect perpendicularity Strong clamping	●	●	●	●	●	E92
		Ø32~Ø63			E93							
		RM4PS3000		90°	Ø14~Ø50	4 corners available High rake angle insert reduces cutting force	●	●	●	●	●	E105
		Ø32~Ø63			Excellent insert rigidity	●	●	●	●	E106		
		RM4ZS3000		90°	Ø25~Ø40	In vertical machining, the maximum cutting width: 9.0 mm	●	●	●	●	●	E109
		RM6PS-WN04 new		90°	Ø20~Ø32	Improved productivity and high-quality shouldering through high speed and high feed machining	●	●	●	●	●	E112
	Ø32~Ø50	E113										
	Alpha Mill-X	AMXS new		90°	Ø32~Ø40	High rake angle cutting edge and chip breaker reduce cutting resistance and improve chip evacuation. High rigidity due to special design	●	●	●	●	●	E146
	Alpha Mill	AMS 1000S/1500S 2000S/3000S 3000S-K/4000S		90°	Ø10~Ø63		●	●	●	●	●	E165 ~E172
		AMS 1000SE/2000SE 3000SE		75°	Ø25~Ø63	The combination of a 3-dimensional curve design & high rake angle helps chip-evacuation effectively with a low cutting force Inner coolant system	●					E173 E174
		AMS 1000M/1500M 2000M/4000M		90°	Ø16~Ø50	The various range of inserts can provide the widened choice High depth and high feed can be available during operation	●	●	●	●	●	E175 ~E177
		AMS 1000MH/1500MH 2000MH/3000MH(-K)		90°	Ø14~Ø40		●	●	●	●	●	E178 E179



Type	Cutter	Designation	Shape	A.A	Diameter range	Features	Application					Page	
							Facing	Shouldering	Slotting	Copying	Ramping, Helical		
Cutters for molds	Future Mill	FMAS3000		45°	Ø25~Ø63	For precision machining Excellent chip evacuation	●					E226	
		FMAS4000			Ø50~Ø63							E227	
		FMPS3000		90°	Ø25~Ø63	4 corners available Strong cutting-edge with low cutting load	●						E232
		FMPS4000			Ø40~Ø63								E233
		FMRS 1000/1500/2000 2500/3000/4000 5000/6000		-	Ø8~Ø63	2 touch clamping system, convenient insert change	●	●	●	●	●		E238 ~243
	Future Mill P-positive	FMRS new 2500/3000 4000/5000 6000		-	Ø17~Ø50	P-positive relief angle ensures high rigidity and high machinability in die steel and high-resistant alloy machining Flat clearance face of insert prevents interference and revolution while machining	●	●	●	●	●		E252 ~E255
	HFMD	HFMS-LN06 new		-	Ø16~Ø40	Double sided insert with 4 corners for small diameter machining For high feed and multi-functional machining Strong clamping system for stable machining	●	●	●	●	●		E264 E265
	HFM	HFMS new 1000		-	Ø8~Ø21	Apply helix cutting-edge on insert, low cutting load and reinforce toughness on corner Increased rigidity with double relief angle (11, 13), prevent interference with high feed To apply the negative axial rake angle when set up the holder, increased chipping resistance	●	●	●	●	●		E273 E274
	HRM	HRMS 08/10/13/15		15°	Ø20~Ø63	Powerful clamping by double clamping system 3 corners available High feed cutting with low cutting load	●	●	●	●	●		E294 ~E296
	HRMD	HRMDS 06 new 09/13		14°	Ø16~Ø63	6 corners available, High feed, multi-function, only one screw application	●	●	●	●	●		E284 ~E287
	Tangen-Pro	TP2PS-LN08 new TP2PS-LN14 new TP2PS-LN17 new		90°	Ø16~Ø25	High-quality results available even under harsh cutting conditions, thanks to the stable clamping force	●	●	●				E306
		Ø25~Ø50			E307								
		Ø32~Ø50			E308								
	Tank Mill	THE		90°	Ø25~Ø50	Right-hand helix angle employed for good chip evacuation. Special surface treatment prevents body breaking and improves rigidity. Strong cutting-edge	●	●					E299
Laser Mill	LBE□□ LRE□□		-	Ø8~Ø32	Indexable ball endmill for precise mold. Rigid holder with simple design finishing MQL is available	●	●	●	●			E318 ~E322	
	LBE□□-C LRE□□-C		-	Ø8~Ø32	Indexable ball endmill for precise mold. Rigid holder with simple design finishing MQL is available Carbide shank	●	●	●				E318 ~E322	

Type	Cutter	Designation	Shape	A.A	Diameter range	Features	Application					Page	
							Facing	Shouldering	Slotting	Copying	Ramping, Helical		
Cutters for molds	Mach Mill	BFE		-	Ø16~Ø32	Upgraded cutting performance with S type curve design V clamping application	●	●	●	●		E323	
		GBE		-	Ø16~Ø50	Helical design of edge can reduce the force during operation. Safe application to prevent rotation guarantee the increased tool life	●	●	●	●		E324	
		BRE		-	Ø20~Ø63	Flute type chip-pocket can make chip-evacuation Customized edge design can prevent the breakage of holder's body	●	●	●	●		E327	
	HAVE	Multi-edge		90°	Ø16~Ø50	Tools for Z-axis feed plunge machining to cut faster and more effectively in vertical machining Machining with whole diameter	●	●	●	●		E331	
		Single-edge										E332	
	O-ring Cutter	ORC		90°	Ø11~Ø46	For grooving the seat of an O-Ring in a plastic mold Superior surface roughness and cutting performance compared to HSS and brazed tool	-	-	-	-	-	E334	
	Chamfer Tool	CE		75°	Ø25~Ø30	For Back & Front high quality chamfering and various Chamfering angle machining	●						E338
				60°	Ø25~Ø35								
				45°	Ø7~Ø39								
				30°	Ø25~Ø42								
		CE		30°	Ø5~Ø35	Various chamfer degrees available Effective long chamfer cutting available	●	●	●				E339
				45°	Ø5~Ø48								
				60°	Ø5~Ø57								
				45°	~Ø28	Centering, Grooving, Chamfering	●	●	●	●		E340	
	CCT		30°	Ø3~Ø16	Centering, Countersinking, Chamfering							E342	
			45°										
			60°										
	CET		30°	Ø4~Ø16	Countersinking, Chamfering, Shouldering	●	●	●				E341	
45°													
60°													
T-Cutter	TFE		90°	Ø21~Ø50	For slotting	●	●	●	●	●	E343		



Type	Cutter	Designation	Shape	A.A	Diameter range	Features	Application					Page
							Facing	Shouldering	Slotting	Copying	Ramping, Helical	
Cutters for aluminum	Pro-A Mill	PAS 2000/4000		90°	Ø12~Ø42 Ø32~Ø40	Polished face increases chip flow and reduces built-up edge	●	●	●	●	●	E355
	Pro-X Mill	PAXS 5000/6000		90°	Ø20~Ø40 Ø25~Ø40	Square shoulder and corner machining	●	●	●	●	●	E359 E360
	Pro-L Mill	PALS-HR (Single-edge)		90°	Ø32~Ø63	High helix and high depth of cut High perpendicularity Low cutting load	●	●	●	●	●	E364 E365
		PALS-HM (Multi-edge)			Ø63		●	●	●	●	●	E366
	Pro-XL Mill	PXLS new		90°	Ø40~Ø80	Improved surface finish and perpendicularity achieved by a single pass with the deep cutting-edges	●	●				E367
	Pro-V Mill	PAVS-XD19 new		90°	Ø25~Ø40	Exclusive milling tool for high speed aluminum machining with key to key way structure ensures stable machining.	●	●	●	●	●	E369
		HSK-XD19 new			Ø32~Ø50		●	●	●	●	●	E370
Thread milling	-	TM		-	Ø32~Ø50	For internal and external threading	●					D49

E KORLOY Modular Adaptors

FMRM type
 → E244~247
 E256~259



LBE-MHD type
 → E322



PAM type
 → E356



PAXM type
 → E361



AMM type
 → E180~182



RM3PM type
 → E94



RM4PM type
 → E107



Steel Shank type
 → E371



Carbide Shank type
 → E372



BT Arbors type
 → E205



HSK Arbors type
 → E206



<p>RM4ZM type ➔ E109</p>			<p>Steel Shank type ➔ E371</p>
<p>RM6PM type ➔ E114</p>			<p>Carbide Shank type ➔ E372</p>
<p>HFMDM type ➔ E267</p>			<p>BT Arbors type ➔ E205</p>
<p>HFMM type ➔ E275</p>			<p>HSK Arbors type ➔ E206</p>
<p>HRMM type ➔ E297, 298</p>			
<p>HRMDM type ➔ E289~291</p>			
<p>GBEM type ➔ E326</p>			

ADN(M)4000

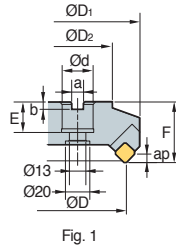

Fig. 1

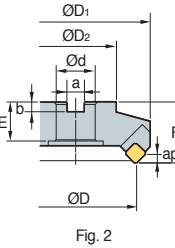

Fig. 2

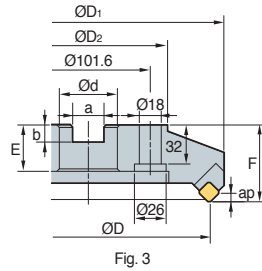

Fig. 3

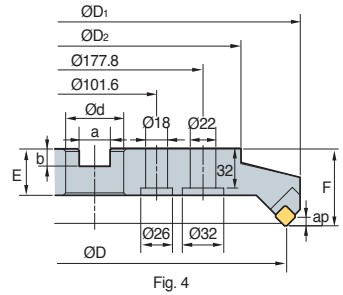

Fig. 4



(mm)

Designation	ØD	ØD1	ØD2	Ød	a	b	E	F	ap	kg	Fig.
ADN 4080R/L	80	57	57	25.4 (27)	9.5 (12.4)	6 (7)	25 (22)	50	6	1.9	1
(ADNM) 4100R/L	100	67	67	31.75 (32)	12.7 (14.4)	8 (8)	32 (28)	50	6	2.5	2
4125R/L	125	87	87	38.1 (40)	15.9 (16.4)	10 (9)	38 (30)	63	6	4.3	2
4160R/L	160	107	107	50.8 (40)	19.0 (16.4)	11 (9)	38 (30)	63	6	6.4	2
4200R/L	200	130	130	47.625 (60)	25.4 (25.7)	14 (14)	38 (38)	63	6	8.7	3
4250R/L	250	180	180	47.625 (60)	25.4 (25.7)	14 (14)	38 (38)	63	6	14.0	3
4315R/L	315	240	240	47.625 (60)	25.4 (25.7)	14 (14)	38 (38)	63	6	21.0	4

() Metric size

Available inserts

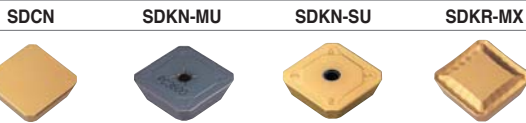

Designation	Cermet		Coated								Uncoated		page					
	CN2000	CN30	NCM325	NCM335	NC5330	NCM535	NCM545	PC3600	PC3700	PC6510	PC9530	PC9540		PC5300	PC5400	ST30A	G10	H01
SDCN 42M																		
42M-G																		
42MT	●	●	●															
42MT-RH																		
42MT-S20										●								E17
1203AEEN																		
1203AEEN-RH																		
1203AESN																		
1203AESN-RH																		
SDKN 1203AESN-MU										●								E18
1203AESN-SU										●	●		●	●				E18
SDKR 1203AESN-MX																		E18
1203AETN-MX																		E18
1203AEN-MX		●																E18

Available arbors

Designation	General arbor	NC arbors	
		ADN	ADNM
ADN 4080R/L	NT*□□ (MU)-FMA25.4-25	BT**□□-FMA25.4-□□	FMC27
(ADNM) 4100R/L	NT*□□ (MU)-FMA31.75-□□	BT**□□-FMA31.75-□□	FMC32
4125R/L	NT*□□ (MU)-FMA38.1-□□	BT**□□-FMA38.1-□□	FMB40
4160R/L	NT*□□ (MU)-FMA50.8-□□	BT**□□-FMA50.8-□□	FMB40
4200R/L	NT*□□ (MU)-FMA47.625-25, KCP-8***	BT**□□-FMA47.625-□□	FMB60
4250R/L	NT*□□ (MU)-FMA47.625-25, KCP-8***	BT**□□-FMA47.625-□□	FMB60
4315R/L	KCP-8*** (Center ring plug)		

*□□-NT number **□□-BT number ***Over milling 5

Recommended cutting condition

Workpiece	Cutting condition		Grades
	vc (m/min)	fz (mm/t)	
P	190~320	0.05~0.20	NCM325 PC3600 ST30A
	161~270	0.05~0.20	
	80~140	0.05~0.20	
M	90~150	0.05~0.20	PC9530
K	140~230	0.05~0.30	PC6510 G10
	50~90	0.05~0.30	

Assembling

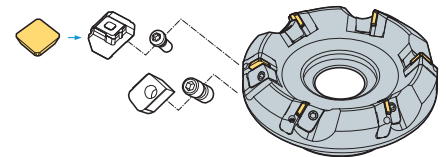

Parts

Specification	Locator	Wedge	Wedge screw	Locator screw	Wrench
Ø80~Ø315	LADN4R/L	WEPN4R/L	DHA0821F	LTX0514	HW40

Available inserts E17, E18 Available arbors and bolt E400~E402



ADN(M)5000+

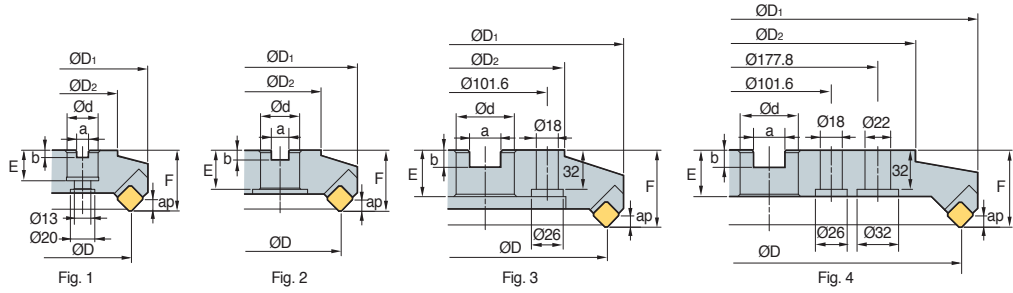

AA
45°
• AR: 15°
• RR: -4°

(mm)

Designation	ØD	ØD1	ØD2	Ød	a	b	E	F	ap	kg	Fig.	
ADN 5080R/L+	4	80	107	65	25.4 (27)	9.5 (12.4)	6 (7)	25 (22)	63	8	2.4	1
(ADNM) 5100R/L+	5	100	126	75	31.75 (32)	12.7 (14.4)	8 (8)	32 (28)	63	8	3.0	2
5125R/L+	6	125	150	100	38.1 (40)	15.9 (16.4)	10 (9)	38 (30)	63	8	4.7	2
5160R/L+	8	160	185	120	50.8 (40)	19.0 (16.4)	11 (9)	38 (30)	63	8	6.5	2
5200R/L+	10	200	225	140	47.625 (60)	25.4 (25.7)	14 (14)	38 (38)	63	8	8.7	3
5250R/L+	12	250	275	220	47.625 (60)	25.4 (25.7)	14 (14)	38 (38)	63	8	15.5	3
5315R/L+	14	315	340	280	47.625 (60)	25.4 (25.7)	14 (14)	38 (38)	63	8	23.7	4

() Metric size

Available inserts

	SDCN	SDKN-MU	SDKN-SU	SDKR-MX	
Designation	Cemet		Coated		page
	CN2000 CN30	NCM325 NCM385 NC5330 NCM535 NCM545	PC3600 PC3700 PC6510 PC9530 PC9540 PC5300 PC5400	ST30A G10 H01	
SDCN 53M					
53M-G					
53MT	●	●			
53MT-RH					
53MT-S20				●	E17
1504AEEN					
1504AEEN-RH				●	
1504AESN				●	
1504AESN-RH				●	
SDKN 1504AESN-MU			●		E18
1504AESN-SU			● ●	● ●	
SDKR 1504AESN-MX		●			E18
1504AETN-MX					
1504AEN-MX		●			

Available arbors

Designation	General arbor	NC arbors	
		ADN	ADNM
ADN 5080R/L+	NT*□□ (MU)-FMA25.4-25	BT**□□-FMA25.4-□□	FMC37
(ADNM) 5100R/L+	NT*□□ (MU)-FMA31.75-□□	BT**□□-FMA31.75-□□	FMC22
5125R/L+	NT*□□ (MU)-FMA38.1-□□	BT**□□-FMA38.1-□□	FMB40
5160R/L+	NT*□□ (MU)-FMA50.8-□□	BT**□□-FMA50.8-□□	FMB40
5200R/L+	NT*□□ (MU)-FMA47.625-25, KCP-8***	BT**□□-FMA47.625-□□	FMB60
5250R/L+	NT*□□ (MU)-FMA47.625-25, KCP-8***	BT**□□-FMA47.625-□□	FMB60
5315R/L+	KCP-8*** (Center ring plug)		

*□□-NT number **□□-BT number ***Over milling 5

Recommended cutting condition

Workpiece	Cutting condition		Grades
	vc (m/min)	fz (mm/t)	
P	190~320	0.05~0.20	NCM325 PC3600 ST30A
	161~270	0.05~0.20	
	80~140	0.05~0.20	
M	90~150	0.05~0.20	PC9530
K	140~230	0.05~0.30	PC6510 G10
	50~90	0.05~0.30	

Assembling

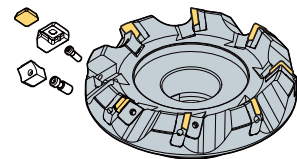

Parts

Specification					
Ø80~Ø315	LADN5R/L	WHPS5R/L	WHX0817 WHX0813*	LTX0514	HW40

Available inserts E17, E18

Available arbors and bolt E400~E402

*: Ø80

AE(M)4000

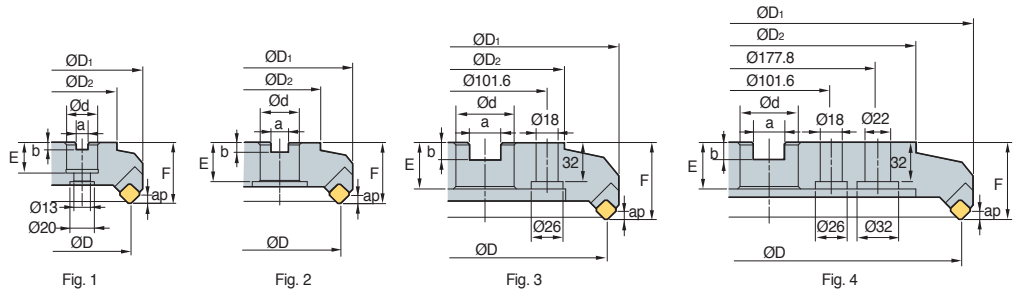

AA 45°
 • AR: 20°
 • RR: -3°

Designation	ØD	ØD ₁	ØD ₂	Ød	a	b	E	F	ap	kg	Fig.
AE 4080R/L	80	103	60	25.4 (27)	9.5 (12.4)	6 (7)	25 (22)	50	5.5	1.7	1
(AEM) 4100R/L	100	122	80	31.75 (32)	12.7 (14.4)	8 (8)	32 (28)	50	5.5	2.9	2
4125R/L	125	146	100	38.1 (40)	15.9 (16.4)	10 (9)	38 (30)	63	5.5	4.4	2
4160R/L	160	181	120	50.8 (40)	19.0 (16.4)	11 (9)	38 (30)	63	5.5	6.1	2
4200R/L	200	220	130	47.625 (60)	25.4 (25.7)	13.5 (14)	38 (38)	63	5.5	8.9	3
4250R/L	250	270	180	47.625 (60)	25.4 (25.7)	13.5 (14)	38 (38)	63	5.5	15.7	3
4315R/L	315	335	240	47.625 (60)	25.4 (25.7)	13.5 (14)	38 (38)	63	5.5	25.1	4

() Metric size

Available inserts

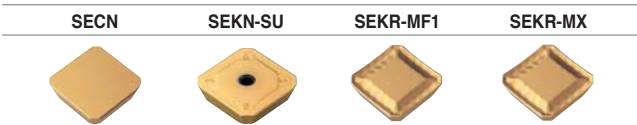

Designation	Cermet		Coated							Uncoated		page				
	CN2000 CN30	CN30	NCM325	NCM335	NC5330	NCM535	NCM545	PC3600	PC3700	PC6510	PC9530		PC9540	PC5300	PC5400	ST30A G10 H01
SECN 1203AFFN																
1203AFTN	●	●													●	
1203AFEN																
1203AFSN			●	●												
1203AFEN-RH										●			●			
1203AFSN-RH																
1203AFTN-S20											●					
SEKN 1203AFSN-SU																
SEKR 1203AFSN-MX			●	●							●					

Available arbors

Designation	General arbor	NC arbors	
		ADN	ADNM
AE 4080R/L	NT*□□ (M/U)-FMA25.4-25	BT**□□ -FMA25.4-□□	FMC27
(AEM) 4100R/L	NT*□□ (M/U)-FMA31.75-□□	BT**□□ -FMA31.75-□□	FMC32
4125R/L	NT*□□ (M/U)-FMA38.1-□□	BT**□□ -FMA38.1-□□	FMB40
4160R/L	NT*□□ (M/U)-FMA50.8-□□	BT**□□ -FMA50.8-□□	FMB40
4200R/L	NT*□□ (M/U)-FMA47.625-25, KCP-8***	BT**□□ -FMA47.625-□□	FMB60
4250R/L	NT*□□ (M/U)-FMA47.625-25, KCP-8***	BT**□□ -FMA47.625-□□	FMB60
4315R/L	KCP-8*** (Center ring plug)		

*□□-NT number **□□-BT number ***Over milling 5

Recommended cutting condition

Workpiece	Cutting condition		Grades
	vc (m/min)	fz (mm/t)	
P	190~320	0.05~0.20	NCM325 PC3600 ST30A
	161~270	0.05~0.20	
	80~140	0.05~0.20	
M	90~150	0.05~0.20	PC9530
K	140~230	0.05~0.30	PC6510 G10
	50~90	0.05~0.30	

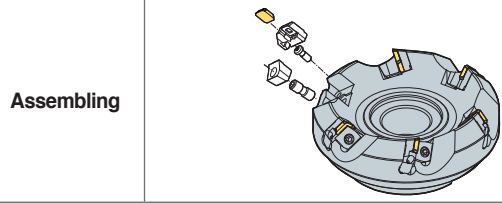

Parts

Specification					
Ø80~Ø315	LAE4R/L	WAE4R/L	DHA0821F	LTX0512	HW40

Available inserts E19, E20 Available arbors and bolt E400~E402



AE(M)5000

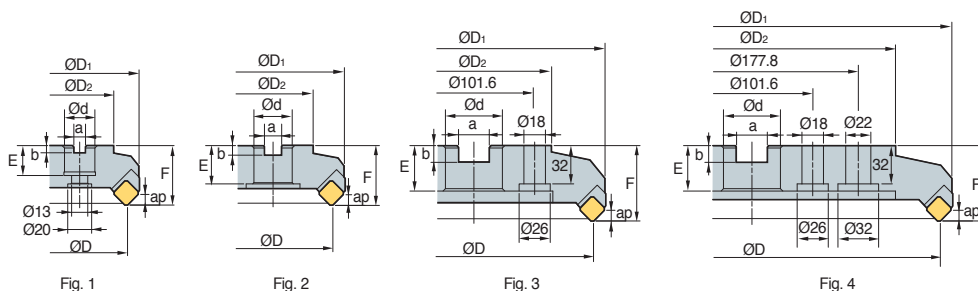

Designation	ØD	ØD1	ØD2	Ød	a	b	E	F	ap	kg	Fig.
AE 5080R/L	80	103	60	25.4 (27)	9.5 (12.4)	6 (7)	25 (22)	50	7.5	1.7	1
(AEM) 5100R/L	100	122	80	31.75 (32)	12.7 (14.4)	8 (8)	32 (28)	50	7.5	2.9	2
5125R/L	125	146	100	38.1 (40)	15.9 (16.4)	10 (9)	38 (30)	63	7.5	4.4	2
5160R/L	160	181	120	50.8 (40)	19.0 (16.4)	11 (9)	38 (30)	63	7.5	6.1	2
5200R/L	200	220	130	47.625 (60)	25.4 (25.7)	13.5 (14)	38 (38)	63	7.5	8.9	3
5250R/L	250	270	180	47.625 (60)	25.4 (25.7)	13.5 (14)	38 (38)	63	7.5	15.7	3
5315R/L	315	335	240	47.625 (60)	25.4 (25.7)	13.5 (14)	38 (38)	63	7.5	25.1	4

() Metric size

Available inserts

	SECN	SEKR-MX	SEKN-SU	
Designation	Cermet			page
	CN2000	CN30	CN30	
SECN	Coated			E19
	1504AFFN	NCM325	NCM335	
	1504AFTN	NC5330	NCM535	
	1504AFEN	NCM545	PC3600	
	1504AFSN	PC3700	PC6510	
	1504AFEN-RH	PC9530	PC9540	
	1504AFSN-RH	PC5300	PC5400	
	1504AFTN-S20	ST30A	G10	
	1504AFSN-SU	H01		
	1504AFSN-MX			
SEKN				E19

Available arbors

Designation	General arbor	NC arbors	
		AE	AEM
AE 5080R/L	NT*□□ (M/U)-FMA25.4-25	BT**□□-FMA25.4-□□	FMC27
(AEM) 5100R/L	NT*□□ (M/U)-FMA31.75-□□	BT**□□-FMA31.75-□□	FMC32
5125R/L	NT*□□ (M/U)-FMA38.1-□□	BT**□□-FMA38.1-□□	FMB40
5160R/L	NT*□□ (M/U)-FMA50.8-□□	BT**□□-FMA50.8-□□	FMB40
5200R/L	NT*□□ (M/U)-FMA47.625-25, KCP-8***	BT**□□-FMA47.625-□□	FMB60
5250R/L	NT*□□ (M/U)-FMA47.625-25, KCP-8***	BT**□□-FMA47.625-□□	FMB60
5315R/L	KCP-8*** (Center ring plug)		

*□□-NT number **□□-BT number ***Over milling 5

Recommended cutting condition

Workpiece	Cutting condition		Grades
	vc (m/min)	fz (mm/t)	
P	190~320	0.05~0.20	NCM325 PC3600 ST30A
	161~270	0.05~0.20	
	80~140	0.05~0.20	
M	90~150	0.05~0.20	PC9530
K	140~230	0.05~0.30	PC6510 G10
	50~90	0.05~0.30	

Assembling

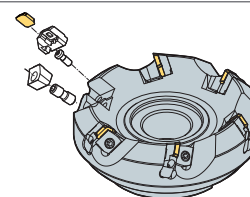

Parts

Specification					
Ø80~Ø315	LAE5R/L	WAE5R/L	DHA0821F	LTX0512	HW40

Available inserts **E19** Available arbors and bolt **E400~E402**

EF(M)4000

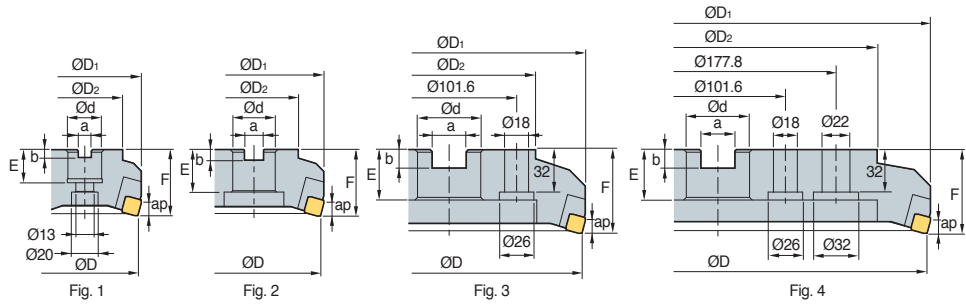

Designation	ØD	ØD ₁	ØD ₂	Ød	a	b	E	F	ap	kg	Fig.
EF											
(EFM)											
4080R/L	80	89	57	25.4 (27)	9.5 (12.4)	6 (7)	25 (22)	50	8.0	1.5	1
4100R/L	100	108	70	31.75 (32)	12.7 (14.4)	8 (8)	32 (28)	50	8.0	2.1	2
4125R/L	125	133	87	38.1 (40)	15.9 (16.4)	10 (9)	38 (30)	63	8.0	3.8	2
4160R/L	160	168	107	50.8 (40)	19.0 (16.4)	11 (9)	38 (30)	63	8.0	5.5	2
4200R/L	200	208	130	47.625 (60)	25.4 (25.7)	13.5 (14)	38 (38)	63	8.0	8.2	3
4250R/L	250	257	180	47.625 (60)	25.4 (25.7)	13.5 (14)	38 (38)	63	8.0	13.4	3
4315R/L	315	322	240	47.625 (60)	25.4 (25.7)	13.5 (14)	38 (38)	63	8.0	21.2	4

() Metric size

Available inserts

Designation	SFCN										page			
	Cermet	Coated							Uncoated					
SFCN 1203EFR	CN2000 CN30	NCM325	NG5330	NCM535	NCM545	PC2010	PC3600	PC6510	PC9530	PC9540	PC5300	PC5400	ST30A G10 H01	● E20

Available arbors

Designation	General arbor	NC arbors	
		EF	EFM
EF			
(EFM)			
4080R/L	NT*□□ (MU)-FMA25.4-25-□□	BT**□□ -FMA25.4-□□	FMC27
4100R/L	NT*□□ (MU)-FMA31.75-□□	BT**□□ -FMA31.75-□□	FMC32
4125R/L	NT*□□ (MU)-FMA38.1-□□	BT**□□ -FMA38.1-□□	FMB40
4160R/L	NT*□□ (MU)-FMA50.8-□□	BT**□□ -FMA50.8-□□	FMB40
4200R/L	NT*□□ (MU)-FMA47.625-25, KCP-8***	BT**□□ -FMA47.625-□□	FMB60
4250R/L	NT*□□ (MU)-FMA47.625-25, KCP-8***	BT**□□ -FMA47.625-□□	FMB60
4315R/L	KCP-8*** (Center ring plug)		

*□□-NT number **□□-BT number ***Over milling 5

Recommended cutting condition

Workpiece	Cutting condition		Grades
	vc (m/min)	fz (mm/t)	
K	75~125	0.05~0.30	H01

Assembling

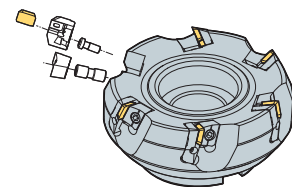

Parts

Specification	Locator	Wedge	Wedge screw	Locator screw	Wrench
Ø80~Ø315	LEF4R/L LEF4R1*/L1*	WEFR/L	DHA0821F	LTX0512	HW40

*: Ø80~Ø100

Available inserts **E20** Available arbors and bolt **E400~E402**



EN(M)4000

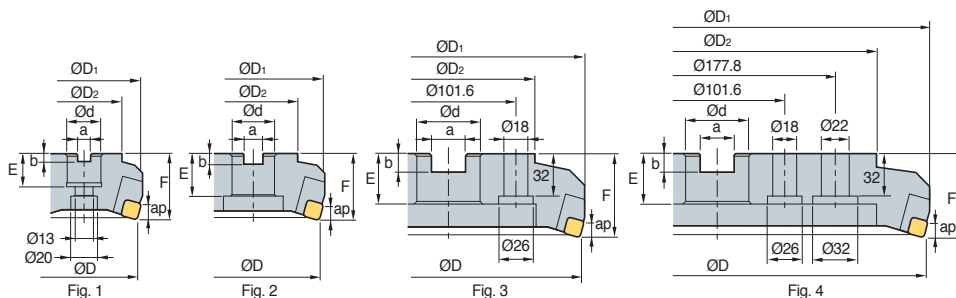

Designation	ØD	ØD1	ØD2	Ød	a	b	E	F	ap	kg	Fig.
EN 4080R/L	80	87	57	25.4 (27)	9.5 (12.4)	6 (7)	25 (22)	50	8.5	1.4	1
(ENM) 4100R/L	100	107	67	31.75 (32)	12.7 (14.4)	8 (8)	32 (28)	50	8.5	2.1	2
4125R/L	125	132	87	38.1 (40)	15.9 (16.4)	10 (9)	38 (30)	63	8.5	3.8	2
4160R/L	160	167	107	50.8 (40)	19.0 (16.4)	11 (9)	38 (30)	63	8.5	5.7	2
4200R/L	200	207	130	47.625 (60)	25.4 (25.7)	13.5 (14)	38 (38)	63	8.5	8.4	3
4250R/L	250	257	180	47.625 (60)	25.4 (25.7)	13.5 (14)	38 (38)	63	8.5	13.8	3
4315R/L	315	322	240	47.625 (60)	25.4 (25.7)	13.5 (14)	38 (38)	63	8.5	21.6	4

() Metric size

Available inserts

Designation	SNCN		SNKN		page
	Cermet	Coated	Uncoated		
SNCN 1204ENN	●				E21
SNKN 1204ENN			●		E23

Available arbors

Designation	General arbor	NC arbors	
		EN	ENM
EF 4080R/L	NT*□□ (M/U)-FMA25.4-25-□□	BT**□□ -FMA25.4-□□	FMC27
(EFM) 4100R/L	NT*□□ (M/U)-FMA31.75-□□	BT**□□ -FMA31.75-□□	FMC32
4125R/L	NT*□□ (M/U)-FMA38.1-□□	BT**□□ -FMA38.1-□□	FMB40
4160R/L	NT*□□ (M/U)-FMA50.8-□□	BT**□□ -FMA50.8-□□	FMB40
4200R/L	NT*□□ (M/U)-FMA47.625-25, KCP-8***	BT**□□ -FMA47.625-□□	FMB60
4250R/L	NT*□□ (M/U)-FMA47.625-25, KCP-8***	BT**□□ -FMA47.625-□□	FMB60
4315R/L	KCP-8*** (Center ring plug)		

*□□-NT number **□□-BT number ***Over milling 5

Recommended cutting condition

Workpiece	Cutting condition		Grades
	vc (m/min)	fz (mm/t)	
P	190~320	0.05~0.20	NCM325 PC3600 ST30A
	161~270	0.05~0.20	
	80~140	0.05~0.20	
M	90~150	0.05~0.20	PC9530
K	140~230	0.05~0.30	PC6510 G10
	50~90	0.05~0.30	

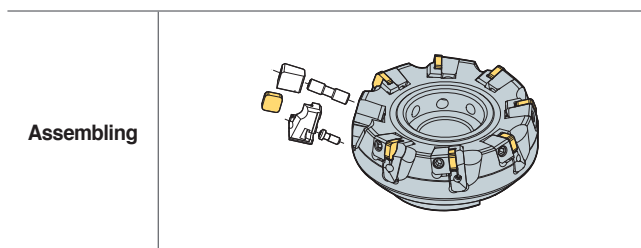

Parts

Specification	Locator	Wedge	Wedge screw	Locator screw	Wrench
Ø80-Ø315	LEN4R/L	WENR/L WENR1*L1*	DHA0830 DHA0825*	LTX0512	HW40

Available inserts E21, E23 Available arbors and bolt E400~E402

*: Ø80-Ø100



EPN(M)4000

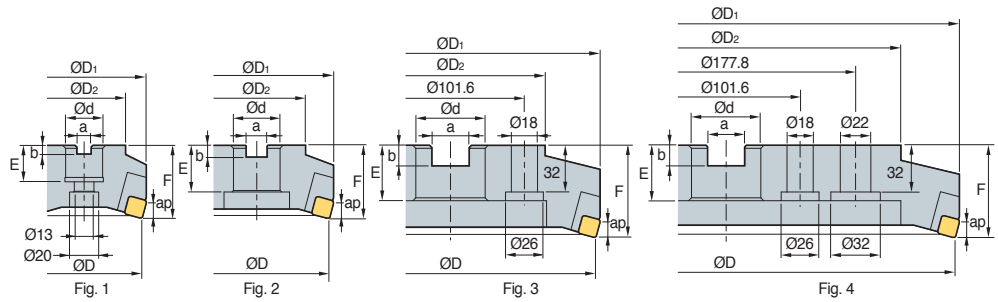

Designation	ØD	ØD1	ØD2	Ød	a	b	E	F	ap	kg	Fig.	
EPN 4080R/L	5	80	86	57	25.4 (27)	9.5 (12.4)	6 (7)	25 (22)	50	9	1.4	1
(EPNM) 4100R/L	6	100	107	67	31.75 (32)	12.7 (14.4)	8 (8)	32 (28)	50	9	2.1	2
4125R/L	8	125	132	87	38.1 (40)	15.9 (16.4)	10 (9)	38 (30)	63	9	3.8	2
4160R/L	10	160	166	107	50.8 (40)	19.0 (16.4)	11 (9)	38 (30)	63	9	5.7	2
4200R/L	12	200	206	130	47.625 (60)	25.4 (25.7)	14 (14)	38 (38)	63	9	8.2	3
4250R/L	16	250	256	180	47.625 (60)	25.4 (25.7)	14 (14)	38 (38)	63	9	13.5	3
4315R/L	20	315	321	240	47.625 (60)	25.4 (25.7)	14 (14)	38 (38)	63	9	21.1	4

() Metric size

Available inserts



Designation	Cermet		Coated							Uncoated		page				
	CN2000	CN30	NCM325	NCM335	NCS330	NCM535	NCM545	PC3600	PC3700	PC6510	PC9530		PC5300	PC5400	ST30A	G10
SPCN 1203EDR	●	●	●	●										●	●	●
1203EDL														●		
1203EDR-G																●
1203EDER-RH										●						
1203EDSR-RH										●						
1203EDTR-RH																
1203EDR-S20											●					
SPKN 1203EDSR-MU										●						
1203EDSR-SU										●	●					
1203EDSL-SU										●						
SPKR 1203EDSR-MX			●	●												
1203EDSL-MX																
SPEX 1203EDR/L-1																

Available arbors

Designation	General arbor	NC arbors	
		EPN	EPNM
EPN 4080R/L	NT*□□(M/U)-FMA25.4-25	BT**□□-FMA25.4-□□	FMC27
(EPNM) 4100R/L	NT*□□(M/U)-FMA31.75-□□	BT**□□-FMA31.75-□□	FMC32
4125R/L	NT*□□(M/U)-FMA38.1-□□	BT**□□-FMA38.1-□□	FMB40
4160R/L	NT*□□(M/U)-FMA50.8-□□	BT**□□-FMA50.8-□□	FMB40
4200R/L	NT*□□(M/U)-FMA47.625-25, KCP-8***	BT**□□-FMA47.625-□□	FMB60
4250R/L	NT*□□(M/U)-FMA47.625-25, KCP-8***	BT**□□-FMA47.625-□□	FMB60
4315R/L	KCP-8*** (Center ring plug)		

*□□-NT number **□□-BT number ***Over milling 5

Recommended cutting condition

Workpiece	Cutting condition		Grades
	vc (m/min)	fz (mm/t)	
P	190~320	0.05~0.20	NCM325 PC3600 ST30A
	161~270	0.05~0.20	
	80~140	0.05~0.20	
M	90~150	0.05~0.20	PC9530
K	140~230	0.05~0.30	PC6510 G10
	50~90	0.05~0.30	

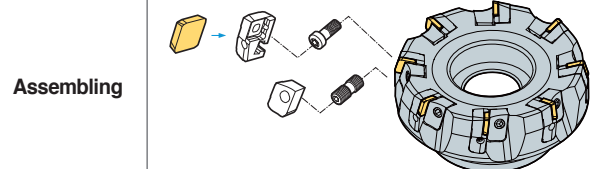

Parts

Specification	Locator	Wedge	Wedge screw	Locator screw	Wrench
Ø80~Ø315	LEPN4R/L LEPN4R1*/L1*	WEPN4R/L	DHA0821F DHA0817F*	LTX0514	HW40

*: Ø80~Ø100

Available inserts E24, E25 Available arbors and bolt E400~E402



EPN(M)5000+

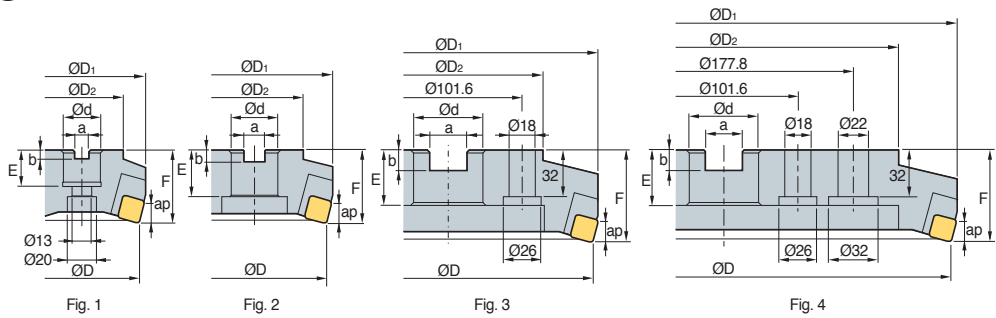

Designation	ØD	ØD1	ØD2	Ød	a	b	E	F	ap	kg	Fig.
EPN 5080R/L+	80	91	60	25.4 (27)	9.5 (12.4)	6 (7)	25 (22)	63	12	1.7	1
(EPNM) 5100R/L+	100	110	70	31.75 (32)	12.7 (14.4)	8 (8)	32 (28)	63	12	2.5	1
5125R/L+	125	134	90	38.1 (40)	15.9 (16.4)	10 (9)	38 (30)	63	12	3.8	2
5160R/L+	160	169	110	50.8 (40)	19.0 (16.4)	11 (9)	38 (30)	63	12	5.5	2
5200R/L+	200	209	150	47.625 (60)	25.4 (25.7)	14 (14)	38 (38)	63	12	8.0	3
5250R/L+	250	259	230	47.625 (60)	25.4 (25.7)	14 (14)	38 (38)	63	12	14.8	3
5315R/L+	315	324	270	47.625 (60)	25.4 (25.7)	14 (14)	38 (38)	63	12	22.4	4

() Metric size

Available inserts



Designation	Cermet		Coated							Uncoated		page					
	CN2000	CN30	NCM325	NC5330	NCM535	NCM545	PC2010	PC3600	PC3700	PC6510	PC9530		PC9540	PC5300	PC5400	ST30A	G10
SPCN 150412T																	
1504EDR	●	●													●	●	
1504EDSR																	
1504EDL									●								
1504EDR-G																	●
1504EDER-RH									●		●						
1504EDSR-RH									●								
1504EDTR-RH																	
1504EDR-S20										●							
SPKN 1504EDSR-MU									●								
1504EDSR-SU									●	●			●	●			
1504EDSL-SU									●								
SPKR 1504EDR-MX			●														
1504EDSR-MX																	
SPEX 1504EDR/L-1																	

Available arbors

Designation	General arbor	NC arbors	
		EPN	EPNM
EPN 5080R/L+	NT*□□(M/U)-FMA25.4-25	BT**□□-FMA25.4-□□	FMC27
(EPNM) 5100R/L+	NT*□□(M/U)-FMA31.75-□□	BT**□□-FMA31.75-□□	FMC32
5125R/L+	NT*□□(M/U)-FMA38.1-□□	BT**□□-FMA38.1-□□	FMB40
5160R/L+	NT*□□(M/U)-FMA50.8-□□	BT**□□-FMA50.8-□□	FMB40
5200R/L+	NT*□□(M/U)-FMA47.625-25, KCP-8***	BT**□□-FMA47.625-□□	FMB60
5250R/L+	NT*□□(M/U)-FMA47.625-25, KCP-8***	BT**□□-FMA47.625-□□	FMB60
5315R/L+	KCP-8*** (Center ring plug)		

*□□-NT number **□□-BT number ***Over milling 5

Recommended cutting condition

Workpiece	Cutting condition		Grades
	vc (m/min)	fz (mm/t)	
P	190~320 161~270 80~140	0.05~0.20 0.05~0.20 0.05~0.20	NCM325 PC3600 ST30A
M	90~150	0.05~0.20	PC9530
K	140~230 50~90	0.05~0.30 0.05~0.30	PC6510 G10

Assembling

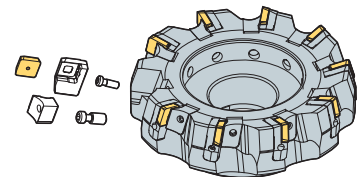

Parts

Specification	Locator	Wedge	Wedge screw	Locator screw	Wrench
Ø80~Ø315	LEPN5R/L LEPN5R1*/L1*	WHPS5R/L	WHX0817 WHX0813*	LTX0514	HW40

Available inserts E24, E25

Available arbors and bolt E400~E402

*: Ø80



PF(M)4000

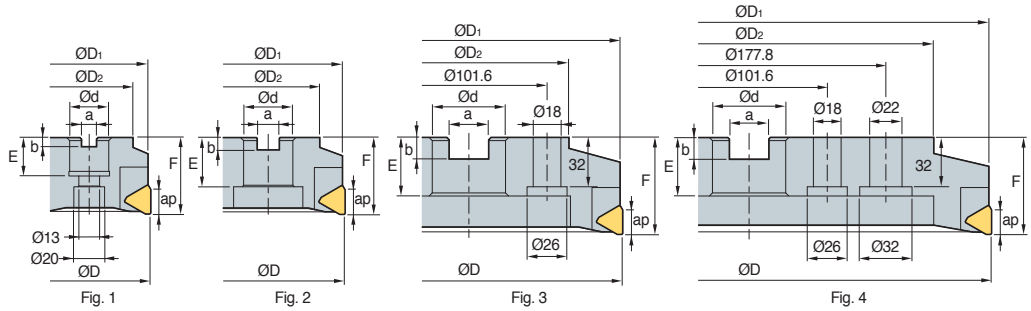

Designation	ØD	ØD1	ØD2	Ød	a	b	E	F	ap	kg	Fig.
PF 4080R/L	80	79	57	25.4 (27)	9.5 (12.4)	6 (7)	25 (22)	50	16	1.2	1
PF(M) 4100R/L	100	97	67	31.75 (32)	12.7 (14.4)	8 (8)	32 (28)	50	16	1.8	2
4125R/L	125	122	87	38.1 (40)	15.9 (16.4)	10 (9)	38 (30)	63	16	3.1	2
4160R/L	160	158	107	50.8 (40)	19.0 (16.4)	11 (9)	38 (30)	63	16	5.6	2
4200R/L	200	197	130	47.625 (60)	25.4 (25.7)	13.5 (14)	38 (38)	63	16	8.8	3
4250R/L	250	247	180	47.625 (60)	25.4 (25.7)	13.5 (14)	38 (38)	63	16	16	3
4315R/L	315	311	240	47.625 (60)	25.4 (25.7)	13.5 (14)	38 (38)	63	16	22	4

() Metric size

Available inserts

TFCN

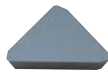

Designation	Cermet	Coated								Uncoated	page
	CN2000 CN30	NCM325 NC5330	NCM635 NCM645	PC2010 PC3600	PC3700 PC6510	PC9530 PC9540	PC5300 PC5400	ST30A G10 H01			
TFCN 2203PFR										E26	
2203PFL											

Available arbors

Designation	General arbor	NC arbors	
		PF	PFM
PF 4080R/L	NT*□□ (M/U)-FMA25.4-25	BT**□□ -FMA25.4-□□	FMC27
PF(M) 4100R/L	NT*□□ (M/U)-FMA31.75-□□	BT**□□ -FMA31.75-□□	FMC32
4125R/L	NT*□□ (M/U)-FMA38.1-□□	BT**□□ -FMA38.1-□□	FMB40
4160R/L	NT*□□ (M/U)-FMA50.8-□□	BT**□□ -FMA50.8-□□	FMB40
4200R/L	NT*□□ (M/U)-FMA47.625-25, KCP-8***	BT**□□ -FMA47.625-□□	FMB60
4250R/L	NT*□□ (M/U)-FMA47.625-25, KCP-8***	BT**□□ -FMA47.625-□□	FMB60
4315R/L	KCP-8*** (Center ring plug)		

*□□-NT number **□□-BT number ***Over milling 5

Recommended cutting condition

Workpiece	Cutting condition		Grades
	vc (m/min)	fz (mm/t)	
P	190~320	0.05~0.20	NCM325 PC3600 ST30A
	161~270	0.05~0.20	
	80~140	0.05~0.20	
M	90~150	0.05~0.20	PC9530 PC6510 G10
K	140~230	0.05~0.30	
	50~90	0.05~0.30	

Assembling

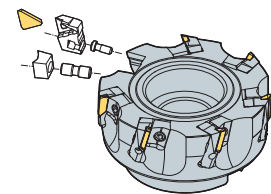

Parts

Specification	Locator	Wedge	Wedge screw	Locator screw	Wrench
Ø80~Ø315	LPF4R/L LPF4R1**/L1**	WPFR/L	DHA0821F DHA0817F*	LTX0512	HW40

*: Ø80~Ø100/ **: Ø80~Ø125

Available inserts E26 Available arbors and bolt E400~E402



PPN(M)4000

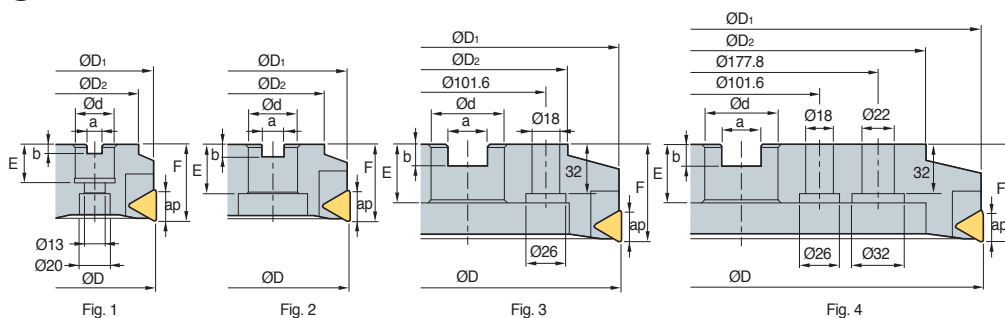

• AR: 7°
• RR: 0°

(mm)

Designation	ØD	ØD1	ØD2	Ød	a	b	E	F	ap	kg	Fig.	
PPN 4080R/L	5	80	79	57	25.4 (27)	9.5 (12.4)	6 (7)	25 (22)	50	18	1.3	1
(PPNM) 4100R/L	6	100	99	67	31.75 (32)	12.7 (14.4)	8 (8)	32 (28)	50	18	1.9	2
4125R/L	8	125	124	87	38.1 (40)	15.9 (16.4)	10 (9)	38 (30)	63	18	3.5	2
4160R/L	10	160	158	107	50.8 (40)	19.0 (16.4)	11 (9)	38 (30)	63	18	5.6	2
4200R/L	12	200	198	130	47.625 (60)	25.4 (25.7)	14 (14)	38 (38)	63	18	8.1	3
4250R/L	16	250	248	180	47.625 (60)	25.4 (25.7)	14 (14)	38 (38)	63	18	13.3	3
4315R/L	20	315	313	240	47.625 (60)	25.4 (25.7)	14 (14)	38 (38)	63	18	21.4	4

() Metric size

Available inserts

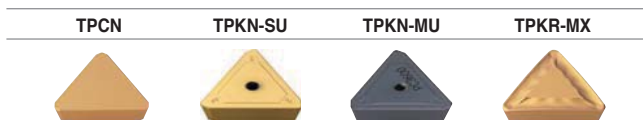

Designation	Cermet		Coated							Uncoated		page					
	CN2000	CN30	NCM325	NCM335	NC5330	NCM535	NCM545	PC3600	PC3700	PC6510	PC9530		PC9540	PC5300	PC5400	ST30A	G10
TPCN 2204PDR	●	●													●	●	
2204PDR-G																	●
2204PDL															●		
2204PDSR			●														
2204PDTR																	E26
2204PDR-RH																	
2204PDER-RH									●				●				
2204PDSR-RH										●							
2204PDR-S20											●						
TPKN 2204PDSR-MU								●									E27
2204PDSR-SU								●	●					●	●		
2204PDSL-SU								●									
TPKR 2204PDR-MX			●														E27
2204PDSR-MX			●	●													
2204PPR-MX																	

Available arbors

Designation	General arbor	NC arbors	
		PPN	PPNM
PPN 4080R/L	NT*□□ (MU)-FMA25.4-25	BT**□□-FMA25.4-□□	FMC27
(PPNM) 4100R/L	NT*□□ (MU)-FMA31.75-□□	BT**□□-FMA31.75-□□	FMC32
4125R/L	NT*□□ (MU)-FMA38.1-□□	BT**□□-FMA38.1-□□	FMB40
4160R/L	NT*□□ (MU)-FMA50.8-□□	BT**□□-FMA50.8-□□	FMB40
4200R/L	NT*□□ (MU)-FMA47.625-25, KCP-8***	BT**□□-FMA47.625-□□	FMB60
4250R/L	NT*□□ (MU)-FMA47.625-25, KCP-8***	BT**□□-FMA47.625-□□	FMB60
4315R/L	KCP-8*** (Center ring plug)		

*□□-NT number **□□-BT number ***Over milling 5

Recommended cutting condition

Workpiece	Cutting condition		Grades
	vc (m/min)	fz (mm/t)	
P	190~320	0.05~0.20	NCM325 PC3600 ST30A
	161~270	0.05~0.20	
	80~140	0.05~0.20	
M	90~150	0.05~0.20	PC9530
K	140~230	0.05~0.30	PC6510 G10
	50~90	0.05~0.30	

Assembling

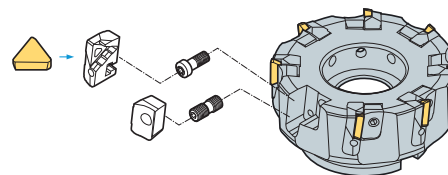

Parts

Specification	Locator	Wedge	Wedge screw	Locator screw	Wrench
Ø80~Ø315	LPPN4R/L LPPN4R1*/L1*	WPPN4R/L	DHA0821F DHA0817F*	LTX0514	HW40

Available inserts E26, E27

Available arbors and bolt E400~E402

*: Ø80~Ø100

Highly rigid inserts for roughing

Mill-max Heavy new

- Productivity - Cutting time is reduced by the cutting-edge design specialized for rough facing at high depth of cuts
- High rigidity - The highly rigid inserts and cutter seams prevent tool breakage in rough facing
- Clamping stability- The wedge-type clamping system, which is easy-to-use and strong, reduces time for replacing inserts, and improves clamping stability

Features of insert

- **Highly rigid inserts**
 - Ideally suited for roughing at high depth of cuts
- **Wide chip pocket area**
 - Improved chip evacuation
 - Reduced cutting loads
- **Minor cutting-edge**
 - Improved surface finish thanks to the wiper function

MAX. ap
 SCKN22: 10.5 mm
 SCKN28: 14.5 mm

- **Major cutting-edge**
 - High rake angle
- **2-level flank relief surface**
 - Relief angle availability even at high feed rates

Features of chip breakers

Insert	Cutting-edge	Uses	Features
MM		For roughing	Highly rigid chip breaker ideally suited for roughing at high depth of cuts

Features of cutter

- **Cutter seams**
 - Prevent cutter breakage even under harsh cutting conditions
- **Wide chip pockets**
 - Improve chip evacuation

Wedge-type clamping system

- Provides clamping stability
- Reduces time for replacing inserts

Recommended cutting condition

Workpiece	Grades	Cutting conditions			
		vc (m/min)	fz (mm/t)	ap (mm)	
P Low carbon steel/Mild steel	PC5300, NC5340	140~270	0.2~0.4	2.0~10.0 [SCKN22], 3.0~14.0 [SCKN28]	
	High carbon steel	PC5300, NC5340	100~220	0.2~0.4	2.0~10.0 [SCKN22], 3.0~14.0 [SCKN28]
	Alloy steel	PC5300, NC5340	100~180	0.2~0.4	2.0~10.0 [SCKN22], 3.0~14.0 [SCKN28]
M Stainless steel	PC5300, NC5340	90~180	0.2~0.4	2.0~10.0 [SCKN22], 3.0~14.0 [SCKN28]	
K Cast iron	PC5300, NC5340	100~180	0.2~0.4	2.0~10.0 [SCKN22], 3.0~14.0 [SCKN28]	



HDDCM 7000/9000 new

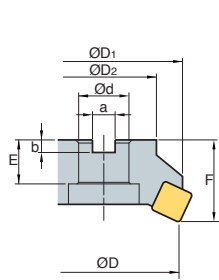

Fig. 1

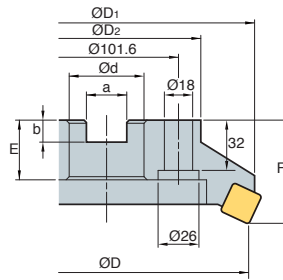

Fig. 2

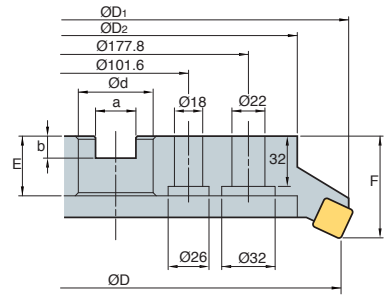

Fig. 3



(mm)

Designation		ØD	ØD1	ØD2	Ød	a	b	E	F	ap		Fig.	
HDDCM	7125R/L-5	5	125	135.6	90	40	16.4	9	32	63	10.5	3.43	1
	7160R/L-6	6	160	169.8	110	40	16.4	9	32	63	10.5	4.89	2
	7160R/L-8	8	160	169.8	110	40	16.4	9	32	63	10.5	4.62	2
	7200R/L-8	8	200	209.2	130	60	25.7	14	38	80	10.5	8.49	2
	7200R/L-10	10	200	209.2	130	60	25.7	14	38	80	10.5	8.74	2
	7250R/L-10	12	250	258.6	180	60	25.7	14	38	80	10.5	13.44	2
	7250R/L-12	10	250	258.6	180	60	25.7	14	38	80	10.5	13.41	2
	7315R/L-12	12	315	323.2	240	60	25.7	14	38	80	10.5	21.69	3
	7315R/L-14	14	315	323.2	240	60	25.7	14	38	80	10.5	21.41	3
HDDCM	9125R/L-5	5	125	140.4	90	40	16.4	9	32	63	14.5	3.4	1
	9160R/L-6	6	160	177.6	110	40	16.4	9	32	80	14.5	6.39	2
	9200R/L-8	8	200	213.6	130	60	25.7	14	38	80	14.5	8.76	2
	9250R/L-10	10	250	265	180	60	25.7	14	38	80	14.5	13.84	2
	9250R/L-12	12	250	265	180	60	25.7	14	38	80	14.5	13.41	2
	9315R/L-12	12	315	327.4	240	60	25.7	14	38	80	14.5	21.02	3

Available inserts

SCKN-MM



Type	Designation	Coated								page					
		CN2000	CN30	NCM825	NC5330	NCM535	NCM645	PC2010	PC3600		PC3700	PC6510	PC9530	PC9540	PC5300
7000 type	SCKN 220715DDSR-MM			●				●							E17
9000 type	SCKN 280920DDSR-MM														

Recommended cutting condition

Workpiece	Cutting condition		Grades
	vc (m/min)	fz (mm/t)	
P	140~270 100~220 100~180	0.2~0.4	PC5300 NC5340
M	90~180		
K	100~180		

Available arbors

Designation	General arbor
HDDCM	
7125R-5	NT*□□(M/U)-FMC40
7160R-6	
7160R-8	
7200R-8	NT*□□(M/U)-FMC60
7200R-10	
7250R-10	
7250R-12	
7315R-12	
7315R-14	NT*□□(M/U)-FMC40
9125R-5	
9160R-6	
9200R-8	
9250R-10	
9250R-12	
9315R-12	NT*□□(M/U)-FMC60

*□□-NT number **□□-BT number ***Over milling 5

Parts

Specification					
Ø125~Ø315 (7000 type)	WHD7R/L	WHX0817	SS64DPR	FTGA0614	HW40
Ø125~Ø315 (9000 type)	WHD9R/L	WHX0817	SS84DPR	FTGA0818	HW40

Available inserts **E17** Available arbors and bolt **E400~E402**

ADS4000

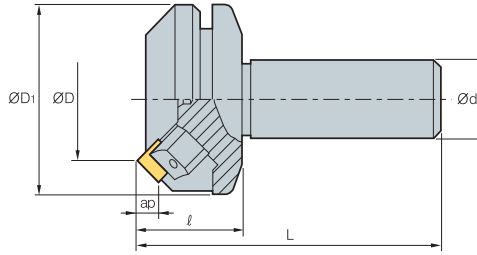

(mm)

Designation		ØD	ØD ₁	Ød	ℓ	L	ap	
ADS	4050R/L	3	50	75	32	40	120	1.8
	4050R/L-S42	3	50	75	42	40	120	2.2
	4063R/L	4	63	87	32	40	120	2.3
	4063R/L-S42	4	63	87	42	40	120	2.7

Available inserts

	SDCN	SDKN-MU	SDKN-SU	SDKR-MX		
Designation	Cermet	Coated			Uncoated	page
	CN2000 CN30	NCM325 NCM335 NC5330 NCM535 NCM545	PC3600 PC3700 PC6510 PC9530 PC9540 PC5300 PC5400	ST30A G10 H01		
SDCN 42M					●	
42M-G						●
42MT	●●	●			●	
42MT-RH						
42MT-S20				●		E17
1203AEEN						
1203AEEN-RH						
1203AESN						
1203AESN-RH						
SDKN 1203AESN-MU			●			E18
1203AESN-SU			●●	●●		
SDKR 1203AESN-MX						
1203AETN-MX						E18
1203AEN-MX		●				

Recommended cutting condition

Workpiece	Cutting condition		Grades
	vc (m/min)	fz (mm/t)	
P	190~320	0.05~0.20	NCM325 PC3600 ST30A
	161~270	0.05~0.20	
	80~140	0.05~0.20	
M	90~150	0.05~0.20	PC9530
K	140~230	0.05~0.30	PC6510 G10
	50~90	0.05~0.30	

Assembling

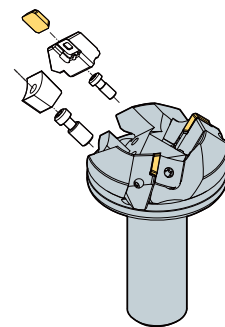

Parts

Specification					
Ø50-Ø63	LASS4R/L	WASR/L	WTX0817	LTX0512	TW25

Available inserts E17, E18

ADS5000

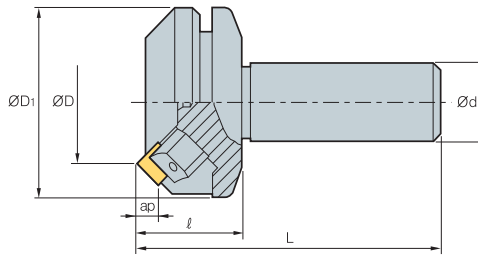

AA
45°
• AR: 15°
• RR: -3°

(mm)

Designation		ØD	ØD1	Ød	ℓ	L	ap	
ADS	5050R/L	3	50	75	32	40	120	1.9
	5050R/L-S42	3	50	75	42	40	120	2.3
	5063R/L	4	63	87	32	40	120	2.4
	5063R/L-S42	4	63	87	42	40	120	2.8

Available inserts

SDCN	SDKN-MU	SDKN-SU	SDKR-MX						
Designation	Cermet	Coated						Uncoated	page
	CN2000 CN30	NCM325 NCM335 NC5330	NCM535 NCM545	PC3600 PC3700 PC6510	PC9530 PC9540	PC5300 PC5400	ST30A G10 H01		
SDCN 53M							●		
53M-G								●	
53MT	●	●					●		
53MT-RH									
53MT-S20					●			E17	
1504AEEN									
1504AEEN-RH				●		●			
1504AESN									
1504AESN-RH				●					
SDKN 1504AESN-MU				●				E18	
1504AESN-SU				●	●		●		
SDKR 1504AESN-MX		●							
1504AETN-MX								E18	
1504AEN-MX	●								

Recommended cutting condition

Workpiece	Cutting condition		Grades
	vc (m/min)	fz (mm/t)	
P	190~320	0.05~0.20	NCM325 PC3600 ST30A
	161~270	0.05~0.20	
	80~140	0.05~0.20	
M	90~150	0.05~0.20	PC9530
K	140~230	0.05~0.30	PC6510 G10
	50~90	0.05~0.30	

Assembling

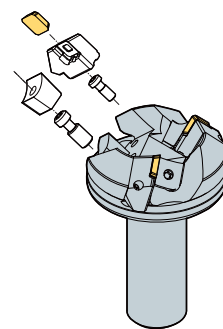

Parts

Specification					
Ø50~Ø63	LASS5R/L	WASR/L	WTX0817	LTX0512	TW25

Available inserts E17, E18

PES2000/3000/4000

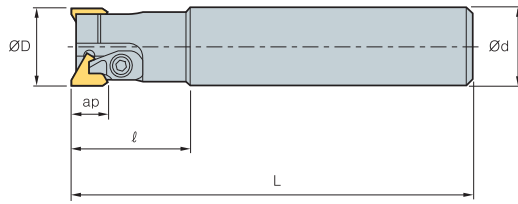

Fig. 1

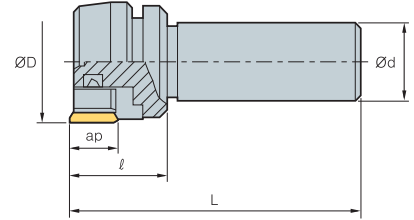

Fig. 2



(mm)

Designation		ØD	Ød	ℓ	L	ap		Fig.
PES	2020R/L	2	20	20	30	110	0.3	1
	2025R/L	2	25	25	35	120	0.5	1
	3030R/L	2	30	32	45	160	0.9	1
	3032R/L	2	32	32	45	160	1.0	1
	3033R/L	2	33	32	45	160	1.1	1
	3035R/L	2	35	32	45	160	1.2	1
	3036R/L	2	36	32	45	160	1.3	1
	3040R/L	2	40	32	45	160	1.4	1
	4050R/L	3	50	32	40	120	1.2	2
	4050R/L-S42	3	50	42	40	120	1.5	2
	4063R/L	4	63	32	40	120	1.5	2
	4063R/L-S42	4	63	42	40	120	1.8	2

Available inserts

		TECN	TEEN														
Designation		Cermet		Coated								Uncoated		page			
		CN2000	CN30	NCM325	NCM335	NC5330	NCM535	NCM545	PC3600	PC6510	PC9530	PC9540	PC5300		PC5400	ST30A	G10
2000 type	TECN 22R																
	22TR		●												●		E26
3000 type	TECN 32R														●		
	32TR		●	●											●		E26
	32TR-S20									●							
4000 type	TEEN 43R														●		
	43R-G														●		
	43TR		●	●	●					●					●		
	43TR-S20										●						E26
	43TR-Z														●		
	43TR-ZH										●						

Recommended cutting condition

Workpiece	Cutting condition		Grades
	vc (m/min)	fz (mm/t)	
P	190~320	0.05~0.20	NCM325 PC3500 ST30A
	161~270	0.05~0.20	
	80~140	0.05~0.20	
M	90~150	0.05~0.20	PC9530
K	140~230	0.05~0.30	PC6510 G10
	50~90	0.05~0.30	

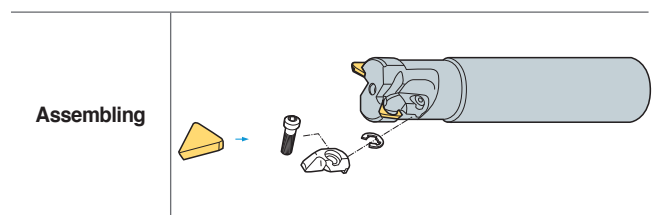

Parts

Specification								
Ø20~Ø25 (2000 type)	-	-	-	CHX0407	HW25L	-	CH4R1	ER03
Ø30~Ø40 (3000 type)	-	-	-	CHX0510	HW30L	-	CH5R1	ER04
Ø50~Ø63 (4000 type)	LPTS4R/L	WPTSR	DHA0815	LTX0512	-	HW40	-	-

Available inserts E26



AFO(M)4000

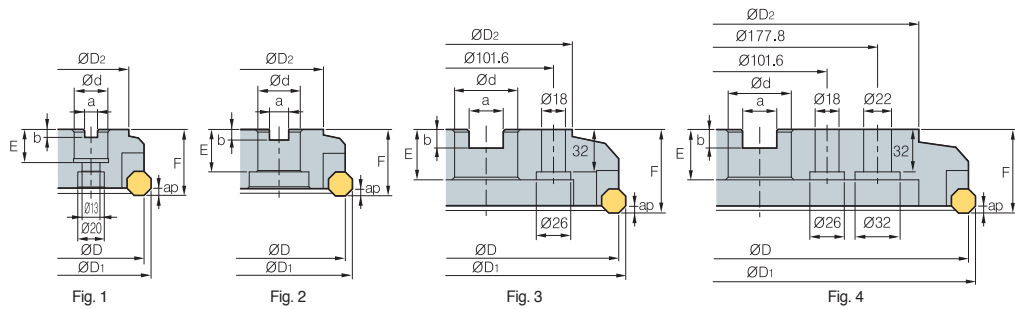

(mm)

Designation		ØD	ØD1	ØD2	Ød	a	b	E	F	ap		Fig.
AFO 4080R/L	5	80	88	60	25.4 (27)	9.5 (12.4)	6 (7)	25 (22)	50	3.3	1.4	1
(AFOM) 4100R/L	6	100	108	80	31.75 (32)	12.7 (14.4)	8 (8)	32 (28)	50	3.3	2.0	1
4125R/L	8	125	133	100	38.1 (40)	15.9 (16.4)	10 (9)	38 (30)	63	3.3	3.1	1

() Metric size

Available inserts

	OFCW	OFKT-MF	OFKT-MM	OFKT-MA					
Designation	Cermet	Coated						Uncoated	page
	CN2000 CN30	NCM325 NC5330 NCM535 NCM545	PC2010 PC3600 PC3700 PC6510 PC9530 PC9540 PC5300 PC5400	ST30A G10 H01					
OFCW 05T3SN								E13	
05T3FN									
05T308FN									
OFKT 05T3SN-MF								E13	
05T308SN-MF									
05T3SN-MM								E13	
05T308SN-MM								E14	
05T3FN-MA									
05T3EN-MA									

Available arbors

Designation	General arbor	NC arbors	
		AFO	AFOM
AFO 4080R/L	NT*□□ (M/U)-FMA25.4-25	BT**□□ -FMA25.4-□□	FMC27
(AFOM) 4100R/L	NT*□□ (M/U)-FMA31.75-□□	BT**□□ -FMA31.75-□□	FMC32
4125R/L	NT*□□ (M/U)-FMA38.1-□□	BT**□□ -FMA38.1-□□	FMB40

*□□-NT number **□□-BT number ***Over milling 5

Recommended cutting condition

Workpiece	Cutting condition		Grades
	vc (m/min)	fz (mm/t)	
P	190~320	0.05~0.20	NCM325 PC3500 ST30A
	161~270	0.05~0.20	
	80~140	0.05~0.20	
M	90~150	0.05~0.20	PC9530
K	140~230	0.05~0.30	PC6510 G10
	50~90	0.05~0.30	

Assembling

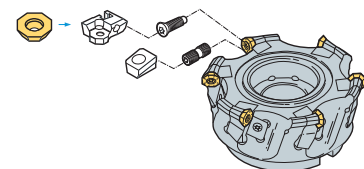

Parts

Specification					
Ø80~Ø125	LAF04R/L	WAF04R/L	DHA0815	FTKA0408	TW15S

Available inserts E13, E14

Available arbors and bolt E400~E402

AFO(M)5000

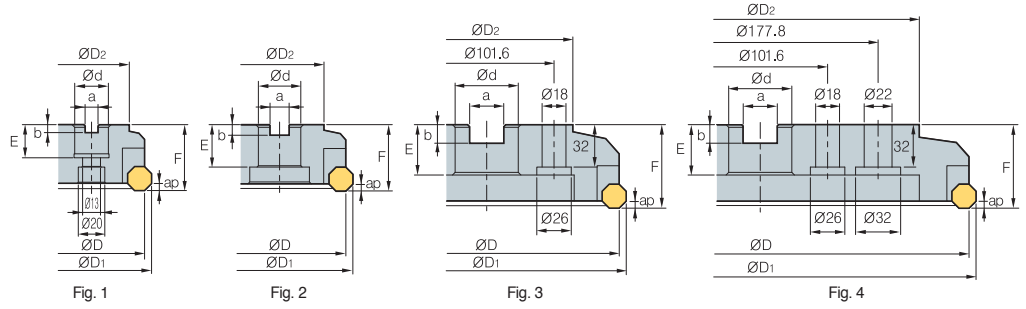

(mm)

Designation		ØD	ØD ₁	ØD ₂	Ød	a	b	E	F	ap		Fig.	
AFO	5080R/L	5	80	91	60	25.4 (27)	9.5 (12.4)	6 (7)	25 (22)	50	4.8	1.4	1
(AFOM)	5100R/L	6	100	111	80	31.75 (32)	12.7 (14.4)	8 (8)	32 (28)	50	4.8	2.0	2
	5125R/L	8	125	136	100	38.1 (40)	15.9 (16.4)	10 (9)	38 (30)	63	4.8	3.1	2
	5160R/L	10	160	171	120	50.8 (40)	19.0 (16.4)	11 (9)	38 (30)	63	4.8	5.2	2
	5200R/L	12	200	211	130	47.625 (60)	25.4 (25.7)	13.5 (14)	38 (38)	63	4.8	7.5	3
	5250R/L	16	250	261	180	47.625 (60)	25.4 (25.7)	13.5 (14)	38 (38)	63	4.8	16.1	3
	5315R/L	20	315	326	240	47.625 (60)	25.4 (25.7)	13.5 (14)	38 (38)	63	4.8	22.8	4

() Metric size

Available inserts

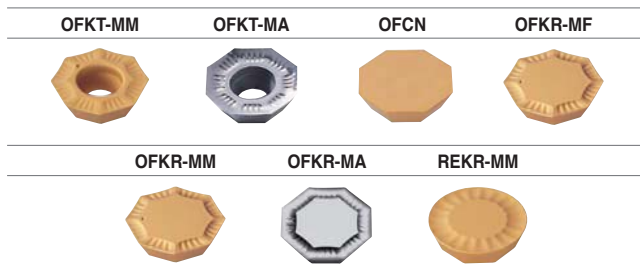

Designation	Cermet		Coated							Uncoated		page						
	CN2000	CN30	NCM325	NCM335	NC5330	NCM535	NCM545	PC3600	PC3700	PC6510	PC9530		PC3940	PC5300	PC5400	ST30A	G10	H01
OFCN									●									E13
0704SN																		
0704FN																		
070408SN																		
OFKR																		E13
0704SN-MM			●	●						●	●		●					
070408SN-MM			●															
0704FN-MA																	●	
OFKT																		E13
0704SN-MM																		
0704FN-MA																	●	
REKR																		E16
170400-MM																		

Available arbors

Designation	General arbor	NC arbors	
		AFO	AFOM
AFO	5080R/L NT*□□ (M/U)-FMA25.4-25	BT**□□ -FMA25.4-□□	FMC27
(AFOM)	5100R/L NT*□□ (M/U)-FMA31.75-□□	BT**□□ -FMA31.75-□□	FMC32
	5125R/L NT*□□ (M/U)-FMA38.1-□□	BT**□□ -FMA38.1-□□	FMB40
	5160R/L NT*□□ (M/U)-FMA50.8-□□	BT**□□ -FMA50.8-□□	FMB40
	5200R/L NT*□□ (M/U)-FMA47.625-25, KCP-8***	BT**□□ -FMA47.625-□□	FMB60
	5250R/L NT*□□ (M/U)-FMA47.625-25, KCP-8***	BT**□□ -FMA47.625-□□	FMB60
	5315R/L KCP-8*** (Center ring plug)		

*□□-NT number **□□-BT number ***Over milling 5

Recommended cutting condition

Workpiece	Cutting condition		Grades
	vc (m/min)	fz (mm/t)	
P	190~320 161~270 80~140	0.05~0.20 0.05~0.20 0.05~0.20	NCM325 PC3500 ST30A
M	90~150	0.05~0.20	PC9530
K	140~230 50~90	0.05~0.30 0.05~0.30	PC6510 G10

Assembling

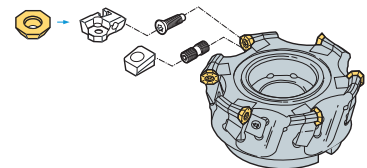

Parts

Specification					
Ø80~Ø315	LAF05R/L LAF05R*/L-1*	WEFR/L	DHA0821F	LTX0512	HW40

*: Ø80~Ø100

Available inserts E13, E16 Available arbors and bolt E400~E402



New serrated edge design increases productivity by reducing insert cutting load

Power Buster

- New tooling utilizing a specially designed serrated edge to increase productivity by reducing the cutting load.
- Double-sided 6 corner insert geometry ensures high rigidity, long tool life and cost efficiency
- The serrated edge divides the chips into smaller pieces. This feature provides excellent chip control, reduces interference of the cutter and ensures good durability of the cutter body.
- Two types of inserts are available-TNMX27 for PBA (Approach angle: 45°) and PBZ (AA: 80°), and TNMX30 for PBP (AA: 90°)
- Application: High depth of cut and feed rate (Steel, Cast iron)

Code system

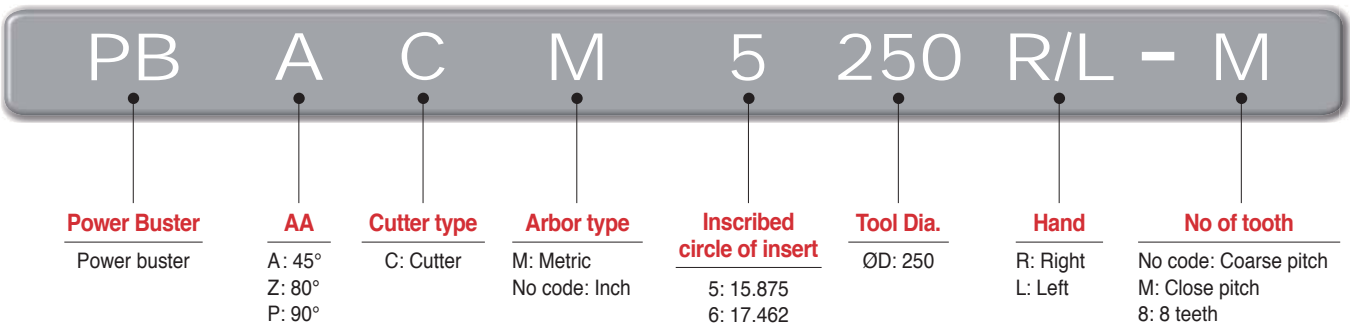

Features of insert

1 Major cutting-edge (Serrated edge)

- Low cutting force
- Ideal for chip control, divides chips into small pieces for proper chip evacuation.
- Ideal edge design for Steel and Cast iron rough milling

Comparison of chip control and cutting force

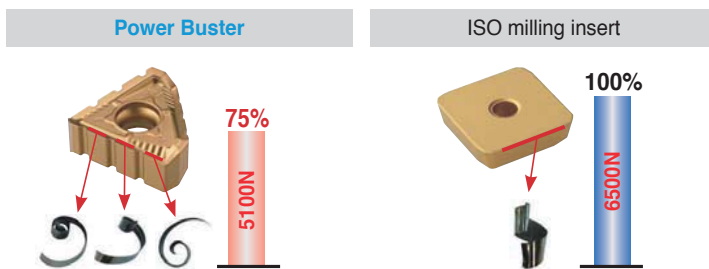

- **Workpiece** SCM440
- **Cutting condition** vc = 200 m/min, ap = 8 mm, ae = 90 mm, fz = 0.3 mm/t

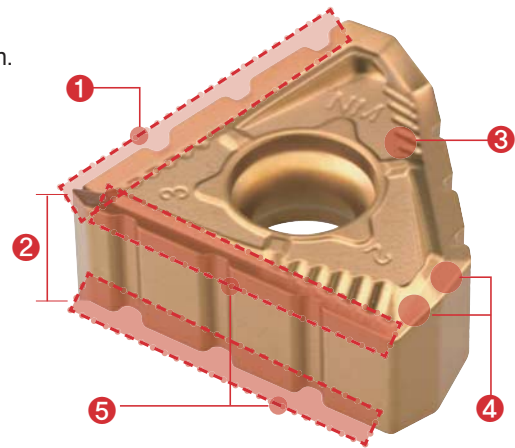

2 Thicker insert

- Thick insert guarantees high rigidity
- Balanced insert design for stable mounting

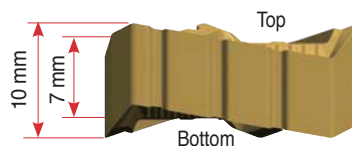

3 NM Chip breaker

- High rake angle for low cutting force
- Good chip flow at various feed and depth of cut
- Inserts are protected with seats for a precise mounting
- Low friction and good heat evacuation at high depth cut

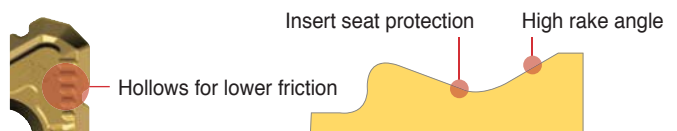

E Technical Information for Power Buster

4 Insert shape applied to PBA/Z cutters (AA: 45°/80°)

- High rake angle to avoid interference with chip
- Calculated minor cutting-edge angel for both AA 45° & 80° cutter

2nd minor cutting-edge for AA 80° 1st minor cutting-edge for AA 45°

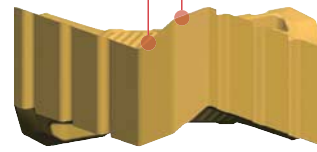

5 Mirror system

- Cutting-edge on the both side of insert covers all overlapped cutting area

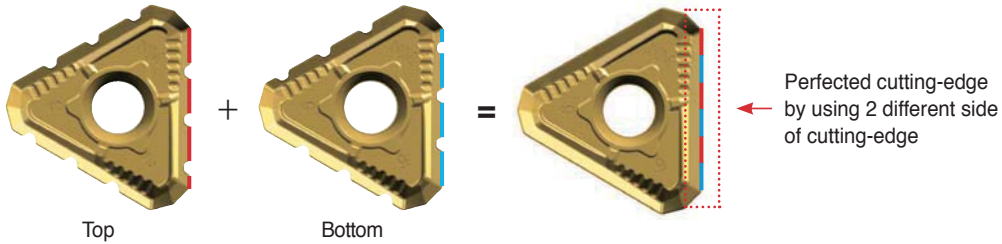

6 Features of cutter

1 Screw-on clamping system

- Simple and strong screw on clamping system

2 Better rigidity & Stable Assembly system

- The shim protects the cutter from insert damage
- High accuracy shim ensures tighter clamping

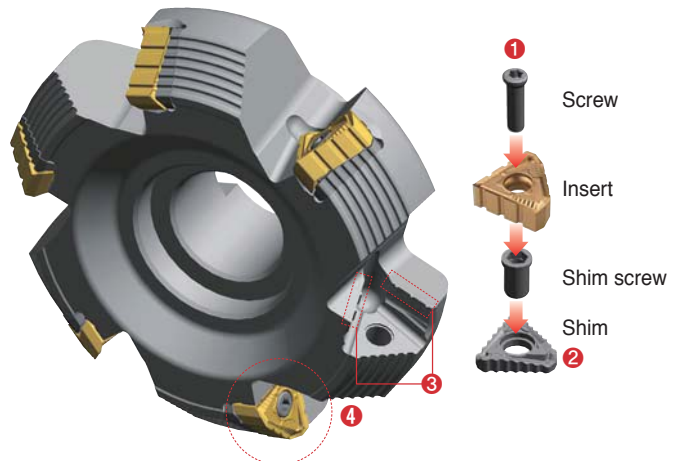
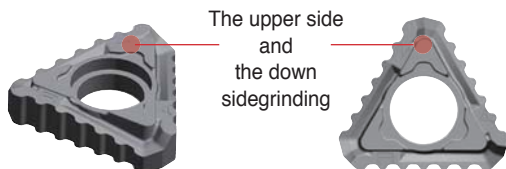

3 Foolproof System

- Insert serrations match pocket design to prevent improper seating and alignment

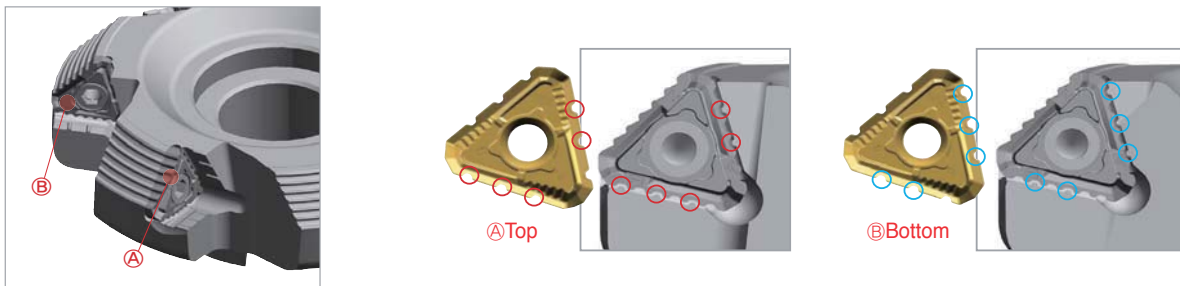

4 Multi-application system

- Same insert for multi-use (45° and 80°)

■ PBA/PBZ

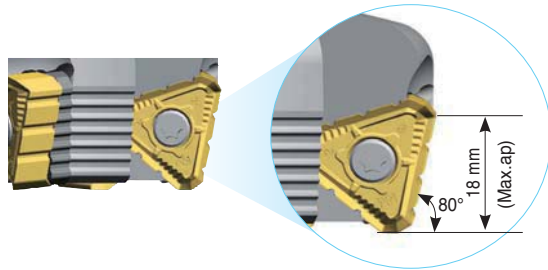
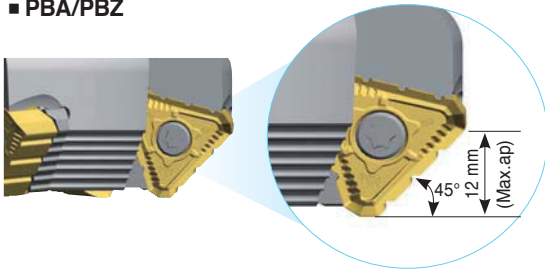

The serrations are effective with a depth of cut larger than 1 mm

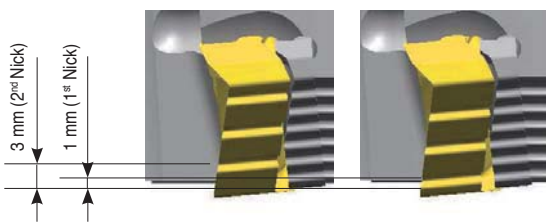

The serrations are effective with a depth of cut larger than 3 mm

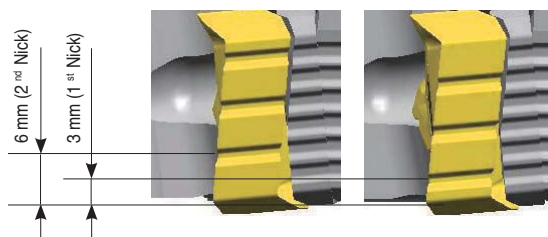

■ PBP

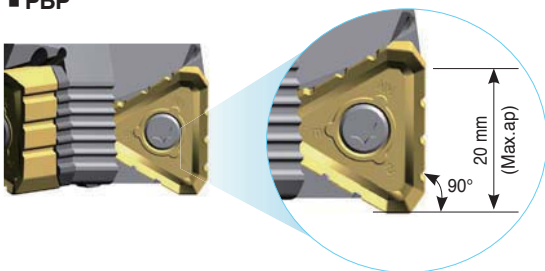

For the AA 90° cutter, nicks function properly at depth of cuts over 5 mm

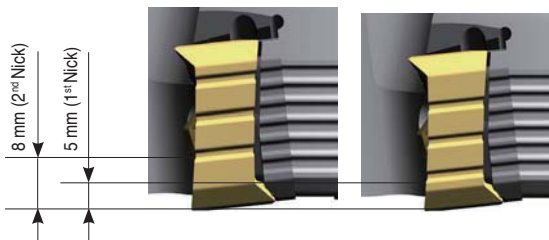

Recommended cutting condition

ISO	Workpiece	Material	NC5330	NCM335	PC5300	
			fz (mm/t)			
			0.1-0.2-0.3	0.1-0.2-0.3	0.1-0.2-0.3	
			vc (m/min)			
P	Carbon steel	-	SUM22, C = 0.1~25	400	335	280
		-	C = 0.30~55	365	305	255
		-	C = 0.55~80	340	285	240
	Low alloy steel (Alloy constituent < 5%)	-	SCM415(H), SCM420, SCM440	280	235	195
		Hardened		165	140	115
		High alloy steel (Alloy constituent > 5%)	Annealed	SKD61	210	180
	Hardened	SKH51, SKH55	175	145	120	
K	Gray cast iron	Low tensile	FC200, FC250	125	-	145
		Hight tensile	FC300, FC350	105	-	120
		Ferric	FCD400, FCD500	80	-	95
		Pearlitic	FCD600, FCD700	75	-	85

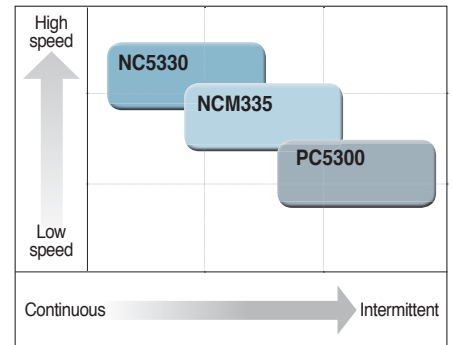

Power Buster test

■ Cylinder block for ship engine (Cast iron)

Cutting width (ae) = 160 mm × 2

Cutting depth (ap) = 10 mm × 2

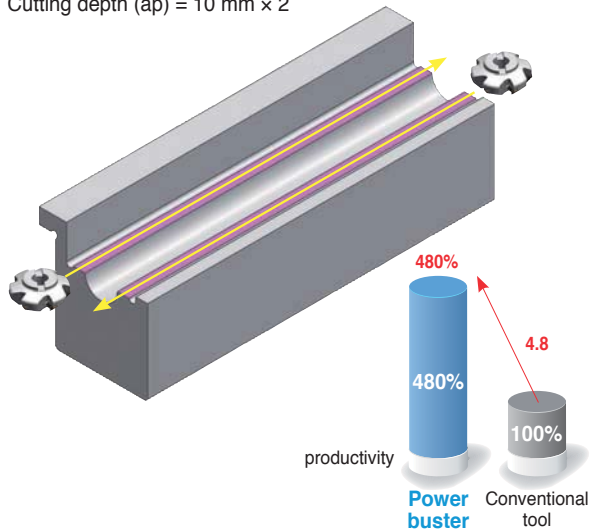

Item	Power buster	Conventional tool
Diameter (ØD)	200 mm	200 mm
	12 tooth	12 tooth
Grades	NC5330	PVD coating for Cast iron
vc	170 m/min	130 m/min
fz	0.24 mm/t	0.16 mm/t
ap	10 mm x 2 passes	4 mm x 5 passes
min	28.2 min/ea	137.5 min/ea
4.8 times productivity increased		<ul style="list-style-type: none"> • One-sided 4 corner insert (Without nick) • AA 45° cutter

■ Heavy machinery part (Alloy steel)

Cutting width (ae) = 160 mm × 2

Cutting depth (ap) = 10 mm × 2

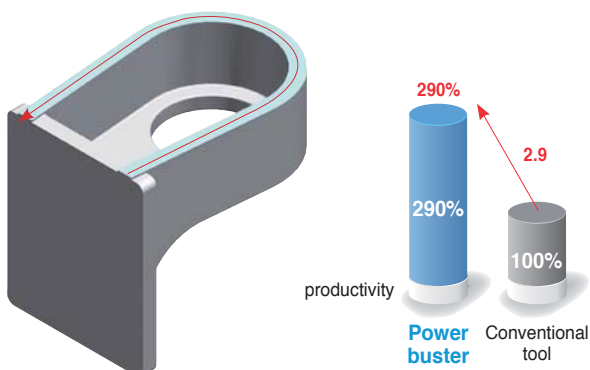

Item	Power Buster	Conventional tool
Diameter (ØD)	125 mm	100 mm
	8 tooth	8 tooth
Grades	NCM335	PVD coating for Cast iron
vc	180 m/min	150 m/min
fz	0.15 mm/t	0.10 mm/t
ap	5 mm x 2 passes	2.5 mm x 4 passes
min	5 min/ea	14.7 min/ea
2.9 times productivity increased		<ul style="list-style-type: none"> • Double-sided 8 corner insert (Without nick) • AA 45° cutter



PBAC(M)5000

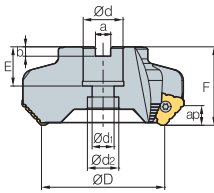

Fig. 1

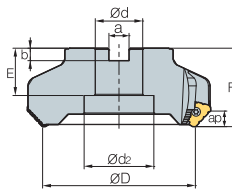

Fig. 2

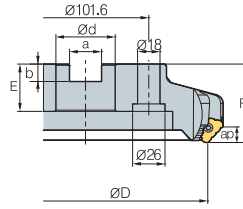

Fig. 3

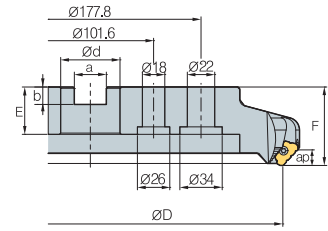

Fig. 4



AA
45°

• AR: -5°
• RR: -11°

(mm)

Designation		⊙	ØD	Ød	Ød1	Ød2	a	b	E	F	ap	Fig.
Coarse pitch	PBAC (PBACM) 5080R/L	4	80	25.4 (27)	14	20	9.5 (12.4)	6 (7)	25 (22)	50	12	1
	5100R/L	4	100	31.75 (32)	-	45	12.7 (14.4)	8 (8)	32 (28)	50	12	2
	5125R/L	6	125	38.1 (40)	-	56	15.9 (16.4)	10 (9)	38 (32)	63	12	2
	5160R/L	8	160	50.8 (40)	-	100	19 (16.4)	11 (9)	38 (32)	63	12	2
	5200R/L	10	200	47.625 (60)	-	-	25.4 (25.7)	14 (14)	38 (38)	63	12	3
	5250R/L	12	250	47.625 (60)	-	-	25.4 (25.7)	14 (14)	38 (38)	63	12	3
5315R/L	14	315	47.625 (60)	-	-	25.4 (25.7)	14 (14)	38 (38)	63	12	4	
Close pitch	PBAC (PBACM) 5080R/L-M	6	80	25.4 (27)	14	20	9.5 (12.4)	6 (7)	25 (22)	50	12	1
	5100R/L-M	6	100	31.75 (32)	-	45	12.7 (14.4)	8 (8)	32 (28)	50	12	2
	5125R/L-M	8	125	38.1 (40)	-	56	15.9 (16.4)	10 (9)	38 (32)	63	12	2
	5160R/L-M	10	160	50.8 (40)	-	100	19 (16.4)	11 (9)	38 (32)	63	12	2
	5200R/L-M	12	200	47.625 (60)	-	-	25.4 (25.7)	14 (14)	38 (38)	63	12	3
	5250R/L-M	14	250	47.625 (60)	-	-	25.4 (25.7)	14 (14)	38 (38)	63	12	3
5315R/L-M	16	315	47.625 (60)	-	-	25.4 (25.7)	14 (14)	38 (38)	63	12	4	

() Metric size

Available inserts

TNMX-NM



Designation	Cermet		Coated											Uncoated			page		
	CN2000	CN30	NCM325	NC5330	NCM535	NCM545	PC2505	PC2010	PC3600	PC3700	PC6510	PC9530	PC9540	PC5300	PC5400	ST30A		G10	H01
TNMX 2710AZNR-NM				●	●					●		●							E26
2710AZNL-NM																			

Available arbors

Designation	Available arbors	
	PBAC	PBACM
PBAC (PBACM) 5080R/L-□	BT□□-FMA25.4-□□	BT□□-FMC27-□□
5100R/L-□	BT□□-FMA31.75-□□	BT□□-FMC32-□□
5125R/L-□	BT□□-FMA38.1-□□	BT□□-FMB40-□□
5160R/L-□	BT□□-FMA50.8-□□	BT□□-FMC40-□□
5200R/L-□		
5250R/L-□	BT□□-FMA47.625-□□	BT□□-FMB60-□□
5315R/L-□		

Parts

Specification				
Ø80-Ø315	FTGA0518	ST53AZR	SHXN0712F	TW20-100

Available inserts E26

Available arbors and bolt E400~E402

PBZC(M)5000

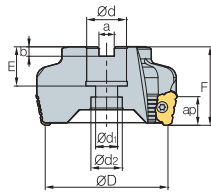

Fig. 1

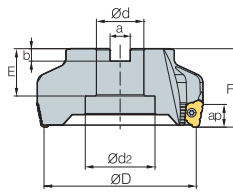

Fig. 2

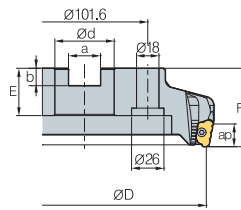

Fig. 3

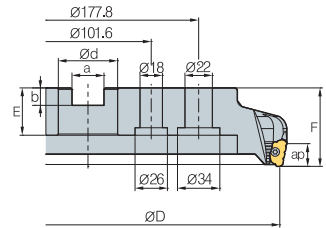

Fig. 4



AA
80°

• AR: -5°
• RR: -12°

(mm)

Designation		⊙	ØD	Ød	Ød ₁	Ød ₂	a	b	E	F	ap	Fig.
Coarse pitch	PBZC (PBZCM) 5080R/L	4	80	25.4 (27)	14	20	9.5 (12.4)	6 (7)	25 (22)	50	18	1
	5100R/L	4	100	31.75 (32)	-	45	12.7 (14.4)	8 (8)	32 (28)	50	18	2
	5125R/L	6	125	38.1 (40)	-	56	15.9 (16.4)	10 (9)	38 (32)	63	18	2
	5160R/L	8	160	50.8 (40)	-	100	19 (16.4)	11 (9)	38 (32)	63	18	2
	5200R/L	10	200	47.625 (60)	-	-	25.4 (25.7)	14 (14)	38 (38)	63	18	3
	5250R/L	12	250	47.625 (60)	-	-	25.4 (25.7)	14 (14)	38 (38)	63	18	3
	5315R/L	14	315	47.625 (60)	-	-	25.4 (25.7)	14 (14)	38 (38)	63	18	4
Close pitch	PBZC (PBZCM) 5080R/L-M	6	80	25.4 (27)	14	20	9.5 (12.4)	6 (7)	25 (22)	50	18	1
	5100R/L-M	6	100	31.75 (32)	-	45	12.7 (14.4)	8 (8)	32 (28)	50	18	2
	5125R/L-M	8	125	38.1 (40)	-	56	15.9 (16.4)	10 (9)	38 (32)	63	18	2
	5160R/L-M	10	160	50.8 (40)	-	100	19 (16.4)	11 (9)	38 (32)	63	18	2
	5200R/L-M	12	200	47.625 (60)	-	-	25.4 (25.7)	14 (14)	38 (38)	63	18	3
	5250R/L-M	14	250	47.625 (60)	-	-	25.4 (25.7)	14 (14)	38 (38)	63	18	3
	5315R/L-M	16	315	47.625 (60)	-	-	25.4 (25.7)	14 (14)	38 (38)	63	18	4

() Metric size

Available inserts

TNMX-NM



Designation	Cermet		Coated										Uncoated			page			
	CN2000	CN30	NCM325	NC5330	NCM535	NCM545	PC2505	PC2010	PC3600	PC3700	PC6510	PC9530	PC9540	PC5300	PC5400		ST30A	G10	H01
TNMX 2710AZNR-NM 2710AZNL-NM				●	●					●		●		●					E26

Available arbors

Designation	Available arbors	
	PBZC	PBZCM
PBZC (PBZCM) 5080R/L-□	BT□□-FMA25.4-□□	BT□□-FMC27-□□
5100R/L-□	BT□□-FMA31.75-□□	BT□□-FMC32-□□
5125R/L-□	BT□□-FMA38.1-□□	BT□□-FMB40-□□
5160R/L-□	BT□□-FMA50.8-□□	BT□□-FMC40-□□
5200R/L-□	BT□□-FMA47.625-□□	BT□□-FMB60-□□
5250R/L-□		
5315R/L-□		

Parts

Specification	 Screw	 Shim	 Shim Screw	 Wrench
Ø80~Ø315	FTGA0518	ST53AZR	SHXN0712F	TW20-100

Available inserts E26 Available arbors and bolt E400~E402



PBPCM6000 new

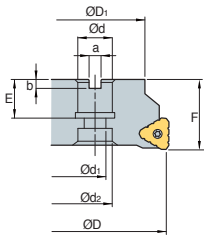

Fig. 1

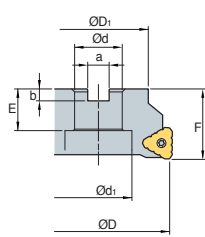

Fig. 2

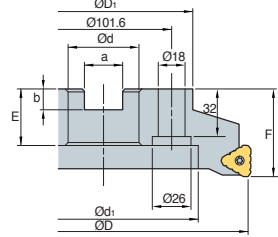

Fig. 3

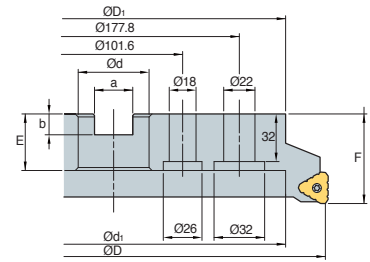

Fig. 4



AA
90°

- AR: -5°
- RR: -12°

(mm)

Designation		ØD	ØD1	Ød	Ød2	Ød2	a	b	E	F	ap		Fig.
PBPCM													
6080R-4	4	80	60	27	14	20	12.4	7	24	50	20	0.85	1
6100R-6	6	100	70	32	-	54	14.4	8	30	50	20	1.16	2
6125R-6	6	125	90	40	-	56	16.4	9	32	63	20	2.84	2
6160R-8	8	160	107	40	-	90	16.4	9	32	63	20	3.58	3
6200R-10	10	200	130	60	-	132	25.7	14	38	63	20	5.13	3
6250R-12	12	250	180	60	-	180	25.7	14	38	63	20	9.6	3
6315R-14	14	315	240	60	-	238	25.7	14	38	63	20	16.85	4

Available inserts

TNMX-NM



Designation	Cermet		Coated											Uncoated			page		
	CN2000	CN30	NCM325	NC5330	NCM535	NCM545	PC2505	PC2010	PC3600	PC3700	PC8510	PC9530	PC9540	PC5300	PC5400	ST30A		G10	H01
TNMX	3012PNR-NM																		E26

Available arbors

Designation	General arbor
PBPCM	
6080R-4	BT□□ -FMC27-□□
6100R-6	BT□□ -FMC32-□□
6125R-6	
6160R-8	BT□□ -FMC40-□□
6200R-10	
6250R-12	BT□□ -FMC60-□□
6315R-14	

Parts

Specification				
Ø80-Ø315	FTGA0518	ST53PNR	SHXN0712F	TW20-100

Available inserts **E26** Available arbors and bolt **E400~E402**



E Technical Information for Rich Mill

Rich Mill series is one of innovations that provides more available cutting-edges by double-sided insert and longer tool life for our customers

Rich Mill Series

- Rich Mill series is one of the innovations that provides more available cutting-edges with double-sided inserts and longer tool life for our customers
- The unique geometry and special cutting-edge guarantees low cutting loads and long tool life
- Rich Mill series has a wide application range from steel and stainless steel to cast iron and aluminum
- Applying negative inserts makes it even stronger and provides longer tool life
- Rich Mill series has both screw-on clamping system and latch clamping system

Code system

RM16	A	C	M	4	100	H	R - M	
Number of edges	Approach angle	Tool type	Arbors type	Inscribed circle of insert	Tool Dia.	Coolant type	Hand	Pitch type
RM3: Number of edges-3 RM4: Number of edges-4 RM6: Number of edges-6 RM8: Number of edges-8 RMH8: Number of edges-8 (Shim) RMT8: Number of edges-8 (Latch Clamp) RM16: Number of edges-16	A: 45° D: 30° E: 15° F: 5° P: 0° Q: 2° Z: Plunging	C: Cutter S: Shank	M: Metric A: Inch	3: 9.525 4: 12.7 5: 15.875	Ø100	H: Thru-Hole No code: None	R: Right L: Left	M: Close H: Extra Close

Rich Mill RM3

Features

- High Quality - True 90° shouldering operation
- High Productivity - Strong thick insert and 3-face clamping ensure stable operation even tough condition.
- High Economics - Long tool life due to optimized manufacturing process

Features of insert

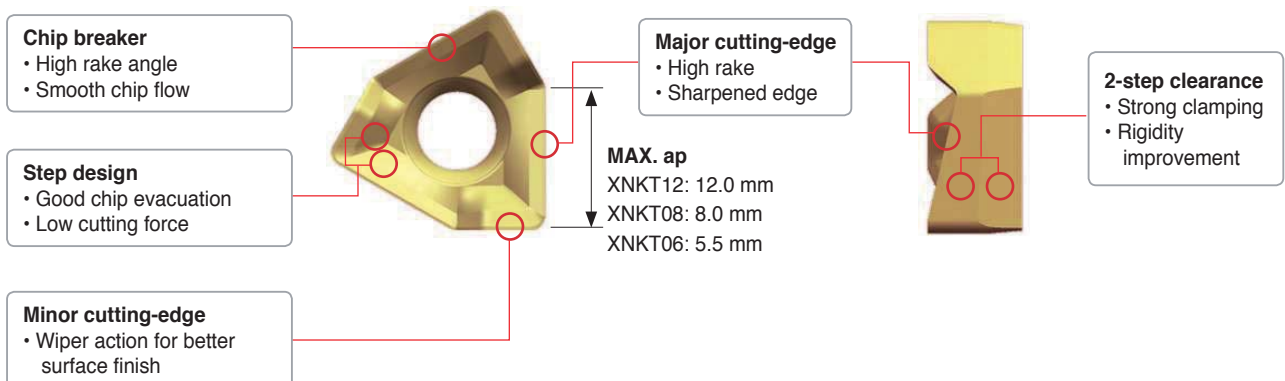

Rich Mill RM3

Features of cutter

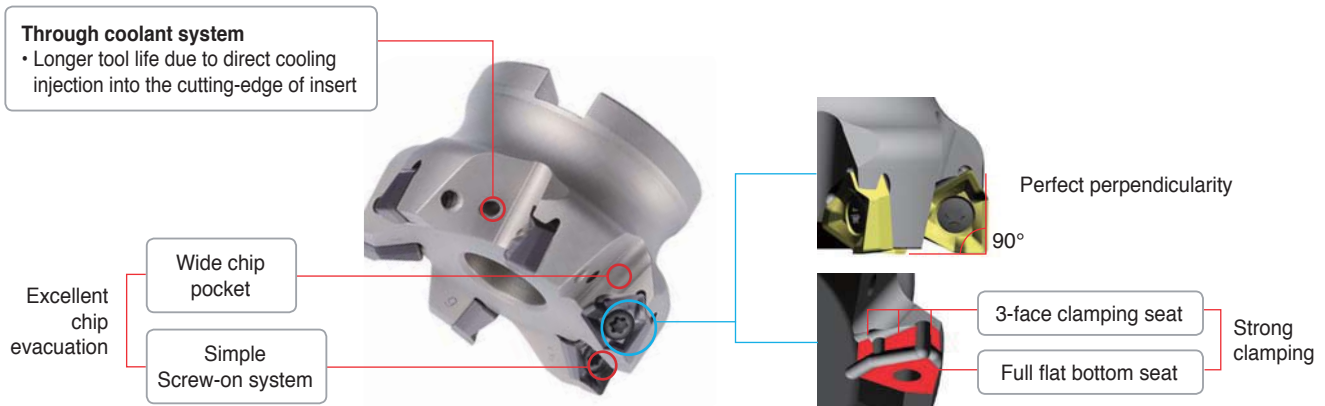

Through coolant system

- Exclusive through coolant bolt required
- Effective coolant distribution directly to cutting-edge
- Coolant supporting arbor required



Features of chip breakers

Insert	Cutting-edge	Uses	Features
MA		Aluminum	Superior cutting quality for aluminum due to sharp cutting-edge and buffed surface
ML		Light	Superior cutting quality for light and light cutting, difficult-to-cut material machining through the low cutting load of chip breaker
MM		General	Suitable for various cutting due to special shape design for general cutting

Max Step in plunging

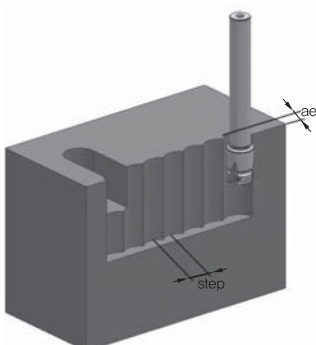

Type	max. ae
3000 type	2.5
4000 type	3.0
5000 type	3.5

ae	Cutter Diameter (mm)											
	Ø20	Ø21	Ø25	Ø26	Ø32	Ø33	Ø40	Ø50	Ø63	Ø80	Ø100	Ø125
	max step (mm)											
1	8.5	8.9	9.7	10	11.1	11.3	12.4	14	15.7	17.7	19.9	22.2
2	12	12.3	13.5	13.8	15.4	15.7	17.4	19.5	22	24.9	28	31.3
3	-	-	-	-	-	-	21	23.7	26.8	30.3	34.1	38.2

Rich Mill RM3

➤ Ramping and helical cutting

1. Ramping

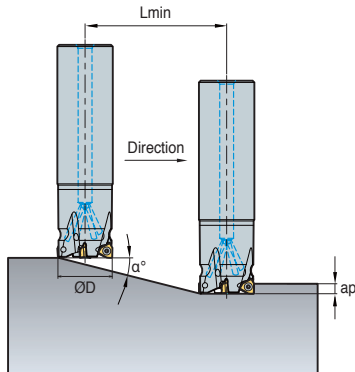

2. Helical cutting for blind hole

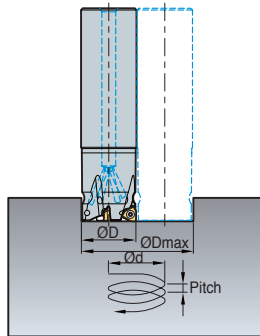

3. Helical cutting for through hole

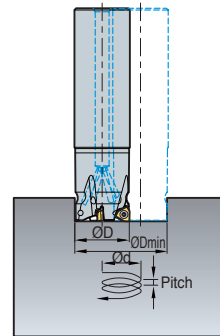

(mm)

Type	Tool Dia. ØD	ap	1. Ramping		2. Helical cutting for blind hole				3. Helical cutting for through hole	
			α°	Lmin	Minimum Hole Diameter Ød	Maximum Pitch	Maximum Hole Diameter Ød	Maximum Pitch	Minimum Hole Diameter Ød	Maximum Pitch
3000 type	20	5.5	15.5	19.8	36.5	5.5	38.5	5.5	33.0	5.5
	21	5.5	14.0	22.1	38.5	5.5	40.5	5.5	35.0	5.5
	25	5.5	10.0	31.2	46.5	5.5	48.5	5.5	43.0	5.5
	26	5.5	9.5	32.9	48.34	5.5	51.0	5.5	45.0	5.5
	32	5.5	6.5	48.3	60.5	5.5	62.5	5.5	59.0	5.5
	33	5.5	6.0	52.3	62.5	5.5	64.5	5.5	59.0	5.5
	40	5.5	4.5	69.9	46.5	5.5	78.5	5.5	73.0	5.5
	50	5.5	3.5	89.9	96.5	5.5	98.5	5.5	93.0	5.5
	63	5.5	2.5	126.0	122.5	5.5	124.5	5.5	119.0	5.5
	80	8	2.0	157.5	156.5	5.5	158.5	5.5	153.0	5.5
	100	8	1.5	210.0	194.5	5.5	198.5	5.5	193.0	5.5
125	8	1.0	315.1	246.5	5.5	248.5	5.5	243.0	5.5	
4000 type	25	8	24.0	18.0	44.5	8.0	48.0	8.0	38.5	8.0
	32	8	13.0	34.7	58.5	8.0	62.0	8.0	52.5	8.0
	33	8	12.0	37.6	60.02	8.0	64.4	8.0	54.5	8.0
	40	8	8.5	53.5	74.5	8.0	78.0	8.0	68.5	8.0
	50	8	6.0	76.1	94.5	8.0	98.0	8.0	88.5	8.0
	63	8	4.0	114.4	122.5	8.0	124.0	8.0	114.5	8.0
	80	8	3.0	152.6	154.5	8.0	158.0	8.0	148.5	8.0
	100	8	2.0	229.1	194.5	8.0	198.0	8.0	188.5	8.0
125	8	1.5	305.5	244.5	7.7	248.0	7.8	238.5	7.7	
5000 type	80	12	5.5	124.6	153.5	12.0	158.0	12.0	146.5	12.0
	100	12	4.5	152.5	193.5	12.0	198.0	12.0	159.5	12.0
	125	12	3.5	196.2	242.5	12.0	248.0	12.0	236.5	12.0

* Please be sure to use cutting oil or air for ramping and helical machining
 $L_{min} = ap / \tan(\alpha^\circ)$



Rich Mill RM3

Application guideline for grade

Workpiece		P	M	K	N	
		Carbon steel	Alloy steel	Stainless steel	Cast iron	Aluminum
Chip breaker	First choice	MM	MM	ML	ML	MA
	Second choice	ML	ML	-	MM	-
Grades	High speed machining	PC3600	PC3600	PC5300	PC6510	H01
	General machining	PC5400	PC5300	PC5400	PC5300	
	Interrupted machining	PC5400	PC5400	PC5400	PC5400	

Recommended cutting condition

• RM3 3000 type

Workpiece	Grades	Cutting conditions				Cutting conditions				
		vc (m/min)	fz (mm/t)	max ap (mm)	Available inserts	vc (m/min)	fz (mm/t)	max ap (mm)	Available inserts	
P	steel	PC3600	160~270	0.25~0.05	5.5	XNKT0604□□ PNSR-MM	160~270	0.2~0.05	5.5	XNKT0604□□ PNER-ML
		PC5300	150~240	0.25~0.05			150~240	0.25~0.05		
		PC5400	130~210	0.25~0.05			130~210	0.25~0.05		
M	Stainless steel	PC5300	90~150	0.2~0.05			90~150	0.1~0.05		
		PC5400	70~120	0.2~0.05			70~120	0.1~0.05		
K	Cast iron	PC6510	140~230	0.3~0.08			140~230	0.25~0.08		
		PC5300	120~200	0.3~0.08			120~200	0.25~0.08		

* Maximum cutting condition: vc = 350 m/min, fz = 0.5 mm/t according to cutting environment

• RM3 4000 type

Workpiece	Grades	Cutting conditions				Cutting conditions								
		vc (m/min)	fz (mm/t)	max ap (mm)	Available inserts	vc (m/min)	fz (mm/t)	max ap (mm)	Available inserts					
P	steel	PC3600	160~270	0.3~0.05	8.0	XNKT0805□□ PNSR-MM	160~270	0.25~0.05	8.0	XNKT0805□□ PNER-ML				
		PC5300	150~240	0.3~0.05			150~240	0.25~0.05						
		PC5400	130~210	0.3~0.05			130~210	0.25~0.05						
M	Stainless steel	PC5300	90~150	0.25~0.05			90~150	0.2~0.05						
		PC5400	70~120	0.25~0.05			70~120	0.2~0.05						
K	Cast iron	PC6510	140~230	0.35~0.08			140~230	0.3~0.08						
		PC5300	120~200	0.35~0.08			120~200	0.3~0.08						
N	Aluminum	H01	400~1200	0.4~0.1				XNCT0805□□PNFR-MA			-	-	-	-

* Maximum cutting condition: vc = 350 m/min, fz = 0.5 mm/t according to cutting environment

• RM3 5000 type

Workpiece	Grades	Cutting conditions				Cutting conditions								
		vc (m/min)	fz (mm/t)	max ap (mm)	Available inserts	vc (m/min)	fz (mm/t)	max ap (mm)	Available inserts					
P	steel	PC3600	160~270	0.3~0.05	12.0	XNKT1206□□ PNSR-MM	160~270	0.25~0.05	12.0	XNKT1206□□ PNER-ML				
		PC5300	150~240	0.3~0.05			150~240	0.25~0.05						
		PC5400	130~210	0.3~0.05			130~210	0.25~0.05						
M	Stainless steel	PC5300	90~150	0.25~0.05			90~150	0.2~0.05						
		PC5400	70~120	0.25~0.05			70~120	0.2~0.05						
K	Cast iron	PC6510	140~230	0.35~0.08			140~230	0.3~0.08						
		PC5300	120~200	0.35~0.08			120~200	0.3~0.08						
N	Aluminum	H01	400~1200	0.4~0.1				XNCT1206□□PNFR-MA			-	-	-	-

* Maximum cutting condition: vc = 350 m/min, fz = 0.5 mm/t according to cutting environment

Rich Mill RM4

Features

- Economical 4 cutting-edges by using double-sided insert
- RM4, as a multi-functional milling tool, offers economical 4 cutting-edges by using an innovative double-sided insert
- Special designed chip breaker consists of high rake angle and strong cutting-edge to decrease the cutting load
- RM4 is multi-functional tool that can cover facing, side cutting, shouldering, slotting, ramping & helical cutting
- Optimal matching of the special cutting-edge geometry with variety of new grades provides consistence & long tool life of insert

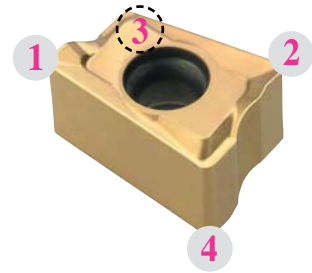

Features of cutter

- 4 cutting - edges can be used by using double-sided insert
- High rake angle chip breaker and cutting-edge can make smooth cutting with low cutting load
- Strong negative insert
- High efficiency, economical, multi-functional tool

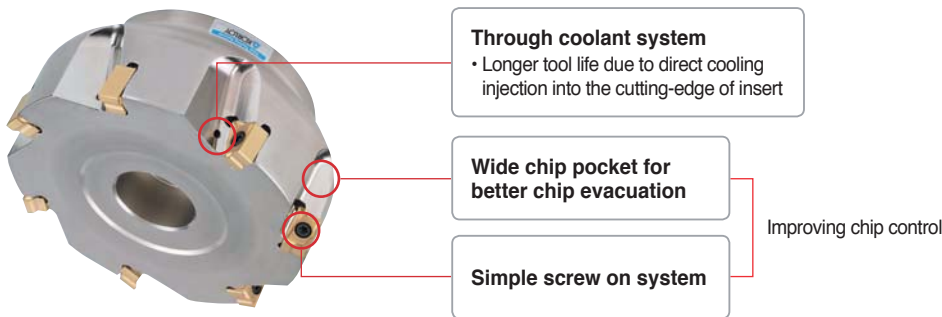

Features of insert

- Double-sided insert using 4 cutting-edges
- High rake angle chip breaker, cutting-edge
- Flexibility of product
- High efficiency, economical, multi-functional tool
- Negative insert has strong cutting-edge

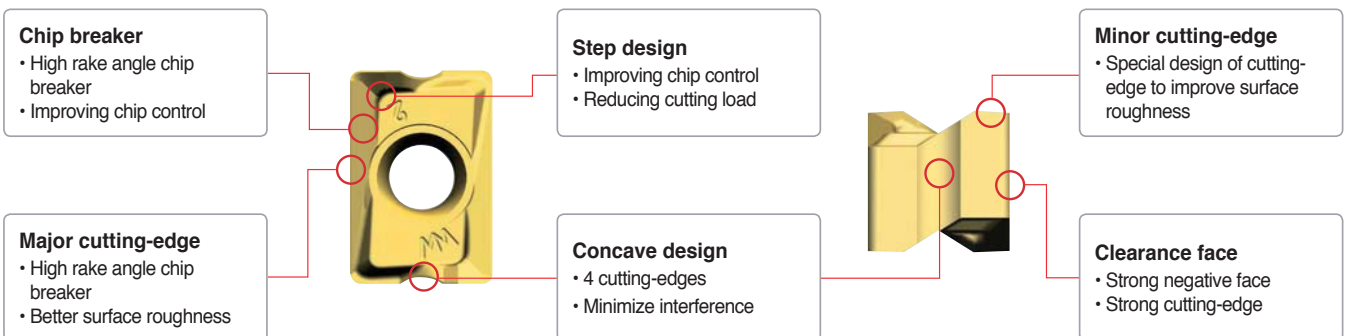



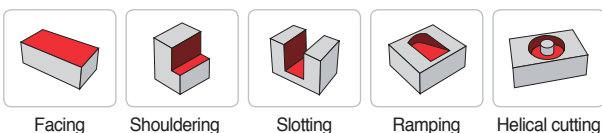



Uses





Rich Mill RM4

Features of chip breakers

Insert	Cutting-edge	Uses	Features
MA 		Aluminum, Light machining	With sharp edge application the better productivity has been accomplished, especially for Aluminum or low force cut
MF 		Light cutting	Due to low cutting load, it is good for light cutting and difficult-to-cut material
MM 		General cutting	It is suitable design for general milling

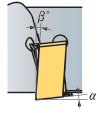
Setting configuration

Shape	Setting angle of insert	Features
	 β° α°	High rake chip breaker & positive setting angle for low cutting load → Improving machinability
	 90°	Multi applications for facing, shouldering, slotting, ramping, helical cutting, etc

Through coolant system

- By using on exclusive coolant bolt (hexagonal socket bolt) powerful cooling & better chip evacuation can be acquired
- To get optimal chip control, the direction of coolant injection has been designed to reach to each cutting-edge directly (through coolant arbor is required)

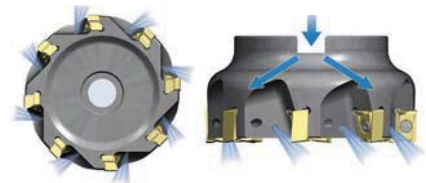

Through coolant system for decreasing cutting heat and good chip evacuation

Rich Mill RM4

Ramping and helical cutting

1. Ramping

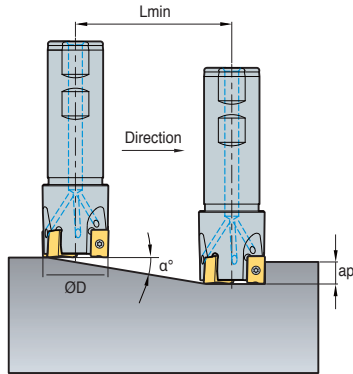

2. Helical cutting for blind hole

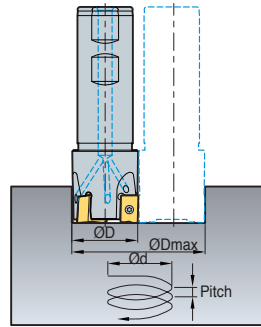

3. Helical cutting for through hole

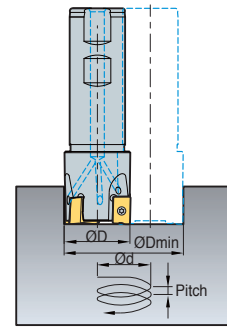

(mm)

Type	Tool Dia. ØD	ap	1. Ramping		2. Helical cutting for blind hole				3. Helical cutting for through hole	
			α°	Lmin	Minimum Hole Diameter Ød	Maximum Pitch	Maximum Hole Diameter Ød	Maximum Pitch	Minimum Hole Diameter Ød	Maximum Pitch
RM4PS3014HR	14	9	4.5	125	25	2.7	27	3.1	19	1.3
RM4PS3016HR	16	9	3.5	160	29	2.5	31	2.7	23	1.4
RM4PS3018HR	18	9	3.0	185	33	2.4	35	2.7	27	1.5
RM4PS3020HR	20	9	2.7	204	37	2.5	39	2.7	31	1.6
RM4PS3025HR	25	9	1.8	301	47	2.1	49	2.3	41	1.6
RM4PS3032HR	32	9	1.2	451	61	1.9	63	2.0	55	1.5
RM4PS3040HR	40	9	0.9	616	77	1.8	79	1.8	71	1.5
RM4PS3050HR	50	9	0.6	843	97	1.5	99	1.5	91	1.3
RM4PC(M)3040HR	40	9	0.9	616	77	1.8	79	1.8	71	1.5
RM4PC(M)3050HR	50	9	0.6	843	97	1.5	99	1.5	91	1.3
RM4PC(M)3063HR	63	9	0.5	1123	123	1.6	125	1.6	117	1.4
RM4PC(M)3080HR	80	9	0.3	1508	157	1.2	159	1.2	151	1.1
RM4PC(M)3100HR	100	9	0.2	1910	197	1.0	199	1.0	191	0.9
RM4PS4032HR	32	14	2.5	229	59.5	3.0	62	4	49	2.0
RM4PS4040HR	40	14	2.0	286	75.5	3.0	78	4	65	2.0
RM4PS4050HR	50	14	2.0	286	95.5	4.0	98	5	85	3.5
RM4PS4063HR	63	14	2.0	286	121.5	5.0	124	5	111	5.0
RM4PC(M)4050HR	50	14	2.0	286	95.5	4.0	98	5	85	3.5
RM4PC(M)4063HR	63	14	2.0	286	121.5	5.0	124	5	111	5.0
RM4PC(M)4080HR	80	14	1.5	382	155.5	5.0	158	5	145	5.0
RM4PC(M)4100HR	100	14	1.0	573	195.5	4.5	198	5	185	4.0
RM4PC(M)4125HR	125	14	1.0	573	245.5	5.0	248	5	235	5.0
RM4PC(M)4160R	160	14	0.5	1146	315.5	3.5	318	4	305	3.5

* Please be sure to use cutting oil or air for ramping and helical machining
 $L_{min} = ap / \tan(\alpha^\circ)$

Recommended cutting condition

ISO	Grades	LNM(E)X100605PNR-MF		LNM(E)X100605PNR-MM		LNEX100605PNR-MA		Max-ap (mm)	LNM(E)X151008PNR-MF		LNM(E)X151008PNR-MM		LNEX151008PNR-MA		Max-ap (mm)
		vc (m/min)	fz (mm/t)	vc (m/min)	fz (mm/t)	vc (m/min)	fz (mm/t)		vc (m/min)	fz (mm/t)	vc (m/min)	fz (mm/t)	vc (m/min)	fz (mm/t)	
P	NCM325	-	-	-	-	-	-	9.0	150~300	0.05~0.30	120~300	0.05~0.35	150~300	0.03~0.20	14.0
	PC3500	150~300	0.05~0.25	120~300	0.05~0.30	150~300	0.03~0.20		150~300	0.05~0.30	120~300	0.05~0.35	150~300	0.03~0.20	
M	PC5300	120~180	0.05~0.25	100~180	0.05~0.30	120~200	0.03~0.20		120~180	0.05~0.30	100~180	0.05~0.3	120~200	0.03~0.20	
K	PC6510	150~300	0.08~0.30	120~300	0.08~0.35	-	-		150~300	0.08~0.35	120~300	0.08~0.35	-	-	



Rich Mill RM4Z

Features

- Rich mill series RM4Z is a plunge mill for high efficiency vertical machining such as slotting and pocketing in roughing applications
- Rich mill series RM4Z is a highly efficient milling tool for plunging, shouldering and facing. It makes operations more economical with the use of its double-sided 4-corner insert
- Plunge machining reduces lead time for high productivity and precision machining.
- In plunging the max depth of RM4Z 3000 type is 9.0 mm and that of RM4Z 4000 type is 14.0 mm

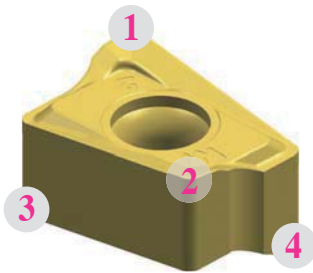
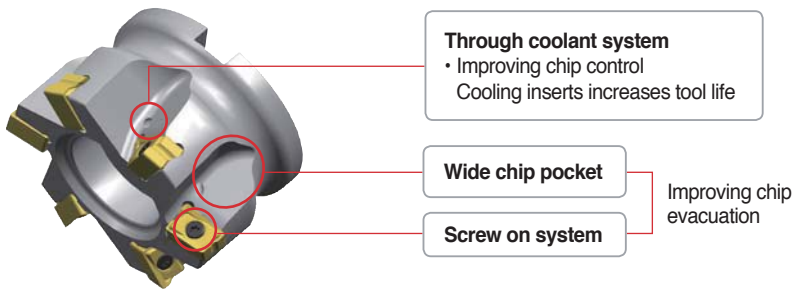

- Double-sided insert ... 4 corner available
- High rake angle chip breaker and cutting-edge
- Various available machining types
- High efficiency and economical insert
- Negative type insert - Strong cutting-edge

Features of insert

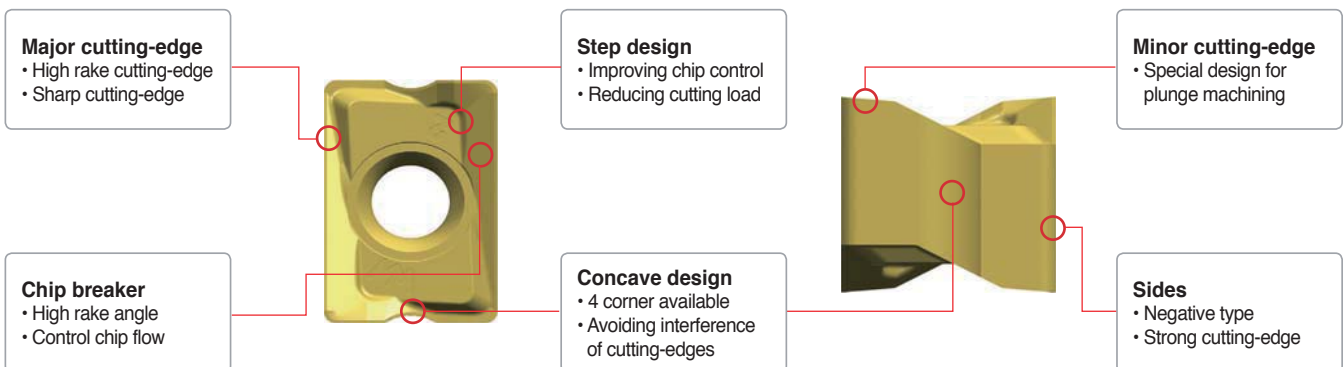

Uses

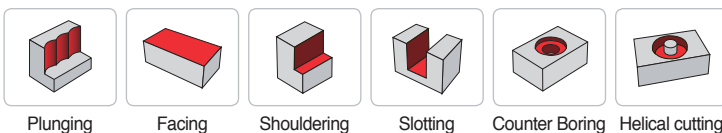

Rich Mill RM4Z

➤ The depth of cut by machining type

• In horizontal machining, Depth of cut = a_p (mm)

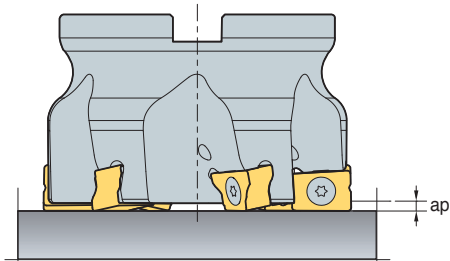

• In plunging, Depth of cut = a_e (mm)

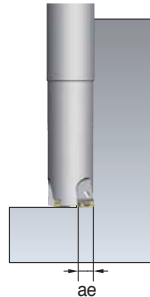

RM4Z	Horizontality	Verticality	
	max a_p (mm)	max a_e (mm)	step
RM4Z 3000	1.5	9	< 0.7D
RM4Z 4000	2.5	14	< 0.7D

➤ Max step in plunging

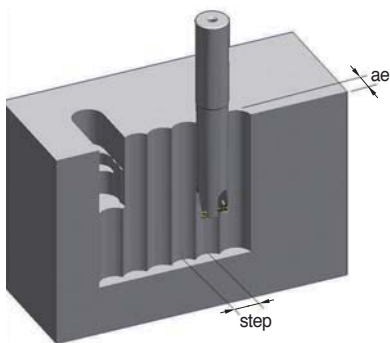

a _e	Cutter Diameter (mm)								
	25	32	40	50	52	63	66	80	100
	Max step (mm)								
1	9.7	11.1	12.4	14	14.2	15.7	16.1	17.7	19.9
2	13.5	15.4	17.4	19.5	20	22	22.6	24.9	28
3	16.2	18.6	21	23.7	24.2	26.8	27.4	30.3	34.1
4	18.3	21.1	24	27.1	27.7	30.7	31.4	34.8	39.1
5	20	23.2	26.4	30	30.6	34	34.9	38.7	43.5
6	21.3	24.9	28.5	32.4	33.2	36.9	37.9	42.1	47.4
7	22.4	26.4	30.3	34.6	35.4	39.5	40.6	45.2	51
8	23.3	27.7	32	36.6	37.5	41.9	43	48	54.2
9	24	28.7	33.4	38.4	39.3	44	45.2	50.5	57.2
10	-	-	-	-	-	46	47.3	52.9	60
11	-	-	-	-	-	47.8	49.1	55.1	62.5
12	-	-	-	-	-	49.4	50.9	57.1	64.9
13	-	-	-	-	-	50.9	52.4	59	67.2
14	-	-	-	-	-	52.3	53.9	60.7	69.3

➤ Through coolant system

- Exclusive hexagonal coolant socket bolt provides excellent cooling and chip evacuation
- Direct coolant injection to cutting-edge improves cooling effectiveness
- Coolant type arbor should be used

* Coolant bolt is not included, it is for sale

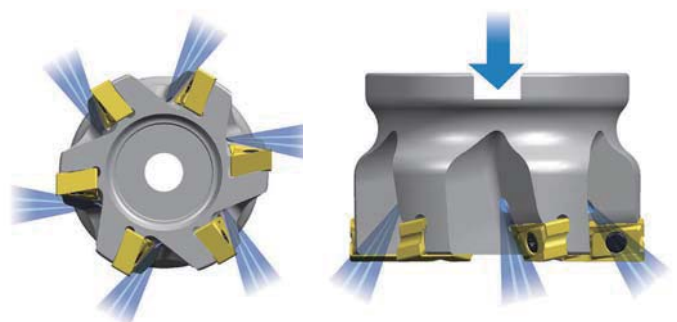

Rich Mill RM4Z

Programming tip

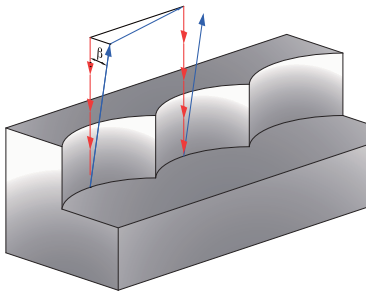

- - - Plunging feed direction
- Tool escape
- β Escape angle ($\beta \geq 1^\circ$)

• When your tool steps back after plunging, please get over 1° more escape angle

Helical machining

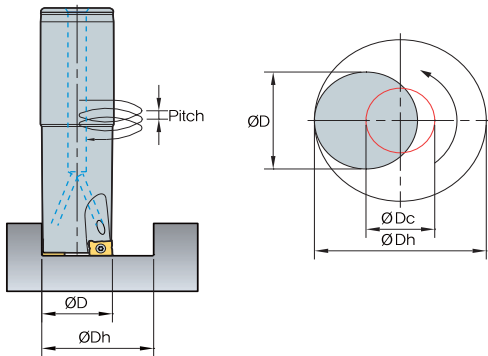

$$\text{ØDc} = \text{ØDh} - \text{ØD}$$

- ØDc = Tool center path
- ØDh = Desired hole diameter
- ØD = Tool Dia.

(mm)

Designation	Diameter ØD (mm)	Helical data				
		ØDh max (mm)	Max. Pitch (mm)	ØDh min (mm)	Max. Pitch (mm)	
RM4ZS	3025HR-L25	25	30	0.4	48	1.8
	3032HR-L32	32	43	0.3	62	0.9
	3040HR-L32	40	59	0.3	78	0.6
RM4ZC	M3040HR	40	59	0.3	78	0.6
	M3050HR	50	79	0.3	98	0.5
	M3052HR	52	83	0.3	102	0.5
RM4ZM	3025HR-M12	25	30	0.4	48	1.8
	3032HR-M16	32	43	0.3	62	0.9
	3040HR-M16	40	59	0.3	78	0.6
RM4ZC	M4063HR	63	95	0.5	124	1.0
	M4066HR	66	101	0.5	130	1.0
	M4080HR	80	129	0.5	158	0.8
	M4100HR	100	169	0.3	198	0.5

Recommended cutting condition

ISO	Grades	LNM(E)X100605PNL-MM				LNM(E)X151008PNL-MM			
		vc (m/min)	fz (mm/t)	* max ae (mm)	** max ap (mm)	vc (m/min)	fz (mm/t)	* max ae (mm)	** max ap (mm)
P	PC3500	100~250	0.05~0.25	9	1.5	120~250	0.05~0.25	14	2.5
M	PC5300	100~250	0.08~0.30			120~250	0.08~0.30		
K	PC6510	80~180	0.05~0.20			100~180	0.05~0.20		

* max ae (mm): (Plunging) max. radial depth of cut

** max ap (mm): (Shouldering/Facing) max depth of cut

Rich Mill RM6

Features

- Stable clamping - 3 clamping surfaces on the side and strong clamping screws
→ Improves cutting stability
- High quality results - High precision, excellent perpendicularity, outstanding surface finish on the flank, accurate tolerance
- High productivity - High rake angle and sharp cutting-edges for lower cutting resistance
→ Ideal for high speed and high feed machining

Features of insert

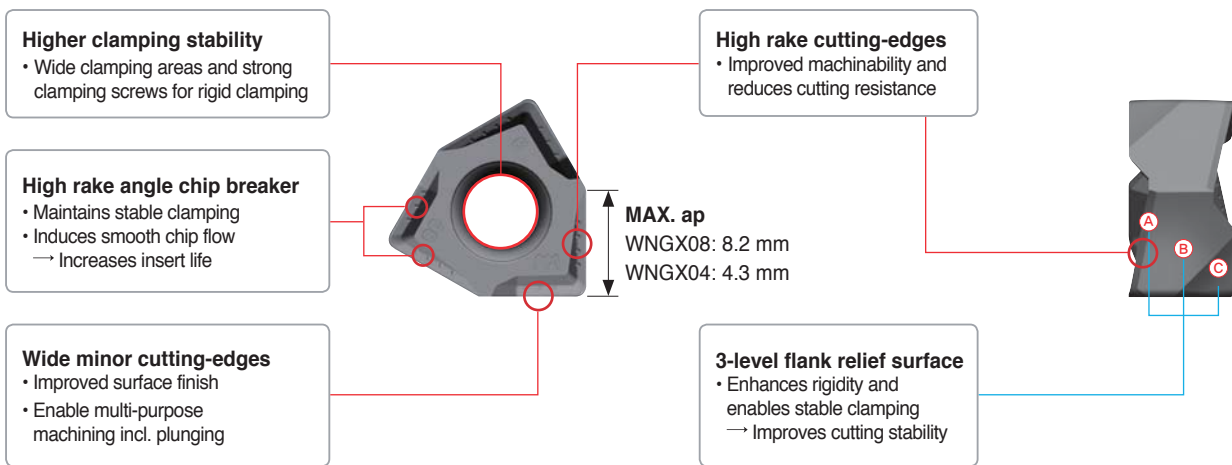



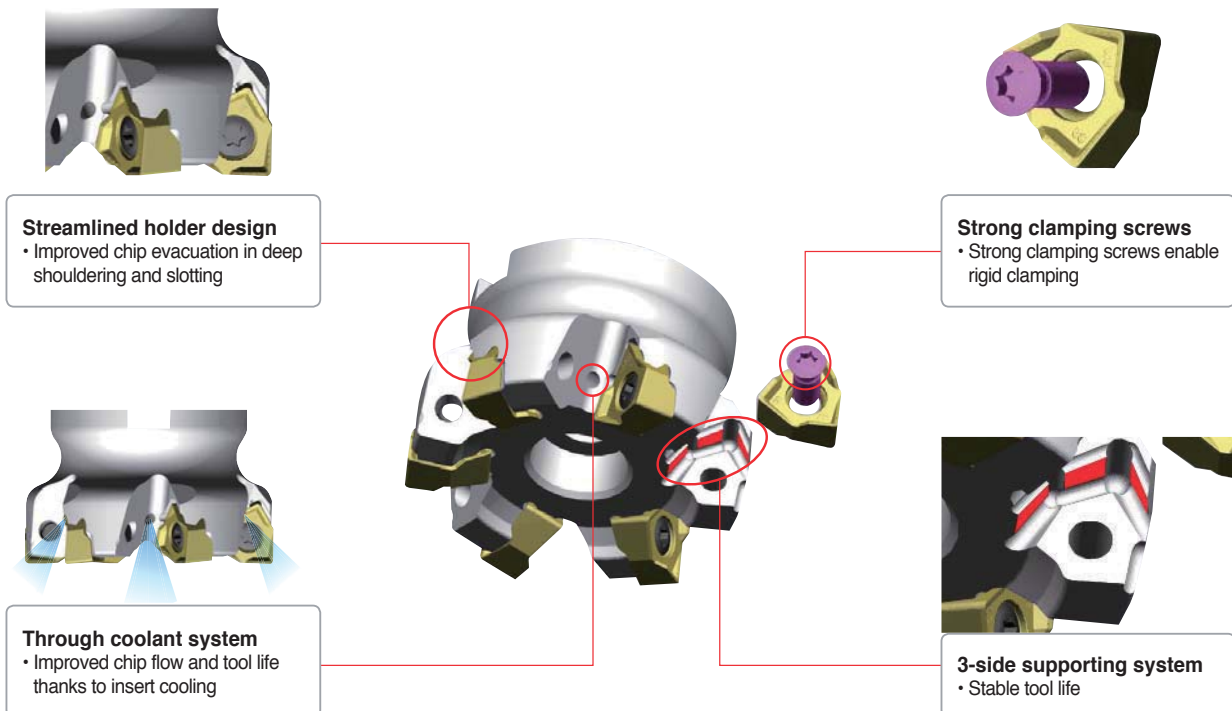



Features of cutter



Rich Mill RM6

Features of chip breakers

Insert	Cutting-edge	Uses	Features
MA			For aluminum Sharp cutting-edges for excellent cutting performance in aluminum machining Buffed surface for excellent chip flow and welding resistance
ML			For light cutting Chip breaker design of low cutting resistance, ideal for light cutting and machining hard-to-cut materials Excellent tool life and quality results
MM			For general cutting Chip breaker design ideal for general shoulder milling and most applications

Application guideline for grade

Workpiece		P	M	K	N	
		Carbon steel	Alloy steel	Stainless steel	Cast iron	Non-ferrous metal
Shape	1st recommended	MM	MM	ML	ML	MA
	2nd recommended	ML	ML	-	MM	MA
Grades	High speed milling	PC3600	PC3600	PC5300	PC6510	H01
	General milling	PC5400	PC5300	PC5400	PC5300	H01
	Interrupted milling	PC5400	PC5400	PC5400	PC5400	H01

Recommended cutting condition

• WNGX04

Workpiece	Grades	WNGX040304PNSR-MM			WNGX040304PNER-ML			WNGX040304PNFR-MA		
		vc (m/min)	fz (mm/t)	max. ap(mm)	vc (m/min)	fz (mm/t)	max. ap (mm)	vc (m/min)	fz (mm/t)	max. ap (mm)
P Steel	PC3600	160~270	0.25~0.05	4.3	160~270	0.20~0.05	4.3	-	-	4.3
	PC5300	150~240	0.25~0.05	4.3	150~240	0.25~0.05	4.3	-	-	4.3
	PC5400	130~210	0.25~0.05	4.3	130~210	0.25~0.05	4.3	-	-	4.3
M Stainless steel	PC5300	90~150	0.20~0.05	4.3	90~150	0.10~0.05	4.3	-	-	4.3
	PC5400	70~120	0.20~0.05	4.3	70~120	0.10~0.05	4.3	-	-	4.3
K Cast iron	PC6510	140~230	0.30~0.08	4.3	140~230	0.25~0.08	4.3	-	-	4.3
	PC5300	120~200	0.30~0.08	4.3	120~200	0.25~0.08	4.3	-	-	4.3
N Non-ferrous metal	H01	-	-	4.3	-	-	4.3	500~1000	0.2~0.05	4.3

※ The above data refer to general cutting conditions and can be adjustable up to 300 m/min and 0.4 mm/t depending on user environment.

• WNGX08

Workpiece	Grades	WNGX080608PNSR-MM			WNGX080608PNER-ML			WNGX080608PNFR-MA		
		vc (m/min)	fz (mm/t)	max. ap (mm)	vc (m/min)	fz (mm/t)	max. ap (mm)	vc (m/min)	fz (mm/t)	max. ap (mm)
P Steel	PC3600	160~270	0.25~0.05	8.2	160~270	0.20~0.05	8.2	-	-	8.2
	PC5300	150~240	0.25~0.05	8.2	150~240	0.25~0.05	8.2	-	-	8.2
	PC5400	130~210	0.25~0.05	8.2	130~210	0.25~0.05	8.2	-	-	8.2
M Stainless steel	PC5300	90~150	0.20~0.05	8.2	90~150	0.10~0.05	8.2	-	-	8.2
	PC5400	70~120	0.20~0.05	8.2	70~120	0.10~0.05	8.2	-	-	8.2
K Cast iron	PC6510	140~230	0.30~0.08	8.2	140~230	0.25~0.08	8.2	-	-	8.2
	PC5300	120~200	0.30~0.08	8.2	120~200	0.25~0.08	8.2	-	-	8.2
N Non-ferrous metal	H01	-	-	8.2	-	-	8.2	500~1000	0.2~0.05	8.2

※ The above data refer to general cutting conditions and can be adjustable up to 300 m/min and 0.4 mm/t depending on user environment.

Rich Mill RM6

Ramping

1. Ramping

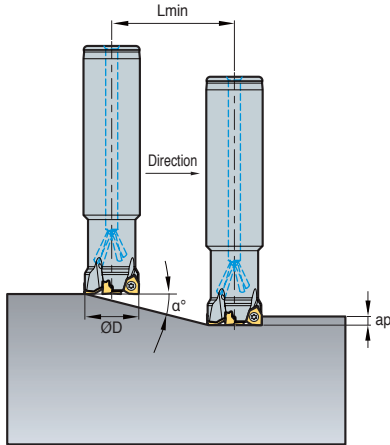

2. Helical cutting for blind holes

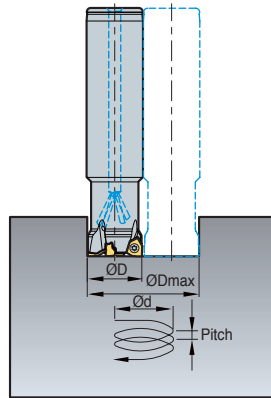

3. Helical cutting for through holes

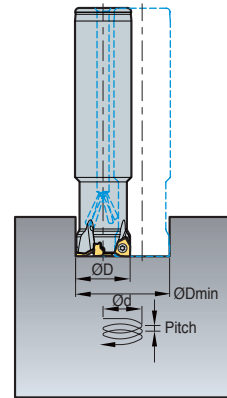

(mm)

Designation	Tool Dia. ØD	Depth of cut ap	1. Ramping		2. Helical cutting for blind holes				3. Helical cutting for through holes		
			Max. rake angle α°	Lmin	Min. machining Dia. Ø DHmin	Max. pitch dmax	Max. machining Dia. Ø DHmax	Max. pitch dmax	Min. machining Dia. Ø DHmin	Max. pitch dmax	
RM6PS	032R-2W32-120-WN08	32	8	0.8	572.9	54	0.96	62	1.3	38.5	0.5
	040R-3W32-120-WN08	40	8	0.5	916.7	70	0.82	78	1.0	54.5	0.4
	050R-4W32-120-WN08	50	8	0.3	1527.9	90	0.66	98	0.8	74.5	0.3
RM6PCM	063R-22-6-WN08	63	8	0.2	2291.3	116	0.58	124	0.6	100.5	0.3
	080R-27-7-WN08	80	8	0.1	4583.7	150	0.38	158	0.4	134.5	0.2
	100R-32-8-WN08	100	8	0.1	4583.7	190	0.49	198	0.5	174.5	0.3
	125R-40-11-WN08	125	8	0.1	4583.7	240	0.63	248	0.6	224.5	0.3

$L_{min} = ap / \tan(\alpha^\circ)$

Lmin: Cutting length at min. rake angle
 ap: Axial depth of cut
 α°: Available rake angle for ramping



Rich Mill RM8

Features

- Double-sided insert to use 8 cutting-edges
- Innovative double-sided insert makes it possible to use 8 cutting-edges
It is more economical than conventional single sided insert
- The unique geometry and high rake angle of cutting-edge guarantees excellent surface finish
Applicable for various workpieces like steel, stainless steel, cast iron, aluminum
- Combined with the innovative geometry and various grades provided the tool offers durability and excellent tool life
- Various pitches and chip breakers can be applicable for diverse machining
- Light Rich Mill cutter can be useful for high speed machining and low power machine



Through coolant system

- Exclusive coolant bolt is adapted to get better chip evacuation and more powerful cooling. To get optimal chip evacuation, the direction of coolant injection has been designed to reach to each cutting-edge directly.
Through coolant arbor is required

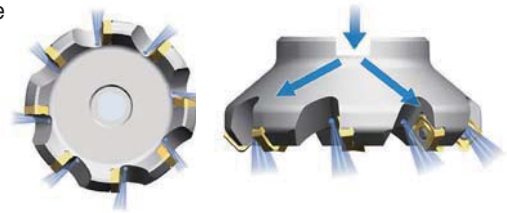

Through coolant system for decreasing cutting heat and good chip evacuation

Features of chip breaker

Insert	Cutting-edge	Uses	Features
MA		For aluminum	Due to sharp cutting-edge and buffed surface, it has good chip flow and welding resistance
ML		For hard-to-cut material	Chip breaker with low cutting load is optimal for machining hard-to-cut materials
MF		For light cutting	Due to low cutting load, it is good for light cutting and difficult-to-cut material
MM		For general cutting	It is suitable design for general milling
W		For wiper	Specialized edge design can be suitable for excellent surface roughness operation

Uses

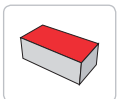

Facing

Features of insert

Insert	Cutting-edge	Features
	View-A 	High rake chip breaker & positive setting angle for low cutting load
	View-B 	Designed wiper technology in minor cutting-edge for improved surface roughness
	Chip breaker 	Low cutting load due to the positive setting and high rake angle chip breaker

Rich Mill RM8

Features of cutter

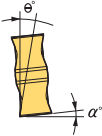
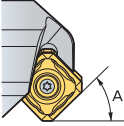
Shape	Setting angle of insert	Features
		High rake angle makes positive setting angle for low cutting load
		Suitable for facing and chamfering • RM8A A = 45° • RM8E A = 75° • RM8Q A = 88°

Recommended cutting condition

ISO	Grades	SNM(E)X1206A(E)NN-MF		SNM(E)X1206A(E)NN-MM		SNEX1206A(E)NN-MA		Max-ap (mm)	SNM(E)X1507A(E)NN-MF		SNM(E)X1507A(E)NN-MM		Max-ap (mm)
		vc (m/min)	fz (mm/t)	vc (m/min)	fz (mm/t)	vc (m/min)	fz (mm/t)		vc (m/min)	fz (mm/t)	vc (m/min)	fz (mm/t)	
P	NC5330	-	-	150~300	0.10~0.35	150~300	0.10~0.35	RM8A 6.0mm	-	-	150~300	0.10~0.35	RM8A 7.5 mm
	NCM325	200~300	0.05~0.30	150~300	0.10~0.35	150~300	0.10~0.35		200~300	0.05~0.30	150~300	0.10~0.35	
	PC3500	200~300	0.05~0.30	150~300	0.10~0.35	150~300	0.10~0.35		200~300	0.05~0.30	150~300	0.10~0.35	
M	PC9530	90~150	0.05~0.25	90~150	0.10~0.35	-	-	RM8E 9.0mm	90~150	0.10~0.30	90~150	0.10~0.35	RM8E 11 mm
	PC5300	90~150	0.05~0.25	90~150	0.10~0.35	-	-		90~150	0.10~0.30	90~150	0.10~0.35	
K	PC6510	150~300	0.08~0.35	150~300	0.10~0.40	150~300	0.10~0.40	RM8Q 11.5mm	150~300	0.08~0.35	150~300	0.10~0.40	
	PC5300	150~300	0.08~0.35	150~300	0.10~0.40	150~300	0.10~0.40		150~300	0.08~0.35	150~300	0.10~0.40	

Rich Mill RMH8

Features

- Screw on clamping system - Adaptable and Stable clamping system
- Reinforced rigidity and enhanced clamping power
 - Applying shim system, prevent cutter damage when insert breaks
- Adapting/exchangeable shim
 - Using various kinds of cutter (Approach angle 45°, 75°, 88°)
 - Stable clamping power with insert

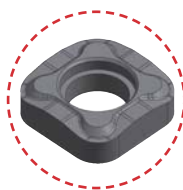
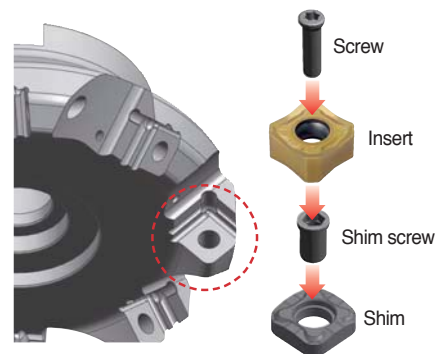

RMH8A
(AA 45°)



RMH8E
(AA 75°)

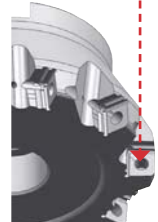

RMH8Q
(AA 88°)

Rich Mill RMT8

Features

- New latch clamping system provides a powerful cutting force and an easy insert change
- New grades with chipping resistance provides good surface roughness and better tool life
- Due to the specially designed chip breaker, all operations are possible
- RMT with various pitches can replace conventional ISO milling tool

Features of cutter

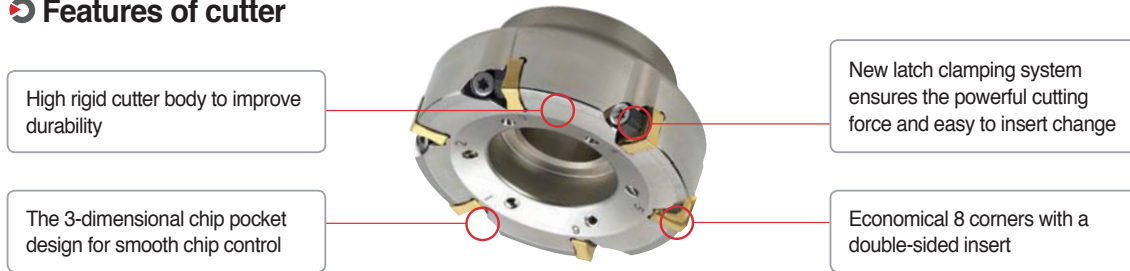

Features of insert (Using R/L)

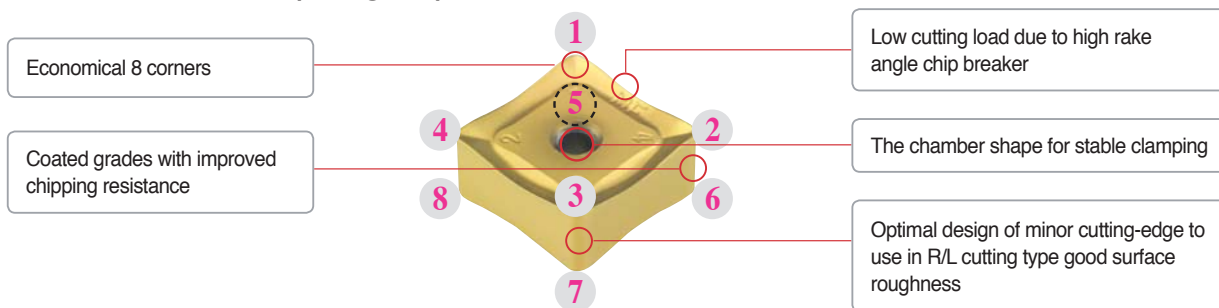

Clamping force analysis

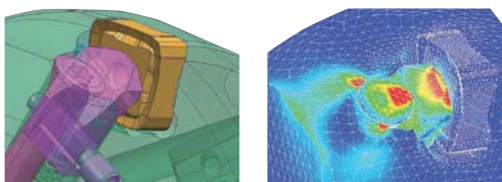

Features of chip breakers

	Insert	Cutting-edge	Uses	Features
MF			For fine finishing	Our specialized insert design creates low cutting forces suitable for light cutting, HRSA
MM			For strengthen	Suitable geometry design for general milling has wider ranges of machining

Recommended grades and chip breakers

ISO	Grades	MM	MF
P	NCM325	◎	○
	PC5300	◎	○
M	PC9530	○	◎
K	PC6510	○	◎

◎: Optimum ○: Proper

Recommended cutting condition





ISO	Grades	MM		MF	
		vc (m/min)	fz (mm/t)	vc (m/min)	fz (mm/t)
P	NC5330	190~310	0.10~0.35	190~310	0.05~0.30
	NCM325	160~270	0.10~0.35	160~270	0.05~0.30
	PC3500	130~210	0.10~0.35	130~210	0.05~0.30
M	PC9530	90~150	0.05~0.30	90~150	0.05~0.30
K	PC6510	140~230	0.10~0.40	140~230	0.08~0.35

Rich Mill RM16











Features

- Economical 16 cutting-edges
- Reduces cost in medium cutting
- Wiper insert can be used for good surface roughness
- Optimal matching of the special cutting-edge geometry with variety of new grades provides consistence & long tool
- When it is used 16 corners, maximum cutting depth is 5.5 mm, but it is used 8 corners, maximum cutting depth is 13 mm
- Wiper insert is placed 0.05 mm lower than facing insert in cutter
- When feed is bigger than wiper cutting-edge length (7 mm), 2 wiper inserts are placed in symmetrical position

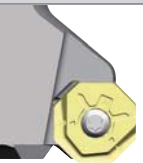
Features of chip breakers

Insert	Cutting-edge	Uses	Features
MA		For aluminum cutting light	With sharp edge application, the better productivity has been accomplished, especially for aluminum cutting
ML		For hard-to-cut material	Chip breaker with low cutting load is optimal for machining hard-to-cut materials
MF		For light cutting	Due to low cutting load, it is good for light cutting and difficult-to-cut material
MM		For general cutting	It is suitable design for general milling
W		For wiper	It has better surface roughness than MM and MF chip breakers

Instruction for wiper insert

Hand	Correct setting	Incorrect setting			
Right hand					
Decision	○	×	×	×	×
Left hand					
Decision	○	×	×	×	×

Through coolant system

- Well designed chip pocket for better chip flow
- Through coolant system reduces cutting heat and improves chip evacuation



Recommended cutting condition

(mm)

ISO	Grades	ONM(H)X060608-MM		ONM(H)X060608-MF		ONHX060608-W		ONM(H)X080608-MM		ONM(H)X080608-MF		ONHX080608-W	
		vc (m/min)	fz (mm/t)	vc (m/min)	fz (mm/t)	vc (m/min)	fz (mm/t)	vc (m/min)	fz (mm/t)	vc (m/min)	fz (mm/t)	vc (m/min)	fz (mm/t)
P	NCM325	150~300	0.10~0.35	200~300	0.05~0.30	200~300	0.05~0.20	150~300	0.10~0.40	200~300	0.05~0.35	200~300	0.05~0.25
	PC3500	150~300	0.10~0.35	200~300	0.05~0.30	200~300	0.05~0.20	150~300	0.10~0.40	200~300	0.05~0.35	200~300	0.05~0.25
M	PC6510	120~180	0.10~0.35	100~180	0.05~0.30	100~180	0.05~0.20	120~180	0.10~0.40	100~180	0.05~0.35	100~180	0.05~0.25
K	PC9530	150~300	0.10~0.40	150~300	0.08~0.35	150~300	0.05~0.25	150~300	0.10~0.45	150~300	0.08~0.40	150~300	0.05~0.30



Cutters

Type	A.A	Designation	Shape	Cutter Diameter	Application	Features	Page		
RM3	90°	RM3PC(M)3000 ^{new}		Ø40~Ø80	XNKT060405PNER-ML XNKT060405PNSR-MM		E89		
		RM3PC(M)4000 ^{new}		Ø40~Ø125	XNCT080508PNFR-MA XNKT080508PNER-ML XNKT080508PNSR-MM			XNKT080512PNSR-MM XNKT080516PNSR-MM XNKT080520PNSR-MM	E90
		RM3PC(M)5000 ^{new}		Ø80~Ø125	XNCT120608PNER-MA XNKT120608PNER-ML XNKT120612PNER-ML XNKT120616PNER-ML XNKT120620PNER-ML			XNKT120608PNSR-MM XNKT120612PNSR-MM XNKT120616PNSR-MM XNKT120620PNSR-MM	
RM4	90°	RM4PC(M)3000		Ø40~Ø100	LNEX100605PNER-MF LNMX100605aPNER-MF LNEX100605PNER-MM LNMX100605PNER-MM LNEX100608PNER-MF LNMX100608PNER-MF	LNEX100608PNER-MM LNMX100608PNER-MM LNEX100605PNER-MA LNEX100605PNL-MM LNMX100605PNL-MM	E95		
		RM4PC(M)4000		Ø50~Ø160	LNEX151004PNER-MF LNMX151004PNER-MF LNEX151004PNER-MM LNMX151004PNER-MM LNEX151008PNER-MF LNMX151008PNER-MF LNEX151008PNER-MM LNMX151008PNER-MM	LNEX151016PNER-MF LNMX151016PNER-MF LNEX151016PNER-MM LNMX151016PNER-MM LNEX151004PNER-MA LNEX151008PNER-MA LNEX151008PNL-MM LNMX151008PNL-MM		E96	
		RM4ZCM3000		Ø40~Ø52	LNEX100605PNL-MM	LNMX100605PNL-MM	E108		
		RM4ZC(M)4000		Ø63~Ø100	LNEX151008PNL-MM	LNMX151008PNL-MM			
RM6	90°	RM6PCM-WN04 ^{new}		Ø40~Ø63	WNGX040304PNFR-MA WNGX040308PNFR-MA WNGX040312PNFR-MA WNGX040316PNFR-MA WNGX040304PNER-ML WNGX040308PNER-ML	WNGX040312PNER-ML WNGX040316PNER-ML WNGX040304PNSR-MM WNGX040308PNSR-MM WNGX040312PNSR-MM WNGX040316PNSR-MM	E110		
		RM6PC(M)-WN08 ^{new}		Ø50~Ø125	WNGX080604PNFR-MA WNGX080608PNFR-MA WNGX080612PNFR-MA WNGX080616PNFR-MA WNGX080604PNER-ML WNGX080608PNER-ML WNGX080612PNER-ML	WNGX080616PNER-ML WNGX080620PNER-ML WNGX080604PNSR-MM WNGX080608PNSR-MM WNGX080612PNSR-MM WNGX080616PNSR-MM WNGX080620PNSR-MM		E111	









Cutters

Type	A.A	Designation	Shape	Cutter Diameter	Application		Features	Page	
RM8	45°	RM8AC(M)4000		Ø50~Ø400	SNEX1206ANN-MA SNEX1206ANN-MF SNMX1206ANN-MF SNEX1206ANN-ML	SNEX1206ANN-MM SNMX1206ANN-MM SNEX1206ANN-W		E115	
		RM8AC(M)5000		Ø80~Ø400	SNEX1507ANN-MF SNMX1507ANN-MF SNEX1507ANN-ML	SNEX1507ANN-MM SNMX1507ANN-MM		E117	
	75°	RM8EC(M)4000		Ø50~Ø400	SNEX1206ENN-MA SNEX1206ENN-MF SNMX1206ENN-MF	SNEX1206ENN-ML SNEX1206ENN-MM SNMX1206ENN-MM		E119	
		RM8EC(M)5000		Ø80~Ø400	SNEX1507ENN-MF SNMX1507ENN-MF SNEX1507ENN-ML	SNEX1507ENN-MM SNMX1507ENN-MM		E121	
	88°	RM8QC(M)4000		Ø63~Ø200	SNEX1206QNN-MA SNEX1206QNN-MF SNMX1206QNN-MF SNEX1206QNN-ML SNEX1206QNN-MM SNMX1206QNN-MM	SNEX120612-MA SNEX120612-MF SNMX120612-MF SNEX120612-ML SNEX120612-MM SNMX120612-MM		E123	
	45°	RMH8AC(M)4000		Ø50~Ø400	SNEX1206ANN-MA SNEX1206ANN-MF SNMX1206ANN-MF	SNEX1206ANN-ML SNEX1206ANN-MM SNMX1206ANN-MM SNEX1206ANN-W			E116
		RMH8AC(M)5000		Ø80~Ø400	SNEX1507ANN-MF SNMX1507ANN-MF SNEX1507ANN-ML	SNEX1507ANN-MM SNMX1507ANN-MM			E118
	75°	RMH8EC(M)4000		Ø50~Ø400	SNEX1206ENN-MA SNEX1206ENN-MF SNMX1206ENN-MF	SNEX1206ENN-ML SNEX1206ENN-MM SNMX1206ENN-MM			E120
		RMH8EC(M)5000		Ø80~Ø400	SNEX1507ENN-MF SNMX1507ENN-MF SNEX1507ENN-ML	SNEX1507ENN-MM SNMX1507ENN-MM			E122
	88°	RMH8QC(M)4000		Ø63~Ø200	SNEX1206QNN-MA SNEX1206QNN-MF SNMX1206QNN-MF SNEX1206QNN-ML SNEX1206QNN-MM SNMX1206QNN-MM	SNEX120612-MA SNEX120612-MF SNMX120612-MF SNEX120612-ML SNEX120612-MM SNMX120612-MM			E124

- Economical 8 corners.
- Low cutting load and excellent smooth cutting.



Cutters

Type	A.A	Designation	Shape	Cutter Diameter	Application		Features	Page	
RMT8	45°	RMT8A(M) 4000/5000		Ø80~Ø315	SNCF1206ANN-MF SNCF1507ANN-MF SNMF1206ANN-MF SNMF1507ANN-MF	SNCF1206ANN-MM SNCF1507ANN-MM SNMF1206ANN-MM SNMF1507ANN-MM		<ul style="list-style-type: none"> Economical 8 corners. Excellent tool life and surface toughness due to low cutting resistance and high rake edge geometry. 	E125 E126
	75°	RMT8E(M) 4000/5000		Ø80~Ø315	SNCF1206ENN-MF SNCF1507ENN-MF SNMF1206ENN-MF SNMF1507ENN-MF	SNCF1206ENN-MM SNCF1507ENN-MM SNMF1206ENN-MM SNMF1507ENN-MM		<ul style="list-style-type: none"> Good performance with increased chipping resistance and grade 	E127 E128
	88°	RMT8Q(M)4000		Ø80~Ø315	SNCF1206QNN-MF	SNMF1206QNN-MF			E129
RMT16	45°	RM16AC(M) 6000/8000		Ø63~Ø400	ONHX060608-MF ONMX060608-MF ONHX0606ANN-MF ONMX0606ANN-MF ONHX080608-MF ONMX080608-MF ONHX0806ANN-MF ONMX0806ANN-MF ONHX060608-ML ONMX060608-ML ONHX080608-ML ONMX080608-ML	ONMX060608-MM ONHX0606ANN-MM ONMX0606ANN-MM ONHX080608-MM ONMX080608-MM ONHX0806ANN-MM ONMX0806ANN-MM ONHX060608-MA ONMX060608-MA ONHX080608-MA ONMX080608-MA		<ul style="list-style-type: none"> Economical 16 corners. Wiper insert for surface roughness. 	E130 E131

Shanks/Modulars

Type	A.A	Designation	Shape	Cutter Diameter	Application		Features	Page
RM3	90°	RM3PS3000 new		Ø20~Ø40	XNKT060405PNER-ML	XNKT060405PNSR-MM		E92
		Ø32~Ø63		XNKT080508PNER-ML XNKT080508PNSR-MM XNKT080512PNSR-MM	XNKT080516PNSR-MM XNKT080520PNSR-MM	E93		
	RM3PM new 3000/4000		Ø20~Ø50	XNKT060405PNER-ML XNKT060405PNSR-MM XNKT060408PNER-ML XNKT060408PNSR-MM XNCT080504PNFR-MA XNCT080508PNFR-MA XNCT080512PNFR-MA XNCT080520PNFR-MA	XNKT080508PNER-ML XNKT080508PNSR-MM XNKT080512PNER-ML XNKT080512PNSR-MM XNKT080516PNER-ML XNKT080516PNSR-MM XNKT080520PNER-ML XNKT080520PNSR-MM	E94		
RM4	90°	RM4PS3000		Ø14~Ø50	LNEX100605PNR-MF LNMX100605PNR-MF LNEX100605PNR-MM LNMX100605PNR-MM LNEX100608PNR-MF LNMX100608PNR-MF	LNEX100608PNR-MM LNMX100608PNR-MM LNEX100605PNR-MA LNEX100605PNL-MM LNMX100605PNL-MM		E105
		RM4PS4000		Ø32~Ø63	LNEX151004PNR-MF LNMX151004PNR-MF LNEX151004PNR-MM LNMX151004PNR-MM LNEX151008PNR-MF LNMX151008PNR-MF LNEX151008PNR-MM LNMX151008PNR-MM	LNEX151016PNR-MF LNMX151016PNR-MF LNEX151016PNR-MM LNMX151016PNR-MM LNEX151004PNR-MA LNEX151008PNR-MA LNEX151008PNL-MM LNMX151008PNL-MM		



Shanks/Modulars

Type	A.A	Designation	Shape	Cutter Diameter	Application		Features	Page
RM4	90°	RM4ZS3000		Ø25~Ø40	LNEX100605PNL-MM	LNMX100605PNL-MM	<ul style="list-style-type: none"> Economical 4 corners. Optimal insert application for vertical machining 	E109
		RM4PM3000		Ø14~Ø50	LNEX100605PNR-MF LNMX100605PNR-MF LNEX100605PNR-MM LNMX100605PNR-MM LNEX100608PNR-MF LNMX100608PNR-MF	LNEX100608PNR-MM LNMX100608PNR-MM LNEX100605PNR-MA LNEX100605PNL-MM LNMX100605PNL-MM	 <ul style="list-style-type: none"> Economical 4 corners. Screw on type for slotting, facing. 	E107
		RM4ZM3000		Ø25~Ø40	LNEX100605PNL-MM	LNMX100605PNL-MM	<ul style="list-style-type: none"> Economical 4 corners. Optimal insert application for vertical machining 	E109
RM6	90°	RM6PS-WN04 new		Ø20~Ø32	WNGX040304PNFR-MA WNGX040308PNFR-MA WNGX040312PNFR-MA WNGX040316PNFR-MA WNGX040304PNER-ML WNGX040308PNER-ML	WNGX040312PNER-ML WNGX040316PNER-ML WNGX040304PNSR-MM WNGX040308PNSR-MM WNGX040312PNSR-MM WNGX040316PNSR-MM	 <ul style="list-style-type: none"> Improved productivity and high-quality shouldering through high speed and high feed machining 	E112
		RM6PS-WN08 new		Ø32~Ø50	WNGX080604PNFR-MA WNGX080608PNFR-MA WNGX080612PNFR-MA WNGX080616PNFR-MA WNGX080620PNFR-MA WNGX080604PNER-ML WNGX080608PNER-ML WNGX080612PNER-ML	WNGX080616PNER-ML WNGX080620PNER-ML WNGX080604PNSR-MM WNGX080608PNSR-MM WNGX080612PNSR-MM WNGX080616PNSR-MM WNGX080620PNSR-MM		E113
		RM6PM-WN04 new	Ø20~Ø32	WNGX040304PNFR-MA WNGX040308PNFR-MA WNGX040312PNFR-MA WNGX040316PNFR-MA WNGX040304PNER-ML WNGX040308PNER-ML	WNGX040312PNER-ML WNGX040316PNER-ML WNGX040304PNSR-MM WNGX040308PNSR-MM WNGX040312PNSR-MM WNGX040316PNSR-MM	E114		
		RM6PM-WN08 new	Ø32~Ø40	WNGX080604PNFR-MA WNGX080608PNFR-MA WNGX080612PNFR-MA WNGX080616PNFR-MA WNGX080620PNFR-MA WNGX080604PNER-ML WNGX080608PNER-ML WNGX080612PNER-ML	WNGX080616PNER-ML WNGX080620PNER-ML WNGX080604PNSR-MM WNGX080608PNSR-MM WNGX080612PNSR-MM WNGX080616PNSR-MM WNGX080620PNSR-MM	E114		



RM3PC(M)3000 new

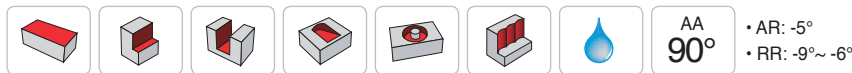
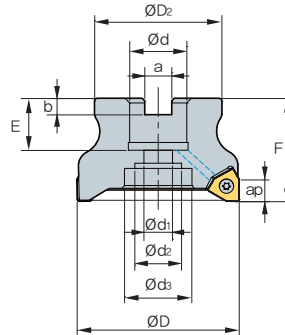

Designation		⚙️	ØD	ØD2	Ød	Ød1	Ød2	Ød3	a	b	E	F	ap	⚖️
RM3PCM	3040HR	5	40	35	16	9	14	-	8.4	5.6	16	40	5.5	0.2
	3040HR-M	6	40	35	16	9	14	-	8.4	5.6	16	40	5.5	0.2
	3050HR	6	50	41	22	11	18	-	10.4	6.3	20	40	5.5	0.3
	3050HR-M	7	50	41	22	11	18	-	10.4	6.3	20	40	5.5	0.3
	3063HR	7	63	49	22	11	18	-	10.4	6.3	20	40	5.5	0.49
	3063HR-M	8	63	49	22	11	18	-	10.4	6.3	20	40	5.5	0.49
RM3PC (RM3PCM)	3080HR	8	80	57	25.4 (27)	14	25	35	9.5 (12.4)	6 (7)	25 (23)	50	5.5	0.87
	3080HR-M	10	80	57	25.4 (27)	14	25	35	9.5 (12.4)	6 (7)	25 (23)	50	5.5	0.88

() Metric size

Available inserts

XNKT-ML XNKT-MM



Designation	Cermet		Coated											Uncoated			page		
	CN2000	CN30	NCM325	NC5330	NCM535	NCM545	PC2505	PC2510	PC3600	PC3700	PC6510	PC9530	PC9540	PC5300	PC5400	ST30A		G10	H01
XNKT	060405PNER-ML							●	●	●	●		●	●	●				E30
	060405PNSR-MM							●	●	●	●		●	●	●				
	060408PNER-ML									●	●			●	●				
	060408PNSR-MM							●	●	●	●			●	●				

Available arbors

Designation	Available arbors	
	RM3PC	RM3PCM
RM3PC(M) 3040HR	-	BT□□-FMC16-□□
3040HR-M		
3050HR		
3050HR-M		
3063HR	-	BT□□-FMC22-□□
3063HR-M		
3080HR	BT□□-FMA25.4-□□	BT□□-FMC27-□□
3080HR-M		

Parts

Specification	Screw	Wrench
Ø40~Ø80	FTNA0306	TW09S

Available inserts E30 Available arbors and bolt E400~E402



RM3PC(M)4000 new

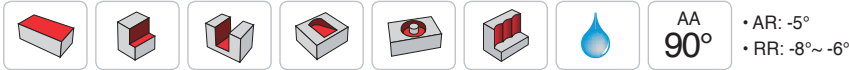
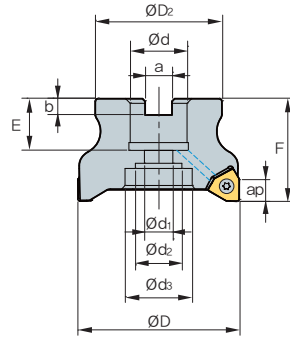

(mm)

Designation	Flutes	ØD	ØD2	Ød	Ød1	Ød2	Ød3	a	b	E	F	ap	kg	
RM3PCM	4040HR	3	40	35	16	9	14	-	8.4	5.6	19	40	8.0	0.19
	4040HR-M	4	40	35	16	9	14	-	8.4	5.6	19	40	8.0	0.19
	4050HR	4	50	42	22	11	18	-	10.4	6.3	20	40	8.0	0.28
	4050HR-M	5	50	42	22	11	18	-	10.4	6.3	20	40	8.0	0.29
	4063HR	5	63	49	22	11	18	-	10.4	6.3	20	40	8.0	0.54
	4063HR-M	6	63	49	22	11	18	-	10.4	6.3	20	40	8.0	0.53
RM3PC (RM3PCM)	4080HR	5	80	57	25.4 (27)	14	20	35	9.5 (12.4)	6 (7)	25 (23)	50	8.0	1.08
	4080HR-M	7	80	57	25.4 (27)	14	20	35	9.5 (12.4)	6 (7)	25 (23)	50	8.0	1.06
	4100HR	7	100	67	31.75 (32)	18	26	42	12.7 (14.4)	8 (8)	33 (25)	63 (50)	8.0	1.68
	4100HR-M	8	100	67	31.75 (32)	18	26	42	12.7 (14.4)	8 (8)	33 (25)	63 (50)	8.0	1.67
	4125HR	8	125	90	38.1 (40)	22	32	52	15.9 (16.4)	9 (10)	38 (29)	63	8.0	3.45
	4125HR-M	10	125	90	38.1 (40)	22	32	52	15.9 (16.4)	9 (10)	38 (29)	63	8.0	3.45

Available inserts

() Metric size

XNCT-MA XNKT-ML XNKT-MM



Designation	Cermet		Coated											Uncoated			page		
	CN2000	CN30	NCM325	NC5330	NCM635	NCM645	PC2505	PC2510	PC3600	PC3700	PC6510	PC9530	PC9540	PC5300	PC5400	ST30A		G10	H01
XNCT	080504PNFR-MA																		●
	080508PNFR-MA																		●
	080512PNFR-MA																		●
	080520PNFR-MA																		●
XNKT	080504PNER-ML																		
	080504PNSR-MM																		
	080508PNER-ML					●													
	080508PNSR-MM					●		●	●	●	●		●	●	●				
	080512PNER-ML																		
	080512PNSR-MM							●	●	●									
	080516PNER-ML																		
	080516PNSR-MM																		
	080520PNER-ML																		
	080520PNSR-MM																		

E29
E30

Available arbors

Designation	Available arbors	
	RM3PC	RM3PCM
RM3PC(M) 4040HR	-	BT□□-FMC16-□□
4050HR	-	BT□□-FMC22-□□
4063HR		
4080HR	BT□□-FMA25.4-□□	BT□□-FMC27-□□
4100HR	BT□□-FMA31.75-□□	BT□□-FMC32-□□
4125HR	BT□□-FMA38.1-□□	BT□□-FMC40-□□

Parts

Specification	Screw	Wrench
Ø40~Ø125	FTNA0408	TW15S

Available inserts E29, E30 Available arbors and bolt E400~E402



RM3PC(M)5000 new

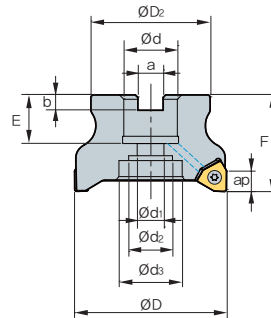

AA
90°
• AR: -5°
• RR: -7°

(mm)

Designation	ØD	ØD2	Ød	Ød1	Ød2	Ød3	a	b	E	F	ap	kg	
RM3PC 5080HR	5	80	57	25.4 (27)	14	20	35	9.5 (12.4)	6 (7)	24 (23)	50	12.0	0.84
(RM3PCM) 5080HR-M	7	80	57	25.4 (27)	14	20	35	9.5 (12.4)	6 (7)	24 (23)	50	12.0	0.84
5100HR	7	100	67	31.75 (32)	18	28	45	12.7 (14.4)	8 (8)	32 (25)	63	12.0	1.76
5100HR-M	8	100	67	31.75 (32)	18	28	45	12.7 (14.4)	8 (8)	32 (25)	63	12.0	1.76
5125HR	8	125	90	38.1 (40)	22	32	52	15.9 (16.4)	9 (10)	38 (30)	63	12.0	2.70
5125HR-M	10	125	90	38.1 (40)	22	32	52	15.9 (16.4)	9 (10)	38 (30)	63	12.0	2.70

() Metric size

Available inserts



Designation	Cermet		Coated											Uncoated			page		
	CN2000	CN30	NCM325	NC5330	NCM535	NCM545	PC2505	PC2510	PC3600	PC3700	PC6510	PC9530	PC9540	PC5300	PC5400	ST30A		G10	H01
XNCT 120608PNFR-MA																			
XNKT 120604PNSR-MM																			
120608PNER-ML																			
120608PNSR-MM																			
120612PNER-ML																			
120612PNSR-MM																			
120616PNER-ML																			
120616PNSR-MM																			
120620PNER-ML																			
120620PNSR-MM																			

Available arbors

Designation	Available arbors	
	RM3PC	RM3PCM
RM3PC(M) 5080HR	BT□□ -FMA25.4-□□	BT□□ -FMC27-□□
5100HR	BT□□ -FMA31.75-□□	BT□□ -FMC32-□□
5125HR	BT□□ -FMA38.1-□□	BT□□ -FMC40-□□

Parts

Specification	Screw	Wrench
Ø80-Ø125	FTNA0511	TW20-100

Available inserts E29, E30 Available arbors and bolt E400~E402

RM3PS3000 new

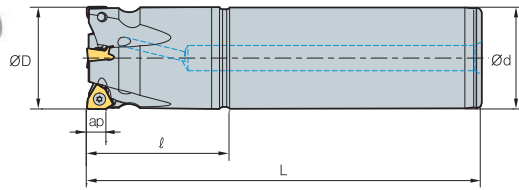

Fig. 1

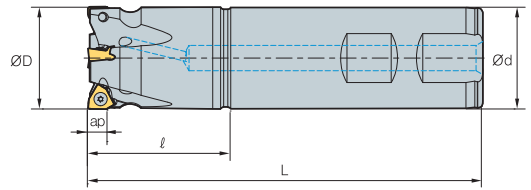
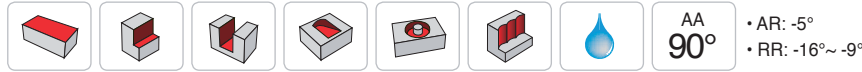

Fig. 2



AA
90°

• AR: -5°
• RR: -16°~ -9°

(mm)

Designation		ØD	Ød	ℓ	L	ap		Fig.
RM3PS 3020HR-2S20	2	20	20	35	100	5.5	0.21	2
3020HR-2L20	2	20	20	35	200	5.5	0.43	1
3021HR-2S20	2	21	20	30	100	5.5	0.21	2
3021HR-2L20	2	21	20	30	200	5.5	0.43	1
3025HR-3S20	3	25	20	35	115	5.5	0.27	2
3025HR-3L20	3	25	20	35	200	5.5	0.46	1
3025HR-3S25	3	25	25	40	115	5.5	0.36	2
3025HR-3L25	3	25	25	40	200	5.5	0.66	1
3026HR-2S20	2	26	20	35	115	5.5	0.29	2
3026HR-2L20	2	26	20	35	200	5.5	0.47	1
3026HR-3S20	3	26	20	35	115	5.5	0.28	2
3026HR-3L20	3	26	20	35	200	5.5	0.47	1
3026HR-2S25	2	26	25	35	115	5.5	0.37	2
3026HR-2L25	2	26	25	35	200	5.5	0.68	1
3026HR-3S25	3	26	25	35	115	5.5	0.37	2
3026HR-3L25	3	26	25	35	200	5.5	0.68	1
3032HR-3S25	3	32	25	42	125	5.5	0.48	2
3032HR-3L25	3	32	25	42	200	5.5	0.74	1
3032HR-4S25	4	32	25	42	125	5.5	0.48	2
3032HR-4L25	4	32	25	42	200	5.5	0.74	1
3032HR-4S32	4	32	32	42	125	5.5	0.68	2
3032HR-4L32	4	32	32	42	200	5.5	1.13	1
3033HR-3S25	3	33	25	42	125	5.5	0.49	2
3033HR-3L25	3	33	25	42	200	5.5	0.75	1
3033HR-4S25	4	33	25	42	125	5.5	0.49	2
3033HR-4L25	4	33	25	42	200	5.5	0.75	1
3033HR-4S32	4	33	32	42	125	5.5	0.70	2
3033HR-4L32	4	33	32	42	200	5.5	1.14	1
3040HR-4S32	4	40	32	45	130	5.5	0.83	2
3040HR-4L32	4	40	32	45	200	5.5	1.24	1
3040HR-5S32	5	40	32	45	130	5.5	0.83	2
3040HR-5L32	5	40	32	45	200	5.5	1.24	1

() Metric size

Available inserts

XNKT-ML XNKT-MM



Designation	Cermet		Coated										Uncoated			page			
	CN2000	CN30	NCM325	NC5330	NCM535	NCM545	PC2505	PC2510	PC3600	PC3700	PC6510	PC9530	PC9540	PC5300	PC5400		ST30A	G10	H01
XNKT 060405PNER-ML							●	●	●	●	●		●	●	●				E30
060405PNSR-MM							●	●	●	●	●		●	●	●				
060408PNER-ML							●	●	●	●	●		●	●	●				
060408PNSR-MM							●	●	●	●	●		●	●	●				

Parts

Specification		
Ø20~Ø40	FTNA0306	TW09S

Available inserts E30



RM3PS4000 new

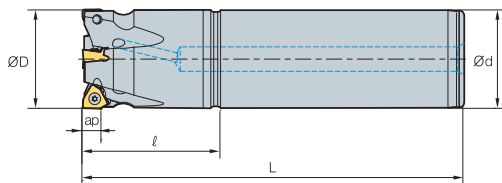

Fig. 1

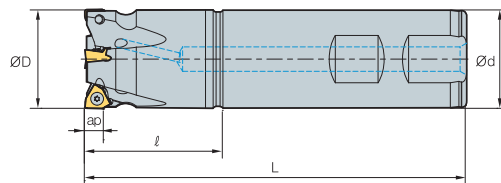

Fig. 2

• AR: -5°
• RR: -11°~ -7°

(mm)

Designation		ØD	Ød	l	L	ap		Fig.
RM3PS 4032HR-3S32	3	32	32	42	125	8	0.67	2
4032HR-3L32	3	32	32	42	200	8	1.11	1
4033HR-3S32	3	33	32	42	125	8	0.68	2
4033HR-3L32	3	33	32	42	200	8	1.13	1
4040HR-3S32	3	40	32	42	130	8	0.8	2
4040HR-3L32	3	40	32	42	200	8	1.21	1
4040HR-4S32	4	40	32	42	130	8	0.81	2
4040HR-4L32	4	40	32	42	200	8	1.22	1
4050HR-4S32	4	50	32	42	135	8	0.99	2
4050HR-4L32	4	50	32	42	200	8	1.38	1
4050HR-4S40	4	50	40	42	135	8	1.32	2
4050HR-4L40	4	50	40	42	200	8	1.94	1
4050HR-5S32	5	50	32	42	135	8	1.02	2
4050HR-5L32	5	50	32	42	200	8	1.4	1
4050HR-5S40	5	50	40	42	135	8	1.35	2
4050HR-5L40	5	50	40	42	200	8	1.96	1
4063HR-5S32	5	63	32	42	135	8	1.31	2
4063HR-5L32	5	63	32	42	200	8	1.7	1
4063HR-5S40	5	63	40	42	135	8	1.64	2
4063HR-5L40	5	63	40	42	200	8	2.25	1
4063HR-6S32	6	63	32	42	135	8	1.31	2
4063HR-6L32	6	63	32	42	200	8	1.7	1
4063HR-6S40	6	63	40	42	135	8	1.64	2
4063HR-6L40	6	63	40	42	200	8	2.26	1

Available inserts



Designation	Cermet		Coated										Uncoated			page			
	CN2000	CN30	NCM325	NC5330	NCM535	NCM545	PC2505	PC2510	PC3600	PC3700	PC6510	PC9530	PC9540	PC5300	PC5400		ST30A	G10	H01
XNCT 080504PNFR-MA																		●	E29 E30
080508PNFR-MA																		●	
080512PNFR-MA																		●	
080520PNFR-MA																		●	
XNKT 080504PNER-ML										●				●	●				
080504PNSR-MM										●	●			●	●				
080508PNER-ML					●					●	●			●	●				
080508PNSR-MM					●			●	●	●	●			●	●				
080512PNER-ML								●	●	●				●	●				
080512PNSR-MM								●	●	●				●	●				
080516PNER-ML														●	●				
080516PNSR-MM								●	●	●				●	●				
080520PNER-ML														●	●				
080520PNSR-MM								●	●	●				●	●				

Parts

Specification		
Ø32~Ø63	FTNA0408	TW15S

Available inserts E29, E30

RM3PM3000/4000 new

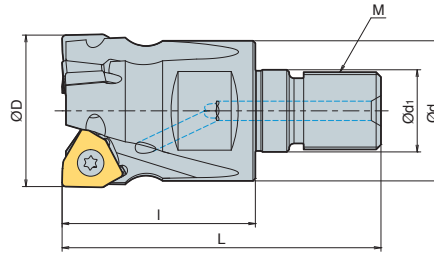

AA **90°**
 • AR: -5°
 • RR: -16°~ -7°

(mm)

Designation		ØD	Ød	Ød1	I	L	M	ap	
RM3PM	3020HR-2-M10	2	20	18	10.5	30	M10	5.5	0.06
	3025HR-3-M12	3	25	21	12.5	35	M12	5.5	0.1
	3032HR-4-M16	4	32	29	17	40	M16	5.5	0.21
	3040HR-5-M16	5	40	29	17	40	M16	5.5	0.26
RM3PM	4032HR-3-M16	3	32	29	17	40	M16	8	0.21
	4040HR-4-M16	4	40	29	17	50	M16	8	0.33
	4050HR-5-M16	5	50	29	17	55	M16	8	0.49

Available inserts



Designation	Cermet		Coated										Uncoated			page			
	CN2000	CN30	NCM325	NC5330	NCM535	NCM545	PC2505	PC2510	PC3600	PC3700	PC6510	PC9530	PC9540	PC5300	PC5400		ST30A	G10	H01
3000 type	XNKT	060405PNER-ML						●	●	●	●		●	●	●				
		060405PNSR-MM					●	●	●	●	●		●	●	●				
		060408PNER-ML							●	●	●		●	●	●				
		060408PNSR-MM					●	●	●	●	●		●	●	●				
4000 type	XNCT	080504PNFR-MA																●	
		080508PNFR-MA																●	
		080512PNFR-MA																●	
		080520PNFR-MA																●	
	XNKT	080504PNER-ML								●					●	●			
		080504PNSR-MM								●				●	●	●			
		080508PNER-ML					●			●	●			●	●	●			
		080508PNSR-MM					●			●	●			●	●	●			
		080512PNER-ML								●	●			●	●	●			
		080512PNSR-MM								●	●			●	●	●			
		080516PNER-ML								●	●			●	●	●			
		080516PNSR-MM								●	●			●	●	●			
080520PNER-ML													●	●					
080520PNSR-MM								●	●	●			●	●					

Available adaptor

Designation	Available adaptor	
RM3PM	3020HR-2-M10	MAT-M10
	3025HR-3-M12	MAT-M12
	3032HR-4-M16	MAT-M16
	3040HR-5-M16	MAT-M16
RM3PM	4032HR-3-M16	MAT-M16
	4040HR-4-M16	MAT-M16
	4050HR-5-M16	MAT-M16

Designation: RM3PM4032HR-M16
 Modular head threading measure size (M16)

II

Adaptor spec.: MAT-M16-035-S32S
 Adaptor threading measure (M16)

Parts

Specification		
Ø20~Ø40 (3000 type)	FTNA0306	TW09S
Ø32~Ø50 (4000 type)	FTNA0408	TW15S

Available inserts E29, E30 Available adaptor E371~E372



RM4PC(M)3000

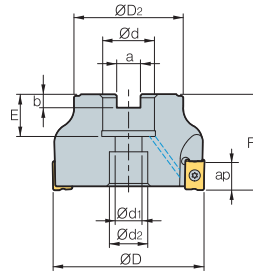
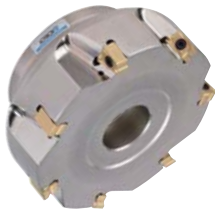

• AR: -6°
• RR: -19°~ -13°

(mm)

Designation		ØD	ØD2	Ød	Ød1	Ød2	a	b	E	F	ap		Bolt	
RM4PCM	3040HR	4	40	35	16	9	14	8.4	5.6	19	40	9.0	0.24	SB0825
	3040HR-M	5	40	35	16	9	14	8.4	5.6	19	40	9.0	0.23	SB0825
	3050HR	5	50	42	22	11	18	10.4	6.3	20	40	9.0	0.36	SB1025
	3050HR-M	7	50	42	22	11	18	10.4	6.3	20	40	9.0	0.35	SB1025
	3063HR	7	63	49	22	11	18	10.4	6.3	20	40	9.0	0.61	SB1025
	3063HR-M	9	63	49	22	11	18	10.4	6.3	20	40	9.0	0.6	SB1025
RM4PC (RM4PCM)	3080HR	8	80	57	25.4 (27)	14	20	9.5 (12.4)	6.0 (7.0)	25 (23)	50	9.0	1.25 (1.24)	SB1230
	3080HR-M	10	80	57	25.4 (27)	14	20	9.5 (12.4)	6.0 (7.0)	25 (23)	50	9.0	1.24 (1.23)	SB1230
	3100HR	9	100	67	31.75(32)	18	26	12.7 (14.4)	8.0 (8.0)	33 (25)	63 (50)	9.0	2.46 (1.94)	SB1630
	3100HR-M	12	100	67	31.75 (32)	18	26	12.7 (14.4)	8.0 (8.0)	33 (25)	63 (50)	9.0	2.44 (1.93)	SB1630

() Metric size

Available inserts

LNEX-MA LNM(E)X-MF LNM(E)X-MM

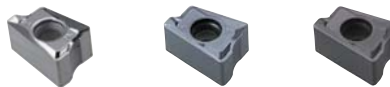

Designation	Cermat		Coated											Uncoated			page	
	CN2000	CN30	NCM325	NC5330	NCM535	NCM545	PC2505	PC2010	PC3600	PC3700	PC8510	PC9530	PC9540	PC5300	PC5400	ST30A		G10
LNEX	100605PNR-MF																	
	100605PNR-MM									●	●			●	●			
	100605PNR-MA																	●
	100608PNR-MF									●	●			●	●			
	100608PNR-MM										●			●	●			
LNMX	100605PNR-MF								●		●			●	●			
	100605PNR-MM								●	●	●	●		●	●			
	100608PNR-MF								●		●			●	●			
	100608PNR-MM								●	●				●	●			

Available arbors

Designation	Available arbors	
	RM4PC	RM4PCM
RM4PC(M)	3040HR	BT□□-FMC16-□□
	3040HR-M	
	3050HR	
	3050HR-M	
	3063HR	
	3063HR-M	
		BT□□-FMC22-□□

Designation	Available arbors	
	RM4PC	RM4PCM
RM4PC(M)	3080HR	BT□□-FMC27-□□
	3080HR-M	
	3100HR	
	3100HR-M	
		BT□□-FMA25.4-□□
		BT□□-FMA31.75-□□

Parts

Specification		
Ø40~Ø100	FTKA0307	TW09S

Available inserts E11 Available arbors and bolt E400~E402

RM4PC(M)4000

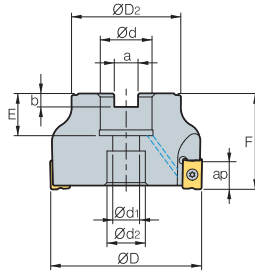
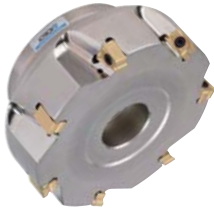

Fig. 1

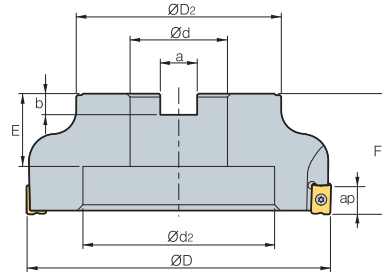

Fig. 2



AA
90°
• AR: -6°
• RR: -19° ~ -13°

(mm)

Designation		$\varnothing D$	$\varnothing D_2$	$\varnothing d$	$\varnothing d_1$	$\varnothing d_2$	a	b	E	F	ap		Bolt	Fig.	
RM4PCM	4040HR	3	40	36	16	11	18	8.4	5.6	19	40	14	0.23	SB0825	1
	4050HR	3	50	46	22	11	18	10.4	6.3	20	40	14	0.36	SB1025	1
	4050HR-M	4	50	46	22	11	18	10.4	6.3	20	40	14	0.35	SB1025	1
	4050HR-H	5	50	46	22	11	18	10.4	6.3	20	40	14	0.36	SB1025	1
	4063HR	4	63	49	22	11	18	10.4	6.3	20	40	14	0.56	SB1025	1
	4063HR-M	6	63	49	22	11	18	10.4	6.3	20	40	14	0.57	SB1025	1
RM4PC (RM4PCM)	4080HR	5	80	57	25.4 (27)	14	20	9.5 (12.4)	6.0 (7.0)	25 (23)	50	14	1.18 (1.16)	SB1230	1
	4080HR-M	7	80	57	25.4 (27)	14	20	9.5 (12.4)	6.0 (7.0)	25 (23)	50	14	1.17 (1.14)	SB1230	1
	4080HR-H	8	80	57	25.4 (27)	14	20	9.5 (12.4)	6.0 (7.0)	25 (23)	50	14	1.17 (1.14)	SB1230	1
	4100HR	5	100	67	31.75 (32)	18	26	12.7 (14.4)	8.0 (8.0)	33 (25)	63 (50)	14	2.35 (1.84)	SB1630	1
	4100HR-M	8	100	67	31.75 (32)	18	26	12.7 (14.4)	8.0 (8.0)	33 (25)	63 (50)	14	2.31 (1.82)	SB1630	1
	4100HR-H	9	100	67	31.75 (32)	18	26	12.7 (14.4)	8.0 (8.0)	33 (25)	63 (50)	14	2.31 (1.82)	SB1630	1
	4125HR	7	125	87	38.1 (40)	22	32	15.9 (16.4)	10 (9.0)	35 (30)	63	14	3.87 (3.79)	SB2040	1
	4125HR-M	10	125	87	38.1 (40)	22	32	15.9 (16.4)	10 (9.0)	35 (30)	63	14	3.82 (3.70)	SB2040	1
	4160R	8	160	107	50.8 (40)	-	100	19 (16.4)	11 (9.0)	38 (32)	63	14	5.0 (4.75)	MBA	2
	4160R-M	12	160	107	50.8 (40)	-	100	19 (16.4)	11 (9.0)	38 (32)	63	14	4.97 (4.71)	MBA	2

() Metric size

Available inserts

LNEX-MA LNM(E)X-MF LNM(E)X-MM

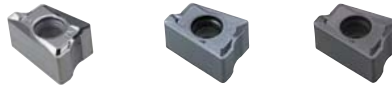

Designation	Cement									page	Designation	Cement									page																	
	CN2000	CN30	NCM325	NC5330	NCM535	NCM545	PC2505	PC2010	PC3600			PC3700	PC6510	PC9530	PC9540	PC3300	PC5400	ST30A	H01	Designation		CN2000	CN30	NCM325	NC5330	NCM535	NCM545	PC2505	PC2010	PC3600	PC3700	PC6510	PC9530	PC9540	PC3300	PC5400	ST30A	H01
LNEX	151004PNR-MF																	E11	151004PNR-MF																	E11		
	151004PNR-MM																			151004PNR-MM																		
	151004PNR-MA																			151008PNR-MF																		
	151008PNR-MF																			151008PNR-MM																		
	151008PNR-MM																			151008PNR-MA																		
	151016PNR-MF																			151016PNR-MM																		
	151016PNR-MM																																					
	151016PNR-MA																																					

Available arbors

Designation	Available arbors	
	RM4PC	RM4PCM
RM4PC(M)	4050HR	
	4050HR-M	
	4063HR	
	4063HR-M	BT□□-FMC22-□□
	4080HR	BT□□-FMA25.4-□□
	4080HR-M	BT□□-FMC27-□□

Designation	Available arbors	
	RM4PC	RM4PCM
RM4PC(M)	4100HR	
	4100HR-M	BT□□-FMA31.75-□□
	4125HR	
	4125HR-M	BT□□-FMA38.1-□□
	4160R	BT□□-FMA50.8-□□
	4160R-M	

Parts

Specification		
$\varnothing 50 \sim \varnothing 160$	FTKA0412B	TW15S

Available inserts E11 Available arbors and bolt E400~E402



RM4PFCB3000

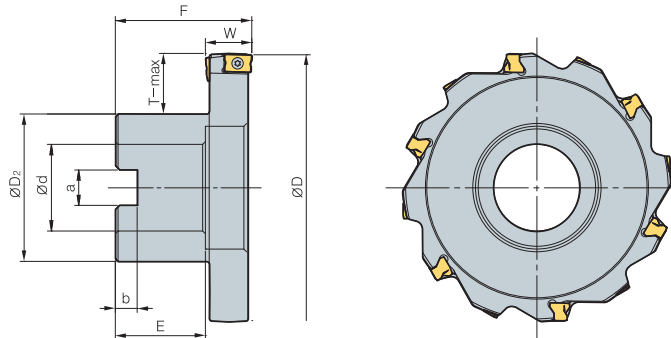
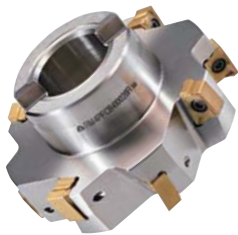

(mm)

Designation		ØD	ØD ₂	Ød	a	b	E	F	W	T-max
RM4PFCB 308015R	10	80	40	25.4	9.5	6	25	50	15	19
	10	80	40	25.4	9.5	6	25	50	17	19
310015R	12	100	54	31.75	12.7	8	32	50	15	22
310017R	12	100	54	31.75	12.7	8	32	50	17	22
312515R	14	125	70	38.1	15.9	10	38	60	15	26
312517R	14	125	70	38.1	15.9	10	38	60	17	26
316015R	16	160	70	38.1	15.9	10	38	60	15	44
316017R	16	160	70	38.1	15.9	10	38	60	17	44

Available inserts

LNM(E)X-MM



Designation	Cermet		Coated										Uncoated			page		
	CN2000	CN30	NCM925	NC5330	NCM635	NCM645	PC2505	PC2010	PC3600	PC3700	PC6510	PC9530	PC9540	PC5300	PC5400		ST30A	G10
LNEX 100605PNR-MM									●	●				●	●			
										●				●	●			
LNMX 100605PNR-MM								●	●	●	●			●	●			
								●	●	●				●	●			

Available arbors

Designation	Available arbors
RM4PFCB 308015R	BT□□ -FMA25.4-□□
	BT□□ -FMA31.75-□□
308017R	
310015R	
310017R	
312515R	
312517R	
316015R	BT□□ -FMA38.1-□□
316017R	

Parts

Specification		
Ø80-Ø160	FTKA0307	TW09S

Available inserts E11 Available arbors and bolt E400-E402

RM4PFCB4000

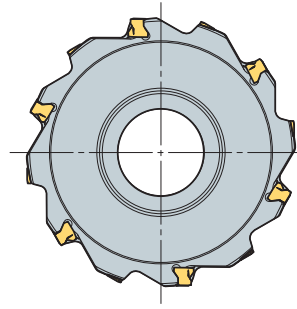
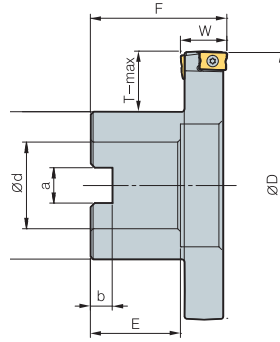

(mm)

Designation		ØD	ØD ₂	Ød	a	b	E	F	W	T-max
RM4PFCB	408022R	6	80	40	25.4	9.5	25	50	22	19
	408024R	6	80	40	25.4	9.5	25	50	24	19
	408026R	6	80	40	25.4	9.5	25	50	26	19
	408028R	6	80	40	25.4	9.5	25	50	28	19
	410022R	8	100	54	31.75	12.7	32	50	22	22
	410024R	8	100	54	31.75	12.7	32	50	24	22
	410026R	8	100	54	31.75	12.7	32	50	26	22
	410028R	8	100	54	31.75	12.7	32	50	28	22
	412522R	10	125	70	38.1	15.9	38	60	22	26
	412524R	10	125	70	38.1	15.9	38	60	24	26
	412526R	10	125	70	38.1	15.9	38	60	26	26
	412528R	10	125	70	38.1	15.9	38	60	28	26
	416022R	12	160	70	38.1	15.9	38	60	22	44
	416024R	12	160	70	38.1	15.9	38	60	24	44
	416026R	12	160	70	38.1	15.9	38	60	26	44
	416028R	12	160	70	38.1	15.9	38	60	28	44

Available inserts

LNM(E)X-MM



Designation	Cermet		Coated										Uncoated			page		
	CN2000	CN30	NCM325	NC5330	NCM535	NCM545	PC2505	PC2010	PC3600	PC3700	PC6510	PC9530	PC9540	PC5300	PC5400		ST30A	G10
LNEX 151008PNR-MM									●	●				●	●			
151008PNL-MM										●	●			●	●			
LNMX 151008PNR-MM					●			●	●	●	●			●	●			
151008PNL-MM								●						●	●			

Available arbors

Designation	Available arbors	Designation	Available arbors
RM4PFCB	408022R	RM4PFCB	412522R
	408024R		412524R
	408026R		412526R
	408028R		412528R
	410022R		416022R
	410024R		416024R
410026R	416026R		
410028R	416028R		

BT□□-FMA25.4-□□

BT□□-FMA31.75-□□

BT□□-FMA38.1-□□

Parts

Specification		
Ø80~Ø160	FTKA0412B	TW15S

Available inserts E11 Available arbors and bolt E400~E402



RM4PHCB3000

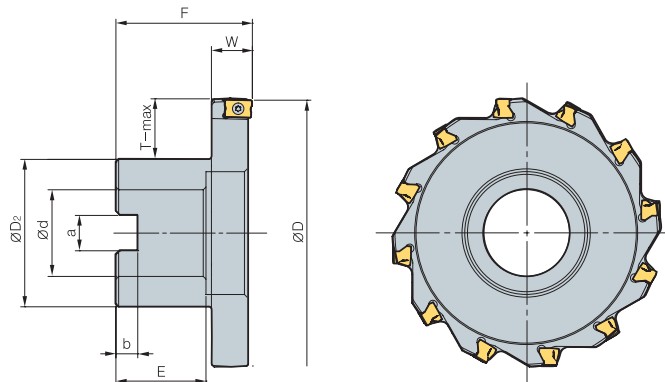
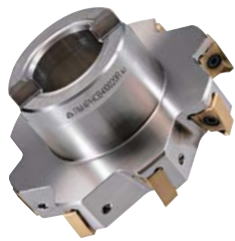

(mm)

Designation		ØD	ØD2	Ød	a	b	E	F	W	T-max	
RM4PHCB	308015R	10	80	40	25.4	9.5	6	25	50	15	19
	310015R	12	100	54	31.75	12.7	8	32	50	15	22
	312515R	14	125	70	38.1	15.9	10	38	60	15	26
	316015R	16	160	70	38.1	15.9	10	38	60	15	44

Available inserts

LNEX-MA LNM(E)X-MF LNM(E)X-MM

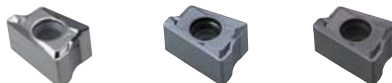

Designation	Cermet		Coated											Uncoated			page	
	CN2000	CN30	NCM825	NC5330	NCM635	NCM645	PC2505	PC2010	PC3600	PC3700	PC6510	PC9530	PC9540	PC5300	PC5400	ST30A		G10
LNEX	100605PNR-MF										●			●	●			
	100605PNR-MM									●	●			●	●			
	100605PNR-MA																	●
	100608PNR-MF									●	●			●	●			
	100608PNR-MM										●			●	●			
LNMX	100605PNR-MF							●		●			●	●				
	100605PNR-MM							●	●	●	●		●	●				
	100608PNR-MF							●		●			●	●				
	100608PNR-MM							●	●	●			●	●				

Available arbors

Designation	Available arbors	
RM4PHCB	308015R	BT□□ -FMA25.4-□□
	310015R	BT□□ -FMA31.75-□□
	312515R	BT□□ -FMA38.1-□□
	316015R	

Parts

Specification		
Ø80-Ø160	FTKA0307	TW09S

Available inserts E11 Available arbors and bolt E400-E402

RM4PHCB4000

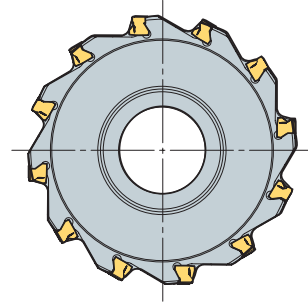
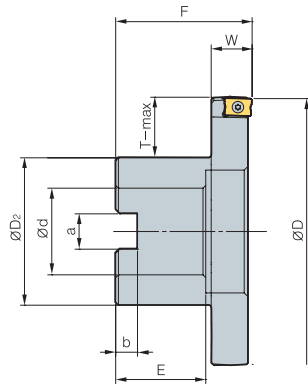
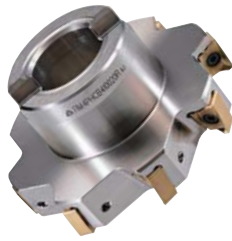

(mm)

Designation		ØD	ØD2	Ød	a	b	E	F	W	T-max	
RM4PHCB	408020R	6	80	40	25.4	9.5	6	25	50	20	19
	410020R	8	100	54	31.75	12.7	8	32	50	20	22
	412520R	10	125	70	38.1	15.9	10	38	60	20	26
	416020R	12	160	70	38.1	15.9	10	38	60	20	44

Available inserts

LNEX-MA LNM(E)X-MF LNM(E)X-MM

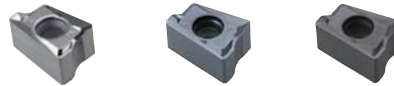

Designation	Cermet		Coated											Uncoated			page		
	CN2000	CN30	NCM325	NC5330	NCM535	NCM545	PC2505	PC2010	PC3600	PC3700	PC6510	PC9530	PC9540	PC5300	PC5400	ST30A		G10	H01
LNEX	151004PNR-MF										●			●	●				
	151004PNR-MM										●			●	●				
	151004PNR-MA																		●
	151008PNR-MF										●			●	●				
	151008PNR-MM									●	●			●	●				
	151008PNR-MA																		●
	151016PNR-MF										●			●	●				
	151016PNR-MM										●			●	●				
LNMX	151004PNR-MF								●	●	●			●	●				
	151004PNR-MM								●	●	●			●	●				
	151008PNR-MF					●			●	●	●			●	●				
	151008PNR-MM					●			●	●	●	●		●	●				
	151016PNR-MF								●	●	●			●	●				
	151016PNR-MM								●	●	●			●	●				

Available arbors

Designation	Available arbors
RM4PHCB 408020R	BT□□ -FMA25.4-□□
410020R	BT□□ -FMA31.75-□□
412520R	BT□□ -FMA38.1-□□
416020R	

Parts

Specification		
Ø80~Ø160	FTKA0412B	TW15S

Available inserts E11 Available arbors and bolt E400~E402



RM4PFCP3000

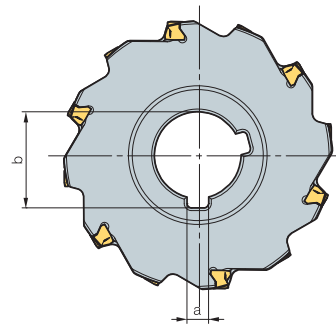
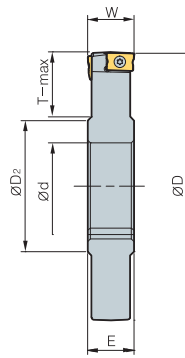

(mm)

Designation		ØD	ØD ₂	Ød	a	b	E	W	T-max
RM4PFCP 308015R	10	80	41.5	25.4	6.35	28	15	15	17
	10	80	41.5	25.4	6.35	28	17	17	17
310015R	12	100	48	31.75	7.94	35.2	15	15	24
	12	100	48	31.75	7.94	35.2	17	17	24
312515R	14	125	58	38.1	9.53	42.3	15	15	32
	14	125	58	38.1	9.53	42.3	17	17	32
316015R	16	160	58	38.1	9.53	42.3	15	15	49
	16	160	58	38.1	9.53	42.3	17	17	49

Available inserts

LN(E)X-MM



Designation	Cermet		Coated										Uncoated			page		
	CN2000	CN30	NCM325	NC5330	NCM535	NCM545	PC2505	PC2010	PC3600	PC3700	PC6510	PC9530	PC9540	PC5300	PC5400		ST30A	G10
LNEX 100605PNR-MM									●	●				●	●			
100605PNL-MM										●				●	●			
LNMX 100605PNR-MM								●	●	●	●			●	●			
100605PNL-MM								●	●	●				●	●			

Available arbors

Designation	Available arbors
RM4PFCP 308015R	BT□□-SCA25.4-□□
308017R	
310015R	
310017R	
312515R	BT□□-SCA31.75-□□
312517R	
316015R	
316017R	
	BT□□-SCA38.1-□□

Parts

Specification		
Ø80-Ø160	FTKA0307	TW09S

Available inserts E11 Available arbors and bolt E400-E402

RM4PFCP4000

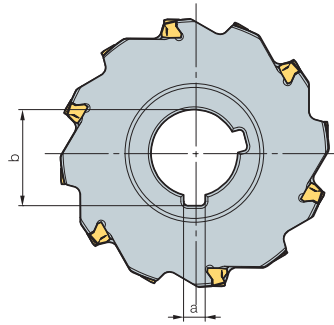
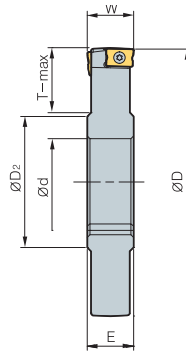

(mm)

Designation		ØD	ØD ₂	Ød	a	b	E	W	T-max	
RM4PFCP	408022R	6	80	41.5	25.4	6.35	28	22	22	17
	408024R	6	80	41.5	25.4	6.35	28	24	24	17
	408026R	6	80	41.5	25.4	6.35	28	26	26	17
	408028R	6	80	41.5	25.4	6.35	28	28	28	17
	410022R	8	100	48	31.75	7.94	35.2	22	22	24
	410024R	8	100	48	31.75	7.94	35.2	24	24	24
	410026R	8	100	48	31.75	7.94	35.2	26	26	24
	410028R	8	100	48	31.75	7.94	35.2	28	28	24
	412522R	10	125	58	38.1	9.53	42.3	22	22	32
	412524R	10	125	58	38.1	9.53	42.3	24	24	32
	412526R	10	125	58	38.1	9.53	42.3	26	26	32
	412528R	10	125	58	38.1	9.53	42.3	28	28	32
416022R	12	160	58	38.1	9.53	42.3	22	22	49	
416024R	12	160	58	38.1	9.53	42.3	24	24	49	
416026R	12	160	58	38.1	9.53	42.3	26	26	49	
416028R	12	160	58	38.1	9.53	42.3	28	28	49	

Available inserts

LN(M)E(X)-MM



Designation	Cermet		Coated										Uncoated			page		
	CN2000	CN30	NCM325	NC5330	NCM535	NCM545	PC2505	PC2010	PC3600	PC3700	PC6510	PC9530	PC9540	PC5300	PC5400		ST30A	G10
LNEX 151008PNR-MM									●	●				●	●			
LNEX 151008PNL-MM										●				●	●			
LNMX 151008PNR-MM					●				●	●	●			●	●			
LNMX 151008PNL-MM								●						●	●			

Available arbors

Designation	Available arbors	Designation	Available arbors
RM4PFCP	408022R	RM4PFCP	412522R
	408024R		412524R
	408026R		412526R
	408028R		412528R
	410022R		416022R
	410024R		416024R
	410026R		416026R
	410028R		416028R

BT□□-SCA25.4-□□

BT□□-SCA31.75-□□

BT□□-SCA38.1-□□

Parts

Specification		
Ø80~Ø160	FTKA0412B	TW15S

Available inserts E11 Available arbors and bolt E400~E402



RM4PHCP3000

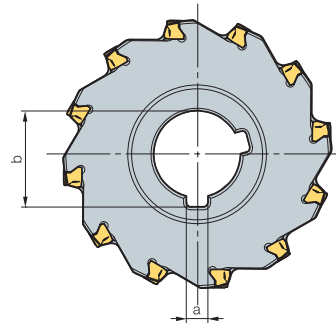
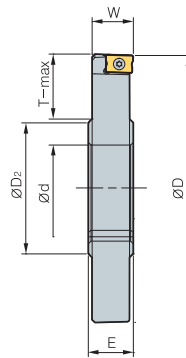

(mm)

Designation		ØD	ØD ₂	Ød	a	b	E	W	T-max	
RM4PHCP	308015R	10	80	41.5	25.4	6.35	28	16.5	15.1	17
	310015R	12	100	48	31.75	7.94	35.2	16.5	15.1	24
	312515R	14	125	58	38.1	9.52	42.3	16.5	15.1	32
	316015R	16	160	58	38.1	9.52	42.3	16.5	15.1	49

Available inserts

LNEX-MA LNM(E)X-MF LNM(E)X-MM

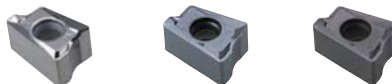

Designation	Cermet		Coated										Uncoated			page		
	CN2000	CN30	NCM325	NC5330	NCM535	NCM545	PC2505	PC2010	PC3600	PC3700	PC6510	PC9530	PC9540	PC5300	PC5400		ST30A	G10
LNEX	100605PNR-MF										●			●	●			
	100605PNR-MM									●	●			●	●			
	100605PNR-MA																	●
	100608PNR-MF									●	●			●	●			
	100608PNR-MM										●			●	●			
LNMX	100605PNR-MF							●		●				●	●			
	100605PNR-MM							●	●	●	●			●	●			
	100608PNR-MF							●		●				●	●			
	100608PNR-MM							●	●	●				●	●			

Available arbors

Designation	Available arbors
RM4PHCP 308015R	BT□□-SCA25.4-□□
310015R	BT□□-SCA31.75-□□
312515R	BT□□-SCA38.1-□□
316015R	

Parts

Specification		
Ø80-Ø160	FTKA0307	TW09S

Available inserts E11 Available arbors and bolt E400-E402

RM4PHCP4000

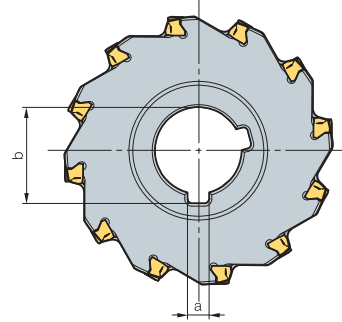
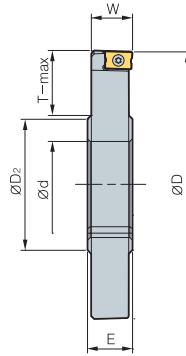

(mm)

Designation		ØD	ØD ₂	Ød	a	b	E	W	T-max	
RM4PHCP	408020R	6	80	41.5	25.4	6.35	28	22	19.8	17
	410020R	8	100	48	31.75	7.94	35.2	22	19.8	24
	412520R	10	125	58	38.1	9.53	42.3	22	19.8	32
	416020R	12	160	58	38.1	9.53	42.3	22	19.8	49

Available inserts

LNEX-MA LNM(E)X-MF LNM(E)X-MM



Designation	Cermet		Coated										Uncoated			page			
	CN2000	CN30	NCM325	NC5330	NCM535	NCM545	PC2505	PC2010	PC3600	PC3700	PC6610	PC9530	PC9540	PC5300	PC5400		ST30A	G10	H01
LNEX	151004PNR-MF										●			●	●				E11
	151004PNR-MM										●			●	●				
	151004PNR-MA																		
	151008PNR-MF										●			●	●				
	151008PNR-MM									●	●			●	●				
	151008PNR-MA																		
	151016PNR-MF											●			●	●			
151016PNR-MM											●			●	●				
LNMX	151004PNR-MF								●	●	●			●	●				
	151004PNR-MM								●	●	●			●	●				
	151008PNR-MF				●				●	●	●			●	●				
	151008PNR-MM				●				●	●	●			●	●				
	151016PNR-MF								●	●	●			●	●				
151016PNR-MM								●	●	●			●	●					

Available arbors

Designation	Available arbors
RM4PHCP 408020R	BT□□ -SCA25.4-□□
410020R	BT□□ -SCA31.75-□□
412520R	
416020R	BT□□ -SCA38.1-□□

Parts

Specification		
Ø80~Ø160	FTKA0412B	TW15S

Available inserts E11 Available arbors and bolt E400~E402



RM4PS3000

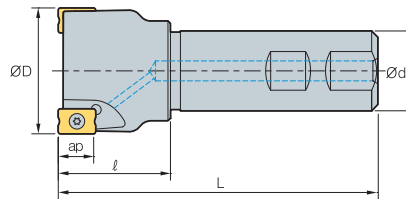

• AR: -6°
• RR: -39°~ -16°

(mm)

Designation		ØD	Ød	l	L	ap	
RM4PS 3014HR-S16	1	14	16	23	90	9.0	0.11
3016HR-S16	1	16	16	25	90	9.0	0.11
3018HR-S16	2	18	16	23	90	9.0	0.12
3020HR-S20	2	20	20	30	100	9.0	0.21
3020HR-S20M	3	20	20	30	100	9.0	0.21
3025HR-S25	2	25	25	35	115	9.0	0.38
3025HR-S25M	3	25	25	35	115	9.0	0.38
3032HR-S32	3	32	32	40	125	9.0	0.69
3032HR-S32M	4	32	32	40	125	9.0	0.7
3040HR-S32	4	40	32	42	130	9.0	0.86
3040HR-S32M	5	40	32	42	130	9.0	0.85
3040HR-S40	4	40	40	42	130	9.0	1.17
3040HR-S40M	5	40	40	42	130	9.0	1.17
3040HR-S42	4	40	42	42	130	9.0	1.26
3040HR-S42M	5	40	42	42	130	9.0	1.25
3050HR-S32	5	50	32	45	135	9.0	1.06
3050HR-S32M	7	50	32	45	135	9.0	1.05
3050HR-S40	5	50	40	45	135	9.0	1.38
3050HR-S40M	7	50	40	45	135	9.0	1.37
3050HR-S42	5	50	42	45	135	9.0	1.48
3050HR-S42M	7	50	42	45	135	9.0	1.48

Available inserts

LNEX-MA LNM(E)X-MF LNM(E)X-MM



Designation	Cermet		Coated										Uncoated			page		
	CN2000	CN30	NCM325	NC5330	NCM535	NCM545	PC2505	PC2010	PC3600	PC3700	PC6510	PC9530	PC9540	PC5300	PC5400		ST30A	G10
LNEX	100605PNR-MF									●	●			●	●			
	100605PNR-MM								●	●				●	●			
	100605PNR-MA																	●
	100605PNL-MM										●			●	●			
	100608PNR-MF									●	●				●	●		
100608PNR-MM										●	●			●	●			
LNMX	100605PNR-MF							●		●				●	●			
	100605PNR-MM							●	●	●	●			●	●			
	100608PNR-MF							●		●				●	●			
	100608PNR-MM							●	●	●				●	●			

Parts

Specification		
Ø14~Ø50	FTKA0307	TW09S

Available inserts E11



RM4PS4000

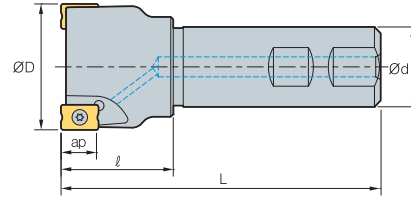

Designation			ØD	Ød	ℓ	L	ap	
RM4PS	4032HR-S32	2	32	32	40	125	14	0.68
	4032HR-S32M	3	32	32	40	125	14	0.69
	4040HR-S32	3	40	32	42	125	14	0.83
	4040HR-S32M	4	40	32	42	125	14	0.83
	4040HR-S40	3	40	40	42	125	14	1.14
	4040HR-S42	3	40	42	42	125	14	1.23
	4050HR-S32	3	50	32	45	125	14	1.02
	4050HR-S32M	4	50	32	45	125	14	1.02
	4050HR-S40	3	50	40	45	125	14	1.35
	4050HR-S40M	4	50	40	45	125	14	1.34
	4050HR-S42	3	50	42	45	125	14	1.45
	4050HR-S42M	4	50	42	45	125	14	1.45
	4063HR-S32	4	63	32	45	125	14	1.25
	4063HR-S32M	6	63	32	45	125	14	1.24
	4063HR-S40	4	63	40	45	125	14	1.62
	4063HR-S40M	6	63	40	45	125	14	1.61
4063HR-S42	4	63	42	45	125	14	1.71	
4063HR-S42M	6	63	42	45	125	14	1.7	

Available inserts



Designation	Cermet		Coated											Uncoated			page		
	CN2000	CN30	NCM325	NC5330	NCM535	NCM545	PC2505	PC2010	PC3600	PC3700	PC6510	PC9530	PC9540	PC5300	PC5400	ST30A		G10	H01
LNEX	151004PNR-MF										●			●	●				
	151004PNR-MM										●			●	●				
	151004PNR-MA																	●	
	151008PNR-MF										●			●	●				
	151008PNR-MM									●	●			●	●				
	151008PNR-MA																		●
	151016PNR-MF										●			●	●				
	151016PNR-MM										●			●	●				
LNMX	151004PNR-MF								●	●	●			●	●				
	151004PNR-MM								●	●	●			●	●				
	151008PNR-MF					●			●	●	●			●	●				
	151008PNR-MM					●			●	●	●			●	●				
	151016PNR-MF								●	●	●	●		●	●				
	151016PNR-MM								●	●	●	●		●	●				

Parts

Specification		
Ø32~Ø63	FTKA0412B	TW15S



RM4PM3000

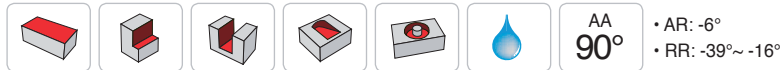
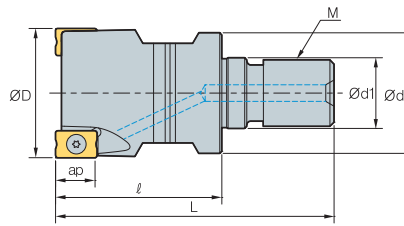

Designation			ØD	Ød	Ød1	l	L	M	ap	
RM4PM	3014HR-M06	1	14	12	6.5	25	40	M06	9.0	0.02
	3016HR-M08	1	16	14.5	8.5	25	42	M08	9.0	0.02
	3018HR-M08	2	18	14.5	8.5	25	42	M08	9.0	0.03
	3020HR-M10	2	20	18	10.5	30	51	M10	9.0	0.06
	3025HR-M12	2	25	23	12.5	35	59	M12	9.0	0.11
	3032HR-M16	3	32	28	17	40	67	M16	9.0	0.21
	3040HR-M16	4	40	28	17	40	67	M16	9.0	0.26
	3050HR-M16	5	50	30	17	45	72	M16	9.0	0.41

Available inserts

LNEX-MA LNM(E)X-MF LNM(E)X-MM

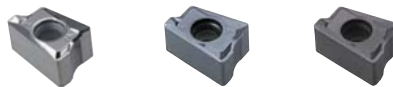

Designation	Cermet		Coated											Uncoated			page	
	CN2000	CN30	NCM325	NC5330	NCM535	NCM545	PC2505	PC2010	PC3600	PC3700	PC6510	PC9530	PC9540	PC5300	PC5400	ST30A		G10
LNEX	100605PNR-MF										●			●	●			
	100605PNR-MM									●	●			●	●			
	100605PNR-MA																	●
	100608PNR-MF									●	●				●	●		
	100608PNR-MM										●				●	●		
LNMX	100605PNR-MF							●		●				●	●			
	100605PNR-MM							●	●	●	●			●	●			
	100608PNR-MF							●		●				●	●			
	100608PNR-MM							●	●					●	●			

Available adaptor

Designation	Available adaptor
RM4PM 3014HR-M06	MAT-M06
3016HR-M08	MAT-M08
3018HR-M08	
3020HR-M10	
3025HR-M12	MAT-M12
3032HR-M16	MAT-M16
3040HR-M16	
3050HR-M16	

Designation: RM4PM3032HR-M16
Modular Head Threading Measure size (M16)

||

Adaptor spec.: MAT-M16-035-S32S
Adaptor Threading Measure (M16)

Parts

Specification		
Ø14~Ø50	Screw FTKA0307	Wrench TW09S

Available inserts E11 Available adaptor E371~E372

RM4ZC(M)3000/4000

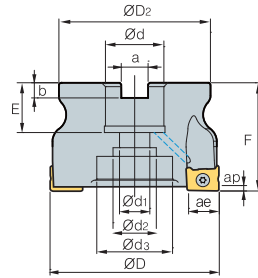

Designation	齿数	ØD	ØD2	Ød	Ød1	Ød2	Ød3	a	b	E	F	ap	ae	kg	
RM4ZCM	3040HR	4	40	37	16	9	14	-	8.4	5.6	19	40	1.5	9.0	0.21
	3050HR	5	50	47	22	11	18	-	10.4	6.3	20	40	1.5	9.0	0.33
	3052HR	5	52	48	22	11	18	-	10.4	6.3	20	40	1.5	9.0	0.37
	4063HR	5	63	58	22	11	18	-	10.4	6.3	20	40	2.5	14.0	0.56
RM4ZC (RM4ZCM)	4066HR	5	66	61	25.4 (27)	14	20	-	9.5 (12.4)	6 (7)	25	50	2.5	14.0	0.74
	4080HR	6	80	70	25.4 (27)	14	20	35	9.5 (12.4)	6 (7)	25 (23)	50	2.5	14.0	1.09
	4100HR	7	100	80	31.75 (32)	18	26	42	12.7 (14.4)	8 (8)	25 (33)	63 (50)	2.5	14.0	1.71

()Metric size

Available inserts

LNM(E)X-MM



Designation	Cermet		Coated											Uncoated			page	
	CN2000	CN30	NCM325	NC5330	NCM535	NCM545	PC2505	PC2010	PC3600	PC3700	PC6510	PC9530	PC9540	PC5300	PC5400	ST30A		G10
3000 type	LNEX	100605PNL-MM																
	LNMX	100605PNL-MM							●	●	●			●	●			
4000 type	LNEX	151008PNL-MM									●			●	●			
	LNMX	151008PNL-MM							●					●	●			

Available arbors

Designation	Available arbors			
	RM4ZC	RM4ZCM		
RM4ZCM	3040HR	BT□□-FMC16-□□ BT□□-SCA16-□□		
		3050HR	3052HR	BT□□-FMC22-□□
				BT□□-FMC22-□□
RM4ZCM RM4ZC(M)	4063HR	BT□□-FMA25.4-□□		
	4066HR	BT□□-FMC27-□□		
	4080HR	BT□□-FMA31.75-□□ BT□□-SCA31.75-□□		
	4100HR	BT□□-FMC32-□□		

Parts

Specification	Screw	Wrench
Ø40~Ø52	FTKA0307	TW09S
Ø63~Ø100	FTKA0412B	TW15S

Available inserts E11 Available arbors and bolt E400~E402



RM4ZS3000

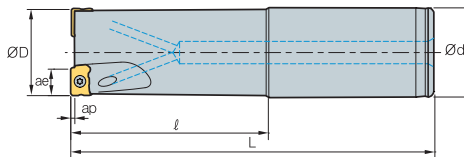

AA
90°
• AR: -11°
• RR: -17°~ -14°

(mm)

Designation		ØD	Ød	ℓ	L	ap	ae	kg
RM4ZS	3025HR-L25	2	25	25	120	200	1.5	0.62
	3032HR-L32	3	32	32	120	210	1.5	1.13
	3040HR-L32	4	40	32	120	250	1.5	1.53

RM4ZM3000

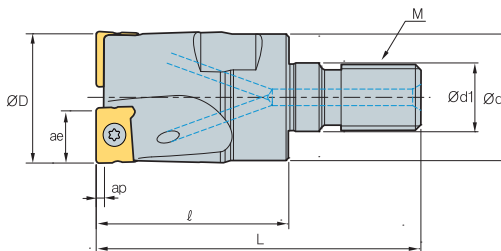

AA
90°
• AR: -11°
• RR: -17°~ -14°

(mm)

Designation		ØD	Ød	Ød1	ℓ	L	M	ap	ae	kg
RM4ZM	3025HR-M12	2	25	23	12.5	35	M12	1.5	9.0	0.11
	3032HR-M16	3	32	29	17	40	M16	1.5	9.0	0.21
	3040HR-M16	4	40	29	17	40	M16	1.5	9.0	0.28

Available inserts

LN(E)X-MM



Designation	Cermet		Coated										Uncoated			page			
	CN2000	CN30	NCM325	NC5330	NCM535	NCM545	PC2505	PC2010	PC3600	PC3700	PC6510	PC9530	PC9540	PC5300	PC5400		ST30A	G10	H01
LNEX 100605PNL-MM																			E11
LNMX 100605PNL-MM								●	●	●				●	●				

Parts

Specification		
Ø25~Ø40	FTKA0307	TW09S

Available inserts E11

RM6PCM-WN04 new

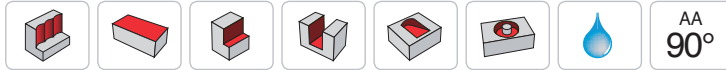
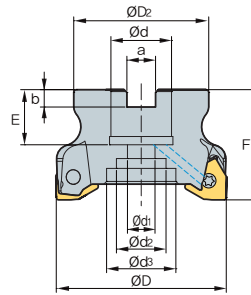

AA 90°
 • AR: -6°
 • RR: -14°~ -11°

(mm)

Designation	6	7	8	9	10	11								
Designation	ØD	ØD2	Ød	Ød1	Ød2	Ød3	a	b	E	F	ap	kg		
RM6PCM 040R-16-6-WN04	40	35	16	9	14	-	8.4	5.6	19	40	4.3	0.19		
040R-16-7-WN04	40	35	16	9	14	-	8.4	5.6	19	40	4.3	0.19		
050R-22-8-WN04	50	42	22	11	18	-	10.4	6.3	20	40	4.3	0.28		
050R-22-9-WN04	50	42	22	11	18	-	10.4	6.3	20	40	4.3	0.28		
063R-22-10-WN04	63	49	22	11	18	-	10.4	6.3	20	40	4.3	0.47		
063R-22-11-WN04	63	49	22	11	18	-	10.4	6.3	20	40	4.3	0.47		

Available inserts

WNGX-MA WNGX-ML WNGX-MM

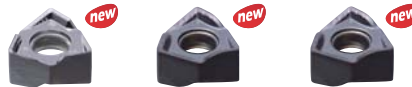

Designation	Cermet		Coated											Uncoated			page		
	CN2000	CN30	NCM325	NC5330	NCM535	NCM545	PC2505	PC2010	PC3600	PC3700	PC6510	PC9530	PC9540	PC5300	PC5400	ST30A		G10	H01
WNGX 040304PNFR-MA																			●
040308PNFR-MA																			●
040312PNFR-MA																			●
040316PNFR-MA																			●
040304PNER-ML								●		●				●	●				
040308PNER-ML								●		●				●	●				
040312PNER-ML														●					
040316PNER-ML														●					
040304PNSR-MM								●		●				●	●				
040308PNSR-MM								●		●				●	●				
040312PNSR-MM														●					
040316PNSR-MM														●					

Available arbors

Designation	NC arbors
RM6PCM 040R-16-6-WN04	BT□□-FMC16-□□
040R-16-7-WN04	
050R-22-8-WN04	
050R-22-9-WN04	BT□□-FMC22-□□
063R-22-10-WN04	
063R-22-11-WN04	

Parts

Specification	Screw	Wrench
Ø40~Ø63	ETNA02506	TW07S

Available inserts E28 Available arbors and bolt E400~E402



RM6PC(M)-WN08 new

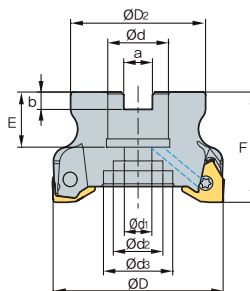

AA
90°

• AR: -6°
• RR: -14°~ -11°

(mm)

Designation		⚙️	ØD	ØD ₂	Ød	Ød ₁	Ød ₂	Ød ₃	a	b	E	F	ap	⚖️
RM6PCM	050R-22-4-WN08	4	50	42	22	11	18	-	10.4	6.3	20	40	8.2	0.28
	050R-22-5-WN08	5	50	42	22	11	18	-	10.4	6.3	20	40	8.2	0.27
	063R-22-5-WN08	5	63	49	22	11	18	-	10.4	6.3	20	40	8.2	0.45
	063R-22-6-WN08	6	63	49	22	11	18	-	10.4	6.3	20	40	8.2	0.45
	080R-27-7-WN08	7	80	57	27	14	20	35	12.4	7	23	50	8.2	0.90
	080R-27-9-WN08	9	80	57	27	14	20	35	12.4	7	23	50	8.2	0.89
	100R-32-8-WN08	8	100	67	32	18	26	42	14.4	8	25	50	8.2	1.47
	100R-32-11-WN08	11	100	67	32	18	26	42	14.4	8	25	50	8.2	1.45
	125R-40-11-WN08	11	125	90	40	22	32	52	16.4	9	29	63	8.2	2.94
125R-40-14-WN08	14	125	90	40	22	32	52	16.4	9	29	63	8.2	2.91	
RM6PC	080R-25.4-7-WN08	7	80	57	25.4	14	20	35	9.5	6	25	50	8.2	0.91
	080R-25.4-9-WN08	9	80	57	25.4	14	20	35	9.5	6	25	50	8.2	0.91
	100R-31.75-8-WN08	8	100	67	31.75	18	26	42	12.7	8	32	63	8.2	1.69
	100R-31.75-11-WN08	11	100	67	31.75	18	26	42	12.7	8	32	63	8.2	1.73
	125R-38.1-11-WN08	11	125	90	38.1	22	32	52	15.9	10	35	63	8.2	1.98
	125R-38.1-14-WN08	14	125	90	38.1	22	32	52	15.9	10	35	63	8.2	2.90

Available inserts

WNGX-MA WNGX-ML WNGX-MM



Designation	Cermet								page	Designation	Coated								page		
	CN2000	CN30	NCM325	NC5330	NCM535	NCM545	PC2010	PC3600			PC3700	PC6510	PC9530	PC9540	PC5300	PC5400	ST30A	H01			
WNGX 080604PNFR-MA										E28	WNGX 080616PNER-ML										E28
080608PNFR-MA											080620PNER-ML										
080612PNFR-MA											080604PNSR-MM										
080616PNFR-MA											080608PNSR-MM										
080620PNFR-MA											080612PNSR-MM										
080604PNER-ML											080616PNSR-MM										
080608PNER-ML											080620PNSR-MM										
080612PNER-ML																					

Available arbors

Designation	NC arbors
RM6PC 080R-25.4-7-WN08	BT□□-FMA25.4-□□
080R-25.4-9-WN08	
100R-31.75-8-WN08	
100R-31.75-11-WN08	
125R-38.1-11-WN08	BT□□-FMA38.1-□□
125R-38.1-14-WN08	
RM6PCM 050R-22-4-WN08	BT□□-FMC22-□□
050R-22-5-WN08	

Designation	NC arbors
RM6PCM 063R-22-5-WN08	BT□□-FMC22-□□
063R-22-6-WN08	
080R-27-7-WN08	BT□□-FMC27-□□
080R-27-9-WN08	
100R-32-8-WN08	BT□□-FMC32-□□
100R-32-11-WN08	
125R-40-11-WN08	
125R-40-14-WN08	BT□□-FMC40-□□

Parts

Specification		
Ø50-Ø125	FTNA0512	TW20-100

Available inserts **E28** Available arbors and bolt **E400~E402**



RM6PS-WN04 new

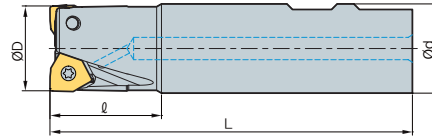

(mm)

Designation		ØD	Ød	ℓ	L	ap		
RM6PS	020R-2W20-110-WN04	2	20	20	35	110	4.3	0.22
	020R-3W20-110-WN04	3	20	20	35	110	4.3	0.22
	025R-3W25-110-WN04	3	25	25	35	110	4.3	0.36
	025R-4W25-110-WN04	4	25	25	35	110	4.3	0.35
	032R-5W32-110-WN04	5	32	32	35	110	4.3	0.60
	025R-6W32-110-WN04	6	32	32	35	110	4.3	0.60

Available inserts

WNGX-MA WNGX-ML WNGX-MM

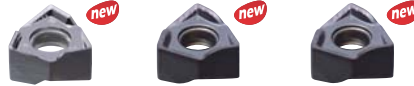

Designation	Cermet		Coated											Uncoated			page		
	CN2000	CN30	NCM325	NC5330	NCM535	NCM545	PC2505	PC2010	PC3600	PC3700	PC6510	PC9530	PC9540	PC5300	PC5400	ST30A		G10	H01
WNGX 040304PNFR-MA																			●
040308PNFR-MA																			●
040312PNFR-MA																			●
040316PNFR-MA																			●
040304PNER-ML								●		●				●	●				
040308PNER-ML								●						●	●				
040312PNER-ML														●	●				
040316PNER-ML														●	●				
040304PNSR-MM								●		●				●	●				
040308PNSR-MM								●						●	●				
040312PNSR-MM														●	●				
040316PNSR-MM														●	●				

Parts

Specification		
Ø20~Ø32	ETNA02506	TW07S

Available inserts E28



RM6PS-WN08 new

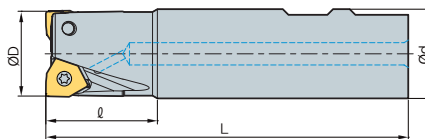

AA 90°
 • AR: -6°
 • RR: -20°~ -14°

(mm)

Designation		ØD	Ød	ℓ	L	ap	
RM6PS 032R-2W32-120-WN08	2	32	32	40	120	8.2	0.65
040R-3W32-120-WN08	3	40	32	40	120	8.2	0.69
040R-4W32-120-WN08	4	40	32	40	120	8.2	0.69
050R-4W32-120-WN08	4	50	32	40	120	8.2	0.76
050R-5W32-120-WN08	5	50	32	40	120	8.2	0.76

Available inserts

WNGX-MA WNGX-ML WNGX-MM



Designation	Cermet		Coated											Uncoated			page	
	CN2000	CN30	NCM325	NC5330	NCM535	NCM545	PC2505	PC2010	PC3600	PC3700	PC6510	PC9530	PC9540	PC5300	PC5400	ST30A		G10
WNGX 080604PNFR-MA																		●
080608PNFR-MA																		●
080612PNFR-MA																		●
080616PNFR-MA																		●
080620PNFR-MA																		●
080604PNER-ML									●	●				●	●			
080608PNER-ML				●					●	●	●			●	●			
080612PNER-ML														●	●			
080616PNER-ML														●	●			
080620PNER-ML														●	●			
080604PNSR-MM									●	●				●	●			
080608PNSR-MM				●					●	●	●			●	●			
080612PNSR-MM														●	●			
080616PNSR-MM														●	●			
080620PNSR-MM														●	●			

E28

Parts

Specification		
Ø32~Ø50	FTNA0512	TW20-100

Available inserts E28

RM6PM new

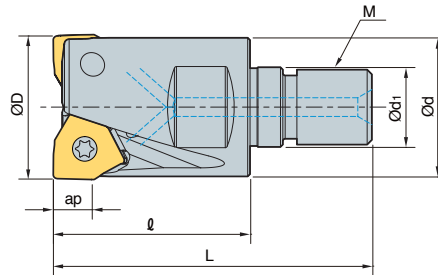

AA 90°
 • AR: -6°
 • RR: -9°~ -6°

(mm)

Designation		ØD	Ød	Ød ₁	ℓ	L	M	ap	
RM6PM 020R-2-M10-WN04	2	20	18	10.5	30	50	10	4.3	0.06
020R-3-M10-WN04	3	20	18	10.5	30	50	10	4.3	0.06
025R-4-M12-WN04	4	25	23	12.5	30	53	12	4.3	0.1
025R-5-M12-WN04	5	25	23	12.5	30	53	12	4.3	0.09
032R-5-M16-WN04	5	32	29	17	40	66	16	4.3	0.25
032R-6-M16-WN04	6	32	29	17	40	66	16	4.3	0.24
032R-2-M16-WN08	2	32	29	17	43	69	16	8.2	0.22
040R-3-M16-WN08	3	40	29	17	43	69	16	8.2	0.31
040R-4-M16-WN08	4	40	29	17	43	69	16	8.2	0.30

Available inserts

WNGX-MA WNGX-ML WNGX-MM

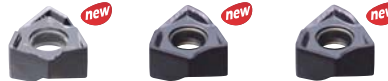

Designation	Coated										Uncoated	page	Designation	Coated										Uncoated	page								
	CN2000	CN30	NCM325	NC5330	NCM535	NCM545	PC2505	PC3600	PC2010	PC6510	PC9530			PC9540	PC5300	PC5400	ST30A	H01	CN2000	CN30	NCM325	NC5330	NCM535	NCM545		PC2505	PC3600	PC2010	PC6510	PC9530	PC9540	PC5300	PC5400
WNGX 040304PNFR-MA																●	WNGX 080604PNFR-MA																●
040308PNFR-MA																●	080608PNFR-MA																●
040312PNFR-MA																●	080612PNFR-MA																●
040316PNFR-MA																●	080616PNFR-MA																●
040304PNER-ML								●	●							●	080620PNFR-MA																●
040308PNER-ML								●								●	080604PNER-ML								●	●							●
040312PNER-ML								●								●	080608PNER-ML								●	●	●						●
040316PNER-ML								●								●	080612PNER-ML								●								●
040304PNSR-MM								●	●							●	080616PNER-ML								●								●
040308PNSR-MM								●								●	080620PNER-ML								●								●
040312PNSR-MM								●								●	080604PNSR-MM								●	●							●
040316PNSR-MM								●								●	080608PNSR-MM								●	●	●						●
																	080612PNSR-MM								●	●	●						●
																	080616PNSR-MM								●								●
																	080620PNSR-MM								●								●

Available adaptor

Designation	Available adaptor	Designation	Available adaptor
RM6PM 020R-2-M10-WN04	MAT-M10	RM6PM 032R-6-M16-WN04	MAT-M16
020R-3-M10-WN04	MAT-M10	032R-2-M16-WN08	MAT-M16
025R-4-M12-WN04	MAT-M12	040R-3-M16-WN08	MAT-M16
025R-5-M12-WN04	MAT-M12	040R-4-M16-WN08	MAT-M16
032R-5-M16-WN04	MAT-M16		

Designation: RM6PM032R-5-M16-WN04
 Modular Head Threading Measure size (M16)

Adaptor spec.: MAT-M16-035-S32S
 Adaptor Threading Measure (M16)

Parts

Specification		
WNGX04 Ø20-Ø32	ETNA02506	-
WNGX08 Ø32-Ø40	FTNA0512	TW20-100

Available inserts E28 Available adaptor E371-E372



RM8AC(M)4000

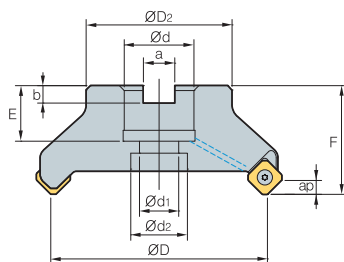

Fig. 1

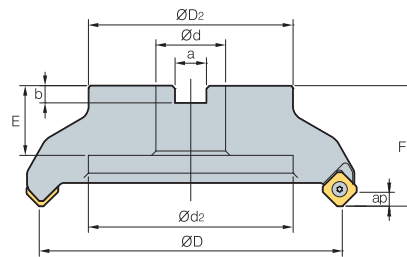

Fig. 2



AA
45°

- AR: -6°
- RR: -9°~ -6°

(mm)

Designation		ØD	ØD2	Ød	Ød1	Ød2	a	b	E	F	ap		Fig.
RM8ACM													
4050HR-M	4	50	49	22	11	18	10.4	6.3	20	40	6.0	0.5	1
4050HR-H	6	50	49	22	11	18	10.4	6.3	20	40	6.0	0.5	1
4063HR-M	6	63	49	22	11	18	10.4	6.3	20	40	6.0	0.7	1
4063HR-H	8	63	49	22	11	18	10.4	6.3	20	40	6.0	0.7	1
RM8AC (RM8ACM)													
4080HR	5	80	57	25.4 (27)	14	20	9.5 (12.4)	6 (7)	25 (23)	50	6.0	1.2	1
4080HR-M	7	80	57	25.4 (27)	14	20	9.5 (12.4)	6 (7)	25 (23)	50	6.0	1.2	1
4080HR-H	10	80	57	25.4 (27)	14	20	9.5 (12.4)	6 (7)	25 (23)	50	6.0	1.3	1
4100HR	6	100	67	31.75 (32)	18	26	12.7 (14.4)	8	33 (25.5)	63 (50)	6.0	1.7	1
4100HR-M	8	100	67	31.75 (32)	18	26	12.7 (14.4)	8	33 (25.5)	63 (50)	6.0	1.7	1
4100HR-H	12	100	67	31.75 (32)	18	26	12.7 (14.4)	8	33 (25.5)	63 (50)	6.0	1.7	1
4125HR	8	125	87	38.1 (40)	22	32	15.9 (16.4)	10 (9)	36 (30)	63	6.0	3.6	1
4125HR-M	10	125	87	38.1 (40)	22	32	15.9 (16.4)	10 (9)	36 (30)	63	6.0	3.6	1
4125HR-H	16	125	87	38.1 (40)	22	32	15.9 (16.4)	10 (9)	36 (30)	63	6.0	3.7	1
4160R	10	160	107	50.8 (40)	-	107	19 (16.4)	11 (9)	38 (32)	63	6.0	4.8	2
4160R-M	12	160	107	50.8 (40)	-	107	19 (16.4)	11 (9)	38 (32)	63	6.0	5.3	2
4160R-H	20	160	107	50.8 (40)	-	107	19 (16.4)	11 (9)	38 (32)	63	6.0	5.4	2
4200R-M	14	200	130	47.625 (60)	-	135	25.4 (25.7)	14	38 (32)	63	6.0	7.1	2
4200R-H	24	200	130	47.625 (60)	-	135	25.4 (25.7)	14	38 (32)	63	6.0	7.1	2
4250R-M	16	250	180	47.625 (60)	-	180	25.4 (25.7)	14	38 (32)	63	6.0	11.9	2
4250R-H	30	250	180	47.625 (60)	-	180	25.4 (25.7)	14	38 (32)	63	6.0	12.0	2
4315R	18	315	240	47.625 (60)	-	238	25.4 (25.7)	14	38	63	6.0	18.8 (18.6)	2
4315R-M	20	315	240	47.625 (60)	-	238	25.4 (25.7)	14	38	63	6.0	18.8 (18.6)	2
4400R-M	28	400	260	47.625 (60)	-	238	25.4 (25.7)	14	38	80	6.0	37.7 (37.4)	2

() Metric size

Available inserts

SNM(E)X-MF SNEX-ML SNM(E)X-MM SNEX-MA SNEX-W



Designation	Cermet		Coated							Uncoated		page				
	CN2000	CN30	NCM925	NC5330	NCM635	NCM645	PC2505	PC2010	PC3600	PC6510	PC9530		PC9540	PC5300	PC5400	ST30A
SNEX 1206ANN-MF									●	●	●	●	●			
1206ANN-ML									●	●	●	●	●			
1206ANN-MM									●	●	●	●	●			E22
1206ANN-MA									●	●	●	●	●			E23
1206ANN-W									●	●	●	●	●			E24
SNMX 1206ANN-MF				●					●	●	●	●	●			
1206ANN-MM			●	●					●	●	●	●	●			

Available arbors

Designation	Available arbors	
	RM8AC	RM8ACM
RM8ACM 4050HR-□	-	BT□□-FMC22-□□
4063HR-□		
RM8AC 4080HR-□	BT□□-FMA25.4-□□	BT□□-FMC27-□□
(RM8ACM) 4100HR-□	BT□□-FMA31.75-□□	BT□□-FMC32-□□
4125HR-□	BT□□-FMA38.1-□□	BT□□-FMB40-□□
4160R-□	BT□□-FMA50.8-□□	BT□□-FMC40-□□
4200R-□		
4250R-□	BT□□-FMA47.625-□□	BT□□-FMB60-□□
4315R-□		
4400R-□		

Parts

Specification		
Ø50~Ø400	FTKA0410	TW15S

Available inserts E22~E24

Available arbors and bolt E400~E402

RMH8AC(M)4000

Shim type

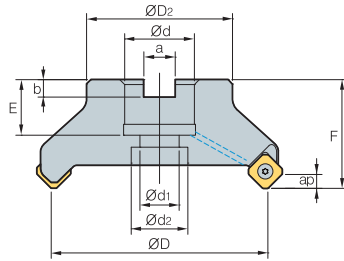

Fig. 1

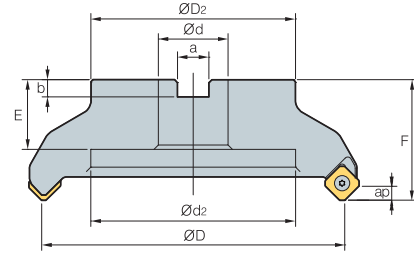

Fig. 2



AA
45°

• AR: -6°
• RR: -9°~ -6°

(mm)

Designation	ØD	ØD2	Ød	Ød1	Ød2	a	b	E	F	ap	Fig.		
RMH8AC													
(RMH8ACM)													
4080HR-M	7	80	57	25.4 (27)	14	20	9.5 (12.4)	25 (23)	50	6.0	6.0	1.2	1
4100HR-M	8	100	67	31.75 (32)	18	26	12.7 (14.4)	33 (25.5)	63 (50)	6.0	6.0	1.7	1
4125HR-M	10	125	87	38.1 (40)	22	32	15.9 (16.4)	36 (30)	63	6.0	6.0	3.6	1
4160R-M	12	160	107	50.8 (40)	-	107	19 (16.4)	38 (32)	63	6.0	6.0	5.3	2
4200R-M	14	200	130	47.625 (60)	-	135	25.4 (25.7)	38 (32)	63	6.0	6.0	7.1	2
4250R-M	16	250	180	47.625 (60)	-	180	25.4 (25.7)	38 (32)	63	6.0	6.0	11.9	2
4315R-M	20	315	240	47.625 (60)	-	238	25.4 (25.7)	38	63	6.0	6.0	18.8 (18.6)	2
4400R-M	26	400	260	47.625 (60)	-	238	25.4 (25.7)	38	80	6.0	6.0	37.7 (37.4)	2

()Metric size

Available inserts

SNM(E)X-MF

SNEX-ML

SNM(E)X-MM

SNEX-MA

SNEX-W

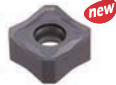

Designation	Cermet		Coated										Uncoated			page			
	CN2000	CN30	NCM325	NC5330	NCM535	NCM545	PC2505	PC2010	PC3600	PC3700	PC6510	PC9530	PC9540	PC5300	PC5400		ST30A	G10	H01
SNEX	1206ANN-MF							●	●	●				●	●				E22 E23 E24
	1206ANN-ML																		
	1206ANN-MM							●	●	●	●								
	1206ANN-MA																	●	
	1206ANN-W																		
SNMX	1206ANN-MF				●			●	●	●		●		●	●				
	1206ANN-MM				●	●		●		●	●		●	●					

Available arbors

Designation	Available arbors		
	RMH8AC	RMH8ACM	
RMH8AC	4080HR-□	BT□□-FMA25.4-□□	BT□□-FMC27-□□
(RMH8ACM)	4100HR-□	BT□□-FMA31.75-□□	BT□□-FMC32-□□
	4125HR-□	BT□□-FMA38.1-□□	BT□□-FMB40-□□
	4160R-□	BT□□-FMA50.8-□□	BT□□-FMC40-□□
	4200R-□	BT□□-FMA47.625-□□	BT□□-FMB60-□□
	4250R-□		
	4315R-□		
	4400R-□		

Parts

Specification	Screw	Shim	Shim Screw	Wrench
Ø80~Ø400	FTKA0412B	SS42RM8	SHXN0609F	TW15S

Available inserts E22~E24 Available arbors and bolt E400~E402



RM8AC(M)5000

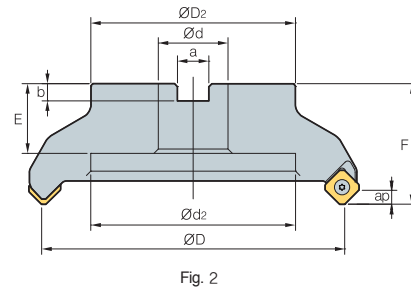
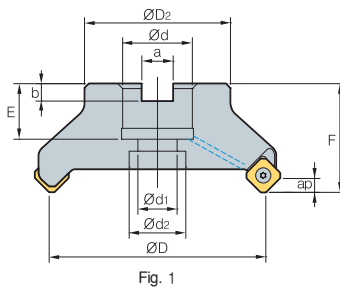

AA
45°

• AR: -6°
• RR: -9°~ -6°

(mm)

Designation	⊙	ØD	ØD2	Ød	Ød1	Ød2	a	b	E	F	ap		Fig.	
RM8AC (RM8ACM)	5080HR-M	6	80	57	25.4 (27)	14	20	9.5 (12.4)	6 (7)	25 (23)	50	7.5	1.2	1
	5100HR-M	7	100	67	31.75 (32)	18	26	12.7 (14.4)	8.0	33 (25)	63 (50)	7.5	2.5 (1.8)	1
	5125HR-M	8	125	87	38.1 (40)	22	32	15.9 (16.4)	10 (9)	35 (30)	63	7.5	3.6	1
	5160R-M	10	160	107	50.8 (40)	-	107	19 (16.4)	11 (9)	38 (32)	63	7.5	5 (4.56)	2
	5200R-M	12	200	130	47.625 (60)	-	135	25.4 (25.7)	14.0	38	63	7.5	7.1 (6.8)	2
	5250R-M	15	250	180	47.625 (60)	-	180	25.4 (25.7)	14.0	38	63	7.5	11.9 (10.6)	2
	5315R-M	20	315	240	47.625 (60)	-	238	25.4 (25.7)	14.0	38	63	7.5	19.1 (18.9)	2
	5400R-M	28	400	260	47.625 (60)	-	238	25.4 (25.7)	14.0	38	80	7.5	37.7 (37.5)	2

() Metric size

Available inserts

SNM(E)X-MF

SNEX-ML

SNM(E)X-MM

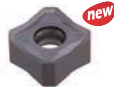

Designation	Cermet		Coated											Uncoated			page			
	CN2000	CN30	NCM325	NC5330	NCM535	NCM545	PC2505	PC2010	PC3600	PC3700	PC6510	PC9530	PC9540	PC5300	PC5400	ST30A		G10	H01	
SNEX	1507ANN-MF										●				●	●			E22	
	1507ANN-ML														●	●				E23
	1507ANN-MM										●				●	●				
SNMX	1507ANN-MF				●				●	●	●			●	●				E24	
	1507ANN-MM				●				●	●	●			●	●					

Available arbors

Designation	Available arbors	
	RM8AC	RM8ACM
RM8AC (RM8ACM) 5080HR-□	BT□□-FMA25.4-□□	BT□□-FMC27-□□
5100HR-□	BT□□-FMA31.75-□□	BT□□-FMC32-□□
5125HR-□	BT□□-FMA38.1-□□	BT□□-FMB40-□□
5160R-□	BT□□-FMA50.8-□□	BT□□-FMC40-□□
5200R-□		
5250R-□		
5315R-□	BT□□-FMA47.625-□□	BT□□-FMB60-□□
5400R-□		

Parts

Specification		
Ø80~Ø400	FTGA0513	TW20-100

Available inserts E22~E24

Available arbors and bolt E400~E402



RMH8AC(M)5000

Shim type

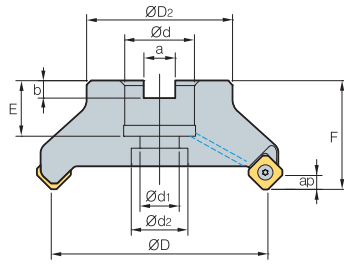

Fig. 1

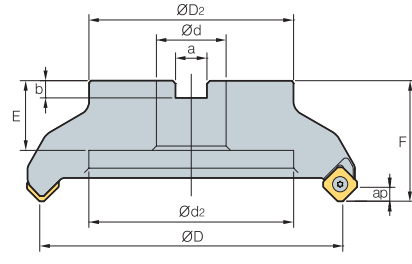

Fig. 2

AA 45°
 • AR: -6°
 • RR: -9°~ -6°

(mm)

Designation	ØD	ØD ₂	Ød	Ød ₁	Ød ₂	a	b	E	F	ap	kg	Fig.		
RMH8AC (RMH8ACM)	5080HR-M	6	80	57	25.4 (27)	14	20	9.5 (12.4)	6 (7)	25 (23)	50	7.5	1.2	1
	5100HR-M	7	100	67	31.75 (32)	18	26	12.7 (14.4)	8.0	33 (25)	63 (50)	7.5	2.5 (1.8)	1
	5125HR-M	8	125	87	38.1 (40)	22	32	15.9 (16.4)	10 (9)	36 (30)	63	7.5	3.6	1
	5160R-M	10	160	107	50.8 (40)	-	107	19 (16.4)	11 (9)	38 (32)	63	7.5	5 (4.56)	2
	5200R-M	12	200	130	47.625 (60)	-	135	25.4 (25.7)	14.0	38 (32)	63	7.5	7.1 (6.8)	2
	5250R-M	15	250	180	47.625 (60)	-	180	25.4 (25.7)	14.0	38 (32)	63	7.5	11.9 (10.6)	2
	5315R-M	20	315	240	47.625 (60)	-	238	25.4 (25.7)	14.0	38	63	7.5	19.1 (18.9)	2
5400R-M	22	400	260	47.625 (60)	-	238	25.4 (25.7)	14.0	38	80	7.5	37.7 (37.5)	2	

()Metric size

Available inserts

SNM(E)X-MF SNEX-ML SNM(E)X-MM



Designation	Cermet		Coated											Uncoated			page			
	CN2000	CN30	NCM325	NC5330	NCM535	NCM545	PC2505	PC2010	PC3600	PC3700	PC6510	PC9530	PC9540	PC5300	PC5400	ST30A		G10	H01	
SNEX	1507ANN-MF																		E22	
	1507ANN-ML																			E23
	1507ANN-MM																	E24		
SNMX	1507ANN-MF				●				●	●	●									E24
	1507ANN-MM				●				●	●	●									

Available arbors

Designation	Available arbors		
	RMH8AC	RMH8ACM	
RMH8AC (RMH8ACM)	5080HR-□	BT□□-FMA25.4-□□	BT□□-FMC27-□□
	5100HR-□	BT□□-FMA31.75-□□	BT□□-FMC32-□□
	5125HR-□	BT□□-FMA38.1-□□	BT□□-FMB40-□□
	5160R-□	BT□□-FMA50.8-□□	BT□□-FMC40-□□
	5200R-□		
	5250R-□		
	5315R-□	BT□□-FMA47.625-□□	BT□□-FMB60-□□
	5400R-□		

Parts

Specification				
Ø80~Ø400	FTGA0513	SS53RM8	SHXN0712F	TW20-100

Available inserts E22~E24 Available arbors and bolt E400~E402



RM8EC(M)4000

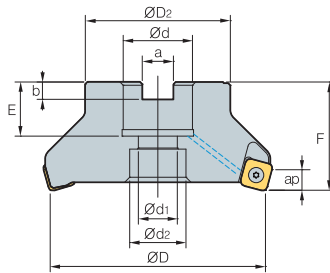

Fig. 1

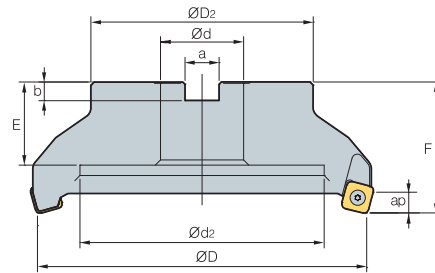

Fig. 2



(mm)

Designation	齿数	ØD	ØD2	Ød	Ød1	Ød2	a	b	E	F	ap	重量	Fig.	
RM8ECM	4050HR-M	4	50	49	22	11	18	10.4	6.3	20	40	9.0	0.4	1
	4063HR-M	6	63	49	22	11	18	10.4	6.3	20	40	9.0	0.6	1
RM8EC (RM8ECM)	4080HR	5	80	57	25.4 (27)	14	20	9.5 (12.4)	6 (7)	25 (23)	50	9.0	1.2	1
	4080HR-M	7	80	57	25.4 (27)	14	20	9.5 (12.4)	6 (7)	25 (23)	50	9.0	1.1	1
	4100HR	6	100	67	31.75 (32)	18	26	12.7 (14.4)	8	33 (25)	63 (50)	9.0	1.6	1
	4100HR-M	8	100	67	31.75 (32)	18	26	12.7 (14.4)	8	33 (25)	63 (50)	9.0	2.5	1
	4125HR	8	125	87	38.1 (40)	22	32	15.9 (16.4)	10 (9)	35 (29)	63	9.0	2.9 (3.3)	1
	4125HR-M	10	125	87	38.1 (40)	22	32	15.9 (16.4)	10 (9)	35 (29)	63	9.0	3.0	1
	4160R	10	160	107	50.8 (40)	-	107	19 (16.4)	11 (9)	38 (32)	63	9.0	4.4	2
	4160R-M	12	160	107	50.8 (40)	-	107	19 (16.4)	11 (9)	38 (32)	63	9.0	4.0	2
	4200R-M	16	200	130	47.625 (60)	-	135	25.4 (25.7)	14	38 (32)	63	9.0	5.9	2
	4250R-M	16	250	180	47.625 (60)	-	180	25.4 (25.7)	14	38	63	9.0	10.9 (10.6)	2
	4315R-M	20	315	240	47.625 (60)	-	238	25.4 (25.7)	14	38	63	9.0	18.1 (17.9)	2
	4400R-M	28	400	260	47.625 (60)	-	238	25.4 (25.7)	14	38	80	9.0	31.8 (31.5)	2

Available inserts

() Metric size

SNM(E)X-MF SNEX-ML SNM(E)X-MM SNEX-MA



Designation	Cermert		Coated											Uncoated			page			
	CN2000	CN30	NCM325	NC5330	NCM535	NCM545	PC2505	PC2010	PC3600	PC3700	PC8510	PC9530	PC9540	PC5300	PC5400	ST30A		G10	H01	
SNEX	1206ENN-MF										●			●	●				E22	
	1206ENN-ML										●			●	●					E23
	1206ENN-MM										●			●	●			E24		
	1206ENN-MA																			●
SNMX	1206ENN-MF				●					●	●	●		●	●				E24	
	1206ENN-MM				●					●	●	●		●	●					

Available arbors

Designation	NC arbors	
	RM8EC	RM8ECM
RM8ECM	4050HR-□ 4063HR-□	BT□□-FMC22-□□
RM8EC (RM8ECM)	4080HR-□ 4100HR-□ 4125HR-□ 4160R-□	BT□□-FMA25.4-□□ BT□□-FMA31.75-□□ BT□□-FMA38.1-□□ BT□□-FMA50.8-□□
	4200R-□ 4250R-□ 4315R-□ 4400R-□	BT□□-FMA47.625-□□ BT□□-FMB60-□□

Parts

Specification	Screw	Wrench
Ø50~Ø400	PTKA0411-R3	TW15S

Available inserts E22~E24

Available arbors and bolt E400~E402

RMH8EC(M)4000

Shim type

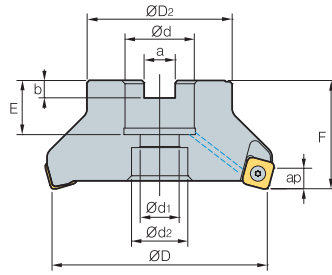

Fig. 1

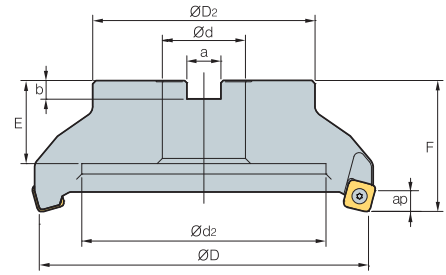

Fig. 2



AA
75°

• AR: -6°
• RR: -8°~ -6°

(mm)

Designation	ØD	ØD2	Ød	Ød1	Ød2	a	b	E	F	ap	$\frac{a}{kg}$	Fig.		
RMH8EC (RMH8ECM)	4080HR-M	7	80	57	25.4 (27)	14	20	9.5 (12.4)	6 (7)	25 (23)	50	9.0	1.1	1
	4100HR-M	8	100	67	31.75 (32)	18	26	12.7 (14.4)	8	33 (25.5)	63 (50)	9.0	2.5	1
	4125HR-M	10	125	87	38.1 (40)	22	32	15.9 (16.4)	10 (9)	36 (30)	63	9.0	3.0	1
	4160R-M	12	160	107	50.8 (40)	-	107	19 (16.4)	11 (9)	38 (32)	63	9.0	4.0	2
	4200R-M	16	200	130	47.625 (60)	-	135	25.4 (25.7)	14	38 (32)	63	9.0	5.9	2
	4250R-M	16	250	180	47.625 (60)	-	180	25.4 (25.7)	14	38 (32)	63	9.0	10.9 (10.6)	2
	4315R-M	20	315	240	47.625 (60)	-	238	25.4 (25.7)	14	38	63	9.0	18.1 (17.9)	2
	4400R-M	24	400	260	47.625 (60)	-	238	25.4 (25.7)	14	38	80	9.0	31.8 (31.5)	2

()Metric size

Available inserts

SNM(E)X-MF SNEX-ML SNM(E)X-MM SNEX-MA



Designation	Cermet		Coated										Uncoated			page			
	CN2000	CN30	NCM325	NC5330	NCM535	NCM545	PC2505	PC2010	PC3600	PC3700	PC6510	PC9530	PC9540	PC5300	PC5400		ST30A	G10	H01
SNEX	1206ENN-MF										●			●	●				E22 E23 E24
	1206ENN-ML													●	●				
	1206ENN-MM									●				●	●				
	1206ENN-MA																	●	
SNMX	1206ENN-MF				●				●	●	●		●	●	●				
	1206ENN-MM				●				●	●	●		●	●	●				

Available arbors

Designation	Available arbors	
	RMH8EC	RMH8ECM
RMH8EC (RMH8ECM)	4080HR-□ BT□□-FMA25.4-□□	BT□□-FMC27-□□
	4100HR-□ BT□□-FMA31.75-□□	BT□□-FMC32-□□
	4125HR-□ BT□□-FMA38.1-□□	BT□□-FMB40-□□
	4160R-□ BT□□-FMA50.8-□□	BT□□-FMC40-□□
	4200R-□	
	4250R-□	
	4315R-□	
	4400R-□ BT□□-FMA47.625-□□	BT□□-FMB60-□□

Parts

Specification				
Ø80~Ø400	PTKA0411-R3	SS42RM8	SHXN0609F	TW15S

Available inserts E22~E24 Available arbors and bolt E400~E402



RM8EC(M)5000

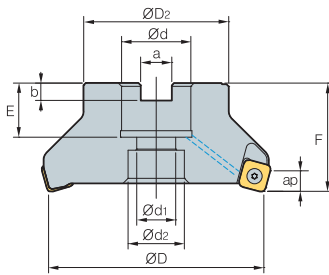

Fig. 1

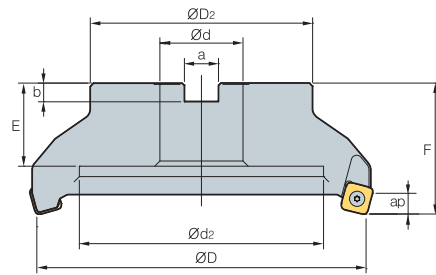

Fig. 2



AA
75°

• AR: -6°
• RR: -8°~ -6°

(mm)

Designation	ØD	ØD ₂	Ød	Ød ₁	Ød ₂	a	b	E	F	ap	$\frac{kg}{m^3}$	Fig.		
RM8EC (RM8ECM)	5080HR-M	6	80	57	25.4 (27)	14	20	9.5 (12.4)	6 (7)	25 (23)	50	11.0	1.1	1
	5100HR-M	7	100	67	31.75 (32)	18	26	12.7 (14.4)	8.0	33 (25)	63 (50)	11.0	2.1 (1.7)	1
	5125HR-M	8	125	87	38.1 (40)	22	32	15.9 (16.4)	10 (9)	35 (30)	63	11.0	3.4 (3.3)	1
	5160R-M	10	160	107	50.8 (40)	-	107	19 (16.4)	11 (9)	38 (32)	63	11.0	4.4 (4.1)	2
	5200R-M	12	200	130	47.625 (60)	-	135	25.4 (25.7)	14.0	38	63	11.0	6.4 (6.1)	2
	5250R-M	15	250	180	47.625 (60)	-	180	25.4 (25.7)	14.0	38	63	11.0	11.0 (10.7)	2
	5315R-M	20	315	240	47.625 (60)	-	238	25.4 (25.7)	14.0	38	63	11.0	18.0 (17.7)	2
	5400R-M	28	400	260	47.625 (60)	-	238	25.4 (25.7)	14.0	38	80	11.0	35.7 (35.4)	2

() Metric size

Available inserts

SNM(E)X-MF

SNEX-ML

SNM(E)X-MM





Designation	Cermet		Coated										Uncoated			page				
	CN2000	CN30	NCM325	NC5330	NCM535	NCM545	PC2505	PC2010	PC3600	PC3700	PC6510	PC9530	PC9540	PC5300	PC5400		ST30A	G10	H01	
SNEX	1507ENN-MF										●			●	●				E22	
	1507ENN-ML										●			●	●					E23
	1507ENN-MM										●			●	●					E24
SNMX	1507ENN-MF				●				●	●	●			●	●				E24	
	1507ENN-MM				●				●	●	●			●	●					

Available arbors

Designation	Available arbors		
	RM8EC	RM8ECM	
RM8EC (RM8ECM)	5080HR-□	BT□□-FMA25.4-□□	BT□□-FMC27-□□
	5100HR-□	BT□□-FMA31.75-□□	BT□□-FMC32-□□
	5125HR-□	BT□□-FMA38.1-□□	BT□□-FMB40-□□
	5160R-□	BT□□-FMA50.8-□□	BT□□-FMC40-□□
	5200R-□		
	5250R-□		
	5315R-□		
	5400R-□	BT□□-FMA47.625-□□	BT□□-FMB60-□□

Parts

Specification	 Screw	 Wrench
Ø80~Ø400	FTGA0513	TW20-100

Available inserts E22~E24

Available arbors and bolt E400~E402

RMH8EC(M)5000

Shim type

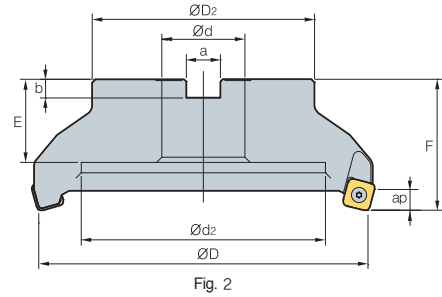
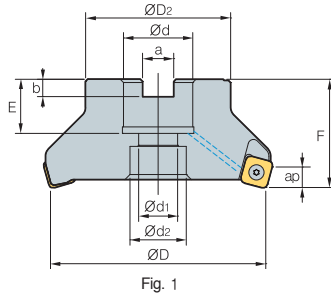

AA
75°

• AR: -6°
• RR: -8°~-6°

(mm)

Designation	ØD	ØD2	Ød	Ød1	Ød2	a	b	E	F	ap	kg	Fig.		
RMH8EC (RMH8ECM)	5080HR-M	6	80	57	25.4 (27)	14	20	9.5 (12.4)	6 (7)	25 (23)	50	11.0	1.1	1
	5100HR-M	7	100	67	31.75 (32)	18	26	12.7 (14.4)	8.0	33 (25.5)	63 (50)	11.0	2.1 (1.7)	1
	5125HR-M	8	125	87	38.1 (40)	22	32	15.9 (16.4)	10 (9)	36 (30)	63	11.0	3.4 (3.3)	1
	5160HR-M	10	160	107	50.8 (60)	-	107	19 (16.4)	11 (9)	38 (32)	63	11.0	4.4 (4.1)	2
	5200R-M	12	200	130	47.625 (60)	-	135	25.4 (25.7)	14.0	38 (32)	63	11.0	6.4 (6.1)	2
	5250R-M	15	250	180	47.625 (60)	-	180	25.4 (25.7)	14.0	38 (32)	63	11.0	110 (10.7)	2
	5315R-M	20	315	240	47.625 (60)	-	238	25.4 (25.7)	14.0	38	63	11.0	18.0 (17.7)	2
	5400R-H	22	400	260	47.625 (60)	-	238	25.4 (25.7)	14.0	38	80	11.0	35.7 (35.4)	2

() Metric size

Available inserts

SNM(E)X-MF

SNEX-ML

SNM(E)X-MM

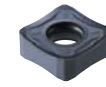

Designation	Cermet		Coated										Uncoated			page				
	CN2000	CN30	NCM325	NC5330	NCM535	NCM545	PC2505	PC2010	PC3600	PC3700	PC6510	PC9530	PC9540	PC5300	PC5400		ST30A	G10	H01	
SNEX	1507ENN-MF										●			●	●				E22	
	1507ENN-ML													●	●					E23
	1507ENN-MM										●			●	●					
SNMX	1507ENN-MF				●				●	●	●			●	●				E24	
	1507ENN-MM				●				●	●	●			●	●					

Available arbors

Designation	Available arbors		
	RMH8EC	RMH8ECM	
RMH8EC (RMH8ECM)	5080HR-□	BT□□-FMA25.4-□□	BT□□-FMC27-□□
	5100HR-□	BT□□-FMA31.75-□□	BT□□-FMC32-□□
	5125HR-□	BT□□-FMA38.1-□□	BT□□-FMB40-□□
	5160R-□	BT□□-FMA50.8-□□	BT□□-FMC40-□□
	5200R-□		
	5250R-□		
	5315R-□	BT□□-FMA47.625-□□	BT□□-FMB60-□□
	5400R-□		

Parts

Specification	Screw	Shim	Shim Screw	Wrench
Ø80~Ø400	FTGA0513	SS53RM8	SHXN0712F	TW20-100

Available inserts E22~E24 Available arbors and bolt E400~E402



RM8QC(M)4000

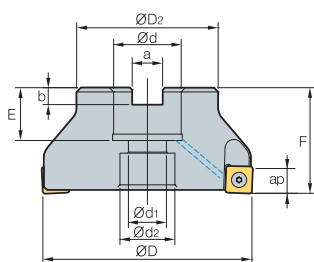

Fig. 1

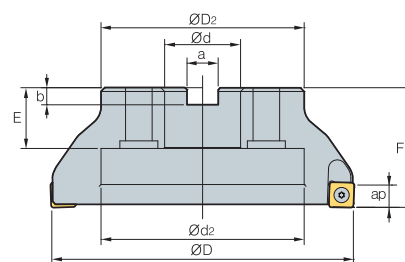

Fig. 2



AA
88°

- AR: -6°
- RR: -8°~ -6°

(mm)

Designation		ØD	ØD2	Ød	Ød1	Ød2	a	b	E	F	ap		Fig.	
RM8QCM	4063HR-M	6	63	49	22	11	18	10.4	6.3	20	40	11.5	0.6	1
	4063HR-H	8	63	49	22	11	18	10.4	6.3	20	40	11.5	0.6	1
RM8QC (RM8QCM)	4080HR-M	7	80	57	25.4 (27)	14	20	9.5 (12.4)	6 (7)	25 (23)	50	11.5	1.1	1
	4080HR-H	10	80	57	25.4 (27)	14	20	9.5 (12.4)	6 (7)	25 (23)	50	11.5	1.0	1
	4100HR-M	8	100	67	31.75 (32)	18	26	12.7 (14.4)	8	33 (25.5)	63 (50)	11.5	1.7	1
	4100HR-H	12	100	67	31.75 (32)	18	26	12.7 (14.4)	8	33 (25.5)	63 (50)	11.5	1.6	1
	4125HR-M	10	125	87	38.1 (40)	22	32	15.9 (16.4)	10 (9)	36 (30)	63	11.5	3.3	1
	4125HR-H	14	125	87	38.1 (40)	22	32	15.9 (16.4)	10 (9)	36 (30)	63	11.5	3.3	1
	4160R-M	12	160	107	50.8 (40)	-	107	19 (16.4)	11 (9)	38 (32)	63	11.5	3.9	2
	4160R-H	18	160	107	50.8 (40)	-	107	19 (16.4)	11 (9)	38 (32)	63	11.5	3.9	2
	4200R-M	14	200	130	47.625 (60)	-	135	25.4 (25.7)	14	38 (32)	63	11.5	6.4	2
	4200R-H	22	200	130	47.625 (60)	-	135	25.4 (25.7)	14	38 (32)	63	11.5	6.4	2

Available inserts

()Metric size

SNM(E)X-MF

SNEX-ML

SNM(E)X-MM

SNEX-MA



Designation	Cermet		Coated										Uncoated			page			
	CN2000	CN30	NCM325	NC5330	NCM535	NCM545	PC2505	PC2010	PC3600	PC3700	PC6510	PC9530	PC9540	PC5300	PC5400		ST30A	G10	H01
SNEX	1206QNN-MF									●	●			●	●				E22 E23 E24
	1206QNN-ML													●	●				
	1206QNN-MM										●			●	●				
	1206QNN-MA																	●	
	120612-MF										●			●	●				
	120612-ML													●	●				
	120612-MM										●								
120612-MA																	●		
SNMX	1206QNN-MF				●			●	●	●			●	●					
	1206QNN-MM				●			●	●	●		●	●						
	120612-MF							●	●	●			●	●					
	120612-MM							●	●	●			●	●					

Available arbors

Designation	Available arbors	
	RM8QC	RM8QCM
RM8QCM 4063HR-□	-	BT□□-FMC22-□□
RM8QC 4080HR-□	BT□□-FMA25.4-□□	BT□□-FMC27-□□
(RM8QCM) 4100HR-□	BT□□-FMA31.75-□□	BT□□-FMC32-□□
4125HR-□	BT□□-FMA38.1-□□	BT□□-FMB40-□□
4160R-□	BT□□-FMA50.8-□□	BT□□-FMC40-□□
4200R-□	BT□□-FMA47.625-□□	BT□□-FMB60-□□

Parts

Specification		
Ø63-Ø200	PTKA0411-R3	TW15S

Available inserts E22~E24

Available arbors and bolt E400~E402

RMH8QC(M)4000

Shim type

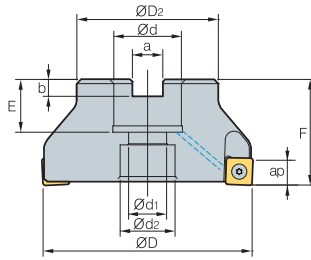

Fig. 1

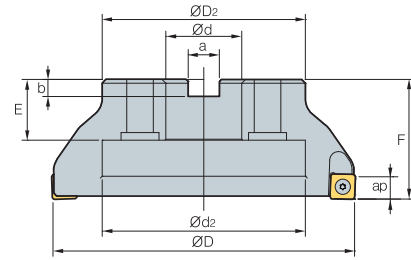

Fig. 2

AA **88°**
 • AR: -6°
 • RR: -8°~ -6°

Designation		⊙	ØD	ØD ₂	Ød	Ød ₁	Ød ₂	a	b	E	F	ap		Fig.
RMH8QC (RMH8QCM)	4080HR-M	7	80	57	25.4 (27)	14	20	9.5 (12.4)	6 (7)	25 (23)	50	11.5	1.1	1
	4100HR-M	8	100	67	31.75 (32)	18	26	12.7 (14.4)	8	33 (25.5)	63 (50)	11.5	2.5	1
	4125HR-M	10	125	87	38.1 (40)	22	32	15.9 (16.4)	10 (9)	36 (30)	63	11.5	3.0	1
	4160R-M	12	160	107	50.8 (40)	-	107	19 (16.4)	11 (9)	38 (32)	63	11.5	4.0	2
	4200R-M	16	200	130	47.625 (60)	-	135	25.4 (25.7)	14	38 (32)	63	11.5	5.9	2

(mm)

()Metric size

Available inserts

SNM(E)X-MF SNEX-ML SNM(E)X-MM SNEX-MA



Designation	Cermet		Coated											Uncoated			page		
	CN2000	CN30	NCM325	NC5330	NCM535	NCM545	PC2505	PC2010	PC3600	PC3700	PC6510	PC9530	PC9540	PC5300	PC5400	ST30A		G10	H01
SNEX	1206QNN-MF									●	●								E22 E23 E24
	1206QNN-ML													●	●				
	1206QNN-MM										●			●	●				
	1206QNN-MA																	●	
	120612-MF										●			●	●				
	120612-ML													●	●				
	120612-MM										●								
SNMX	1206QNN-MF				●				●	●	●			●	●				
	1206QNN-MM				●				●	●	●		●	●	●				
	120612-MF								●	●	●			●	●				
	120612-MM								●	●	●			●	●				

Available arbors

Designation	Available arbors		
	RMH8QC	RMH8QCM	
RMH8QC (RMH8QCM)	4080HR-□	BT□□-FMA25.4-□□	BT□□-FMC27-□□
	4100HR-□	BT□□-FMA31.75-□□	BT□□-FMC32-□□
	4125HR-□	BT□□-FMA38.1-□□	BT□□-FMB40-□□
	4160R-□	BT□□-FMA50.8-□□	BT□□-FMC40-□□
	4200R-□	BT□□-FMA47.625-□□	BT□□-FMB60-□□

Parts

Specification				
Ø80~Ø200	PTKA0411-R3	SS42RM8	SHXN0609F	TW15S

Available inserts E22~E24 Available arbors and bolt E400~E402



RMT8A(M)4000

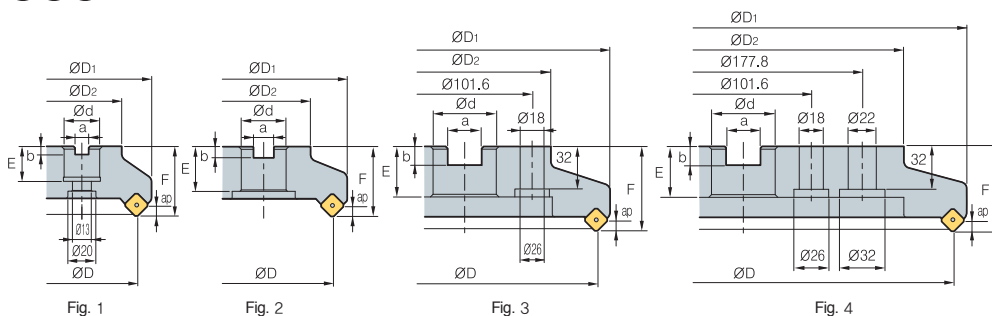

(mm)

Designation	ØD	ØD1	ØD2	Ød	a	b	E	F	ap	kg	Fig.
RMT8A (RMT8AM) 4080R	80	100	57	25.4 (27)	9.5 (12.4)	6 (7)	25 (22)	50	4	1.6	1
4080R-M	80	100	57	25.4 (27)	9.5 (12.4)	6 (7)	25 (22)	50	4	1.6	1
4100R	100	120	70	31.75 (32)	12.7 (14.4)	8 (8)	32 (28)	50	4	2.3	2
4100R-M	100	120	70	31.75 (32)	12.7 (14.4)	8 (8)	32 (28)	50	4	2.3	2
4125R	125	144	87	38.1 (40)	15.9 (16.4)	10 (9)	38 (30)	63	4	4.3	2
4125R-M	125	144	87	38.1 (40)	15.9 (16.4)	10 (9)	38 (30)	63	4	4.3	2
4160R	160	179	110	50.8 (40)	19.0 (16.4)	11 (9)	38 (30)	63	4	6.5	2
4160R-M	160	179	110	50.8 (40)	19.0 (16.4)	11 (9)	38 (30)	63	4	6.5	2
4200R	200	219	130	47.625 (60)	25.4 (25.7)	14 (14)	38 (38)	63	4	8.8	3
4200R-M	200	219	130	47.625 (60)	25.4 (25.7)	14 (14)	38 (38)	63	4	8.8	3
4250R	250	269	180	47.625 (60)	25.4 (25.7)	14 (14)	38 (38)	63	4	14.1	3
4250R-M	250	269	180	47.625 (60)	25.4 (25.7)	14 (14)	38 (38)	63	4	14.1	3
4315R	315	334	240	47.625 (60)	25.4 (25.7)	14 (14)	38 (38)	63	4	22.3	4
4315R-M	315	334	240	47.625 (60)	25.4 (25.7)	14 (14)	38 (38)	63	4	22.3	4

Available inserts

() Metric size

SNC(M)F-MF SNC(M)F-MM



Designation	Cermet		Coated										Uncoated			page			
	CN2000	CN80	NCM325	NC5330	NCM535	NCM545	PC2505	PC2010	PC3600	PC3700	PC8510	PC9530	PC9540	PC5300	PC5400		ST30A	G10	H01
SNCF 1206ANN-MF																			E20
1206ANN-MM																			
SNMF 1206ANN-MF																			E21
1206ANN-MM																			

Available arbors

Designation	General arbor	NC arbors	
		RMT8A	RMT8AM
RMT8A (RMT8AM) □080R	NT*□□(M/U)-FMA25.4-25	BT**□□-FMA25.4-□□	FMC27
□100R	NT*□□(M/U)-FMA31.75-□□	BT**□□-FMA31.75-□□	FMC32
□125R	NT*□□(M/U)-FMA38.1-□□	BT**□□-FMA38.1-□□	FMB40
□160R	NT*□□(M/U)-FMA50.8-□□	BT**□□-FMA50.8-□□	
□200R	NT*□□(M/U)-FMA47.625-25, KCP-8***	BT**□□-FMA47.625-□□	FMB60
□250R			
□315R	KCP-8*** (Center ring plug)	-	-

*□□-NT number **□□-BT number ***Over milling 5

Parts

Specification	Screw	Screw	Spring	Latch	Wrench
Ø80-Ø315	ETKA0523	KHB0417	SPR0315	LTC05SR-RM4	TW20-100

Available inserts E20, E21

Available arbors and bolt E400~E402

RMT8A(M)5000

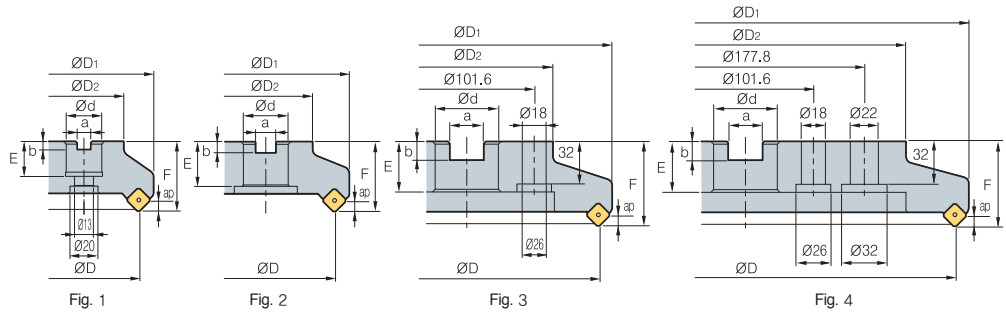

• AR: -6°
• RR: -6°

(mm)

Designation	⊙	ØD	ØD1	ØD2	Ød	a	b	E	F	ap		Fig.	
RMT8A (RMT8AM)	5080R	5	80	104	57	25.4 (27)	9.5 (12.4)	6 (7)	25 (22)	50	6	1.8	1
	5080R-M	6	80	104	57	25.4 (27)	9.5 (12.4)	6 (7)	25 (22)	50	6	1.8	1
	5100R	6	100	124	70	31.75 (32)	12.7 (14.4)	8 (8)	32 (28)	50	6	2.6	2
	5100R-M	8	100	124	70	31.75 (32)	12.7 (14.4)	8 (8)	32 (28)	50	6	2.6	2
	5125R	8	125	149	87	38.1 (40)	15.9 (16.4)	10 (9)	38 (30)	63	6	4.3	2
	5125R-M	10	125	149	87	38.1 (40)	15.9 (16.4)	10 (9)	38 (30)	63	6	4.3	2
	5160R	10	160	184	110	50.8 (40)	19.0 (16.4)	11 (9)	38 (30)	63	6	6.5	2
	5160R-M	14	160	184	110	50.8 (40)	19.0 (16.4)	11 (9)	38 (30)	63	6	6.5	2
	5200R	12	200	224	130	47.625 (60)	25.4 (25.7)	14 (14)	38 (38)	63	6	9.0	3
	5200R-M	18	200	224	130	47.625 (60)	25.4 (25.7)	14 (14)	38 (38)	63	6	9.0	3
	5250R	16	250	274	180	47.625 (60)	25.4 (25.7)	14 (14)	38 (38)	63	6	14.4	3
	5250R-M	22	250	274	180	47.625 (60)	25.4 (25.7)	14 (14)	38 (38)	63	6	14.4	3
	5315R	20	315	339	240	47.625 (60)	25.4 (25.7)	14 (14)	38 (38)	63	6	22.2	4
	5315R-M	28	315	339	240	47.625 (60)	25.4 (25.7)	14 (14)	38 (38)	63	6	22.2	4

Available inserts

() Metric size

SNC(M)F-MF SNC(M)F-MM



Designation	Cermet		Coated										Uncoated			page			
	CN2000	CN80	NCM325	NC5330	NCM535	NCM545	PC2505	PC2010	PC3600	PC3700	PC6510	PC9530	PC9540	PC5300	PC5400		ST30A	G10	H01
SNCF	1507ANN-MF										●								E20
	1507ANN-MM																		
SNMF	1507ANN-MF																		E21
	1507ANN-MM																		

Available arbors

Designation	General arbor	NC arbors		
		RMT8A	RMT8AM	
RMT8A (RMT8AM)	□080R	NT*□□(M/U)-FMA25.4-25	BT**□□-FMA25.4-□□	FMC27
	□100R	NT*□□(M/U)-FMA31.75-□□	BT**□□-FMA31.75	FMC32
	□125R	NT*□□(M/U)-FMA38.1-□□	BT**□□-FMA38.1	FMC32
	□160R	NT*□□(M/U)-FMA50.8-□□	BT**□□-FMA50.8	
	□200R	NT*□□(M/U)-FMA47.625-25, KCP-8***	BT**□□-FMA47.625-□□	FMB60
	□250R			
□315R	KCP-8*** (Center ring plug)	-	-	

*□□-NT number **□□-BT number ***Over milling 5

Parts

Specification					
Ø80~Ø315	ETKA0625	KHB0417	SPR0415	LTC06SR-RM5	TW20-100

Available inserts E20, E21 Available arbors and bolt E400~E402



RMT8E(M)4000

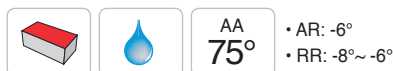
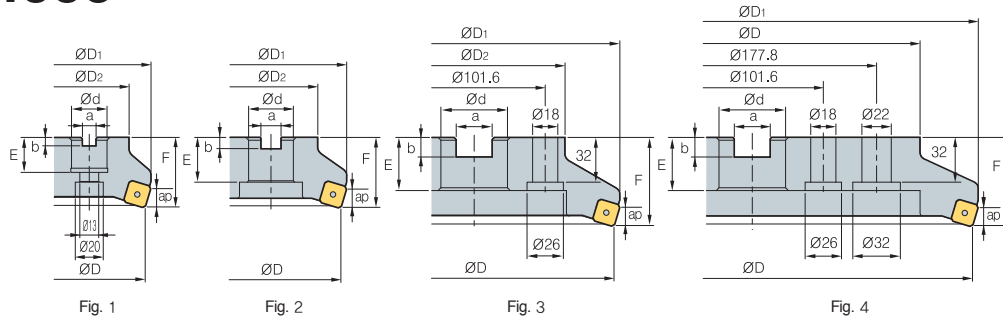

Designation	ØD	ØD1	ØD2	Ød	a	b	E	F	ap	kg	Fig.
RMT8E (RMT8EM) 4080R	80	100	57	25.4 (27)	9.5 (12.4)	6 (7)	25 (22)	50	5	1.5	1
4080R-M	80	100	57	25.4 (27)	9.5 (12.4)	6 (7)	25 (22)	50	5	1.5	1
4100R	100	120	67	31.75 (32)	12.7 (14.4)	8 (8)	32 (28)	50	5	2	2
4100R-M	100	120	67	31.75 (32)	12.7 (14.4)	8 (8)	32 (28)	50	5	2	2
4125R	125	144	87	38.1 (40)	15.9 (16.4)	10 (9)	38 (30)	63	5	3.8	2
4125R-M	125	144	87	38.1 (40)	15.9 (16.4)	10 (9)	38 (30)	63	5	3.8	2
4160R	160	179	107	50.8 (40)	19.0 (16.4)	11 (9)	38 (30)	63	5	5.8	2
4160R-M	160	179	107	50.8 (40)	19.0 (16.4)	11 (9)	38 (30)	63	5	5.8	2
4200R	200	219	130	47.625 (60)	25.4 (25.7)	14 (14)	38 (38)	63	5	7.9	3
4200R-M	200	219	130	47.625 (60)	25.4 (25.7)	14 (14)	38 (38)	63	5	7.9	3
4250R	250	269	180	47.625 (60)	25.4 (25.7)	14 (14)	38 (38)	63	5	13.0	3
4250R-M	250	269	180	47.625 (60)	25.4 (25.7)	14 (14)	38 (38)	63	5	13.0	3
4315R	315	334	240	47.625 (60)	25.4 (25.7)	14 (14)	38 (38)	63	5	20.5	4
4315R-M	315	334	240	47.625 (60)	25.4 (25.7)	14 (14)	38 (38)	63	5	20.5	4

Available inserts

SNC(M)F-MF SNC(M)F-MM



Designation	Cermet		Coated										Uncoated			page		
	CN2000	CN30	NCM825	NC5330	NCM635	NCM645	PC2505	PC2010	PC3600	PC3700	PC6510	PC9530	PC9540	PC5300	PC5400		ST30A	G10
SNCF 1206ENN-MM										●								
SNMF 1206ENN-MM										●								
										●								

Available arbors

Designation	General arbor	NC arbors	
		RMT8E	RMT8EM
<input type="checkbox"/> 080R	NT* <input type="checkbox"/> <input type="checkbox"/> (M/U)-FMA25.4-25	BT** <input type="checkbox"/> <input type="checkbox"/> -FMA25.4- <input type="checkbox"/> <input type="checkbox"/>	FMC27
<input type="checkbox"/> 100R	NT* <input type="checkbox"/> <input type="checkbox"/> (M/U)-FMA31.75- <input type="checkbox"/> <input type="checkbox"/>	BT** <input type="checkbox"/> <input type="checkbox"/> -FMA31.75- <input type="checkbox"/> <input type="checkbox"/>	FMC32
<input type="checkbox"/> 125R	NT* <input type="checkbox"/> <input type="checkbox"/> (M/U)-FMA38.1- <input type="checkbox"/> <input type="checkbox"/>	BT** <input type="checkbox"/> <input type="checkbox"/> -FMA38.1- <input type="checkbox"/> <input type="checkbox"/>	FMB40
<input type="checkbox"/> 160R	NT* <input type="checkbox"/> <input type="checkbox"/> (M/U)-FMA50.8- <input type="checkbox"/> <input type="checkbox"/>	BT** <input type="checkbox"/> <input type="checkbox"/> -FMA50.8- <input type="checkbox"/> <input type="checkbox"/>	
<input type="checkbox"/> 200R	NT* <input type="checkbox"/> <input type="checkbox"/> (M/U)-FMA47.625-25, KCP-8***	BT** <input type="checkbox"/> <input type="checkbox"/> -FMA47.625- <input type="checkbox"/> <input type="checkbox"/>	FMB60
<input type="checkbox"/> 250R			
<input type="checkbox"/> 315R	KCP-8*** (Center ring plug)	-	-

*-NT number **-BT number ***Over milling 5

Parts

Specification					
Ø80-Ø315	ETKA0523	KHB0417	SPR0315	LTC05SR-RM4	TW20-100

Available inserts E20, E21 Available arbors and bolt E400~E402



RMT8E(M)5000

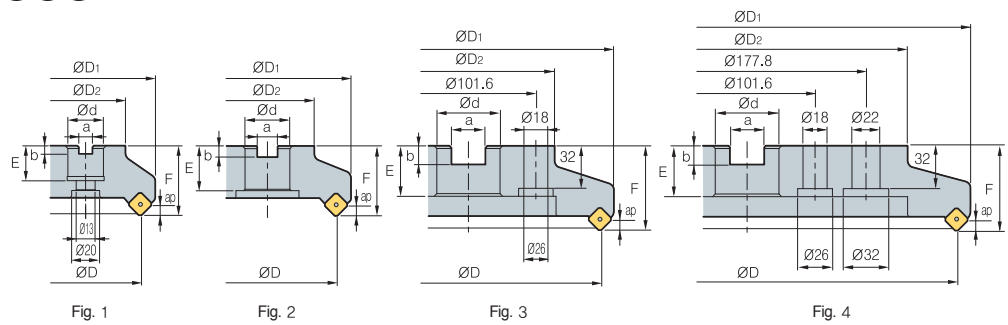

AA
75°

• AR: -6°
• RR: -8°~ -6°

(mm)

Designation		ØD	ØD1	ØD2	Ød	a	b	E	F	ap	kg	Fig.	
RMT8E (RMT8EM)	5080R	5	80	88	57	25.4 (27)	9.5 (12.4)	6 (7)	25 (22)	50	8	1.4	1
	5080R-M	6	80	88	57	25.4 (27)	9.5 (12.4)	6 (7)	25 (22)	50	8	1.4	1
	5100R	6	100	108	67	31.75 (32)	12.7 (14.4)	8 (8)	32 (28)	50	8	1.9	2
	5100R-M	8	100	108	67	31.75 (32)	12.7 (14.4)	8 (8)	32 (28)	50	8	1.9	2
	5125R	8	125	133	87	38.1 (40)	15.9 (16.4)	10 (9)	38 (30)	63	8	3.7	2
	5125R-M	10	125	133	87	38.1 (40)	15.9 (16.4)	10 (9)	38 (30)	63	8	3.7	2
	5160R	10	160	168	107	50.8 (40)	19.0 (16.4)	11 (9)	38 (30)	63	8	5.7	2
	5160R-M	14	160	168	107	50.8 (40)	19.0 (16.4)	11 (9)	38 (30)	63	8	5.7	2
	5200R	12	200	208	130	47.625 (60)	25.4 (25.7)	14 (14)	38 (38)	63	8	7.5	3
	5200R-M	18	200	208	130	47.625 (60)	25.4 (25.7)	14 (14)	38 (38)	63	8	7.5	3
	5250R	16	250	258	180	47.625 (60)	25.4 (25.7)	14 (14)	38 (38)	63	8	12.4	3
	5250R-M	22	250	258	180	47.625 (60)	25.4 (25.7)	14 (14)	38 (38)	63	8	12.4	3
	5315R	20	315	323	240	47.625 (60)	25.4 (25.7)	14 (14)	38 (38)	63	8	19.9	4
	5315R-M	28	315	323	240	47.625 (60)	25.4 (25.7)	14 (14)	38 (38)	63	8	19.9	4

() Metric size

Available inserts

SNC(M)F-MF SNC(M)F-MM



Designation	Cermet		Coated										Uncoated			page		
	CN2000	CN30	NCM325	NC5330	NCM635	NCM545	PC2505	PC2010	PC3600	PC3700	PC6510	PC9530	PC9540	PC5300	PC5400		ST30A	G10
SNCF 1507ENN-MF											●							
1507ENN-MM																		
SNMF 1507ENN-MF																		
1507ENN-MM																		

Available arbors

Designation	General arbor	NC arbors	
		RMT8E	RMT8EM
RMT8E (RMT8EM) □080R	NT*□□(M/U)-FMA25.4-25	BT**□□-FMA25.4-□□	FMC27
□100R	NT*□□(M/U)-FMA31.75-□□	BT**□□-FMA31.75-□□	FMC32
□125R	NT*□□(M/U)-FMA38.1-□□	BT**□□-FMA38.1-□□	FMB40
□160R	NT*□□(M/U)-FMA50.8-□□	BT**□□-FMA50.8-□□	FMB60
□200R	NT*□□(M/U)-FMA47.625-25,	BT**□□-FMA47.625-□□	FMB60
□250R	KCP-8***		
□315R	KCP-8*** (Center ring plug)		

*□□-NT number **□□-BT number ***Over milling 5

Parts

Specification					
Ø80~Ø315	ETKA0625	KHB0417	SPR0415	LTC06SR-RM5	TW20-100

Available inserts E20, E21 Available arbors and bolt E400~E402



RMT8Q(M)4000

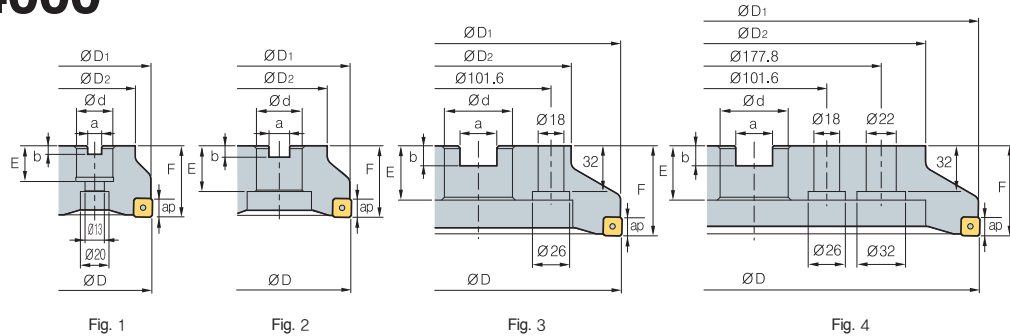
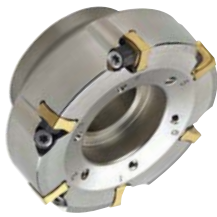

AA
88°
• AR: -6°
• RR: -11°~ -6°

Designation	ØD	ØD1	ØD2	Ød	a	b	E	F	ap	kg	Fig.	
RMT8Q												
(RMT8QM)												
4080R	5	80	79	57	25.4 (27)	9.5 (12.4)	6 (7)	25 (22)	50	5	1.4	1
4080R-M	6	80	79	57	25.4 (27)	9.5 (12.4)	6 (7)	25 (22)	50	5	1.4	1
4100R	6	100	99	67	31.75 (32)	12.7 (14.4)	8 (8)	32 (28)	50	5	1.8	2
4100R-M	8	100	99	67	31.75 (32)	12.7 (14.4)	8 (8)	32 (28)	50	5	1.8	2
4125R	8	125	124	87	38.1 (40)	15.9 (16.4)	10 (9)	38 (30)	63	5	3.6	2
4125R-M	10	125	124	87	38.1 (40)	15.9 (16.4)	10 (9)	38 (30)	63	5	3.6	2
4160R	10	160	159	107	50.8 (40)	19.0 (16.4)	11 (9)	38 (30)	63	5	5.7	2
4160R-M	14	160	159	107	50.8 (40)	19.0 (16.4)	11 (9)	38 (30)	63	5	5.7	2
4200R	12	200	199	130	47.625 (60)	25.4 (25.7)	14 (14)	38 (38)	63	5	7.5	3
4200R-M	18	200	199	130	47.625 (60)	25.4 (25.7)	14 (14)	38 (38)	63	5	7.5	3
4250R	16	250	249	180	47.625 (60)	25.4 (25.7)	14 (14)	38 (38)	63	5	12.5	3
4250R-M	22	250	249	180	47.625 (60)	25.4 (25.7)	14 (14)	38 (38)	63	5	12.5	3
4315R	20	315	314	240	47.625 (60)	25.4 (25.7)	14 (14)	38 (38)	63	5	19.9	4
4315R-M	28	315	314	240	47.625 (60)	25.4 (25.7)	14 (14)	38 (38)	63	5	19.9	4

() Metric size

Available inserts

SNC(M)F-MF SNC(M)F-MM



Designation	Cermet		Coated										Uncoated			page			
	CN2000	CN30	NCM325	NC5330	NCM535	NCM545	PC2505	PC2010	PC3600	PC3700	PC6510	PC9530	PC9540	PC5300	PC5400		ST30A	G10	H01
SNCF											●								E20
										●									
SNMF									●										

Available arbors

Designation	General arbor	NC arbors	
		RMT8Q	RMT8QM
RMT8Q	□080R	BT**□□-FMA25.4-□□	FMC27
(RMT8QM)	□100R	BT**□□-FMA31.75-□□	FMC32
	□125R	BT**□□-FMA38.1-□□	FMB40
	□160R	BT**□□-FMA50.8-□□	
	□200R	BT**□□-FMA47.625-□□	FMB60
	□250R		
	□315R	KCP-8*** (Center ring plug)	-

*□□-NT number **□□-BT number ***Over milling 5

Parts

Specification					
Ø80-Ø315	ETKA0523	KHB0417	SPR0315	LTC05SR-RM4	TW20-100

Available inserts E20 Available arbors and bolt E400~E402

RM16AC(M)6000

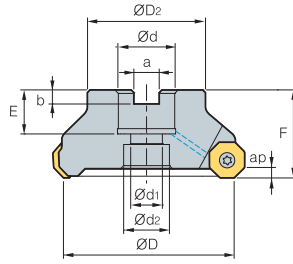

Fig. 1

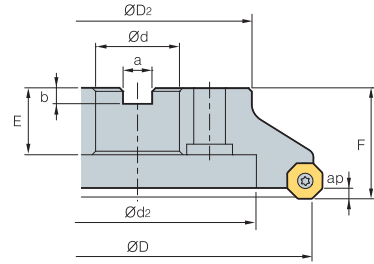

Fig. 2



• AR: -6°
• RR: -6°

(mm)

Designation	ØD	ØD2	Ød	Ød1	Ød2	a	b	E	F	ap	kg	Fig.	
RM16ACM 6063HR-M	5	63	49	22	11	18	10.4	6.3	20	40	4.0	0.7	1
RM16AC (RM16ACM) 6080HR-M	6	80	57	25.4 (27)	14	20	9.5 (12.4)	6 (7)	25 (23)	50	4.0	1.2	1
6100HR-M	7	100	67	31.75 (32)	18	26	12.7 (14.4)	8	33 (25)	63 (50)	4.0	1.9	1
6125HR-M	8	125	87	38.1 (40)	22	32	15.9 (16.4)	10 (9)	35 (29)	63	4.0	3.5	1
6160R-M	10	160	107	50.8 (40)	-	107	19 (16.4)	11 (9)	38 (32)	63	4.0	4.1	2
6200R-M	12	200	130	47.625 (60)	-	135	25.4 (25.7)	14	38 (32)	63	4.0	6.1	2
6250R-M	15	250	180	47.625 (60)	-	180	25.4 (25.7)	14	38	63	4.0	11.5	2
6315R-M	20	315	240	47.625 (60)	-	238	25.4 (25.7)	14	38	63	4.0	18.9	2
6400R-M	26	400	260	47.625 (60)	-	238	25.4 (25.7)	14	38	80	4.0	32.7	2

() Metric size

Available inserts



Designation	Cermet		Coated										Uncoated			page			
	CN2000	CN30	NCM325	NC5330	NCM535	NCM545	PC2505	PC2010	PC3600	PC3700	PC6510	PC9530	PC9540	PC5300	PC5400		ST30A	G10	H01
ONHX 060608-MM											●			●	●				E14
060608-MF											●			●	●				
060608-ML														●	●				
060608-MA																		●	
060608-W											●	●		●	●				
0606ANN-MM											●	●		●	●				
0606ANN-MF											●	●		●	●				
ONMX 060608-MM					●				●	●	●		●	●	●				
060608-MF					●				●	●	●		●	●	●				
0606ANN-MM					●				●	●	●		●	●	●				
0606ANN-MF					●				●	●	●		●	●	●				

Available arbors

Designation	Available arbors	
	RM16AC	RM16ACM
RM16AC (RM16ACM) 6063HR-M		BT□□-FMC22-□□
6080HR-M	BT□□-FMA25.4-□□	BT□□-FMC27-□□
6100HR-M	BT□□-FMA31.75-□□	BT□□-FMC32-□□
6125HR-M	BT□□-FMA38.1-□□	BT□□-FMB40-□□
6160R-M	BT□□-FMA50.8-□□	BT□□-FMC40-□□
6200R-M		
6250R-M		
6315R-M		
6400R-M	BT□□-FMA47.625-□□	BT□□-FMB60-□□

Parts

Specification	Screw	Wrench
Ø63~Ø400	FTGA0513	TW20-100

Available inserts E14 Available arbors and bolt E400~E402



RM16AC(M)8000

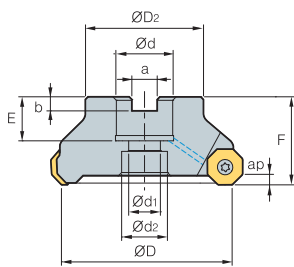

Fig. 1

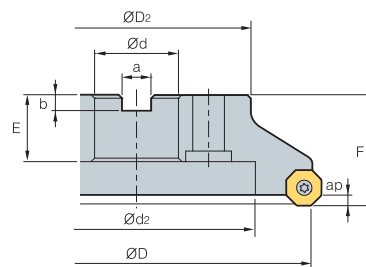



Fig. 2



AA
45°

- AR: -6°
- RR: -6°

(mm)

Designation		ØD	ØD2	Ød	Ød1	Ød2	a	b	E	F	ap	 kg	Fig.
RM16ACM 8063HR-M	5	63	49	22	11	18	10.4	6.3	20	40	5.5	0.7	1
RM16AC 8080HR-M	6	80	57	25.4 (27)	14	20	9.5 (12.4)	6 (7)	25 (23)	50	5.5	1.2	1
(RM16ACM) 8100HR-M	7	100	67	31.75 (32)	18	26	12.7 (14.4)	8	33 (25)	63 (50)	5.5	1.8	1
8125HR-M	8	125	87	38.1 (40)	22	32	15.9 (16.4)	10 (9)	35 (29)	63	5.5	3.5	1
8160R-M	10	160	107	50.8 (40)	-	107	19 (16.4)	11 (9)	38 (32)	63	5.5	4.5	2
8200R-M	12	200	130	47.625 (60)	-	135	25.4 (25.7)	14 (14)	38 (32)	63	5.5	5.8	2
8250R-M	14	250	180	47.625 (60)	-	180	25.4 (25.7)	14	38	63	5.5	11.4	2
8315R-M	18	315	240	47.625 (60)	-	238	25.4 (25.7)	14	38	63	5.5	18.8	2
8400R-M	24	400	260	47.625 (60)	-	238	25.4 (25.7)	14	38	80	5.5	32.7	2

() Metric size

Available inserts

ONHX-MF	ONHX-ML	ONHX-MM	ONHX-W	ONHX-MA	ONMX-MF	ONMX-MM
						

Designation	Cermet		Coated										Uncoated			page		
	CN2000	CN30	NCM325	NC530	NCM535	NCM545	PC2505	PC2010	PC3600	PC3700	PC8510	PC9530	PC9540	PC5300	PC5400		ST30A	G10
ONHX 080608-MM											●			●	●			
080608-MF											●			●	●			
080608-ML														●	●			
080608-MA																		●
080608-W											●			●	●			
0806ANN-MM											●			●	●			
0806ANN-MF											●			●	●			
ONMX 080608-MM					●			●	●	●	●			●	●			
080608-MF					●			●	●	●	●			●	●			
0806ANN-MM					●			●	●	●	●			●	●			
0806ANN-MF					●			●	●	●	●			●	●			

E14

Available arbors

Designation	Available arbors	
	RM16AC	RM16ACM
RM16AC 8063HR-M	-	BT□□-FMC22-□□
(RM16ACM) 8080HR-M	BT□□-FMA25.4-□□	BT□□-FMC27-□□
8100HR-M	BT□□-FMA31.75-□□	BT□□-FMC32-□□
8125HR-M	BT□□-FMA38.1-□□	BT□□-FMB40-□□
8160R-M	BT□□-FMA50.8-□□	BT□□-FMC40-□□
8200R-M		
8250R-M		
8315R-M		
8400R-M	BT□□-FMA47.625-□□	BT□□-FMB60-□□

Parts

Specification		
Ø63-Ø400	FTGA0513	TW20-100

Available inserts E14 Available arbors and bolt E400~E402



E Technical Information for Aero Mill

Lighter tool ensures excellent performance in high speed machining

Aero Mill

- Excellent machining performance can be acquired especially at the high speeds due to the light aluminum cutter body that is 50% of the weight of a conventional steel cutter body
- High speed milling cutter for precise machining
- Special aluminum material and high rake angle of insert provide rigid & stable machining
- High tolerance surface finishes can be acquired due to the low cutting load provided from the high rake angle
- Balanceable up to G2.5 level

➤ Assembly structure of cutter

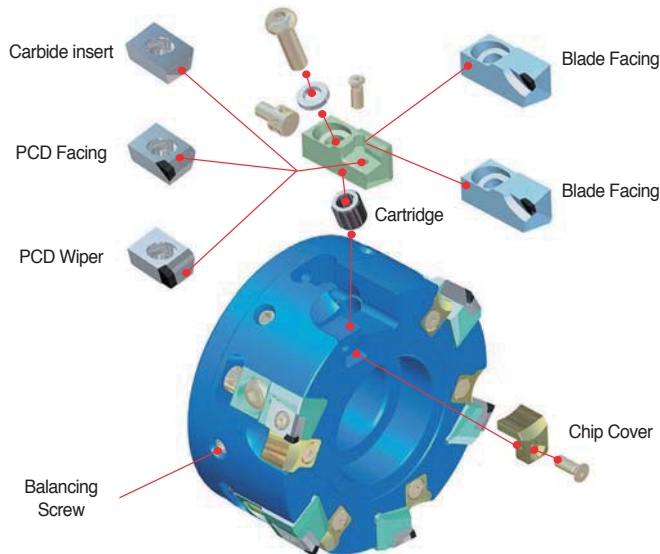

➤ Features of cutter

- Increased stability based on cartridge type application
- Both insert and blade can be available in the same cutter
- Finishing to roughing can be possible because of wide chip pocket space
- Roughing and finishing available with carbide, PCD insert application
- Cutter breakage can be solved by making use of the chip cover

➤ Coolant through system

- Specially designed coolant through system provides coolant from the center of the cutter to the insert enhances the cooling rate and chip evacuation.
- Direction of coolant has designed to focus directly to the insert cutting-edge to maximize chip evacuation and improve tool life
- Coolant bolt is applicable up to $\text{Ø}160$, coolant cover is applicable from $\text{Ø}200$ and over.
Coolant devices are sold separately for through coolant system, through coolant arbor has to be used

Coolant Bolt

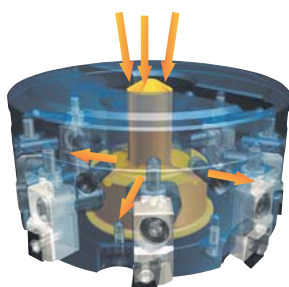

For $\text{Ø}80\text{--}\text{Ø}160$

Coolant Cover

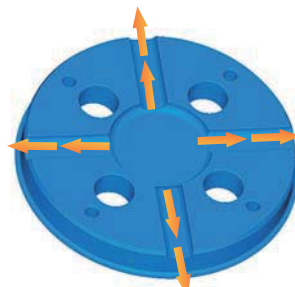

For $\text{Ø}200$ and over



Aero Mill

Application range

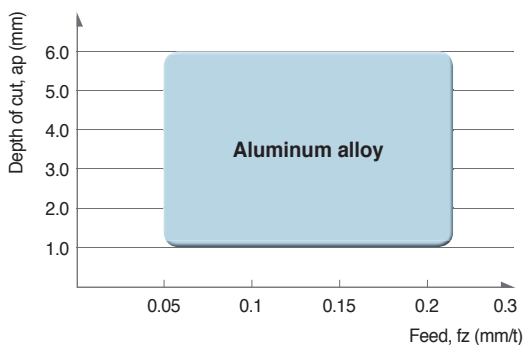

Recommended cutting condition

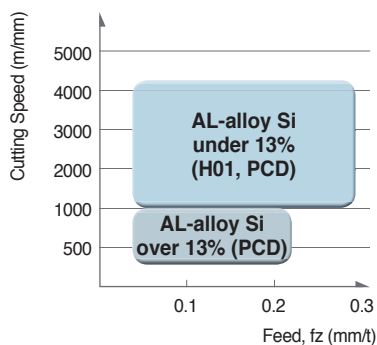

Surface finish

- **Workpiece** A6061
- **Cutting condition** vc = 1570 m/min vf = 3000 mm/min
S = 5000 rpm fz = 0.1 mm/t
ap = 0.5 mm Machine = PCV620
- **Designation** **Cutter** APD100R-A6Z (6 Flutes)
Insert CDEW1204R-XCF (H01)

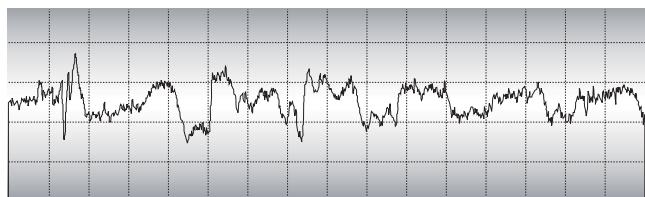

- Rmax: 2.1 μm
- Rz: 1.6 μm
- Ra: 0.3 μm

Max. revolution

Diameter (mm)	Max. revolution (rpm)
Ø80	16,000
Ø100	15,000
Ø125	12,500
Ø160	10,000
Ø200	8,000
Ø250	6,500
Ø315	5,000

Coolant parts

Diameter (mm)	Type	Designation	Shape	Note
Ø80	Coolant Bolt	CBP080-IN/MM		Extra charge
Ø100	Coolant Bolt	CBP100-IN CBP100-MM-1		
Ø125	Coolant Bolt	CBP125-IN CBP125-MM-1		
Ø160	Coolant Bolt	CBP160-IN CBP160-MM		
Ø200	Coolant Cover	CCP200		
Ø250	Coolant Cover	CCP250		
Ø315	Coolant Cover	CCP315		

• Choice: CBP100-IN:APD type, General for unmarked item

E Technical Information for Aero Mill-Plus

High speed milling tool with PCD blade

Aero Mill-Plus

- Improve tool life up to 20% with a coolant system that enables direct spray cooling to cutting blades
- Enable high feed milling by increasing the number of cutting blades by 20% through a simply structured coupling method for clamps
- Reduces set up time up to 40% by applying a spanner adjustment method
- Introduce an aluminum cutter body to provide a superior cutting performance during high speed milling

Assembly structure of cutter

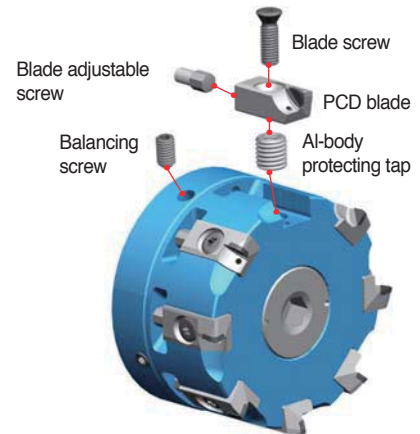

Features of cutter

- Prevent overload to the spindle bearings through weight reduction of the Al alloy body and enable high-speed processing
- Provide PCD Blade-dedicated cutter design to offer stable tool life and increase of applied blades
- Improve the blade life by applying a coolant system that enables direct spray cooling to cutting blades
- Adopt a clamping method with simple structure without set screw
- Reduce weight and apply a coolant bolt that is exclusively used for Aero-Mill Plus that applies coolant to remove internal chip

Code system

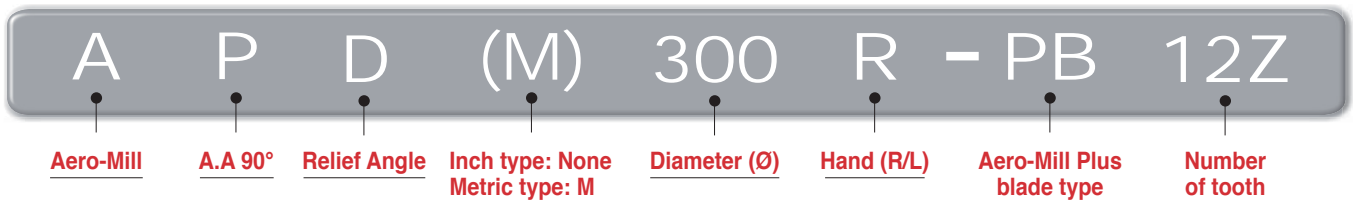

Application range

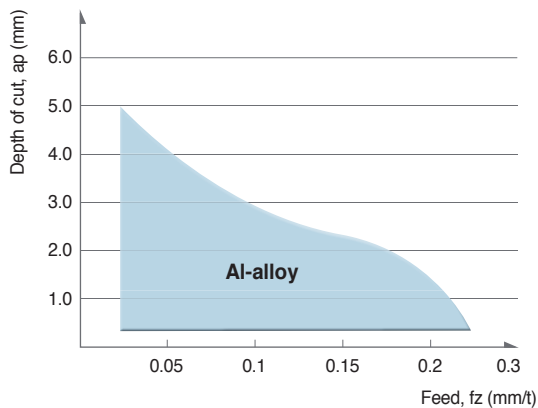

Recommended cutting speed

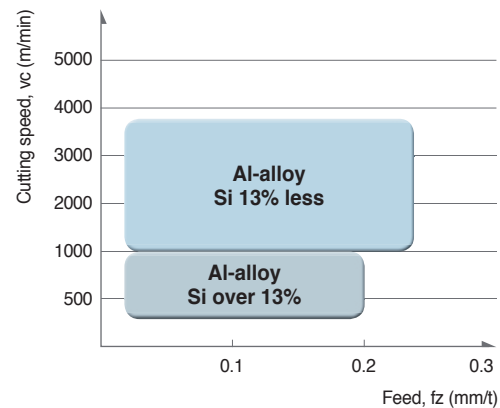

Max. RPM

Diameter (mm)	Max. revolution (rpm)
Ø80	20,000
Ø100	18,000
Ø125	16,000
Ø160	13,000
Ø200	10,000
Ø250	8,000
Ø315	7,000

Coolant parts

Diameter (mm)	Type	inch/mm	Designation	Shape	Material	Note
Ø80	Coolant bolt	inch, mm	CB12-AMaP80		Steel	Included
		inch	CB16-AMP100			
		mm	CB16-AMP100M			
		inch	CB20-AMP125			
		mm	CB20-AMP125M			
		inch	CB24-AMP160			
Ø160	Coolant cover	inch, mm	CCV-AMP200		Aluminum	Extra charge
		inch, mm	CCV-AMP250			
		inch, mm	CCV-AMP315			



Good performance in small-medium size of operations

Aero Mill-Mini

- Good performance in small-medium size of operations
- Good duration of the steel body
- Choice of Uncoated carbide/PCD grades can be applied to various kind of work material
- Balance level: G25

Features of cutter

- Simple and strong design of Screw-on clamping.
- Adjustable range: ± 0.1 mm Max
- Adjustable step: Min. 2 micro meter
- Wide chip pocket area for Roughing and Aluminum machining.
- Inner coolant system

Assembly structure of cutter

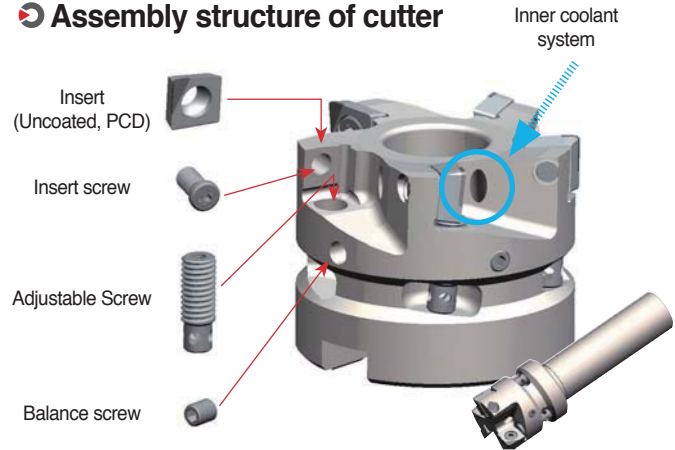

Code system



Application range

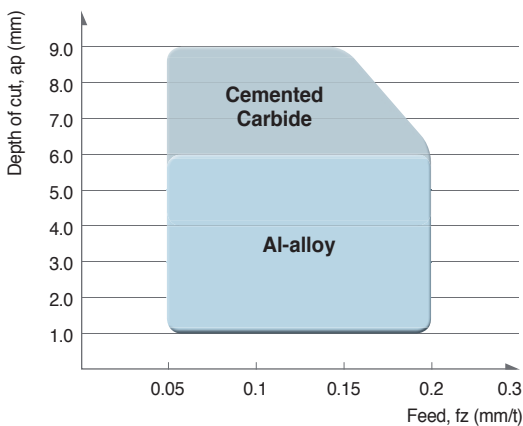

Recommended cutting condition

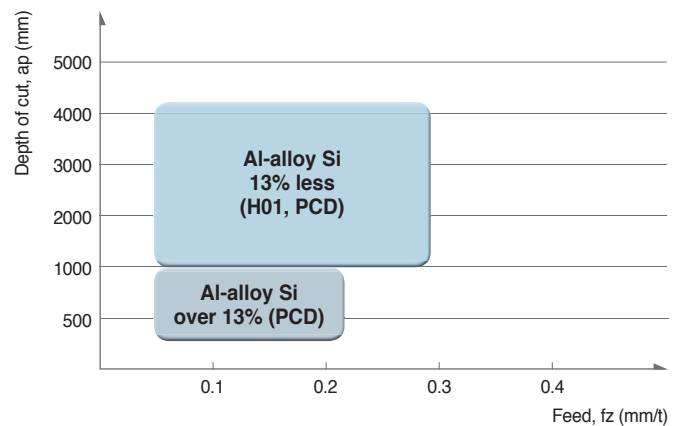

Max. RPM

Diameter	Max. RPM (min ⁻¹)
Ø32	26,000
Ø40	24,500
Ø50	22,000
Ø63	20,000

APD(M)-A

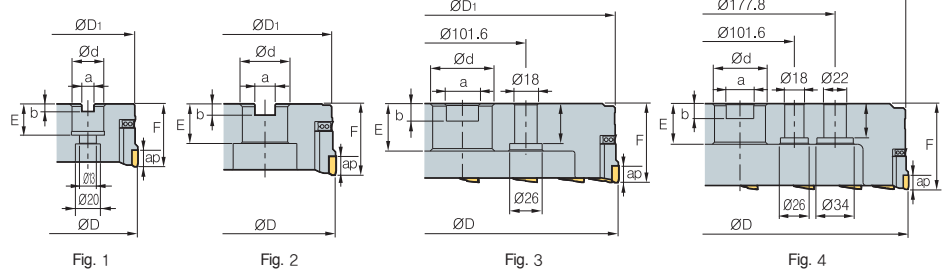
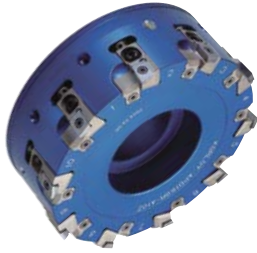

AA
90°
• AR: 6°
• RR: 5°~9°

(mm)

Designation		ØD	ØD ₁	Ød	a	b	E	F	ap	Max rpm		Fig.	
APD	080R/L-A6Z	6	80	76	25.4 (27)	9.5 (12.4)	6 (7)	25 (22)	50	10	16000	0.75	1
(APDM)	100R/L-A6Z	6	100	95	31.75 (32)	12.7 (14.4)	8 (8)	32 (28)	50	10	15000	0.95	2
	125R/L-A8Z	8	125	120	38.1 (40)	15.9 (16.4)	10 (9)	38 (30)	63	10	12500	1.8	2
	160R/L-A10Z	10	160	155	50.8 (40)	19.0 (16.4)	11 (9)	38 (30)	63	10	10000	2.9	2
	200R/L-A12Z	12	200	195	47.625 (60)	25.4 (25.7)	14 (14)	38 (38)	63	10	8000	4.0	3
	250R/L-A16Z	16	250	245	47.625 (60)	25.4 (25.7)	14 (14)	38 (38)	63	10	6500	6.3	3
	315R/L-A18Z	18	315	310	47.625 (60)	25.4 (25.7)	14 (14)	38 (38)	80	10	5000	11.3	4

()Metric size

Available inserts

CDEW-XCF CDEW-XAF, NAF CDEW-XAW, NAW



Designation	Uncoated			PCD	page
	H01	G10	ST30A	DP200	
CDEW	1204R-XCF	●			E06 E07
	1204L-XCF				
	1204R-XAF			●	
	1204L-XAF				
	1204R-NAF			●	
	1204L-NAF				
	1204R-XAW			●	
	1204L-XAW				
	1204R-NAW			●	
	1204L-NAW				

Available arbors

Designation	General arbor	NC arbors
APD	080R/L NT*□□(M/U)-FMA25.4-25	BT**□□-FMA25.4
(APDM)	100R/L NT*□□(M/U)-FMA31.75-□□	BT**□□-FMA31.75
	125R/L NT*□□(M/U)-FMA38.1-□□	BT**□□-FMA38.1
	160R/L NT*□□(M/U)-FMA50.8-□□	BT**□□-FMA50.8
	200R/L NT*□□(M/U)-FMA47.625-25, 250R/L KCP-8***	BT**□□-FMA47.625-□□
	315R/L KCP-8*** (Center ring plug)	-

*□□-NT number **□□-BT number ***Over milling 5

Recommended cutting condition

Workpiece	Cutting condition		Grades
	vc (m/min)	fz (mm/t)	
Aluminum	1,000~4,000 500~2,500	0.05~0.30 0.05~0.20	DP200 H01

Parts

Specification								
Ø80~Ø315	LAPDR/L-AJ	CAPDR/L-AJ	PTMA0411	FTNA0411	AZ0514	BHA0619-NYLOK	TW15S	HW50

Available inserts E06, E07 Available arbors and bolt E400~E402



APD(M)-PB

Blade

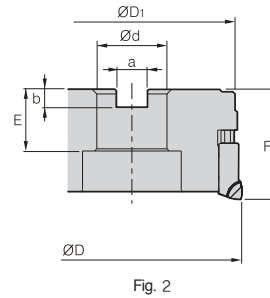
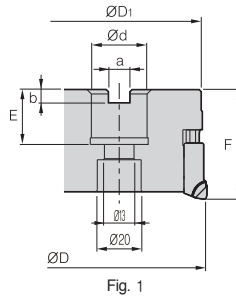
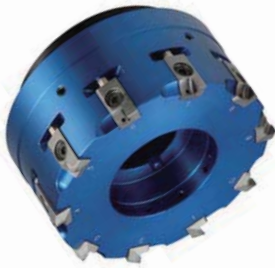

AA
90°

• AR: 6°
• RR: -4°~1°

Designation		⊙	Max ⊙	ØD	ØD ₁	Ød	a	b	E	F	ap	kg	Fig.
APD (APDM)	080R/L-PB6Z	6	10	80	77	25.4 (27)	9.5 (12.4)	6 (7)	23.5	50	5	0.55	1
	080R/L-PB8Z	8	10	80	77	25.4 (27)	9.5 (12.4)	6 (7)	23.5	50	5	0.55	1
	100R/L-PB6Z	6	12	100	97	31.75 (32)	12.7 (14.4)	8	34 (32)	50	5	0.92	2
	100R/L-PB8Z	8	12	100	97	31.75 (32)	12.7 (14.4)	8	34 (32)	50	5	0.92	2
	125R/L-PB8Z	8	14	125	122	38.1 (40)	15.9 (16.4)	10 (9)	40 (35)	63	5	1.9	2
	125R/L-PB10Z	10	14	125	122	38.1 (40)	15.9 (16.4)	10 (9)	40 (35)	63	5	1.9	2
	160R/L-PB10Z	10	20	160	157	50.8 (40)	19.0 (16.4)	11 (9)	41 (35)	63	5	3.3	2
160R/L-PB12Z	12	20	160	157	50.8 (40)	19.0 (16.4)	11 (9)	41 (35)	63	5	3.3	2	

() Metric size

Available blades

BAMPR-XAF BAMPR-XAW BAMPR-XAWR



Designation	PCD	page
	DP150	
BAMPR-XAF	●	E06
BAMPR-XAW	●	
BAMPR-XAWR		

Available arbors

Designation	NC arbors
APD-PB (APDM-PB) 080R/L-PB□□Z	BT□□-FMA25.4(FMC27)-□□
100R/L-PB□□Z	BT□□-FMA31.75(FMC32)-□□
125R/L-PB□□Z	BT□□-FMA38.1(FMB40)-□□
160R/L-PB□□Z	BT□□-FMA50.8(FMB/FMC40)-□□

Parts

Specification						
Ø80-Ø160	ETKA0620	AZ0514-SPN6	UZD1010	KHE0610	SPN-6	TW25-100

Available inserts E06 Available arbors and bolt E400~E402

APD(M)-PB

Blade

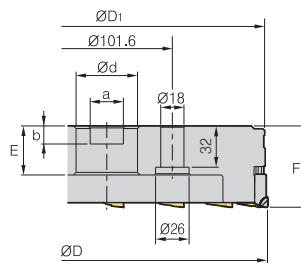

Fig. 1

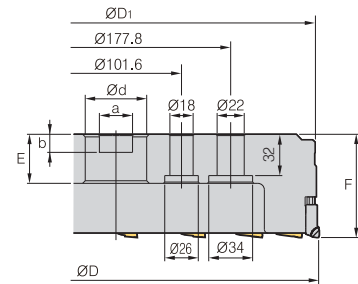

Fig. 2



AA
90°

• AR: -6°
• RR: -39°~-16°

(mm)

Designation		Max	ØD	ØD1	Ød	a	b	E	F	ap	kg	Fig.	
APD	200R/L-PB12Z	12	26	200	197	47.625 (60)	25.4 (25.7)	14	40	63	5	4.0	1
(APDM)	250R/L-PB16Z	16	32	250	247	47.625 (60)	25.4 (25.7)	14	40	63	5	6.5	1
	315R/L-PB18Z	18	42	315	312	47.625 (60)	25.4 (25.7)	14	40	63	5	11.3	2

() Metric size

Available blades

BAMPR-XAF

BAMPR-XAW

BAMPR-XAWR



Designation	PCD	page
	DP150	
BAMPR-XAF	●	E06
BAMPR-XAW	●	
BAMPR-XAWR		

Available arbors

Designation	NC arbors
APD-PB	BT□□-FMA47.625(FMB60)-□□
(APDM-PB)	
315R/L-PB□□Z	

Parts

Specification						
Ø200-Ø315	ETKA0620	AZ0514-SPN6	UZD1010	KHE0610	SPN-6	TW25-100

Available inserts E06 Available arbors and bolt E400~E402



MAPDS000HR/L-Z0

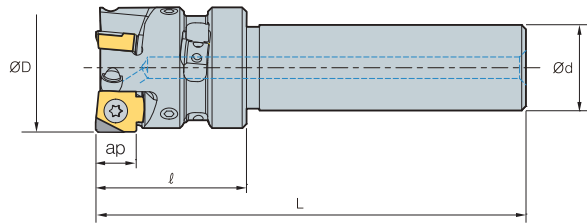

* PCD ap: 5mm



Designation			ØD	Ød	l	L	ap	Max rpm	
MAPDS	032HR/L-Z3	3	32	20	35	100	9.5	26,000	0.35
	040HR/L-Z4	4	40	20	35	100	9.5	24,500	0.42

(mm)

Available inserts

SNEW SNEW-XAF SNEW-NAF

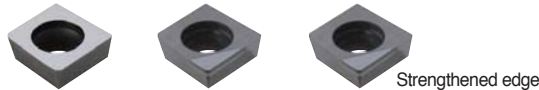

Designation	Uncoated			PCD	page
	H01	G10	ST30A	DP200	
SNEW 09T3ADFR	●				E22 E23
09T3ADTR-XAF				●	
09T3ADTR-XAW				●	
09T3ADTR-NAF				●	
09T3ADTR-NAW				●	

Parts

Specification					
Ø32~Ø63	FTKA0408	AHX0617F-NYLOK	KHD0405	TW15S	HW20L

Available inserts E22, E23

MAPD000HR/L-Z0

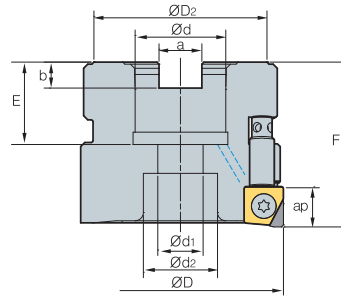

* PCD ap: 5 mm



AA
90°

• AR: 6°
• RR: -1°~12°

(mm)

Designation		ØD	ØD ₂	Ød	a	b	E	F	Ød ₁	Ød ₂	ap	Max rpm		
MAPD	040HR/L-Z4	4	40	34	16	8.4	5.6	18	40	9	14	9.5	24,000	0.24
	050HR/L-Z5	5	50	42	22	10.4	6.3	20	40	11	18	9.5	22,000	0.35
	063HR/L-Z6	6	63	42	22	10.4	6.3	20	40	11	18	9.5	20,000	0.65

Available inserts

SNEW

SNEW-XAF

SNEW-NAF

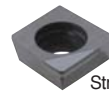
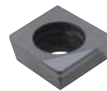
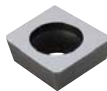

Strengthened edge

Designation	Uncoated				PCD	page
	H01	G10	ST30A	ST20	DP200	
SNEW	09T3ADFR	●				E22 E23
	09T3ADTR-XAF				●	
	09T3ADTR-XAW				●	
	09T3ADTR-NAF				●	
	09T3ADTR-NAW				●	

Available arbors

Designation	NC arbors
MAPD	040HR/L-Z4
	050HR/L-Z5
	063HR/L-Z6

BT**□□-FMC16-□□
BT**□□-FMC22-□□
BT**□□-FMC22-□□

Recommended cutting condition

Workpiece	Cutting condition		Grades
	vc (m/min)	fz (mm/t)	
Aluminum	1,000~4,000 500~2,500	0.05~0.30 0.05~0.20	DP200 H01

Coolant bolt (Not included)

Designation	Applicable cutter	Available cutters
CB0525	MAPD040HR/L-Z4	Ø40
CB1025	MAPD050HR/L-Z5	Ø50
	MAPD063HR/L-Z6	Ø63

Parts

Specification					
Ø32~Ø63	FTKA0408	AHX0617F-NYLK	KHD0405	TW15S	HW20L

Available inserts E22, E23 Available arbors and bolt E400~E402



Code system

PDF
6
032
-
HSK63A

PCD Face cutter

Tooth

Diameter

Shank

PCD Face cutter

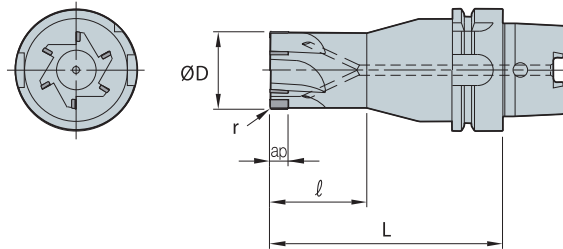

AA
90°
• AR: 6°
• RR: 5°~9°

	Designation		ØD	r	ap	l	L
PDF	4032-HSK50A	4	32	0.5	8	50	120
	4040-HSK50A	4	40	0.5	8	50	120
	4032-HSK63A	4	32	0.5	8	50	120
	4040-HSK63A	4	40	0.5	8	50	120
	4050-HSK63A	4	50	0.5	8	50	120
	6063-HSK63A	6	63	0.5	12	-	100
	6063-HSK100A	6	63	0.5	12	-	100

(mm)

Recommended cutting condition

Workpiece	vc (m/min)	fz (mm/t)	ap (mm)
Al, Brass, Alloy	200~2,000	0.02~0.1	0.05~4.0

Special PCD order sheet

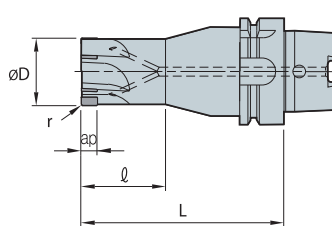
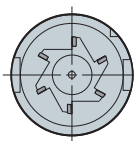

Fig. 1

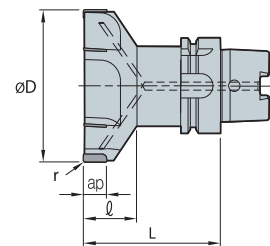

Fig. 2

Designation	Fig.	tooth	Dimensions (mm)					Shank spec.
			ØD	r	ap	l	L	
PDF								



E Technical Information for Alpha Mill-X

Milling tool for high productivity with good perpendicularity and minimized cutting load

Alpha Mill-X new

- Superior perpendicularity is achieved by its design and optimized for high quality surface finish.
- Lower cutting load and minimized burr due to high rake angle cutting edge
- Improved productivity due to high-speed capability and high feed machining
(Compared to existing tools, cutting speed and feed per tooth are improved by 15%)

Code system

• Shank type

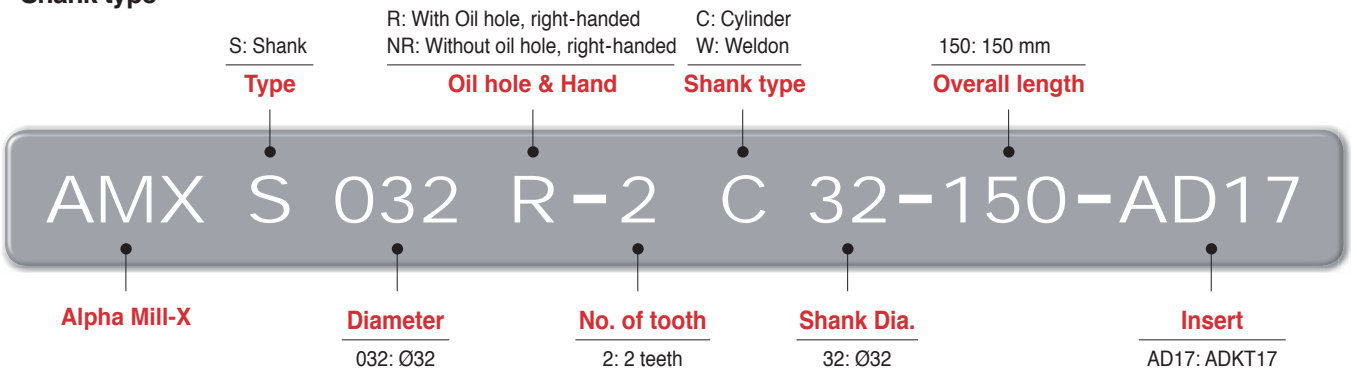

• Cutter type

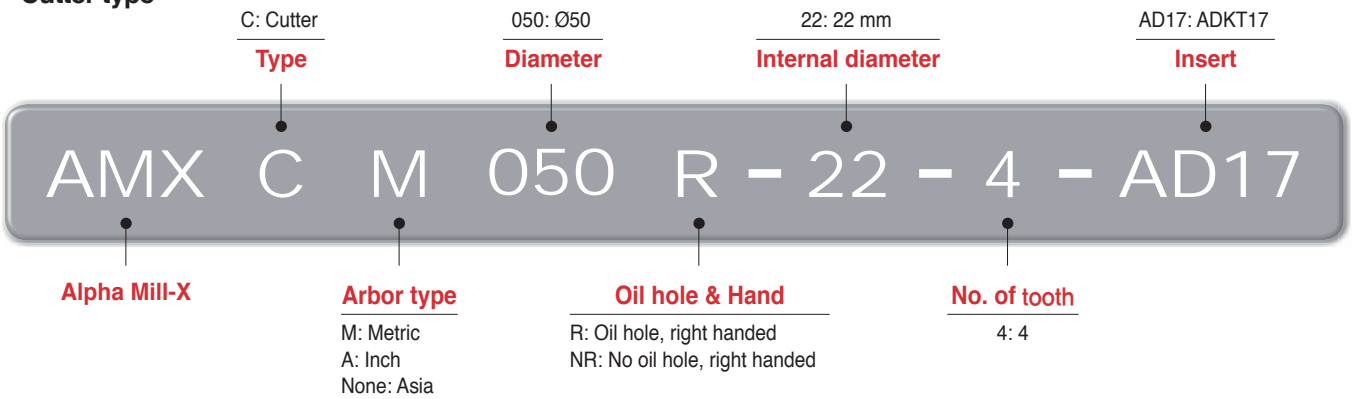

Cutting load

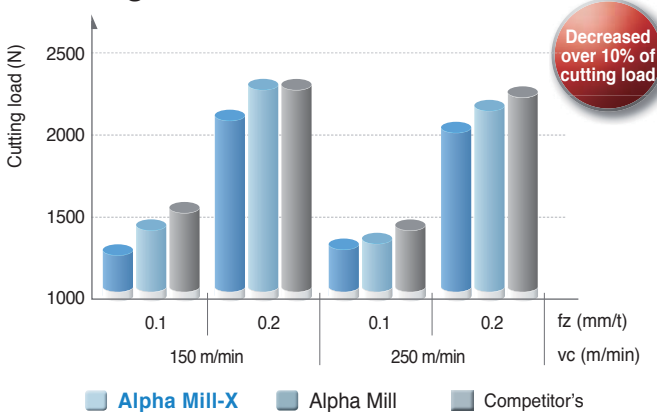

Application area

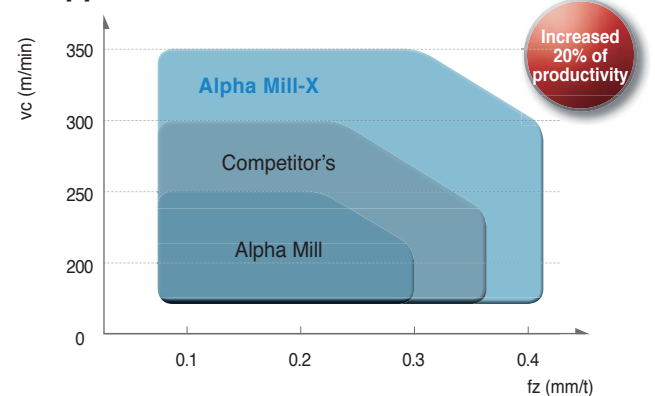

Features

High rake angle chip breaker

- Applied high rake angle
- Improved chip control

Applied minor cutting edge with a wiper function

- Minor cutting edge design optimized to excellent surface in machined surfaces

Flat clamping area

- Stable clamping in high speed and high feed machining

High rake cutting edge

- Better surface roughness
- Lower cutting load

Wider chip pocket

- Maximized chip control
- Outstanding chip control in high speed and high feed machining

Perfect perpendicularity

Existing Alpha Mill
APMT1604PDSR-MM

- Applying cutting edge with high rake angle: decreased cutting load
- Thicker insert: high rigidity of insert

Alpha Mill-X
ADKT170608PESR-MM

- Optimal for high speed and high feed machining

Cutting condition for ramping and helical operation

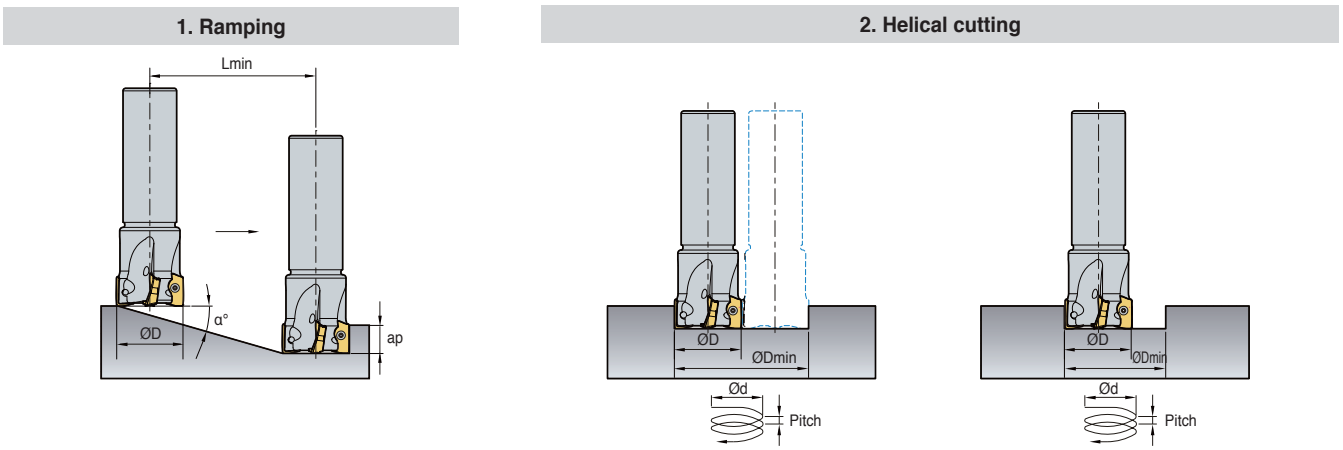

Designation	Tool dia. ØD (min)	ap	1. Ramping		2. Helical cutting					
			Maximum angle α (°)	Lmin (mm)	Blind hole		Through hole			
					Max. desirable hole dia. ØDH Max (mm)	Max. pitch dmax (mm)	Min. desirable hole dia. ØDH Min (mm)	Max. pitch dmax (mm)	Min. desirable hole dia. ØDH Min (mm)	Max. pitch dmax (mm)
ADKT17	20	16.5	13.0	71.5	30.4	7.0	38.4	8.9	20.8	4.8
	25	16.5	8.0	117.4	40.4	5.7	48.4	6.8	30.8	4.3
	32	16.5	3.7	255.2	54.4	3.5	62.4	4.0	44.8	2.9
	33	16.5	3.6	262.3	56.4	3.5	64.4	4.1	46.8	2.9
	40	16.5	2.6	363.4	70.4	3.2	78.4	3.6	60.8	2.8
	50	16.5	1.9	497.4	90.4	3.0	98.4	3.3	80.8	2.7
	63	16.5	1.3	727.1	116.4	2.6	124.4	2.8	106.8	2.4
	80	16.5	1.1	859.3	150.4	2.9	158.4	3.0	140.8	2.7

* In ramping and helical machining, use coolant and air. Lmin - $ap/\tan(\alpha^\circ)$

Recommended cutting conditions

• ADKT17 (Surface machining and shouldering)

ISO	Recommended grade	ADKT1706 □ □ PESR-MM / ML		
		vc	fz	max ap
P	PC5300	150~240 m/min (492~787 sfm)	0.3~0.05 mm/t (0.012~0.002 ipt)	16.5 mm (0.65 in)
	PC5400	130~210 m/min (426~688 sfm)	0.3~0.05 mm/t (0.002~0.012 ipt)	
	PC3700	160~270 m/min (426~688 sfm)	0.3~0.05 mm/t (0.002~0.012 ipt)	
M	PC5300	90~150 m/min (295~492 sfm)	0.25~0.05 mm/t (0.01~0.002 ipt)	
	PC5400	70~120 m/min (229~393 sfm)	0.25~0.05 mm/t (0.01~0.002 ipt)	
K	PC5300	120~200 m/min (393~656 sfm)	0.35~0.08 mm/t (0.014~0.003 ipt)	
S	PC5300	40~70m/min (131~229 sfm)	0.2~0.05 mm/t (0.014~0.002 ipt)	
	PC5400	30~50m/min (98~164 sfm)	0.2~0.05 mm/t (0.014~0.002 ipt)	

※ Maximum cutting condition: vc = 350 m/min, fz = 0.4 mm/t according to cutting environment

• ADKT17 (Grooving, ramping and helical machining)

ISO	Recommended grade	ADKT1706 □ □ PESR-MM / ML		
		vc	fz	max ap
P	PC5300	150~240 m/min (492~787 sfm)	0.15~0.05 mm/t (0.012~0.002 ipt)	16.5 mm (0.65 in)
	PC5400	130~210 m/min (426~688 sfm)	0.15~0.05 mm/t (0.002~0.012 ipt)	
	PC3700	160~270 m/min (426~688 sfm)	0.3~0.05 mm/t (0.002~0.012 ipt)	
M	PC5300	90~150 m/min (295~492 sfm)	0.15~0.05 mm/t (0.01~0.002 ipt)	
	PC5400	70~120 m/min (229~393 sfm)	0.15~0.05 mm/t (0.01~0.002 ipt)	
K	PC5300	120~200 m/min (393~656 sfm)	0.2~0.08 mm/t (0.014~0.003 ipt)	
S	PC5300	40~70m/min (131~229 sfm)	0.15~0.05 mm/t (0.006~0.002 ipt)	
	PC5400	30~50m/min (98~164 sfm)	0.15~0.05 mm/t (0.006~0.002 ipt)	

※ In deep grooving, set ap under 5 mm and use coolant and air.

Recommended Chip Breakers for workpiece

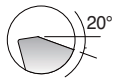
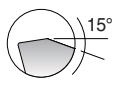
Chip breaker	Cutting edge shape	Recommended C/B and grade as per workpiece (●: 1st recommendation)											
		P		M		K		N		S			
		Low carbon steel/ Mild steel		High carbon steel/ Alloy steel		Stainless steel		Cast iron		Aluminum alloy steel		Ti/Inconel	
		C/B	Grades	C/B	Grades	C/B	Grades	C/B	Grades	C/B	Grades	C/B	Grades
ML		-	● PC3700 ○ PC5300 ○ PC5400	-	● PC3700 ○ PC5300 ○ PC5400	●	● PC5300 ○ PC5400	-	● PC6510 ○ PC5300 ○ PC5400	-	-	●	● PC5300 ○ PC5400
MM		-	● PC3700 ○ PC5300 ○ PC5400	●	● PC3700 ○ PC5300 ○ PC5400	-	● PC5300 ○ PC5400	●	● PC6510 ○ PC5300 ○ PC5400	-	-	-	● PC5300 ○ PC5400



AMXCM new

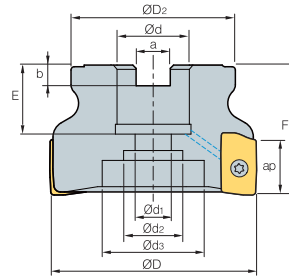

AA
90°
• AR: 8°
• RR: -10°~3°

(mm)

Designation		$\varnothing D$	$\varnothing D_2$	$\varnothing d$	$\varnothing d_1$	$\varnothing d_2$	$\varnothing d_3$	a	b	E	F	ap	
AMXCM 040R-16-3-AD17	3	40	35	16	9	14	-	8.4	5.6	19	40	16.5	0.18
040R-16-4-AD17	4	40	35	16	9	14	-	8.4	5.6	19	40	16.5	0.18
050R-22-4-AD17	4	50	42	22	11	18	-	10.4	6.3	20	40	16.5	0.23
050R-22-5-AD17	5	50	42	22	11	18	-	10.4	6.3	20	40	16.5	0.20
063R-22-5-AD17	5	63	49	22	11	18	-	10.4	6.3	20	40	16.5	0.44
063R-22-6-AD17	6	63	49	22	11	18	-	10.4	6.3	20	40	16.5	0.49
080R-27-6-AD17	6	80	57	27	14	25	38	12.4	7.0	23	50	16.5	0.88
080R-27-7-AD17	7	80	57	27	14	25	38	12.4	7.0	23	50	16.5	0.90

Available inserts

ADKT-ML ADKT-MM



Designation	Cermet		Coated											Uncoated		page		
	CN2000	CN30	NCM325	NC5330	NCM635	NCM545	PC2505	PC2010	PC3600	PC3700	PC6510	PC9530	PC9540	PC5300	PC5400		G10	H01
ADKT 170604PESR-MM																		E04
170608PESR-MM					●					●	●		●	●	●			
170608PESR-ML					●					●	●		●	●	●			
170616PESR-MM														●	●			
170620PESR-MM														●	●			

Available arbors

Designation	NC arbors
AMXCM 040R-16-3-AD17	BT□□-FMC26-□□
040R-16-4-AD17	BT□□-FMC26-□□
050R-22-4-AD17	BT□□-FMC22-□□
050R-22-5-AD17	BT□□-FMC22-□□
063R-22-5-AD17	BT□□-FMC22-□□
063R-22-6-AD17	BT□□-FMC22-□□
080R-27-6-AD17	BT□□-FMC27-□□
080R-27-7-AD17	BT□□-FMC27-□□

Parts

Specification		
$\varnothing 40\sim\varnothing 80$	FTKA0410	TW15S

Available inserts **E04** Available arbors and bolt **E400~E402**



AMXS new

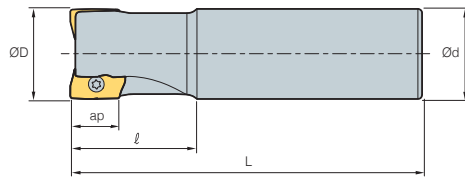

Fig. 1

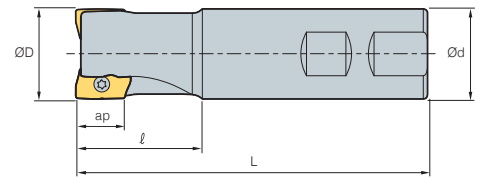

Fig. 2



AA
90°
• AR: 8°
• RR: -10°~3°

(mm)

Designation		ØD	Ød	ℓ	L	ap		Fig.
AMXS 020R-1C20-180-AD17	1	20	20	35	180	16.5	0.36	1
020R-1W20-090-AD17	1	20	20	35	90	16.5	0.16	2
025R-2C25-200-AD17	2	25	25	35	200	16.5	0.66	1
025R-2W25-115-AD17	2	25	25	35	115	16.5	0.34	2
032R-3C32-200-AD17	3	32	32	45	200	16.5	1.05	1
032R-3W32-125-AD17	3	32	32	45	125	16.5	0.62	2
033R-3C32-200-AD17	3	33	32	45	200	16.5	1.05	1
033R-3W32-125-AD17	3	33	32	45	125	16.5	0.62	2
040R-3C32-200-AD17	3	40	32	50	200	16.5	1.17	1
040R-3W32-130-AD17	3	40	32	50	130	16.5	0.75	2
040R-4C32-200-AD17	4	40	32	50	200	16.5	1.20	1
040R-4W32-130-AD17	4	40	32	50	130	16.5	0.74	2

Available inserts

ADKT-ML ADKT-MM



Designation	Cermet		Coated										Uncoated		page			
	CN2000	CN30	NCM325	NC5330	NCM535	NCM545	PC2505	PC2010	PC3600	PC3700	PC6510	PC9530	PC9540	PC5300		PC5400	G10	H01
ADKT 170604PESR-MM																		E04
170608PESR-MM					●				●	●		●	●	●				
170608PESR-ML					●				●	●		●	●	●				
170616PESR-MM														●	●			
170620PESR-MM														●	●			

Parts

Specification		
Ø40~Ø80	FTKA0410	TW15S

Available inserts E04 Available arbors and bolt E400~E402



Various applications are available with multi-functional cutters

Alpha Mill

- Innovative curve cutting-edge and chip-breaker design ensures ideal 90-degree cutting, lower cutting resistance, and improved insert life.
- Various applications are available with multi-functional cutters. (Facing, Slotting, Square shoulder milling, etc.)
- Excellent performance ensured at large depth of cut operations due to strong cutting-edge and low cutting resistance.

Features of insert

- Long tool life at high speed, high feed and deeper cutting by low cutting resistance and strong cutting-edge
- Distinguished features of Alpha-Curve reduce cutting resistance and improve cutting-edge strength and wear resistance
- Low cutting resistance is realized by KORLOY unique design-the alpha curve cutting-edge and optimal convex and concave design
- Highly efficient machining is available by the ideal application of the grade to material

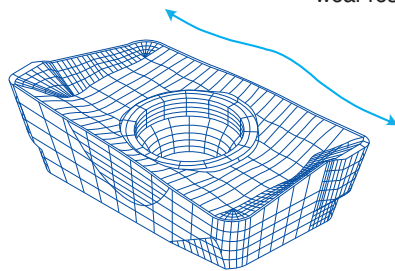

Application example

Shouldering

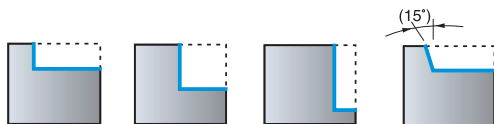

Slotting



Drilling



Ramping

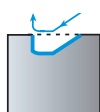

Helical cutting

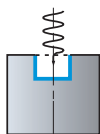

Alpha Mill Nick new



- New nick cutting edge reduces cutting load
- High productivity
- APMT standard holders are compatible with Alpha Mill nick that is reducing stock management cost.

Features

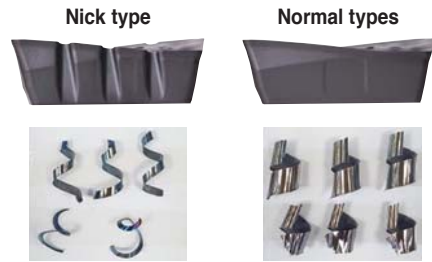
- Lower cutting load due to the overlapping system

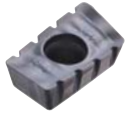

- ※ Nick types require both chip breaker types for application.
- ※ Can be used with the existing Alpha Mill holders. Use multi-edges for maximum results. (cutters with even-numbered teeth)

Type	Nick type		General type
Required No. of teeth	20		20
For AMCM3080M (4 Flute x 5 teeth)	 x 10 APMT16-MN3	 x 10 APMT16-MN4	 x 20 APMT16-MM, MF, ML, MA

How to clamp

- Alternate the two types of chip breakers when clamping an insert.

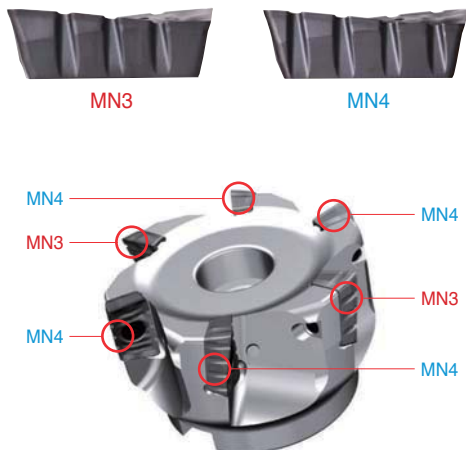

Min. depth of cut

- The depth of cut must be greater than ap_{min1} for chip breaking.

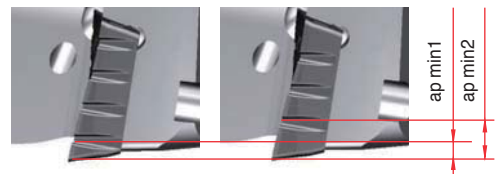

Type	ap_{min1}	ap_{min2}
APMT11 (2000 type)	1.6 mm	4.1 mm
APMT16 (3000 type)	2.2 mm	5 mm
APMT18 (4000 type)	2.3 mm	5.5 mm



Application examples

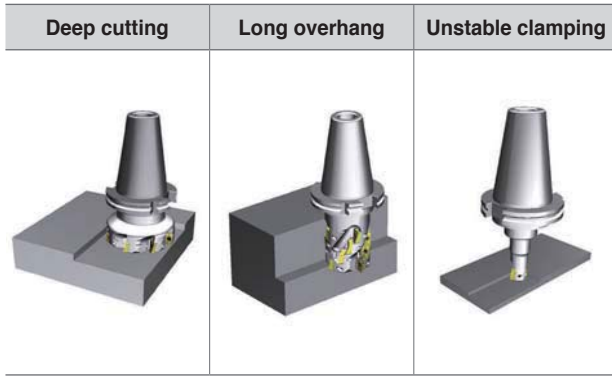

Application area

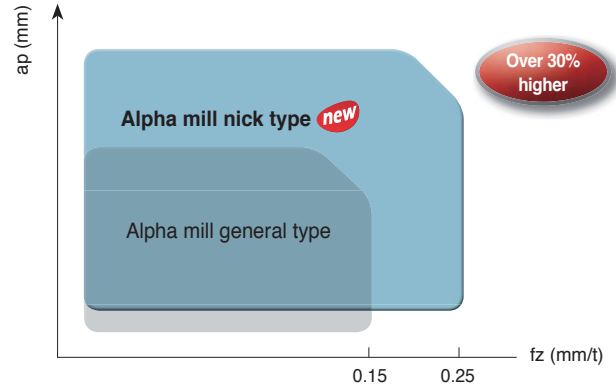

• 30% or higher cutting conditions available compared to normal types

Recommended cutting condition

ISO	Grades	APMT 2000 type			APMT 3000 type			APMT 4000 type		
		vc (m/min)	fz (mm/t)	ap (mm)	vc (m/min)	fz (mm/t)	ap (mm)	vc (m/min)	fz (mm/t)	ap (mm)
P	PC3700	180~280	0.05~0.15	11	160~270	0.05~0.18	16	160~270	0.05~0.18	17
	PC5300	150~250	0.05~0.15		150~240	0.05~0.18		150~240	0.05~0.18	
M	PC5300	90~170	0.05~0.15		90~150	0.05~0.18		90~150	0.05~0.18	
K	PC5300	120~240	0.1~0.2		120~200	0.1~0.23		120~200	0.1~0.23	

※ Above cutting conditions can be applied up to cutting speed of 300 m/min and feed per tooth of 0.4 mm/t.

Features of chip breakers

Insert	Cutting-edge	Uses	Features
MA		Al	Optimal cutting-edge and buffed surface for aluminum workpieces ensure high performance in machining
ML		Hard-to-cut material	Chip breaker with low cutting load is optimal for machining hard-to-cut materials
MF		Light cutting	Chip breaker with low cutting load and harder cutting-edge than ML's are optimal for light cutting
MM		General cutting	Optimal for milling in general ranges
MN		Roughing (nick)	Design for easy chip cutting ensures high machinability in toughing

Product constitution

Item description	Type	Nose R	MA	ML	
APMT	1000Type	0.4	APMT0602PDFR-MA	-	
		0.8	APMT060208PDFR-MA	-	
	1500Type	0.4	APMT0903PDFR-MA	APMT0903PDER-ML	
		0.8	APMT090308PDFR-MA	APMT090308PDER-ML	
	2000Type	0.5	APMT11T3PDFR-MA	APMT11T3PDER-ML	
		0.8	APMT11T308PDFR-MA	APMT11T308PDER-ML	
	3000Type	0.4	APMT160404PDFR-MA	APMT160404PDER-ML	
		0.8	APMT1604PDFR-MA	APMT1604PDER-ML	
	4000Type	0.4	APMT180604PDFR-MA	APMT180604PDER-ML	
		0.8	APMT1806PDFR-MA	APMT1806PDER-ML	
		1.2	APMT180612PDFR-MA	APMT180612PDER-ML	
		1.6	APMT180616PDFR-MA	APMT180616PDER-ML	
		2.0	APMT180620PDFR-MA	APMT180620PDER-ML	
		2.4	APMT180624PDFR-MA	APMT180624PDER-ML	
			3.0	APMT180630R-MA	APMT180630R-ML

- The inserts can switch to the APMT type holders.

Recommended grades and chip breakers by workpiece

Chip breaker	Cutter edge	Recommended C/B and grade as per workpiece (●: 1st)											
		P		M		K		N		S			
		Low carbon steel/Mild steel	High carbon steel/Mild steel	Stainless steel	Cast iron	Aluminum alloy	Ti/Inconel						
		C/B	Grades	C/B	Grades	C/B	Grades	C/B	Grades	C/B	Grades	C/B	Grades
MA		-	-	-	-	-	-	-	-	●	● H01	-	-
ML		-	-	-	-	●	● PC5300 ○ PC5400 ○ PC3545 ○ PC9530	-	-	-	-	●	● PC5300 ○ PC5400 ○ PC3545
MF		●	● PC3700 ○ PC5300 ○ PC5400 ○ NCM325 ○ NCM335	-	○ PC3700 ○ PC3545 ○ NCM325 ○ NCM335	-	● PC5300 ○ PC5400 ○ PC3545 ○ PC9530	-	● PC6510 ○ PC5300 ○ PC5400	-	-	-	● PC5300 ○ PC5400 ○ PC3545
MM		-	● PC3700 ○ PC5300 ○ PC5400 ○ NCM325 ○ NCM335	●	● PC3700 ○ PC5300 ○ PC5400 ○ NCM325 ○ NCM335	-	● PC5300 ○ PC5400 ○ PC3545 ○ PC9530	●	● PC6510 ○ PC5300 ○ PC5400	-	-	-	● PC5300 ○ PC5400 ○ PC3545
MN		-	● PC3500 ○ PC5300 ○ PC5400	-	-	-	● PC5300 ○ PC5400 ○ PC9530	-	● PC6510 ○ PC5300 ○ PC5400	-	-	-	● PC5300 ○ PC5400 ○ PC3545



➤ Recommended depth of cut

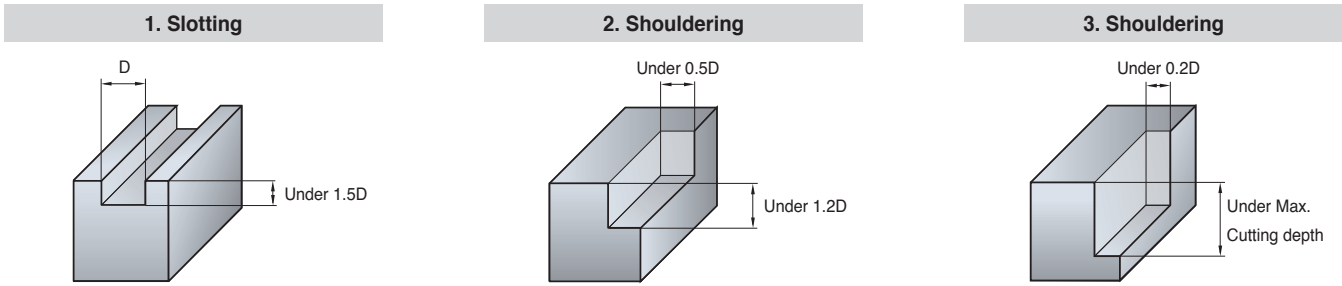

➤ Recommended cutting condition (for Multi-edge type)

Workpiece	Grades	Fig.	Tool dia.									
			Ø10, 16		Ø20, 25		Ø32, 40		Ø50, 63		Ø80, 100	
			vc (m/min)	fz (mm/t)	vc (m/min)	fz (mm/t)	vc (m/min)	fz (mm/t)	vc (m/min)	fz (mm/t)	vc (m/min)	fz (mm/t)
Mild steel, Low carbon steel	NC5340 NCM325 PC5400 PC5300 PC3500 PC3600	①	50~80	0.05~0.08	80~100	0.05~0.08	100~120	0.05~0.08	100~120	0.05~0.08	100~120	0.05~0.08
		②	65~90	0.08~0.1	100~120	0.08~0.1	120~140	0.08~0.1	120~140	0.08~0.1	120~140	0.08~0.1
		③	65~95	0.1~0.15	100~120	0.1~0.15	120~140	0.1~0.15	120~140	0.1~0.15	130~150	0.1~0.15
High carbon steel, Alloy steel	NC5340 NCM325 PC5300 PC3500 PC3600	①	45~60	0.05	60~80	0.05	80~100	0.05	80~100	0.05	80~100	0.05
		②	50~80	0.05~0.08	80~100	0.05~0.08	100~120	0.08~0.1	100~120	0.08~0.1	100~120	0.08~0.1
		③	50~80	0.1~0.15	80~100	0.1~0.15	110~130	0.1~0.15	100~120	0.1~0.15	110~130	0.1~0.15
Alloy tool steel	PC5300 PC3500 PC3600 PC2510 PC2505	①	40~55	0.05	50~70	0.05	70~90	0.05	70~90	0.05	70~90	0.05
		②	45~60	0.05~0.08	60~80	0.05~0.08	90~120	0.05~0.08	100~120	0.05~0.08	100~120	0.05~0.08
		③	50~75	0.12~0.18	90~110	0.12~0.18	100~130	0.1~0.15	100~120	0.1~0.15	110~130	0.1~0.15
Stainless steel	PC5300 PC9530	①	35~50	0.054	50~70	0.054	70~90	0.05	70~90	0.05	70~90	0.05
		②	45~60	0.05~0.08	60~80	0.05~0.08	90~120	0.05~0.08	100~120	0.05~0.08	100~120	0.05~0.08
		③	50~75	0.1~0.15	90~110	0.1~0.15	100~130	0.1~0.15	110~130	0.1~0.15	110~130	0.1~0.15
Cast iron	PC6510 PC5300	①	50~70	0.1~0.12	70~90	0.1~0.12	70~90	0.1~0.12	90~120	0.1~0.12	90~120	0.1~0.12
		②	50~80	0.12	80~100	0.12	90~120	0.12	100~140	0.12	100~140	0.12
		③	50~80	0.15~0.2	80~100	0.15~0.2	100~130	0.15~0.2	120~150	0.15~0.2	120~150	0.15~0.2
Aluminum alloy	H01	①	160~600	0.1~0.2	200~800	0.1~0.2	300~900	0.1~0.2	400~1,000	0.1~0.2	400~1,000	0.1~0.2
		②	200~650	0.15~0.3	250~900	0.15~0.3	300~950	0.15~0.3	400~1,000	0.1~0.4	400~1,000	0.1~0.4
		③	200~650	0.15~0.3	250~900	0.15~0.3	300~950	0.15~0.3	400~1,000	0.1~0.4	400~1,000	0.1~0.4
Hardened steel	PC5300 PC2510 PC2505	①	35~50	0.03	50~70	0.03	60~90	0.03	60~90	0.03	60~90	0.03
		②	45~60	0.05~0.08	60~80	0.05~0.08	80~100	0.05~0.08	80~100	0.05~0.08	80~100	0.05~0.08
		③	50~80	0.05~0.08	80~100	0.05~0.08	80~100	0.05~0.08	80~100	0.05~0.08	80~100	0.05~0.08

➤ Recommended cutting condition (for Single-edge type)

Workpiece	Grades	Fig.	Tool dia.									
			Ø10, 16		Ø20, 25		Ø32, 40		Ø50, 63		Ø80, 100	
			vc (m/min)	fz (mm/t)	vc (m/min)	fz (mm/t)	vc (m/min)	fz (mm/t)	vc (m/min)	fz (mm/t)	vc (m/min)	fz (mm/t)
Mild steel, low carbon steel	NC5340 NCM325 PC5400 PC5300 PC3500 PC3600	①	45~60	0.05~0.08	60~80	0.05~0.08	80~120	0.05~0.08	120~200	0.05~0.08	150~200	0.05~0.08
		②	60~90	0.08~0.1	80~120	0.08~0.1	120~180	0.08~0.1	180~250	0.08~0.1	200~250	0.08~0.1
		③	60~90	0.1~0.15	80~120	0.1~0.15	120~180	0.1~0.15	180~250	0.1~0.15	200~250	0.1~0.15
High carbon steel, alloy steel	NC5340 NCM325 PC5300 PC3500 PC3600	①	40~60	0.05	50~80	0.05	80~110	0.05	100~150	0.05	100~150	0.05
		②	50~80	0.05~0.08	80~100	0.05~0.08	110~150	0.05~0.1	150~200	0.05~0.1	150~200	0.05~0.1
		③	50~80	0.1~0.15	80~100	0.1~0.15	120~150	0.1~0.15	180~200	0.1~0.15	180~200	0.1~0.15
Alloy tool steel	PC5300 PC3500 PC3600 PC2510 PC2505	①	35~50	0.05	50~70	0.05	80~100	0.05	100~130	0.05	100~130	0.05
		②	45~70	0.05~0.08	70~100	0.05~0.08	100~130	0.05~0.1	130~180	0.05~0.1	130~180	0.05~0.1
		③	45~70	0.1~0.15	70~100	0.1~0.15	100~150	0.1~0.15	130~180	0.1~0.15	130~180	0.1~0.15
Stainless steel	PC5300 PC9530	①	35~50	0.05	50~70	0.05	80~100	0.05	100~130	0.05	100~130	0.05
		②	45~70	0.05~0.08	70~100	0.05~0.08	100~130	0.05~0.1	130~180	0.05~0.1	130~180	0.05~0.1
		③	45~70	0.1~0.15	70~100	0.1~0.15	100~150	0.1~0.15	130~180	0.1~0.15	130~180	0.1~0.15
Cast iron	PC6510 PC5300	①	50~80	0.08~0.12	80~100	0.08~0.12	80~100	0.15	120~150	0.15	120~150	0.15
		②	65~90	0.12~0.15	100~120	0.12~0.15	100~130	0.15~0.18	150~200	0.15~0.18	150~200	0.15~0.18
		③	65~90	0.15~0.2	100~120	0.15~0.2	100~130	0.15~0.2	150~200	0.15~0.2	150~200	0.15~0.2
Aluminum alloy	H01	①	200~600	0.15~0.2	250~800	0.15~0.2	300~900	0.15~0.2	400~1,000	0.1~0.2	400~1,000	0.1~0.2
		②	200~650	0.2~0.25	250~900	0.2~0.25	350~950	0.2~0.25	400~1,000	0.2~0.3	400~1,000	0.2~0.3
		③	200~650	0.25~0.3	250~900	0.25~0.3	350~950	0.25~0.3	400~1,000	0.3~0.4	400~1,000	0.3~0.4
Hardened steel	PC5300 PC2510 PC2505	①	35~50	0.03	50~70	0.03	60~90	0.03	60~90	0.03	60~90	0.03
		②	45~65	0.05~0.08	60~80	0.05~0.08	80~100	0.05~0.08	80~100	0.05~0.08	80~100	0.05~0.08
		③	50~80	0.05~0.08	80~100	0.05~0.08	80~100	0.05~0.08	80~100	0.05~0.08	80~100	0.05~0.08



➤ Cutting condition for ramping and helical operation

1. Ramping

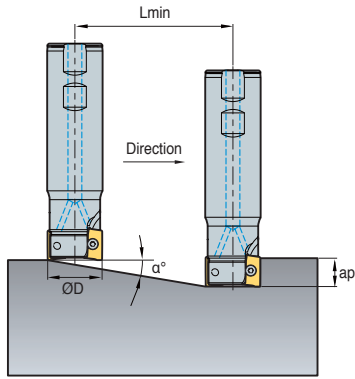

2. Helical cutting for blind hole

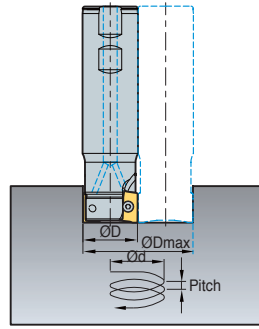

3. Helical cutting for through hole

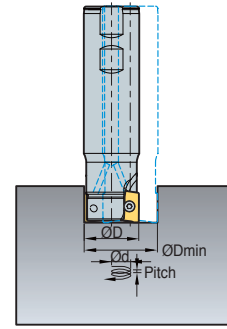

(mm)

Designation	Tool dia. ØD (min)	ap	1. Ramping		2. Helical cutting for blind hole				3. Helical cutting for through hole	
			Maximum angle α(°)	Lmin (mm)	Max. desirable hole dia. ØDH Max (mm)	Max. pitch dmax (mm)	Min. desirable hole dia. ØDH Min (mm)	Max. pitch dmax (mm)	Min. desirable hole dia. ØDH Min (mm)	Max. pitch dmax (mm)
AMS1010HS	10	5	6.5	44	17.6	2.0	18.8	2.1	13	1.5
AMS1011HS	11		5.6	51	19.6	1.9	20.8	2.0	15	1.5
AMS1012HS	12		4.9	58	21.6	1.9	22.8	2.0	17	1.5
AMS1014HS	14		3.9	73	25.6	1.8	26.8	1.8	21	1.4
AMS1015HS	15		3.6	80	27.6	1.7	28.8	1.8	23	1.4
AMS1016HS	16		3.3	87	29.6	1.7	30.8	1.8	25	1.4
AMS1017HS	17		3.0	94	31.6	1.7	32.8	1.7	27	1.4
AMS1018HS	18		2.8	101	33.6	1.7	34.8	1.7	29	1.4
AMS1020HS	20		2.5	115	37.6	1.6	38.8	1.7	33	1.4
AMS1021HS	21		2.3	123	39.6	1.6	40.8	1.7	35	1.4
AMS1022HS	22		2.2	130	41.6	1.6	42.8	1.6	37	1.4
AMS1025HS	25		1.9	151	47.6	1.6	48.8	1.6	43	1.4
AMS1026HS	26		1.8	158	49.6	1.6	50.8	1.6	45	1.4
AMS1032HS	32		1.4	201	61.6	1.5	62.8	1.6	57	1.4
AMS1033HS	33		1.4	208	63.6	1.5	64.8	1.6	59	1.4
AMCM1032HS	32		1.4	201	61.6	1.5	62.8	1.6	57	1.4
AMCM1040HS	40		1.1	258	77.6	1.5	78.8	1.5	73	1.4
AMCM1050HS	50		0.9	330	97.6	1.5	98.8	1.5	93	1.4
AMCM1063HS	63		0.7	423	123.6	1.5	124.8	1.5	119	1.4
AMS1510HS	10		9	7.5	68	17.4	2.3	18.8	2.5	11
AMS1512HS	12	6.5		79	21.4	2.4	22.8	2.6	15	1.7
AMS1513HS	13	5.7		90	23.4	2.3	24.8	2.5	17	1.7
AMS1514HS	14	6.3		82	25.4	2.8	26.8	2.9	19	2.1
AMS1516HS	16	5.0		102	29.4	2.6	30.8	2.7	23	2.0
AMS1517HS	17	4.6		112	31.4	2.5	32.8	2.6	25	2.0
AMS1518HS	18	4.2		122	33.4	2.5	34.8	2.6	27	2.0
AMS1519HS	19	3.9		132	35.4	2.4	36.8	2.5	29	2.0
AMS1520HS	20	3.6		142	37.4	2.4	38.8	2.5	31	2.0
AMS1521HS	21	3.4		152	39.4	2.3	40.8	2.4	33	2.0
AMS1522HS	22	3.2		162	41.4	2.3	42.8	2.4	35	1.9
AMS1524HS	24	2.8		182	45.4	2.2	46.8	2.3	39	1.9
AMS1525HS	25	2.7		192	47.4	2.2	48.8	2.3	41	1.9
AMS1528HS	28	2.3		222	53.4	2.2	54.8	2.2	47	1.9
AMS1530HS	30	2.1		242	57.4	2.1	58.8	2.2	51	1.9
AMS1532HS	32	2.0		262	61.4	2.1	62.8	2.2	55	1.9
AMS1535HS	35	1.8		292	67.4	2.1	68.8	2.1	61	1.9
AMS1540HS	40	1.5		342	77.4	2.0	78.8	2.1	71	1.9
AMCM15040HS	40	1.5		342	77.4	2.0	78.8	2.1	71	1.9
AMCM15050HS	50	1.2		442	97.4	2.0	98.8	2.0	91	1.9
AMCM15063HS	63	0.9		572	123.4	1.9	124.8	2.0	117	1.8
AMCM15080HS	80	0.7		742	157.4	1.9	158.8	1.9	151	1.8
AMCM15100HS	100	0.5		942	197.4	1.9	198.8	1.9	191	1.8

$$Lmin = \frac{ap}{\tan \alpha^\circ} \text{ (mm)}$$



Cutting condition for ramping and helical operation

1. Ramping

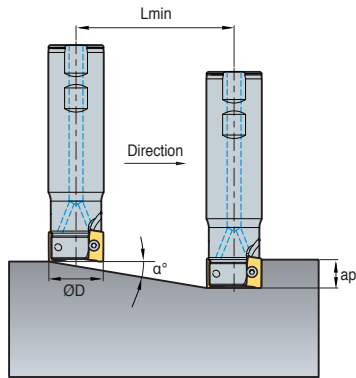

2. Helical cutting for blind hole

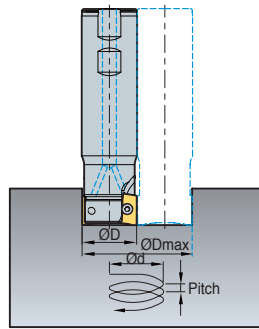

3. Helical cutting for through hole

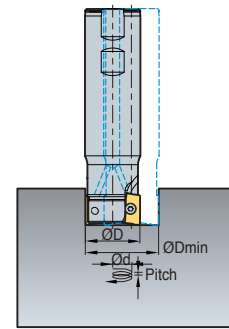

(mm)

Designation	Tool dia. ØD (min)	ap	1. Ramping		2. Helical cutting for blind hole				3. Helical cutting for through hole		
			Maximum angle α(°)	Lmin (mm)	Max. desirable hole dia. ØDH Max (mm)	Max. pitch dmax (mm)	Min. desirable hole dia. ØDH Min (mm)	Max. pitch dmax (mm)	Min. desirable hole dia. ØDH Min (mm)	Max. pitch dmax (mm)	
AMS2010HS	10	10	16.82	33	16.4	5.0	18	5.4	11	3.3	
AMS2012HS	12		11.69	48	20.4	4.2	22	4.6	15	3.1	
AMS2014HS	14		7.55	75	24.4	3.2	26	3.4	19	2.5	
AMS2016HS	16		10.30	55	28	5.1	30	5.5	23	4.2	
AMS2018HS	18		8.23	69	32	4.6	34	4.9	27	3.9	
AMS2020HS	20		5.60	102	36	3.5	38	3.7	31	3.0	
AMS2022HS	22		5.15	111	40	3.6	42	3.8	35	3.2	
AMS2025HS	25		3.92	146	46	3.2	48	3.3	41	2.8	
AMS2032HS	32		2.70	212	60	2.8	62	2.9	55	2.6	
AMS2040HS	40		1.98	289	76	2.6	78	2.7	71	2.5	
AMS2050HS	50		1.48	386	96	2.5	98	2.5	91	2.4	
AMS2063HS	63		1.11	514	122	2.4	124	2.4	117	2.3	
AMCM2040HS	40		1.29	445	76	2.5	78	2.6	71	2.1	
AMCM2050HS	50		0.36	1576	96	0.6	98	0.6	91	0.6	
AMCM2063HS	63		0.27	2104	122	0.6	124	0.6	117	0.6	
AMCM2080HS	80		0.21	2784	156	0.6	158	0.6	151	0.5	
AMCM2100HS	100		0.16	3584	196	0.5	198	0.6	191	0.5	
AMS3025HS	25		10	4.72	121	46	3.8	48	4.0	36	3.0
AMS3032HS	32			3.00	191	60	3.1	62	3.2	50	2.6
AMS3040HS	40			2.29	250	76	3.0	78	3.1	66	2.6
AMS3050HS	50	1.64		350	96	2.7	98	2.8	86	2.5	
AMS3063HS	63	1.22		470	122	2.6	124	2.6	112	2.4	
AMCM3040HS	40	1.99		288	76	2.6	78	2.7	66	2.3	
AMCM3050HS	50	1.67		343	96	2.8	98	2.9	86	2.5	
AMCM3063HS	63	1.22		470	122	2.6	124	2.6	112	2.4	
AMCM3080HS	80	0.90		636	156	2.5	158	2.5	146	2.3	
AMCM3100HS	100	0.69		830	196	2.4	198	2.4	186	2.2	
AMS2025MH	25	10	1.50	764	46	1.2	48	1.3	-	-	
AMS2032MH	32		1.50	1146	60	1.6	62	1.6	-	-	
AMS3040MH	40	16	1.50	1528	76	2.0	78	2.0	-	-	
AMS4020HS	20	16	9.5	98	37.4	6.2	38.8	6.5	31	5.2	
AMS4021HS	21		5.2	179	39.4	3.6	40.8	3.7	33	3.0	
AMS4025HS	25		7.6	122	47.4	6.3	48.8	6.5	41	5.5	
AMS4026HS	26		7.1	130	49.4	6.2	50.8	6.4	43	5.4	
AMS4032HS	32		3.4	276	61.4	3.6	62.8	3.7	55	3.3	
AMS4033HS	33		3.2	288	63.4	3.6	64.8	3.7	57	3.2	
AMS4040HS	40		2.5	376	77.4	3.4	78.8	3.4	71	3.1	
AMS4050HS	50		1.9	502	97.4	3.2	98.8	3.2	91	3.0	
AMS4063HS	63		1.4	665	123.4	3.0	124.8	3.1	117	2.9	
AMCM4050HS	50		1.9	502	97.4	3.2	98.8	3.2	91	3.0	
AMCM4063HS	63		1.4	665	123.4	3.0	124.8	3.1	117	2.9	
AMCM4080HS	80		1.1	878	157.4	2.9	158.8	2.9	151	2.8	
AMCM4100HS	100		0.8	1128	197.4	2.9	198.8	2.9	191	2.8	
AMCM4125HS	125		0.6	1442	247.4	2.8	248.8	2.8	241	2.7	

$$Lmin = \frac{ap}{\tan \alpha} \text{ (mm)}$$



AMC(M)1000S

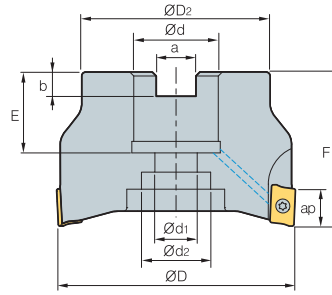
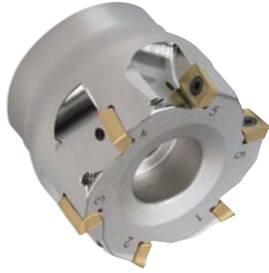

AA
90°
• AR: 9°~13°
• RR: -14°~5°

(mm)

Designation		ØD	ØD2	Ød	Ød1	Ød2	a	b	E	F	ap		
AMCM	1032HS	8	32	30	16	9	14	8.4	5.6	19	40	5.6	0.15
	1040HS-16	10	40	34	16	9	14	8.4	5.6	19	40	5.6	0.24
	1040HS-22	10	40	34	22	11	18	10.4	6.3	21	40	5.6	0.24
	1050HS	12	50	42	22	11	18	10.4	6.3	21	40	5.6	0.36
	1063HS	14	63	49	22	11	18	10.4	6.3	21	40	5.6	0.61

Available inserts

APMT-MA APMT-MM



Designation	Cermet		Coated										Uncoated		page			
	CN2000	CN30	NCM325	NC5330	NCM535	NCM545	PC2505	PC2510	PC3600	PC3700	PC6510	PC9530	PC9540	PC5300		PC5400	G10	H01
APMT 0602PDFR-MA																		●
060208PDFR-MA																		
060202PDSR-MM				●														
0602PDSR-MM				●			●	●	●	●	●	●		●	●			
060208PDSR-MM				●				●	●					●	●			
060212R-MM				●				●						●	●			

Available arbors

Designation	Ød	NC arbors
AMCM 1032HS	16	BT□□-FMC16-□□
1040HS-16		
1040HS-22		
1050HS	22	BT□□-FMC22-□□
1063HS		

Parts

Specification		
Ø32~Ø63	FTKA01842	TW06S-A

Available inserts E05 Available arbors and bolt E400~E402



AMC(M)1500S

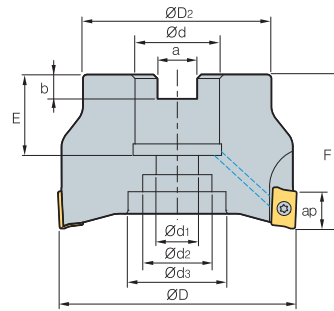

AA 90°
 • AR: 9°~13°
 • RR: -14°~5°

(mm)

Designation		ØD	ØD2	Ød	Ød1	Ød2	Ød3	a	b	E	F	ap		
AMCM	15040HS	5	40	34	16	9	14	-	8.4	5.6	19	40	9	0.22
	15050HS	6	50	42	22	11	18	-	10.4	6.3	21	40	9	0.34
	15063HS	8	63	49	22	11	18	-	10.4	6.3	21	40	9	0.57
AMC (AMCM)	15080HS	10	80	57	25.4 (27)	14	25	35	9.5 (12.4)	6 (7)	24 (23)	50	9	1.10
	15100HS	12	100	67	31.75 (32)	18	26	42	12.7 (14.4)	8 (8)	32 (26)	63	9	2.10

() Metric size

Available inserts

APMT-MA APMT-ML APMT-MM



Designation	Cermet		Coated											Uncoated		page			
	CN2000	CN30	NCM325	NC5330	NCM635	NCM645	PC2505	PC2510	PC3600	PC3700	PC6510	PC9530	PC9540	PC5300	PC5400		G10	H01	
APMT 0903PDFR-MA																		●	E05
090308PDFR-MA																			
0903PDER-ML														●	●				
090308PDER-ML														●	●				
0903PDSR-MM				●			●	●	●	●	●			●	●				
090308PDSR-MM				●					●	●				●	●				
090312R-MM									●	●				●	●				
090316R-MM				●					●	●				●	●				
090320R-MM									●	●				●	●				

Available arbors

Designation	Ød	NC arbors
AMCM 15040HS	16	BT□□-FMC16-□□
15050HS	22	BT□□-FMC22-□□
15063HS		
AMC (AMCM) 15080HS	25.4	BT□□-FMA25.4-□□
	27	BT□□-FMC27-□□
15100HS	31.75	BT□□-FMA31.75-□□
	32	BT□□-FMC32-□□

Parts

Specification		
Ø40~Ø100	FTKA02565S	TW08S

Available inserts E05 Available arbors and bolt E400~E402

AMC(M)2000S

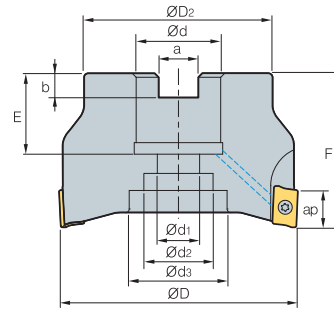
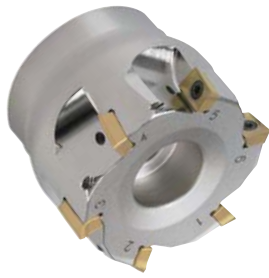

AA
90°
• AR: 9°~13°
• RR: -14°~5°

(mm)

Designation	⊘	ØD	ØD2	Ød	Ød1	Ød2	Ød3	a	b	E	F	ap	kg	
AMCM	2040HS	5	40	34	16	9	14	-	8.4	5.6	18	40	11	0.22
	2050HS	6	50	42	22	11	18	-	10.4	6.3	20	40	11	0.34
	2063HS	8	63	49	22	11	18	-	10.4	6.3	20	40	11	0.57
AMC (AMCM)	2080HS	8	80	57	25.4 (27)	14	25	35	9.5 (12.4)	6 (7)	25 (22)	50	11	1.10
	2100HS	10	100	67	31.75 (32)	18	26	42	12.7 (14.4)	8 (8)	32 (28)	63	11	2.10

() Metric size

Available inserts



Designation	Cermet		Coated										Uncoated		page			
	CN2000	CN30	NCM325	NC5330	NCM535	NCM545	PC2505	PC2510	PC3600	PC3700	PC6510	PC9530	PC9540	PC5300		PC5400	G10	H01
APMT	11T3PDFR-MA																●	E05
	11T308PDFR-MA																	
	11T3PDER-ML												●	●				
	11T308PDER-ML												●	●				
	11T3PDSR-MM			●	●	●		●	●	●	●	●	●	●	●			
	11T3PDSR-MF			●				●	●	●			●	●	●			
	11T308PDSR-MM			●				●	●	●		●	●	●	●			
	11T312PDSR-MM			●				●	●		●		●	●	●			
	11T316R-MM			●				●	●				●	●				
	11T318R-MM			●				●	●				●	●				
	11T324R-MM			●				●	●				●	●				
	11T3PDSR-MN2												●	●				
	11T3PDSR-MN3												●	●				

* Please purchase 2 types of APMT-MN (nick type) inserts with different chip breakers. * Please use the cutters with even teeth.

Available arbors

Designation	Ød	NC arbors
AMCM	2040HS	BT□□-FMC16-□□
	2050HS	
	2063HS	BT□□-FMC22-□□
AMC (AMCM)	2080HS	BT□□-FMA25.4-□□
		BT□□-FMC27-□□
		BT□□-FMA31.75-□□
	2100HS	BT□□-FMC32-□□

Parts

Specification	Screw	Wrench
Ø40~Ø100	FTKA02565S	TW08S

Available inserts E05 Available arbors and bolt E400~E402



AMC(M)3000S

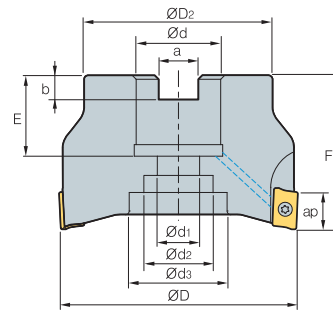
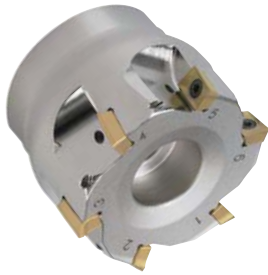

AA 90°
• AR: 14°
• RR: -12°~8°

(mm)

Designation		ØD	ØD2	Ød	Ød1	Ød2	Ød3	a	b	E	F	ap		
AMCM	3040HS	4	40	34	16	9	14	-	8.4	5.6	18	40	16	0.18
	3050HS	5	50	42	22	11	18	-	10.4	6.3	20	40	16	0.28
	3063HS	6	63	49	22	11	18	-	10.4	6.3	20	40	16	0.50
AMC (AMCM)	3080HS	7	80	57	25.4 (27)	14	25	35	9.5 (12.4)	6 (7)	25 (22)	50	16	1.02
	3100HS	8	100	67	31.75 (32)	18	26	42	12.7 (14.4)	8 (8)	32 (28)	63	16	2.05

() Metric size

Available inserts

APMT-MA APMT-ML APMT-MM APMT-MF APMT-MN



Designation	Cermet		Coated											Uncoated		page		
	CN2000	CN30	NCM325	NC5330	NCM535	NCM545	PC2505	PC2510	PC3600	PC3700	PC6510	PC9530	PC9540	PC5300	PC5400		G10	H01
APMT 1604PDFR-MA																		●
160404PDFR-MA																		
1604PDER-ML																		
160404PDER-ML																		
1604PDSR-MM			●	●	●		●	●	●	●	●	●	●	●	●			
1604PDSR-MF				●				●	●	●				●	●			
160410PDSR-MM								●						●	●			
160416PDSR-MM				●				●	●					●	●			
160424R-MM				●				●	●					●	●			
160430R-MM								●	●					●	●			
160432R-MM				●				●	●					●	●			
1604PDSR-MN3														●				
1604PDSR-MN4														●				

※ Please purchase 2 types of APMT-MN (nick type) inserts with different chip breakers. ※ Please use the cutters with even teeth.

Available arbors

Designation	Ød	NC arbors
AMCM 3040HS	16	BT□□-FMC16-□□
3050HS	22	BT□□-FMC22-□□
3063HS		
AMC (AMCM) 3080HS	25.4	BT□□-FMA25.4-□□
	27	BT□□-FMC27-□□
	31.75	BT□□-FMA31.75-□□
3100HS	32	BT□□-FMA32-□□

Parts

Specification		
Ø40~Ø100	FTKA0410	TW15S

Available inserts E05 Available arbors and bolt E400~E402

AMC(M)3000S-K

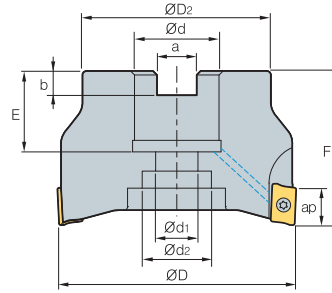
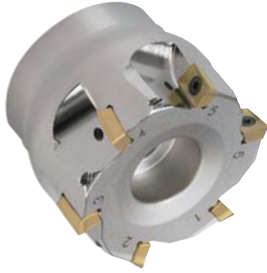

• AR: 14°
• RR: -12°~8°

(mm)

Designation	ØD	ØD2	Ød	Ød1	Ød2	a	b	E	F	ap	$\frac{m}{kg}$
AMCM 3040HS-K	40	34	16	9	14	8.4	5.6	18	40	16	0.15
3050HS-K	50	42	22	11	18	10.4	6.3	20	40	16	0.24
3063HS-K	63	49	22	11	18	10.4	6.3	20	40	16	0.24
AMC 3080HS-K	80	57	25.4 (27)	14	20	9.5 (12.4)	6 (7)	25 (22)	50	16	0.36
(AMCM) 3100HS-K	100	67	31.75 (32)	18	26	12.7 (14.4)	8 (8)	32 (28)	63	16	0.61

() Metric size

Available inserts



Designation	Cermet		Coated										Uncoated			page			
	CN2000	CN30	NCM325	NCM335	NCM535	NCM545	PC2505	PC2510	PC3700	PC6510	PC9530	PC9540	PC5300	PC5400	PD2000		G10	H01	H05
APKT 1604PDSR			●						●	●									
1604PDSR-MF			●										●						
1604PDSR-MM			●	●					●	●	●		●						
160432R-MM1																			
1604PDFR-MA														●			●	●	
1604PDFR-MA2																	●		
160416FR-MA2																			
160432FR-MA2																			
1604PDFR-MA3																	●	●	
160420FR-MA3																			

E05

Available arbors

Designation	Ød	NC arbors
AMCM 3040HS-K	16	BT□□-FMC16-□□
3050HS-K	22	BT□□-FMC22-□□
3063HS-K		
AMC 3080HS-K	25.4	BT□□-FMA25.4-□□
(AMCM)	27	BT□□-FMC27-□□
	31.75	BT□□-FMA31.75-□□
3100HS-K	32	BT□□-FMC32-□□

Parts

Specification	Screw	Wrench
Ø40~Ø100	FTKA0410	TW15S

Available inserts E05 Available arbors and bolt E400~E402



AMC(M)4000S

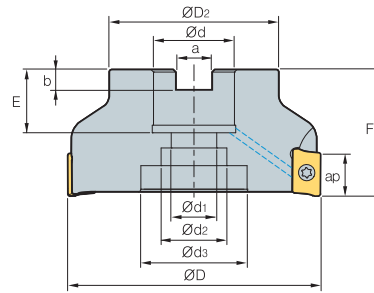

• AR: 13°~15°
• RR: -12°~7°

(mm)

Designation	⊙	ØD	ØD2	Ød	Ød1	Ød2	Ød3	a	b	E	F	ap	kg
AMCM 4050HS	5	50	42	22	11	18	-	10.4	6.3	21	40	17	0.28
4063HS	6	63	49	22	11	18	-	10.4	6.3	21	40	17	0.50
AMC (AMCM) 4080HS	7	80	57	25.4 (27)	14	25	35	9.5(12.4)	6(7)	24(23)	50	17	1.00
4100HS	8	100	67	31.75(32)	18	26	42	12.7(14.4)	8(9)	32(25)	63(50)	17	2.10
4125HS	9	125	87	38.1(40)	22	32	52	15.9(16.4)	10(9)	35(29)	63	17	3.30
4160S	10	160	107	50.8(40)	-	-	100	19(16.4)	11(9)	38(32)	63	17	3.6
4200S	10	200	108	47.625(60)	-	-	132	25.4(25.7)	14(14)	40(38)	63	17	6

() Metric size

Available inserts



Designation	Cement										page	Designation	Cement										page													
	CN2000	CN30	NCM325	NC5330	NCM535	NCM545	PC2505	PC2010	PC3600	PC3700			PC6510	PC9530	PC9540	PC5300	PC5400	G10	H01	Designation	CN2000	CN30		NCM325	NC5330	NCM535	NCM545	PC2505	PC2010	PC3600	PC3700	PC6510	PC9530	PC9540	PC5300	PC5400
APMT 1806PDR-MA												●	APMT 180624PDR-ML																						●	
180604PDR-MA												●	180630R-ML																						●	
180612PDR-MA												●	1806PDR-MM																							●
180616PDR-MA												●	1806PDR-MF																							●
180620PDR-MA												●	180612PDR-MM																							●
180624PDR-MA												●	180616PDR-MM																							●
180630R-MA												●	180620PDR-MM																							●
1806PDR-ML												●	180624PDR-MM																							●
180604PDR-ML												●	180630R-MM																							●
180612PDR-ML												●	180632R-MM																							●
180616PDR-ML												●	1806PDR-MN3																							●
180620PDR-ML												●	1806PDR-MN4																							●

※ Please purchase 2 types of APMT-MN (nick type) inserts with different chip breakers. ※ Please use the cutters with even teeth.

Available arbors

Designation	Ød	NC arbors	Designation	Ød	NC arbors
AMCM 4050HS	22	BT□□-FMC22-□□	AMC (AMCM) 4125HS	38.1	BT□□-FMA38.1-□□
4063HS		BT□□-FMA25.4-□□			
AMC (AMCM) 4080HS	25.4	BT□□-FMC27-□□	4160S	50.8	BT□□-FMA50.8-□□
4100HS		BT□□-FMA31.75-□□			
	32	BT□□-FMC32-□□	4200S	47.625	BT□□-FMA47.625-□□
					60

Parts

Specification		
Ø50~Ø200	FTKA0410	TW15S

Available inserts **E05** Available arbors and bolt **E400~E402**

AMC(M)1000SE/2000SE

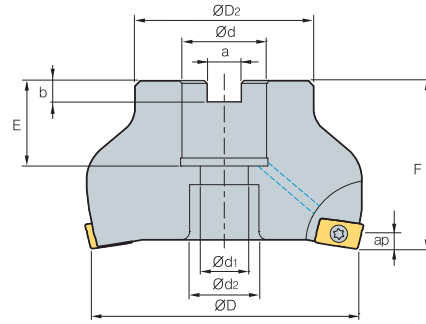
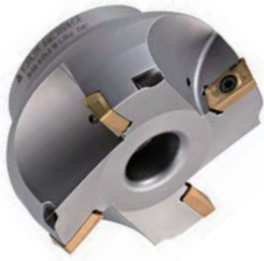

(mm)

Designation	⊙	ØD	ØD2	Ød	Ød1	Ød2	a	b	E	F	ap	$\frac{m}{kg}$
AMCM 1040HSE	4	40	34	16	9	14	8.4	5.6	19	40	2.5	0.26
	5	50	42	22	11	18	10.4	6.3	21	40	2.5	0.39
AMC (AMCM) 2080HSE	5	80	57	25.4 (27)	14	20	9.5 (12.4)	6.0 (7.0)	25 (22)	50	4	1.2
	6	100	67	31.75 (32)	18	26	12.7 (14.4)	8.0 (8.0)	32 (28)	63	4	2.33

() Metric size

Available inserts

APMT-MM APMT-MF



Type	Designation	Cermet		Coated											Uncoated		page	
		CN2000	CN30	NCM325	NC5330	NCM535	NCM545	PC2505	PC2510	PC3600	PC3700	PC6510	PC9530	PC9540	PC5300	PC5400		G10
1000 type	APMT 060202PDSR-MM				●					●					●	●		
	0602PDSR-MM				●			●	●	●	●	●			●	●		
	060208PDSR-MM				●					●	●				●	●		
	060212R-MM				●					●					●	●		
2000 type	APMT 11T3PDSR-MM			●	●	●		●	●	●	●	●			●	●		
	11T3PDSR-MF				●					●	●	●			●	●		
	11T308PDSR-MM				●					●	●		●	●	●	●		
	11T312PDSR-MM				●					●	●		●		●	●		
	11T316R-MM				●					●	●				●	●		
	11T318R-MM				●					●	●				●	●		
	11T324R-MM				●					●	●				●	●		

E05

Available arbors

Type	Designation	Ød	NC arbors
1000 type	AMC (AMCM) 1040HSE	16	BT□□-FMC16-□□
	1050HSE	22	BT□□-FMC22-□□
2000 type	AMC (AMCM) 2080HSE	25.4	BT□□-FMA25.4-□□
		27	BT□□-FMC27-□□
	2100HSE	31.75	BT□□-FMA31.75-□□
		32	BT□□-FMC32-□□

Parts

Specification	Screw	Wrench	Wrench
Ø40~Ø50 (1000 type)	FTKA01842	-	TW06S-A
Ø80~Ø100 (2000 type)	FTKA02565S	TW08S	-

Available inserts E05 Available arbors and bolt E400~E402



AMC(M)3000SE

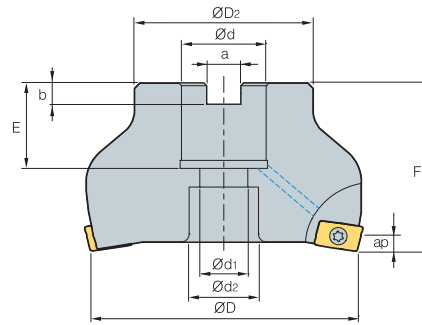
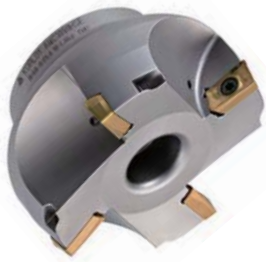

• AR: 45°
• RR: 0°

(mm)

Designation		ØD	ØD2	Ød	Ød1	Ød2	a	b	E	F	ap	
AMC 3080HSE	4	80	57	25.4 (27)	14	20	9.5 (12.4)	6.0 (7.0)	25 (22)	50	6	1.3
(AMCM) 3100HSE	5	100	67	31.75 (32)	18	26	12.7 (14.4)	8.0 (8.0)	32 (28)	63	6	2.3

() Metric size

Available inserts

APMT-MM APMT-MF



Designation	Cermet		Coated											Uncoated		page		
	CN2000	CN30	NCM325	NC5330	NCM535	NCM545	PC2505	PC2510	PC3600	PC3700	PC8510	PC9530	PC9540	PC5300	PC5400		G10	H01
APMT 1604PDSR-MM			●	●	●		●	●	●	●	●	●	●	●	●			E05
1604PDSR-MF				●					●	●	●			●	●			
160410PDSR-MM									●					●	●			
160416PDSR-MM				●					●	●				●	●			
160424R-MM				●					●	●				●	●			
160430R-MM									●	●				●	●			
160432R-MM				●					●	●				●	●			

Available arbors

Designation	Ød	NC arbors
AMC 3080HSE	25.4	BT□□-FMA25.4-□□
	27	BT□□-FMC27-□□
(AMCM) 3100HSE	31.75	BT□□-FMA31.75-□□
	32	BT□□-FMC32-□□

Parts

Specification		
Ø80-Ø100	FTKA0410	TW08S

Available inserts E05 Available arbors and bolt E400~E402

AMC(M)2000M

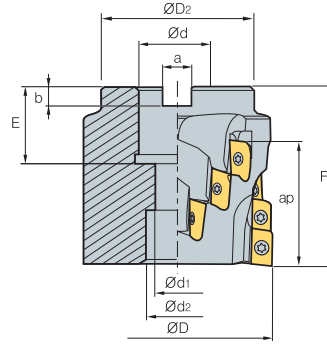

(mm)

Designation	$\varnothing D$	$\varnothing D_2$	$\varnothing d$	$\varnothing d_1$	$\varnothing d_2$	a	b	E	F	No. of flute	ap	kg	
AMCM 2050M	16	50	40	22	11	18	10.4	6.3	21	58	4	39	0.7
AMC (AMCM) 2063M	16	63	50	25.4 (27)	13.5	20	9.5 (12.4)	6 (7)	25 (25)	58	4	39	0.8
2080M	20	80	60	31.75 (32)	-	45	12.7 (14.4)	8 (8)	35 (28)	63	5	39	0.96
2100M	24	100	80	38.1 (40)	-	56	15.9 (16.4)	10 (9)	38 (30)	63	6	39	1.2

() Metric size

Available inserts



Designation	Cermet		Coated											Uncoated		page		
	CN2000	CN30	NCM325	NC5330	NCM535	NCM545	PC2505	PC2510	PC3600	PC3700	PC6510	PC9530	PC9540	PC5300	PC5400		G10	H01
APMT 11T3PDFR-MA																		
11T308PDFR-MA																		
11T3PDER-ML																		
11T308PDER-ML																		
11T3PDSR-MM			●	●	●		●	●	●	●	●	●	●	●	●			
11T3PDSR-MF				●				●	●	●	●			●	●			
11T308PDSR-MM				●				●	●	●	●	●	●	●	●			
11T312PDSR-MM				●				●	●	●	●	●	●	●	●			
11T316R-MM				●				●	●	●	●	●	●	●	●			
11T318R-MM				●				●	●	●	●	●	●	●	●			
11T324R-MM				●				●	●	●	●	●	●	●	●			
11T3PDSR-MN2														●	●			
11T3PDSR-MN3														●	●			

E05

※ Please purchase 2 types of APMT-MN (nick type) inserts with different chip breakers. ※ Please use the cutters with even teeth.

Available arbors

Designation	$\varnothing d$	NC arbors	
AMC (AMCM) 2050M	22.225	BT□□-FMA22.225-□□	BT□□-SMA22.225-□□
	22	BT□□-FMC22-□□	BT□□-SMC22-□□
2063M	25.4	BT□□-FMA25.4-□□	BT□□-SMA25.4-□□
	27	BT□□-FMC27-□□	BT□□-SMC27-□□
2080M	31.75	BT□□-FMA31.75-□□	BT□□-SMA31.75-□□
	32	BT□□-FMC32-□□	BT□□-SMC32-□□
2100M	38.1	BT□□-FMA38.1-□□	BT□□-SMA38.1-□□
	40	BT□□-FMC40-□□	BT□□-SMC40-□□

Caution when clamping the inserts

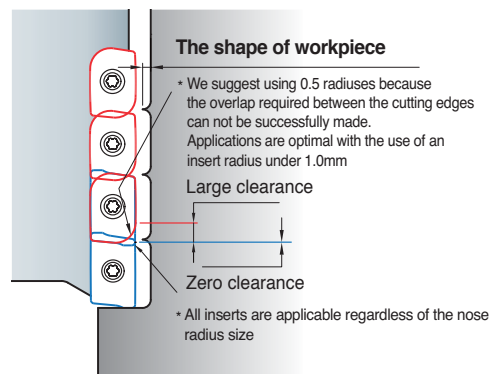

Parts

Specification	Screw	Wrench
$\varnothing 50 \sim \varnothing 100$	FTKA02565S	TW08S

Available inserts E05 Available arbors and bolt E400-E402



AMC(M)3000M

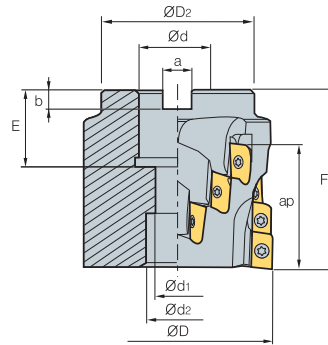

AA
90°
• AR: 9°
• RR: -9° ~ -5°

(mm)

Designation	ØD	ØD ₂	Ød	Ød ₁	Ød ₂	a	b	E	F	No. of flute	ap	kg
AMC 3063M	16	63	25.4 (27)	14	20	9.5 (12.4)	6 (7)	38 (38)	85	4	57	1.1
(AMCM) 3080M	20	80	31.75 (32)	14	26	12.7 (14.4)	8 (8)	40 (40)	100	4	71	2.23
3100M	30	100	38.1 (40)	22	32	15.9 (16.4)	10 (9)	40 (40)	100	6	71	3.59

() Metric size

Available inserts



Designation	Cermet		Coated											Uncoated		page		
	CN2000	CN30	NCM325	NC5330	NCM635	NCM645	PC2505	PC2510	PC3600	PC3700	PC6510	PC9530	PC9540	PC5300	PC5400		G10	H01
APMT 1604PDFR-MA																	●	E05
160404PDFR-MA																		
1604PDER-ML														●	●			
160404PDER-ML														●	●			
1604PDSR-MM			●	●	●		●	●	●	●	●	●	●	●	●			
1604PDSR-MF				●					●					●	●			
160410PDSR-MM								●						●	●			
160416PDSR-MM				●				●	●					●	●			
160424R-MM				●				●	●					●	●			
160430R-MM								●	●					●	●			
160432R-MM				●				●	●					●	●			
1604PDSR-MN3														●				
1604PDSR-MN4														●				

※ Please purchase 2 types of APMT-MN (nick type) inserts with different chip breakers. ※ Please use the cutters with even teeth.

Available arbors

Designation	Ød	NC arbors	
AMC (AMCM) 3063M	25.4	BT□□-FMA25.4-□□	BT□□-SMA25.4-□□
	27	BT□□-FMC27-□□	BT□□-SMC27-□□
3080M	31.75	BT□□-FMA31.75-□□	BT□□-SMA31.75-□□
	32	BT□□-FMC32-□□	BT□□-SMC32-□□
3100M	38.1	BT□□-FMA38.1-□□	BT□□-SMA38.1-□□
	40	BT□□-FMC40-□□	BT□□-SMC40-□□

Caution when clamping the inserts

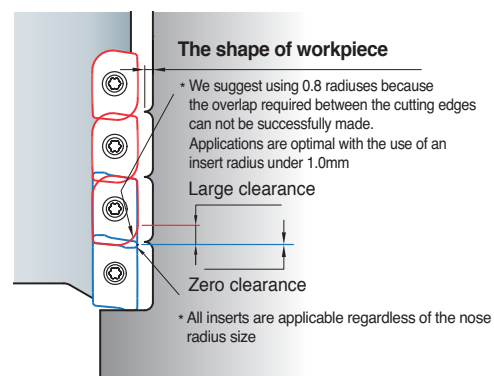

Parts

Specification	Screw	Wrench
Ø63-Ø100	FTKA0410	TW15S

Available inserts E05 Available arbors and bolt E400~E402

AMC(M)4000M

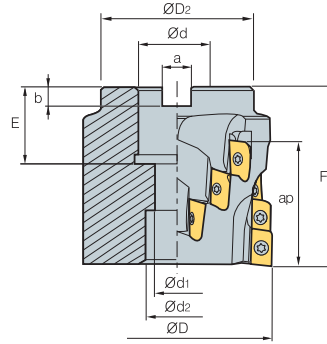

(mm)

Designation	ØD	ØD2	Ød	Ød1	Ød2	a	b	E	F	No. of flute	ap	kg	
AMC 4063M	16	63	57	25.4 (27)	14	20	9.5 (12.4)	6 (7)	38 (38)	85	4	61.1	1.1
(AMCM) 4080M	20	80	67	31.75 (32)	14	26	12.7 (14.4)	8 (8)	40 (40)	100	4	76.1	2.23
4100M	30	100	87	38.1 (40)	22	32	15.9 (16.4)	10 (9)	40 (40)	100	6	76.1	3.59
4125M	18	125	87	38.1 (40)	22	32	15.9 (16.4)	10 (9)	36 (29)	68	6	46.1	4.0

()Metric size

Available inserts



Designation	Cemented										page	Designation	Cemented										page													
	CN2000	CN30	NCM325	NC5330	NCM535	NCM545	PC2505	PC2010	PC3600	PC3700			PC6510	PC9530	PC9540	PC5300	PC5400	G10	H01	Designation	CN2000	CN30		NCM325	NC5330	NCM535	NCM545	PC2505	PC2510	PC3600	PC3700	PC6510	PC9530	PC9540	PC5300	PC5400
APMT 1806PDFR-MA																			APMT 180624PDER-ML																	
180604PDFR-MA																			180630R-ML																	
180612PDFR-MA																			1806PDSR-MM																	
180616PDFR-MA																			1806PDSR-MF																	
180620PDFR-MA																			180612PDSR-MM																	
180624PDFR-MA																			180616PDSR-MM																	
180630R-MA																			180620PDSR-MM																	
1806PDER-ML																			180624PDSR-MM																	
180604PDER-ML																			180630R-MM																	
180612PDER-ML																			180632R-MM																	
180616PDER-ML																			1806PDSR-MN3																	
180620PDER-ML																			1806PDSR-MN4																	

* Please purchase 2 types of APMT-MN (nick type) inserts with different chip breakers. * Please use the cutters with even teeth.

Available arbors

Designation	Ød	NC arbors	
AMC 4063M	25.4	BT□□-FMA25.4-□□	BT□□-SMA25.4-□□
	27	BT□□-FMC27-□□	BT□□-SMC27-□□
4080M	31.75	BT□□-FMA31.75-□□	BT□□-SMA31.75-□□
	32	BT□□-FMC32-□□	BT□□-SMC32-□□
4100M	38.1	BT□□-FMA38.1-□□	BT□□-SMA38.1-□□
	40	BT□□-FMC40-□□	BT□□-SMC40-□□
4125M	38.1	BT□□-FMA38.1-□□	BT□□-SMA38.1-□□
	40	BT□□-FMC40-□□	BT□□-SMC40-□□

Caution when clamping the inserts

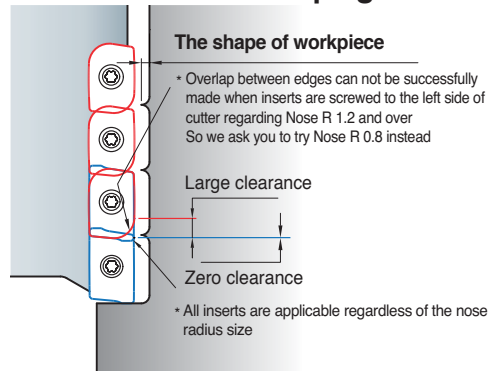

Parts

Specification	Screw	Wrench
Ø63~Ø125	FTKA0410	TW15S

Available inserts E05 Available arbors and bolt E400~E402



AMS1000S

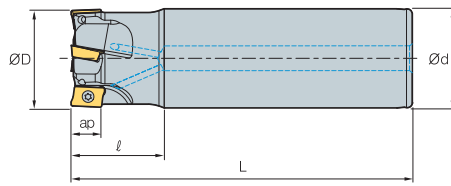

Fig. 1

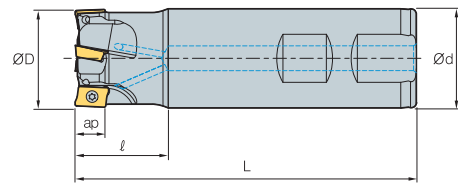

Fig. 2



AA
90°
• AR: 7.5°~13°
• RR: -17°~-6°

(mm)

Designation		ØD	Ød	ℓ	L	ap		Fig.
AMS	1010HS	2	10	10	20	80	0.04	2
	1011HS	2	11	10	20	80	0.04	2
	1012HS-2	2	12	12	25	80	0.06	2
	1012HS-2L12	2	12	12	25	120	0.09	1
	1012HS-3	3	12	12	25	80	0.06	2
	1014HS-2	2	14	16	25	90	0.11	2
	1014HS-2L16	2	14	16	25	140	0.18	1
	1014HS-3	3	14	16	25	90	0.11	2
	1015HS	3	15	16	25	90	0.11	2
	1015HS-3L16	3	15	16	25	140	0.18	1
	1016HS-3	3	16	16	25	90	0.12	2
	1016HS-3L16	3	16	16	25	160	0.22	1
	1016HS-4	4	16	16	25	90	0.12	2
	1017HS	4	17	16	25	90	0.12	2
	1017HS-3L16	3	17	16	25	160	0.22	1
	1018HS	4	18	16	25	90	0.12	2
	1018HS-4L16	4	18	16	25	180	0.25	1
	1020HS-4	4	20	20	30	110	0.23	2
	1020HS-4L20	4	20	20	30	200	0.43	1
	1020HS-5	5	20	20	30	110	0.23	2
1021HS	5	21	20	30	110	0.24	2	
1021HS-4L20	4	21	20	30	200	0.43	1	
1022HS	5	22	20	30	110	0.27	2	
1025HS	7	25	25	30	120	0.39	2	
1026HS	7	26	25	30	120	0.39	2	
1032HS	8	32	32	35	120	0.65	2	
1033HS	8	33	32	35	120	0.65	2	

Available inserts

APMT-MA APMT-MM



Designation	Cermet		Coated											Uncoated		page		
	CN2000	CN30	NCM325	NC5330	NCM535	NCM545	PC2505	PC2510	PC3600	PC3700	PC6510	PC9530	PC9540	PC5300	PC5400		G10	H01
APMT 0602PDFR-MA																	●	E05
060208PDFR-MA																		
060202PDSR-MM				●						●				●	●			
0602PDSR-MM				●			●	●	●	●	●			●	●			
060208PDSR-MM				●					●	●				●	●			
060212R-MM				●					●					●	●			
060216R-MM									●					●	●			

Parts

Specification		
Ø10~Ø33	FTKA01842	TW06S-A

Available inserts E05

AMS1500S

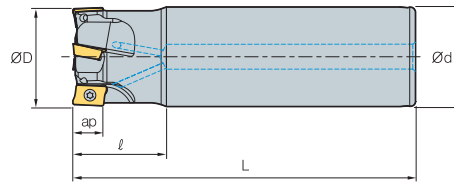

Fig. 1

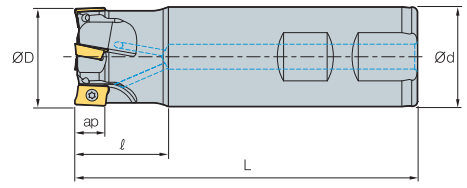
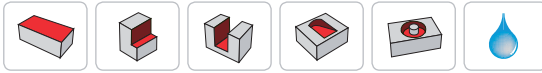

Fig. 2



AA
90°
• AR: 7.5°~12.5°
• RR: -28°~-14°

(mm)

Designation		ØD	Ød	ℓ	L	ap		Fig.
AMS 15010HS	1	10	10	25	80	9	0.04	2
15010HS-1L16	1	10	16	30	160	9	0.21	1
15012HS	1	12	16	25	80	9	0.10	2
15012HS-1L16	1	12	16	30	160	9	0.21	1
15013HS	1	13	16	25	80	9	0.10	2
15014HS	1	14	16	25	80	9	0.10	2
15014HS-1L16	1	14	16	30	160	9	0.21	1
15016HS	2	16	16	30	90	9	0.11	2
15016HS-2L16	2	16	16	30	160	9	0.21	1
15017HS	2	17	16	30	90	9	0.12	2
15017HS-2L16	2	17	16	30	160	9	0.21	1
15018HS	2	18	16	30	90	9	0.14	2
15018HS-2L16	2	18	16	30	160	9	0.21	1
15019HS	2	19	16	30	90	9	0.16	2
15020HS	2	20	20	30	90	9	0.18	2
15020HS-2L20	2	20	20	30	160	9	0.34	1
15020HS-3	3	20	20	30	90	9	0.18	2
15021HS	2	21	20	30	90	9	0.20	2
15021HS-2L20	2	21	20	30	160	9	0.34	1
15021HS-3	3	21	20	30	90	9	0.20	2
15022HS	3	22	20	30	110	9	0.23	2
15022HS-3L20	3	22	20	30	180	9	0.38	1
15024HS	3	24	20	30	110	9	0.30	2
15024HS-4	4	24	20	30	110	9	0.30	2
15025HS-3S20	3	25	20	30	110	9	0.35	2
15025HS	3	25	25	30	110	9	0.35	2
15025HS-3L25	3	25	25	30	180	9	0.59	1

Available inserts



Designation	Cermet		Coated										Uncoated		page			
	CN2000	CN30	NCM325	NC5330	NCM635	NCM545	PC2505	PC2510	PC3600	PC3700	PC6510	PC9530	PC9540	PC5300		PC5400	G10	H01
APMT 0903PDFR-MA																	●	E05
090308PDFR-MA																		
0903PDER-ML														●	●			
090308PDER-ML														●	●			
0903PDSR-MM				●			●	●	●	●				●	●			
090308PDSR-MM				●				●	●	●				●	●			
090312R-MM								●	●	●				●	●			
090316R-MM				●				●	●	●				●	●			
090320R-MM								●	●	●				●	●			

Parts

Specification		
Ø10~Ø14	FTKA02555S	TW08S
Ø16~Ø25	FTKA02565S	

Available inserts E05



AMS1500S

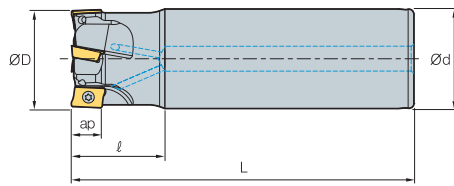

Fig. 1

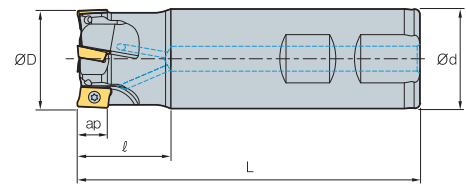

Fig. 2



AA **90°**
 • AR: 7.5°~12.5°
 • RR: -28°~-14°

(mm)

Designation		ØD	Ød	ℓ	L	ap		Fig.
AMS 15025HS-4S20	4	25	20	30	110	9	0.25	2
15025HS-4S25	4	25	25	30	110	9	0.25	2
15028HS	4	28	25	30	110	9	0.36	2
15028HS-4L25	4	28	25	30	180	9	0.61	1
15028HS-5	5	28	25	30	110	9	0.36	2
15030HS	4	30	25	30	110	9	0.38	2
15030HS-4L25	4	30	25	30	180	9	0.62	1
15030HS-5	5	30	25	30	110	9	0.38	2
15032HS	4	32	32	30	110	9	0.60	2
15032HS-4L32	4	32	32	30	180	9	1.00	1
15032HS-5	5	32	32	30	110	9	0.60	2
15035HS	5	35	32	30	110	9	0.70	2
15035HS-6	6	35	32	30	110	9	0.70	2
15040HS-S32	5	40	32	35	130	9	0.80	2
15040HS-5L32	5	40	32	35	200	9	1.20	1
15040HS-6S32	6	40	32	35	130	9	0.80	2
15040HS-S40	5	40	40	35	130	9	1.13	2
15040HS-6S40	6	40	40	35	130	9	1.13	2
15040HS-S42	5	40	42	35	130	9	1.23	2
15040HS-6S42	6	40	42	35	130	9	1.23	2

Available inserts

APMT-MA APMT-ML APMT-MM



Designation	Cermet		Coated											Uncoated		page		
	CN2000	CN30	NCM325	NC5330	NCM535	NCM545	PC2505	PC2510	PC3600	PC3700	PC6510	PC9530	PC9540	PC5300	PC5400		G10	H01
APMT 0903PDFR-MA																		●
090308PDFR-MA																		
0903PDER-ML																		
090308PDER-ML																		
0903PDSR-MM				●			●	●	●	●	●							
090308PDSR-MM				●														
090312R-MM																		
090316R-MM				●														
090320R-MM																		

Parts

Specification		
Ø25~Ø40	FTKA02565S	TW08S

Available inserts E05

AMS2000S

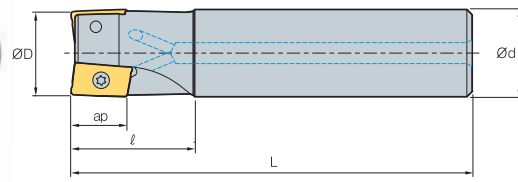

Fig. 1

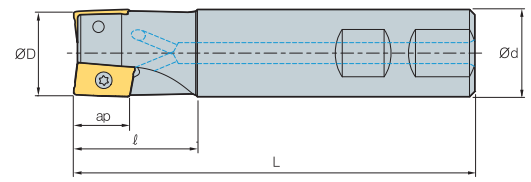

Fig. 2



AA
90°
• AR: 3°~14°
• RR: -25°~-18°

(mm)

Designation	Teeth	ØD	Ød	ℓ	L	ap	Weight (kg)	Fig.
AMS 2010HS	1	10	10	20	85	11	0.04	2
2010HS-1L16	1	10	16	30	160	11	0.21	1
2012HS	1	12	16	25	85	11	0.10	2
2012HS-1L16	1	12	16	30	160	11	0.21	1
2014HS	1	14	16	25	90	11	0.12	2
2014HS-1L16	1	14	16	30	160	11	0.21	1
2016HS	2	16	16	25	90	11	0.12	2
2016HS-2L16	2	16	16	30	180	11	0.21	1
2018HS	2	18	16	25	90	11	0.12	2
2018HS-2L16	2	18	16	30	180	11	0.21	1
2020HS	2	20	20	30	100	11	0.21	2
2020HS-2L20	2	20	20	30	210	11	0.49	1
2022HS	3	22	20	35	115	11	0.25	2
2022HS-3L20	3	22	20	35	180	11	0.38	1
2025HS	3	25	25	35	115	11	0.40	2
2025HS-3L25	3	25	25	40	180	11	0.59	1
2032HS	4	32	32	40	125	11	0.70	2
2032HS-4L32	4	32	32	50	180	11	1.00	1
2040HS	5	40	32	42	130	11	0.84	2
2040HS-5L32	5	40	32	50	200	11	1.20	1
2040HS-S40	5	40	40	42	130	11	1.15	2
2040HS-S42	5	40	42	42	130	11	2.00	2
2050HS	6	50	32	45	135	11	1.06	2
2050HS-S40	6	50	40	45	135	11	1.38	2
2050HS-S42	6	50	42	45	135	11	1.50	2
2063HS	8	63	32	45	135	11	1.31	2
2063HS-S40	8	63	40	45	135	11	1.62	2
2063HS-S42	8	63	42	45	135	11	1.70	2

Available inserts



Designation	Cermet		Coated											Uncoated		page		
	CN2000	CN30	NCM325	NC5330	NCM535	NCM545	PC2505	PC2510	PC3600	PC3700	PC6510	PC9530	PC9540	PC5300	PC5400		G10	H01
APMT 11T3PDFR-MA																		●
11T308PDFR-MA																		
11T3PDER-ML														●	●			
11T308PDER-ML														●	●			
11T3PDSR-MM			●	●	●		●	●	●	●	●	●		●	●			
11T3PDSR-MF				●				●	●	●	●			●	●			
11T308PDSR-MM				●				●	●	●	●	●		●	●			
11T312PDSR-MM				●				●	●	●	●	●		●	●			
11T316R-MM				●				●	●	●	●			●	●			
11T318R-MM				●				●	●	●	●			●	●			
11T324R-MM				●				●	●	●	●			●	●			
11T3PDSR-MN2														●	●			
11T3PDSR-MN3														●	●			

Parts

* Please purchase 2 types of APMT-MN (nick type) inserts with different chip breakers. * Please use the cutters with even teeth.

Specification	Screw	Wrench
Ø10~Ø14	FTKA02555S	TW08S
Ø16~Ø63	FTKA02565S	



AMS3000S

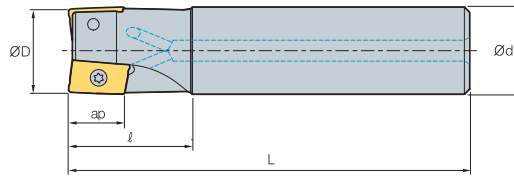

Fig. 1

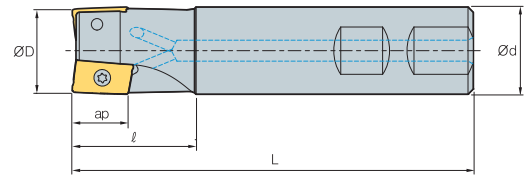

Fig. 2



AA
90°
• AR: 3°~14°
• RR: -18°~-10°

(mm)

Designation		ØD	Ød	ℓ	L	ap		Fig.
AMS 3025HS	2	25	25	35	115	16	0.40	2
3025HS-2M25	2	25	25	35	180	16	0.65	1
3025HS-2L25	2	25	25	60	220	16	0.75	1
3032HS	3	32	32	40	125	16	0.69	2
3032HS-2M32	2	32	32	40	200	16	1.13	1
3032HS-2L32	2	32	32	65	260	16	1.52	1
3032HS-3M32	3	32	32	40	200	16	1.12	1
3032HS-3L32	3	32	32	65	260	16	1.48	1
3040HS	4	40	32	42	130	16	0.80	2
3040HS-3M32	3	40	32	42	200	16	1.24	1
3040HS-3L32	3	40	32	42	260	16	1.61	1
3040HS-4M32	4	40	32	42	200	16	1.21	1
3040HS-4L32	4	40	32	42	260	16	1.58	1
3040HS-S40	4	40	40	42	130	16	1.10	2
3040HS-S42	4	40	42	42	130	16	1.20	2
3050HS	5	50	32	45	135	16	1.00	2
3050HS-S40	5	50	40	45	135	16	1.30	2
3050HS-S42	5	50	42	45	135	16	1.40	2
3063HS	6	63	32	45	135	16	1.25	2
3063HS-S40	6	63	40	45	135	16	1.50	2
3063HS-S42	6	63	42	45	135	16	1.54	2

Available inserts



Designation	Cermet		Coated										Uncoated		page			
	CN2000	CN30	NCM325	NC5330	NCM535	NCM545	PC2505	PC2510	PC3800	PC3700	PC6510	PC9530	PC9540	PC5300		PC5400	G10	H01
APMT 1604PDFR-MA																		●
160404PDFR-MA																		
1604PDER-ML																		
160404PDER-ML																		
1604PDSR-MM			●	●	●		●	●	●	●	●	●	●	●	●			
1604PDSR-MF				●				●	●	●				●	●			
160410PDSR-MM								●	●					●	●			
160416PDSR-MM				●					●	●				●	●			
160424R-MM				●					●	●				●	●			
160430R-MM									●	●				●	●			
160432R-MM				●					●	●				●	●			
1604PDSR-MN3														●	●			
1604PDSR-MN4														●	●			

※ Please purchase 2 types of APMT-MN (nick type) inserts with different chip breakers. ※ Please use the cutters with even teeth.

Parts

Specification		
Ø25 Ø32~Ø63	FTKA0408 FTKA0410	TW15S

Available inserts E05

AMS3000S-K

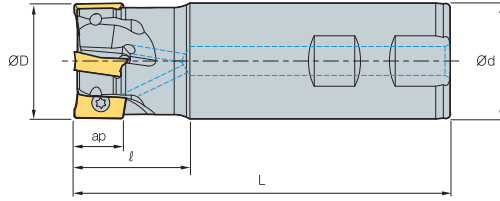

AA
90°
• AR: 14°
• RR: -18° ~ -10°

(mm)

Designation		ØD	Ød	l	L	ap	
AMS 3025HS-K	2	25	25	35	115	16	0.4
3032HS-K	3	32	32	40	125	16	0.69
3040HS-K	4	40	32	42	130	16	0.8
3040HS-K-S40	4	40	40	42	130	16	1.1
3040HS-K-S42	4	40	42	42	130	16	1.2
3050HS-K	5	50	32	45	135	16	1.0
3050HS-K-S40	5	50	40	45	135	16	1.3
3050HS-K-S42	5	50	42	45	135	16	1.4
3063HS-K	6	63	32	45	135	16	1.25
3063HS-K-S40	6	63	40	45	135	16	1.5
3063HS-K-S42	6	63	42	45	135	16	1.54

Available inserts

APKT APKT-MF APKT-MM APKT-MM1 APKT-MA APKT-MA2 APKT-MA3



Designation	Cermet		Coated										Uncoated			page		
	CN2000	CN30	NCM325	NCM335	NCM535	NCM545	PC2505	PC2510	PC3700	PC6510	PC9530	PC9540	PC5300	PC5400	PD2000		G10	H01
APKT 1604PDSR			●						●	●								
1604PDSR-MF			●										●					
1604PDSR-MM			●	●					●	●	●		●					
160432R-MM1																		
1604PDFR-MA														●			●	●
1604PDFR-MA2																	●	
160416FR-MA2																		
160432FR-MA2																		
1604PDFR-MA3																	●	●

Parts

Specification		
Ø25 Ø32-Ø63	FTKA0408 FTKA0410	TW15S

Available inserts E05



AMS4000S

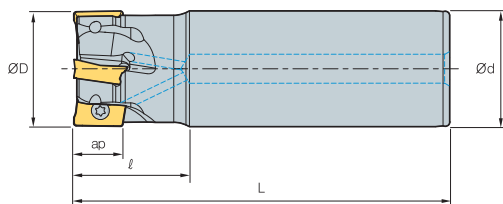

Fig. 1

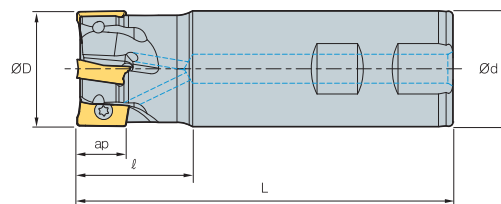

Fig. 2



AA
90°
• AR: 7°~13°
• RR: -20°~-6°

(mm)

Designation		ØD	Ød	ℓ	L	ap		Fig.
AMS 4020HS	1	20	20	30	90	17	0.18	2
4020HS-M	1	20	20	30	160	17	0.17	1
4021HS	1	21	20	30	90	17	0.19	2
4021HS-M	1	21	20	30	160	17	0.34	1
4025HS	2	25	25	40	110	17	0.35	2
4025HS-2M25	2	25	25	40	180	17	0.58	1
4025HS-2L25	2	25	25	40	230	17	0.80	1
4026HS	2	26	25	40	110	17	0.37	2
4026HS-2M25	2	26	25	40	180	17	0.60	1
4026HS-2L25	2	26	25	40	230	17	0.82	1
4032HS	3	32	32	40	125	17	0.65	2
4032HS-2M32	2	32	32	50	200	17	1.17	1
4032HS-2L32	2	32	32	50	260	17	1.50	1
4032HS-3M32	3	32	32	50	200	17	1.10	1
4032HS-3L32	3	32	32	50	260	17	1.48	1
4033HS	3	33	32	40	125	17	0.68	2
4033HS-2M32	2	33	32	50	200	17	1.12	1
4033HS-2L32	2	33	32	50	260	17	1.55	1
4033HS-3M32	3	33	32	50	200	17	1.12	1
4033HS-3L32	3	33	32	50	260	17	1.55	1

Available inserts

APMT-MA APMT-ML APMT-MM APMT-MF APMT-MN



Designation	Coated										Uncoated	page	Designation	Coated										Uncoated	page								
	CN2000	CN30	NCM325	NC5330	NCM635	NCM645	PC2505	PC2010	PC3600	PC3700				PC6510	PC9530	PC9540	PC5300	PC5400	G10	H01	CN2000	CN30	NCM325			NC5330	NCM635	NCM645	PC2505	PC2010	PC3600	PC3700	PC6510
APMT 1806PDR-MA												●		APMT 180624PDR-ML																●			
180604PDR-MA												●		180630R-ML																●			
180612PDR-MA												●		1806PDSR-MM			●		●	●	●	●	●	●	●	●	●	●	●	●			
180616PDR-MA												●		1806PDSR-MF			●		●	●										●			
180620PDR-MA												●		180612PDSR-MM			●		●	●										●			
180624PDR-MA												●		180616PDSR-MM			●		●	●										●			
180630R-MA												●		180620PDSR-MM																●			
1806PDER-ML												●●		180624PDSR-MM			●		●	●										●●			
180604PDER-ML												●●		180630R-MM					●	●										●●			
180612PDER-ML												●●		180632R-MM			●		●	●										●●			
180616PDER-ML												●●		1806PDSR-MN3																●			
180620PDER-ML												●●		1806PDSR-MN4																●			

※ Please purchase 2 types of APMT-MN (nick type) inserts with different chip breakers. ※ Please use the cutters with even teeth.

Parts

Specification		
Ø20~Ø21	FTKA0408	TW15S
Ø25~Ø33	FTKA0410	TW15S

Available inserts E05

AMS4000S

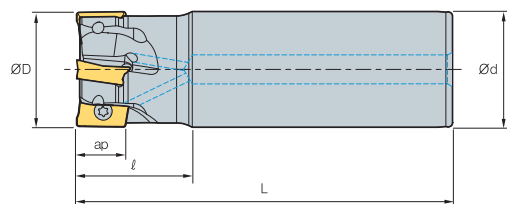

Fig. 1

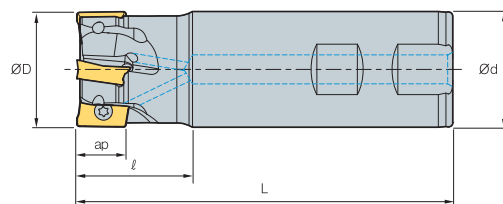

Fig. 2



AA 90°
• AR: 7°~13°
• RR: -20°~-6°

(mm)

Designation	Flutes	ØD	Ød	ℓ	L	ap	Weight (kg)	Fig.
AMS 4040HS-3M32	3	40	32	50	200	17	1.20	1
4040HS-3L32	3	40	32	50	260	17	1.60	1
4040HS-4M32	4	40	32	50	200	17	1.20	1
4040HS-4L32	4	40	32	50	260	17	1.60	1
4040HS-S32	4	40	32	40	130	17	0.76	2
4040HS-S40	4	40	40	40	130	17	1.10	2
4040HS-S42	4	40	42	40	130	17	1.20	2
4050HS-S32	5	50	32	40	135	17	0.95	2
4050HS-S40	5	50	40	40	135	17	1.30	2
4050HS-S42	5	50	42	40	135	17	1.40	2
4063HS-S32	6	63	32	40	135	17	1.25	2
4063HS-S40	6	63	40	40	135	17	1.60	2
4063HS-S42	6	63	42	40	135	17	1.70	2

Available inserts



Designation	Coated										Uncoated		page	Designation	Coated										Uncoated		page								
	CN2000	CN30	NCM325	NC5330	NCM635	NCM645	PC2505	PC2510	PC3600	PC3700	PC6510	PC9530			PC9540	PC5300	PC5400	G10	H01	CN2000	CN30	NCM325	NC5330	NCM635	NCM645	PC2505		PC2510	PC3600	PC3700	PC6510	PC9530	PC9540	PC5300	PC5400
APMT 1806PDFR-MA																●	E05	APMT 180624PDER-ML																●	E05
180604PDFR-MA																●		180630R-ML														●			
180612PDFR-MA																●		1806PDSR-MM			●		●	●	●	●	●	●	●	●	●	●	●		
180616PDFR-MA																●		1806PDSR-MF			●		●	●	●	●	●	●	●	●	●	●	●	●	
180620PDFR-MA																●		180612PDSR-MM			●		●	●	●	●	●	●	●	●	●	●	●	●	
180624PDFR-MA																●		180616PDSR-MM			●		●	●	●	●	●	●	●	●	●	●	●	●	
180630R-MA																●		180620PDSR-MM																	
1806PDER-ML																●		180624PDSR-MM			●		●	●	●	●	●	●	●	●	●	●	●	●	
180604PDER-ML																●		180630R-MM			●		●	●	●	●	●	●	●	●	●	●	●	●	
180612PDER-ML																●		180632R-MM			●		●	●	●	●	●	●	●	●	●	●	●	●	
180616PDER-ML																●		1806PDSR-MN3																●	
180620PDER-ML																●		1806PDSR-MN4																●	

* Please purchase 2 types of APMT-MN (nick type) inserts with different chip breakers. * Please use the cutters with even teeth.

Parts

Specification	Screw	Wrench
Ø40~Ø63	FTKA0410	TW15S

Available inserts E05



AMS1000SE/2000SE

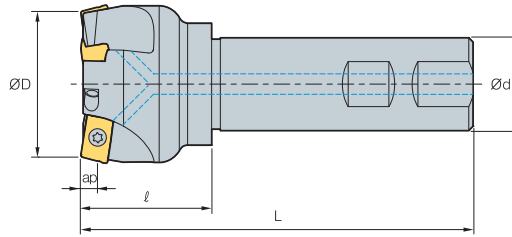

AA
75°

• AR: -4.5°~-1°
• RR: -3°~0°

(mm)

Designation		ØD	Ød	ℓ	L	ap	
AMS 1025HSE	3	25	25	30	115	2.5	0.41
AMS 2025HSE	2	25	25	30	115	4	0.4
2032HSE	3	32	32	40	125	4	0.72
2040HSE	3	40	32	40	130	4	0.86
2040HSE-S40	3	40	40	40	130	4	1.2
2040HSE-S42	3	40	42	40	130	4	1.3
2050HSE	4	50	32	40	135	4	0.98
2050HSE-S40	4	50	40	40	135	4	1.3
2050HSE-S42	4	50	42	40	135	4	1.4
2063HSE	5	63	32	40	135	4	1.24
2063HSE-S40	5	63	40	40	135	4	1.57
2063HSE-S42	5	63	42	40	135	4	1.62

Available inserts

APMT-MF APMT-MM



Type	Designation	Cermet		Coated											Uncoated		page	
		CN2000	CN30	NCM325	NC5330	NCM535	NCM545	PC2505	PC2510	PC3600	PC3700	PC6510	PC9530	PC9540	PC5300	PC5400		G10
1000 type	APMT 060202PDSR-MM				●													
	0602PDSR-MM				●			●	●	●	●	●			●	●		
	060208PDSR-MM				●					●	●				●	●		
	060212R-MM				●					●					●	●		
	060216R-MM									●					●	●		
2000 type	APMT 11T3PDSR-MM			●	●	●		●	●	●	●	●			●	●		
	11T3PDSR-MF				●					●	●	●			●	●		
	11T308PDSR-MM				●					●	●		●		●	●		
	11T312PDSR-MM				●					●	●		●		●	●		
	11T316R-MM				●					●	●				●	●		
	11T318R-MM									●	●				●	●		
	11T324R-MM				●					●	●				●	●		

Parts

Specification			
Ø25 (1000 type)	FTKA01842	-	TW06S-A
Ø25~Ø63 (2000 type)	FTKA02565S	TW08S	-

Available inserts E05



AMS3000SE

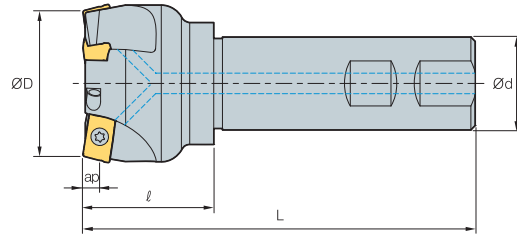

AA
75°

• AR: -4.5°~ -1°
• RR: -3°~ 0°

(mm)

Designation		ØD	Ød	l	L	ap	
AMS 3050HSE	3	50	32	45	135	6	1.0
3050HSE-S40	3	50	40	45	135	6	1.3
3050HSE-S42	3	50	42	45	135	6	1.4
3063HSE	4	63	32	45	135	6	1.3
3063HSE-S40	4	63	40	45	135	6	1.6
3063HSE-S42	4	63	42	45	135	6	1.7

Available inserts

APMT-MF APMT-MM



Designation	Cermet		Coated										Uncoated		page			
	CN2000	CN80	NCM325	NC5330	NCM535	NCM545	PC2505	PC2510	PC3600	PC3700	PC6510	PC9530	PC9540	PC5300		PC5400	G10	H01
APMT 1604PDSR-MM			●	●	●		●	●	●	●	●	●	●	●	●			E05
1604PDSR-MF				●						●				●				
160410PDSR-MM														●	●			
160416PDSR-MM				●					●	●				●	●			
160424R-MM				●					●	●				●	●			
160430R-MM									●	●				●	●			
160432R-MM				●					●	●				●	●			

Parts

Specification		
Ø50~Ø63	FTKA0410	TW15S

Available inserts E05



AMS1000M/1500M

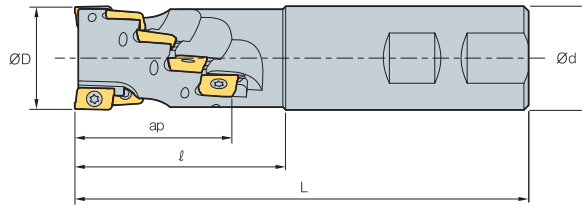

Designation		ØD	Ød	ℓ	L	No. of flute	ap	
AMS 1016M	6	16	16	30	80	2	15.5	0.3
	12	20	20	32	85	3	20.5	0.3
	20	25	25	39	95	4	25.5	0.3
AMS 15020M	3	20	20	42	105	1	26.5	0.3
	8	25	25	50	110	2	35	0.3
	10	32	32	60	120	2	44	0.3

Available inserts



Type	Designation	Cermet		Coated										Uncoated		page			
		CN2000	CN30	NCM325	NC5330	NCM635	NCM545	PC2505	PC2510	PC3600	PC3700	PC6510	PC9530	PC9540	PC5300		PC5400	G10	H01
1000 type	APMT 0602PDFR-MA																	●	E05
	APMT 060208PDFR-MA																		
	APMT 060202PDSR-MM				●						●				●	●			
	APMT 0602PDSR-MM				●			●	●		●	●	●		●	●			
	APMT 060208PDSR-MM				●					●	●				●	●			
	APMT 060212R-MM				●					●	●				●	●			
1500 type	APMT 060216R-MM								●					●	●				
	APMT 0903PDFR-MA																●		
	APMT 090308PDFR-MA																		
	APMT 0903PDER-ML													●	●				
	APMT 090308PDER-ML													●	●				
	APMT 0903PDSR-MM				●			●	●	●	●	●		●	●				
	APMT 090308PDSR-MM				●					●	●			●	●				
	APMT 090312R-MM									●	●			●	●				
APMT 090316R-MM				●					●	●			●	●					
APMT 090320R-MM									●	●			●	●					

Caution when clamping the inserts

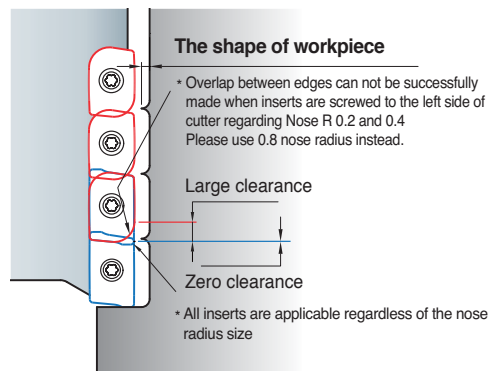

Parts

Specification			
Ø16~Ø25 (1000 type)	FTKA01842	-	TW06S-A
Ø20~Ø32 (1500 type)	FTKA02565S	TW08S	-

Available inserts E05

AMS2000M

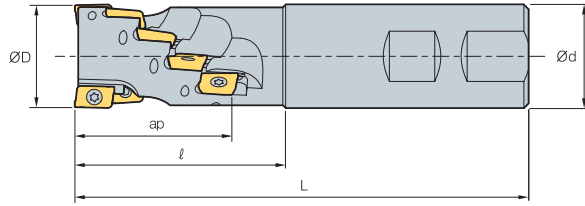

(mm)

Designation		ØD	Ød	ℓ	L	No. of flute	ap	
AMS	2020M	3	20	20	45	1	29.4	0.32
	2025M	8	25	25	55	2	38.9	0.40
	2032M	10	32	32	65	2	48.5	0.65
	2040M	14	40	40	75	2	58	0.75

Available inserts



Designation	Cermet		Coated										Uncoated		page			
	CN2000	CN30	NCM325	NC5330	NCM535	NCM545	PC2505	PC2510	PC3600	PC3700	PC6510	PC9530	PC9540	PC5300		PC5400	G10	H01
APMT 11T3PDFR-MA																		●
11T308PDFR-MA																		
11T3PDER-ML														●	●			
11T308PDER-ML														●	●			
11T3PDSR-MM			●	●	●		●	●	●	●	●	●		●	●			
11T3PDSR-MF				●				●	●	●				●	●			
11T308PDSR-MM				●				●	●				●	●	●			
11T312PDSR-MM				●				●	●				●	●	●			
11T316R-MM				●				●	●					●	●			
11T318R-MM																		
11T324R-MM				●				●	●					●	●			
11T3PDSR-MN2														●	●			
11T3PDSR-MN3														●	●			

E05

※ Please purchase 2 types of APMT-MN (nick type) inserts with different chip breakers. ※ Please use the cutters with even teeth.

Caution when clamping the inserts

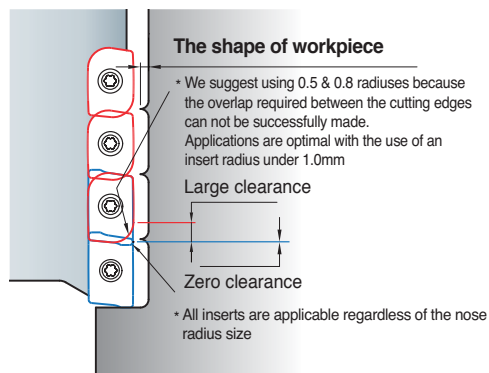

Parts

Specification		
Ø20~Ø40	FTKA02565S	TW08S

Available inserts E05



AMS4000M

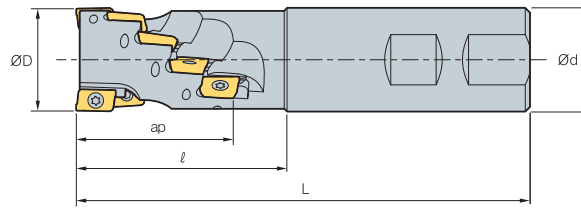

AA
90°
• AR: 7°~9°
• RR: -13°~-10°

(mm)

Designation		ØD	Ød	ℓ	L	No. of flute	ap	
AMS	4032M	4	32	32	60	130	2	0.65
	4040M	6	40	40	70	140	2	1.11
	4050M-S40	6	50	40	55	125	2	1.22
	4050M	8	50	40	70	140	2	1.37

Available inserts



Designation	Cermet		Coated											Uncoated		page	
	CN2000	CN30	NCM325	NC5330	NCM535	NCM545	PC2505	PC2510	PC3600	PC3700	PC6510	PC9530	PC9540	PC5300	PC5400		G10
APMT 1806PDFR-MA																	●
180604PDFR-MA																	●
180612PDFR-MA																	●
180616PDFR-MA																	●
180620PDFR-MA																	●
180624PDFR-MA																	●
180630R-MA																	●
1806PDER-ML													●	●			
180604PDER-ML													●	●			
180612PDER-ML													●	●			
180616PDER-ML													●	●			
180620PDER-ML													●	●			
180624PDER-ML													●	●			
180630R-ML													●	●			
1806PDSR-MM				●			●	●	●	●	●	●	●	●			
1806PDSR-MF				●					●				●	●			
180612PDSR-MM				●					●				●	●			
180616PDSR-MM				●					●				●	●			
180620PDSR-MM				●					●				●	●			
180624PDSR-MM				●					●				●	●			
180630R-MM				●					●				●	●			
180632R-MM				●					●				●	●			
1806PDSR-MN3													●	●			
1806PDSR-MN4													●	●			

※ Please purchase 2 types of APMT-MN (nick type) inserts with different chip breakers.
 ※ Please use the cutters with even teeth.

Caution when clamping the inserts

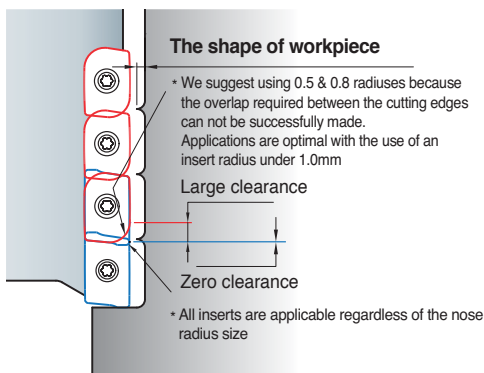

Parts

Specification		
Ø32~Ø50	FTKA0410	TW15S

Available inserts E05

AMS1000MH/1500MH

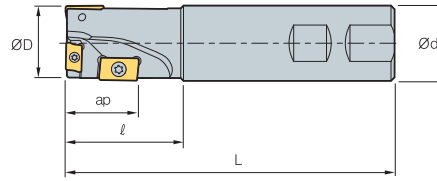

AA 90°
 • AR: 9°~12°
 • RR: -12°~-10°

(mm)

Designation		ØD	Ød	ℓ	L	ap		APMT 0602	APMT 0903	APM(X)T 11T3 -	APMT 1604	APKT 1604 -
AMS 1014MH	3	14	12	30	120	11	0.16	3	-	-	-	-
	3	16	14	30	140	11	0.20	3	-	-	-	-
	3	18	16	30	140	11	0.21	3	-	-	-	-
AMS 15020MH	3	20	20	35	140	17	0.31	1	2	-	-	-

Available inserts

APMT-MA APMT-ML APMT-MM



Type	Designation	Cermet		Coated											Uncoated		page	
		CN2000	CN30	NCM325	NC5330	NCM535	NCM545	PC2505	PC2510	PC3600	PC3700	PC6510	PC9530	PC9540	PC5300	PC5400		G10
1000 type	APMT 0602PDFR-MA																	●
	060208PDFR-MA																	
	060202PDSR-MM				●						●				●	●		
	0602PDSR-MM				●			●	●	●	●	●	●		●	●		
	060208PDSR-MM				●					●	●				●	●		
1500 type	APMT 0903PDFR-MA																	●
	090308PDFR-MA																	
	0903PDER-ML													●	●			
	090308PDER-ML													●	●			
	0903PDSR-MM				●			●	●	●	●	●		●	●			
090308PDSR-MM				●					●	●			●	●				

Parts

Specification			
	Screw	Wrench	Wrench
Ø14~Ø18 (1000 type)	FTKA01842	-	TW06S-A
Ø20 (1500 type)	FTKA02565S	TW08S	-

Recommended cutting condition

	Drilling	Shouldering	Slotting
vc (m/min)	80~200	80~200	80~200
fz (mm/t)	0.03~0.06	0.05~0.25	0.05~0.20

• Please keep the drill depth under 0.25D when you're drilling
 • Please keep the step depth from 0.2 to 0.3mm

Available inserts E05



AMS2000MH/3000MH(-K)

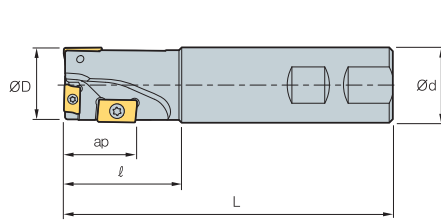

Fig. 1

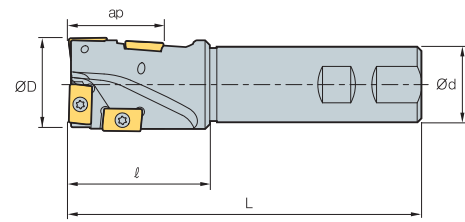

Fig. 2



• AR: 9°~12°
• RR: -12°~-10°

(mm)

Designation		ØD	Ød	ℓ	L	ap		APMT 0602	APMT 0903	APM(X)T 11T3 -	APMT 1604	APKT 1604 -	Fig.
AMS 2025MH	3	25	25	40	130	20	0.45	-	-	3	-	-	1
2032MH	3	32	32	50	140	30	0.75	-	-	1	2	-	1
AMS 3040MH	4	40	32	60	150	40	0.90	-	-	-	4	-	2
3040MH-K	4	40	32	60	150	40	0.90	-	-	-	-	4	2

Available inserts



Type	Designation	Cermet		Coated										Uncoated	page				
		CN2000	CN30	NCM325	NCM335	NC5330	NCM535	NCM545	PC2505	PC2510	PC3600	PC3700	PC6510	PC9530		PC9540	PC5300	PC5400	H01
2000 type	APMT 11T3PDFR-MA																	●	E04 E05
	11T308PDFR-MA																		
	11T3PDER-ML																		
	11T308PDER-ML																		
	11T3PDSR-MM			●		●	●		●	●	●	●	●		●	●			
	11T3PDSR-MF					●				●	●	●			●	●			
	11T308PDSR-MM					●				●	●		●	●	●	●			
	11T312PDSR-MM					●				●	●		●	●	●	●			
	11T316R-MM					●				●	●		●	●	●	●			
	11T318R-MM					●				●	●		●	●	●	●			
11T324R-MM					●				●	●		●	●	●	●				
3000 type	APMT 1604PDSR-MM			●		●			●	●	●	●	●	●	●	●			
	1604PDSR-MF					●				●	●	●		●	●				
3000-K type	APKT 1604PDSR-MM			●	●							●	●	●					
	1604PDSR-MF			●								●		●					

Parts

Specification			
	Screw	Wrench	Wrench
Ø25 (2000 type)	FTKA02565S	TW08S	-
Ø32 (2000 type)	FTKA02565S+FTKA0410	TW08S+TW15S	-
Ø40 (3000 type)	FTKA0410	TW15S	-

Available inserts E04, E05

Recommended cutting condition

	Drilling	Shouldering	Slotting
vc (m/min)	80~200	80~200	80~200
fz (mm/t)	0.03~0.06	0.05~0.25	0.05~0.20

• Please keep the drill depth under 0.25D when you're drilling
• Please keep the step depth from 0.2 to 0.3mm

AMM1000

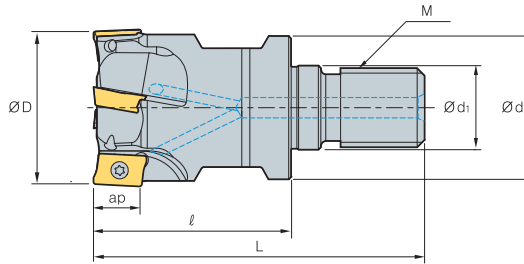

AA
90°
• AR: 7.5°~12.5°
• RR: -28°~-6°

(mm)

Designation		ØD	Ød	Ød1	l	L	M	ap	
AMM 1012HR-M06	3	12	11	6.5	25	40	M06	5.6	0.02
1016HR-M08	4	16	14.5	8.5	25	42	M08	5.6	0.03
1020HR-M10	5	20	18	10.5	30	51	M10	5.6	0.07
1025HR-M12	7	25	23	12.5	35	59	M12	5.6	0.12
1032HR-M16	8	32	29	17	40	67	M16	5.6	0.23

Available inserts

APMT-MA APMT-MM



Designation	Cermet		Coated										Uncoated		page			
	CN2000	CN30	NCM325	NC5330	NCM535	NCM545	PC2505	PC2510	PC3600	PC3700	PC6510	PC9530	PC9540	PC5300		PC5400	G10	H01
APMT 0602PDFR-MA																		●
060208PDFR-MA																		
060202PDSR-MM				●					●					●	●			
0602PDSR-MM				●			●	●	●	●	●	●		●	●			
060208PDSR-MM				●					●	●				●	●			
060212R-MM				●					●					●	●			
060216R-MM									●					●	●			

Available adaptor

Designation	Available adaptor
AMM 1012HR-M06	MAT-M06
1016HR-M08	MAT-M08
1020HR-M10	MAT-M10
1025HR-M12	MAT-M12
1032HR-M16	MAT-M16

Designation: AMM1032HR-M16
Modular head threading measure size (M16)

II

Adaptor spec.: MAT-M16-035-S32S
Adaptor threading measure (M16)

Parts

Specification		
Ø12~Ø32	FTKA01842	TW06S-A

Available inserts E05 Available adaptor E371~E372



AMM1500

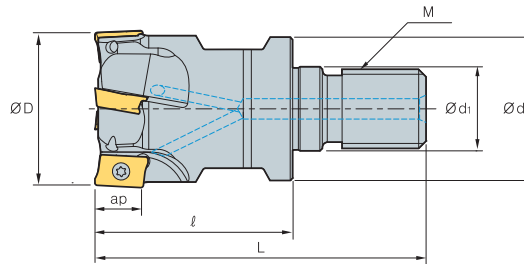

• AR: 7.5°~12.5°
• RR: -28°~-6°

(mm)

Designation		ØD	Ød	Ød1	l	L	M	ap	
AMM 15010HR-M06	1	10	9.5	6.5	25	40	M06	9	0.01
15012HR-M06	1	12	11	6.5	25	40	M06	9	0.02
15016HR-M08	2	16	14.5	8.5	25	42	M08	9	0.03
15020HR-M10	2	20	18	10.5	30	51	M10	9	0.06
15025HR-M12	3	25	23	12.5	35	59	M12	9	0.12
15032HR-M16	4	32	29	17	40	67	M16	9	0.22

Available inserts

APMT-MA APMT-ML APMT-MM



Designation	Cermet		Coated											Uncoated		page		
	CN2000	CN30	NCM825	NC5330	NCM535	NCM545	PC2505	PC2510	PC3600	PC3700	PC8510	PC9530	PC9540	PC5300	PC5400		G10	H01
APMT 0903PDFR-MA																		●
090308PDFR-MA																		
0903PDER-ML																		
090308PDER-ML																		
0903PDSR-MM				●			●	●	●	●	●							
090308PDSR-MM				●														
090312R-MM																		
090316R-MM				●														
090320R-MM																		

Available adaptor

Designation	Available adaptor
AMM 15010HR-M06	MAT-M06
15012HR-M06	
15016HR-M08	MAT-M08
15020HR-M10	MAT-M10
15025HR-M12	MAT-M12
15032HR-M16	MAT-M16

Designation: AMM1032HR-M16
Modular head threading measure size (M16)

||

Adaptor spec.: MAT-M16-035-S32S
Adaptor threading measure (M16)

Parts

Specification		
Ø10~Ø14	FTKA02555S	TW08S
Ø16~Ø100	FTKA02565S	TW08S

Available inserts E05 Available adaptor E371~E372

AMM2000

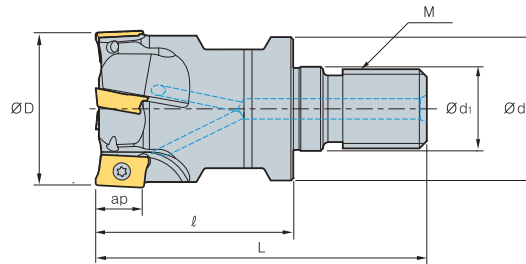

• AR: 7.5°~12.5°
• RR: -28°~-6°

(mm)

Designation		ØD	Ød	Ød1	l	L	M	ap	
AMM 2016HR-M08	2	16	14.5	8.5	25	42	M08	11	0.04
2020HR-M10	2	20	18	10.5	30	51	M10	11	0.07
2025HR-M12	3	25	23	12.5	35	59	M12	11	0.04
2032HR-M16	4	32	29	17	40	67	M16	11	0.23
2040HR-M16	5	40	29	17	40	67	M16	11	0.25

Available inserts

APMT-MA APMT-ML APMT-MM APMT-MF APMT-MN



Designation	Cermet		Coated												Uncoated		page	
	CN2000	CN30	NCM325	NC5330	NCM535	NCM545	PC2505	PC2510	PC3600	PC3700	PC6510	PC9530	PC9540	PC5300	PC5400	G10		H01
APMT 11T3PDFR-MA																		●
11T308PDFR-MA																		
11T3PDER-ML														●	●			
11T308PDER-ML														●	●			
11T3PDSR-MM			●	●	●		●	●	●	●	●	●		●	●			
11T3PDSR-MF				●				●	●	●				●	●			
11T308PDSR-MM				●				●	●	●		●	●	●	●			
11T312PDSR-MM				●				●	●		●			●	●			
11T316R-MM				●				●	●					●	●			
11T318R-MM																		
11T324R-MM				●				●	●					●	●			
11T3PDSR-MN2														●	●			
11T3PDSR-MN3														●	●			

* Please purchase 2 types of APMT-MN (nick type) inserts with different chip breakers. * Please use the cutters with even teeth.

Available adaptor

Designation	Available adaptor
AMM 2016HR-M08	MAT-M08
2020HR-M10	MAT-M10
2025HR-M12	MAT-M12
2032HR-M16	MAT-M16
2040HR-M16	

Designation: AMM1032HR-M16
Modular head threading measure size (M16)

II

Adaptor spec.: MAT-M16-035-S32S
Adaptor threading measure (M16)

Parts

Specification		
Ø16~Ø40	FTKA02565S	TW08S

Available inserts E05 Available adaptor E371~E372



Guarantee strong constrain force by 2-side constraint

BT/HSK Tooling System

Code system (Single, Multi-edge type)

BT50 HAT 4 063 114 - 4 F						
Arbor type	Item Name	Type	Diameter	Length (ap)	No. of flute	Front piece or total length
BT30/40/50 HSK40/50/63/100	AM HAT RM	1000 type 1500 type 2000 type 3000 type 4000 type	063: Ø63	Length: 114 HS: Coolant + Single	No. of flute: 4 No. of tooth: 4	Front Piece (Y/N) Y: F No code: No L: Long type

Code system (Modular type)

BT50 MAT M16 092			
Arbor type	Item category	M Dimensions	Total length (L)
BT30/40/50 HSK40/50/63/100	MAT	M16	092: 92

DBT system

Feature of (D)BT arbor

- Guaranteed strong force by 2-side constraint
- Guarantee strengthen cutting at high speed
- Guaranteed superior surface roughness

DBT (Constrain, increased surface roughness)

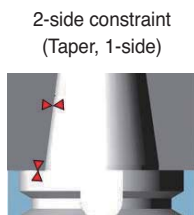

DBT Workpiece
Ra = 0.3µm

BT

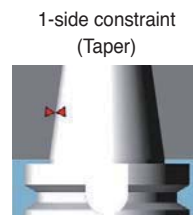

BT Workpiece
Ra = 0.5µm

HSK system

Feature of HSK arbor

- Guaranteed strong constrain force by 2-side constraint
- Guaranteed strengthened cutting at high speeds
- Guaranteed superior surface roughness
- Guaranteed repeatability at axle direction and repeated direction

HSK A: HSK T key tolerance comparison

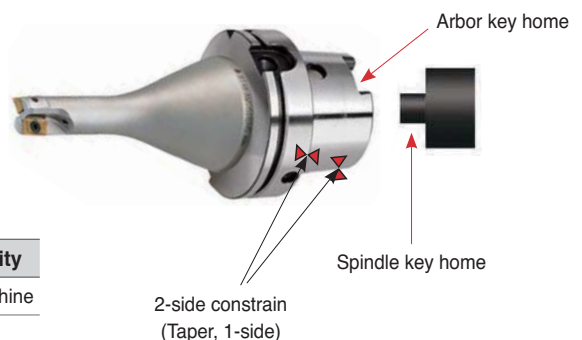

HSK tolerance comparison

Arbor type	Max. tolerance	Min. tolerance	Available facility
HSK-T	0.075	0.035	Multi-tasking machine
HSK-A	0.33	0.08 (General)	MCT

BT30 AM1000HS

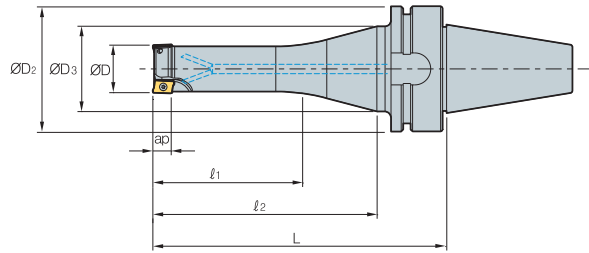

AA
90°
• AR: 7.5°~13°
• RR: -28°~-7°

(mm)

Designation		ØD	ØD2	ØD3	l1	l2	L	ap	
BT30	AM1010HS-2	2	10	46	41	35	83	112	5.6
	AM1012HS-2	2	12	46	41	35	83	112	5.6
	AM1012HS-3	3	12	46	41	35	83	112	5.6
	AM1016HS-3	3	16	46	41	35	83	112	5.6
	AM1016HS-4	4	16	46	41	35	83	112	5.6
	AM1020HS-4	4	20	46	41	45	98	127	5.6
	AM1020HS-5	5	20	46	41	45	98	127	5.6

Available inserts

APMT-MA APMT-MM



Designation	Cermet		Coated												Uncoated		page	
	CN2000	CN30	NCM325	NC5330	NCM535	NCM545	PC2505	PC2510	PC3600	PC3700	PC6510	PC9530	PC9540	PC5300	PC5400	G10		H01
APMT 0602PDFR-MA																		●
060208PDFR-MA																		
060202PDSR-MM				●						●				●	●			
0602PDSR-MM				●			●	●	●	●	●	●		●	●			
060208PDSR-MM				●						●	●			●	●			
060212R-MM				●						●				●	●			
060216R-MM									●					●	●			

Parts

Specification			
Ø10~Ø20	FTKA01842	-	TW06S-A

Available inserts E05



BT40 AM1500HS

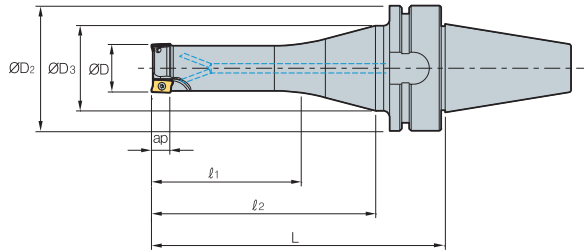

• AR: 7.5°~13°
• RR: -28°~-7°

(mm)

Designation		ØD	ØD2	ØD3	l1	l2	L	ap
BT40 AM15016HS-2	2	16	63	50	45	83	117	9
AM15016HS-2L	2	16	63	50	35	118	152	9
AM15020HS-2	2	20	63	50	60	98	132	9
AM15020HS-3	3	20	63	50	60	98	132	9
AM15020HS-2L	2	20	63	50	50	118	152	9
AM15025HS-3	3	25	63	50	75	113	147	9
AM15025HS-4	4	25	63	50	75	113	147	9
AM15025HS-3L	3	25	63	50	65	133	167	9
AM15032HS-4	4	32	63	50	80	113	147	9
AM15032HS-5	5	32	63	50	80	113	147	9
AM15032HS-4L	4	32	63	50	70	133	167	9
AM15040HS-5	5	40	63	50	60	98	132	9
AM15040HS-6	6	40	63	50	60	98	132	9
AM15040HS-5L	5	40	63	50	50	118	152	9

Available inserts

APMT-MA APMT-ML APMT-MM



Designation	Cermet		Coated											Uncoated		page		
	CN2000	CN30	NCM325	NC5330	NCM535	NCM545	PC2505	PC2510	PC3600	PC3700	PC6510	PC9530	PC9540	PC5300	PC5400		G10	H01
APMT 0903PDFR-MA																	●	E05
090308PDFR-MA																		
0903PDER-ML														●	●			
090308PDER-ML														●	●			
0903PDSR-MM				●			●	●	●	●	●			●	●			
090308PDSR-MM				●					●	●				●	●			
090312R-MM									●	●				●	●			
090316R-MM				●					●	●				●	●			
090320R-MM									●	●				●	●			

Parts

Specification			
Ø16~Ø40	FTKA02565S	TW08S	-

Available inserts E05

BT40 AM2000HS

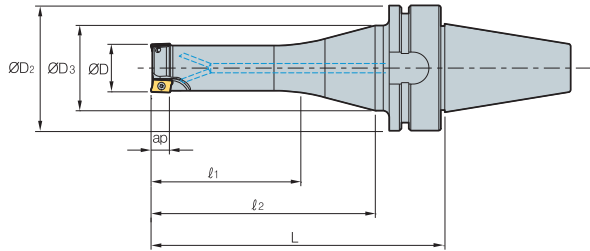

AA 90°
 • AR: 7°~10°
 • RR: -20°~-7°

(mm)

Designation	⊘	ØD	ØD ₂	ØD ₃	ℓ ₁	ℓ ₂	L	ap	
BT40	AM2016HS-2	2	16	63	50	45	83	117	11
	AM2016HS-2L	2	16	63	50	35	118	152	11
	AM2020HS-2	2	20	63	50	60	98	132	11
	AM2020HS-2L	2	20	63	50	50	118	152	11
	AM2025HS-3	3	25	63	50	75	113	147	11
	AM2025HS-3L	3	25	63	50	65	133	167	11
	AM2032HS-4	4	32	63	50	80	113	147	11
	AM2032HS-4L	4	32	63	50	70	133	167	11
	AM2040HS-5	5	40	63	50	60	98	132	11
	AM2040HS-5L	5	40	63	50	50	118	152	11
	AM2050HS-6	6	50	63	50	60	98	132	11
	AM2050HS-6L	6	50	63	50	50	118	152	11

Available inserts



Designation	Cermet		Coated											Uncoated		page		
	CN2000	CN30	NCM825	NC5330	NCM635	NCM645	PC2505	PC2510	PC3600	PC3700	PC6510	PC9530	PC9540	PC5300	PC5400		G10	H01
APMT 11T3PDFR-MA																	●	E05
11T308PDFR-MA																		
11T3PDER-ML														●	●			
11T308PDER-ML														●	●			
11T3PDSR-MM			●	●	●		●	●	●	●	●	●		●	●			
11T3PDSR-MF				●				●	●	●				●	●			
11T308PDSR-MM				●				●	●	●		●	●	●	●			
11T312PDSR-MM				●				●	●			●	●	●	●			
11T316R-MM				●				●	●					●	●			
11T318R-MM								●	●					●	●			
11T324R-MM				●				●	●					●	●			
11T3PDSR-MN2														●				
11T3PDSR-MN3														●				

* Please purchase 2 types of APMT-MN (nick type) inserts with different chip breakers. * Please use the cutters with even teeth.

Parts

Specification	Screw	Wrench
Ø16-Ø50	FTKA02565S	TW08S

Available inserts E05



BT50 AM3000HS

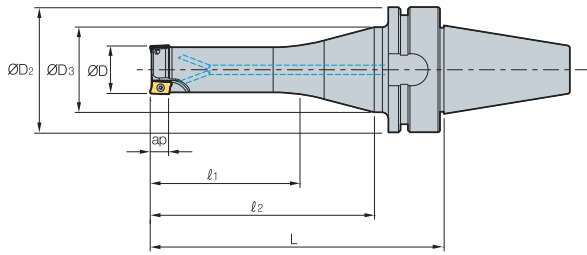

AA
90°
• AR: 7°~10°
• RR: -20°~-7°

(mm)

Designation		ØD	ØD2	ØD3	l1	l2	L	ap	
BT50	AM3025HS-2	2	25	100	80	65	113	158	16
	AM3025HS-2L	2	25	100	80	55	123	168	16
	AM3032HS-3	3	32	100	80	70	113	158	16
	AM3032HS-3L	3	32	100	80	60	123	168	16
	AM3040HS-4	4	40	100	80	50	98	143	16
	AM3040HS-4L	4	40	100	80	40	108	153	16
	AM3050HS-5	5	50	100	80	50	98	143	16
	AM3050HS-5L	5	50	100	80	40	108	153	16

Available inserts

APMT-MA APMT-ML APMT-MM APMT-MF APMT-MN



Designation	Cermet		Coated											Uncoated		page		
	CN2000	CN30	NCM325	NC5330	NCM535	NCM545	PC2505	PC2510	PC3600	PC3700	PC8510	PC9530	PC9540	PC5300	PC5400		G10	H01
APMT 1604PDFR-MA																		●
160404PDFR-MA																		
1604PDER-ML																		●
160404PDER-ML																		●
1604PDSR-MM			●	●	●		●	●	●	●	●	●	●	●	●			
1604PDSR-MF				●				●	●	●				●	●			
160410PDSR-MM								●						●	●			
160416PDSR-MM				●				●	●					●	●			
160424R-MM				●				●	●					●	●			
160430R-MM								●	●					●	●			
160432R-MM				●				●	●					●	●			
1604PDSR-MN3														●				
1604PDSR-MN4														●				

※ Please purchase 2 types of APMT-MN (nick type) inserts with different chip breakers. ※ Please use the cutters with even teeth.

Parts

Specification		
Ø25	FTKA0408	TW15S
Ø32~Ø50	FTKA0410	

Available inserts E05

BT50 AM4000HS

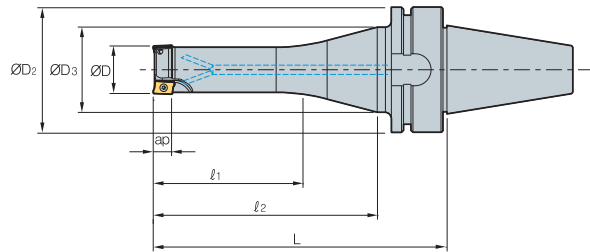

AA
90°
• AR: 7°~10°
• RR: -20°~-7°

(mm)

Designation		ØD	ØD ₂	ØD ₃	l ₁	l ₂	L	ap	
BT50	AM4020HS-1	1	20	100	80	50	98	143	17
	AM4025HS-2	2	25	100	80	65	113	158	17
	AM4032HS-3	3	32	100	80	70	113	158	17
	AM4032HS-3L	3	32	100	80	60	123	168	17
	AM4040HS-4	4	40	100	80	50	98	143	17
	AM4040HS-4L	4	40	100	80	40	108	153	17
	AM4050HS-5	5	50	100	80	50	98	143	17
	AM4050HS-5L	5	50	100	80	40	108	153	17

Available inserts



Designation	Cermet		Coated												Uncoated		page	
	CN2000	CN30	NCM325	NC5330	NCM535	NCM545	PC2505	PC2510	PC3600	PC3700	PC6510	PC9530	PC9540	PC5300	PC5400	G10		H01
APMT 1806PDFR-MA																	●	
180604PDFR-MA																	●	
180612PDFR-MA																	●	
180616PDFR-MA																	●	
180620PDFR-MA																	●	
180624PDFR-MA																	●	
180630R-MA																	●	
1806PDER-ML														●	●			
180604PDER-ML														●	●			
180612PDER-ML														●	●			
180616PDER-ML														●	●			
180620PDER-ML														●	●			
180624PDER-ML														●	●			
180630R-ML														●	●			
1806PDSR-MM				●				●	●	●	●	●	●	●	●			
1806PDSR-MF				●				●	●	●	●	●	●	●	●			
180612PDSR-MM				●				●	●	●	●	●	●	●	●			
180616PDSR-MM				●				●	●	●	●	●	●	●	●			
180620PDSR-MM				●				●	●	●	●	●	●	●	●			
180624PDSR-MM				●				●	●	●	●	●	●	●	●			
180630R-MM				●				●	●	●	●	●	●	●	●			
180632R-MM				●				●	●	●	●	●	●	●	●			
1806PDSR-MN3														●	●			
1806PDSR-MN4														●	●			

E05

* Please purchase 2 types of APMT-MN (nick type) inserts with different chip breakers. * Please use the cutters with even teeth.

Parts

Specification	Screw	Wrench
Ø20~Ø25	FTKA0408	TW15S
Ø32~Ø50	FTKA0410	TW15S

Available inserts E05



HSK63A AM1000HS

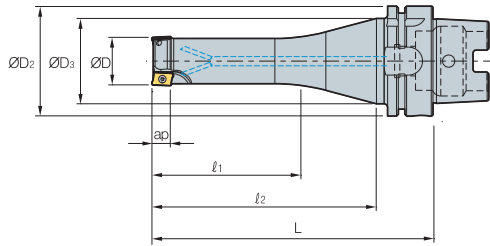

AA
90°
• AR: 7.5°~13°
• RR: -28°~-7°

(mm)

Designation		ØD	ØD ₂	ØD ₃	l ₁	l ₂	L	ap	
HSK63A	AM1010HS-2	2	10	63	53	35	83	116	5.6
	AM1012HS-2	2	12	63	53	35	83	116	5.6
	AM1012HS-3	3	12	63	53	35	83	116	5.6
	AM1016HS-3	3	16	63	53	35	83	116	5.6
	AM1016HS-4	4	16	63	53	35	83	116	5.6
	AM1020HS-4	4	20	63	53	45	98	131	5.6
	AM1020HS-5	5	20	63	53	45	98	131	5.6

Available inserts

APMT-MA APMT-MM



Designation	Cermet		Coated											Uncoated		page		
	CN2000	CN30	NCM325	NC5330	NCM535	NCM545	PC2505	PC2510	PC3600	PC3700	PC6510	PC9530	PC9540	PC5300	PC5400		G10	H01
APMT 0602PDFR-MA																	●	E05
060208PDFR-MA																		
060202PDSR-MM				●					●					●	●			
0602PDSR-MM				●		●	●	●	●	●	●			●	●			
060208PDSR-MM				●					●	●				●	●			
060212R-MM				●					●					●	●			
060216R-MM									●					●	●			

Parts

Specification			
Ø10~Ø20	FTKA01842	-	TW06S-A

Available inserts E05

HSK63A AM1500HS

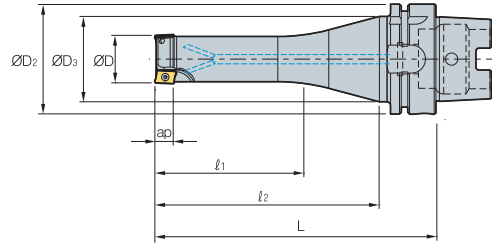

AA
90°
• AR: 7.5°~13°
• RR: -28°~-7°

(mm)

Designation		ØD	ØD2	ØD3	l1	l2	L	ap	
HSK63A	AM15016HS-2	2	16	63	53	45	83	116	9
	AM15016HS-2L	2	16	63	53	35	118	151	9
	AM15020HS-2	2	20	63	53	60	98	131	9
	AM15020HS-3	3	20	63	53	60	98	131	9
	AM15020HS-2L	2	20	63	53	50	118	151	9
	AM15025HS-3	3	25	63	53	75	113	146	9
	AM15025HS-4	4	25	63	53	75	113	146	9
	AM15025HS-3L	3	25	63	53	65	133	166	9
	AM15032HS-4	4	32	63	53	80	113	146	9
	AM15032HS-5	5	32	63	53	80	113	146	9
	AM15032HS-4L	4	32	63	53	70	133	166	9
	AM15040HS-5	5	40	63	53	60	98	131	9
	AM15040HS-6	6	40	63	53	60	98	131	9
	AM15040HS-5L	5	40	63	53	50	118	151	9

Available inserts

APMT-MA APMT-ML APMT-MM



Designation	Cermet		Coated										Uncoated		page			
	CN2000	CN30	NCM325	NC5330	NCM535	NCM545	PC2505	PC2510	PC3600	PC3700	PC6510	PC9530	PC9540	PC5300		PC5400	G10	H01
APMT 0903PDFR-MA																	●	E05
090308PDFR-MA																		
0903PDER-ML														●	●			
090308PDER-ML														●	●			
0903PDSR-MM				●			●	●	●	●	●			●	●			
090308PDSR-MM				●					●	●				●	●			
090312R-MM									●	●				●	●			
090316R-MM				●					●	●				●	●			
090320R-MM									●	●				●	●			

Parts

Specification			
Ø16~Ø40	FTKA02565S	TW08S	-

Available inserts E05



HSK63A AM2000HS

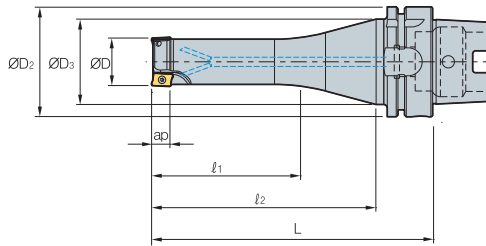

AA
90°
• AR: 7°~10°
• RR: -20°~-7°

(mm)

Designation		ØD	ØD ₂	ØD ₃	l ₁	l ₂	L	ap	
HSK63A	AM2016HS-2	2	16	63	53	45	83	116	11
	AM2016HS-2L	2	16	63	53	35	118	151	11
	AM2020HS-2	2	20	63	53	60	98	131	11
	AM2020HS-2L	2	20	63	53	50	118	151	11
	AM2025HS-3	3	25	63	53	75	113	146	11
	AM2025HS-3L	3	25	63	53	65	133	166	11
	AM2032HS-4	4	32	63	53	80	113	146	11
	AM2032HS-4L	4	32	63	53	70	133	166	11
	AM2040HS-5	5	40	63	53	60	98	131	11
	AM2040HS-5L	5	40	63	53	50	118	151	11
	AM2050HS-6	6	50	63	53	60	98	131	11
	AM2050HS-6L	6	50	63	53	50	118	151	11

Available inserts



Designation	Cermet		Coated											Uncoated		page	
	CN2000	CN30	NCM325	NC5330	NCM535	NCM545	PC2505	PC2510	PC3600	PC3700	PC8510	PC9530	PC9540	PC5300	PC5400		G10
APMT 11T3PDFR-MA																	●
11T308PDFR-MA																	
11T3PDER-ML														●	●		
11T308PDER-ML														●	●		
11T3PDSR-MM			●	●	●		●	●	●	●	●	●		●	●		
11T3PDSR-MF				●				●	●	●				●	●		
11T308PDSR-MM				●				●	●		●	●		●	●		
11T312PDSR-MM				●				●	●		●			●	●		
11T316R-MM				●				●	●					●	●		
11T318R-MM																	
11T324R-MM				●				●	●					●	●		
11T3PDSR-MN2														●			
11T3PDSR-MN3														●			

※ Please purchase 2 types of APMT-MN (nick type) inserts with different chip breakers. ※ Please use the cutters with even teeth.

Parts

Specification	Screw	Wrench
Ø16~Ø50	FTKA02565S	TW08S

Available inserts E05

HSK63A AM3000HS

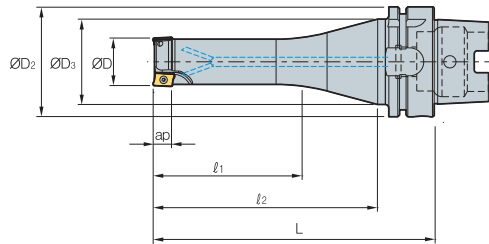

AA
90°
• AR: 7°~10°
• RR: -20°~-7°

(mm)

Designation		ØD	ØD2	ØD3	l1	l2	L	ap	
HSK63A	AM3025HS-2	2	25	63	53	65	113	146	16
	AM3025HS-2L	2	25	63	53	55	123	156	16
	AM3032HS-3	3	32	63	53	70	113	146	16
	AM3032HS-3L	3	32	63	53	60	123	156	16
	AM3040HS-4	4	40	63	53	50	98	131	16
	AM3040HS-4L	4	40	63	53	40	108	141	16
	AM3050HS-5	5	50	63	53	50	98	131	16
	AM3050HS-5L	5	50	63	53	40	108	141	16

Available inserts



Designation	Cermet		Coated											Uncoated		page		
	CN2000	CN30	NCM325	NC5330	NCM635	NCM645	PC2505	PC2510	PC3600	PC3700	PC6510	PC9530	PC9540	PC5300	PC5400		G10	H01
APMT 1604PDFR-MA																		●
160404PDFR-MA																		
1604PDER-ML														●	●			
160404PDER-ML														●	●			
1604PDSR-MM			●	●	●		●	●	●	●	●	●	●	●	●			
1604PDSR-MF				●				●	●	●				●	●			
160410PDSR-MM								●	●					●	●			
160416PDSR-MM				●				●	●					●	●			
160424R-MM				●				●	●					●	●			
160430R-MM								●	●					●	●			
160432R-MM				●				●	●					●	●			
1604PDSR-MN3														●				
1604PDSR-MN4														●				

* Please purchase 2 types of APMT-MN (nick type) inserts with different chip breakers. * Please use the cutters with even teeth.

Parts

Specification		
Ø25 Ø32~Ø50	FTKA0408 FTKA0410	TW15S

Available inserts E05



HSK63A AM4000HS

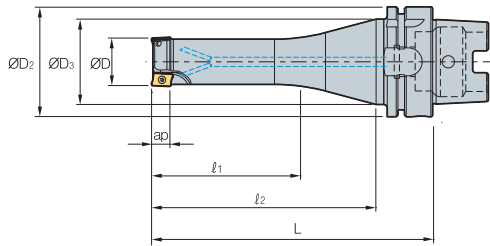

AA 90°
• AR: 7°~10°
• RR: -20°~-7°

(mm)

Designation			$\varnothing D$	$\varnothing D_2$	$\varnothing D_3$	ℓ_1	ℓ_2	L	ap
HSK63A	AM4020HS-1	1	20	63	53	50	98	131	17
	AM4025HS-2	2	25	63	53	65	113	146	17
	AM4032HS-3	3	32	63	53	70	113	146	17
	AM4032HS-3L	3	32	63	53	60	123	156	17
	AM4040HS-4	4	40	63	53	50	98	131	17
	AM4040HS-4L	4	40	63	53	40	108	141	17
	AM4050HS-5	5	50	63	53	50	98	131	17
	AM4050HS-5L	5	50	63	53	40	108	141	17

Available inserts



Designation	Cermet		Coated											Uncoated		page		
	CN2000	CN30	NCM325	NC5330	NCM535	NCM545	PC2505	PC2510	PC3600	PC3700	PC6510	PC9530	PC9540	PC5300	PC5400		G10	H01
APMT 1806PDFR-MA																	•	
180604PDFR-MA																	•	
180612PDFR-MA																	•	
180616PDFR-MA																	•	
180620PDFR-MA																	•	
180624PDFR-MA																	•	
180630R-MA																	•	
1806PDER-ML														•	•			
180604PDER-ML														•	•			
180612PDER-ML														•	•			
180616PDER-ML														•	•			
180620PDER-ML														•	•			
180624PDER-ML														•	•			
180630R-ML														•	•			
1806PDSR-MM				•			•	•	•	•	•	•	•	•	•			
1806PDSR-MF				•					•	•				•	•			
180612PDSR-MM				•					•	•				•	•			
180616PDSR-MM				•					•					•	•			
180620PDSR-MM														•	•			
180624PDSR-MM				•					•					•	•			
180630R-MM									•					•	•			
180632R-MM				•					•					•	•			
1806PDSR-MN3														•	•			
1806PDSR-MN4														•	•			

E05

※ Please purchase 2 types of APMT-MN (nick type) inserts with different chip breakers. ※ Please use the cutters with even teeth.

Parts

Specification		
$\varnothing 20 \sim \varnothing 25$	FTKA0408	
$\varnothing 32 \sim \varnothing 50$	FTKA0410	TW15S

Available inserts E05

BT30/40 AM1000

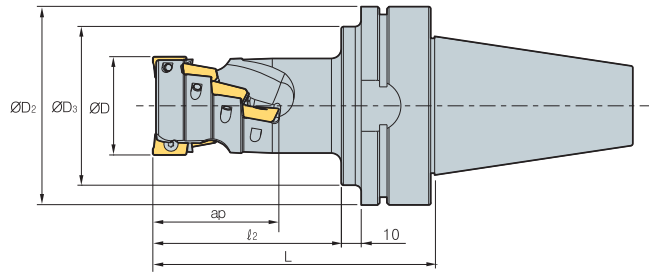

(mm)

Designation		ØD	ØD2	ØD3	l2	L	No. of flute	ap	
BT30	AM1016015-2	6	16	46	41	30	62	2	15.5
	AM1020020-3	12	20	46	41	32	64	3	20.5
	AM1025025-4	20	25	46	41	39	71	4	25.5
BT40	AM1016015-2	6	16	63	50	30	67	2	15.5
	AM1020020-3	12	20	63	50	32	69	3	20.5
	AM1025025-4	20	25	63	50	39	76	4	25.5

Available inserts

APMT-MA APMT-MM



Designation	Cermet		Coated											Uncoated		page		
	CN2000	CN30	NCM825	NC5330	NCM635	NCM645	PC2505	PC2510	PC3600	PC3700	PC6510	PC9530	PC9540	PC5300	PC5400		G10	H01
APMT 0602PDFR-MA																	●	E05
060208PDFR-MA																		
060202PDSR-MM				●						●				●	●			
0602PDSR-MM				●			●	●	●	●	●			●	●			
060208PDSR-MM				●					●	●				●	●			
060212R-MM				●					●					●	●			
060216R-MM									●					●	●			

Caution when clamping the inserts

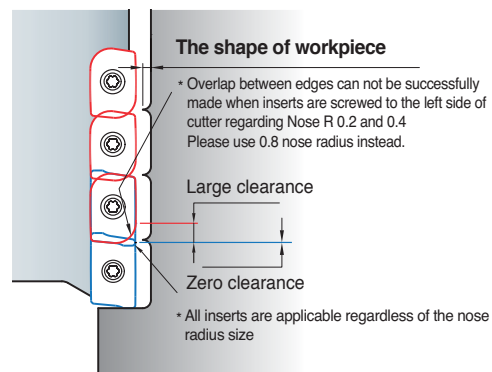

Parts

Specification			
Ø16~Ø25	FTKA01842	-	TW06S-A

Available inserts E05



BT30/40 AM1500

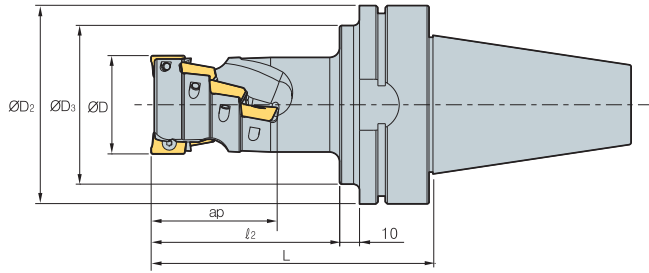

AA
90°
• AR: -12.5°~13°
• RR: -17°~-6°

(mm)

Designation		ØD	ØD2	ØD3	l2	L	No. of flute	ap	
BT30	AM15020026-1	3	20	46	41	42	74	1	26.5
	AM15025035-2	8	25	46	41	50	62	2	35
	AM15032044-2	10	32	46	41	60	92	2	44
BT40	AM15020026-1	3	20	63	50	42	79	1	26.5
	AM15025035-2	8	25	63	50	50	87	2	35
	AM15032044-2	10	32	63	50	60	97	2	44

Available inserts



Designation	Cermet		Coated										Uncoated		page			
	CN2000	CN30	NCM825	NC5330	NCM635	NCM645	PC2505	PC2510	PC3600	PC3700	PC6510	PC9530	PC9540	PC5300		PC5400	G10	H01
APMT 0903PDFR-MA																		●
090308PDFR-MA																		
0903PDER-ML														●	●			
090308PDER-ML														●	●			
0903PDSR-MM				●			●	●	●	●	●			●	●			
090308PDSR-MM				●					●	●				●	●			
090312R-MM									●	●				●	●			
090316R-MM				●					●	●				●	●			
090320R-MM									●	●				●	●			

E05

Caution when clamping the inserts

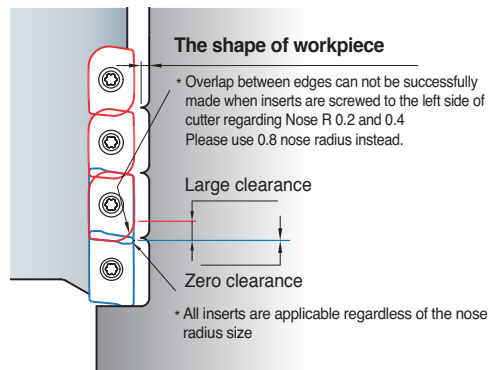

Parts

Specification			
Ø20~Ø32	FTKA02565S	TW08S	-

Available inserts E05

BT30/40 AM2000

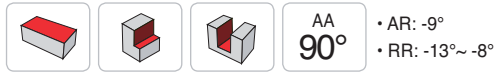
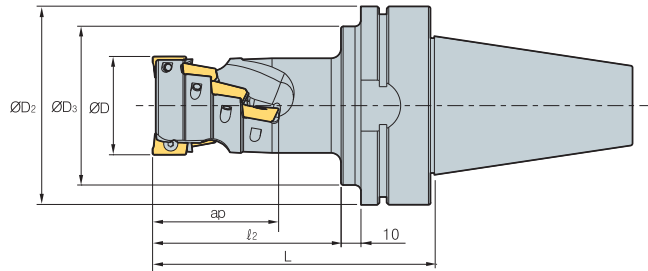

(mm)

Designation		ØD	ØD2	ØD3	l2	L	No. of flute	ap
BT30	AM2020029-1	3	20	46	41	45	77	29.4
	AM2025038-2	8	25	46	45	55	87	38.9
	AM2032048-2	10	32	46	45	65	97	48.5
	AM2040058-2	14	40	46	45	75	107	58
	AM2050039-4	16	50	46	45	58	90	39
	AM2063039-4	16	63	46	45	58	90	39
	AM2080039-5	20	80	46	45	63	95	39
BT40	AM2100039-6	24	100	46	45	63	95	39
	AM2020029-1	3	20	63	50	45	82	29.4
	AM2025038-2	8	25	63	50	55	92	38.9
	AM2032048-2	10	32	63	50	65	102	48.5
	AM2040058-2	14	40	63	50	75	112	58
	AM2050039-4	16	50	63	50	58	95	39
	AM2063039-4	16	63	63	50	58	95	39
	AM2080039-5	20	80	63	50	63	100	39
	AM2100039-6	24	100	63	50	63	100	39

Available inserts



Designation	Cermet		Coated										Uncoated		page			
	CN2000	CN30	NCM325	NC5330	NCM535	NCM545	PC2505	PC2510	PC3600	PC3700	PC6510	PC9530	PC9540	PC5300		PC5400	G10	H01
APMT 11T3PDFR-MA																		
11T308PDFR-MA																		
11T3PDER-ML														●	●			
11T308PDER-ML														●	●			
11T3PDSR-MM			●	●	●		●	●	●	●	●	●		●	●			
11T3PDSR-MF				●				●	●	●	●			●	●			
11T308PDSR-MM				●				●	●		●	●		●	●			
11T312PDSR-MM				●				●	●		●	●		●	●			
11T316R-MM				●				●	●					●	●			
11T318R-MM								●	●					●	●			
11T324R-MM				●				●	●					●	●			
11T3PDSR-MN3														●	●			
11T3PDSR-MN4														●	●			

※ Please purchase 2 types of APMT-MN (nick type) inserts with different chip breakers.
 ※ Please use the cutters with even teeth.

Caution when clamping the inserts

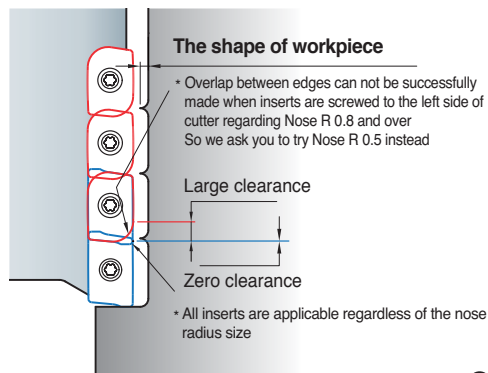

Parts

Specification	Screw	Wrench
Ø20~Ø100	FTKA02565S	TW08S

Available inserts E05



BT50 AM3000

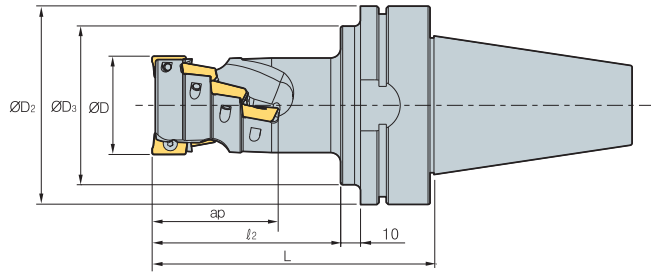

AA
90°
• AR: 13°~15°
• RR: -11°~ -4°

(mm)

Designation	Flute	ØD	ØD2	ØD3	Ø2	L	No. of flute	ap
BT50 AM3050043-2	6	50	100	80	72	120	2	43
AM3063057-4	16	63	100	80	86	134	4	57
AM3080071-4	20	80	100	80	100	148	4	71
AM3100071-6	30	100	100	80	100	148	6	71

Available inserts



Designation	Cermet		Coated											Uncoated		page		
	CN2000	CN30	NCM325	NC5330	NCM535	NCM545	PC2505	PC2510	PC3600	PC3700	PC6510	PC9530	PC9540	PC5300	PC5400		G10	H01
APMT 1604PDFR-MA																		●
160404PDFR-MA																		
1604PDER-ML																		●
160404PDER-ML																		●
1604PDSR-MM			●	●	●		●	●	●	●	●	●	●	●	●			
1604PDSR-MF				●					●	●	●			●	●			
160410PDSR-MM									●	●				●	●			
160416PDSR-MM				●					●	●				●	●			
160424R-MM				●					●	●				●	●			
160430R-MM									●	●				●	●			
160432R-MM				●					●	●				●	●			
1604PDSR-MN3														●	●			
1604PDSR-MN4														●	●			

※ Please purchase 2 types of APMT-MN (nick type) inserts with different chip breakers.
 ※ Please use the cutters with even teeth.

Caution when clamping the inserts

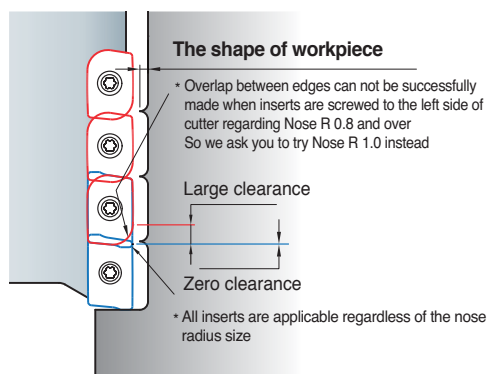

Parts

Specification	Screw	Wrench
Ø50~Ø100	FTKA0410	TW15S

Available inserts E05

BT50 AM4000

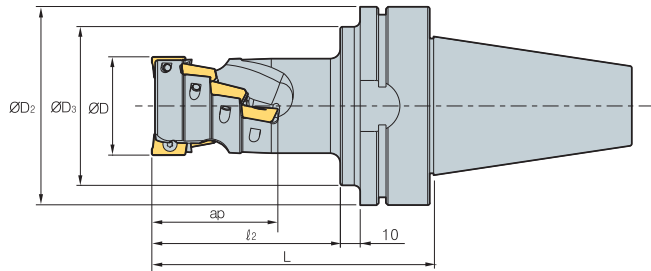

(mm)

Designation		$\varnothing D$	$\varnothing D_2$	$\varnothing D_3$	l_2	L	No. of flute	ap	
BT50	AM4040046-2	6	40	100	80	75	123	2	46
	AM4050061-2	8	50	100	80	95	143	2	61
	AM4063061-4	16	63	100	80	90	138	4	61
	AM4080076-4	20	80	100	80	105	153	4	76
	AM4100076-6	30	100	100	80	105	153	6	76

Available inserts



Designation	Cermet		Coated										Uncoated		page			
	CN2000	CN30	NCM325	NC5330	NCM535	NCM545	PC2505	PC2510	PC3600	PC3700	PC6510	PC9630	PC9540	PC5300		PC5400	G10	H01
APMT																		
1806PDFR-MA																		●
180604PDFR-MA																		●
180612PDFR-MA																		●
180616PDFR-MA																		●
180620PDFR-MA																		●
180624PDFR-MA																		●
180630R-MA																		●
1806PDER-ML														●	●			
180604PDER-ML														●	●			
180612PDER-ML														●	●			
180616PDER-ML														●	●			
180620PDER-ML														●	●			
180624PDER-ML														●	●			
180630R-ML														●	●			
1806PDSR-MM				●			●	●	●	●	●	●	●	●	●			
1806PDSR-MF				●					●	●	●	●	●	●	●			
180612PDSR-MM				●					●	●	●	●	●	●	●			
180616PDSR-MM				●					●	●	●	●	●	●	●			
180620PDSR-MM				●					●	●	●	●	●	●	●			
180624PDSR-MM				●					●	●	●	●	●	●	●			
180630R-MM				●					●	●	●	●	●	●	●			
180632R-MM				●					●	●	●	●	●	●	●			
1806PDSR-MN3													●					
1806PDSR-MN4													●					

E05

※ Please purchase 2 types of APMT-MN (nick type) inserts with different chip breakers.
 ※ Please use the cutters with even teeth.

Caution when clamping the inserts

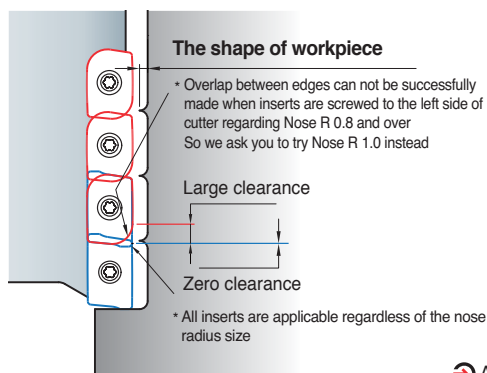

Parts

Specification		
$\varnothing 40\text{--}\varnothing 100$	FTKA0410	TW15S

Available inserts E05



BT50 HAT4000

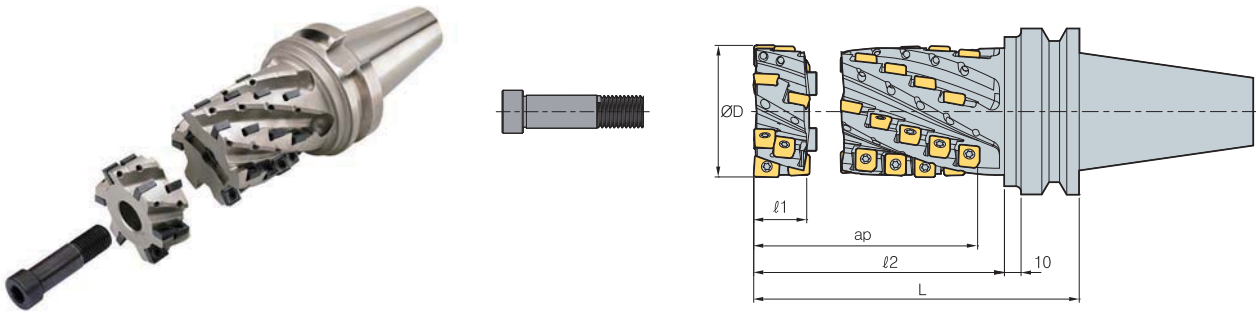

(mm)

Designation			ØD	l1	l2	L	No. of flute	ap	Application	
	SPMT	ZPMT								
BT50- (Set)	HAT4050094-2F	10	1	50	32	119	160	2	94	HAT4050032-2F
	HAT4050104-2F	11	1	50	32	129	170	2	104	
	HAT4050114-2F	12	1	50	32	139	180	2	114	
	HAT4063094-4F	20	2	63	32	119	160	4	94	HAT4063032-4F
	HAT4063104-4F	22	2	63	32	129	170	4	104	
	HAT4063114-4F	24	2	63	32	139	180	4	114	
	HAT4080094-4F	20	2	80	33	119	160	4	94	HAT4080033-4F
	HAT4080104-4F	22	2	80	33	129	170	4	104	
HAT4080114-4F	24	2	80	33	139	180	4	114		
(Front Piece)	HAT4050032-2F	3	1	50	32	-	-	2	-	-
	HAT4063032-4F	6	2	63	32	-	-	4	-	
	HAT4080033-4F	6	2	80	33	-	-	4	-	

Available inserts

SPMT-MM ZPMT-MM





Designation	Cermet		Coated												Uncoated		page	
	CN2000	CN30	NCM325	NC5330	NCM535	NCM545	PC2505	PC2510	PC3600	PC3700	PC6510	PC9530	PC9540	PC5300	PC5400	G10		H01
SPMT 120508-MMN																		E25
ZPMT 1505PPSR-MMN																		E31

Set specification

Set Designation	Designation	Front Piece	Clamping Bolt
HAT4050094-2F	HAT4050062-2F		
HAT4050104-2F	HAT4050072-2F	HAT4050032-2F	HSB1255
HAT4050114-2F	HAT4050082-2F		
HAT4063094-4F	HAT4063062-4F		
HAT4063104-4F	HAT4063072-4F	HAT4063032-4F	HSB1670
HAT4063114-4F	HAT4063082-4F		
HAT4080094-4F	HAT4080061-4F		
HAT4080104-4F	HAT4080071-4F	HAT4080033-4F	HSB1682
HAT4080114-4F	HAT4080081-4F		

Parts

Specification	 Screw	 Wrench
Ø50~Ø80	ETNA0511	TW20

Available inserts E25, E31

HSK63A AM1000

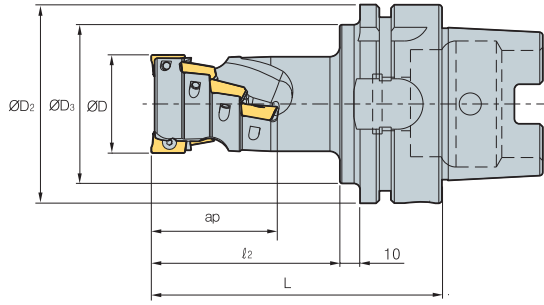

(mm)

Designation		$\varnothing D$	$\varnothing D_2$	$\varnothing D_3$	$\varnothing l_2$	L	No. of flute	ap	
HSK63A	AM1016015-2	6	16	63	53	30	66	2	15.5
	AM1020020-3	12	20	63	53	32	68	3	20.5
	AM1025025-4	20	25	63	53	39	75	4	25.5

Available inserts

APMT-MA APMT-MM



Designation	Cermet		Coated										Uncoated		page			
	CN2000	CN30	NCM325	NC5330	NCM635	NCM545	PC2505	PC2510	PC3600	PC3700	PC6510	PC9530	PC9540	PC5300		PC5400	G10	H01
APMT 0602PDFR-MA																		●
060208PDFR-MA																		
060202PDSR-MM				●						●				●	●			
0602PDSR-MM				●			●	●	●	●	●	●		●	●			
060208PDSR-MM				●					●	●				●	●			
060212R-MM				●					●	●				●	●			
060216R-MM									●	●				●	●			

Parts

Specification			
$\varnothing 16\sim\varnothing 25$	FTKA01842	-	TW06S-A

Caution when clamping the inserts

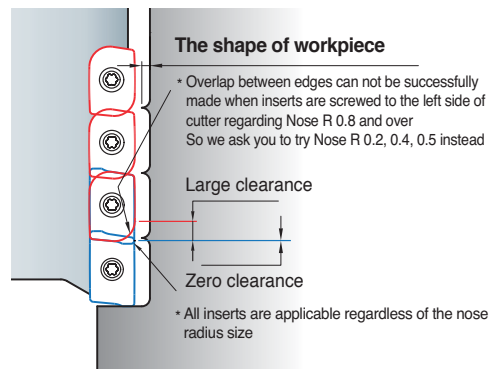

Available inserts E05



HSK63A AM1500

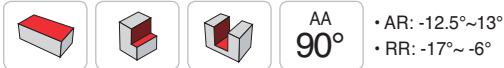
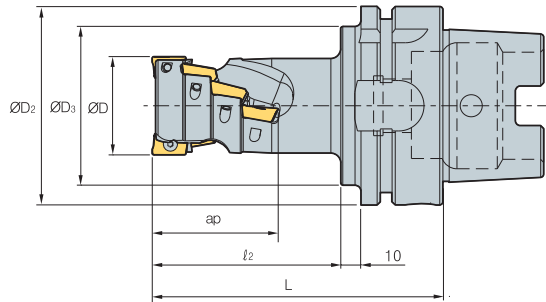

(mm)

Designation		ØD	ØD ₂	ØD ₃	l ₂	L	No. of flute	ap
HSK63A AM15020026-1	3	20	63	53	42	78	1	26.5
AM15025035-2	8	25	63	53	50	86	2	35
AM15032044-2	10	32	63	53	60	96	2	44

Available inserts

APMT-MA APMT-ML APMT-MM



Designation	Cermet		Coated											Uncoated		page		
	CN2000	CN30	NCM325	NC5330	NCM535	NCM545	PC2505	PC2510	PC3600	PC3700	PC6510	PC9530	PC9540	PC5300	PC5400		G10	H01
APMT 0903PDFR-MA																		●
090308PDFR-MA																		
0903PDER-ML														●	●			
090308PDER-ML														●	●			
0903PDSR-MM				●			●	●	●	●	●			●	●			
090308PDSR-MM				●					●	●	●			●	●			
090312R-MM									●	●	●			●	●			
090316R-MM				●					●	●	●			●	●			
090320R-MM									●	●	●			●	●			

Parts

Specification			
Ø20~Ø32	FTKA02565S	TW08S	-

Available inserts E05

Caution when clamping the inserts

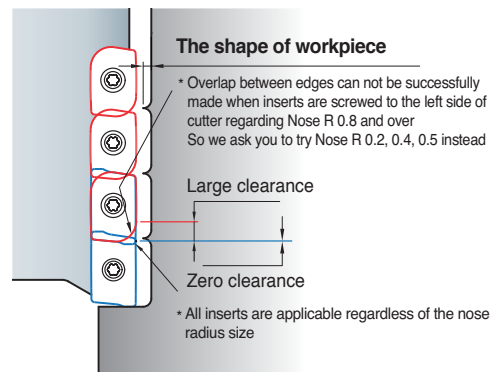

HSK63A AM2000

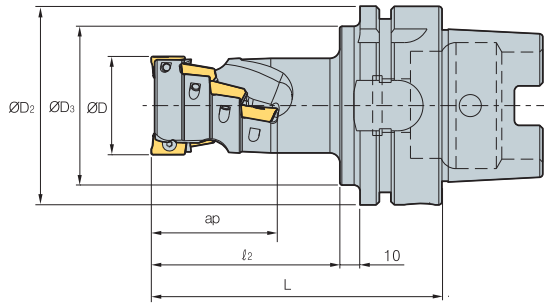

(mm)

Designation	Flutes	ØD	ØD ₂	ØD ₃	l ₂	L	No. of flute	ap
HSK63A	AM2020029-1	3	20	63	53	45	81	29.4
	AM2025038-2	8	25	63	53	55	91	38.9
	AM2032048-2	10	32	63	53	65	101	48.5
	AM2040058-2	14	40	63	53	75	111	58
	AM2050039-4	16	50	63	53	58	94	39
	AM2063039-4	16	63	63	53	58	94	39
	AM2080039-5	20	80	63	53	63	99	39
	AM2100039-6	24	100	63	53	63	99	39

Available inserts

APMT-MA APMT-ML APMT-MM APMT-MF APMT-MN



Designation	Cermet		Coated											Uncoated		page		
	CN2000	CN30	NCM325	NC5330	NCM535	NCM545	PC2505	PC2510	PC3600	PC3700	PC6510	PC9530	PC9540	PC5300	PC5400		G10	H01
APMT 11T3PDFR-MA																		●
11T308PDFR-MA																		
11T3PDER-ML														●	●			
11T308PDER-ML														●	●			
11T3PDSR-MM			●	●	●		●	●	●	●	●	●		●	●			
11T3PDSR-MF				●				●	●	●				●	●			
11T308PDSR-MM				●				●	●	●				●	●			
11T312PDSR-MM				●				●	●	●				●	●			
11T316R-MM				●				●	●					●	●			
11T318R-MM				●				●	●					●	●			
11T324R-MM				●				●	●					●	●			
11T3PDSR-MN3														●				
11T3PDSR-MN4														●				

※ Please purchase 2 types of APMT-MN (nick type) inserts with different chip breakers.
 ※ Please use the cutters with even teeth.

Caution when clamping the inserts

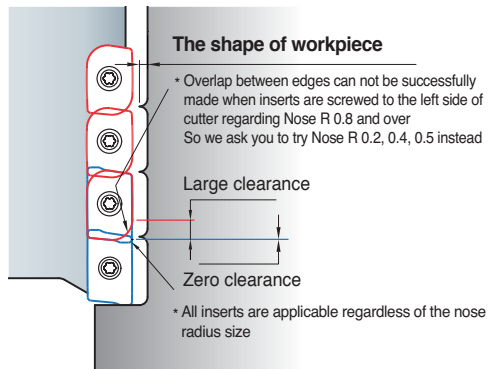

Parts

Specification	Screw	Wrench
Ø20~Ø100	FTKA02565S	TW08S

Available inserts E05



HSK100A AM3000

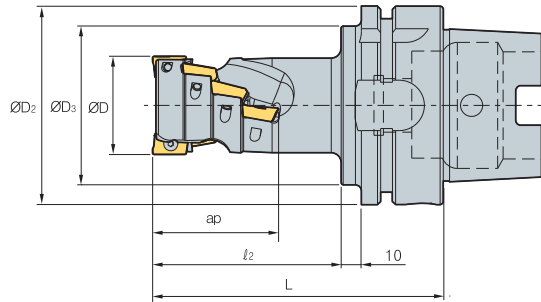

(mm)

Designation		ØD	ØD ₂	ØD ₃	l ₂	L	No. of flute	ap
HSK100A AM3050043-2	6	50	100	88	72	111	2	43
AM3063057-4	16	63	100	88	86	125	4	57
AM3080071-4	20	80	100	88	100	139	4	71
AM3100071-6	30	100	100	88	100	139	6	71

Available inserts



Designation	Cermet		Coated										Uncoated		page			
	CN2000	CN30	NCM325	NC5330	NCM535	NCM545	PC2505	PC2510	PC3600	PC3700	PC6510	PC9530	PC9540	PC5300		PC5400	G10	H01
APMT 1604PDFR-MA																	●	E05
160404PDFR-MA																		
1604PDER-ML														●	●			
160404PDER-ML														●	●			
1604PDSR-MM			●	●	●		●	●	●	●	●	●	●	●	●			
1604PDSR-MF				●				●	●	●				●	●			
160410PDSR-MM								●	●	●				●	●			
160416PDSR-MM				●				●	●	●				●	●			
160424R-MM				●				●	●	●				●	●			
160430R-MM								●	●	●				●	●			
160432R-MM				●				●	●	●				●	●			
1604PDSR-MN3														●	●			
1604PDSR-MN4														●	●			

※ Please purchase 2 types of APMT-MN (nick type) inserts with different chip breakers.
 ※ Please use the cutters with even teeth.

Caution when clamping the inserts

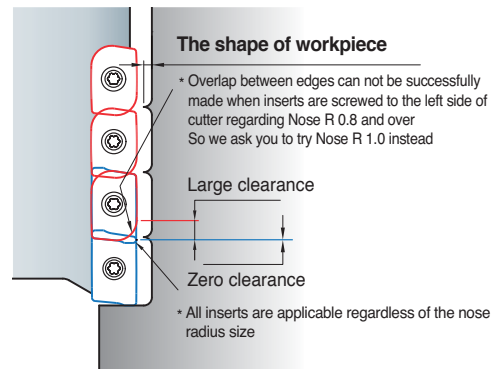

Parts

Specification		
Ø50~Ø100	FTKA0410	TW15S

Available inserts E05

HSK100A AM4000

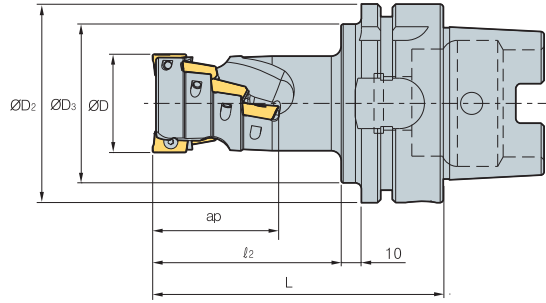

(mm)

Designation		$\varnothing D$	$\varnothing D_2$	$\varnothing D_3$	l_2	L	No. of flute	ap
HSK100A	AM4040046-2	6	40	100	88	75	114	46
	AM4050061-2	8	50	100	88	95	134	61
	AM4063061-4	16	63	100	88	90	129	61
	AM4080076-4	20	80	100	88	105	144	76
	AM4100076-6	30	100	100	88	105	144	76

Available inserts



Designation	Material										page	Designation	Material										page														
	Cermet		Coated						Uncoated				Cermet		Coated						Uncoated																
	CN2000	CN30	NCM325	NC5330	NCM535	NCM545	PC2505	PC2010	PC3600	PC3700	PC6510	PC9530	PC9540	PC5300	PC5400	G10	H01		CN2000	CN30	NCM325	NC5330	NCM535	NCM545	PC2505	PC2510	PC3600	PC3700	PC6510	PC9530	PC9540	PC5300	PC5400	G10	H01		
APMT 1806PDFR-MA																	●	APMT 180624PDER-ML															●	E05	E05		
180604PDFR-MA																	●	180630R-ML															●				
180612PDFR-MA																	●	1806PDSR-MM			●		●	●	●	●	●	●	●	●	●	●	●				
180616PDFR-MA																	●	1806PDSR-MF			●		●		●		●		●		●		●			●	
180620PDFR-MA																	●	180612PDSR-MM			●		●		●		●		●		●		●			●	
180624PDFR-MA																	●	180616PDSR-MM			●		●		●		●		●		●		●			●	
180630R-MA																	●	180620PDSR-MM			●		●		●		●		●		●		●			●	
1806PDER-ML																	●	180624PDSR-MM			●		●		●		●		●		●		●			●	
180604PDER-ML																	●	180630R-MM			●		●		●		●		●		●		●			●	
180612PDER-ML																	●	180632R-MM			●		●		●		●		●		●		●			●	
180616PDER-ML																	●	1806PDSR-MN3																		●	
180620PDER-ML																	●	1806PDSR-MN4																			●

※ Please purchase 2 types of APMT-MN (nick type) inserts with different chip breakers.
 ※ Please use the cutters with even teeth.

Caution when clamping the inserts

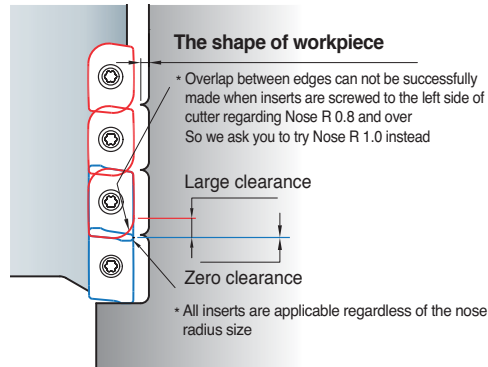

Parts

Specification	Screw	Wrench
$\varnothing 40 \sim \varnothing 100$	FTKA0410	TW15S

Available inserts E05



BT30/BT40/BT50

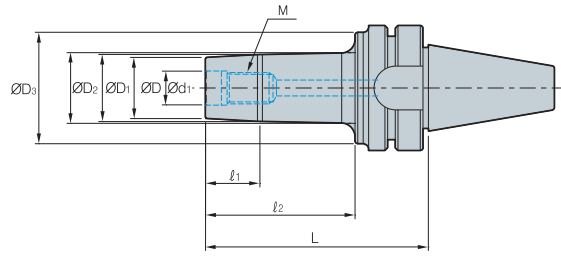

(mm)

Designation	ØD	ØD1	ØD2	ØD3	Ød1	ℓ1	ℓ2	L	M	
BT30-	MAT-M06-053	11	11.7	13	30	6.5	5	21	53	M06*1.0
	MAT-M08-057	14.5	15.7	17.5	35	8.5	7	25	57	M08*1.25
	MAT-M10-062	18	19.7	24	38	10.5	7	30	62	M10*1.5
	MAT-M12-067	23	24.7	27.5	41	12.5	10	35	67	M12*1.75
	MAT-M16-067	29	31.7	33.5	41	17	10	35	67	M16*2.0
BT40-	MAT-M06-062	11	11.7	14	40	6.5	5	25	62	M06*1.0
	MAT-M06-077	11	11.7	14	40	6.5	5	40	77	M06*1.0
	MAT-M06-092	11	11.7	14	40	6.5	5	55	92	M06*1.0
	MAT-M08-067	14.5	15.7	19	44	8.5	7	30	67	M08*1.25
	MAT-M08-082	14.5	15.7	19	44	8.5	7	45	82	M08*1.25
	MAT-M08-097	14.5	15.7	19	44	8.5	7	60	97	M08*1.25
	MAT-M10-072	18	19.7	23	50	10.5	10	35	72	M10*1.5
	MAT-M10-087	18	19.7	23	50	10.5	10	50	87	M10*1.5
	MAT-M10-102	18	19.7	23	50	10.5	10	65	102	M10*1.5
	MAT-M12-077	23	24.7	30	55	12.5	10	40	77	M12*1.75
	MAT-M12-092	23	24.7	30	55	12.5	13	55	92	M12*1.75
	MAT-M12-107	23	24.7	30	55	12.5	13	70	107	M12*1.75
	MAT-M16-077	29	31.7	37	55	17	13	40	77	M16*2.0
	MAT-M16-092	29	31.7	37	55	17	13	55	92	M16*2.0
	MAT-M16-107	29	31.7	37	55	17	13	70	107	M16*2.0
BT50-	MAT-M06-083	11	11.7	15	40	6.5	5	35	83	M06*1.0
	MAT-M06-098	11	11.7	15	40	6.5	5	50	98	M06*1.0
	MAT-M06-113	11	11.7	15	40	6.5	5	65	113	M06*1.0
	MAT-M08-088	14.5	15.7	20	45	8.5	7	40	88	M08*1.25
	MAT-M08-103	14.5	15.7	20	45	8.5	7	55	103	M08*1.25
	MAT-M08-118	14.5	15.7	20	45	8.5	7	70	118	M08*1.25
	MAT-M10-093	18	19.7	25	55	10.5	10	45	93	M10*1.5
	MAT-M10-113	18	19.7	25	55	10.5	10	65	113	M10*1.5
	MAT-M10-128	18	19.7	25	55	10.5	10	80	128	M10*1.5
	MAT-M12-103	23	24.7	33	65	12.5	10	55	103	M12*1.75
	MAT-M12-118	23	24.7	33	65	12.5	13	70	118	M12*1.75
	MAT-M12-133	23	24.7	33	65	12.5	13	85	133	M12*1.75
	MAT-M16-103	29	31.7	41	85	17	13	55	103	M16*2.0
	MAT-M16-118	29	31.7	41	85	17	13	70	118	M16*2.0
	MAT-M16-133	29	31.7	41	85	17	13	85	133	M16*2.0

➔ Available modular E42, E43

HSK63A/HSK100A

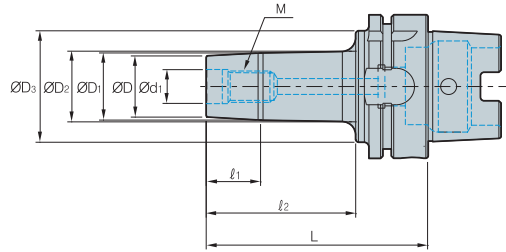

(mm)

Designation	ØD	ØD1	ØD2	ØD3	Ød1	ℓ1	ℓ2	L	M	
HSK63A-	MAT-M06-061	11	11.7	27	40	6.5	5	25	61	M06*1.0
	MAT-M06-076	11	11.7	27	40	6.5	5	40	76	M06*1.0
	MAT-M06-091	11	11.7	27	40	6.5	5	55	91	M06*1.0
	MAT-M08-066	14.5	15.7	30.5	44	8.5	7	30	66	M08*1.25
	MAT-M08-081	14.5	15.7	30.5	44	8.5	7	45	81	M08*1.25
	MAT-M08-096	14.5	15.7	30.5	44	8.5	7	60	96	M08*1.25
	MAT-M10-071	18	19.7	34	50	10.5	10	35	71	M10*1.5
	MAT-M10-086	18	19.7	34	50	10.5	10	50	86	M10*1.5
	MAT-M10-101	18	19.7	34	50	10.5	10	65	101	M10*1.5
	MAT-M12-076	23	24.7	36.5	55	12.5	10	40	76	M12*1.75
	MAT-M12-091	23	24.7	36.5	55	12.5	13	55	91	M12*1.75
	MAT-M12-106	23	24.7	36.5	55	12.5	13	70	106	M12*1.75
	MAT-M16-076	29	31.7	38.5	55	17	13	40	76	M16*2.0
	MAT-M16-091	29	31.7	38.5	55	17	13	55	91	M16*2.0
MAT-M16-106	29	31.7	38.5	55	17	13	70	106	M16*2.0	
HSK100A-	MAT-M06-074	11	11.7	15	40	6.5	5	35	74	M06*1.0
	MAT-M06-089	11	11.7	15	40	6.5	5	50	89	M06*1.0
	MAT-M06-104	11	11.7	15	40	6.5	5	65	104	M06*1.0
	MAT-M08-079	14.5	15.7	20	45	8.5	7	40	79	M08*1.25
	MAT-M08-094	14.5	15.7	20	45	8.5	7	55	94	M08*1.25
	MAT-M08-109	14.5	15.7	20	45	8.5	7	70	109	M08*1.25
	MAT-M10-084	18	19.7	25	55	10.5	10	45	84	M10*1.5
	MAT-M10-104	18	19.7	25	55	10.5	10	65	104	M10*1.5
	MAT-M10-119	18	19.7	25	55	10.5	10	80	119	M10*1.5
	MAT-M12-094	23	24.7	33	65	12.5	10	55	94	M12*1.75
	MAT-M12-109	23	24.7	33	65	12.5	13	70	109	M12*1.75
	MAT-M12-124	23	24.7	33	65	12.5	13	85	124	M12*1.75
	MAT-M16-094	29	31.7	41	85	17	13	55	94	M16*2.0
	MAT-M16-109	29	31.7	41	85	17	13	70	109	M16*2.0
	MAT-M16-124	29	31.7	41	85	17	13	85	124	M16*2.0

Available modular E42, E43



Rigid body employs high tensile aluminum

Future Mill

- Light-weight aluminum body (50% of steel body) can be used for high speed cutting, tapping center, and on low power machines
- Easy handling
- It can be used for aluminum alloys, medium cutting of steel, and cast iron
- Rigid body employs high tensile aluminum
- Locators for excellent durability
- A variety of chip breaker are available
- The high rake angle provides low cutting loads and good surface roughness

Features of cutter

- Strong clamping between aluminum body and locator with double screw provides high efficiency
- Acute angle of locator seat provides strong clamping
- Wide chip pocket area provides good chip evacuation
- High tensile strength aluminum body

Assembly structure of cutter

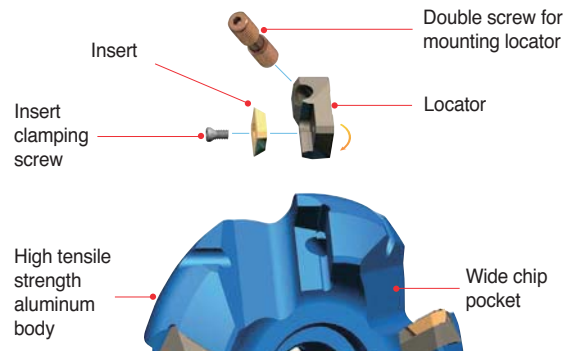

Locator

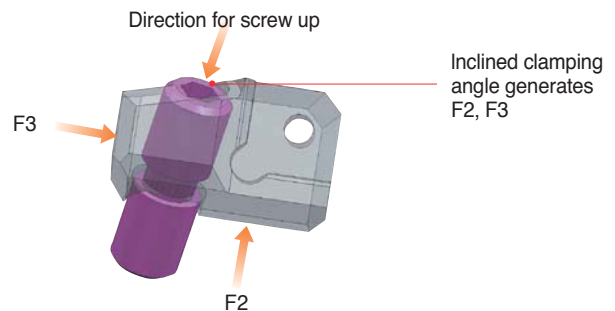
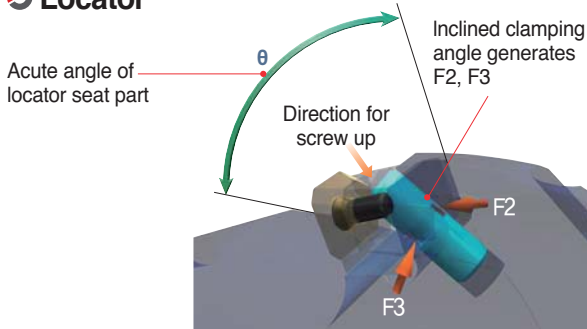

Through coolant system

- Exclusively designed coolant bolt and cover provide excellent coolant action and chip evacuation for improved tool life
- Exact coolant direction to cutting area
- Exclusive coolant bolt and cover are sold separately. Through coolant arbor is required

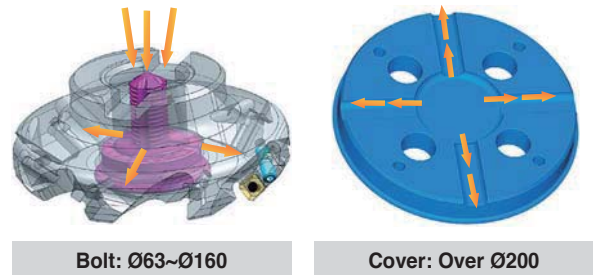

Application range as per workpiece

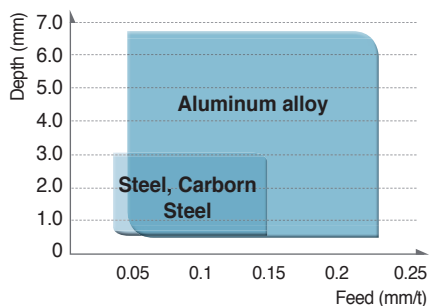

Cutting speed

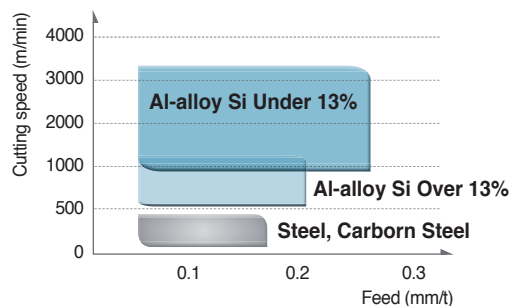

Max. available revolution

Cutter diameter	Max. revolution
Ø63	20,000
Ø80	16,000
Ø100	13,000
Ø125	10,000
Ø160	8,000
Ø200	6,500
Ø250	5,000
Ø315	4,000

Future Mill (FMA)

Features

- General milling cutter for high productivity
- Adjustable pitch of cutter and various chip breaker offer wide application range.
- Light cutter body allows high speed cutting and can be used in low horse power machine
- Smooth cutting with low cutting load is accomplished with high-rake angle

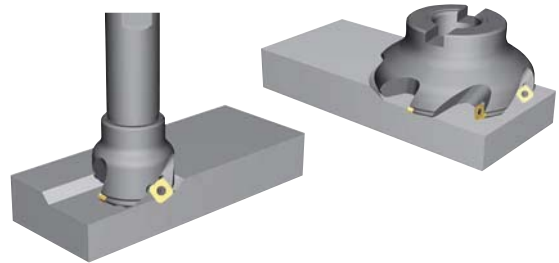

Features of chip breaker

Insert	Cutting-edge	Uses	Features
None C/B		Light cutting	Superior surface roughness at finishing due to ground type cermet insert
MF		Light cutting	Superior cutting quality for light and difficult-to-cut material machining through the low cutting load of chip breaker
MM		General cutting	Suitable for various cutting due to special shape design for general cutting
MR		Roughing	Tough cutting-edge provides stable cutting performance in severe interruption
MA		For aluminum	Superior cutting quality for aluminum due to sharp cutting-edge and buffed surface - S□ET-MA: Sharp cutting-edge due to high accurate grinding - S□XT-MA: Suitable cutting-edge for roughing

Recommended cutting condition

ISO	Grades	vc (m/min)	MF	MM	MR	MA
			fz (mm/t)	fz (mm/t)	fz (mm/t)	fz (mm/t)
P	NC5330	210~350	0.05~0.20	0.10~0.30	0.10~0.30	-
	NCM325	190~310	0.05~0.20	0.10~0.30	0.10~0.30	-
	PC3500	160~270	0.05~0.20	0.10~0.30	0.10~0.30	-
M	PC9530	90~150	0.05~0.15	0.10~0.30	-	-
	NCM335	70~120	0.05~0.15	0.10~0.30	-	-
K	PC5300	110~180	0.05~0.20	0.10~0.30	-	-
N	H01	260~440	-	-	-	0.10~0.35



Future Mill (FMP)

Features

- The strong cutting-edge ensures excellent tool life in high feed and high speed, deep depth of cut, with low cutting loads
- Optimal grades for most workpieces make high efficiency cutting possible
- Unique chip breaker makes good chip evacuation and lower cutting loads (1)
- Innovative curve cutting-edge lowers cutting load and provides a stronger cutting-edge (2)

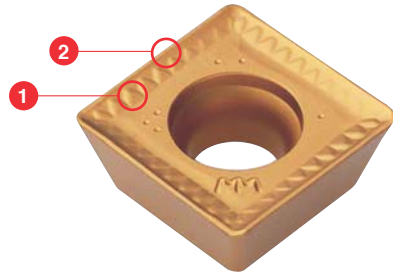

Machining examples

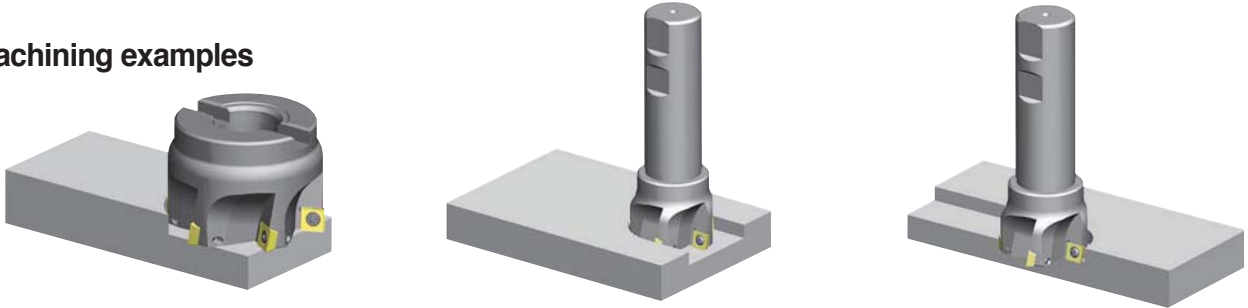

Features of chip breaker

- Innovative special cutting-edge and chip breaker design ensures ideal 90° cutting and low cutting load
- Various applications are available with multi functional cutters (Facing, Slotting, Shouldering)
- Improved tool life due to special coated grades
- Superior cutting quality at deep cutting depth through the low cutting load and strong cutting-edge

Recommended C/B and grade as per workpiece

Insert	Cutting-edge	Uses	Recommended C/B and grade as per workpiece (●: 1st)										
			Low carbon steel/Mild steel		High carbon steel/Mild steel		Stainless steel		Cast iron		Aluminum alloy		
			C/B	Grades	C/B	Grades	C/B	Grades	C/B	Grades	C/B	Grades	
MF			Low cutting load type	●	○ NCM325 ○ NC5330 ● NCM335		● NCM325 ○ NC5330 ○ NCM335	●	○ NCM325 ○ NC5330 ● NCM335	●	● PC6510 ○ PC215K	-	-
MM			Reinforced cutting edge type		○ NCM325 ○ NC5330 ● NCM335		● NCM325 ○ NC5330 ○ NCM335		○ NCM325 ○ NC5330 ● NCM335		● PC6510 ○ PC215K	-	-
MA			Sharp cutting edge type	-	-	-	-	-	-	-	-	●	● H01 ○ G10

Recommended cutting condition

ISO	Cutting Speed vc (m/min)								
	CVD Coated		PVD Coated						Carbide
	NCM325	NCM335	PC3500	PC3600	PC6510	PC5300	PC9530	PC5400	H01
P	190~310	180~290	160-270	160-270	-	150-240	-	130-210	-
M	110~180	100~160	-	-	-	90-150	90-150	70-120	-
K	-	-	-	-	140-230	120-200	-	100-160	-
N	-	-	-	-	-	-	-	-	260-440

Future Mill (FMR)

Features

- Wide coverage for medium to roughing, general steel to high hardness mold materials
- 2 step shape of insert provides strong clamping and can minimize components to replace the shim
- 4-8 cutting-edge available per insert (Inscribed circle 05, 06, 07, 08, 10, 12, 16, 20)
- Uneven flute spacing prevents vibration on high speed applications and provides more stable machining
- Precise design of the insert seat prevents insert from chattering
- Special design of the insert bottom prevents movement and chatter of insert
- Easy to change cutting-edge due to the rotation prevention design of the insert

Machining examples

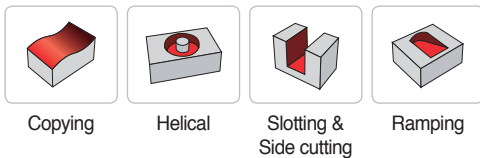

FMR Insert cutting-edge shape

Designation	RDHW□□□□M0F	RDHW□□□□M0E	RDHW□□□□M0S
Cutting edge shape (G calss)			

Features of chip breaker

Insert	Cutting-edge	Uses	Features
MF		Finishing	Low cutting resistance chip breaker design guarantees long tool life good performance at finishing and difficult-to-cut material machining
MM		Medium	Suitable for general milling at wide application range
MA		Aluminum	Sharp cutting-edge and buffed top face for aluminum machining prevent welding and control chip flow

Clamping system

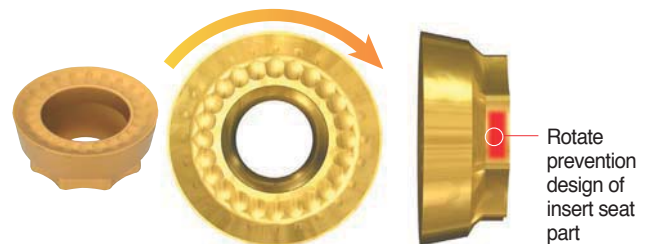
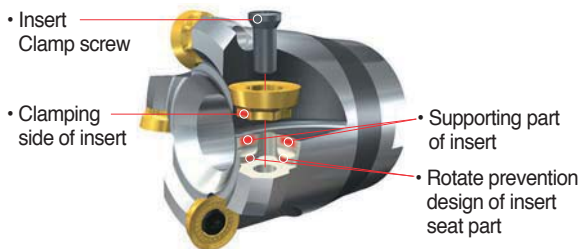

FMR□3000 type
FMR□4000 type

FMR□5000 type
FMR□6000 type

RDKT10T3M0-□□
RDKT1204M0-□□

RDKT1605M0-MM
RDKT2006M0-MM

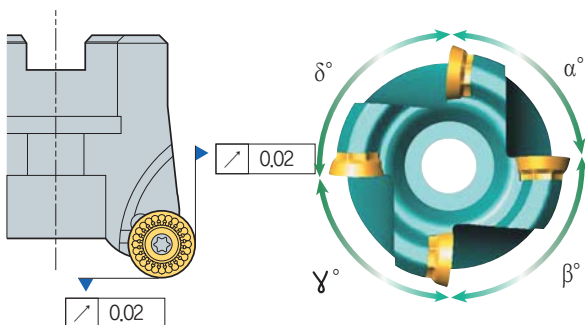

Good surface finish due to the precise design of insert seat part of cutter

Uneven flute spacing prevents vibration at high speed application and provides stable machining

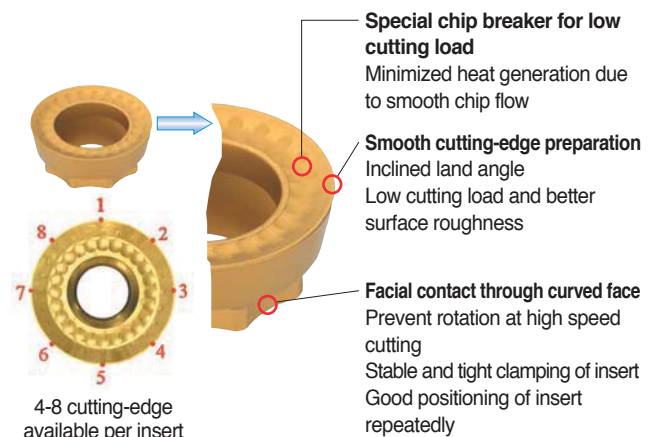

Future Mill (FMR)

Chip removal rate (cm³/min)

Workpiece	Grades	Ø8	Ø10	Ø12	Ø15	Ø16	Ø20	Ø21	Ø25	Ø26	Ø32	Ø33	Ø40	Ø50	Ø63	Ø80	Ø100	Ø125	Ø160	
P General structure steel (under 200HB) General carbon steel (under 30 HRC) High carbon steel, Alloy steel (30~40 HRC) High carbon steel, Alloy steel (40~50 HRC) Alloy steel (over 50 HRC)	PC3500 PC5300	4.97	9.94	9.94	14.92	31.83	31.83	47.74	47.74	47.74	71.61	38.19	95.49	119.36	143.23	167.11	190.98	133.69	509.29	
		vc = 250, fz = 0.25, ap = 0.5, ae = 0.5D		vc = 300, fz = 0.4, ap = 1.0, ae = 0.5D		vc = 250, fz = 0.4, ap = 1.5, ae = 0.5D														vc = 200, fz = 0.5, ap = 4.0, ae = 0.5D
		3.97	7.95	7.95	11.93	25.46	25.46	38.19	38.19	38.19	57.29	38.19	76.39	95.49	114.59	133.69	152.78	133.69	458.36	
		vc = 200, fz = 0.25, ap = 0.5, ae = 0.5D		vc = 250, fz = 0.4, ap = 1.0, ae = 0.5D		vc = 200, fz = 0.4, ap = 1.5, ae = 0.5D														vc = 180, fz = 0.5, ap = 4.0, ae = 0.5D
		2.86	5.72	5.72	8.59	22.91	22.91	34.37	34.37	34.37	51.56	34.37	68.75	85.94	103.13	120.32	137.5	120.32	407.43	
		vc = 180, fz = 0.20, ap = 0.5, ae = 0.5D		vc = 200, fz = 0.4, ap = 1.0, ae = 0.5D		vc = 180, fz = 0.4, ap = 1.5, ae = 0.5D														vc = 160, fz = 0.5, ap = 4.0, ae = 0.5D
		1.24	2.48	2.48	3.72	11.45	11.45	14.32	17.18	14.32	21.48	14.32	28.64	35.8	42.97	50.13	57.29	50.13	249.55	
		vc = 130, fz = 0.15, ap = 0.4, ae = 0.5D		vc = 170, fz = 0.3, ap = 0.9, ae = 0.5D		vc = 150, fz = 0.3, ap = 1.0, ae = 0.5D														vc = 140, fz = 0.4, ap = 3.0, ae = 0.5D
		0.95	1.9	1.9	2.86	7.63	7.63	9.54	11.45	9.54	14.32	9.54	19.09	23.87	28.64	33.42	38.19	33.42	152.78	
		vc = 100, fz = 0.15, ap = 0.4, ae = 0.5D		vc = 130, fz = 0.3, ap = 0.9, ae = 0.5D		vc = 100, fz = 0.3, ap = 1.0, ae = 0.5D														vc = 100, fz = 0.4, ap = 3.0, ae = 0.5D
M Stainless steel	PC5300	2.06	4.13	4.13	6.2	16.55	16.55	12.41	24.82	12.41	18.62	12.41	24.82	31.03	37.24	43.44	49.65	43.44	331.04	
		vc = 130, fz = 0.20, ap = 0.5, ae = 0.5D		vc = 200, fz = 0.2, ap = 1.0, ae = 0.5D		vc = 100, fz = 0.3, ap = 1.0, ae = 0.5D														vc = 130, fz = 0.5, ap = 4.0, ae = 0.5D
K Cast iron	PC5300	2.86	5.72	5.72	8.59	14.32	14.32	21.48	21.48	21.48	32.22	21.48	42.97	53.71	64.45	75.2	85.94	75.2	366.69	
		vc = 180, fz = 0.20, ap = 0.5, ae = 0.5D		vc = 180, fz = 0.2, ap = 1.0, ae = 0.5D		vc = 180, fz = 0.2, ap = 1.5, ae = 0.5D														vc = 180, fz = 0.4, ap = 4.0, ae = 0.5D

Required machine power (P_{KW} = 0.75 x P_{HP})

• RDKT10

Workpiece	Grades	Ø21	Ø25	Ø26	Ø32	Ø40	Ø50	Ø63	Ø80	Ø100	Cutting condition			
											vc	fz	ap	ae
P General structure steel (under 200HB) General carbon steel (under 30 HRC) High carbon steel, Alloy steel (30~40 HRC) High carbon steel, Alloy steel (40~50 HRC) Alloy steel (over 50 HRC)	PC3500 PC5300	2.2	2.2	2.2	3.3	4.4	5.5	6.6	7.7	8.8	250	0.4	1.5	0.5D
		2.1	2.1	2.1	3.1	4.1	5.2	6.2	7.3	8.3	200	0.4	1.5	0.5D
		2.2	2.2	2.2	3.3	4.5	5.6	6.7	7.9	9	180	0.4	1.5	0.5D
		1.1	1.1	1.1	1.6	2.1	2.6	3.2	3.7	4.2	150	0.3	1.0	0.5D
		0.7	0.7	0.7	1.1	1.4	1.7	2.1	2.4	2.8	100	0.3	1.0	0.5D
M Stainless steel	PC5300	0.6	0.6	0.6	0.8	1.2	1.5	1.7	2	2.3	130	0.2	1.5	0.5D
K Cast iron	PC5300	0.6	0.6	0.6	0.9	1.2	1.5	1.8	2.1	2.4	180	0.2	1.5	0.5D

• The figures in the above chart means Php value.

• RDKT12

Workpiece	Grades	Ø32	Ø33	Ø40	Ø50	Ø63	Ø80	Ø100	Ø125	Cutting condition			
										vc	fz	ap	ae
P General structure steel (under 200HB) General carbon steel (under 30 HRC) High carbon steel, Alloy steel (30~40 HRC) High carbon steel, Alloy steel (40~50 HRC) Alloy steel (over 50 HRC)	PC3500 PC5300	1.7	1.7	2.6	3.5	3.5	4.4	5.3	6.1	200	0.4	1.5	0.5D
		2	2	3.1	4.1	2.6	5.2	6.2	7.2	180	0.4	1.5	0.5D
		2.2	2.2	3.3	4.4	2.8	5.6	6.7	7.8	160	0.4	1.5	0.5D
		1	1	1.5	1.6	2.1	2.6	3.1	3.6	140	0.3	1.0	0.5D
		0.7	0.7	1	1.4	0.8	1.7	2.1	2.4	100	0.3	1.0	0.5D
M Stainless steel	PC5300	0.5	0.5	0.8	1.1	0.7	1.4	1.7	2	130	0.2	1.5	0.5D
K Cast iron	PC5300	0.6	0.6	0.9	1.2	0.7	1.5	1.8	2.1	180	0.2	1.5	0.5D

• The figures in the above chart means Php value.

Chip removal rate by cutting condition

• Used insert: RDKT10

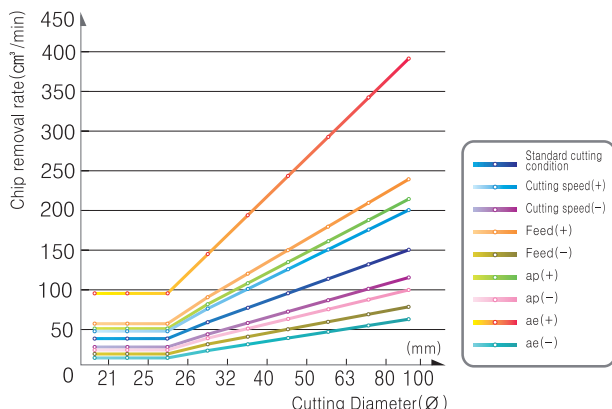

• Variation of cutting condition

Standard	ISO			
	vc = 200	fz = 0.4	ap = 1.5	ae = 0.5D
Speed (+)	250			
Speed (-)	150			
Feed (+)	0.6			
Feed (-)	0.2			
ap (+)	2			
ap (-)	1			
ae (+)	D			
ae (-)	0.2D			



Future Mill (FMR)

FMR Vibration test

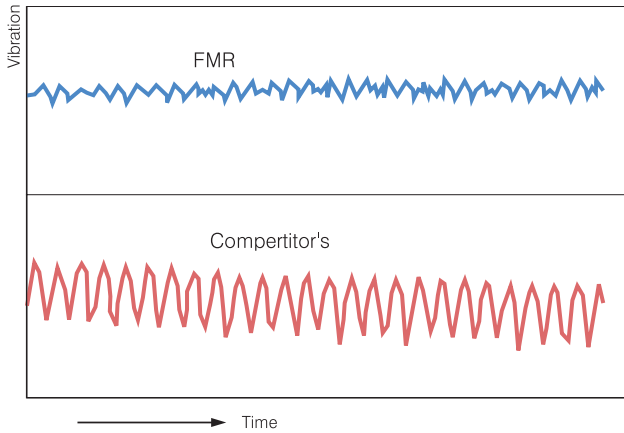

Machining example

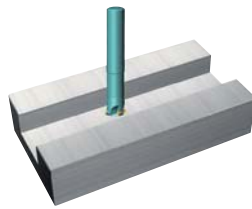

- **Workpiece** STD11
- **Cutting condition**
 - vc (m/min) = 200
 - fz (mm/t) = 0.40
 - ap (mm) = 2.0
 - ae (mm) = 4.0
- **Tools**
 - Insert** RDKT10T3M0-MM (PC3500)
 - Holder** FMRS3032RD-S

Cutting condition formulas for milling

Cutting speed	RPM
---------------	-----

$$vc = \frac{\pi \times D \times n}{1000} \text{ (m/min)}$$

$$n = \frac{vc \times 1000}{\pi \times D} \text{ (min}^{-1}\text{)}$$

Feed (per tooth)	Feed (per minute)
------------------	-------------------

$$fz = \frac{vf}{Z \times n} \text{ (mm/t)}$$

$$vf = fz \times n \times z \text{ (mm/min)}$$

Chip removal rate	Required machine power
-------------------	------------------------

$$Q = \frac{ap \times ae \times vf}{1000} \text{ (cm}^3\text{/min)}$$

$$P_{kw} = \frac{Q \times kc}{60 \times 102 \times \eta} \text{ (kW)}$$

$$P_{hp} = \frac{P_c}{0.75} \text{ (hp)}$$

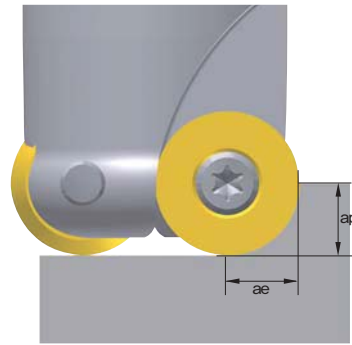

vc = Cutting speed (m/min)	Pkw = Required machine power (kW)
n = Revolution per a minute (min ⁻¹)	Php = Horsepower requirement (hp)
D = Cutting diameter (mm)	Q = Chip removal amount (cm ³ /min)
De = Efficient cutting diameter (mm)	ap = Depth of cut (mm)
vf = Feed per a minute (mm/min)	ae = Width of cut (mm)
fz = Feed per tooth (mm/t)	kc = Specific cutting resistance (MPa)
z = Number of tooth	η = Mechanical efficiency (%)
Pc = Power requirement (kW)	

Feed as per cutting depth

Designation	Chip breaker	Depth of cut (mm)									
		0.2~0.5	0.5~1.0	2.0	3.0	4.0	5.0	6.0	7.0	8.0	
RDHW0501M0	-	0.25	0.15	-	-	-	-	-	-	-	-
RDHW06T1M0	-	0.30	0.20	0.10	-	-	-	-	-	-	-
RDHW0702M0	-	0.35	0.25	0.10	0.07	-	-	-	-	-	-
RDHW0803M0	-	0.40	0.30	0.15	0.01	-	-	-	-	-	-
RDKT10T3M0 -	MF/MM	-	0.40	0.35	0.30	0.20	-	-	-	-	-
RDKT1204M0 -	MF/MM	-	0.50	0.45	0.30	0.25	0.22	-	-	-	-
RDHW1605M0	-	-	0.60	0.50	0.45	0.35	0.30	0.20	0.10	-	-
RDHW2006M0	-	-	-	0.60	0.50	0.40	0.30	0.25	0.15	0.10	-
RDKT1605M0 -	MM	-	0.60	0.50	0.45	0.35	0.30	0.20	0.10	-	-
RDKT2006M0 -	MM	-	-	0.60	0.50	0.40	0.30	0.25	0.15	0.10	-

Future Mill (FMR)

Ramping technical data

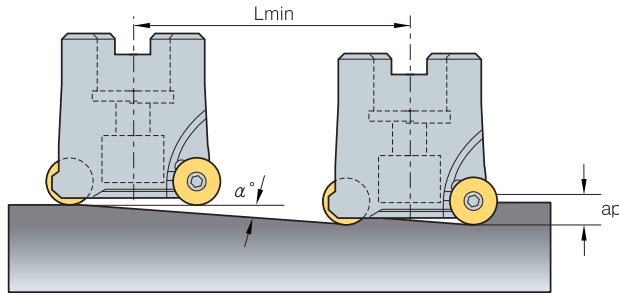

$$L_{min} = \frac{ap}{\tan \alpha^\circ} \text{ (mm)}$$

※ Lmin: Min. inclination cutting length
 α° : Max. ramping angle
 ap: Depth of cut

(mm)

Section	Tool dia.	Ramping angle α° (Max)	Cutting length L (mm) by ramping angle									
			ap = 1	ap = 2	ap = 2.5	ap = 3	ap = 3.5	ap = 4	ap = 5	ap = 6	ap = 8	ap = 10
FMR1000	08	18.14	3	6	8	-	-	-	-	-	-	-
	10	11.7	5	10	12	-	-	-	-	-	-	-
	12	8.43	7	13	17	-	-	-	-	-	-	-
	15	5.93	10	19	24	-	-	-	-	-	-	-
FMR1500	10	20.67	21	5	7	8	-	-	-	-	-	-
	12	10.05	10	11	14	17	-	-	-	-	-	-
	16	6.12	6	19	23	28	-	-	-	-	-	-
	20	4.36	4	26	33	39	-	-	-	-	-	-
FMR2000	15	9.42	6	12	15	18	21	-	-	-	-	-
	20	5.85	10	20	24	29	34	-	-	-	-	-
FMR2500	16	13.7	4	8	10	12	14	16	-	-	-	-
	20	9.29	6	12	15	18	21	24	-	-	-	-
	25	6.56	9	17	22	26	30	35	-	-	-	-
FMR3000	25	21.8	3	5	6	8	9	10	13	-	-	-
	32	13.24	4	9	11	13	15	17	21	-	-	-
	40	9.09	6	13	16	19	22	25	31	-	-	-
	50	6.52	9	17	22	26	31	35	44	-	-	-
	63	4.76	12	24	30	36	42	48	60	-	-	-
	80	3.52	16	33	41	49	57	65	81	-	-	-
FMR4000	100	2.69	21	43	53	64	74	85	106	-	-	-
	32	15.95	3	7	9	10	12	14	17	21	-	-
	40	10.3	6	11	14	17	19	22	28	33	-	-
	50	7.13	8	16	20	24	28	32	40	48	-	-
	63	5.08	11	22	28	34	39	45	56	67	-	-
	80	3.69	16	31	39	47	54	62	78	93	-	-
	100	2.79	21	41	51	62	72	82	103	123	-	-
FMR5000	125	2.14	27	54	67	80	94	107	134	161	-	-
	40	7.4	8	15	19	23	27	31	38	46	62	-
	50	5.22	11	22	27	33	38	44	55	66	88	-
	63	3.79	15	30	38	45	53	60	75	91	121	-
	80	2.97	19	39	48	58	67	77	96	116	154	-
	100	2.09	27	55	69	82	96	110	137	164	219	-
FMR6000	125	1.63	35	70	88	105	123	141	176	211	281	-
	40	7.44	8	15	19	23	27	31	38	46	61	77
	50	4.97	11	23	29	34	40	46	57	69	92	46
	63	3.69	16	31	39	47	54	62	78	93	124	62
	80	2.72	21	42	53	63	74	84	105	126	168	84
	100	2.12	27	54	68	81	95	108	135	162	216	108
	125	1.57	36	73	91	109	128	146	182	219	292	146



Future Mill (FMR)

Helical cutting technical data - ØDH Min

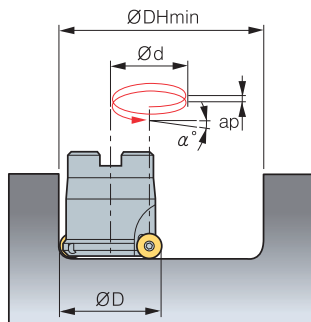

- ØD = Tool dia. (mm), ØDH Min, Max = Min, Max diameter (mm)
- Ød = Tool path (mm)
- ØDH Min (Min diameter) = ØD × 2 - Insert size, ØDH Max (Max diameter) = ØD × 2 - 2
- Ød (Tool path) = ØDH Min, Max - ØD

(mm)

Section	Insert	Tool dia.	ØDH Min	Ød	Ramping angle (α°)									
					ap = 1	ap = 2	ap = 2.5	ap = 3	ap = 3.5	ap = 4	ap = 5	ap = 6	ap = 8	ap = 10
FMR1000	5	08	11	3	6.11	12.35	15.57	-	-	-	-	-	-	-
	5	10	15	5	3.65	7.34	7.34	-	-	-	-	-	-	-
	5	12	19	7	2.61	5.23	5.23	-	-	-	-	-	-	-
	5	15	25	10	1.83	3.65	3.65	-	-	-	-	-	-	-
FMR1500	6	10	14	4	4.57	9.20	9.20	13.95	-	-	-	-	-	-
	6	12	18	6	3.04	6.11	6.11	9.20	-	-	-	-	-	-
	6	16	26	10	1.83	3.65	3.65	5.49	-	-	-	-	-	-
	6	20	34	14	1.30	2.61	2.61	3.92	-	-	-	-	-	-
FMR2000	7	15	23	8	2.28	4.57	4.57	6.88	8.04	-	-	-	-	-
	7	20	33	13	1.40	2.81	2.81	4.22	4.92	-	-	-	-	-
FMR2500	8	16	24	8	2.28	4.57	4.57	6.88	8.04	9.20	-	-	-	-
	8	20	32	12	1.52	3.04	3.04	4.57	5.34	6.11	-	-	-	-
	8	25	42	17	1.07	2.15	2.15	3.22	3.76	4.30	-	-	-	-
FMR3000	10	25	40	15	1.22	2.43	2.43	3.65	4.27	4.88	6.11	-	-	-
	10	32	54	22	0.83	1.66	1.66	2.49	2.91	3.32	4.15	-	-	-
	10	40	70	30	0.61	1.22	1.22	1.83	2.13	2.43	3.04	-	-	-
	10	50	90	40	0.46	0.91	0.91	1.37	1.60	1.83	2.28	-	-	-
	10	63	116	53	0.34	0.69	0.69	1.03	1.21	1.38	1.72	-	-	-
	10	80	150	70	0.26	0.52	0.52	0.78	0.91	1.04	1.30	-	-	-
FMR4000	12	32	52	20	0.91	1.83	1.83	2.74	3.20	3.65	4.57	5.49	-	-
	12	40	68	28	0.65	1.30	1.30	1.96	2.28	2.61	3.26	3.92	-	-
	12	50	88	38	0.48	0.96	0.96	1.44	1.68	1.92	2.40	2.88	-	-
	12	63	114	51	0.36	0.72	0.72	1.07	1.25	1.43	1.79	2.15	-	-
	12	80	148	68	0.27	0.54	0.54	0.81	0.94	1.07	1.34	1.61	-	-
	12	100	188	88	0.21	0.41	0.41	0.62	0.73	0.83	1.04	1.24	-	-
	12	125	238	113	0.16	0.32	0.32	0.48	0.57	0.65	0.81	0.97	-	-
FMR5000	16	40	64	24	0.76	1.52	1.52	2.28	2.66	3.04	3.81	4.57	6.11	-
	16	50	84	34	0.54	1.07	1.07	1.61	1.88	2.15	2.69	3.22	4.30	-
	16	63	110	47	0.39	0.78	0.78	1.16	1.36	1.55	1.94	2.33	3.11	-
	16	80	144	64	0.29	0.57	0.57	0.86	1.00	1.14	1.43	1.71	2.28	-
	16	100	184	84	0.22	0.43	0.43	0.65	0.76	0.87	1.09	1.30	1.74	-
FMR6000	20	50	80	30	0.61	1.22	1.22	1.83	2.13	2.43	3.04	3.65	4.88	6.11
	20	63	106	43	0.42	0.85	0.85	1.27	1.49	1.70	2.12	2.55	3.40	4.25
	20	80	140	60	0.30	0.61	0.61	0.91	1.06	1.22	1.52	1.83	2.43	3.04
	20	100	180	80	0.23	0.46	0.46	0.68	0.80	0.91	1.14	1.37	1.83	2.28
	20	125	230	105	0.17	0.35	0.35	0.52	0.61	0.70	0.87	1.04	1.39	1.74
	20	160	300	140	0.13	0.26	0.26	0.39	0.46	0.52	0.65	0.78	1.04	1.30

Future Mill (FMR)

Helical cutting technical data - ØDH Max

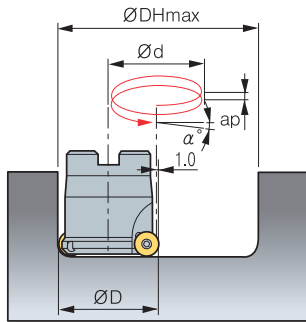

- ØD = Tool dia. (mm), ØDH Min, Max = Min, Max diameter (mm)
- Ød = Tool path (mm)
- ØDH Min (Min diameter) = ØD × 2 - Insert size, ØDH Max (Max diameter) = ØD × 2 - 2
- Ød (Tool path) = ØDH Min, Max - ØD

(mm)

Section	Insert	Tool dia.	ØDH Max	Ød	Ramping angle (α°)									
					ap = 1	ap = 2	ap = 2.5	ap = 3	ap = 3.5	ap = 4	ap = 5	ap = 6	ap = 8	ap = 10
FMR1000	5	08	14	6	3.04	6.11	7.65	-	-	-	-	-	-	-
	5	10	18	8	2.28	4.57	5.72	-	-	-	-	-	-	-
	5	12	22	10	1.83	3.65	4.57	-	-	-	-	-	-	-
	5	15	28	13	1.40	2.81	3.51	-	-	-	-	-	-	-
FMR1500	6	10	18	8	2.28	4.57	5.72	6.88	-	-	-	-	-	-
	6	12	22	10	1.83	3.65	4.57	5.49	-	-	-	-	-	-
	6	16	30	14	1.30	2.61	3.26	3.92	-	-	-	-	-	-
	6	20	38	18	1.01	2.03	2.54	3.04	-	-	-	-	-	-
FMR2000	7	15	28	13	1.40	2.81	3.51	4.22	4.92	-	-	-	-	-
	7	20	38	18	1.01	2.03	2.54	3.04	3.55	-	-	-	-	-
FMR2500	8	16	30	14	1.30	2.61	3.26	3.92	4.57	5.23	-	-	-	-
	8	20	38	18	1.01	2.03	2.54	3.04	3.55	4.06	-	-	-	-
	8	25	48	23	0.79	1.59	1.98	2.38	2.78	3.18	-	-	-	-
FMR3000	10	25	48	23	0.79	1.59	1.98	2.38	2.78	3.18	3.97	-	-	-
	10	32	62	30	0.61	1.22	1.52	1.83	2.13	2.43	3.04	-	-	-
	10	40	78	38	0.48	0.96	1.20	1.44	1.68	1.92	2.40	-	-	-
	10	50	98	48	0.38	0.76	0.95	1.14	1.33	1.52	1.90	-	-	-
	10	63	124	61	0.30	0.60	0.75	0.90	1.05	1.20	1.50	-	-	-
	10	80	158	78	0.23	0.47	0.58	0.70	0.82	0.94	1.17	-	-	-
	10	100	198	98	0.19	0.37	0.47	0.56	0.65	0.74	0.93	-	-	-
FMR4000	12	32	62	30	0.61	1.22	1.52	1.83	2.13	2.43	3.04	3.65	-	-
	12	40	78	38	0.48	0.96	1.20	1.44	1.68	1.92	2.40	2.88	-	-
	12	50	98	48	0.38	0.76	0.95	1.14	1.33	1.52	1.90	2.28	-	-
	12	63	124	61	0.30	0.60	0.75	0.90	1.05	1.20	1.50	1.80	-	-
	12	80	158	78	0.23	0.47	0.58	0.70	0.82	0.94	1.17	1.40	-	-
	12	100	198	98	0.19	0.37	0.47	0.56	0.65	0.74	0.93	1.12	-	-
	12	125	248	123	0.15	0.30	0.37	0.45	0.52	0.59	0.74	0.89	-	-
FMR5000	16	40	78	38	0.48	0.96	1.20	1.44	1.68	1.92	2.40	2.88	3.85	-
	16	50	98	48	0.38	0.76	0.95	1.14	1.33	1.52	1.90	2.28	3.04	-
	16	63	124	61	0.30	0.60	0.75	0.90	1.05	1.20	1.50	1.80	2.39	-
	16	80	158	78	0.23	0.47	0.58	0.70	0.82	0.94	1.17	1.40	1.87	-
	16	100	198	98	0.19	0.37	0.47	0.56	0.65	0.74	0.93	1.12	1.49	-
	16	125	248	123	0.15	0.30	0.37	0.45	0.52	0.59	0.74	0.89	1.19	-
FMR6000	20	50	98	48	0.38	0.76	0.95	1.14	1.33	1.52	1.90	2.28	3.04	3.81
	20	63	124	61	0.30	0.60	0.75	0.90	1.05	1.20	1.50	1.80	2.39	2.99
	20	80	158	78	0.23	0.47	0.58	0.70	0.82	0.94	1.17	1.40	1.87	2.34
	20	100	198	98	0.19	0.37	0.47	0.56	0.65	0.74	0.93	1.12	1.49	1.86
	20	125	248	123	0.15	0.30	0.37	0.45	0.52	0.59	0.74	0.89	1.19	1.48
	20	160	318	158	0.12	0.23	0.29	0.35	0.40	0.46	0.58	0.69	0.92	1.16



Future Mill series for mold making

FMR P-positive

- Stable clamping system enables stable machining and productivity
- Varied product line-up ensures wide application range
- Optimal shape and grade with high hardness for hard-to-cut material machining

Features

- P-positive relief angle (11°) ensures high rigidity and high machinability in die steel and high-resistant alloy machining
- Flat clearance face of insert prevents interference and revolution while machining
- Optimal grades and chip breakers for various workpieces
- Chip breaker
 - Concave shape ensures wide chip pocket and lowers cutting temperature
 - Clearance face for preventing rotation
 - Prevents rotation in machining
 - Divides corners
 - Prevents interference in high-feed machining
 - Ensures stable clamping
 - Through-coolant system
 - Superb chip evacuation
 - Low cutting heat ensures long tool life

Features of chip breaker

Insert	Cutting-edge	Uses	Features
MA		Aluminum machining	Optimal cutting-edge for aluminum machining and buffed surface ensure high machinability
ML		Titanium & Inconel machining	Excellent results in titanium machining thanks to a high hardness cutting-edge and the chip breaker reducing the cutting load
MF		Fine finishing	Chip breaker for low cutting resistance enables fine finishing.
MM		General machining	Optimal for general machining
None C/B		Super hard material machining	Optimal for high hardness die steel and heat resistant alloy

Recommended cutting condition

* Recommended chip breaker: ● First ○ Second

Workpiece	Hardness	Grades	Cutting conditions				Chip breaker				None C/B		
			vc (m/min)	fz (mm/t)	ap (mm)	ae (mm)	MA	ML	MF	MM	1	2	
P	Low carbon steel	HB80~180	PC5400	100~250	0.12~0.70	0.3~6.0	0.7D~0.1D	-	-	●	○	-	-
	High carbon steel	HB180~280	PC5400	100~220	0.12~0.70	0.3~6.0	0.7D~0.1D	-	-	●	○	-	-
	Low alloy steel	Under H _R C27	PC3600	180~290	0.20~0.60	0.3~6.0	0.7D~0.1D	-	-	-	●	○	-
			PC5400/PC5300	100~200	0.20~0.60	0.3~6.0	0.7D~0.1D	-	-	-	●	○	-
	Low pre-hardened steel	H _R C20~50	PC3600	130~250	0.30~0.50	~0.5	0.7D~0.1D	-	-	-	-	●	○
			PC2510/PC5300	50~150	0.30~0.50	~0.5	0.7D~0.1D	-	-	-	-	●	○
	High alloy steel	Under H _R C27	PC3600	130~250	0.30~0.50	~0.5	0.7D~0.1D	-	-	-	●	○	-
PC5300			100~220	0.30~0.50	~0.5	0.7D~0.1D	-	-	-	●	○	-	
High pre-hardened steel	H _R C20~48	PC2510/PC5300	50~150	0.30~0.50	~0.5	0.7D~0.1D	-	-	-	-	●	○	
M	Stainless steel	Under HB270	PC5300/PC5400	100~150	0.20~0.60	0.3~6.0	0.7D~0.1D	-	-	○	●	-	-
K	Gray cast iron, Ductile cast iron	Under 350MPa	PC5300	120~210	0.20~0.60	0.3~6.0	0.7D~0.1D	-	-	○	●	-	-
N	Aluminum	-	H01	300~800	0.30~0.60	0.3~6.0	0.7D~0.1D	●	-	-	-	-	-
S	Heat resistant alloy	Fe	H _R C20~30	PC5300/PC5400	35~60	0.30~0.50	~0.5	0.7D~0.1D	-	●	○	-	-
		Ni or Co	H _R C40~45	PC5300/PC5400	30~50	0.30~0.50	~0.5	0.7D~0.1D	-	●	○	-	-
	Titanium	H _R C35~45	PC5300/PC5400	40~70	0.30~0.50	~1.5	0.7D~0.1D	-	●	○	-	-	
H	High hardened materials	Over H _R C50	PC2505/PC2510	30~50	0.30~0.50	~0.5	0.7D~0.1D	-	-	-	-	●	○

E Technical Information for FMR P-positive

➤ Feed per tooth according to ap (fz, mm/t)

(mm)

Insert	Insert size (d)	Feed per tooth according to ap							
		ap = 1	ap = 2	ap = 3	ap = 4	ap = 5	ap = 6	ap = 8	ap = 10
RPMT08	8	0.30	0.22	0.18	0.15	-	-	-	-
RPMT10	10	0.40	0.28	0.25	0.20	0.12	-	-	-
RPMT12	12	0.60	0.45	0.35	0.30	0.25	0.20	-	-
RPMT16	16	0.65	0.45	0.40	0.32	0.30	0.28	0.23	-
RPMT20	20	0.70	0.50	0.42	0.35	0.32	0.29	0.25	0.22

➤ Performance evaluation

Alloy steel (SM490A Heat treatment, HRC 38~40)

- **Cutting conditions** vc (m/min) = 250
fz (mm/tooth) = 0.6
ap (mm) = 1
wet

- **Tools** Insert RPMT1204M0E-MF (PC5300)
Holder FMRS4032HRP-3L25

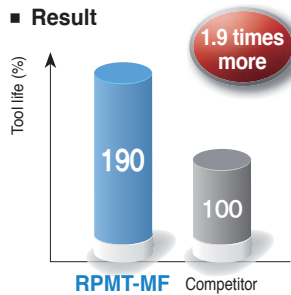

Low pre-hardened steel (KP4M Heat treatment, HRC 30~45)

- **Cutting conditions** vc (m/min) = 178
fz (mm/tooth) = 0.72
ap (mm) = 1.5
dry

- **Tools** Insert RPMT1606M0S-MM (PC5300)
Holder FMRCM5063HRP-4

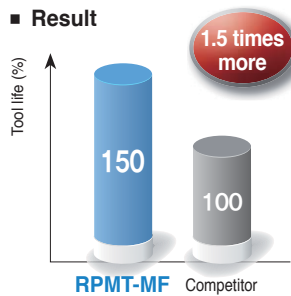

Low pre-hardened steel (KP1, HRC 28~33)

- **Cutting conditions** vc (m/min) = 178
fz (mm/tooth) = 0.74
ap (mm) = 0.8
dry

- **Tools** Insert RPMT1204M0E-MF (PC5300)
Holder FMRCM4063HRP-6

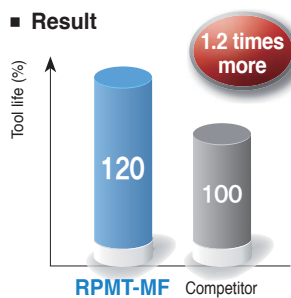

High pre-hardened steel (STD61, HRC 50~52)

- **Cutting conditions** vc (m/min) = 50
fz (mm/tooth) = 0.15
ap (mm) = 4.0
dry

- **Tools** Insert RPMW1204M0S1 (PC5300)
Holder FMRS4032HRP-3L25

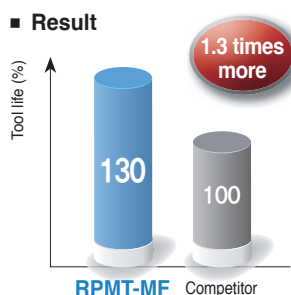

FMR P-positive

Maximum angle table for ramping machining

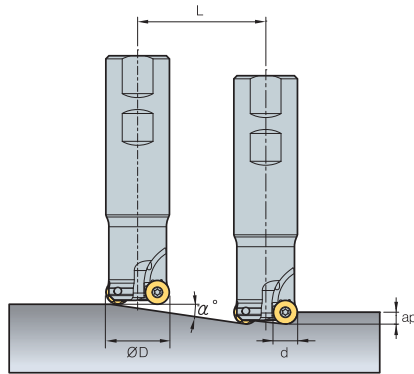

$$L_{min} = \frac{ap}{\tan \alpha^\circ} \text{ (mm)}$$

* L (mm): Cutting length
 α°: Max. ramping angle
 ap: Depth of cut

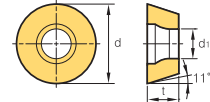

(mm)

Section	Insert size (d)	Tool dia. (ØD)	Ramping angle α° (max)	Cutting length L (mm) by ap									
				ap = 1	ap = 2	ap = 2.5	ap = 3	ap = 3.5	ap = 4	ap = 5	ap = 6	ap = 8	ap = 10
FMR2500	8	17	4.7	12	24	30	36	42	48	-	-	-	-
	8	18	4.1	14	28	34	41	48	55	-	-	-	-
	8	20	15.4	4	7	9	11	13	14	-	-	-	-
	8	21	13.9	4	8	10	12	14	16	-	-	-	-
	8	25	9.8	6	12	14	17	20	23	-	-	-	-
	8	26	9.2	6	12	16	19	22	25	-	-	-	-
FMR3000	10	25	13.8	4	8	10	12	14	16	20	-	-	-
	10	26	12.6	4	9	11	13	16	18	22	-	-	-
	10	32	8.4	7	14	17	20	24	27	34	-	-	-
	10	33	8.0	7	14	18	21	25	29	36	-	-	-
	10	40	5.8	10	20	25	30	34	39	49	-	-	-
	10	50	4.2	14	27	34	41	48	55	68	-	-	-
	10	63	3.1	19	37	47	56	65	75	93	-	-	-
FMR4000	12	25	4.5	13	25	32	38	44	51	63	76	-	-
	12	26	4.1	14	28	35	42	49	56	70	84	-	-
	12	32	14.7	4	8	10	11	13	15	19	23	-	-
	12	33	13.8	4	8	10	12	14	16	20	24	-	-
	12	40	9.6	6	12	15	18	21	24	30	36	-	-
	12	50	6.7	9	17	21	26	30	34	43	51	-	-
	12	63	4.8	12	24	30	36	42	48	60	72	-	-
	12	66	4.5	13	26	32	38	45	51	64	77	-	-
	12	80	3.5	17	33	41	50	58	66	83	99	-	-
FMR5000	16	40	17.8	3	6	8	9	11	12	16	19	25	-
	16	50	11.3	5	10	13	15	18	20	25	30	40	-
	16	63	7.6	7	15	19	22	26	30	37	45	60	-
	16	66	7.1	8	16	20	24	28	32	40	48	64	-
	16	80	5.3	11	21	27	32	37	43	53	64	85	-
	16	100	4.0	14	29	36	43	51	58	72	87	116	-
	16	125	3.0	19	38	48	58	67	77	96	115	154	-
	16	160	2.2	26	52	65	78	90	103	129	155	207	-
FMR6000	20	50	17.8	3	6	8	9	11	12	16	19	25	31
	20	63	11.1	5	10	13	15	18	20	25	30	41	51
	20	80	7.4	8	15	19	23	27	31	38	46	61	77
	20	100	5.3	11	21	27	32	37	43	53	64	85	107
	20	125	4.0	14	29	36	43	51	58	72	87	116	145
	20	160	2.9	20	40	49	59	69	79	99	119	158	198
	20	200	2.2	26	52	65	78	90	103	129	155	207	258
	20	250	1.7	33	67	84	100	117	134	167	200	267	334

* Insert size (d): Please refer page E19, E20 applicable insert drawing.

FMR P-positive

Minimum hole diameter table for helical machining (ØDH Min)

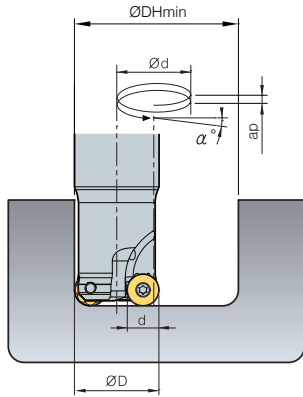

- ØD = Tool dia. (mm)
- Ød (Tool path, mm) = ØDH Min, Max - ØD
- ØDH Min (Minimum hole diameter) = ØD × 2 - Insert size (d)
- ØDH Max (Maximum hole diameter) = ØD × 2 - 2
- Ramping angle by ap (α°) = $\tan^{-1}\left(\frac{ap}{\pi \times \text{Ød}}\right)$
- Helical angle adjusted by ap cannot exceed maximum angle
- ap = Depth of cut

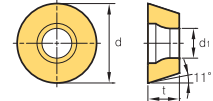

(mm)

Section	Insert size (d)	Tool dia. (ØD)	Ramping angle α° (max)	ØDH Min	Ød	Ramping angle (α°) by ap									
						ap = 1	ap = 2	ap = 2.5	ap = 3	ap = 3.5	ap = 4	ap = 5	ap = 6	ap = 8	ap = 10
FMR2500	8	17	4.7	26	9	2.03	4.06	-	-	-	-	-	-	-	-
	8	18	4.1	28	10	1.83	3.65	-	-	-	-	-	-	-	-
	8	20	15.4	32	12	1.52	3.04	3.81	4.57	5.34	6.11	-	-	-	-
	8	21	13.9	34	13	1.40	2.81	3.51	4.22	4.92	5.63	-	-	-	-
	8	25	9.8	42	17	1.07	2.15	2.69	3.22	3.76	4.30	-	-	-	-
	8	26	9.2	44	18	1.01	2.03	2.54	3.04	3.55	4.06	-	-	-	-
FMR3000	10	25	13.8	40	15	1.22	2.43	3.04	3.65	4.27	4.88	-	-	-	-
	10	26	12.6	42	16	1.14	2.28	2.85	3.43	4.00	4.57	-	-	-	-
	10	32	8.4	54	22	0.83	1.66	2.07	2.49	2.91	3.32	-	-	-	-
	10	33	8.0	56	23	0.79	1.59	1.98	2.38	2.78	3.18	-	-	-	-
	10	40	5.8	70	30	0.61	1.22	1.52	1.83	2.13	2.43	-	-	-	-
	10	50	4.2	90	40	0.46	0.91	1.14	1.37	1.60	1.83	-	-	-	-
	10	63	3.1	116	53	0.34	0.69	0.86	1.03	1.21	1.38	-	-	-	-
	10	66	2.9	122	56	0.33	0.65	0.81	0.98	1.14	1.30	-	-	-	-
FMR4000	12	25	4.5	38	13	1.40	2.81	3.51	-	-	-	-	-	-	-
	12	26	4.1	40	14	1.30	2.61	3.26	-	-	-	-	-	-	-
	12	32	14.7	52	20	0.91	1.83	2.28	2.74	3.20	3.65	4.57	5.49	-	-
	12	33	13.8	54	21	0.87	1.74	2.17	2.61	3.04	3.48	4.35	5.23	-	-
	12	40	9.6	68	28	0.65	1.30	1.63	1.96	2.28	2.61	3.26	3.92	-	-
	12	50	6.7	88	38	0.48	0.96	1.20	1.44	1.68	1.92	2.40	2.88	-	-
	12	63	4.8	114	51	0.36	0.72	0.89	1.07	1.25	1.43	1.79	2.15	-	-
	12	66	4.5	120	54	0.34	0.68	0.84	1.01	1.18	1.35	1.69	2.03	-	-
	12	80	3.5	148	68	0.27	0.54	0.67	0.81	0.94	1.07	1.34	1.61	-	-
	12	100	2.6	188	88	0.21	0.41	0.52	0.62	0.73	0.83	1.04	1.24	-	-
FMR5000	16	40	17.8	64	24	0.76	1.52	1.90	2.28	2.66	3.04	3.81	4.57	6.11	-
	16	50	11.3	84	34	0.54	1.07	1.34	1.61	1.88	2.15	2.69	3.22	4.30	-
	16	63	7.6	110	47	0.39	0.78	0.97	1.16	1.36	1.55	1.94	2.33	3.11	-
	16	66	7.1	116	50	0.36	0.73	0.91	1.09	1.28	1.46	1.83	2.19	2.92	-
	16	80	5.3	144	64	0.29	0.57	0.71	0.86	1.00	1.14	1.43	1.71	2.28	-
	16	100	4.0	184	84	0.22	0.43	0.54	0.65	0.76	0.87	1.09	1.30	1.74	-
	16	125	3.0	234	109	0.17	0.33	0.42	0.50	0.59	0.67	0.84	1.00	1.34	-
	16	160	2.2	304	144	0.13	0.25	0.32	0.38	0.44	0.51	0.63	0.76	1.01	-
FMR6000	20	50	17.8	80	30	0.61	1.22	1.52	1.83	2.13	2.43	3.04	3.65	4.88	6.11
	20	63	11.1	106	43	0.42	0.85	1.06	1.27	1.49	1.70	2.12	2.55	3.40	4.25
	20	80	7.4	140	60	0.30	0.61	0.76	0.91	1.06	1.22	1.52	1.83	2.43	3.04
	20	100	5.3	180	80	0.23	0.46	0.57	0.68	0.80	0.91	1.14	1.37	1.83	2.28
	20	125	4.0	230	105	0.17	0.35	0.43	0.52	0.61	0.70	0.87	1.04	1.39	1.74
	20	160	2.9	300	140	0.13	0.26	0.33	0.39	0.46	0.52	0.65	0.78	1.04	1.30
	20	200	2.2	380	180	0.10	0.20	0.25	0.30	0.35	0.41	0.51	0.61	0.81	1.01
	20	250	1.7	480	230	0.08	0.16	0.20	0.24	0.28	0.32	0.40	0.48	0.63	0.79

* Insert size (d): Please refer page E19, E20 applicable insert drawing.



FMR P-positive

Maximum hole diameter table for helical machining (ØDH Max)

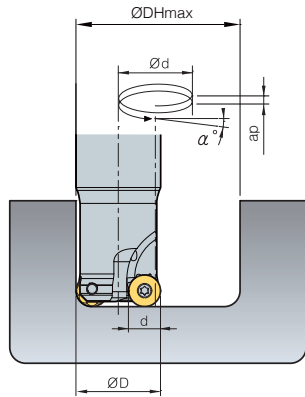

- ØD = Tool dia. (mm)
- Ød (Tool path, mm) = ØDH Min, Max - ØD
- ØDH Min (Minimum hole diameter) = ØD × 2 - Insert size (d)
- ØDH Max (Maximum hole diameter) = ØD × 2 - 2
- Ramping angle by ap (α°) = $\tan^{-1} \left(\frac{ap}{\pi \times \text{Ød}} \right)$
- Helical angle adjusted by ap cannot exceed maximum angle
- ap = Depth of cut

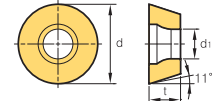

(mm)

Section	Insert size (d)	Tool dia. (ØD)	Ramping angle α° (max)	ØDH Max	Ød	Ramping angle (α°) by ap									
						ap = 1	ap = 2	ap = 2.5	ap = 3	ap = 3.5	ap = 4	ap = 5	ap = 6	ap = 8	ap = 10
FMR2500	8	17	4.7	32	15	1.22	2.43	3.04	3.65	-	-	-	-	-	-
	8	18	4.1	34	16	1.14	2.28	2.85	3.43	-	-	-	-	-	-
	8	20	15.4	38	18	1.01	2.03	2.54	3.04	3.55	4.06	-	-	-	-
	8	21	13.9	40	19	0.96	1.92	2.40	2.88	3.37	3.85	-	-	-	-
	8	25	9.8	48	23	0.79	1.59	1.98	2.38	2.78	3.18	-	-	-	-
	8	26	9.2	50	24	0.76	1.52	1.90	2.28	2.66	3.04	-	-	-	-
FMR3000	10	25	13.8	48	23	0.79	1.59	1.98	2.38	2.78	3.18	-	-	-	-
	10	26	12.6	50	24	0.76	1.52	1.90	2.28	2.66	3.04	-	-	-	-
	10	32	8.4	62	30	0.61	1.22	1.52	1.83	2.13	2.43	-	-	-	-
	10	33	8.0	64	31	0.59	1.18	1.47	1.77	2.06	2.36	-	-	-	-
	10	40	5.8	78	38	0.48	0.96	1.20	1.44	1.68	1.92	-	-	-	-
	10	50	4.2	98	48	0.38	0.76	0.95	1.14	1.33	1.52	-	-	-	-
	10	63	3.1	124	61	0.30	0.60	0.75	0.90	1.05	1.20	-	-	-	-
FMR4000	12	25	4.5	48	23	0.79	1.59	1.98	2.38	2.78	3.18	-	-	-	-
	12	26	4.1	50	24	0.76	1.52	1.90	2.28	2.66	3.04	-	-	-	-
	12	32	14.7	62	30	0.61	1.22	1.52	1.83	2.13	2.43	3.04	3.65	-	-
	12	33	13.8	64	31	0.59	1.18	1.47	1.77	2.06	2.36	2.95	3.54	-	-
	12	40	9.6	78	38	0.48	0.96	1.20	1.44	1.68	1.92	2.40	2.88	-	-
	12	50	6.7	98	48	0.38	0.76	0.95	1.14	1.33	1.52	1.90	2.28	-	-
	12	63	4.8	124	61	0.30	0.60	0.75	0.90	1.05	1.20	1.50	1.80	-	-
	12	66	4.5	130	64	0.29	0.57	0.71	0.86	1.00	1.14	1.43	1.71	-	-
	12	80	3.5	158	78	0.23	0.47	0.58	0.70	0.82	0.94	1.17	1.40	-	-
FMR5000	16	40	17.8	78	38	0.48	0.96	1.20	1.44	1.68	1.92	2.40	2.88	3.85	-
	16	50	11.3	98	48	0.38	0.76	0.95	1.14	1.33	1.52	1.90	2.28	3.04	-
	16	63	7.6	124	61	0.30	0.60	0.75	0.90	1.05	1.20	1.50	1.80	2.39	-
	16	66	7.1	130	64	0.29	0.57	0.71	0.86	1.00	1.14	1.43	1.71	2.28	-
	16	80	5.3	158	78	0.23	0.47	0.58	0.70	0.82	0.94	1.17	1.40	1.87	-
	16	100	4.0	198	98	0.19	0.37	0.47	0.56	0.65	0.74	0.93	1.12	1.49	-
	16	125	3.0	248	123	0.15	0.30	0.37	0.45	0.52	0.59	0.74	0.89	1.19	-
	16	160	2.2	318	158	0.12	0.23	0.29	0.35	0.40	0.46	0.58	0.69	0.92	-
FMR6000	20	50	17.8	98	48	0.38	0.76	0.95	1.14	1.33	1.52	1.90	2.28	3.04	3.81
	20	63	11.1	124	61	0.30	0.60	0.75	0.90	1.05	1.20	1.50	1.80	2.39	2.99
	20	80	7.4	158	78	0.23	0.47	0.58	0.70	0.82	0.94	1.17	1.40	1.87	2.34
	20	100	5.3	198	98	0.19	0.37	0.47	0.56	0.65	0.74	0.93	1.12	1.49	1.86
	20	125	4.0	248	123	0.15	0.30	0.37	0.45	0.52	0.59	0.74	0.89	1.19	1.48
	20	160	2.9	318	158	0.12	0.23	0.29	0.35	0.40	0.46	0.58	0.69	0.92	1.16
	20	200	2.2	398	198	0.09	0.18	0.23	0.28	0.32	0.37	0.46	0.55	0.74	0.92
20	250	1.7	498	248	0.07	0.15	0.18	0.22	0.26	0.29	0.37	0.44	0.59	0.74	

* Insert size (d): Please refer page E19, E20 applicable insert drawing.



FMAC(M)3000

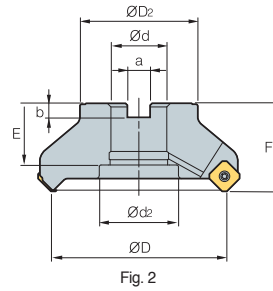
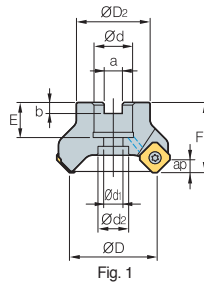

AA
45°

• AR: 21°
• RR: -17°~-12°

(mm)

Designation		ØD	ØD ₂	Ød	a	b	E	F	Ød ₁	Ød ₂	ap		Fig.	
FMACM	3050HR	4	50	42	22	10.4	6.3	20	40	11	17.5	4.0	0.4	1
	3050HR-H	6	50	42	22	10.4	6.3	20	40	11	17.5	4.0	0.4	1
	3063HR	5	63	49	22	10.4	6.3	20	40	11	17.5	4.0	0.5	1
	3063HR-H	8	63	49	22	10.4	6.3	20	40	11	17.5	4.0	0.6	1
FMAC (FMACM)	3080HR	6	80	57	25.4 (27)	9.5 (12.4)	6 (7)	25 (23)	50	14	20	4.0	1.1	1
	3080HR-H	10	80	57	25.4 (27)	9.5 (12.4)	6 (7)	25 (23)	50	14	20	4.0	1.2	1
	3100HR	7	100	67	31.75 (32)	12.7 (14.4)	8 (8)	35 (25.5)	50	(18)	45 (26)	4.0	1.7	2 (1)
	3100HR-H	12	100	67	31.75 (32)	12.7 (14.4)	8 (8)	35 (25.5)	50	(18)	45 (26)	4.0	1.7	2 (1)
	3125HR	8	125	87	38.1 (40)	15.9 (16.4)	10 (9)	42 (29)	63	(22)	55 (32)	4.0	3.3 (3.5)	2 (1)
	3125HR-H	14	125	87	38.1 (40)	15.9 (16.4)	10 (9)	42 (29)	63	(22)	55 (32)	4.0	3.3 (3.5)	2 (1)

() Metric size

Available inserts

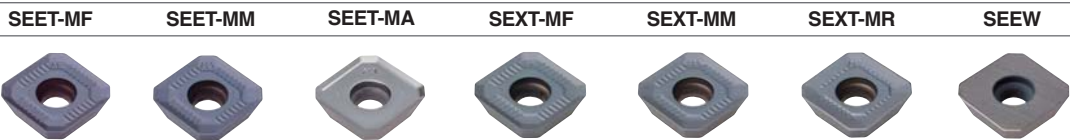

Designation	Cermet		Coated										Uncoated				page			
	CN2000	CN30	NCM325	NC5330	NCM535	NCM545	PC2505	PC2010	PC3600	PC3700	PC6510	PC9530	PC9540	PC5300	PC5400	ST30A		G10	H01	H05
SEET	0903AGFN-MA																			
	0903AGSN-MF																			
	0903AGSN-MM			●																
SEXT	0903AGSN-MF							●		●				●	●					
	0903AGSN-MM							●	●	●				●	●					
	0903AGSN-MR																			
SEEW	0903AGTN																			

Available arbors

Designation	Ød	NC arbors
FMACM	3050HR-□ 3063HR-□	BT□□-FMC22-□□
FMAC (FMACM)	3080HR-□	BT□□-FMA25.4-□□ BT□□-FMC27-□□
	3100HR-□	BT□□-FMA31.75-□□ BT□□-FMC32-□□
	3125HR-□	BT□□-FMA38.1-□□ BT□□-FMB/FMC40-□□

Parts

Specification		
Ø50~Ø125	FTKA0307	TW09S

Available inserts E19, E20 Available arbors and bolt E400~E402



FMAC(M)4000

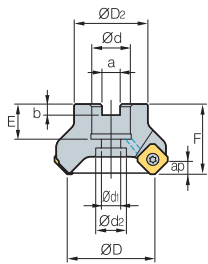

Fig. 1

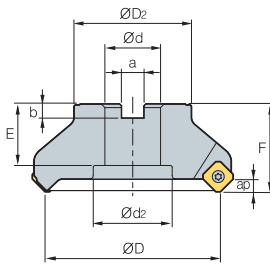

Fig. 2

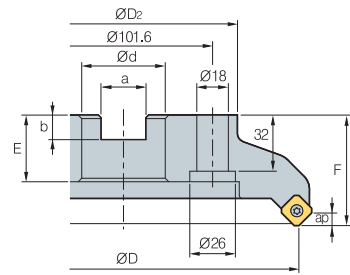

Fig. 3



AA
45°

• AR: 21°
• RR: -17°~-12°

(mm)

Designation		ØD	ØD ₂	Ød	a	b	E	F	Ød ₁	Ød ₂	ap		Fig.	
FMACM	4050HR	3	50	42	22	10.4	6.3	20	40	11	18	6.5	0.4	1
	4063HR	4	63	49	22	10.4	6.3	20	40	11	18	6.5	0.6	1
	4063HR-M	5	63	49	22	10.4	6.3	20	40	11	18	6.5	0.6	1
	4063HR-H	6	63	49	22	10.4	6.3	20	40	11	18	6.5	0.6	1
FMAC (FMACM)	4080HR	5	80	57	25.4 (27)	9.5 (12.4)	6 (7)	25 (23)	50	14	20	6.5	1.1	1
	4080HR-M	6	80	57	25.4 (27)	9.5 (12.4)	6 (7)	25 (23)	50	14	20	6.5	1.1	1
	4080HR-H	8	80	57	25.4 (27)	9.5 (12.4)	6 (7)	25 (23)	50	14	20	6.5	1.1	1
	4100HR	5	100	67	31.75 (32)	12.7 (14.4)	8 (8)	33 (25)	63 (50)	18	26	6.5	2 (1.6)	1
	4100HR-M	7	100	67	31.75 (32)	12.7 (14.4)	8 (8)	33 (25)	63 (50)	18	26	6.5	2 (1.6)	1
	4100HR-H	10	100	67	31.75 (32)	12.7 (14.4)	8 (8)	33 (25)	63 (50)	18	26	6.5	2 (1.6)	1
	4125HR	6	125	87	38.1 (40)	15.9 (16.4)	10 (9)	35 (29)	63	22	32	6.5	3.1	1
	4125HR-M	8	125	87	38.1 (40)	15.9 (16.4)	10 (9)	35 (29)	63	22	32	6.5	3.1	1
	4125HR-H	12	125	87	38.1 (40)	15.9 (16.4)	10 (9)	35 (29)	63	22	32	6.5	3.1	1
	4160R	7	160	107	50.8 (40)	19.0 (16.4)	11 (9)	38 (35)	63	-	-	6.5	4.8	2
	4160R-M	10	160	107	50.8 (40)	19.0 (16.4)	11 (9)	38 (35)	63	-	-	6.5	4.8	2
	4160R-H	16	160	107	50.8 (40)	19.0 (16.4)	11 (9)	38 (35)	63	-	-	6.5	4.8	2
	4200R	8	200	130	47.625 (60)	25.4 (25.7)	14	38 (32)	63	-	-	6.5	6.1	3
4200R-M	12	200	130	47.625 (60)	25.4 (25.7)	14	38 (32)	63	-	-	6.5	6.1	3	
4200R-H	18	200	130	47.625 (60)	25.4 (25.7)	14	38 (32)	63	-	-	6.5	6.1	3	

() Metric size

Available inserts

SEET-MF	SEET-MM	SEET-MA	SEXT-MF	SEXT-MM	SEXT-MR	SEEW	SEEW-W												
Designation	Cermet	Coated						Uncoated	page	Designation	Cermet	Coated						Uncoated	page
	CN2000 CN30	NCM325 NC5330 NCM535 NCM545	PC3700 PC6510 PC9540 PC9530 PC5400	PD2000 PD1010	H01 H05						CN2000 CN30	NCM325 NC5330 NCM535 NCM545	PC2010 PC3700 PC6510 PC9540 PC5300 PC5400	H01 H05					
SEET 14M4AGFN-MA									E19	SEXT 14M4AGSN-MR									E19
SEET 14M4AGSN-MF									E20	SEEW 14M4AGTN									E20
SEET 14M4AGSN-MM										SEEW 14M4AGFN-W									
SEXT 14M4AGSN-MF										SEEW 14M4AGSN-W									
SEXT 14M4AGSN-MM										SEEW 14M4AGTN-W									

Available arbors

Designation	Ød	NC arbors	Designation	Ød	NC arbors
FMACM 4050HR-□	22	BT□□-FMC22-□□	FMAC (FMACM) 4125HR-□	38.1	BT□□-FMA38.1-□□
FMACM 4063HR-□		BT□□-FMA25.4-□□		40	BT□□-FMB40-□□
FMAC (FMACM) 4080HR-□	25.4	BT□□-FMC27-□□	4160R-□	50.8	BT□□-FMA50.8-□□
FMAC (FMACM) 4100HR-□	27	BT□□-FMA31.75-□□		40	BT□□-FMB/FMC40-□□
	31.75	BT□□-FMC32-□□	4200R-□	47.625	BT□□-FMA47.625-□□
		60		BT□□-FMB60-□□	

Parts

Specification					
Ø50-Ø200	FTGA03512	SS42SAF	SHXN0509F	TW15S	HW35L

Available inserts E19, E20

Available arbors and bolt E400-E402



FMAC(M)3000-A

Aluminum body

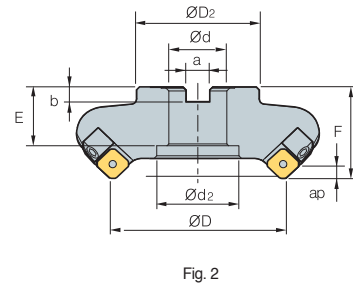
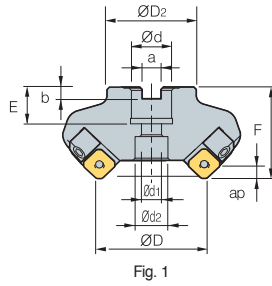

AA
45°
• AR: 21°
• RR: -16°~-12°

(mm)

Designation		ØD	ØD ₂	Ød	a	b	E	F	Ød ₁	Ød ₂	ap		Fig.
FMACM 3063R-A	3	63	49	22	10.4	6.3	20	40	11	18	4	0.5	1
FMAC 3080R-A	4	80	57	25.4 (27)	9.5 (12.4)	6 (7)	25	50	13.5	20	4	0.6	1
(FMACM) 3100R-A	5	100	67	31.75 (32)	12.7 (14.4)	8 (8)	32	50	-	45	4	0.8	2
3100R-25.4-A	5	100	67	25.4	9.5	6	25	50	-	38	4	0.9	2
3125R-A	6	125	87	38.1 (40)	15.9 (16.4)	10 (9)	38	63	-	56	4	1.6	2
3125R-25.4-A	6	125	70	25.4	9.5	6	25	63	-	38	4	1.7	2

() Metric size

Available inserts



Designation	Cermet		Coated											Uncoated				page		
	CN2000	CN30	NCM325	NC5330	NCM535	NCM545	PC2505	PC2010	PC3600	PC3700	PC6510	PC9530	PC9540	PC5300	PC5400	ST30A	G10		H01	H05
SEET 0903AGFN-MA																				
SEET 0903AGSN-MF											●	●						●	●	
SEET 0903AGSN-MM			●								●			●	●					
SEXT 0903AGSN-MF								●		●				●	●					
SEXT 0903AGSN-MM								●	●	●				●	●					
SEXT 0903AGSN-MR																				
SEEW 0903AGTN																				

Available arbors

Designation	Ød	NC arbors
FMACM 3063R-□	22	BT□□-FMC22-□□
FMAC (FMACM) 3080R-□	25.4	BT□□-FMA25.4-□□
	27	BT□□-FMC27-□□
3100R-□	31.75	BT□□-FMA31.75-□□
	32	BT□□-FMC32-□□
3125R-□	38.1	BT□□-FMA38.1-□□
	40	BT□□-FMB40-□□

Parts

Specification					
Ø63~Ø125	FTKA0307	TW09S	HW30L	LFMA3R-A	DHA620

Available inserts E19, E20 Available arbors and bolt E400~E402



FMAC(M)4000-A

Aluminum body

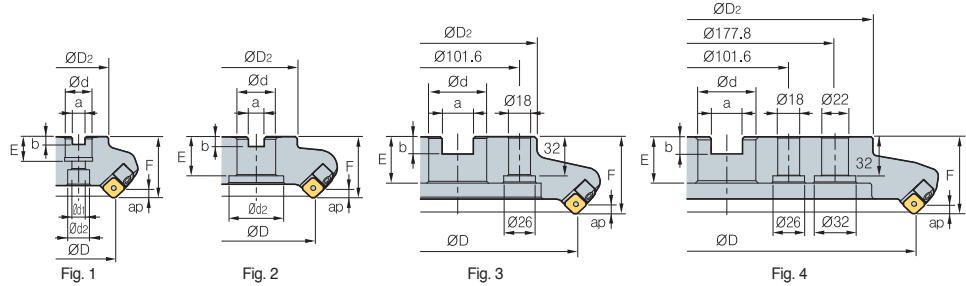

AA
45°
• AR: 21°
• RR: -16°~ -12°

Designation		\odot	$\text{\O}D$	$\text{\O}D_2$	$\text{\O}d$	a	b	E	F	$\text{\O}D_1$	$\text{\O}D_2$	ap	$\frac{\text{kg}}{\text{kg}}$	Fig.
FMACM	4063R-A	3	63	49	22	10.4	6.3	20	50	11	18	6.5	0.6	1
FMAC	4080R-A	4	80	67	25.4 (27)	9.5 (12.4)	6 (7)	25 (22)	50	13.5	20	6.5	0.8	1
(FMACM)	4100R-A	5	100	67	31.75 (32)	12.7 (14.4)	8(8)	32	50	-	45	6.5	1.1	2
	4100R-25.4-A	5	100	67	25.4	9.5	6	25	50	-	38	6.5	1.2	2
	4125R-A	6	125	87	38.1 (40)	15.9 (16.4)	10 (9)	38 (35)	63	-	56	6.5	1.7	2
	4125R-25.4-A	6	125	70	25.4	9.5	6	25	63	-	38	6.5	1.8	2
	4160R-A	7	160	107	50.8 (40)	19.0 (16.4)	11 (9)	38 (35)	63	-	75	6.5	2.5	2
	4200R-A	8	200	130	47.625 (60)	25.4 (25.7)	14 (14)	38 (32)	63	-	-	6.5	3.2	3
	4250R-A	10	250	180	47.625 (60)	25.4 (25.7)	14 (14)	38	63	-	-	6.5	4.1	3
	4315R-A	12	315	240	47.625 (60)	25.4 (25.7)	14 (14)	38	63	-	-	6.5	6.7	4

Note) Through coolant type between $\text{\O}50$ ~ $\text{\O}125$

() Metric size

Available inserts

	SEET-MF	SEET-MM	SEET-MA	SEXT-MF	SEXT-MM	SEXT-MR	SEEW	SEEW-W		
Designation		Cermet CN2000 CN30	Coated NCM325 NC5330 NCM535 NCM545 PC3600 PC3700 PC6510 PC9530 PC9540 PC5300 PC5400 PD2000 PD1010						Uncoated H01 H05	page
SEET	14M4AGFN-MA 14M4AGSN-MF 14M4AGSN-MM								E19 E20	
SEXT	14M4AGSN-MF 14M4AGSN-MM								E19 E20	
Designation		Cermet CN2000 CN30	Coated NCM325 NC5330 NCM535 NCM545 PC2505 PC2010 PC3600 PC3700 PC6510 PC9530 PC9540 PC5300 PC5400						Uncoated H01 H05	page
SEXT	14M4AGSN-MR								E19	
SEEW	14M4AGTN 14M4AGFN-W 14M4AGSN-W 14M4AGTN-W								E20	

Available arbors

Designation	$\text{\O}d$	NC arbors	Designation	$\text{\O}d$	NC arbors
FMACM	4063R-□	22	BT□□-FMC22-□□	40	BT□□-FMB40-□□
FMAC (FMACM)	4080R-□	25.4	BT□□-FMA25.4-□□	50.8	BT□□-FMA50.8-□□
	4100HR-□		27	BT□□-FMC27-□□	40
	4125R-□	31.75	BT□□-FMA31.75-□□	47.625	BT□□-FMA47.625-□□
		32	BT□□-FMC32-□□	60	BT□□-FMB60-□□
		38.1	BT□□-FMA38.1-□□	60	BT□□-FMB60-□□

Parts

Specification					
$\text{\O}63$ ~ $\text{\O}315$	FTGA03512	TW15S	HW40L	LFMA4R-A	DHA0830

Available inserts E19, E20

Available arbors and bolt E400~E402

FMAS3000

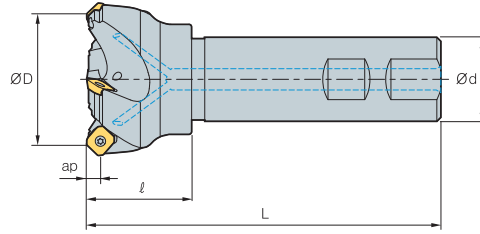

AA
45°

• AR: 23°
• RR: -17°~-13°

(mm)

Designation		ØD	Ød	ℓ	L	ap	
FMAS 3025HR	2	25	25	35	115	4	0.4
3032HR	3	32	25	40	125	4	0.5
3032HR-S32	3	32	32	40	130	4	0.8
3040HR	3	40	32	40	130	4	0.9
3040HR-S40	3	40	40	40	140	4	1.3
3040HR-S42	3	40	42	40	140	4	1.4
3050HR	4	50	32	40	135	4	1
3050HR-S40	4	50	40	40	140	4	1.3
3050HR-S42	4	50	42	40	140	4	1.5
3063HR	5	63	32	45	135	4	1.2
3063HR-S40	5	63	40	45	145	4	1.6
3063HR-S42	5	63	42	45	145	4	1.7

Available inserts



Designation	Cermet		Coated												Uncoated				page	
	CN2000	CN30	NCM325	NC5330	NCM535	NCM545	PC2505	PC2010	PC3600	PC3700	PC6510	PC9530	PC9540	PC5300	PC5400	ST30A	G10	H01		H05
SEET 0903AGFN-MA																				
0903AGSN-MF											●	●		●	●			●	●	
0903AGSN-MM			●								●			●	●					
SEXT 0903AGSN-MF								●			●			●	●					
0903AGSN-MM								●	●	●				●	●					
0903AGSN-MR																				
SEEW 0903AGTN																				

Parts

Specification		
Ø25-Ø63	FTKA0307	TW09S

Available inserts E19, E20



FMAS4000

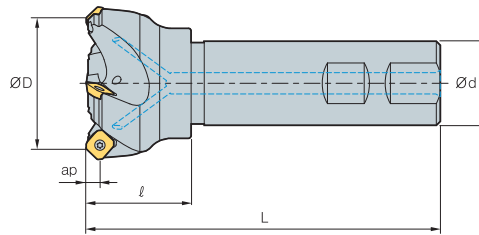

AA
45°

• AR: 23°
• RR: -17°~-13°

(mm)

Designation		ØD	Ød	l	L	ap	
FMAS	4050HR	3	50	32	45	135	1
	4050HR-S40	3	50	40	45	135	1.3
	4050HR-S42	3	50	42	45	135	1.45
	4063HR	4	63	32	45	135	1.2
	4063HR-S40	4	63	40	45	135	1.5
	4063HR-S42	4	63	42	45	135	1.6

Available inserts

		SEET-MF	SEET-MM	SEET-MA	SEXT-MF	SEXT-MM	SEXT-MR	SEEW	SEEW-W												
Designation		Cermet		Coated										Uncoated			page				
		CN2000	CN30	NCM325	NCM335	NC5330	NCM535	NCM545	PC3600	PC3700	PC6510	PC9530	PC9540	PC5300	PC5400	PD2000		PD1010	ST30A	H01	H05
SEET	14M4AGFN-MA																				
	14M4AGSN-MF																				
	14M4AGSN-MM																				
SEXT	14M4AGSN-MF																				
	14M4AGSN-MM																				
	14M4AGSN-MR																				
SEEW	14M4AGTN																				
	14M4AGFN-W																				
	14M4AGSN-W																				
	14M4AGTN-W																				

Parts

Specification					
Ø50~Ø63	FTGA03512	SS42SAF	SHXN0509F	TW15S	HW35L

Available inserts E19, E20

FMPC(M)3000

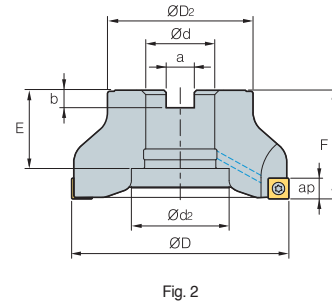
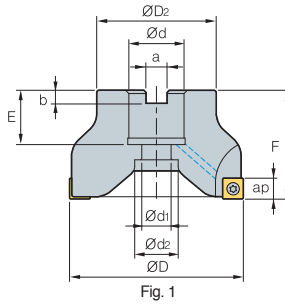

• AR: 10°
• RR: -9°~ -8°

Designation		⚙️	ØD	ØD ₂	Ød	a	b	E	F	Ød ₁	Ød ₂	ap	⚖️	Fig.
FMPCM	3050HS	5	50	40	22	10.4	6.3	20	40	11	18	7	0.3	1
	3063HS	6	63	40	22	10.4	6.3	20	40	11	18	7	0.5	1
FMPC (FMPCM)	3080HS	7	80	55	25.4 (27)	9.5 (12.4)	6 (7)	25 (22)	50	14	20	7	1.0	1
	3100HS	8	100	67	31.75 (32)	12.7 (14.4)	8 (8)	36 (26)	50	18	45 (26)	7	1.5	2 (1)

(mm)

() Metric size

Available inserts

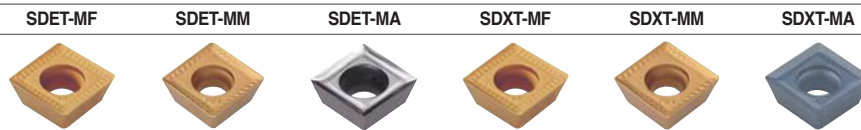

Designation	Cermet		Coated										Uncoated				page		
	CN2000	CN30	NCM325	NCM335	NC5330	NCM535	NCM545	PC3600	PC3700	PC6510	PC9530	PC9540	PC5300	PC5400	PD2000	ST30A		G10	H01
SDET	09M402R-MA														●			●	●
	09M405R-MF																		
	09M405R-MM																		
SDXT	09M405R-MF			●				●	●	●	●		●	●					
	09M405L-MF																		
	09M405R-MM			●	●			●	●	●	●		●	●					
	09M405L-MM							●	●										
	09M405R-MA																	●	●

Available arbors

Designation	Ød	NC arbors
FMPCM	3050HS	BT□□-FMC22-□□
	3063HS	
FMPC (FMPCM)	3080HS	BT□□-FMA25.4-□□
		BT□□-FMC27-□□
		BT□□-FMA31.75-□□
	3100HS	BT□□-FMC32-□□

Parts

Specification	Screw	Wrench
Ø50~Ø100	FTGA03508	TW15S

Assembling

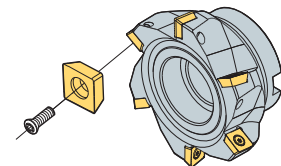

Available inserts E17, E18 Available arbors and bolt E400~E402



FMPC(M)4000

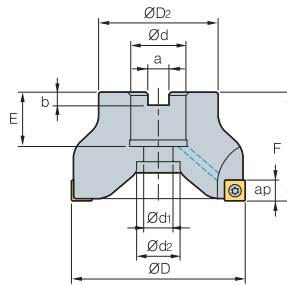

AA
90°
• AR: 10°
• RR: -9° ~ -8°

Designation			ØD	ØD ₂	Ød	a	b	E	F	Ød ₁	Ød ₂	ap	
FMPCM	4063HS	5	63	49	22	10.4	6.3	20 (20)	50 (50)	11	18	11	0.4
FMPC	4080HS	6	80	57	25.4 (27)	9.5 (12.4)	6 (7)	25 (23)	50 (50)	14	20	11	0.9
(FMPCM)	4100HS	7	100	67	31.75 (32)	12.7 (14.4)	8 (8)	33 (25)	63 (50)	18	26	11	1.9 (1.5)
	4125HS	8	125	87	38.1 (40)	15.9 (16.4)	10 (9)	35 (29)	63	22	32	11	3.1

(mm)

() Metric size

Available inserts

		SDET-MF	SDET-MM	SDET-MA	SDXT-MF	SDXT-MM	SDXT-MA														
Designation		Cermet		Coated								Uncoated				page					
		CN2000	CN30	NCM325	NCM335	NC5330	NCM535	NCM545	PC3600	PC3700	PC6510	PC9530	PC9540	PC5300	PC5400		PD1010	ST30A	G10	H01	H05
SDET	130504R-MA																				
	130508R-MF																				
	130508R-MM																				
SDXT	130508R-MF			●				●		●	●		●	●							
	130508R-MM			●	●			●	●	●	●		●	●							
	130508R-MA																		●	●	

Available arbors

Designation	Ød	NC arbors
FMPCM 4063HS	22	BT□□-FMC22-□□
FMPC 4080HS	25.4	BT□□-FMA25.4-□□
(FMPCM)	27	BT□□-FMC27-□□
	31.75	BT□□-FMA31.75-□□
4100HS	32	BT□□-FMC32-□□
	38.1	BT□□-FMA38.1-□□
4125HS	40	BT□□-FMB/FMC40-□□

Parts

Specification		
Ø63-Ø125	FTNC04511	TW20S

Assembling

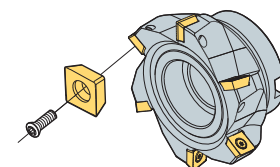

Available inserts E17,E18 Available arbors and bolt E400~E402

FMPC(M)3000-A

Aluminum body

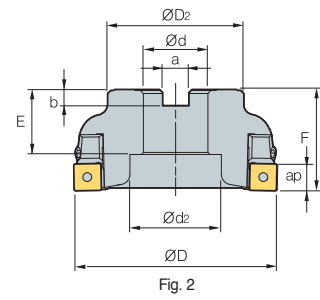
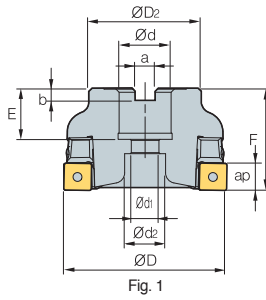
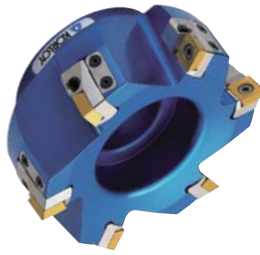

AA
90°

• AR: 10°
• RR: -9°~ -7.3°

(mm)

Designation		ØD	ØD ₂	Ød	a	b	E	F	Ød ₁	Ød ₂	ap	kg	Fig.
FMPCM 3063S-A	3	63	40	22	10.4	6.3	20	40	11.0	18	7	0.2	1
FMPC 3080S-A	4	80	55	25.4 (27)	9.5 (12.4)	6 (7)	25 (22)	50	13.5	20	7	0.4	1
(FMPCM) 3100S-A	5	100	67	31.75 (32)	12.7 (14.4)	8 (8)	32	50	-	45	7	0.6	2
3100S-25.4-A	5	100	67	25.4	9.5	6	25	50	-	38	7	0.7	2

() Metric size

Available inserts

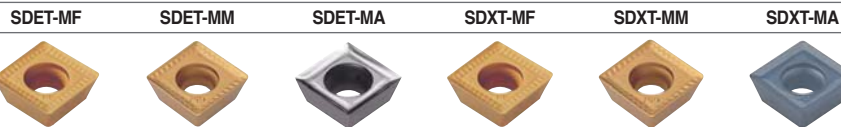

Designation	Cermet		Coated										Uncoated				page			
	CN2000	CN30	NCM325	NCM335	NC5330	NCM535	NCM545	PC3600	PC3700	PC6510	PC9530	PC9540	PC5300	PC5400	PD2000	ST30A		G10	H01	H05
SDET 09M402R-MA																				
SDET 09M405R-MF																				
SDET 09M405R-MM																				
SDXT 09M405R-MF																				E17
SDXT 09M405L-MF																				E18
SDXT 09M405R-MM																				
SDXT 09M405L-MM																				
SDXT 09M405R-MA																				

Available arbors

Designation	Ød	NC arbors
FMPCM 3063S-□	22	BT□□-FMC22-□□
FMPC 3080S-□	25.4	BT□□-FMA25.4-□□
	27	BT□□-FMC27-□□
3100S-□	31.75	BT□□-FMA31.75-□□
	32	BT□□-FMC32-□□
3125S-□	38.1	BT□□-FMA38.1-□□
	40	BT□□-FMB/FMC40-□□

Parts

Specification	Screw	Insert wrench	Locator wrench	Locator	Locator screw	Chip cover	Chip cover screw
Ø63	FTGA03508	TW15S	HW30L	LFMP3R-A	DHA0624	CFMP3R14R1-A	PXMA0306
Ø80~Ø100	FTGA03508	TW15S	HW30L	LFMP3R-A	DHA0624	CFMP3R-A	PXMA0306

Available inserts E17, E18 Available arbors and bolt E400~E402



FMPC(M)4000-A

Aluminum body

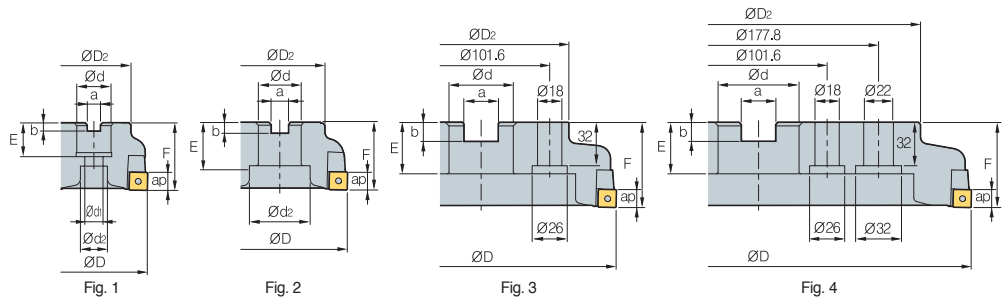
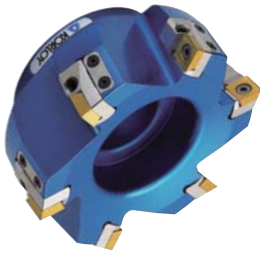

AA
90°

• AR: 10°
• RR: -9°~-7.3°

(mm)

Designation		ØD	ØD ₂	Ød	a	b	E	F	Ød ₁	Ød ₂	ap		Fig.
FMPCM 4063S-A	3	63	49	22	10.4	6.3	20	50	11	18	11	0.6	1
FMPC 4080S-A	4	80	67	25.4 (27)	9.5 (12.4)	6 (7)	25 (22)	50	13.5	20	11	0.8	1
(FMPCM) 4100S-A	5	100	67	31.75 (32)	12.7 (14.4)	8 (8)	32	50	-	45	11	1.1	2
4100S-25.4-A	5	100	67	25.4	9.5	6	25	50	-	38	11	1.2	2
4125S-A	6	125	87	38.1 (40)	15.9 (16.4)	10 (9)	38 (35)	63	-	56	11	1.7	2
4125S-25.4-A	6	125	70	25.4	9.5	6	25	63	-	38	11	1.8	2
4160S-A	8	160	107	50.8 (40)	19.0 (16.4)	11 (9)	38 (35)	63	-	75	11	2.5	2
4200S-A	10	200	130	47.625 (60)	25.4 (25.7)	14 (14)	38 (32)	63	-	-	11	3.2	3
4250S-A	12	250	180	47.625 (60)	25.4 (25.7)	14 (14)	38	63	-	-	11	4.1	3
4315S-A	15	315	240	47.625 (60)	25.4 (25.7)	14 (14)	38	63	-	-	11	6.7	4

() Metric size

Available inserts

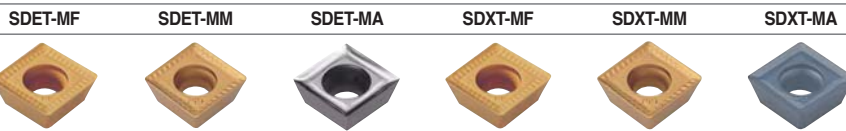

Designation	Cermet		Coated								Uncoated				page					
	CN2000	CN30	NCM325	NCM335	NC5330	NCM535	NCM545	PC3600	PC3700	PC6510	PC9530	PC9540	PC5300	PC5400		PD1010	ST30A	G10	H01	H05
SDET 130504R-MA																				
130508R-MF																				
130508R-MM																				
SDXT 130508R-MF			●					●	●	●		●	●							
130508R-MM			●	●				●	●	●		●	●							
130508R-MA																		●	●	

Available arbors

Designation	Ød	NC arbors	Designation	Ød	NC arbors
FMPCM 4063R-□	22	BT□□-FMC22-□□	FMPC 4125R-□	40	BT□□-FMB40-□□
FMPC 4080R-□	25.4	BT□□-FMA25.4-□□	(FMPCM) 4160R-□	50.8	BT□□-FMA50.8-□□
	27	BT□□-FMC27-□□		40	BT□□-FMB/FMC40-□□
4100HR-□	31.75	BT□□-FMA31.75-□□	4200R-□	47.625	BT□□-FMA47.625-□□
	32	BT□□-FMC32-□□	4250R-□	60	BT□□-FMB60-□□
4125R-□	38.1	BT□□-FMA38.1-□□	4315R-□	60	BT□□-FMB60-□□

Parts

Specification							
Ø63~Ø80	FTNC04509	TW20S	HW40L	LFMP4R1-A	DHA0825	CFMP3R14R1-A	PXMA0306
Ø100~Ø315	FTNC04509	TW20S	HW40L	LFMP4R-A	DHA0830	CFMP4R-A	PXMA0306

Available inserts E17, E18

Available arbors and bolt E400~E402



FMPS3000

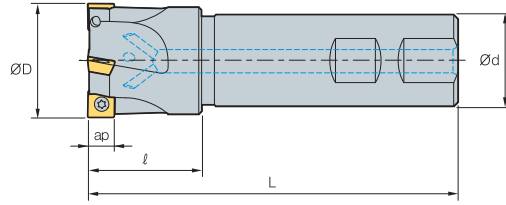

Designation			ØD	Ød	l	L	ap	
FMPS	3025HS	2	25	25	35	115	7	0.4
	3032HS	3	32	25	40	125	7	0.5
	3040HS	4	40	32	40	130	7	0.8
	3040HS-S40	4	40	40	45	140	7	1.2
	3040HS-S42	4	40	42	45	140	7	1.3
	3050HS	5	50	32	40	135	7	1
	3050HS-S40	5	50	40	40	140	7	1.3
	3050HS-S42	5	50	42	40	140	7	1.4
	3063HS	6	63	32	45	135	7	1.2
	3063HS-S40	6	63	40	45	145	7	1.6
	3063HS-S42	6	63	42	45	145	7	1.7

Available inserts

		SDET-MF		SDET-MM		SDET-MA		SDXT-MF		SDXT-MM		SDXT-MA									
Designation		Cermet		Coated								Uncoated				page					
		CN2000	CN30	NCM325	NCM335	NC5330	NCM535	NCM545	PC3600	PC3700	PC6510	PC9530	PC9540	PC5300	PC5400		PD2000	ST30A	G10	H01	H05
SDET	09M402R-MA																				
	09M405R-MF																				
	09M405R-MM																				
SDXT	09M405R-MF			●					●	●	●	●		●	●						E17
	09M405L-MF																				E18
	09M405R-MM			●	●				●	●	●	●		●	●						
	09M405L-MM								●	●											
	09M405R-MA																		●	●	

Parts

Specification		
Ø25~Ø63	FTGA03508	TW15S

Assembling

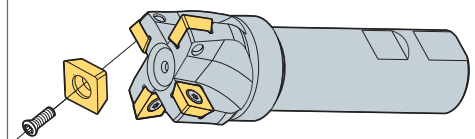

Available inserts E17, E18



FMPS4000

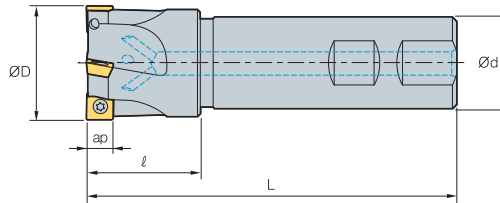

AA
90°

- AR: 10°
- RR: -9° ~ -8°

Designation			ØD	Ød	ℓ	L	ap	
FMPS	4040HS	3	40	32	40	130	11	1
	4040HS-S40	3	40	40	40	140	11	1.3
	4040HS-S42	3	40	42	40	140	11	1.4
	4050HS	4	50	32	45	135	11	1.5
	4050HS-S40	4	50	40	45	145	11	1.7
	4050HS-S42	4	50	42	45	145	11	1.6
	4063HS	5	63	32	45	135	11	2.1
	4063HS-S40	5	63	40	45	145	11	2.4
4063HS-S42	5	63	42	45	145	11	2.6	

Available inserts

		SDET-MF	SDET-MM	SDET-MA	SDXT-MF	SDXT-MM	SDXT-MA															
Designation		Cermet		Coated								Uncoated				page						
		CN2000	CN30	NCM325	NCM335	NC5330	NCM535	NCM545	PC3600	PC3700	PC6510	PC9530	PC9540	PC5300	PC5400		PD1010	ST30A	G10	H01	H05	
SDET	130504R-MA																				E17	
	130508R-MF																					E18
	130508R-MM																					
SDXT	130508R-MF			●				●		●	●		●	●							E18	
	130508R-MM			●	●			●	●	●	●		●	●								E18
	130508R-MA																		●	●		

Parts

Specification		
Ø40~Ø63	FTNC04511	TW20S

Assembling

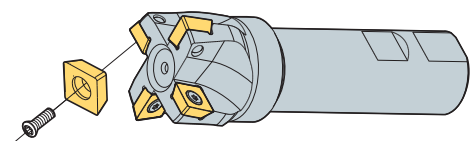

Available inserts E17, E18

FMRC(M)3000

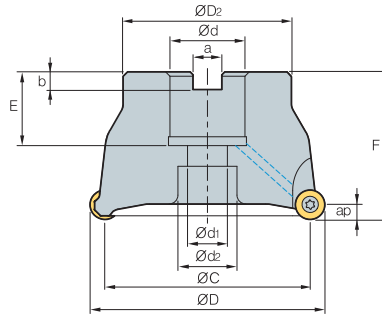

• AR: 5°
• RR: -5°

(mm)

Designation		ØD	ØC	ØD ₂	Ød	a	b	E	F	Ød ₁	Ød ₂	ap		
FMRCM	3040HRD	3	40	30	36	16	8.4	5.6	18	40	9	14	5.0	0.2
	3040HRD-H	4	40	30	36	16	8.4	5.6	18	40	9	14	5.0	0.2
	3050HRD	4	50	40	42	22	10.4	6.3	20	40	11	16.5	5.0	0.3
	3050HRD-H	5	50	40	42	22	10.4	6.3	20	40	11	16.5	5.0	0.3
	3063HRD	5	63	53	49	22	10.4	6.3	20	50	11	16.5	5.0	0.64
	3063HRD-H	6	63	53	49	22	10.4	6.3	20	50	11	16.5	5.0	0.64
FMRC (FMRCM)	3080HRD	6	80	70	57	25.4 (27)	9.5 (12.4)	6 (7.0)	25 (22)	50 (50)	14	19	5.0	1.1
	3080HRD-H	7	80	70	57	25.4 (27)	9.5 (12.4)	6 (7.0)	25 (22)	50 (50)	14	19	5.0	1.1
	3100HRD	7	100	90	67	31.75 (32)	12.7 (14.4)	8 (8.0)	32 (28)	63 (63)	18	26	5.0	2.1
	3100HRD-H	8	100	90	67	31.75 (32)	12.7 (14.4)	8 (8.0)	32 (28)	63 (63)	18	26	5.0	2.1

Note) It's general that you measure of inner diameter when the diameter of FMRC/FMRCM is Ø40~Ø63

()Metric size

Available inserts

RDKT-MF RDKT-MM RDCT-MA



Designation	Cermet		Coated										Uncoated		page				
	CN2000	CN30	NCM325	NC5330	NCM535	NCM545	PC2505	PC2010	PC3600	PC3700	PC6510	PC9530	PC9540	PC5300		PC5400	ST30A	H01	
RDCT 10T3M0-MA																	●	E15 E16	
RDKT 10T3M0-MF																			
10T3M0-MM			●						●	●	●		●						

Available arbors

Designation	Ød	NC arbors
FMRCM 3040HRD 3040HRD-H	16	BT□□-FMC16-□□
3050HRD 3050HRD-H 3063HRD 3063HRD-H	22	BT□□-FMC22-□□
FMRC 3080HRD	25.4	BT□□-FMA/FMB25.4-□□
(FMRCM) 3080HRD-H	27	BT□□-FMB/FMC27-□□
3100HRD	31.75	BT□□-FMA31.75-□□
3100HRD-H	32	BT□□-FMC32-□□

Parts

Specification		
Ø40~Ø100	FTGA03508	TW15S

Available inserts E15, E16 Available arbors and bolt E400~E402



FMRC(M)4000

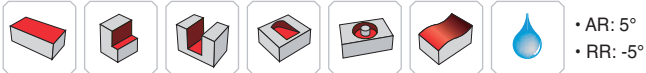
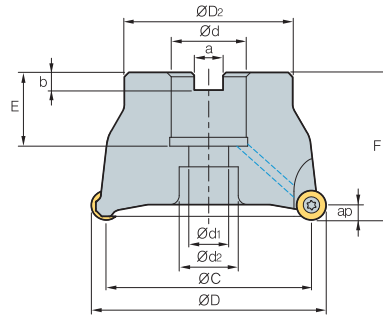

Designation			ØD	ØC	ØD ₂	Ød	a	b	E	F	Ød ₁	Ød ₂	ap	
FMRCM	4050HRD	4	50	38	42	22	10.4	6.3	20	50	11	18	6.0	0.4
	4063HRD	4	63	51	49	22	10.4	6.3	20	50	11	18	6.0	0.6
	4063HRD-M	5	63	51	49	22	10.4	6.3	20	50	11	18	6.0	0.6
FMRC (FMRCM)	4080HRD	5	80	68	57	25.4 (27)	9.5 (12.4)	6 (7.0)	25 (23)	50 (50)	14	20	6.0	1.0
	4080HRD-M	6	80	68	57	25.4 (27)	9.5 (12.4)	6 (7.0)	25 (23)	50 (50)	14	20	6.0	1.0
	4100HRD	6	100	88	67	31.75 (32)	12.7 (14.4)	8 (8.0)	33 (25)	63 (50)	18	26	6.0	1.9 (1.5)
	4100HRD-M	7	100	88	67	31.75 (32)	12.7 (14.4)	8 (8.0)	33 (25)	63 (50)	18	26	6.0	1.9 (1.5)
	4125HRD	7	125	113	87	38.1 (40)	15.9 (16.4)	10 (9.0)	35 (29)	63 (63)	22	32	6.0	3.0
	4125HRD-M	8	125	113	87	38.1 (40)	15.9 (16.4)	10 (9.0)	35 (29)	63 (63)	22	32	6.0	3.0

Note) It's general that you measure of inner diameter when the diameter of FMRC/FMRCM is Ø40~Ø63 () Metric size

Available inserts

RDKT-MF RDKT-MM RDCT-MA



Designation	Cermet		Coated											Uncoated		page		
	CN2000	CN30	NCM325	NC5330	NCM535	NCM545	PC2505	PC2010	PC3600	PC3700	PC6510	PC9530	PC9540	PC5300	PC5400		ST30A	H01
RDCT 1204M0-MA																	●	E15 E16
RDKT 1204M0-MF									●		●							
1204M0-MM			●						●	●	●			●				

Available arbors

Designation	Ød	NC arbors
FMRCM 4063HRD	22	BT□□-FMC22-□□
4063HRD-M		
FMRC (FMRCM) 4080HRD	25.4	BT□□-FMA/FMB25.4-□□
4080HRD-M		
4100HRD	31.75	BT□□-FMA31.75-□□
4100HRD-M		
4125HRD	38.1	BT□□-FMA/FMB38.1-□□
4125HRD-M		
	40	BT□□-FMB/FMC40-□□

Parts

Specification		
Ø50~Ø125	FTKA0410	TW15S

Available inserts E15, E16 Available arbors and bolt E400~E402

FMRC(M)5000

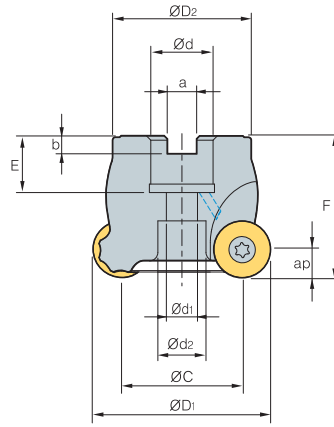

• AR: 5°
• RR: -5°

(mm)

Designation		ØD	ØC	ØD ₂	Ød	a	b	E	F	Ød ₁	Ød ₂	ap		
FMRCM	5050HRD	3	50	34	42	22	10.4	6.3	20	50	11	16.5	8.0	0.4
	5063HRD	4	63	47	49	22	10.4	6.3	20	50	11	18	8.0	0.6
	5063HRD-H	5	63	47	49	22	10.4	6.3	20	50	11	18	8.0	0.6
FMRC (FMRCM)	5080HRD	5	80	64	57	25.4 (27)	9.5 (12.4)	6 (7.0)	25 (23)	50 (50)	14	20	8.0	0.9
	5080HRD-H	6	80	64	57	25.4 (27)	9.5 (12.4)	6 (7.0)	25 (23)	50 (50)	14	20	8.0	0.9
	5100HRD	6	100	84	67	31.75 (32)	12.7 (14.4)	8 (8)	33 (25)	63 (50)	18	26	8.0	1.9 (1.4)
	5100HRD-H	7	100	84	67	31.75 (32)	12.7 (14.4)	8 (8)	33 (25)	63 (50)	18	26	8.0	1.9 (1.4)
	5125HRD	7	125	109	87	38.1 (40)	15.9 (16.4)	10 (9)	35 (29)	63 (63)	22	32	8.0	3
5125HRD-H	8	125	109	87	38.1 (40)	15.9 (16.4)	10 (9)	35 (29)	63 (63)	22	32	8.0	3	

Note) It's general that you measure of inner diameter when the diameter of FMRC/FMRCM is Ø50~Ø63

()Metric size

Available inserts

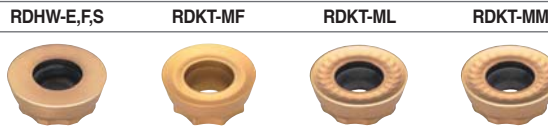

Designation	Cermet		Coated										Uncoated		page			
	CN2000	CN80	NCM325	NC5330	NCM535	NCM545	PC2505	PC2010	PC3600	PC3700	PC6510	PC9530	PC9540	PC5300		PC5400	ST30A	H01
RDHW	1605MOE																	E15
	1605MOF																	
	1605MOS																	
RDKT	1605M0-MM									●								E16
	1605M0-MF																	
	1605M0-ML																	

Available arbors

Designation	Ød	NC arbors
FMRCM	5050HRD	BT□□-FMC22-□□
	5063HRD	
	5063HRD-H	
FMRC (FMRCM)	5080HRD	BT□□-FMA/FMB25.4-□□
	5080HRD-H	BT□□-FMB/FMC27-□□
	5100HRD	BT□□-FMA31.75-□□
	5100HRD-H	BT□□-FMC32-□□
	5125HRD	BT□□-FMA/FMB38.1-□□
	5125HRD-H	BT□□-FMB/FMC40-□□

Parts

Specification		
Ø50~Ø125	FTGA0513-P	TW20-100

Available inserts E15, E16 Available arbors and bolt E400~E402



FMRC(M)6000

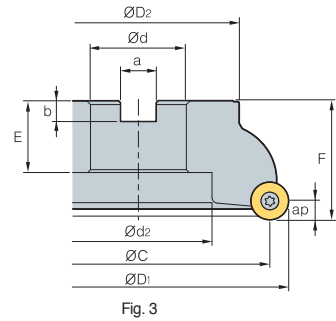
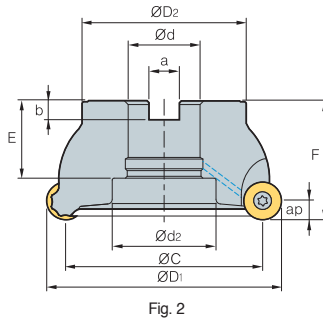
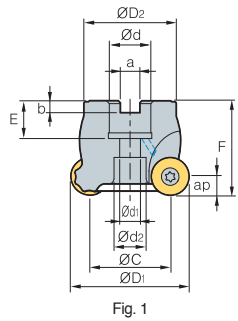

• AR: 5°
• RR: -5°

(mm)

Designation		ØD	ØC	ØD ₂	Ød	a	b	E	F	Ød ₁	Ød ₂	ap		Fig.	
FMRCM	6063HRD	3	63	43	49	22	10.4	6.3	20	50	11	17	10.0	0.5	1
	6063HRD-M	4	63	43	49	22	10.4	6.3	20	50	11	17	10.0	0.5	1
FMRC (FMRCM)	6080HRD	4	80	60	57	25.4 (27)	9.5 (12.4)	6 (7.0)	25 (22)	50	14	20	10.0	0.8	1
	6080HRD-M	5	80	60	57	25.4 (27)	9.5 (12.4)	6 (7.0)	25 (22)	50	14	20	10.0	0.8	1
	6100HRD	5	100	80	67	31.75 (32)	12.7 (14.4)	8 (8)	32 (28)	63	18	26	10.0	1.6	1
	6100HRD-M	6	100	80	67	31.75 (32)	12.7 (14.4)	8 (8)	32 (28)	63	18	26	10.0	1.6	1
	6125HRD	6	125	105	87	38.1 (40)	15.9 (16.4)	10 (9)	41 (29)	63	- (22)	55 (32)	10.0	2.7 (2.9)	2 (1)
	6125HRD-M	7	125	105	87	38.1 (40)	15.9 (16.4)	10 (9)	41 (29)	63	- (22)	55 (32)	10.0	2.7 (2.9)	2 (1)
6160RD	7	160	140	107	50.8 (40)	19 (16.4)	11 (9)	38 (35)	63	-	78	10.0	4.4	3	
6160RD-M	8	160	140	107	50.8 (40)	19 (16.4)	11 (9)	38 (35)	63	-	78	10.0	4.4	3	

() Metric size

Available inserts

RDHW-E,F,S RDKT-MM



Designation	Cermet		Coated											Uncoated		page		
	CN2000	CN30	NCM325	NC5330	NCM535	NCM545	PC2505	PC2010	PC3600	PC3700	PC6510	PC9530	PC9540	PC5300	PC5400		ST30A	H01
RDHW	2006MOE																	E15
	2006MOF																	
	2006MOS																	
RDKT	2006M0-MM									●								

Available arbors

Designation	Ød	NC arbors
FMRCM	6063HRD	BT□□-FMC22-□□
	6063HRD-M	
FMRC (FMRCM)	6080HRD	BT□□-FMA/FMB25.4-□□
	6080HRD-M	BT□□-FMB/FMC27-□□
6100HRD	31.75	BT□□-FMA31.75-□□
6100HRD-M	32	BT□□-FMC32-□□
6125HRD	38.1	BT□□-FMA/FMB38.1-□□
6125HRD-M	40	BT□□-FMB/FMC40-□□
6160RD	50.8	BT□□-FMA50.8-□□
6160RD-M	40	BT□□-FMB/FMC40-□□

Parts

Specification		
Ø63~Ø160	FTGA0515-P	TW20-100

Available inserts E15, E16

Available arbors and bolt E400~E402

FMRS1000/1500

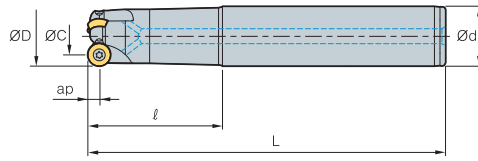

Fig. 1

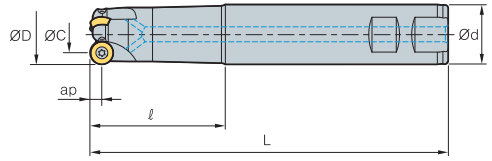

Fig. 2



- AR: 5°
- RR: -5° ~ -1°

(mm)

Designation			ØD	ØC	Ød	ℓ	L	ap		Fig.
FMRS	1008HRD-M	1	8	5.5	10	30	80	2.5	0.2	1
	1008HRD-L	1	8	5.5	10	50	100	2.5	0.2	1
	1010HRD-M	2	10	5	12	44	100	2.5	0.2	1
	1010HRD-L	2	10	5	12	64	120	2.5	0.2	1
	1012HRD-M	2	12	7	12	44	100	2.5	0.3	1
	1012HRD-L	2	12	7	16	80	160	2.5	0.3	1
	1015HRD-M	3	15	10	16	80	160	2.5	0.3	1
	1015HRD-L	3	15	10	16	100	200	2.5	0.4	1
FMRS	1510HRD-M	1	10	6	12	44	100	3.0	0.2	1
	1510HRD-L	1	10	6	12	64	120	3.0	0.2	1
	1512HRD-M	2	12	6	12	54	110	3.0	0.3	1
	1512HRD-L	2	12	6	16	80	160	3.0	0.3	1
	1516HRD-M	3	16	10	16	60	130	3.0	0.3	1
	1516HRD-L	3	16	10	20	90	180	3.0	0.4	1
	1520HRD-M	3	20	14	20	80	150	3.0	0.4	1
	1520HRD-L	3	20	14	20	90	200	3.0	0.5	1

Available inserts

RDHW-E,FS RDKW



Type	Designation	Cermet		Coated										Uncoated		page			
		CN2000	CN30	NCM325	NC5330	NCM535	NCM545	PC2505	PC2010	PC3600	PC3700	PC6510	PC9530	PC9540	PC5300		PC5400	ST30A	H01
1000 type	RDHW	0501M0E																	
		0501M0F																	
		0501M0S																	
1500 type	RDKW	0501M0E																	
	RDHW	06T1M0E																	
		06T1M0F																	
		06T1M0S																	
	RDKW	06T1M0E																	

Parts

Specification		
Ø8~Ø15 (1000 type)	FTNA0203	TW06P
Ø10~Ø20 (1500 type)	FTNA02205	TW06P

Available inserts E15, E16



FMRS2000/2500

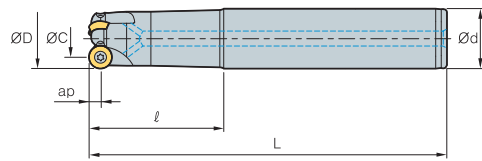

Fig. 1

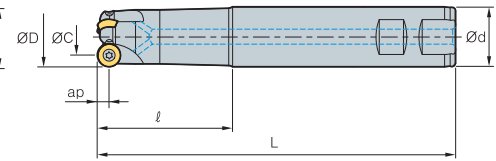

Fig. 2



• AR: 5°
• RR: -5° ~ -1°

(mm)

Designation		ØD	ØC	Ød	l	L	ap		Fig.	
FMRS	2015HRD-S	2	15	8	16	55	115	3.5	0.3	2
	2015HRD-M	2	15	8	20	80	150	3.5	0.4	1
	2015HRD-L	2	15	8	20	90	200	3.5	0.5	1
	2020HRD-S	3	20	14	20	65	125	3.5	0.3	2
	2020HRD-M	3	20	14	20	80	150	3.5	0.4	1
	2020HRD-L	3	20	14	25	90	200	3.5	0.5	1
FMRS	2516HRD-S	2	16	8	16	65	125	4.0	0.3	2
	2516HRD-M	2	16	8	16	80	150	4.0	0.4	1
	2516HRD-L	2	16	8	20	90	200	4.0	0.5	1
	2520HRD-S	2	20	12	20	65	125	4.0	0.4	2
	2520HRD-M	2	20	12	20	80	150	4.0	0.5	1
	2520HRD-L	2	20	12	25	90	200	4.0	0.6	1
	2525HRD-S	3	25	17	25	55	125	4.0	0.5	2
	2525HRD-M	3	25	17	25	90	200	4.0	0.6	1
2525HRD-L	3	25	17	32	110	250	4.0	0.7	1	

Available inserts

RDHW-E,F,S RDKW



Type	Designation	Cermet		Coated										Uncoated		page			
		CN2000	CN30	NCM325	NC5330	NCM535	NCM545	PC2505	PC2010	PC3600	PC3700	PC6510	PC9530	PC9540	PC5300		PC5400	ST30A	H01
2000 type	RDHW	0702M0E																	E15 E16
		0702M0F																	
		0702M0S																	
2500 type	RDKW	0702M0E																	
	RDHW	0803M0E																	
		0803M0F																	
		0803M0S																	
	RDKW	0803M0E																	

Parts

Specification		
Ø15-Ø20 (2000 type)	FTNA02555	TW07S
Ø16-Ø25 (2500 type)	FTNA0305	TW09S
	FTNA0306 (Ø20 over)	

Available inserts E15, E16

FMRS3000

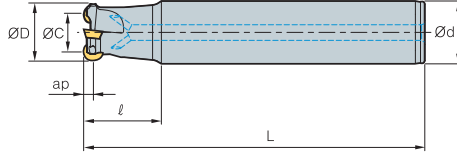

Fig. 1

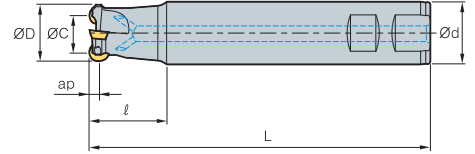

Fig. 2



- AR: 5°
- RR: -8° ~ -5°

(mm)

Designation			ØD	ØC	Ød	l	L	ap		Fig.
FMRS	3021HRD-M	1	21	11	20	40	150	5	0.4	1
	3021HRD-M2	2	21	11	20	40	150	5	0.4	1
	3021HRD-L	1	21	11	20	50	200	5	0.6	1
	3021HRD-L2	2	21	11	20	50	200	5	0.6	1
	3025HRD-S	2	25	15	25	35	115	5	0.5	2
	3025HRD-M	2	25	15	25	70	200	5	0.7	1
	3025HRD-L	2	25	15	25	100	250	5	1	1
	3026HRD-M	2	26	16	25	70	200	5	0.65	1
	3026HRD-L	2	26	16	25	100	250	5	0.7	1
	3032HRD-S	3	32	22	32	40	125	5	1	2
	3032HRD-M	3	32	22	32	70	200	5	1.3	1
	3032HRD-L	3	32	22	32	150	300	5	1.6	1
	3040HRD-S	4	40	30	32	40	125	5	1.3	2
	3040HRD-M	4	40	30	32	70	200	5	1.5	1
3040HRD-L	4	40	30	32	150	300	5	1.8	1	

Available inserts

RDKT-MF RDKT-MM RDCT-MA



Designation	Cermet		Coated											Uncoated		page		
	CN2000	CN30	NCM325	NC5330	NCM535	NCM545	PC2505	PC2010	PC3600	PC3700	PC6510	PC9530	PC9540	PC5300	PC5400		ST30A	H01
RDCT 10T3M0-MA																	●	E15 E16
RDKT 10T3M0-MF																		
10T3M0-MM			●						●	●	●			●				

Parts

Specification		
Ø21 Ø25-Ø40	FTGA03507 FTGA03508	TW15S

Available inserts E15, E16



FMRS4000

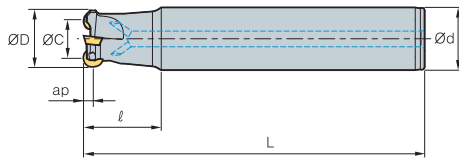

Fig. 1

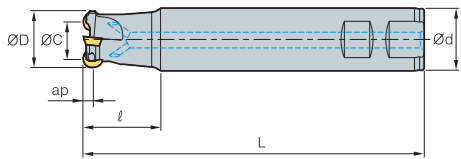

Fig. 2



• AR: 5°
• RR: -8° ~ -5°

(mm)

Designation		ØD	ØC	Ød	l	L	ap		Fig.
FMRS									
4032HRD-S	2	32	20	32	40	125	6	0.8	2
4032HRD-M	2	32	20	32	70	200	6	1.1	1
4032HRD-L	2	32	20	32	150	300	6	1.6	1
4033HRD-S	2	33	21	32	40	125	6	0.9	2
4033HRD-M	2	33	21	32	70	200	6	1.1	1
4033HRD-L	2	33	21	32	150	300	6	1.7	1
4040HRD-S	3	40	28	32	40	125	6	1	2
4040HRD-M	3	40	28	32	70	200	6	1.6	1
4040HRD-L	3	40	28	32	150	300	6	1.8	1
4040HRD-S40	3	40	28	40	40	125	6	1.3	2
4040HRD-M40	3	40	28	40	70	200	6	2	1
4040HRD-L40	3	40	28	40	150	300	6	2.4	1
4040HRD-S42	3	40	28	42	40	125	6	1.6	2
4040HRD-M42	3	40	28	42	70	200	6	2.4	1
4040HRD-L42	3	40	28	42	150	300	6	2.8	1
4050HRD-S	4	50	38	42	50	125	6	1.5	2
4050HRD-M	4	50	38	42	50	250	6	2.1	1
4050HRD-L	4	50	38	42	50	300	6	2.7	1
4050HRD-S40	4	50	38	40	50	150	6	2	2
4050HRD-M40	4	50	38	40	50	250	6	2.6	1
4050HRD-L40	4	50	38	40	50	300	6	3.2	1

Available inserts

RDKT-MF RDKT-MM RDCT-MA



Designation	Cermet		Coated										Uncoated		page			
	CN2000	CN30	NCM325	NC5330	NCM535	NCM545	PC2505	PC2010	PC3800	PC3700	PC6510	PC9530	PC9540	PC5300		PC5400	ST30A	H01
RDCT 1204M0-MA																	●	E15
RDKT 1204M0-MF										●		●					●	E16
RDKT 1204M0-MM			●							●	●	●					●	E16

Parts

Specification		
Ø32~Ø50	FTKA0410	TW15S

Available inserts E15, E16

FMRS5000

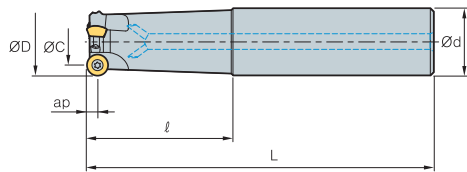

Fig. 1

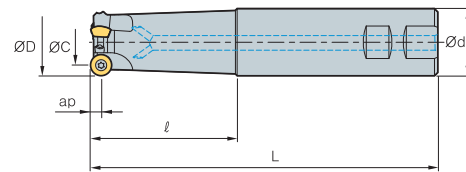

Fig. 2



- AR: 5°
- RR: -8° ~ -5°

(mm)

Designation		ØD	ØC	Ød	ℓ	L	ap		Fig.
FMRS									
5040HRD-S	2	40	24	32	40	125	8	1.4	2
5040HRD-M	2	40	24	32	70	200	8	1.8	1
5040HRD-L	2	40	24	32	150	300	8	2.0	1
5040HRD-S40	2	40	24	40	40	125	8	1.6	2
5040HRD-M40	2	40	24	40	70	200	8	2.0	1
5040HRD-L40	2	40	24	40	150	300	8	2.4	1
5040HRD-S42	2	40	24	42	40	125	8	2.0	2
5040HRD-M42	2	40	24	42	70	200	8	2.4	1
5040HRD-L42	2	40	24	42	150	300	8	2.8	1
5050HRD-S40	3	50	34	40	50	150	8	2.0	2
5050HRD-M40	3	50	34	40	50	250	8	2.4	1
5050HRD-L40	3	50	34	40	50	300	8	2.6	1
5050HRD-S	3	50	34	42	50	150	8	1.5	2
5050HRD-M	3	50	34	42	50	250	8	1.8	1
5050HRD-L	3	50	34	42	50	300	8	2.0	1
5063HRD-S40	4	63	47	40	50	150	8	1.7	2
5063HRD-M40	4	63	47	40	50	250	8	2.0	1
5063HRD-L40	4	63	47	40	50	300	8	2.3	1
5063HRD-S	4	63	47	42	50	150	8	1.6	2
5063HRD-M	4	63	47	42	50	250	8	1.8	1
5063HRD-L	4	63	47	42	50	300	8	2.0	1

Available inserts

RDHW-E,F,S RDKT-MF RDKT-ML RDKT-MM



Designation	Cermet		Coated											Uncoated		page		
	CN2000	CN30	NCM825	NC5330	NCM535	NCM545	PC2505	PC2010	PC3600	PC3700	PC6510	PC9530	PC9540	PC5300	PC5400		ST30A	H01
RDHW																		
1605M0E																		
1605M0F																		
1605M0S																		E15
RDKT																		E16
1605M0-MF																		
1605M0-MM																		
1605M0-ML																		

Parts

Specification		
Ø40~Ø63	FTGA0513-P	TW20-100

Available inserts E15, E16



FMRS6000

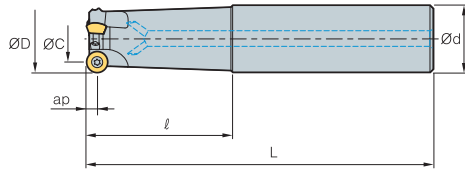

Fig. 1

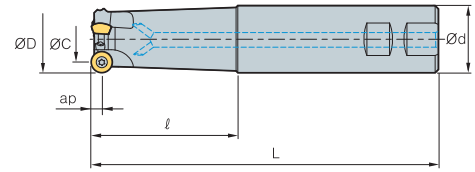

Fig. 2



• AR: 5°
• RR: -8° ~ -5°

(mm)

Designation		ØD	ØC	Ød	l	L	ap		Fig.
FMRS									
6050HRD-S40	3	50	31	40	50	150	10	1.3	2
6050HRD-S42	3	50	31	42	50	150	10	1.4	2
6050HRD-M40	3	50	31	40	50	250	10	2.2	1
6050HRD-M42	3	50	31	42	50	250	10	2.4	1
6050HRD-L40	3	50	31	40	50	300	10	2.7	1
6050HRD-L42	3	50	31	42	50	300	10	3.0	1
6063HRD-S40	4	63	44	40	50	150	10	1.5	2
6063HRD-S42	4	63	44	42	50	150	10	1.6	2
6063HRD-M40	4	63	44	40	50	250	10	2.5	1
6063HRD-M42	4	63	44	42	50	250	10	2.7	1
6063HRD-L40	4	63	44	40	50	300	10	3.0	1
6063HRD-L42	4	63	44	42	50	300	10	3.2	1

Available inserts

RDHW-E,F,S RDKT-MM



Designation	Cermet		Coated										Uncoated		page			
	CN2000	CN30	NCM325	NC5330	NCM535	NCM545	PC2505	PC2010	PC3600	PC3700	PC6510	PC9530	PC9540	PC5300		PC5400	ST30A	H01
RDHW																		
2006MOE																		
2006MOF																		E15
2006MOS																		E16
RDKT										●								
2006M0-MM																		

Parts

Specification		
Ø50~Ø63	FTGA0515-P	TW20-100

Available inserts E15, E16

FMRM1000/1500

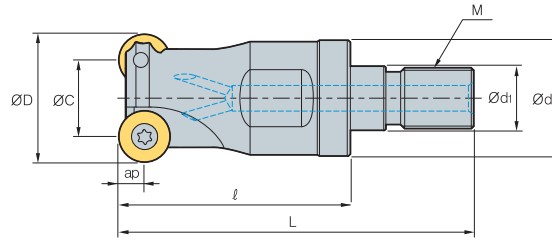

• AR: 0°~5°
• RR: -5°~-1°

(mm)

Designation		ØD	ØC	Ød	Ød1	ℓ	L	M	ap		
FMRM	1008HRD-M06	1	8	5.5	9.5	6.5	25	40	M06	2.5	0.02
	1010HRD-M06	2	10	5	9.5	6.5	25	40	M06	2.5	0.02
	1012HRD-M06	2	12	7	11	6.5	25	40	M06	2.5	0.02
	1015HRD-M08	3	15	10	14.5	8.5	30	47	M08	2.5	0.04
	1510HRD-M06	1	10	7	9.5	6.5	25	40	M06	3.0	0.02
	1512HRD-M06	2	12	6	11	6.5	25	40	M06	3.0	0.02
	1516HRD-M08	3	16	10	14.5	8.5	30	47	M08	3.0	0.02
	1520HRD-M10	3	20	14	18	10.5	35	56	M10	3.0	0.07

Available inserts

RDHW-E,F,S RDKW



Type	Designation	Cermet		Coated										Uncoated		page			
		CN2000	CN80	NCM325	NC5330	NCM535	NCM545	PC2505	PC2010	PC3600	PC3700	PC6510	PC9530	PC9540	PC5300		PC5400	ST30A	H01
1000 type	RDHW 0501M0E																		E15 E16
	0501M0F																		
	0501M0S																		
RDKW 0501M0E																			
1500 type	RDHW 06T1M0E																		
	06T1M0F																		
	06T1M0S																		
RDKW 06T1M0E																			

Available adaptor

Designation	Available adaptor
FMRM 1008HRD-M06	MAT-M06
1010HRD-M06	
1012HRD-M06	
1015HRD-M08	MAT-M08
1510HRD-M06	MAT-M06
1512HRD-M06	
1515HRD-M08	MAT-M08
1520HRD-M10	MAT-M10

Designation: FMRM1008HRD-M06
Modular head threading measure size (M06)

||

Adaptor spec.: MAT-M06-020-S10S
Adaptor threading measure (M06)

Parts

Specification		
Ø8~Ø15 (1000 type)	FTNA0203	TW06P
Ø10~Ø20 (1500 type)	FTNA02205	TW06P

Available inserts E15, E16 Available adaptor E371~E372



FMRM2000/2500

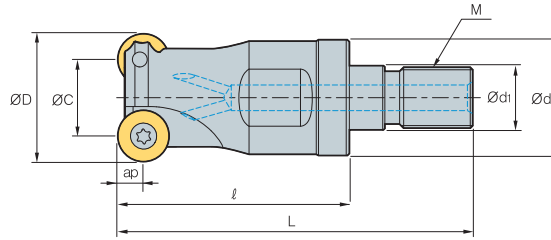

• AR: 0°~5°
• RR: -5°~ -1°

Designation		⚙️	ØD	ØC	Ød	Ød1	ℓ	L	M	ap	⚖️ (mm)
FMRM	2015HRD-M08	2	15	8	14.5	8.5	30	47	M08	3.5	0.04
	2020HRD-M10	3	20	13	18	10.5	35	56	M10	3.5	0.07
	2516HRD-M08	2	16	8	14.5	8.5	30	47	M08	4.0	0.04
	2520HRD-M10	2	20	12	18	10.5	35	56	M10	4.0	0.07
	2525HRD-M12	3	25	17	22.5	12.5	45	69	M12	4.0	0.13

Available inserts

RDHW-E,FS RDKW



Type	Designation	Cermet		Coated											Uncoated		page			
		CN2000	CN30	NCM325	NC5330	NCM535	NCM545	PC2505	PC2010	PC3600	PC3700	PC6510	PC9530	PC9540	PC5300	PC5400		ST30A	H01	
2000 type	RDHW	0702M0E																		E15 E16
		0702M0F																		
		0702M0S																		
2500 type	RDKW	0702M0E																		
	RDHW	0803M0E																		
		0803M0F																		
		0803M0S																		
	RDKW	0803M0E																		

Available adaptor

Designation	Available adaptor
FMRM 2015HRD-M08	MAT-M08
2020HRD-M10	MAT-M10
2516HRD-M08	MAT-M08
2520HRD-M10	MAT-M10
2525HRD-M12	MAT-M12

Designation: FMRM1008HRD-M06
Modular Head Threading Measure size (M06)

||

Adaptor spec.: MAT-M06-020-S10S
Adaptor Threading Measure (M06)

Parts

Specification	Screw	Wrench
Ø15~Ø20 (2000 type)	FTNA02555	TW07S
Ø16~Ø25 (2500 type)	FTNA0305	TW09S

Available inserts E15, E16 Available adaptor E371~E372

FMRM3000

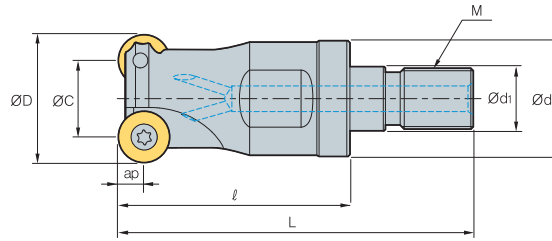

• AR: 5°
• RR: -8° ~ -5°

(mm)

Designation		ØD	ØC	Ød	Ød1	l	L	M	ap	
FMRM	3021HRD-M10	2	21	11	18	10.5	35	M10	5.0	0.1
	3025HRD-M12	2	25	15	22.5	12.5	45	M12	5.0	0.15
	3032HRD-M16	3	32	22	29	17	50	M16	5.0	0.2
	3042HRD-M16	4	42	32	29	17	50	M16	5.0	0.24

Available inserts

RDHW-E,F,S RDCT-MA RDKT-MF RDKT-ML RDKT-MM



Designation	Cermet		Coated											Uncoated		page			
	CN2000	CN30	NCM325	NC5330	NCM535	NCM545	PC2505	PC2010	PC3600	PC3700	PC6510	PC9530	PC9540	PC5300	PC5400		ST30A	H01	
RDCT	10T3M0-MA																	●	E15 E16
RDKT	10T3M0-MF																		
	10T3M0-MM			●						●	●	●		●					

Available adaptor

Designation	Available adaptor	
FMRM	3021HRD-M10	MAT-M10
	3025HRD-M12	MAT-M12
	3032HRD-M16	MAT-M16
	3042HRD-M16	

Designation: FMRM1008HRD-M06
Modular Head Threading Measure size (M06)

II

Adaptor spec.: MAT-M06-020-S10S
Adaptor Threading Measure (M06)

Parts

Specification		
Ø21 Ø25-Ø42	FTGA03507 FTGA03508	TW15S

Available inserts E15, E16 Available adaptor E371~E372



FMRM4000/5000

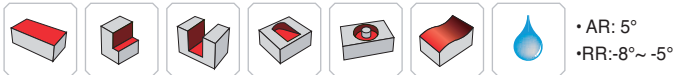
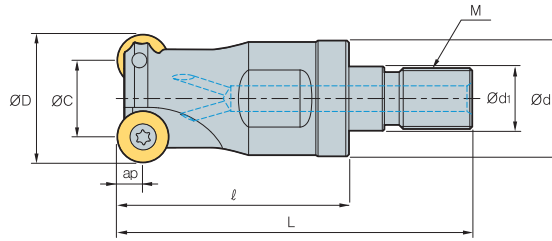

Designation			ØD	ØC	Ød	Ød ₁	ℓ	L	M	ap	
FMRM	4025HRD-M12	2	25	13	22.5	12.5	45	69	M12	6.0	0.12
	4032HRD-M16	2	32	20	29	17	50	77	M16	6.0	0.22
	4040HRD-M16	3	40	28	29	17	50	77	M16	6.0	0.23
	4042HRD-M16	4	42	28	29	17	50	77	M16	6.0	0.25
	5040HRD-M16	2	40	24	29	17	50	77	M16	8.0	0.25

Available inserts



Type	Designation	Cermet		Coated											Uncoated		page				
		CN2000	CN30	NCM325	NC5330	NCM535	NCM545	PC2505	PC2010	PC3600	PC3700	PC6510	PC9530	PC9540	PC5300	PC5400		ST30A	H01		
4000 type	RDCT 1204M0-MA																				
	RDKT 1204M0-MF																				
	1204M0-MM																				
5000 type	RDHW 1605M0-E																				
	RDKT 1605M0-MF																				
	1605M0-ML																				
	1605M0-MM																				

Available adaptor

Designation	Available adaptor
FMRM 4025HRD-M12	MAT-M12
4032HRD-M16	
4040HRD-M16	MAT-M16
4042HRD-M16	
5040HRD-M16	MAT-M16

Designation: FMRM1008HRD-M06
Modular head threading measure size (M06)

II

Adaptor spec.: MAT-M06-020-S10S
Adaptor threading measure (M06)

Parts

Specification		
Ø25~Ø42 (4000 type)	FTKA0410	TW15S
Ø40 (5000 type)	FTGA0513-P	TW20-100

Available inserts E15, E16 Available adaptor E371~E372

FMRCM3000 new

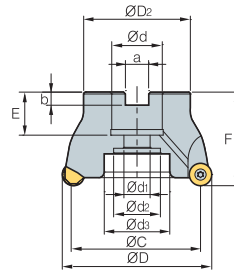

• AR: 5°
• RR: -4°~0°

(mm)

Designation		ØD	ØC	ØD ₂	Ød	Ød ₁	Ød ₂	d ₃	a	b	E	F	ap		Insert size	
FMRCM	3040HRP-5	5	40	30	38	16	9	14	-	8.4	5.6	19	40	5	0.22	10
	3050HRP-6	6	50	40	45	22	11	18	-	10.4	6.3	20	40	5	0.35	10
	3052HRP-6	6	52	42	45	22	11	18	-	10.4	6.3	20	40	5	0.37	10
	3063HRP-6	6	63	53	50	22	11	18	-	10.4	6.3	20	40	5	0.55	10
	3063HRP-7	7	63	53	50	22	11	18	-	10.4	6.3	20	40	5	0.56	10
	3066HRP-7	7	66	56	50	22	11	18	-	10.4	6.3	20	40	5	0.60	10

Available inserts

		RPCT-MA	RPET-ML	RPMT-MF	RPMT-MM	RPMW													
Designation		Cermet		Coated								Uncoated		page					
		CN2000	CN80	NCM325	NC5330	NCM535	NCM545	PC2505	PC2510	PC3600	PC3700	PC6510	PC9530		PC9540	PC5300	PC5400	ST30A	H01
RPCT	10T3M0-MA																		E16
RPET	10T3M0E-ML														●	●		●	
RPMT	10T3M0E-MF														●	●			
	10T3M0S-MM														●	●			
RPMW	10T3M0E1														●	●			

Available arbors

Designation	Ød	NC arbors
FMRCM 3040HRP-5	16	BT□□-FMC16-□□
3050HRP-6	22	BT□□-FMC22-□□
3052HRP-6	22	BT□□-FMC22-□□
3063HRP-6	22	BT□□-FMC22-□□
3063HRP-7	22	BT□□-FMC22-□□
3066HRP-7	22	BT□□-FMC22-□□

Parts

Specification		
Ø40~Ø66	FTGA03508	TW15S

Available inserts E16 Available arbors and bolt E400~E402



FMRC(M)4000 new

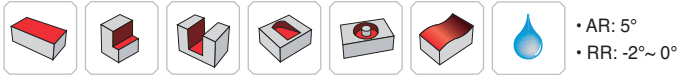
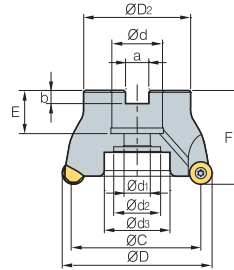

Designation		⚙️	ØD	ØC	ØD2	Ød	Ød1	Ød2	Ød3	a	b	E	F	ap	kg	Insert size
FMRCM	4050HRP-4	4	50	38	45	22	11	18	-	10.4	6.3	20	40	6	0.26	12
	4050HRP-5	5	50	38	45	22	11	18	-	10.4	6.3	20	40	6	0.28	12
	4052HRP-5	5	52	40	45	22	11	18	-	10.4	6.3	20	40	6	0.30	12
	4063HRP-5	5	63	51	50	22	11	18	-	10.4	6.3	20	40	6	0.44	12
	4063HRP-6	6	63	51	50	22	11	18	-	10.4	6.3	20	40	6	0.48	12
	4066HRP-6	6	66	54	50	22	11	18	-	10.4	6.3	20	40	6	0.50	12
FMRC (FMRCM)	4080HRP-6	6	80	68	57	25.4 (27)	14	25	35	9.5 (12.4)	6 (7)	24 (23)	50	6	0.92	12
	4080HRP-7	7	80	68	57	25.4 (27)	14	25	35	9.5 (12.4)	6 (7)	24 (23)	50	6	0.90	12
	4100HRP-7	7	100	88	67	31.75 (32)	18	26	42	12.7 (14.4)	8 (8)	32 (25)	63 (53)	6	1.46	12

() Metric size

Available inserts

		RPCT-MA		RPET-ML		RPMT-MF		RPMT-MM		RPMW									
Designation		Cermet		Coated								Uncoated		page					
		CN2000	CN30	NCM325	NC330	NCM535	NCM545	PC2505	PC2510	PC3600	PC3700	PC6510	PC9530		PC9540	PC5300	PC5400	ST30A	H01
RPCT	1204M0-MA																		
RPET	1204M0E-ML																		
RPMT	1204M0E-MF																		
	1204M0S-MM																		
RPMW	1204M0S1																		
	1204M0S2																		

Available arbors

Designation		Ød	Available arbors
FMRCM	4050HRP-4	22	BT□□-FMC22-□□
	4050HRP-5		
	4052HRP-5		
	4063HRP-5		
	4063HRP-6		
	4066HRP-6		
FMRC (FMRCM)	4080HRP-6	25.4	BT□□-FMA25.4-□□
		27	BT□□-FMC27-□□
	4080HRP-7	25.4	BT□□-FMA25.4-□□
		27	BT□□-FMC27-□□
	4100HRP-7	31.75	BT□□-FMA31.75-□□
		32	BT□□-FMC32-□□

Parts

Specification		
Ø50~Ø100	FTKA0410	TW15S

Available inserts E16 Available arbors and bolt E400~E402

FMRC(M)5000 new

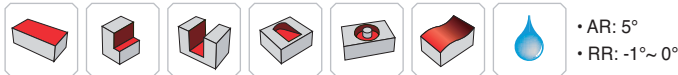
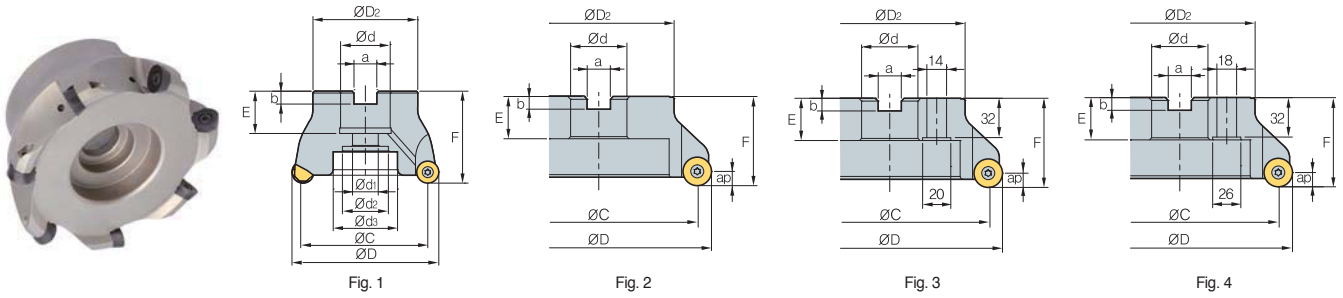

Designation		ØD	ØC	ØD ₂	Ød	Ød ₁	Ød ₂	Ød ₃	a	b	E	F	ap	kg	Fig.	Insert size	
FMRCM	5063HRP-4	4	63	47	50	22	11	18	-	10.4	6.3	20	40	8	0.43	1	16
	5063HRP-5	5	63	47	50	22	11	18	-	10.4	6.3	20	40	8	0.44	1	16
	5066HRP-5	5	66	50	50	22	11	18	-	10.4	6.3	20	40	8	0.48	1	16
FMRC (FMRCM)	5080HRP-5	5	80	64	57	25.4 (27)	14	25	35	9.5 (12.4)	6 (7)	24 (23)	50	8	0.77	1	16
	5080HRP-6	6	80	64	57	25.4 (27)	14	25	35	9.5 (12.4)	6 (7)	24 (23)	50	8	0.82	1	16
	5100HRP-6	6	100	84	67	31.75 (32)	18	26	42	12.7 (14.4)	8 (8)	32 (25)	63 (55)	8	1.42	1	16
	5125HRP-7	7	125	109	87	38.1 (40)	22	32	52	15.9 (16.4)	10 (9)	35 (29)	68 (63)	8	2.78	1	16
	5125HRP-8	8	125	109	87	38.1 (40)	22	32	52	15.9 (16.4)	10 (9)	35 (29)	68 (63)	8	2.79	1	16
	5160RP-8	8	160	144	107	50.8 (40)	-	-	100	19 (16.4)	11 (9)	38 (32)	63	8	4.01	2 (3)	16

()Metric size

Available inserts

		RPCT-MA	RPET-ML	RPMT-MF	RPMT-MM	RPMW												
Designation		Cermet		Coated										Uncoated		page		
		CN2000	CN30	NCM325	NC5330	NCM635	NCM545	PC2505	PC2510	PC3600	PC3700	PC6510	PC9530	PC9540	PC5300		PC5400	ST30A
RPCT	1606M0-MA																	
RPET	1606M0E-ML																	
RPMT	1606M0E-MF																	
	1606M0S-MM																	
RPMW	1606M0S1																	

Available arbors

Designation	Ød	Available arbors
FMRCM	5063HRP-4	BT□□-FMC22-□□
	5063HRP-5	
	5066HRP-5	
FMRC (FMRCM)	5080HRP-5	BT□□-FMA25.4-□□ BT□□-FMC27-□□
	5080HRP-6	BT□□-FMA25.4-□□ BT□□-FMC27-□□
	5100HRP-6	BT□□-FMA31.75-□□ BT□□-FMC32-□□
	5125HRP-7	BT□□-FMA38.1-□□ BT□□-FMC40-□□
	5125HRP-8	BT□□-FMA38.1-□□ BT□□-FMC40-□□
	5160RP-8	BT□□-FMA50.8-□□ BT□□-FMC40-□□

Parts

Specification	Screw	Wrench
Ø63~Ø160	FTGA0512-P	TW20-100

Available inserts E16 Available arbors and bolt E400~E402



FMRC(M)6000 new

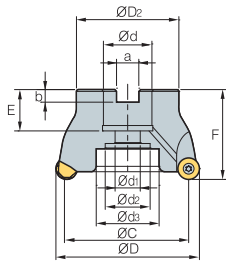

Fig. 1

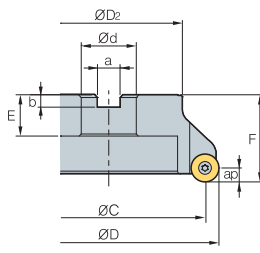

Fig. 2

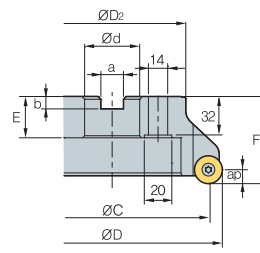

Fig. 3

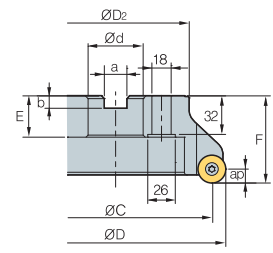

Fig. 4



• AR: 5°
• RR: 0°

Designation		ØD	ØC	ØD ₂	Ød	Ød ₁	Ød ₂	Ød ₃	a	b	E	F	ap	kg	Fig.	Insert size	
FMRCM	6063HRP-4	4	63	43	50	22	11	18	-	10.4	6.3	20	40	10	0.37	1	20
FMRC	6080HRP-5	5	80	60	57	25.4 (27)	14	25	35	9.5 (12.4)	6 (7)	24 (23)	50	10	0.87	1	20
FMRCM	6100HRP-5	5	100	80	67	31.75 (32)	18	26	42	12.7 (14.4)	8 (8)	32 (25)	63 (55)	10	1.31	1	20
	6100HRP-6	6	100	80	67	31.75 (32)	18	26	42	12.7 (14.4)	8 (8)	32 (25)	63 (55)	10	1.40	1	20
	6125HRP-5	5	125	105	87	38.1 (40)	22	32	52	15.9 (16.4)	10 (9)	35 (29)	68 (63)	10	2.77	1	20
	6125HRP-7	7	125	105	87	38.1 (40)	22	32	52	15.9 (16.4)	10 (9)	35 (29)	68 (63)	10	2.89	1	20
	6160RP-6	6	160	140	107	50.8 (40)	-	-	100	19 (16.4)	11 (9)	38 (32)	63	10	3.58	2 (3)	20
	6160RP-8	8	160	140	107	50.8 (40)	-	-	100	19 (16.4)	11 (9)	38 (32)	63	10	3.53	2 (3)	20
	6200RP-8	8	200	180	130	47.625 (60)	-	-	132	25.4 (25.7)	14 (14)	38	63	10	5.15	4	20
	6250RP-9	9	250	230	180	47.625 (60)	-	-	180	25.4 (25.7)	14 (14)	38	63	10	9.72	4	20

() Metric size

Available inserts



Designation	Cermet		Coated										Uncoated		page			
	CN2000	CN30	NCM625	NC5330	NCM635	NCM645	PC2505	PC2510	PC3600	PC3700	PC6510	PC9530	PC9540	PC5300		PC5400	ST30A	H01
RPCT 2007M0-MA																		
RPET 2007M0E-ML														●	●			
RPMT 2007M0E-MF									●					●	●			
2007M0S-MM							●	●	●	●				●	●			
RPMW 2007M0S1							●	●	●					●	●			

Available arbors

Designation	Ød	Available arbors	Designation	Ød	Available arbors
FMRCM 6063HRP-4	22	BT□□-FMC22-□□	FMRC (FMRCM) 6125HRP-7	38.1	BT□□-FMA38.1-□□
FMRC 6080HRP-5	25.4	BT□□-FMA25.4-□□		40	BT□□-FMC40-□□
FMRCM 6100HRP-5	27	BT□□-FMC27-□□	6160RP-6	50.8	BT□□-FMA50.8-□□
	31.75	BT□□-FMA31.75-□□		40	BT□□-FMC40-□□
6100HRP-6	32	BT□□-FMC32-□□	6160RP-8	50.8	BT□□-FMA50.8-□□
	31.75	BT□□-FMA31.75-□□		40	BT□□-FMC40-□□
6125HRP-5	32	BT□□-FMC32-□□	6200RP-8	47.625	BT□□-FMA47.625-□□
	38.1	BT□□-FMA38.1-□□		60	BT□□-FMC60-□□
	40	BT□□-FMC40-□□	6250RP-9	47.625	BT□□-FMA47.625-□□
				60	BT□□-FMC60-□□

Parts

Specification	Screw	Wrench
Ø63~Ø250	FTKA0615-P	TW25-100

Available inserts E16 Available arbors and bolt E400~E402

FMRS2500 new

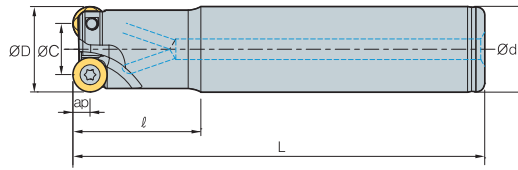

- AR: -4°
- RR: -4° ~ -1°

(mm)

Designation			ØD	ØC	Ød	l	L	ap		Insert size
FMRS	2517HRP-2S16	2	17	9	16	35	90	4	0.11	8
	2517HRP-2M16	2	17	9	16	35	150	4	0.20	8
	2517HRP-2L16	2	17	9	16	35	200	4	0.27	8
	2518HRP-2M16	2	18	10	16	35	150	4	0.20	8
	2518HRP-2L16	2	18	10	16	35	200	4	0.28	8
	2520HRP-3S20	3	20	12	20	35	130	4	0.27	8
	2520HRP-3M20	3	20	12	20	100	180	4	0.36	8
	2520HRP-3L20	3	20	12	20	130	250	4	0.50	8
	2521HRP-3S20	3	21	13	20	35	130	4	0.28	8
	2521HRP-3M20	3	21	13	20	35	180	4	0.40	8
	2521HRP-3L20	3	21	13	20	35	250	4	0.55	8
	2525HRP-4S25	4	25	17	25	35	150	4	0.48	8
	2525HRP-4M25	4	25	17	25	60	180	4	0.60	8
	2525HRP-4L25	4	25	17	25	130	250	4	0.81	8
	2526HRP-4S25	4	26	18	25	35	150	4	0.48	8
2526HRP-4L25	4	26	18	25	130	250	4	0.85	8	

Available inserts



Designation	Cermet		Coated											Uncoated		page		
	CN2000	CN30	NCM325	NC5330	NCM635	NCM545	PC2505	PC2510	PC3600	PC3700	PC6510	PC9530	PC9540	PC5300	PC5400		ST30A	H01
RPET 0803M0E-ML														●	●			E16
RPMT 0803M0E-MF								●						●	●			
0803M0S-MM							●	●	●					●	●			
RPMW 0803M0E1							●	●	●					●	●			

Parts

Specification		
Ø17 Ø18-Ø26	FTNA0305 FTNA0306	TW09S

Available inserts E16



FMRS3000 new

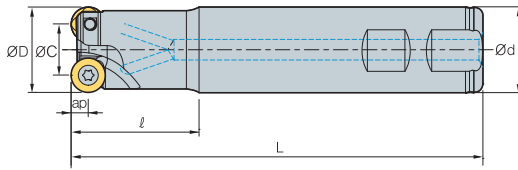

Fig. 1

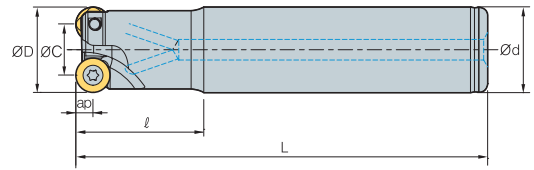
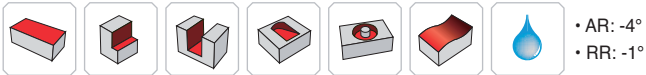

Fig. 2



• AR: -4°
• RR: -1°

(mm)

Designation		ØD	ØC	Ød	l	L	ap		Fig.	Insert size
FMRS 3025HRP-2M20	2	25	15	20	40	170	5	0.40	2	10
3025HRP-2S25	2	25	15	25	40	120	5	0.39	1	10
3025HRP-2M25	2	25	15	25	60	160	5	0.52	2	10
3025HRP-2L25	2	25	15	25	130	250	5	0.80	2	10
3026HRP-2L25	2	26	16	25	30	200	5	0.69	2	10
3032HRP-3S32	3	32	22	32	40	125	5	0.68	1	10
3032HRP-3L32	3	32	22	32	60	200	5	1.08	2	10
3032HRP-4S32	4	32	22	32	40	125	5	0.66	1	10
3032HRP-4L25	4	32	22	25	60	200	5	0.74	2	10
3033HRP-4S32	4	33	23	32	40	125	5	0.67	1	10
3033HRP-4M32	4	33	23	32	60	180	5	1.00	2	10
3033HRP-4L32	4	33	23	32	180	300	5	1.64	2	10

Available inserts

RPCT-MA RPET-ML RPMT-MF RPMT-MM RPMW



Designation	Cermet		Coated										Uncoated		page			
	CN2000	CN30	NCM325	NC5330	NCM535	NCM545	PC2505	PC2510	PC3600	PC3700	PC6510	PC9530	PC9540	PC5300		PC5400	ST30A	H01
RPCT 10T3M0-MA																		
RPET 10T3M0E-ML														●	●		●	
RPMT 10T3M0E-MF														●	●			
10T3M0S-MM							●	●	●	●				●	●			
RPMW 10T3M0E1							●	●	●					●	●			

Parts

Specification		
Ø25~Ø26	FTGA03507	TW15S
Ø32~Ø33	FTGA03508	

Available inserts E16

FMRS4000 new

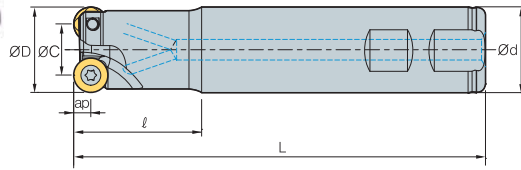

Fig. 1

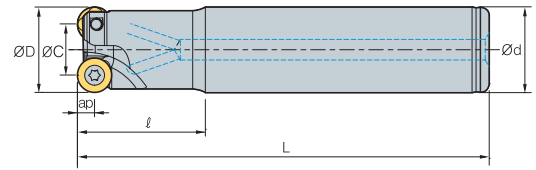

Fig. 2



- AR: -4°
- RR: -2°~0°

(mm)

Designation		ØD	ØC	Ød	ℓ	L	ap		Fig.	Insert size
FMRS 4025HRP-2S25	2	25	13	25	60	160	6	0.46	1	12
4026HRP-2L25	2	26	14	25	60	200	6	0.48	2	12
4032HRP-2L25	2	32	20	25	40	190	6	0.68	2	12
4032HRP-2S32	2	32	20	32	50	125	6	0.64	1	12
4032HRP-2L32	2	32	20	32	50	250	6	1.40	2	12
4032HRP-3S32	3	32	20	32	50	125	6	0.64	1	12
4032HRP-3M32	3	32	20	32	60	160	6	0.85	2	12
4033HRP-3M32	3	33	21	32	60	200	6	1.01	2	12
4033HRP-3L32	3	33	21	32	60	300	6	1.67	2	12
4040HRP-3S32	3	40	28	32	35	105	6	0.60	1	12
4040HRP-3M32	3	40	28	32	50	160	6	0.96	2	12
4040HRP-4S32	4	40	28	32	35	105	6	0.60	1	12
4040HRP-4M32	4	40	28	32	35	150	6	0.87	2	12
4040HRP-4L32	4	40	28	32	35	250	6	1.46	2	12
4050HRP-4M32	4	50	38	32	50	150	6	1.10	2	12
4050HRP-4M40	4	50	38	40	50	150	6	1.44	2	12
4050HRP-4M42	4	50	38	42	50	150	6	1.55	2	12

Available inserts

RPCT-MA RPET-ML RPMT-MF RPMT-MM RPMW



Designation	Cermet		Coated											Uncoated		page		
	CN2000	CN30	NCM825	NC5330	NCM535	NCM545	PC2505	PC2510	PC3600	PC3700	PC6510	PC9530	PC9540	PC5300	PC5400		ST30A	H01
RPCT 1204M0-MA																		
RPET 1204M0E-ML														●	●			
RPMT 1204M0E-MF									●					●	●			
1204M0S-MM							●	●	●	●			●	●	●			
RPMW 1204M0S1							●	●	●	●				●	●			
1204M0S2														●	●			

Parts

Specification		
Ø25-Ø26	FTKA0408	TW15S
Ø32-Ø50	FTKA0410	TW15S

Available inserts E16



FMRS5000/6000 **new**

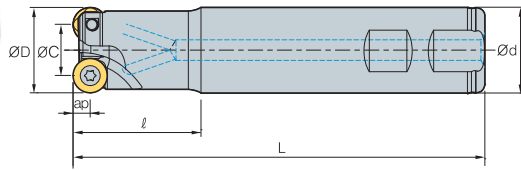

Fig. 1

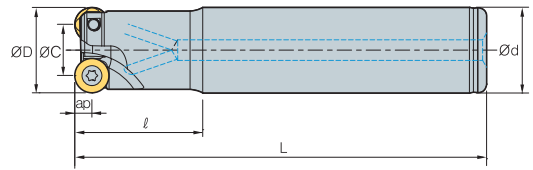
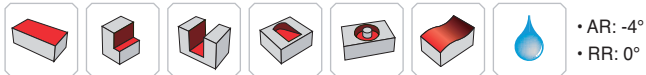

Fig. 2



(mm)

Designation		ØD	ØC	Ød	l	L	ap		Insert size	Fig.	
FMRS	5040HRP-2M32	2	40	24	32	50	160	8	0.92	16	2
	5040HRP-2L32	2	40	24	32	50	250	8	1.45	16	2
	5050HRP-3M40	3	50	34	40	50	160	8	1.48	16	2
	5050HRP-3L40	3	50	34	40	50	300	8	2.86	16	2
	6050HRP-3S32	3	50	30	32	50	160	10	1.06	20	1
	6050HRP-3M32	3	50	30	32	50	200	10	1.30	20	2
	6050HRP-3S40	3	50	30	40	50	125	10	1.45	20	1
	6050HRP-3M40	3	50	30	40	50	200	10	1.85	20	2

Available inserts



Type	Designation	Cermet		Coated										Uncoated		page			
		CN2000	CN30	NCM325	NC5330	NCM635	NCM545	PC2505	PC2510	PC3600	PC3700	PC6510	PC9530	PC9540	PC5300		PC5400	ST30A	H01
5000 type	RPCT 1606M0-MA																	●	E16
	RPET 1606M0E-ML														●	●			
	RPMT 1606M0E-MF								●						●	●			
	RPMT 1606M0S-MM							●	●	●	●				●	●			
RPMW 1606M0S1							●	●	●					●	●				
5000 type	RPCT 2007M0-MA																	●	E16
	RPET 2007M0E-ML														●	●			
	RPMT 2007M0E-MF								●						●	●			
	RPMT 2007M0S-MM							●	●	●	●				●	●			
RPMW 2007M0S1							●	●	●					●	●				

Parts

Specification		
Ø40~Ø50 (5000 type)	FTGA0511-P	TW20-100
Ø50 (6000 type)	FTKA0615-P	TW25-100

Available inserts E16

FMRM2500 new

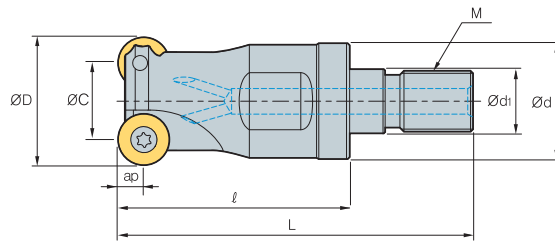

• AR: -4°
• RR: -4°~0°

(mm)

Designation		ØD	ØC	Ød	Ød ₁	l	L	M	ap		Insert size	
FMRM	2517HRP-M08	2	17	9	14.5	8.5	25	42	M08	4	0.03	8
	2521HRP-M10	3	21	13	18	10.5	30	51	M10	4	0.06	8
	2526HRP-M12	4	26	18	23	12.5	35	59	M12	4	0.11	8
	2533HRP-M16	4	33	25	29	17	40	67	M16	4	0.22	8
	2540HRP-M16	5	40	32	29	17	40	67	M16	4	0.26	8

Available inserts

RPCT-MA RPET-ML RPMT-MF RPMT-MM RPMW



Designation	Cermet		Coated										Uncoated		page			
	CN2000	CN80	NCM825	NC5330	NCM635	NCM545	PC2505	PC2510	PC3600	PC3700	PC6510	PC9530	PC9540	PC5300		PC5400	ST30A	H01
RPET 0803M0E-ML														●	●			E16
RPMT 0803M0E-MF									●					●	●			
0803M0S-MM							●	●	●					●	●			
RPMW 0803M0E1							●	●	●					●	●			

Parts

Specification		
Ø17 Ø21~Ø40	FTNA0305 FTNA0306	TW09S

Available inserts E16 Available adaptor E371~E372



FMRM3000 new

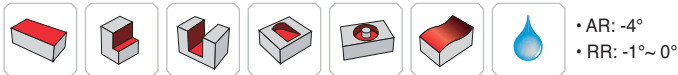
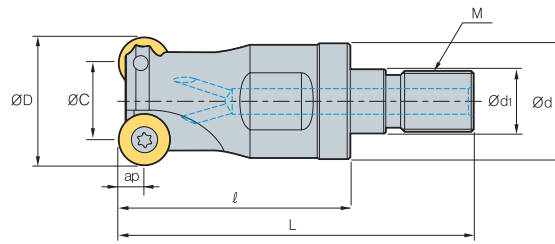

Designation			ØD	ØC	Ød	Ød ₁	ℓ	L	M	ap		Insert size
FMRM	3026HRP-M12	3	26	16	23	12.5	35	59	M12	5	0.10	10
	3033HRP-M16	3	33	23	29	17	40	67	M16	5	0.20	10
	3035HRP-M16	3	35	25	29	17	40	67	M16	5	0.22	10
	3040HRP-M16	3	40	30	29	17	40	67	M16	5	0.25	10
	3042HRP-M16	3	42	32	29	17	40	67	M16	5	0.27	10

Available inserts

		RPCT-MA		RPET-ML		RPMT-MF		RPMT-MM		RPMW									
Designation		Cermet		Coated								Uncoated		page					
		CN2000	CN30	NCM325	NC5330	NCM535	NCM545	PC2505	PC2510	PC3600	PC3700	PC6510	PC9530		PC9540	PC5300	PC5400	ST30A	H01
RPCT	10T3M0-MA																		
RPET	10T3M0E-ML														●	●			
RPMT	10T3M0E-MF									●					●	●			
	10T3M0S-MM							●	●	●	●				●	●			
RPMW	10T3M0E1							●	●	●					●	●			

Parts

Specification		
Ø26 Ø33~Ø42	FTGA03507 FTGA03508	TW15S

Available inserts E16 Available adaptor E371~E372

FMRM4000 new

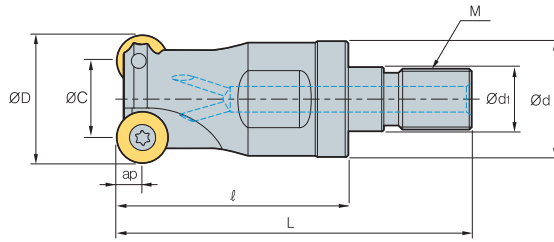

• AR: -4°
• RR: 0°

(mm)

Designation												Insert size
FMRM	4026HRP-M12	2	26	14	23	12.5	35	59	M12	6	0.10	12
	4033HRP-M16	3	33	21	29	17	40	67	M16	6	0.21	12
	4035HRP-M16	3	35	23	29	17	40	67	M16	6	0.21	12
	4040HRP-M16	4	40	28	29	17	40	67	M16	6	0.24	12
	4042HRP-M16	4	42	30	29	17	40	67	M16	6	0.25	12

Available inserts

RPCT-MA RPET-ML RPMT-MF RPMT-MM RPMW



Designation	Cermet		Coated										Uncoated		page			
	CN2000	CN30	NCM325	NC5330	NCM535	NCM545	PC2505	PC2510	PC3600	PC3700	PC6510	PC9530	PC9540	PC5300		PC5400	ST30A	H01
RPCT 1204M0-MA																		●
RPET 1204M0E-ML														●	●			
RPMT 1204M0E-MF									●					●	●	●		
1204M0S-MM							●	●	●	●				●	●	●		
RPMW 1204M0S1							●	●	●	●				●	●			
1204M0S2														●	●			

Parts

Specification		
Ø26 Ø33-Ø42	FTKA0408 FTKA0410	TW15S

Available inserts E16 Available adaptor E371-E372



FMRM5000 new

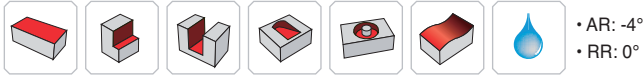
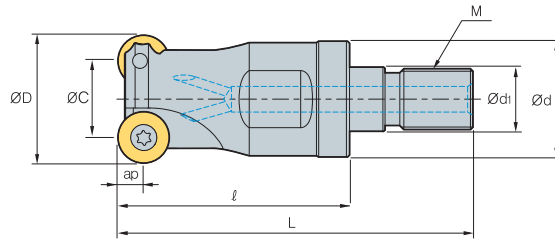

Designation		Flutes	ØD	ØC	Ød	Ød ₁	ℓ	L	M	ap	Weight (kg)	Insert size
FMRM	5040HRP-M16	2	40	24	29	17	40	67	M16	8	0.21	16
	5042HRP-M16	2	42	26	29	17	40	67	M16	8	0.23	16

Available inserts

		RPCT-MA		RPET-ML		RPMT-MF		RPMT-MM		RPMW								
Designation		Cermet		Coated								Uncoated		page				
		CN2000	CN30	NCM325	NC5330	NCM535	NCM545	PC2505	PC2510	PC3600	PC3700	PC6510	PC9530	PC9540	PC5300	PC5400	ST30A	H01
RPCT	1606M0-MA																	●
RPET	1606M0E-ML														●	●		
RPMT	1606M0E-MF									●					●	●		
	1606M0S-MM							●	●	●	●				●	●		
RPMW	1606M0S1							●	●	●					●	●		

Parts

Specification	Screw	Wrench	Wrench
Ø40~Ø42	FTGA0511-P	-	TW20-100

Available inserts **E16** Available adaptor **E371~E372**

E Technical Information for HFMD

High Feed Milling Tool with 4 Corners for Small Diameter

HFMD new

- Economical 4-corner double sided insert
- Increased productivity due to thinner and elongated shape of the insert which makes fine pitch available
- Insert designed for low cutting resistance with high rake angle and helix angle which reduces cutting load
- Inhibiting chipping and breakage due to concave clamping system and stronger screw

Code system

• Shank type

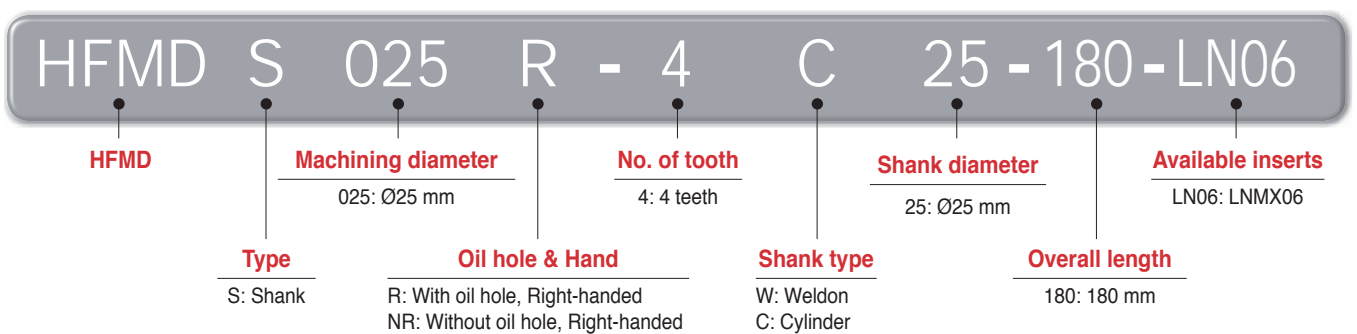

• Cutter type

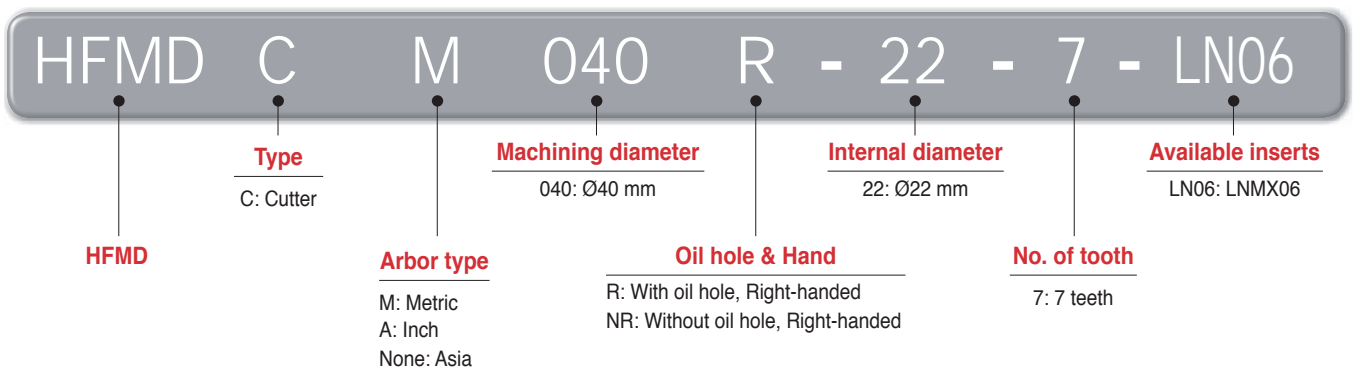

• Modular type

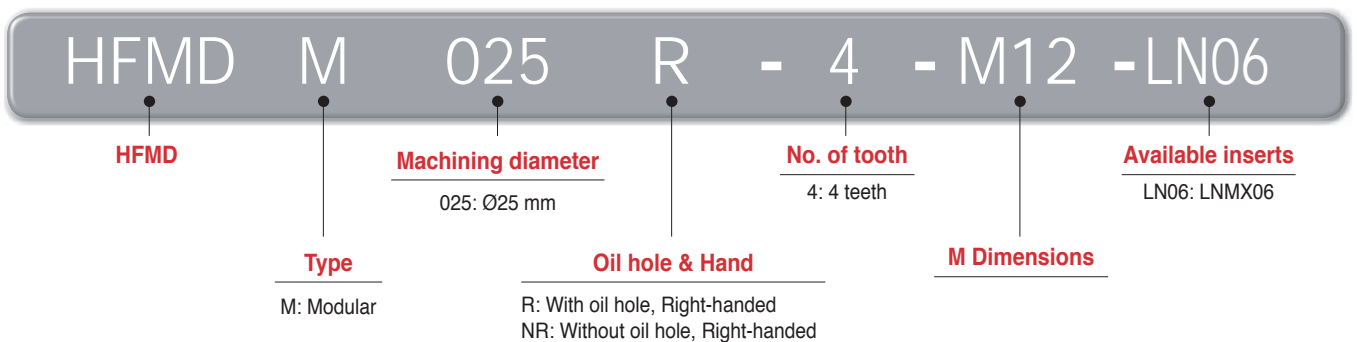

Features

Highly efficient insert due to fine pitch

- Able to use fine pitch at the same machining diameter with typical types of milling cutters due to smaller inscribed circle ($A < B$)

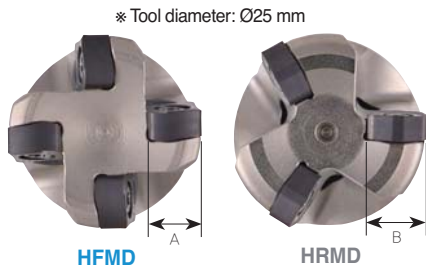

Economical 4-corner insert

- Can use 4 corners with 1 insert by utilizing front/back face; High feed due to finer pitch



Insert with strong clamping force

- ① Concave clamping system ② Wider bottom face clamping area ③ Applied a bigger size of screw

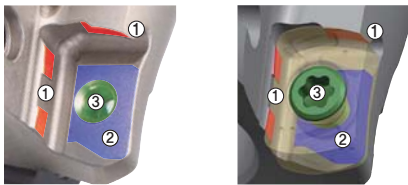

Insert designed for low cutting resistance

- High rake angle and helix angle minimize cutting resistance compared to competitors' products and positive type of inserts

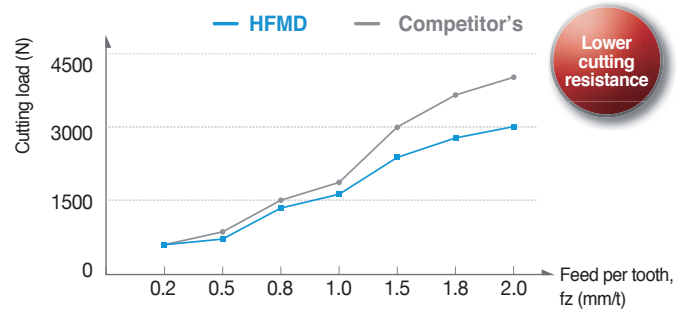

Features of chip breaker

Insert	Cutting-edge	Uses	Features
ML		For hard-to-cut materials For Ti & inconel	Ensures superior machining quality by applying a low cutting resistance chip breaker and high-strength cutting edge design suitable for machining hard-to-cut materials
MF		For light cutting	Suitable for light cutting with a low cutting resistance chip breaker design
MM		For multi-purpose	Available for most cutting area with its exclusive design suitable for general high feed machining

Application area

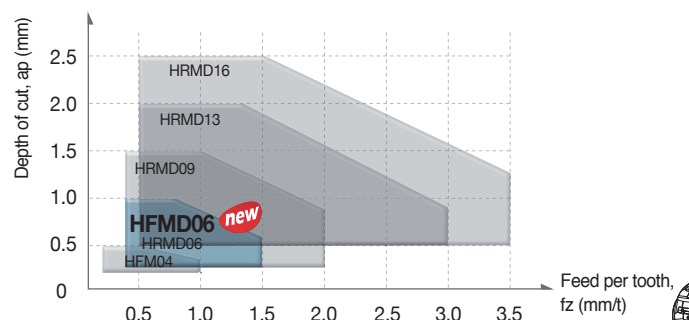
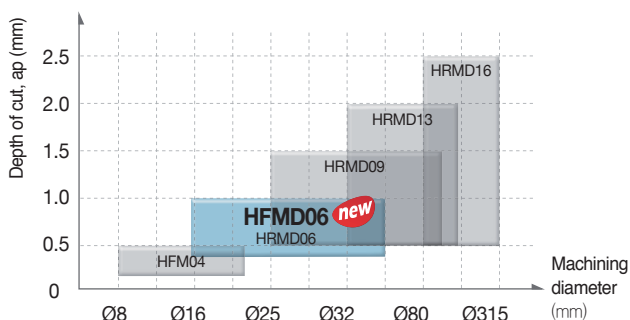

Recommended cutting condition

※ Recommended chip breaker: ● 1st ○ 2nd



ISO	Workpiece				HB (HRC)	Grade	Cutting conditions				Available chip breaker					
	Workpiece materials	KS	AISI	ISO (DIN)*			vc (m/min)	fz (mm/t)	ap (mm)	ae (mm)	ML	MF	MM			
P	Mild steel	SM20C	1020	C25 (CK22)*	120~180	PC5400 (PC5300)	100~220	0.3~1.2	0.2~1.0	0.7D~0.1D	○	●	-			
	Carbon steel	SM45C	1042 1045	C45/C45E4 (C45/CK45)*	200	PC5400 (PC5300)	100~200	0.3~1.2	0.2~1.0	0.7D~0.1D	○	●	-			
	Alloy steel	SCM440	4140	41CrMo4	270(28)	PC3700 (PC5300)	100~200	0.3~1.2	0.2~1.0	0.7D~0.1D	○	●	-			
	Pre-hardened steel	KP4M	P20 (Improved)	-	(1,2738)*	300(32)	PC3700 (PC5300)	100~180	0.3~1.0	0.2~0.8	0.7D~0.1D	-	●	○		
		NIMAX	P21 (Improved)	-	-	370(40)	PC3700 (PC5300)	100~180	0.3~1.0	0.2~0.8	0.7D~0.1D	-	●	○		
		CENA1	P21 (Improved)	-	-	370(40)	PC3700 (PC5300)	100~180	0.3~1.0	0.2~0.8	0.7D~0.1D	-	●	○		
		NAK80	P21 (Improved)	-	-	400(43)	PC3700 (PC5300)	100~180	0.3~1.0	0.2~0.8	0.7D~0.1D	-	●	○		
STAVAX	420	-	(X30Cr13)*	510(52)	PC3700 (PC2510)	80~150	0.3~0.7	0.2~0.8	0.7D~0.1D	-	●	○				
Alloy tool steel	STD11 STD61	D2 H13	-	(X165CrVMo12-1 X40CrMoV5-1)*	-	(40~50)	PC2510 (PC3700)	80~130	0.3~0.65	0.2~0.6	0.7D~0.1D	-	○	●		
M	Stainless steel	STS316	316	-	(X5CrNiMo17-12-2)*	Under 270	PC5400	90~180	0.3~0.8	0.2~0.8	0.7D~0.1D	●	○	-		
K	Grey cast iron, Ductile cast iron	GCD450	65-45-12	450-10 (GGG40.3)*	-	Tensile Strength Over 450Mpa	PC5300 (PC5400)	130~220	0.3~0.9	0.2~1.0	0.7D~0.1D	-	●	○		
S	HRSA	Fe series	Incoloy901	N09901	-	(WS 2.4662)*	-	(25~35)	PC5300	30~100	0.3~0.6	0.2~0.6	0.4D~0.7D	●	○	-
		Ni or Co series	Inconel718	N07718	-	(WS 2.4668)*	-	(35~45)	PC5300	30~45	0.3~0.7	0.2~0.6	0.4D~0.7D	○	●	-
	Titanium	Ti-6Al-4V	R56400	-	(TiAl6V4)*	-	(40~45)	PC5300	30~50	0.3~1.0	0.2~0.6	0.7D~0.1D	●	○	-	

Performance evaluation

Alloy steel (SCM440, HB250)

- **Workpiece** Steel rectangular tube (300×200×100)
- **Cutting conditions** vc (m/min) = 180, fz (mm/t) = 1.0, ap (mm) = 0.8, ae (mm) = 20, dry
- **Tools** Insert LNMx060310R-MF
Holder HFMDs032R-5C32-200-LN06 (Ø32, 5T)

Test result

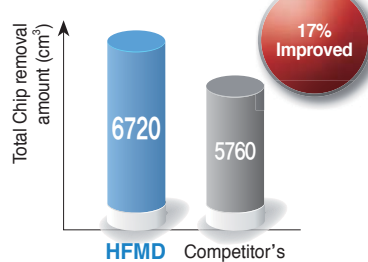

- Chip removal rate Q (cm³/min): 143.2
- Cutting time (min): 46.9

Pre-hardened steel (KP4M, HRC30)

- **Workpiece** Steel rectangular tube (300×200×100)
- **Cutting conditions** vc (m/min) = 160, fz (mm/t) = 1.2, ap (mm) = 0.8, ae (mm) = 20, dry
- **Tools** Insert LNMx060310R-MF
Holder HFMDs032R-5C32-200-LN06 (Ø32, 5T)

Test result

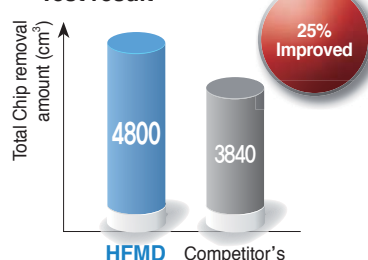

- Chip removal rate Q (cm³/min): 152.8
- Cutting time (min): 31.4



Ramping and helical cutting

Ramping

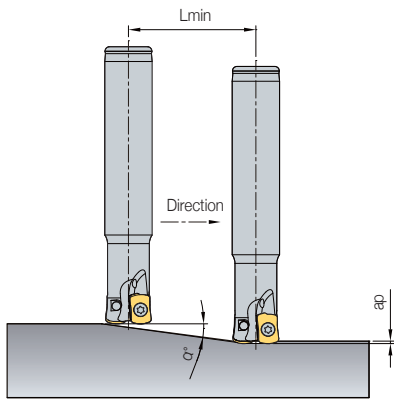

$$L_{min} = \frac{ap}{\tan \alpha} \text{ (mm)}$$

※ Lmin: Min. inclination cutting length
 α°: Max. ramping angle
 ap: Depth of cut

Helical cutting

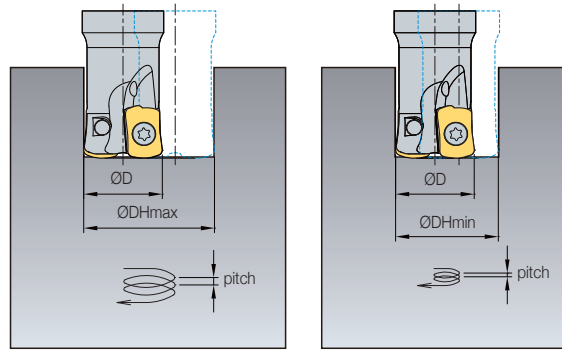

• ØD = Tool dia. (mm)
 • Ød = Tool path (mm) = ØDH Min, Max - ØD

Designation	Tool dia. ØD	Depth of cut ap	Ramping		Blind hole helical cutting				Thru hole helical cutting	
			Max ramping angle α (°)	Lmin	Min diameter ØDH Min	Max pitch dmax	Max diameter ØDH Max	Max pitch dmax	Min diameter ØDH Min	Max pitch dmax
HFMS016	16	0.7	3.0	13	30	0.7	22	0.7	21	0.7
HFMS017	17	1.0	2.3	25	32	1.0	24	1.0	22	1.0
HFMS018	18	1.0	2.1	27	34	1.0	26	1.0	24	1.0
HFMS019	19	1.0	1.9	30	36	1.0	28	1.0	26	1.0
HFMS020	20	1.0	1.5	37	38	1.0	30	1.0	28	1.0
HFMS021	21	1.0	1.5	39	40	1.0	32	1.0	30	1.0
HFMS025	25	1.0	1.4	40	48	1.0	40	1.0	38	1.0
HFMS026	26	1.0	1.4	42	50	1.0	42	1.0	40	1.0
HFMS030	30	1.0	1.1	51	58	1.0	50	1.0	48	1.0
HFMS032	32	1.0	1.0	55	62	1.0	54	1.0	52	1.0
HFMS033	33	1.0	1.0	57	64	1.0	56	1.0	54	1.0
HFMS035	35	1.0	0.9	61	68	1.0	60	1.0	58	1.0
HFMS040	40	1.0	0.8	71	78	1.0	70	1.0	68	1.0
HFMC042	42	1.0	0.8	76	82	1.0	74	1.0	72	1.0
HFMC050	50	1.0	0.6	92	98	1.0	90	1.0	88	1.0
HFMC052	52	1.0	0.6	96	102	1.0	94	1.0	92	1.0
HFMC063	63	1.0	0.5	119	124	1.0	116	1.0	114	1.0
HFMC066	66	1.0	0.5	126	130	1.0	122	1.0	120	1.0

- Adjust feed to under 70% of recommended cutting condition when ramping & helical cutting
- In helical ramping, max. cutting depth per 1 helical revolution of cutter should not exceed max. cutting depth as per insert size
- In ramping, max. cutting depth per 1 ramping process of cutter should not exceed max. depth of cut as per used insert size

Corner R programming

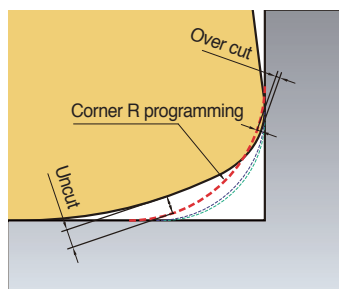

--- R2.0 - - - R1.6 - · - R1.5

Insert	Corner R programming	Cutting conditions		Over Cut	Uncut
		Nose R	Max. ap		
LNMX060310R-ML LNMX060310R-MF LNMX060310R-MM	R1.5			0	0.41
	R1.6 (Standard)	1.0	1.0	0	0.38
	R2.0			0.057	0.27

- During usage of CNC program, over cut & uncut would be occurred on the corner processing site if entering the correct program corner R value for each insert
- To prevent overcut, you will need to complete a CNC program considering the above overcut

HFMDs-LN06 new

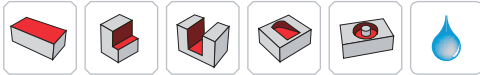
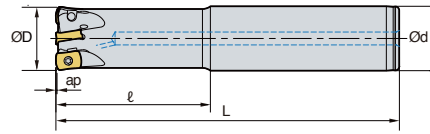

• AR: -9°
• RR: 10°~15°

(mm)

Designation		ØD	Ød	ℓ	L	ap	
HFMDs 016R-2C16-100-LN06	2	16	16	30	100	0.7	0.13
016R-2C16-150-LN06	2	16	16	50	150	0.7	0.19
017R-2C16-100-LN06	2	17	16	30	100	1.0	0.13
017R-2C16-150-LN06	2	17	16	40	150	1.0	0.20
017R-2C16-200-LN06	2	17	16	40	200	1.0	0.27
018R-2C16-100-LN06	2	18	16	40	100	1.0	0.14
018R-2C16-160-LN06	2	18	16	40	160	1.0	0.18
018R-2C16-200-LN06	2	18	16	40	200	1.0	0.28
019R-2C16-100-LN06	2	19	16	40	100	1.0	0.15
019R-2C16-160-LN06	2	19	16	40	160	1.0	0.19
019R-2C16-200-LN06	2	19	16	40	200	1.0	0.29
020R-3C20-100-LN06	3	20	20	40	100	1.0	0.20
020R-3C20-130-LN06	3	20	20	50	130	1.0	0.26
020R-3C20-160-LN06	3	20	20	80	160	1.0	0.31
020R-3C20-200-LN06	3	20	20	120	200	1.0	0.40

Available inserts

LNX-ML LNX-MF LNX-MM



Designation	Coated				page
	PC2510	PC3700	PC5300	PC5400	
LNX 060310R-ML			●	●	E11
060310R-MF	●	●	●	●	
060310R-MM	●	●	●	●	

Parts

Specification		
Ø16~Ø40	FTNA0306	TW09S

Available inserts E11



HFMDS-LN06 new

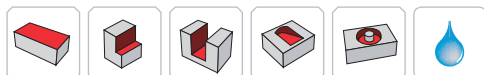
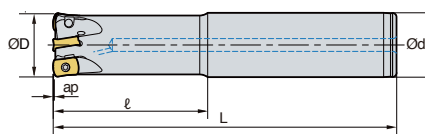

• AR: -9°
• RR: 10°~15°

(mm)

Designation		ØD	Ød	ℓ	L	ap	
HFMDS 021R-3C20-100-LN06	3	21	20	30	100	1.0	0.21
021R-3C20-130-LN06	3	21	20	40	130	1.0	0.27
021R-3C20-160-LN06	3	21	20	40	160	1.0	0.34
021R-3C20-200-LN06	3	21	20	40	200	1.0	0.42
025R-4C25-100-LN06	4	25	25	40	100	1.0	0.33
025R-4C25-140-LN06	4	25	25	60	140	1.0	0.46
025R-4C25-180-LN06	4	25	25	100	180	1.0	0.58
025R-4C25-250-LN06	4	25	25	150	250	1.0	0.67
026R-4C25-100-LN06	4	26	25	30	100	1.0	0.34
026R-4C25-140-LN06	4	26	25	40	140	1.0	0.48
026R-4C25-180-LN06	4	26	25	40	180	1.0	0.63
026R-4C25-250-LN06	4	26	25	40	250	1.0	0.72
032R-5C32-150-LN06	5	32	32	70	150	1.0	0.82
032R-5C32-200-LN06	5	32	32	120	200	1.0	1.08
032R-5C32-250-LN06	5	32	32	150	250	1.0	1.20
033R-5C32-150-LN06	5	33	32	40	150	1.0	0.82
033R-5C32-200-LN06	5	33	32	40	200	1.0	1.08
033R-5C32-250-LN06	5	33	32	40	250	1.0	1.20
035R-5C32-150-LN06	5	35	32	40	150	1.0	0.87
035R-5C32-200-LN06	5	35	32	40	200	1.0	1.13
035R-5C32-250-LN06	5	35	32	40	250	1.0	1.25
040R-6C32-150-LN06	6	40	32	40	150	1.0	0.97
040R-6C32-200-LN06	6	40	32	40	200	1.0	1.28
040R-6C32-250-LN06	6	40	32	40	250	1.0	1.38

Available inserts

LNMX-ML LNMX-MF LNMX-MM



Designation	Coated				page
	PC2510	PC3700	PC5300	PC5400	
LNMX 060310R-ML			●	●	E11
060310R-MF	●	●	●	●	
060310R-MM	●	●	●	●	

Parts

Specification		
Ø16~Ø40	FTNA0306	TW09S

Available inserts E11

HFMDCM-LN06 new

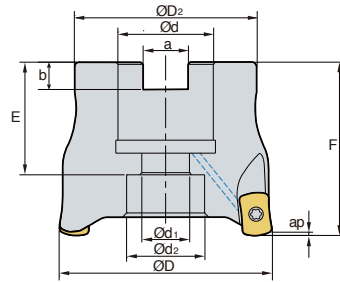

• AR: -9°
• RR: 10°~12°

(mm)

Designation		ØD	ØD2	Ød	Ød1	Ød2	a	b	E	F	ap	
HFMDCM 032R-16-5-LN06	5	32	30	16	9	13.5	8.4	5.6	19	40	1.0	0.12
040R-16-6-LN06	6	40	34	16	9	14	8.4	5.6	19	40	1.0	0.21
050R-22-6-LN06	6	50	42	22	11	18	10.4	6.3	21	40	1.0	0.32
050R-22-7-LN06	7	50	42	22	11	18	10.4	6.3	21	40	1.0	0.32
050R-22-8-LN06	8	50	42	22	11	18	10.4	6.3	21	40	1.0	0.32
052R-22-7-LN06	7	52	42	22	11	18	10.4	6.3	21	40	1.0	0.34
052R-22-8-LN06	8	52	42	22	11	18	10.4	6.3	21	40	1.0	0.34
063R-22-8-LN06	8	63	49	22	11	18	10.4	6.3	21	40	1.0	0.53
063R-22-9-LN06	9	63	49	22	11	18	10.4	6.3	21	40	1.0	0.53
066R-22-8-LN06	8	66	49	22	11	18	10.4	6.3	21	40	1.0	0.57
066R-22-9-LN06	9	66	49	22	11	18	10.4	6.3	21	40	1.0	0.57

Available inserts

LNMX-ML LNMX-MF LNMX-MM



Designation	Coated				page
	PC2510	PC3700	PC5300	PC5400	
LNMX 060310R-ML			●	●	E11
060310R-MF	●	●	●	●	
060310R-MM	●	●	●	●	

Available arbors

Designation	Available arbors
HFMDCM 032R-16-□-LN06	BT□□-FMC16-□□
040R-16-□-LN06	
050R-22-□-LN06	
052R-22-□-LN06	BT□□-FMC22-□□
063R-22-□-LN06	
066R-22-□-LN06	

Parts

Specification		
Ø32-Ø66	FTNA0306	TW09S

Available inserts E11 Available arbors and bolt E400-E402



HFMDM-LN06 new

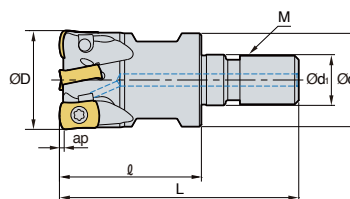

• AR: -9°
• RR: 10°~15°

(mm)

Designation		ØD	Ød	Ød ₁	l	L	M	ap	
HFMDM 016R-2-M08-LN06	2	16	14.5	8.5	25	42	M08	0.7	0.03
017R-2-M08-LN06	2	17	14.5	8.5	25	42	M08	1.0	0.03
018R-2-M08-LN06	2	18	14.5	8.5	25	42	M08	1.0	0.04
019R-2-M08-LN06	2	19	14.5	8.5	25	42	M08	1.0	0.05
020R-3-M10-LN06	3	20	18	10.5	30	51	M10	1.0	0.06
021R-3-M10-LN06	3	21	18	10.5	30	51	M10	1.0	0.07
025R-4-M12-LN06	4	25	23	12.5	35	59	M12	1.0	0.10
026R-4-M12-LN06	4	26	23	12.5	35	59	M12	1.0	0.10
032R-5-M16-LN06	5	32	29	17	40	67	M16	1.0	0.20
033R-5-M16-LN06	5	33	29	17	40	67	M16	1.0	0.20
035R-5-M16-LN06	5	35	29	17	40	67	M16	1.0	0.21
040R-6-M16-LN06	6	40	29	17	40	67	M16	1.0	0.24
042R-6-M16-LN06	6	42	29	17	40	67	M16	1.0	0.25

Available inserts

LNX-ML LNX-MF LNX-MM



Designation	Coated				page
	PC2510	PC3700	PC5300	PC5400	
LNX 060310R-ML			●	●	E11
060310R-MF	●	●	●	●	
060310R-MM	●	●	●	●	

Parts

Specification		
Ø16~Ø42	FTNA0306	TW09S

Available inserts E11 Available adaptor E371~E372



E Technical Information for HFM

Stable machining, high efficiency milling tools for small diameter machining

HFM new

- Increase productivity through improved insert shape and size, high feed per tooth, and many cutting-edges, for small diameter machining
- Stable tool life through the combination of the reinforced toughness on corner and suitable grades of high hardness in the area of high speed and high hardness

Code system

• Shank type

HFM	S	1	010	H	R	-	2	L	10
High Feed Mill	Tool type S: Shank	Inscribed circle of insert 1: 04 type insert	Tool dia. 010: Ø10	Coolant type No code: None H: Thru-hole	Hand R: Right L: Left		No. of tooth 2: 2 teeth	Shank length S: Standard type M: Middle type L: Long type	Shank Dia. 10: Ø10

• Modular type

HFM	M	1	010	H	R	-	M06
High Feed Mill	Tool type M: Modular	Inscribed circle of insert 1: 04 type insert	Tool dia. 010: Ø10	Coolant type No code: None H: Thru-hole	Hand R: Right L: Left		M Dimensions

• Modular adapter

MAT	-	M10	-	010	-	S20		S	-	C	-	170
Modular Adaptor		M Dimensions M10		Neck length 010: 10 mm		Shank Dia. S20: Ø20		Neck type T: Taper S: Straight		Adaptor material Unmarked: Steel C: Carbide		Adaptor length 170: 170 mm

Features

- Apply helix cutting-edge on insert, low cutting load and reinforce toughness on corner
- Increased rigidity with double relief angle (11, 13), prevent interference with high feed
- To apply the negative axial rake angle when set up the holder, increased chipping resistance
- Tool life is increased with suitable C/B and grade for every material

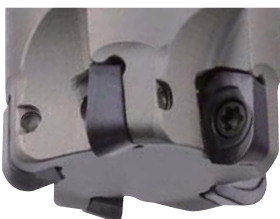

• Holder setup

- To set up the negative axial rake angle, increased chipping resistance

• No. of tooth

- Increased tool life with increased flutes
- HRM(D) Ø20 (2 flutes) → HFM Ø20 (5 flutes)



• Relief angle

- 11, 13 double relief angle increase rigidity and prevent interference

• Major cutting-edge

- Improved sharpness of principle edge
- Improved toughness of corner edge



Features of chip breaker

Insert	Cutting-edge	Uses	Features
MF		Fine finishing Titanium & Inconel machining	Low cutting resistance C/B, suitable for light cutting
None C/B		Super hard material machining	High toughness shape, suitable for hard die steel cutting

Application area

Application area (ap & Diameter)

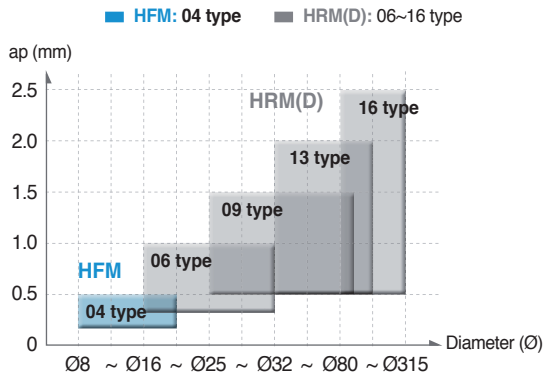

Application area (ap & fz)

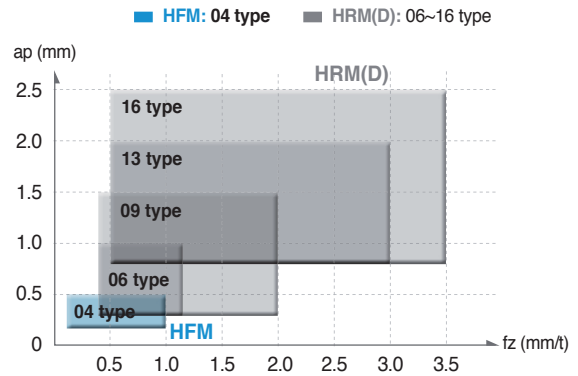

Recommended cutting condition



Workpiece	Workpiece			HB (HrC)	Grades	Cutting conditions				Chip breaker			
	KOR (KS)	USA (AISI)	GER (DIN)			vc (m/min)	fz (mm/t)	ap (mm)	ae (mm)	MF	None C/B		
P	Mild steel	SM20C	1020	C22	120~180	PC5400 (PC5300)	100~220	0.5~1.0	~0.5	0.7D~0.1D	●	-	
	Carbon steel	SM45C	1045	C45	200	PC5400 (PC5300)	100~200	0.5~1.0	~0.5	0.7D~0.1D	●	-	
	Alloy steel	SCM440	4140	41CrMo4	270(28)	PC5300	100~200	0.5~1.0	~0.5	0.7D~0.1D	●	-	
	Pre-hardened steel	KP4M	P20 (Improved)	1.2738 (Improved)	300(32)	PC5300 ^{new} (PC2510)	100~180	0.5~0.9	~0.4	0.7D~0.1D	●	○	
		NIMAX	P21 (Improved)	-	370(40)	PC5300 ^{new} (PC2510)	100~180	0.5~0.9	~0.4	0.7D~0.1D	●	○	
		CENA1	P21 (Improved)	-	370(40)	PC5300 ^{new} (PC2510)	100~180	0.5~0.9	~0.4	0.7D~0.1D	●	○	
		NAK80	P21 (Improved)	-	400(43)	PC5300	100~160	0.5~0.7	~0.4	0.7D~0.1D	○	-	
	Alloy tool steel	STAVAX	420	X30Cr13	510(52)	PC2510 ^{new} (PC5300)	100~180	0.5~0.9	~0.4	0.7D~0.1D	-	●	
		STD11	D2	X155CrVMo12-1	- (40~50)	PC2510 ^{new} (PC2505)	80~150	0.3~0.6	~0.4	0.7D~0.1D	●	-	
STD61		H13	X40CrMoV5-1	- (40~50)	PC2505 ^{new}	80~130	0.3~0.55	~0.3	0.7D~0.1D	-	●		
M	Stainless steel	STD11 (Cold forging)	D2	X155CrVMo12-1	630(60)	PC2505 ^{new}	30~75	0.3~0.5	~0.2	0.7D~0.1D	-	●	
		STS316	316	X5CrNiMo17-12-2	Under 270	PC5400 (PC5300)	70~150	0.5~0.7	~0.5	0.7D~0.1D	●	-	
K	Gray cast iron, Ductile cast iron	GCD450	65-45-12	GGG40.3	Tensile Strength Over 450Mpa	PC5300	130~220	0.6~0.8	~0.5	0.7D~0.1D	●	-	
S	HRSA	Fe series	Incoloy901	N09901	- (WS 2.4662)	- (25~35)	PC5300 (PC5400)	30~100	0.3~0.5	~0.3	0.4D~0.7D	●	○
		Ni or Co series	Inconel718	N07718	NiCr19FeNbMo (WS 2.4668)	- (35~45)	PC5300 (PC5400)	20~50	0.3~0.6	~0.3	0.4D~0.7D	●	○
	Titanium	Ti-6Al-4V	R56400	TiAl6V4	- (40~45)	PC5300	30~50	0.4~1.0	~0.3	0.7D~0.1D	●	-	

Performance evaluation

High speed machining

- **Workpiece**
STD11 (H_RC40~45)
- **Insert**
LPM(E)W0402□□R
- **Recommended grade**
PC2505 (1st), PC2510 (2nd)

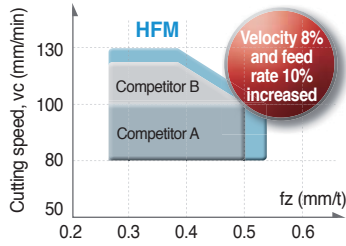

- **Workpiece**
STD11 (Over H_RC60)
- **Insert**
LPM(E)W0402□□R
- **Recommended grade**
PC2505 (1st), PC2510 (2nd)

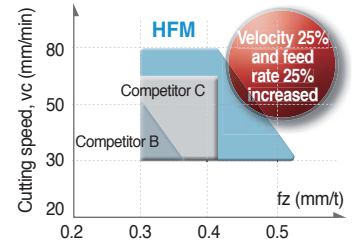

High feed machining

- **Workpiece**
KP4M (H_RC32),
NAK80 (H_RC43)
- **Insert**
LPMT0402□□R-MF
- **Recommended grade**
PC5300 (1st), PC2510 (2nd)

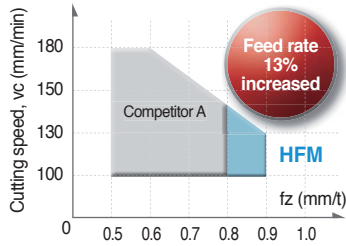

- **Workpiece**
Ti-6AL-4V (H_RC40~45)
- **Insert**
LPMT0402□□R-MF
- **Recommended grade**
PC5300 (1st), PC5400 (2nd)

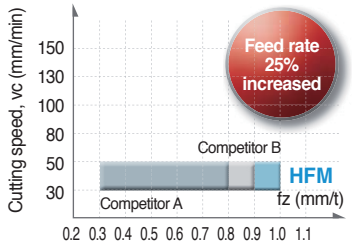

High hardness machining

- Recommended grades according to interruption

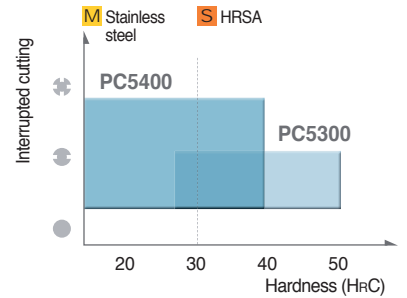
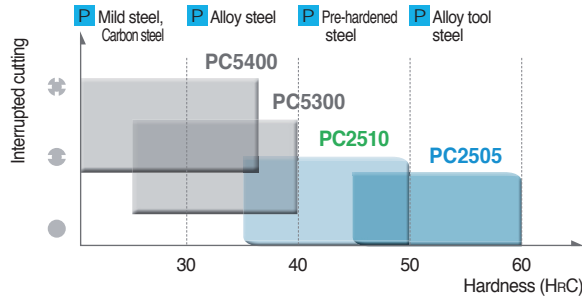

- Recommended grades according to velocity

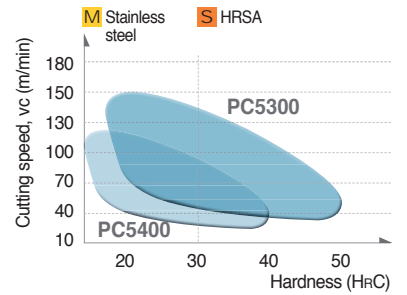
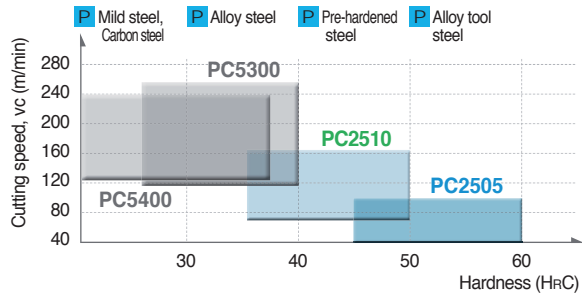

Effective machining

- **Machining center**
 - BT40 and under, HFM recommended
 - BT50 and above, HRM(D) recommended
- **Chip removal rate Q (cm³/min)**
 - Ø8~Ø20, HFM recommended
 - Ø20 and above, HRM(D) recommended

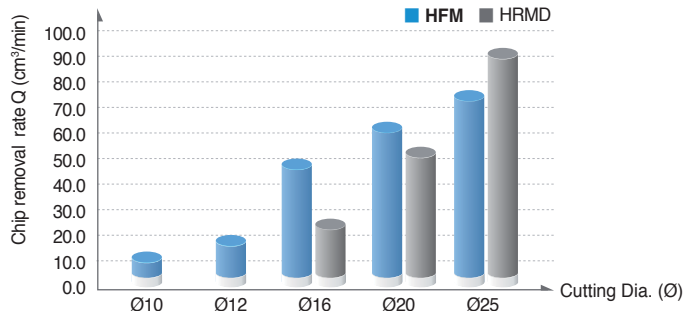

Performance evaluation

Carbon steel [C45 (DIN)/1045 (AISI)/SM45C (KS), HB200]

- **Workpiece** Mold
- **Cutting conditions** vc (m/min) = 150, fz (mm/t) = 0.6
ap (mm) = 0.4, ae (mm) = 5
dry
- **Tools** **Insert** LPMT040210R-MF (PC5300)
Holder HFMS1010HR-2S10

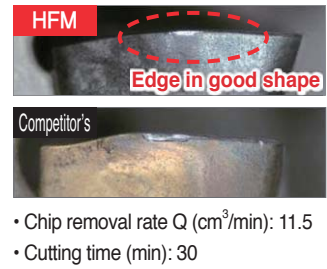
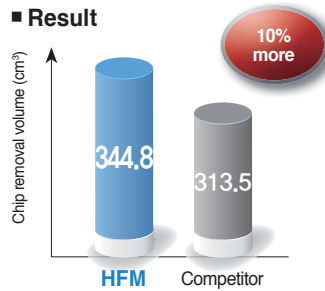

Pre-hardened steel [P21 (Improved) (AISI)/NAK80 (KS), HRC40~41]

- **Workpiece** Mold
- **Cutting conditions** vc (m/min) = 100, fz (mm/t) = 1.26
ap (mm) = 0.3, ae (mm) = 10
dry
- **Tools** **Insert** LPMT040210R-MF (PC5300)
Holder HFMS1016HR-4S16

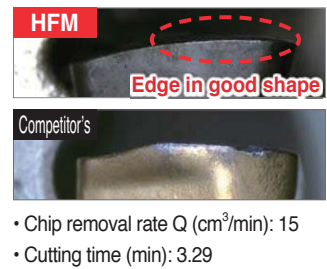
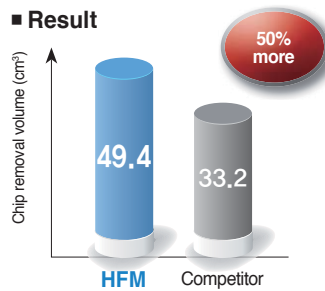

Alloy tool steel [X155CrVMo12-1 (DIN)/D2 (AISI)/STD11 (KS), HRC40~45]

- **Workpiece** Mold
- **Cutting conditions** vc (m/min) = 80, fz (mm/t) = 0.5
ap (mm) = 0.3, ae (mm) = 10
dry
- **Tools** **Insert** LPMW040210R (PC2510)
Holder HFMS1016HR-4S16

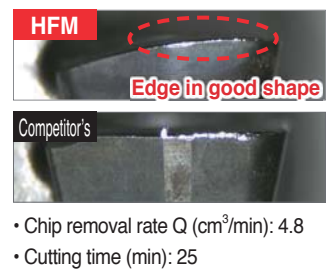
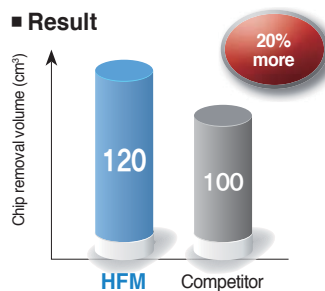

Alloy tool steel [X155CrVMo12-1 (DIN)/D2 (AISI)/STD11 (KS), HRC60]

- **Workpiece** Mold
- **Cutting conditions** vc (m/min) = 75, fz (mm/t) = 0.4
ap (mm) = 0.15, ae (mm) = 5
dry
- **Tools** **Insert** LPMW040210R (PC2505)
Holder HFMS1010HR-2S10

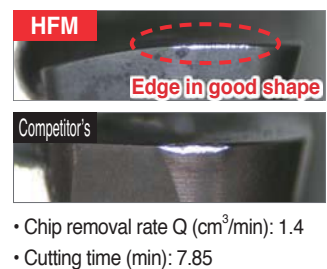
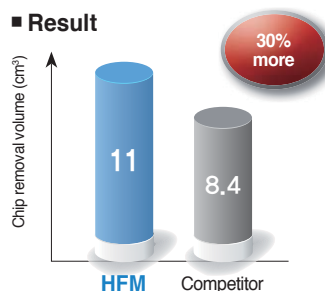

HRSA [TiAl6V4 (DIN)/R56400 (AISI)/Ti-6Al-4V (KS), HRC48]

- **Workpiece** Aviation parts
- **Cutting conditions** vc (m/min) = 50, fz (mm/t) = 1.2
ap (mm) = 0.3, ae (mm) = 10
wet
- **Tools** **Insert** LPMT040210R-MF (PC5300)
Holder HFMS1016HR-4S16

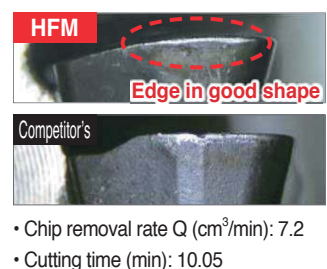
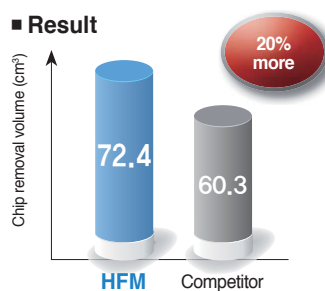

Ramping and helical cutting

Ramping

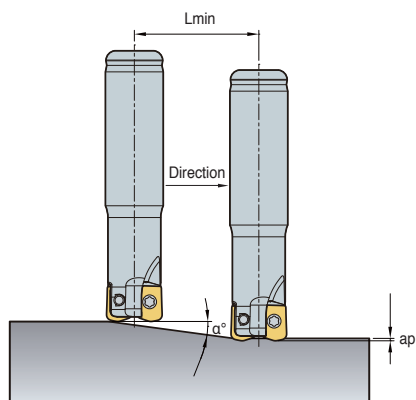

$$L_{min} = \frac{ap}{\tan \alpha^\circ} \text{ (mm)}$$

※ Lmin: Min. inclination cutting length
 α° : Max. ramping angle
 ap: Depth of cut

Helical cutting

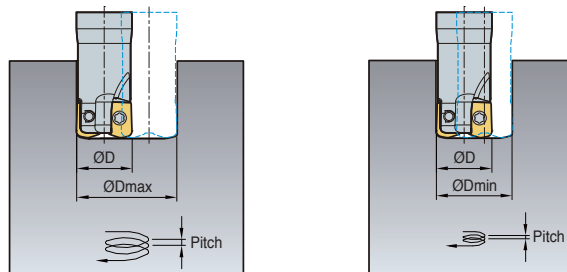

- $\varnothing D$ = Tool dia. (mm)
- $\varnothing d$ = Tool path (mm) = $\varnothing DH \text{ Min, Max} - \varnothing D$
- $\varnothing DH \text{ Min}$ (Min diameter, mm) = $\varnothing D \times 2 - 5.4$
- $\varnothing DH \text{ Max}$ (Max diameter, mm) = $\varnothing D \times 2 - 2$

(mm)

Designation	Tool dia. $\varnothing D$	Depth of cut ap	Ramping		Helical cutting		
			Max ramping angle α°	Lmin	Max diameter $\varnothing DH \text{ Max}$	Min diameter $\varnothing DH \text{ Min}$	Max pitch d_{max}
HFMS1010HR	10	0.4~0.5	3.5	7	18	15	0.4
HFMS1011HR	11	0.4~0.5	3.1	8	20	17	0.4
HFMS1012HR	12	0.4~0.5	2.7	9	22	19	0.4
HFMS1013HR	13	0.4~0.5	2.4	10	24	21	0.4
HFMS1014HR	14	0.4~0.5	2.2	11	26	23	0.4
HFMS1015HR	15	0.4~0.5	2.0	12	28	25	0.4
HFMS1016HR	16	0.4~0.5	1.8	13	30	27	0.4
HFMS1017HR	17	0.4~0.5	1.7	14	32	29	0.4
HFMS1018HR	18	0.4~0.5	1.6	15	34	31	0.4
HFMS1019HR	19	0.4~0.5	1.5	16	36	33	0.4
HFMS1020HR	20	0.4~0.5	1.4	17	38	35	0.4
HFMS1021HR	21	0.4~0.5	1.3	18	40	37	0.4
HFMM1025HR	25	0.4~0.5	1.1	22	48	45	0.4
HFMM1026HR	26	0.4~0.5	1.0	23	50	47	0.4
HFMM1030HR	30	0.4~0.5	0.9	27	58	55	0.4
HFMM1032HR	32	0.4~0.5	0.8	29	62	59	0.4
HFMM1033HR	33	0.4~0.5	0.8	30	64	61	0.4

- Adjust feed to under 70% of recommended cutting condition when ramping & helical cutting
- In helical ramping, max. cutting depth per 1 helical revolution of cutter should not exceed max. cutting depth as per insert size
- In ramping, max. cutting depth per 1 ramping process of cutter should not exceed max. depth of cut as per used insert size

Corner R programming

(mm)

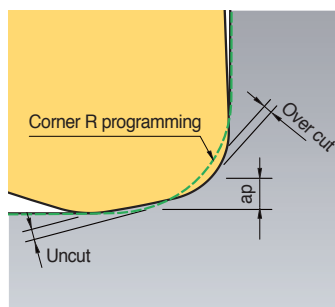

Insert	Corner R programming	Cutting conditions		Over Cut	Uncut
		Nose R	Max. ap		
LPMT040210R-MF	R1.0 (Standard)	1.0	0.4	0	0.17
LPMW040210R	R1.5			0.10	0.08
LPEW040210R	R2.0			0.31	0
LPMT040220R-MF	R1.0	2.0	0.5	0	0.41
LPMW040220R	R1.5			0	0.2
LPEW040220R	R2.0 (Standard)			0	0

- When using CNC program, overcut & uncut occurs on the corner processing site if entering the correct program corner R value for each insert
- To prevent overcut, you will need to complete a CNC program considering the above overcut



HFMS1000 new

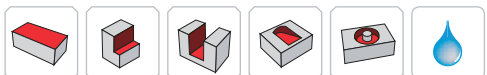
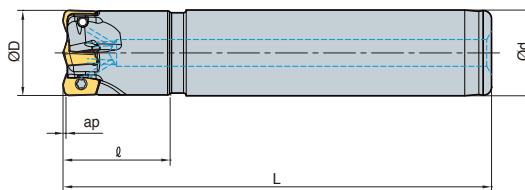

AA
13°
• AR: -4°
• RR: -14° ~ -7°

(mm)

Designation		ØD	Ød	l	L	ap	
HFMS 1008HR-1S10	1	8	10	20	80	0.4~0.5	0.03
1008HR-1M10	1	8	10	25	100	0.4~0.5	0.03
1008HR-1L10	1	8	10	35	120	0.4~0.5	0.03
1010HR-2S08	2	10	8	20	80	0.4~0.5	0.03
1010HR-2M08	2	10	8	25	100	0.4~0.5	0.04
1010HR-2L08	2	10	8	35	120	0.4~0.5	0.04
1010HR-2S10	2	10	10	20	80	0.4~0.5	0.04
1010HR-2M10	2	10	10	25	105	0.4~0.5	0.05
1010HR-2L10	2	10	10	35	120	0.4~0.5	0.06
1011HR-2S10	2	11	10	20	80	0.4~0.5	0.04
1011HR-2M10	2	11	10	25	105	0.4~0.5	0.06
1011HR-2L10	2	11	10	35	120	0.4~0.5	0.07
1012HR-3S10	3	12	10	20	80	0.4~0.5	0.05
1012HR-3M10	3	12	10	25	105	0.4~0.5	0.06
1012HR-3L10	3	12	10	35	120	0.4~0.5	0.07
1012HR-3S12	3	12	12	20	80	0.4~0.5	0.06
1012HR-3M12	3	12	12	25	105	0.4~0.5	0.08
1012HR-3L12	3	12	12	35	120	0.4~0.5	0.09
1013HR-3S12	3	13	12	20	80	0.4~0.5	0.06
1013HR-3M12	3	13	12	25	105	0.4~0.5	0.09
1013HR-3L12	3	13	12	40	120	0.4~0.5	0.10
1014HR-3S12	3	14	12	20	80	0.4~0.5	0.07
1014HR-3M12	3	14	12	25	105	0.4~0.5	0.09
1014HR-3L12	3	14	12	40	120	0.4~0.5	0.10

Available inserts



Designation	Cermet		Coated										Uncoated			page			
	CN2000	CN30	NCM6325	NC5330	NCM635	NCM645	PC2505	PC2510	PC3600	PC3700	PC6510	PC9530	PC9540	PC5300	PC5400		ST30A	G10	H01
LPMT 040210R-MF							●		●					●	●				E11
040220R-MF							●		●					●	●				
LPMW 040210R							●	●						●	●				E12
040220R							●	●						●	●				
LPEW 040210R							●	●						●	●				
040220R							●	●						●	●				

Parts

Specification		
Ø8~Ø10	FTKA01840	TW06S-A
Ø11~Ø14	FTKA01842	

Available inserts E11, E12

HFMS1000 new

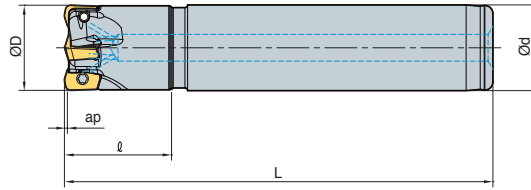

AA
13°
• AR: -4°
• RR: -6° ~ -3°

(mm)

Designation		ØD	Ød	ℓ	L	ap	
HFMS 1015HR-4S12	4	15	12	20	80	0.4~0.5	0.07
1015HR-4M12	4	15	12	25	105	0.4~0.5	0.09
1015HR-4L12	4	15	12	40	120	0.4~0.5	0.11
1016HR-4S16	4	16	16	20	80	0.4~0.5	0.11
1016HR-4M16	4	16	16	25	105	0.4~0.5	0.14
1016HR-4L16	4	16	16	40	120	0.4~0.5	0.16
1017HR-4S16	4	17	16	20	80	0.4~0.5	0.11
1017HR-4M16	4	17	16	25	105	0.4~0.5	0.15
1017HR-4L16	4	17	16	40	120	0.4~0.5	0.17
1018HR-4S16	4	18	16	20	80	0.4~0.5	0.11
1018HR-4M16	4	18	16	25	105	0.4~0.5	0.15
1018HR-4L16	4	18	16	40	120	0.4~0.5	0.17
1019HR-4S16	4	19	16	20	80	0.4~0.5	0.12
1019HR-4M16	4	19	16	25	105	0.4~0.5	0.16
1019HR-4L16	4	19	16	40	120	0.4~0.5	0.18
1020HR-4S20	4	20	20	20	80	0.4~0.5	0.17
1020HR-4M20	4	20	20	25	105	0.4~0.5	0.22
1020HR-4L20	4	20	20	40	120	0.4~0.5	0.26
1020HR-5S20	5	20	20	20	80	0.4~0.5	0.17
1020HR-5M20	5	20	20	25	105	0.4~0.5	0.23
1020HR-5L20	5	20	20	40	120	0.4~0.5	0.27
1021HR-5S20	5	21	20	20	80	0.4~0.5	0.17
1021HR-5M20	5	21	20	25	105	0.4~0.5	0.23
1021HR-5L20	5	21	20	40	120	0.4~0.5	0.27

Available inserts



Designation	Cermet		Coated										Uncoated			page			
	CN2000	CN30	NCM325	NC5330	NCM535	NCM545	PC2505	PC2510	PC3600	PC3700	PC6510	PC9530	PC9540	PC5300	PC5400		ST30A	G10	H01
LPMT 040210R-MF							●							●	●				E11
040220R-MF							●		●					●	●				
LPMW 040210R							●	●						●					E12
040220R							●	●						●					
LPEW 040210R							●	●						●					E12
040220R							●	●						●					

Parts

Specification		
Ø15~Ø21	FTKA01842	TW06S-A

Available inserts E11, E12



HFMM new

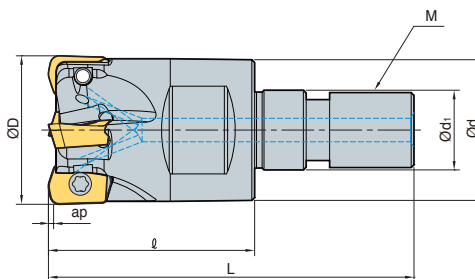

AA **13°**
 • AR: -4°
 • RR: -14° ~ -3°

(mm)

Designation		ØD	Ød	Ød1	l	L	M	ap	
HFMM 1008HR-M06	1	8	9.5	6.5	17	32	M06	0.4~0.5	0.01
1010HR-M06	2	10	9.5	6.5	17	32	M06	0.4~0.5	0.01
1011HR-M06	2	11	9.5	6.5	17	32	M06	0.4~0.5	0.01
1012HR-M06	3	12	11	6.5	19	34	M6B	0.4~0.5	0.01
1013HR-M06	3	13	11	6.5	19	34	M6B	0.4~0.5	0.01
1016HR-M08	4	16	14.5	8.5	22	39	M08	0.4~0.5	0.03
1017HR-M08	4	17	14.5	8.5	22	39	M08	0.4~0.5	0.03
1020HR-M10	5	20	18	10.5	25	46	M10	0.4~0.5	0.06
1021HR-M10	5	21	18	10.5	25	46	M10	0.4~0.5	0.06
1025HR-M12	6	25	23	12.5	27	51	M12	0.4~0.5	0.11
1026HR-M12	6	26	23	12.5	27	51	M12	0.4~0.5	0.11
1030HR-M16	7	30	29	17	30	60	M16	0.4~0.5	0.17
1032HR-M16	8	32	29	17	30	60	M16	0.4~0.5	0.18
1033HR-M16	8	33	29	17	30	60	M16	0.4~0.5	0.18

Available inserts



Designation	Cermet		Coated										Uncoated			page			
	CN2000	CN30	NCM325	NC5330	NCM535	NCM545	PC2505	PC2510	PC3600	PC3700	PC6510	PC9530	PC9540	PC5300	PC5400		ST30A	G10	H01
LPMT 040210R-MF							●		●					●	●				E11
040220R-MF							●		●					●	●				
LPMW 040210R							●	●						●					E12
040220R							●	●						●					
LPEW 040210R							●	●						●					
040220R							●	●						●					

Parts

Specification		
Ø8~Ø10	FTKA01840	TW06S-A
Ø11~Ø33	FTKA01842	

Available inserts E11, E12

Available adaptor E371~E372

HRMD is more economical due to the use of 6 cutting-edges compared to HRM tool with a 3-edge positive insert

HRMDouble

- HRMD is more economical due to the use of 6 cutting-edges compared to HRM tool with a 3-edge positive insert
- High-rake angle cutting-edge and chip breaker reduces cutting load
- Negative geometry has been designed for rigidity of cutting-edge and double-sided function
- Screw on system and stable support achieves strong clamping force
- Unique insert design for high feed and multifunctional machining
- HRMD insert with symmetrical cutting-edge is applicable for both R and L type machining

Features of insert

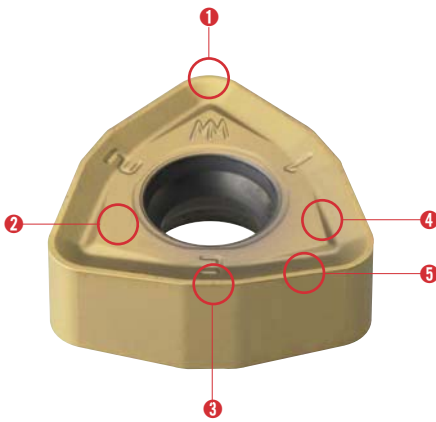

1 Nose-R

- Security of rigid edge in ramping pocket machining
- Round edge suitable for high feed rates insert geometry
- Possible to use R/L type machining

2 Clamping surface

- Design for stable clamping
- Prevention of friction by chip

3 Minor cutting-edge

- Improvement of surface roughness in high feed machining
- Special design for decreasing thrust force
- Symmetrical insert design for R/L type tool

4 Chip breaker

- Reduction of cutting load due to High-rake angle
- Improvement of chip flow and evacuation in various applications
- Prevention of damage on clamping face of insert

5 Major cutting-edge

- Symmetrical design insert for R/L type tool
- Superior cutting performance due to high rake angle cutting-edge
- Low cutting resistance in high feed
- Special design for decreasing thrust force

Features of cutter



Inner coolant system

- Improvement of chip control and evacuation
- Longer tool life due to reduced cutting temperature

3-surface constrained system

- Strong clamping system
- Stable clamping system against different cutting resistances in various machining applications

Simple screw on system

- Strong clamping of screw on system
- Convenient clamping system
- Wide chip pocket for better chip evacuation

Code system

• Cutter type

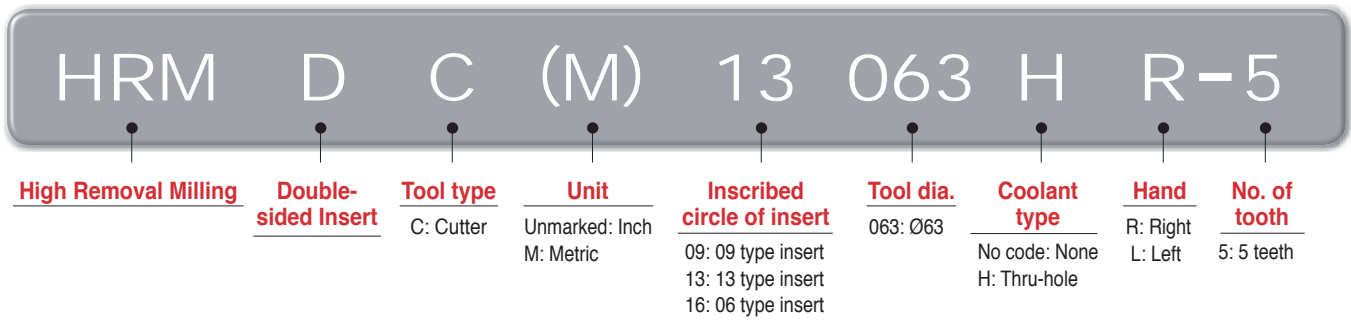

• Shank type

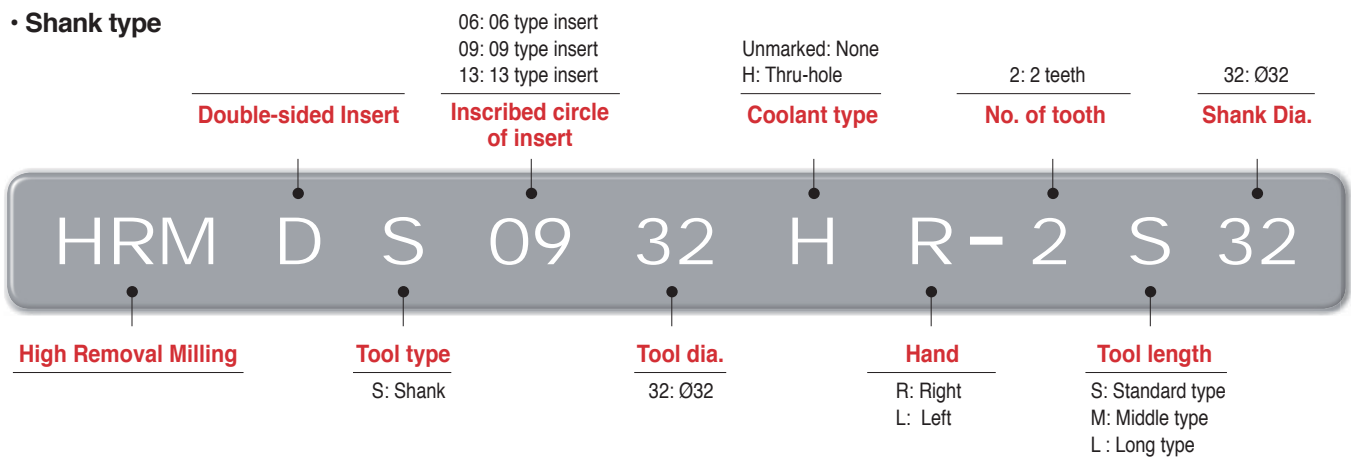

• Modular head

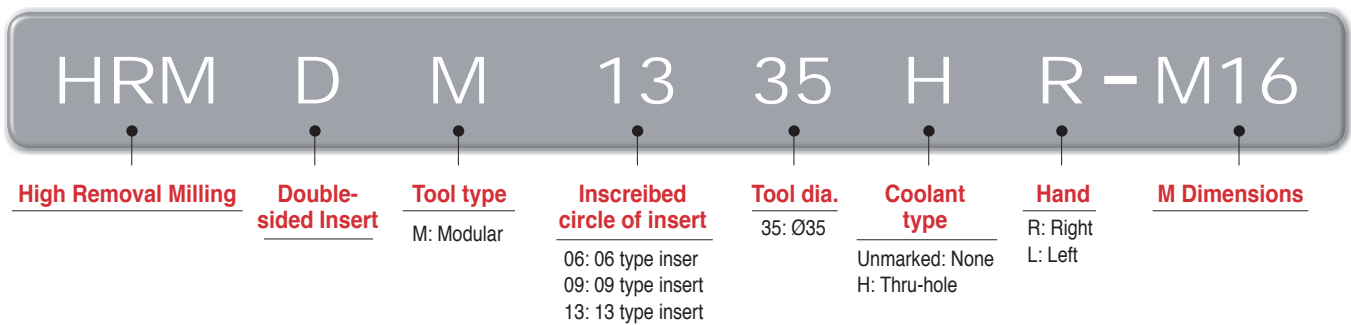

• Modular adaptor

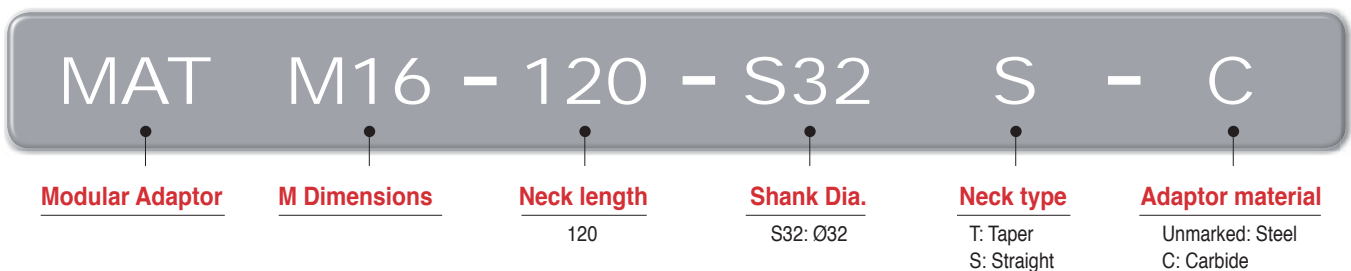

Corner R programming

Designation	Cutting condition		Approx. R (mm)	
	Max.ap (mm)	Max.fz (mm/t)	Input. R	Uncut
WNMX060312ZNN-□□	1.0	1.2	1.8	0.4
WNMX09T316ZNN-□□	1.5	2.0	2.5	0.6
WNMX130520ZNN-□□	2.0	3.0	3.0	0.8
WNMX160720ZNN-□□	2.5	3.5	3.5	1.2

Information for uncut part by using "Input.R" for CAM program

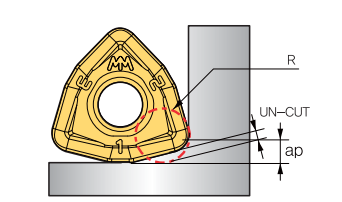

Uncut part can be changed by poor machine condition or weak clamp of workpiece, etc

Interference prevent system

Designation	ØD (mm)	Ød (mm)	t (mm)
HRMDS0617HR-2□16	17	16	1
HRMDS0618HR-2□16	18	16	2
HRMDS0621HR-2□20	21	20	1
HRMDS0626HR-3□25	26	25	1
HRMDS0633HR-4□32	33	32	1
HRMDS0926HR-2□25	26	25	1
HRMDS0933HR-3□32	33	32	1
HRMDS0935HR-4□32	35	32	3
HRMDS0940HR-4□32	40	32	8
HRMDS0950HR-5□32	50	32	18
HRMDS0950HR-5□40	50	40	10
HRMDS0950HR-5□42	50	42	8
HRMDS1333HR-3□32	33	32	1
HRMDS1335HR-4□32	35	32	3
HRMDS1340HR-4□30	40	30	8
HRMDS1350HR-4□32	50	32	18
HRMDS1350HR-4□40	50	40	10
HRMDS1350HR-4□42	50	42	8
HRMDS1363HR-5□32	63	32	31
HRMDS1363HR-5□40	63	40	23
HRMDS1363HR-5□42	63	42	21

The side clearance prevents to interference between tool and workpiece even in deep hole machining

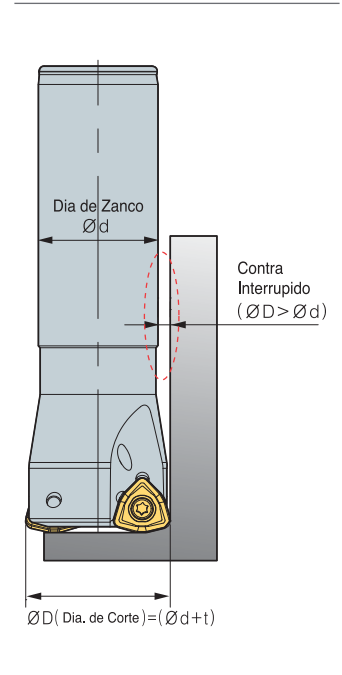

Ramping & helical cutting technical data

Ramping

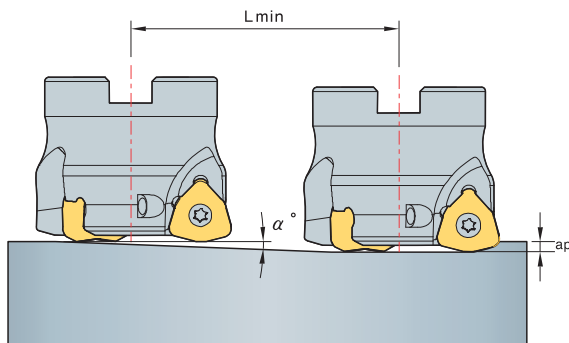

Helical cutting

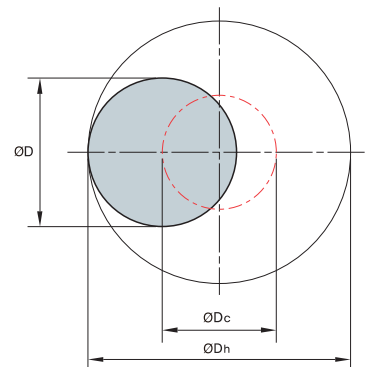

$$L_{min} = \frac{ap}{\tan \alpha^\circ} \text{ (mm)}$$

$$\varnothing D_c = \varnothing D_h - \varnothing D$$

$\varnothing D_c$ = Tool pass of tool center

$\varnothing D_h$ = Desirable hole diameter on workpiece

$\varnothing D$ = Tool dia.

- Adjust feed to under 70% of Recommended cutting condition when ramping & helical cutting
- In helical ramping, max. cutting depth per 1 helical revolution of cutter should not exceed max. cutting depth as per insert size
- in ramping, max. cutting depth for 1 ramping process should not exceed max. depth of cut as per used insert size

Designation	Tool dia. $\varnothing D$ (mm)	Efficient cutting diameter $\varnothing D_e$ (mm)	Ramping			Helical ramping	
			Max. ap (mm)	Max. angle α°	Cutting Length L_{min} (mm)	Dh Min. Cutting diameter (mm)	Dh Max. Cutting diameter (mm)
HRMDS0616HR	16	9.5	1	4.8	11	23.8	29.6
HRMDS0617HR	17	10.5	1	4.1	13	25.8	31.6
HRMDS0618HR	18	11.5	1	3.5	16	27.8	33.6
HRMDS0620HR	20	13.5	1	2.5	22	31.8	37.6
HRMDS0621HR	21	14.5	1	2.2	26	33.8	39.6
HRMDS0625HR	25	18.5	1	1.3	44	41.8	47.6
HRMDS0626HR	26	19.5	1	1.2	47	43.8	49.6
HRMDS0632HR	32	25.5	1	0.6	95	55.8	61.6
HRMDS0633HR	33	26.5	1	0.5	114	57.8	63.6
HRMDS0925HR	25	15.4	1.5	5.4	15.8	37.6	46.8
HRMDS0926HR	26	16.4	1.5	5.0	17.0	39.6	48.8
HRMDS0930HR	30	20.4	1.5	3.9	22.0	47.6	56.8
HRMDS0932HR	32	22.3	1.5	3.5	24.5	51.6	60.8
HRMDS0933HR	33	23.3	1.5	3.3	25.8	53.6	62.8
HRMDS0935HR	35	25.4	1.5	3.0	28.3	57.6	66.8
HRMDS0940HR	40	30.2	1.5	2.5	34.5	67.6	76.8
HRMDS0950HR	50	40.2	1.5	1.8	47.0	87.6	96.8
HRMDS1332HR	32	19.3	2	5.7	20.0	47	60
HRMDS1333HR	33	20.3	2	5.4	21.3	49	62
HRMDS1335HR	35	22.3	2	4.8	24.0	53	66
HRMDS1340HR	40	27.2	2	3.7	30.7	63	76
HRMDS1350HR	50	37	2	2.6	44.0	83	96
HRMDS1363HR	63	50	2	1.9	61.3	109	122
HRMDCM09040HR	40	30.2	1.5	2.5	34.5	67.6	76.8
HRMDCM09050HR	50	40.2	1.5	1.8	47.0	87.6	96.8
HRMDCM09063HR	63	53.1	1.5	1.4	63.3	113.6	122.8
HRMDC(M)09080HR	80	70.1	1.5	1.0	84.5	147.6	156.8
HRMDC(M)09100HR	100	90	1.5	0.8	109.5	187.6	196.8
HRMDCM13050HR	50	37	2	2.6	44.0	83	96
HRMDCM13063HR	63	50	2	1.9	61.3	109	122
HRMDC(M)13080HR	80	66.9	2	1.4	84.0	143	156
HRMDC(M)13100HR	100	86.9	2	1.0	110.7	183	196
HRMDC(M)13125HR	125	111.9	2	0.8	144.0	233	246
HRMDC(M)16080HR	80	63.3	2.5	1.4	102	138	156
HRMDC(M)16100HR	100	83.3	2.5	1	143	178	196
HRMDC(M)16125HR	125	108.3	2.5	0.7	204	228	246
HRMDC(M)16160R	160	143.3	2.5	0.5	286	298	316
HRMDC(M)16200R	200	183.3	2.5	0.3	477	378	396
HRMDC(M)16250R	250	233.3	2.5	0.2	716	478	496
HRMDC(M)16315R	315	298.3	2.5	0.1	1432	608	626

Application area

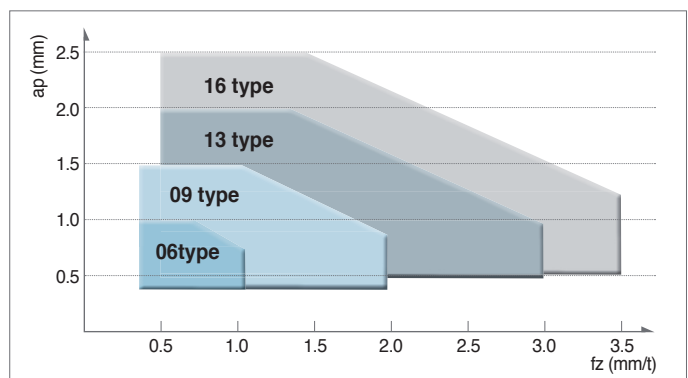
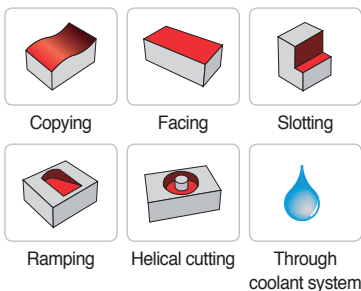

Recommended cutting condition

ISO	Workpiece	Material	Grades	Cutting speed, vc (m/min)		
P	Carbon steel	Low carbon steel	SUM22, C = 0.1~25	PC5300 280 PC5400 245		
		General carbon steel	C = 0.30~55	PC5300 255 PC5400 220		
		High carbon steel	C = 0.55~80	PC5300 240 PC5400 205		
		Low alloy steel (Alloy constituent < 5%)	-	SCM415(H), SCM420, SCM440	PC5300 195 PC5400 170	
			Hardened		PC5300 115 PC5400 100	
		High alloy steel (Alloy constituent > 5%)	Annealed	SKD61	PC5300 150 PC5400 130	
	Hardened		SKH51, SKH55	PC5300 120 PC5400 105		
	M	Stainless steel	Ferritic/Martensitic	SUS410, SUS420, SUS430	PC5300 160 PC5400 135	
			Austenitic	SUS303, SUS304, SUS316	PC5300 130 PC5400 110	
			Duplex (Austenitic/Ferritic)	F51	PC5300 100 PC5400 85	
K			Gray cast iron	Low tensile	GC200, GC250	PC5300 170 PC5400 150
				High tensile	GC300, GC350	PC5300 150 PC5400 130
	Ductile cast iron	Ferritic	GCD400, GCD500	PC5300 170 PC5400 150		
		Pearlitic	GCD600, GCD700	PC5300 150 PC5400 130		
	S	Fe Base	-	Incoloy	PC5300 60 PC5400 50	
		Ni Base	-	Inconel, Nimonic, Hastelloy	PC5300 55 PC5400 45	
Co Base		-	stellite	PC5300 25 PC5400 20		
		-				
Titanium alloys		-	pure Ti	PC5300 130 PC5400 105		
		-	alloy (TiAl6V4)	PC5300 65 PC5400 55		

Machining example



Working condition

- **Workpiece** SM45C (HrC22)
- **Cutting conditions**
 - vc = 283 m/min (1,803⁻¹)
 - fz = 1.4 mm/tooth
 - vf = 10,097 mm/min
 - ap = 0.8 mm
 - ae = 35 mm
 - Coolant: Dry, Machining: Copying
 - Machine: Horizontal MCT
 - Overhang of tool: 250 mm

- **Tools** Insert WNMX130520ZNN-MM (PC3500)
- Holder HRMDCM13050HR-4

40% Increased productivity
80% Reduced tool cost

Test result

In comparing HRMD with our competitor using the same cutting conditions, the cutting speed of HRMD was higher with the same depth of cut (apxae), the cycle time was reduced by 40% and the tool life was increased to over 60%. HRMD is economically more efficient due to the use of 6 cutting-edges compared to EDNW type with positive insert



Working condition

- **Workpiece** STS304
- **Cutting conditions**
 - vc = 130 m/min (414⁻¹)
 - fz = 1.2 mm/tooth
 - vf = 2,981 mm/min
 - ap = 1.0 mm
 - ae = 80 mm
 - Coolant: Wet, Machining: Facing and Slotting
 - Machine: Vertical MCT
 - Overhang of tool: 250 mm

- **Tools** Insert WNMX130520ZNN-MM (PC3545)
- Holder HRMDCM13100HR-6

80% Increased productivity
25% Reduced tool cost

Test result

In comparing HRMD with our competitor using the same cutting conditions, the cutting speed of HRMD was higher with the same depth of cut (apxae), the cycle time was reduced by 80% and the tool life was the same, but HRMD is economically more efficient due to the use of 6 cutting-edges compared to SDKN type with positive insert



HRMDC(M)09

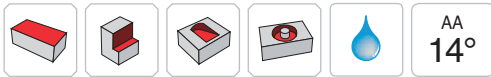
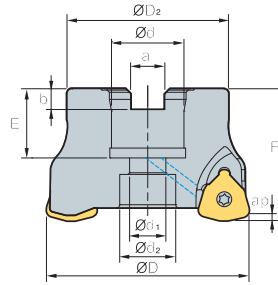

AA
14°
• AR: -7°
• RR: -12° ~ -18°

(mm)

Designation	⚙️	ØD	ØD2	Ød	Ød1	Ød2	a	b	E	F	ap	kg	Bolt	
HRMDCM	09040HR-3	3	40	34	16	9	14	8.4	5.6	19	40	1.5	0.2	SB0825
	09040HR-4	4	40	34	16	9	14	8.4	5.6	19	40	1.5	0.2	
	09050HR-4	4	50	42	22	11	18	10.4	6.3	21	40	1.5	0.3	SB1025
	09050HR-5	5	50	42	22	11	18	10.4	6.3	21	40	1.5	0.3	
	09063HR-5	5	63	49	22	11	18	10.4	6.3	21	40	1.5	0.5	SB1025
	09063HR-6	6	63	49	22	11	18	10.4	6.3	21	40	1.5	0.5	
	09080HR-6	6	80	57	27	14	20	12.4	7	23	50	1.5	1.1	SB1230
	09080HR-7	7	80	57	27	14	20	12.4	7	23	50	1.5	1.1	
	09100HR-7	7	100	67	32	18	26	14.4	8	25	50	1.5	1.7	SB1630
09100HR-8	8	100	67	32	18	26	14.4	8	25	50	1.5	1.7		
HRMDC	09080HR-6	6	80	57	25.4	14	20	9.5	6	24	50	1.5	1.1	SB1230
	09080HR-7	7	80	57	25.4	14	20	9.5	6	24	50	1.5	1.1	
	09080HR-31.75-6	6	80	67	31.75	18	26	12.7	8	32	63	1.5	1.5	SB1630
	09080HR-31.75-7	7	80	67	31.75	18	26	12.7	8	32	63	1.5	1.5	
	09100HR-7	7	100	67	31.75	18	26	12.7	8	32	63	1.5	2.1	SB1630
	09100HR-8	8	100	67	31.75	18	26	12.7	8	32	63	1.5	2.1	

Available inserts

WNMX-MF WNMX-ML WNMX-MM



Designation	Cermet		Coated										Uncoated			page			
	CN2000	CN80	NCM325	NC5330	NCM535	NCM545	PC2505	PC2510	PC3600	PC3700	PC8510	PC9530	PC9540	PC5300	PC5400		ST30A	G10	H01
WNMX 09T316ZNN-MF								●	●					●	●				E28
09T316ZNN-ML														●	●				
09T316ZNN-MM							●	●	●		●			●	●				

Available arbors

Designation	NC arbors	
HRMDCM	09040HR-□	BT□□-FMC16-□□ SK□□-FMC16-□□
	09050HR-□	BT□□-FMC22-□□
	09063HR-□	SK□□-FMC22-□□
	09080HR-□	BT□□-FMC27-□□ SK□□-FMC27-□□
	09100HR-□	BT□□-FMC32-□□ SK□□-FMC32-□□
	HRMDC	09080HR-□
09080HR-31.75-□		BT□□-FMA31.75-□□
09100HR-□		SK□□-FMA31.75-□□

Bolt

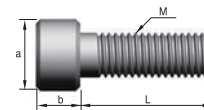

Designation	Dimensions (mm)				
	M	a	b	L	pitch
SB0825	M08	13	8	25	1.25
SB1025	M10	16	10	25	1.5
SB1230	M12	18	12	30	1.75
SB1630	M16	24	16	30	2.0

Parts

Specification		
Ø40-Ø100	FTKA0307	TW09S

Available inserts E28 Available arbors and bolt E400~E402

HRMDC(M)13

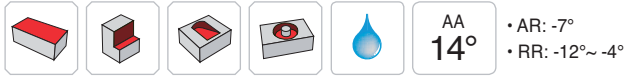
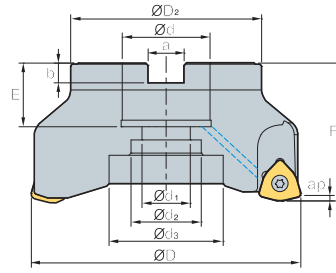

(mm)

Designation	ØD	ØD2	Ød	Ød1	Ød2	Ød3	a	b	E	F	ap	kg	Bolt		
HRMDCM	13050HR-3	3	50	42	22	11	17	-	10.4	6.3	21	40	2	0.3	SB1025
	13050HR-4	4	50	42	22	11	17	-	10.4	6.3	21	40	2	0.3	
	13063HR-4	4	63	49	22	11	18	-	10.4	6.3	21	40	2	0.5	SB1025
	13063HR-5	5	63	49	22	11	18	-	10.4	6.3	21	40	2	0.5	
	13080HR-5	5	80	57	27	14	20	-	12.4	7	23	50	2	1	SB1230
	13080HR-6	6	80	57	27	14	20	-	12.4	7	23	50	2	1	
	13100HR-6	6	100	67	32	18	26	-	14.4	8	25	50	2	1.6	SB1630
	13100HR-7	7	100	67	32	18	26	-	14.4	8	25	50	2	1.6	
13125HR-7	7	125	87	40	22	32	52	16.4	9	29	63	2	3.2	SB2040 MBA-M20	
13125HR-8	8	125	87	40	22	32	52	16.4	9	29	63	2	3.2		
HRMDC	13080HR-5	5	80	57	25.4	14	20	-	9.5	6	24	50	2	1	SB1230
	13080HR-6	6	80	57	25.4	14	20	-	9.5	6	24	50	2	1	
	13080HR-31.75-5	5	80	67	31.75	18	26	-	12.7	8	32	63	2	1.4	SB1630
	13080HR-31.75-6	6	80	67	31.75	18	26	-	12.7	8	32	63	2	1.4	
	13100HR-6	6	100	67	31.75	18	26	-	12.7	8	32	63	2	2.1	SB1630
	13100HR-7	7	100	67	31.75	18	26	-	12.7	8	32	63	2	2.1	
	13125HR-7	7	125	87	38.1	22	32	52	15.9	10	35	63	2	3.3	SB2040 MBA-M20
	13125HR-8	8	125	87	38.1	22	32	52	15.9	10	35	63	2	3.3	

Available inserts

WNMX-MF WNMX-ML WNMX-MM

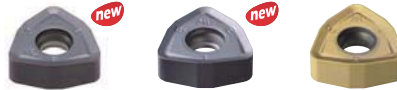

Designation	Cermet		Coated										Uncoated			page			
	CN2000	CN30	NCM325	NC5330	NCM535	NCM545	PC2505	PC2510	PC3600	PC3700	PC6510	PC9530	PC9540	PC5300	PC5400		ST30A	G10	H01
WNMX 130520ZNN-MF								●						●	●				E28
130520ZNN-ML														●	●				
130520ZNN-MM							●	●	●	●		●	●	●	●				

Available arbors

Designation	NC arbors	
HRMDCM	13050HR-□	BT□□-FMC22-□□
		SK□□-FMC22-□□
	13063HR-□	BT□□-FMC22-□□
	13080HR-□	SK□□-FMC27-□□
	13100HR-□	BT□□-FMC32-□□
		SK□□-FMC32-□□
13125HR-□	BT□□-FMC40-□□	
	SK□□-FMC40-□□	
HRMDC	13080HR-□	BT□□-FMA25.4-□□
	13080HR-31.75-□	SK□□-FMA25.4-□□
	13100HR-□	BT□□-FMA31.75-□□
		SK□□-FMA31.75-□□
	13125HR-□	BT□□-FMA38.1-□□
		SK□□-FMA38.1-□□

Bolt

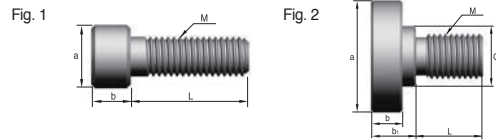

Designation	Dimensions (mm)							Fig.
	M	a	b	b1	C	L	pitch	
SB1025	M10	16	10	-	-	25	1.5	1
SB1230	M12	18	12	-	-	30	1.75	1
SB1630	M16	24	16	-	-	30	2.0	1
SB2040	M20	30	20	-	-	40	2.5	1
MBA-M20	M20	50	14	20	27	30	2.5	2

Parts

Specification	Screw	Wrench
Ø50~Ø125	FTKA0412B	TW15S

Available inserts E28 Available arbors and bolt E400~E402



HRMDC(M)16 new

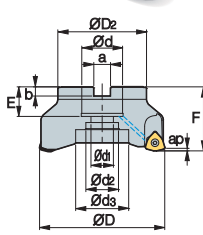

Fig. 1

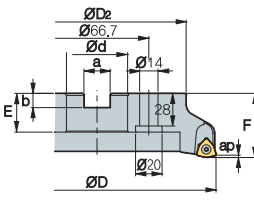

Fig. 2

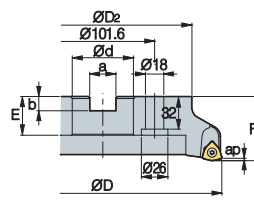

Fig. 3

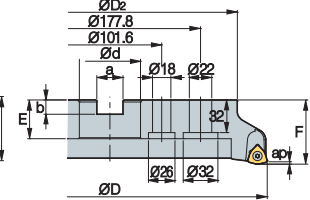
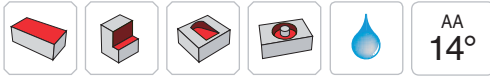

Fig. 4



AA
14°
• AR: -7°
• RR: -12° ~ -4°

(mm)

Designation	ØD	ØD2	Ød	Ød1	Ød2	Ød3	a	b	E	F	ap	kg	Bolt	Fig.	
HRMDC (HRMDCM) 16080HR-4	4	80	65	25.4 (27)	14	20	-	9.5 (12.4)	6 (7)	25 (23)	50	2.5	0.99	SB1230	1
16080HR-5	5	80	65	25.4 (27)	14	20	-	9.5 (12.4)	6 (7)	25 (23)	50	2.5	0.91		
16100HR-5	5	100	85	31.75 (32)	18	26	-	12.7 (14.4)	8	33 (25)	63 (50)	2.5	1.68	SB1630	1
16100HR-6	6	100	85	31.75 (32)	18	26	-	12.7 (14.4)	8	33 (25)	63 (50)	2.5	1.64		
16125HR-6	6	125	100	38.1 (40)	22	32	52	15.9 (16.4)	10 (9)	36 (29)	63	2.5	3.23	SB2040	1
16125HR-7	7	125	100	38.1 (40)	22	32	52	15.9 (16.4)	10 (9)	36 (29)	63	2.5	3.24	MBA-M20	
16160R-7	7	160	107	50.8 (40)	-	90	-	19 (16.4)	11 (9)	38 (32)	63	2.5	3.73	MBA-M24	2
16160R-8	8	160	107	50.8 (40)	-	90	-	19 (16.4)	11 (9)	38 (32)	63	2.5	3.77		
16200R-8	8	200	145	47.625 (60)	-	132	-	25.4 (25.7)	14	38	63	2.5	6.48	-	3
16200R-10	10	200	145	47.625 (60)	-	132	-	25.4 (25.7)	14	38	63	2.5	6.61		
16250R-10	10	250	190	47.625 (60)	-	190	-	25.4 (25.7)	14	38	63	2.5	11.01	-	3
16250R-12	12	250	190	47.625 (60)	-	190	-	25.4 (25.7)	14	38	63	2.5	11.04		
16315R-12	12	315	250	47.625 (60)	-	238	-	25.4 (25.7)	14	38	63	2.5	18.34	-	4
16315R-14	14	315	250	47.625 (60)	-	238	-	25.4 (25.7)	14	38	63	2.5	18.35		

() Metric size

Available inserts

WNNX-MF WNNX-ML WNNX-MM

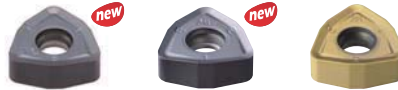

Designation	Cermet		Coated										Uncoated			page		
	CN2000	CN30	NCM325	NC5330	NCM535	NCM545	PC2505	PC2510	PC3600	PC3700	PC6510	PC9530	PC9540	PC5300	PC5400		ST30A	G10
WNNX 160720ZNN-MF									●					●				
160720ZNN-ML									●					●				
160720ZNN-MM									●	●				●	●			

Available arbors

Designation	HRMDC	HRMDCM
HRMDC (HRMDCM) 16080HR-4	BT□□-FMA25.4-□□	BT□□-FMC27-□□
16080HR-5		
16100HR-5	BT□□-FMA31.75-□□	BT□□-FMC32-□□
16100HR-6		
16125HR-6	BT□□-FMA38.1-□□	BT□□-FMB40-□□
16125HR-7		
16160R-7	BT□□-FMA50.8-□□	BT□□-FMC40-□□
16160R-8		
16200R-8		
16200R-10		
16250R-10	BT□□-FMA47.625-□□	BT□□-FMB60-□□
16250R-12		
16315R-12		
16315R-14		

Bolt

Fig. 1

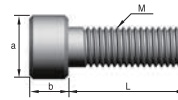
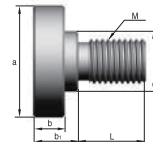

Fig. 2



Designation	Dimensions (mm)							Fig.
	M	a	b	b1	C	L	pitch	
SB1025	M10	16	10	-	-	25	1.5	1
SB1230	M12	18	12	-	-	30	1.75	1
SB1630	M16	24	16	-	-	30	2.0	1
SB2040	M20	30	20	-	-	40	2.5	1
MBA-M20	M20	50	14	20	27	30	2.5	2
MBA-M24	M24	65	14	24	37	36	3.0	2

Parts

Specification	Screw	Wrench
Ø80-Ø315	FTGA0513-P	TW20-100

Available inserts E28 Available arbors and bolt E400~E402

HRMDS06 new

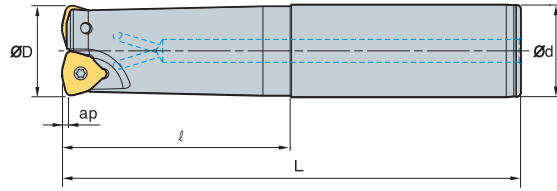

AA
14°

• AR: -7°
 • RR: -17°~ -25°

(mm)

Designation			ØD	Ød	ℓ	L	ap	
HRMDS	0616HR-2S16	2	16	16	30	110	1.0	0.15
	0616HR-2M16	2	16	16	70	150	1.0	0.20
	0616HR-2L16	2	16	16	100	200	1.0	0.26
	0617HR-2S16	2	17	16	20	110	1.0	0.15
	0617HR-2M16	2	17	16	20	150	1.0	0.21
	0617HR-2L16	2	17	16	20	200	1.0	0.28
	0618HR-2S16	2	18	16	20	110	1.0	0.15
	0618HR-2M16	2	18	16	20	150	1.0	0.21
	0618HR-2L16	2	18	16	20	200	1.0	0.28
	0620HR-2S20	2	20	20	50	130	1.0	0.28
	0620HR-2M20	2	20	20	100	180	1.0	0.38
	0620HR-2L20	2	20	20	130	250	1.0	0.53
	0621HR-2S20	2	21	20	20	130	1.0	0.29
	0621HR-2M20	2	21	20	20	180	1.0	0.40
	0621HR-2L20	2	21	20	20	250	1.0	0.57
	0625HR-3S25	3	25	25	60	140	1.0	0.44
	0625HR-3M25	3	25	25	80	180	1.0	0.57
	0625HR-3L25	3	25	25	120	250	1.0	0.80
	0626HR-3S25	3	26	25	30	140	1.0	0.46
	0626HR-3M25	3	26	25	30	180	1.0	0.60
	0626HR-3L25	3	26	25	30	250	1.0	0.84
	0632HR-4S32	4	32	32	70	150	1.0	0.82
	0632HR-4M32	4	32	32	100	200	1.0	1.10
	0632HR-4L32	4	32	32	180	300	1.0	1.66
0633HR-4S32	4	33	32	40	200	1.0	1.14	
0633HR-4M32	4	33	32	40	250	1.0	1.43	
0633HR-4L32	4	33	32	40	300	1.0	1.73	

Available inserts

WNMX-MF WNMX-ML WNMX-MM

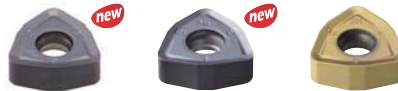

Designation	Cermet		Coated										Uncoated			page			
	CN2000	CN30	NCM325	NC5330	NCM535	NCM545	PC2505	PC2510	PC3600	PC3700	PC6510	PC9530	PC9540	PC5300	PC5400		ST30A	G10	H01
WNMX 060312ZNN-MF								●						●	●				E28
060312ZNN-ML								●						●	●				
060312ZNN-MM							●	●	●	●				●	●				

Parts

Specification		
Ø16~Ø33	ETNA02506	TW07S

Available inserts E28



HRMDS09

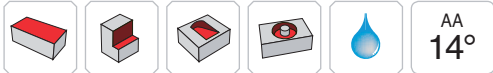
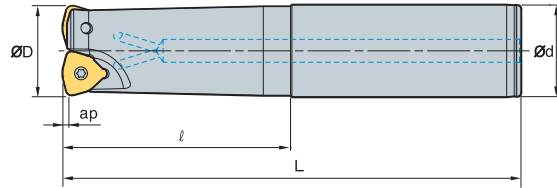

AA
14°
• AR: -7°
• RR: -17° ~ -25°

(mm)

Designation		ØD	Ød	ℓ	L	ap	
HRMDS 0925HR-2S25	2	25	25	60	140	1.5	0.5
0925HR-2M25	2	25	25	120	200	1.5	0.6
0925HR-2L25	2	25	25	180	300	1.5	1
0926HR-2S25	2	26	25	60	140	1.5	0.5
0926HR-2M25	2	26	25	60	200	1.5	0.7
0926HR-2L25	2	26	25	60	300	1.5	1
0930HR-3S32	3	30	32	70	150	1.5	0.8
0930HR-3M32	3	30	32	120	200	1.5	1
0930HR-3L32	3	30	32	180	300	1.5	1.5
0932HR-3S32	3	32	32	70	150	1.5	0.8
0932HR-3M32	3	32	32	120	200	1.5	1.1
0932HR-3L32	3	32	32	180	300	1.5	1.7
0933HR-3S32	3	33	32	70	150	1.5	0.8
0933HR-3M32	3	33	32	70	200	1.5	1.1
0933HR-3L32	3	33	32	70	300	1.5	1.7
0935HR-4S32	4	35	32	50	150	1.5	0.9
0935HR-4M32	4	35	32	50	200	1.5	1.1
0935HR-4L32	4	35	32	50	300	1.5	1.7
0940HR-4S32	4	40	32	50	150	1.5	0.9
0940HR-4M32	4	40	32	50	250	1.5	1.5
0940HR-4L32	4	40	32	50	300	1.5	1.8
0940HR-4S40	4	40	40	60	150	1.5	1.3

Available inserts

WNMX-MF WNMX-ML WNMX-MM



Designation	Cermet		Coated										Uncoated			page			
	CN2000	CN30	NCM325	NC5330	NCM635	NCM645	PC2505	PC2510	PC3600	PC3700	PC6510	PC9530	PC9540	PC5300	PC5400		ST30A	G10	H01
WNMX 09T316ZNN-MF								●	●					●	●				E28
09T316ZNN-ML														●	●				
09T316ZNN-MM							●	●	●		●			●	●				

Parts

Specification		
Ø25~Ø40	FTKA0307	TW09S

Available inserts E28

HRMDS09

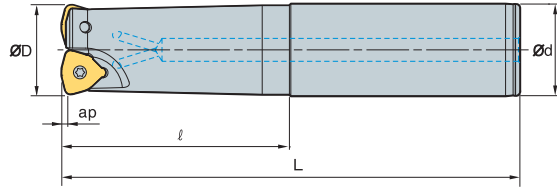

(mm)

Designation		ØD	Ød	ℓ	L	ap	
HRMDS 0940HR-4M40	4	40	40	130	250	1.5	2.2
0940HR-4L40	4	40	40	180	300	1.5	2.7
0940HR-4S42	4	40	42	60	150	1.5	1.4
0940HR-4M42	4	40	42	130	250	1.5	2.3
0940HR-4L42	4	40	42	180	300	1.5	2.8
0950HR-4S32	4	50	32	40	150	1.5	1.1
0950HR-4M32	4	50	32	40	250	1.5	1.6
0950HR-4L32	4	50	32	40	300	1.5	2
0950HR-4S40	4	50	40	40	150	1.5	1.4
0950HR-4M40	4	50	40	40	250	1.5	2.4
0950HR-4L40	4	50	40	40	300	1.5	2.9
0950HR-4S42	4	50	42	40	150	1.5	1.6
0950HR-4M42	4	50	42	40	250	1.5	2.6
0950HR-4L42	4	50	42	40	300	1.5	3.1
0950HR-5S32	5	50	32	40	150	1.5	1.1
0950HR-5M32	5	50	32	40	250	1.5	1.6
0950HR-5L32	5	50	32	40	300	1.5	2
0950HR-5S40	5	50	40	40	150	1.5	1.4
0950HR-5M40	5	50	40	40	250	1.5	2.4
0950HR-5L40	5	50	40	40	300	1.5	2.9
0950HR-5S42	5	50	42	40	150	1.5	1.6
0950HR-5M42	5	50	42	40	250	1.5	2.6
0950HR-5L42	5	50	42	40	300	1.5	3.1

Available inserts

WNMX-MF WNMX-ML WNMX-MM

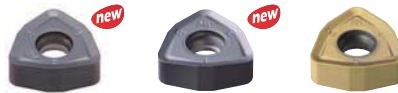

Designation	Cermet		Coated										Uncoated			page			
	CN2000	CN30	NCM325	NC5330	NCM535	NCM545	PC2505	PC2510	PC3600	PC3700	PC6510	PC9530	PC9540	PC5300	PC5400		ST30A	G10	H01
WNMX 09T316ZNN-MF									●	●				●	●				E28
09T316ZNN-ML														●	●				
09T316ZNN-MM							●	●	●		●			●	●				

Parts

Specification		
Ø40-Ø50	FTKA0307	TW09S

Available inserts E28



HRMDS13

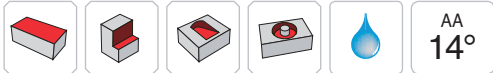
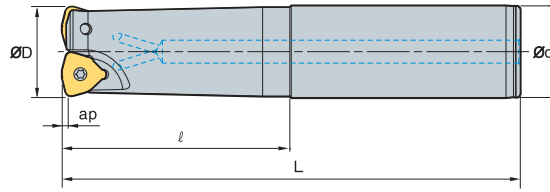

• AR: -7°
• RR: -14° ~ -16°

(mm)

Designation		ØD	Ød	l	L	ap	
HRMDS 1332HR-2S32	2	32	32	70	150	2	0.8
1332HR-2M32	2	32	32	120	200	2	1
1332HR-2L32	2	32	32	180	300	2	1.6
1333HR-2S32	2	33	32	70	150	2	0.8
1333HR-2M32	2	33	32	70	200	2	1.1
1333HR-2L32	2	33	32	70	300	2	1.7
1335HR-2S32	2	35	32	50	150	2	0.8
1335HR-2M32	2	35	32	50	200	2	1.1
1335HR-2L32	2	35	32	50	300	2	1.7
1340HR-3S32	3	40	32	50	150	2	0.8
1340HR-3M32	3	40	32	50	250	2	1.4
1340HR-3L32	3	40	32	50	300	2	1.7
1340HR-3S40	3	40	40	60	150	2	1.2
1340HR-3M40	3	40	40	130	250	2	2.1
1340HR-3L40	3	40	40	180	300	2	2.6
1340HR-3S42	3	40	42	60	150	2	1.4
1340HR-3M42	3	40	42	130	250	2	2.3
1340HR-3L42	3	40	42	180	300	2	2.7
1350HR-3S32	3	50	32	50	150	2	1.1
1350HR-3M32	3	50	32	50	250	2	1.7
1350HR-3L32	3	50	32	50	300	2	2
1350HR-3S40	3	50	40	50	150	2	1.5
1350HR-3M40	3	50	40	50	250	2	2.4
1350HR-3L40	3	50	40	50	300	2	2.9
1350HR-3S42	3	50	42	50	150	2	1.6
1350HR-3M42	3	50	42	50	250	2	2.6
1350HR-3L42	3	50	42	50	300	2	3.1

Available inserts

WNMX-MF WNMX-ML WNMX-MM

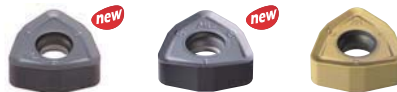

Designation	Cermet		Coated										Uncoated			page		
	CN200	CN30	NCM325	NC5330	NCM535	NCM545	PC2505	PC2510	PC3600	PC3700	PC6510	PC9530	PC9540	PC5300	PC5400		ST30A	G10
WNMX 130520ZNN-MF									●					●	●			
130520ZNN-ML														●	●			
130520ZNN-MM							●	●	●	●		●	●	●	●			

Parts

Specification		
Ø32~Ø50	FTKA0412B	TW15S

Available inserts E28



HRMDS13

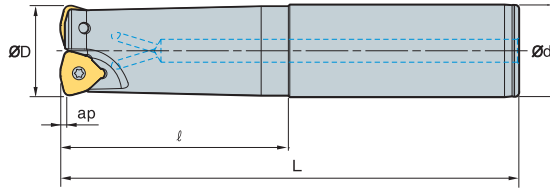

(mm)

Designation		ØD	Ød	ℓ	L	ap	
HRMDS 1350HR-4S32	4	50	32	50	150	2	1.1
1350HR-4M32	4	50	32	50	250	2	1.7
1350HR-4L32	4	50	32	50	300	2	2
1350HR-4S40	4	50	40	50	150	2	1.5
1350HR-4M40	4	50	40	50	250	2	2.4
1350HR-4L40	4	50	40	50	300	2	2.9
1350HR-4S42	4	50	42	50	150	2	1.6
1350HR-4M42	4	50	42	50	250	2	2.6
1350HR-4L42	4	50	42	50	300	2	3.1
1363HR-4S32	4	63	32	50	150	2	1.4
1363HR-4M32	4	63	32	50	250	2	2.1
1363HR-4L32	4	63	32	50	300	2	2.4
1363HR-4S40	4	63	40	50	150	2	1.8
1363HR-4M40	4	63	40	50	250	2	2.8
1363HR-4L40	4	63	40	50	300	2	3.2
1363HR-4S42	4	63	42	50	150	2	1.9
1363HR-4M42	4	63	42	50	250	2	3
1363HR-4L42	4	63	42	50	300	2	3.5
1363HR-5S32	5	63	32	50	150	2	1.5
1363HR-5M32	5	63	32	50	250	2	2
1363HR-5L32	5	63	32	50	300	2	2.3
1363HR-5S40	5	63	40	50	150	2	1.8
1363HR-5M40	5	63	40	50	250	2	2.8
1363HR-5L40	5	63	40	50	300	2	3.2
1363HR-5S42	5	63	42	50	150	2	1.9
1363HR-5M42	5	63	42	50	250	2	3
1363HR-5L42	5	63	42	50	300	2	3.5

Available inserts

WNMX-MF WNMX-ML WNMX-MM

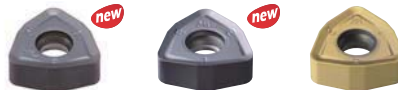

Designation	Cermet		Coated										Uncoated			page			
	CN2000	CN30	NCM325	NC5330	NCM535	NCM545	PC2505	PC2510	PC3600	PC3700	PC6510	PC9530	PC9540	PC5300	PC5400		ST30A	G10	H01
WNMX 130520ZNN-MF									●					●	●				E28
130520ZNN-ML									●					●	●				
130520ZNN-MM							●	●	●	●		●	●	●	●				

Parts

Specification		
Ø50~Ø63	FTKA0412B	TW15S

Available inserts E28



HRMDM06 new

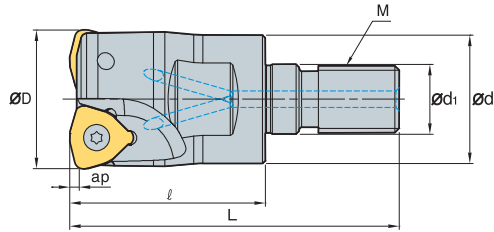

AA
14°
• AR: -7°
• RR: -18° ~ -25°

(mm)

Designation		ØD	Ød	Ød ₁	l	L	M	ap	
HRMDM	0616HR-M08	2	16	14.5	8.5	25	M08	1.0	0.03
	0617HR-M08	2	17	14.5	8.5	25	M08	1.0	0.03
	0618HR-M08	2	18	14.5	8.5	25	M08	1.0	0.03
	0620HR-M10	2	20	18	10.5	30	M10	1.0	0.06
	0621HR-M10	2	21	18	10.5	30	M10	1.0	0.07
	0625HR-M12	3	25	23	12.5	35	M12	1.0	0.10
	0626HR-M12	3	26	23	12.5	35	M12	1.0	0.11
	0632HR-M16	4	32	29	17	40	M16	1.0	0.21
	0633HR-M16	4	33	29	17	40	M16	1.0	0.22

Available inserts

WNMX-MF WNMX-ML WNMX-MM



Designation	Cermet		Coated										Uncoated			page			
	CN2000	CN30	NCM325	NC5330	NCM535	NCM545	PC2505	PC2510	PC3600	PC3700	PC6510	PC9530	PC9540	PC5300	PC5400		ST30A	G10	H01
WNMX 060312ZNN-MF									●						●	●			
060312ZNN-ML															●	●			
060312ZNN-MM							●	●	●	●				●	●				

Available adaptor

Designation	Available adaptor	Designation	Available adaptor
HRMDM 0616HR-M08	MAT- M08	HRMDM 0625HR-M12	MAT- M12
0617HR-M08	MAT- M08	0626HR-M12	MAT- M12
0618HR-M08	MAT- M08	0632HR-M16	MAT- M16
0620HR-M10	MAT- M10	0633HR-M16	MAT- M16
0621HR-M10	MAT- M10		

Designation: HRMDM0625HR-M12
Modular head threading measure size (M12)

II

Adaptor spec.: MAT-M12-030-S20S
Adaptor threading measure (M12)

Parts

Specification		
Ø16~Ø33	Screw ETNA02506	Wrench TW07S

Available inserts E28 Available adaptor E371~E372

HRMDM09

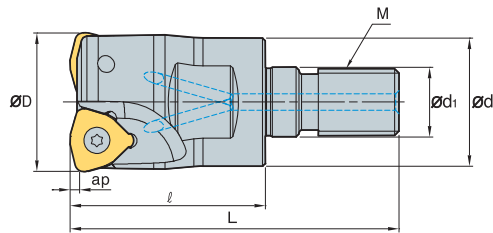
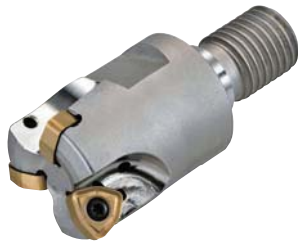

AA
14°
• AR: -7°
• RR: -18°~ -25°

(mm)

Designation		ØD	Ød	Ød1	l	L	M	ap	
HRMDM	0925HR-M12	2	25	23	12.5	35	M12	1.5	0.10
	0926HR-M12	2	26	23	12.5	35	M12	1.5	0.11
	0930HR-M16	3	30	29	17	40	M16	1.5	0.19
	0932HR-M16	3	32	29	17	40	M16	1.5	0.20
	0933HR-M16	3	33	29	17	40	M16	1.5	0.21
	0935HR-M16	4	35	29	17	40	M16	1.5	0.22
	0940HR-M16	4	40	29	17	40	M16	1.5	0.25

Available inserts

WNMX-MF WNMX-ML WNMX-MM

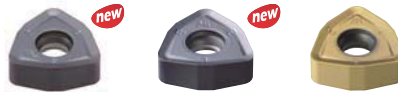

Designation	Cermet		Coated											Uncoated			page		
	CN2000	CN80	NCM325	NC5330	NCM535	NCM545	PC2505	PC2510	PC3600	PC3700	PC6510	PC9530	PC9540	PC5300	PC5400	ST30A		G10	H01
WNMX	09T316ZNN-MF								●	●				●	●				E28
	09T316ZNN-ML													●	●				
	09T316ZNN-MM						●		●	●		●		●	●				

Available adaptor

Designation	Available adaptor	
HRMDM	0925HR-M12	MAT- M12
	0926HR-M12	
	0930HR-M16	
	0932HR-M16	MAT- M16
	0933HR-M16	
	0935HR-M16	
	0940HR-M16	

Designation: HRMDM0932HR-M16
Modular head threading measure size (M16)

II

Adaptor spec.: MAT-M16-035-S32S
Adaptor threading measure (M16)

Parts

Specification		
Ø25~Ø40	FTKA0307	TW09S

Available inserts E28 Available adaptor E371~E372



HRMDM13

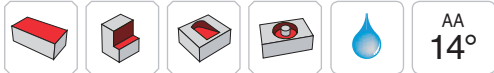
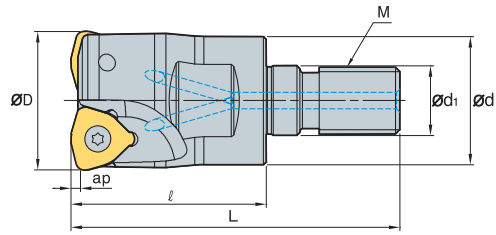
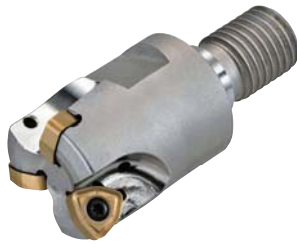

AA
14°
• AR: -7°
• RR: -18° ~ -25°

(mm)

Designation	Inserts	ØD	Ød	Ød1	ℓ	L	M	ap	kg
HRMDM	1332HR-M16	2	32	29	17	40	M16	2	0.20
	1333HR-M16	2	33	29	17	40	M16	2	0.20
	1335HR-M16	2	35	29	17	40	M16	2	0.22
	1340HR-M16	3	40	29	17	45	M16	2	0.26

Available inserts

WNMX-MF WNMX-ML WNMX-MM

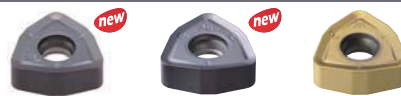

Designation	Cermet		Coated										Uncoated			page			
	CN2000	CN30	NCM325	NC5330	NCM635	NCM645	PC2505	PC2510	PC3600	PC3700	PC6510	PC9530	PC9540	PC6300	PC5400		ST30A	G10	H01
WNMX	130520ZNN-MF								●					●	●				E28
	130520ZNN-ML													●	●				
	130520ZNN-MM						●	●	●	●		●	●	●	●				

Available adaptor

Designation	Available adaptor
HRMDM 1332HR-M16	MAT-M16
1333HR-M16	
1335HR-M16	
1340HR-M16	

Designation: HRMDM0932HR-M16
Modular head threading measure size (M16)

||

Adaptor spec.: MAT-M16-120-S32T
Adaptor threading measure (M16)

Parts

Specification	Screw	Wrench
Ø32~Ø40	FTKA0412B	TW15S

Available inserts E28 Available adaptor E371~E372

HRMC(M)13

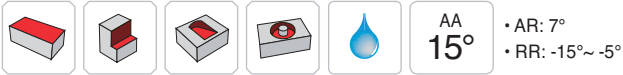
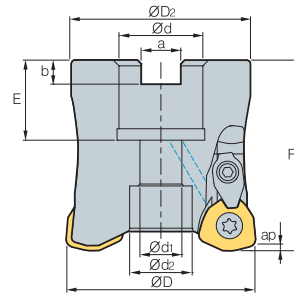

(mm)

Designation		ØD	ØD2	Ød	Ød1	Ød2	a	b	E	F	ap		Bolt	
HRMC (HRMCM)	13050HR-3	3	50	47	22.225 (22)	11	16.4	8.0 (10.4)	5 (6.3)	20 (21)	50	2.0	0.4	SB1035
	13050HR-4	4	50	47	22.225 (22)	11	16.4	8.0 (10.4)	5 (6.3)	20 (21)	50	2.0	0.4	SB1035
	13063HR-4	4	63	60	22.225 (22)	11	17	8.0 (10.4)	5 (6.3)	20 (21)	50	2.0	0.7	SB1035
	13080HR-5	5	80	76	31.75 (27)	18 (13)	26 (20)	12.7 (12.4)	8 (7)	32 (23)	70	2.0	1.6	SB16 (12)45

()Metric size

Available inserts

WDKT-MH



Designation	Cermet		Coated								Uncoated			page					
	CN2000	CN30	NCM325	NC5330	NCM535	NCM545	PC2505	PC2510	PC3600	PC3700	PC6510	PC9530	PC9540		PC5300	PC5400	ST30A	G10	H01
WDKT 130520ZDSR-MH							●	●	●		●	●		●	●				E27

Available arbors

Designation	HRMDC	HRMDCM
HRMC (HRMCM)	13050HR-3	
	13050HR-4	BT□□-FMA22.225-□□ SK□□-FMC22-□□
	13063HR-4	
13080HR-5	BT□□-FMA31.75-□□ SK□□-FMA31.75-□□	BT□□-FMC27-□□ SK□□-FMC27-□□

Bolt

Fig. 1

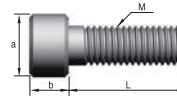
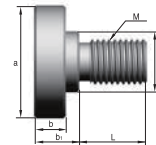

Fig. 2



Designation	Dimensions (mm)							Fig.
	M	a	b	b1	C	L	pitch	
SB1035	M10	16	10	-	-	35	1.5	1
SB1245	M12	18	12	-	-	45	1.75	1
SB1645	M16	24	16	-	-	45	2.0	1
SB2040	M20	30	20	-	-	40	2.5	1
MBA-M20	M20	50	14	20	27	30	2.5	2
MBA-M24	M24	65	14	24	37	36	3.0	2

Parts

Specification					
Ø50-Ø80	FTGA0513-P	CHH4.5R1	CTX04513H	CR03	TW20-100

Available inserts E27 Available arbors and bolt E400-E402



HRMC(M)15

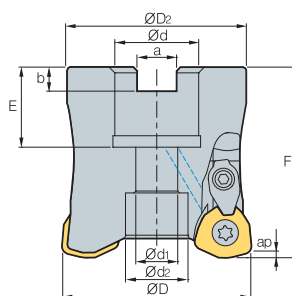

• AR: 7°
• RR: -15° ~ -5°

(mm)

Designation	3	4	5	6	6	7	ØD	ØD	Ød	Ød1	Ød2	a	b	E	F	ap	kg	Bolt
HRMC (HRMCM) 15063HR-3	3	4	5	6	6	7	63	60	22.225 (22)	11	17	8.0 (10.4)	5 (6.3)	20 (21)	50	2.5	0.7	SB1035
15080HR-4	4	5	6	6	6	7	80	76	31.75 (27)	18 (13)	26 (20)	12.7 (12.4)	8 (7)	32 (23)	70	2.5	1.7	SB16 (12)45
15100HR-5	5	6	6	6	6	7	100	96	31.75 (32)	18	26	12.7 (14.4)	8 (8)	32 (26)	70	2.5	2.8	SB1645
15100HR-6	6	6	6	6	6	7	100	96	31.75 (32)	18	26	12.7 (14.4)	8 (8)	32 (26)	70	2.5	3.2	SB1645
15125HR-6	6	6	6	6	6	7	125	98	38.1 (40)	22	32	15.9 (16.4)	10 (9)	35 (29)	63	2.5	3.3	SB2040
15160R-7	7	6	6	6	6	7	160	100	50.8 (40)	-	72	19.0 (16.4)	11 (9)	38 (35)	63	2.5	4.3	MBA-M24 (M20)

() Metric size

Available inserts

WDKT-MH



Designation	Cermet		Coated										Uncoated			page			
	CN2000	CN30	NCM325	NC5330	NCM535	NCM545	PC2505	PC2510	PC3600	PC3700	PC6510	PC9530	PC9540	PC5300	PC5400		ST30A	G10	H01
WDKT 150625ZDSR-MH									●	●	●	●		●	●				E27

Available arbors

Designation	HRMDC	HRMDCM
HRMC (HRMCM) 15063HR-3	BT□□-FMA22.225-□□	BT□□-FMC22-□□ SK□□-FMC22-□□
15080HR-4	BT□□-FMA31.75-□□ SK□□-FMA31.75-□□	BT□□-FMC27-□□ SK□□-FMC27-□□
15100HR-5		BT□□-FMC32-□□ SK□□-FMC32-□□
15100HR-6		
15125HR-6	BT□□-FMA38.1-□□ SK□□-FMA38.1-□□	BT□□-FMB40-□□ BT□□-FMC40-□□
15160R-7	BT□□-FMA50.8-□□	SK□□-FMC40-□□

Bolt

Fig. 1

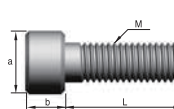
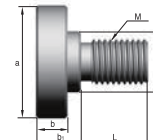

Fig. 2



Designation	Dimensions (mm)							Fig.
	M	a	b	b1	C	L	pitch	
SB1035	M10	16	10	-	-	35	1.5	1
SB1245	M12	18	12	-	-	45	1.75	1
SB1645	M16	24	16	-	-	45	2.0	1
SB2040	M20	30	20	-	-	40	2.5	1
MBA-M20	M20	50	14	20	27	30	2.5	2
MBA-M24	M24	65	14	24	37	36	3.0	2

Parts

Specification					
Ø63-Ø160	FTGA0513-P	CHH5.5R1	CTX0515	CR04	TW20-100

Available inserts E27 Available arbors and bolt E400~E402

HRMS08/10

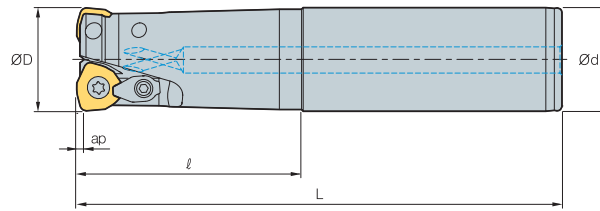

AA **15°**
 • AR: 7°
 • RR: -11° ~ -5°

(mm)

Designation		ØD	Ød	l	L	ap	
HRMS	0820HR-2S20	2	20	20	50	130	0.3
	0820HR-2M20	2	20	20	100	180	0.4
	0820HR-2L20	2	20	20	130	250	0.5
	0821HR-2S20	2	21	20	50	130	0.3
	0821HR-2M20	2	21	20	50	180	0.4
	0821HR-2L20	2	21	20	50	250	0.5
	1025HR-2S25	2	25	25	60	140	0.4
	1025HR-2M25	2	25	25	120	200	0.6
	1025HR-2L25	2	25	25	180	300	0.9
	1026HR-2S25	2	26	25	60	140	0.4
	1026HR-2M25	2	26	25	60	200	0.6
	1026HR-2L25	2	26	25	60	300	1.0
	1030HR-2S32	2	30	32	70	150	0.8
	1030HR-2M32	2	30	32	120	200	1.0
1030HR-2L32	2	30	32	180	300	1.5	

Available inserts

WDKT-MH



Type	Designation	Cermet		Coated										Uncoated			page			
		CN2000	CN30	NCM325	NC5330	NCM535	NCM545	PC2505	PC2510	PC3600	PC3700	PC6510	PC9530	PC9540	PC5300	PC5400		ST30A	G10	H01
08 type	WDKT 080316ZDSR-MH							●	●	●	●	●	●	●	●	●				E27
10 type	WDKT 10T320ZDSR-MH							●	●	●	●	●	●	●	●	●				

Parts

Specification					
Ø20~Ø21 (08 type)	FTNA0306	-	-	-	TW09P
Ø25~Ø30 (10 type)	FTKA0408	CHH3.5R1	CTX03510	CR03	TW15S

Available inserts E27



HRMS13

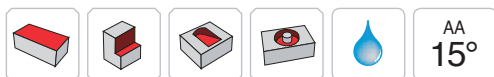
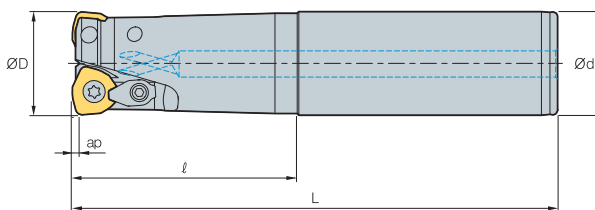

AA
15°
• AR: 7°
• RR: -11° ~ -5°

(mm)

Designation		ØD	Ød	l	L	ap	
HRMS	1332HR-2S32	2	32	32	70	150	0.8
	1332HR-2M32	2	32	32	120	200	1.0
	1332HR-2L32	2	32	32	180	300	1.6
	1333HR-2S32	2	33	32	70	150	0.8
	1333HR-2M32	2	33	32	70	200	1.1
	1333HR-2L32	2	33	32	70	300	1.7
	1335HR-2S32	2	35	32	50	150	0.8
	1335HR-2M32	2	35	32	50	200	1.1
	1335HR-2L32	2	35	32	50	300	1.7
	1340HR-3S32	3	40	32	50	150	0.8
	1340HR-3M32	3	40	32	50	250	1.4
	1340HR-3L32	3	40	32	50	300	1.7
	1340HR-3S40	3	40	40	60	150	1.2
	1340HR-3M40	3	40	40	130	250	2.1
	1340HR-3L40	3	40	40	180	300	2.6
	1340HR-3S42	3	40	42	60	150	1.4
	1340HR-3M42	3	40	42	130	250	2.3
	1340HR-3L42	3	40	42	180	300	2.7

Available inserts

WDKT-MH



Designation	Cermet		Coated										Uncoated			page			
	CN2000	CN30	NCM325	NC5330	NCM535	NCM545	PC2505	PC2510	PC3600	PC3700	PC6510	PC9530	PC9540	PC5300	PC5400		ST30A	G10	H01
WDKT 130520ZDSR-MH							●	●	●		●	●		●	●				E27

Parts

Specification					
Ø32,33,35	FTGA0510-P	CHH4.5R1	CTX04513H	CR03	TW20
Ø40	FTGA0512-P	CHH5.5R1	CTX04513H	CR03	TW20

Available inserts E27

HRMS15

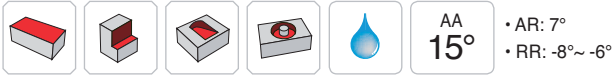
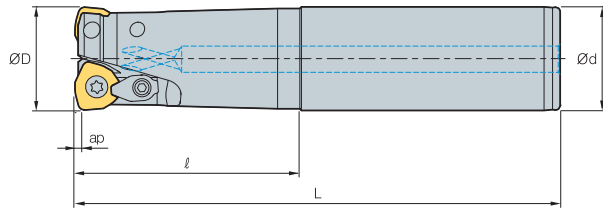

(mm)

Designation		ØD	Ød	l	L	ap	
HRMS	1550HR-3S32	3	50	32	50	150	1.0
	1550HR-3M32	3	50	32	50	250	1.6
	1550HR-3L32	3	50	32	50	300	1.9
	1550HR-3S40	3	50	40	50	150	1.4
	1550HR-3M40	3	50	40	50	250	2.3
	1550HR-3L40	3	50	40	50	300	2.8
	1550HR-3S42	3	50	42	50	150	1.5
	1550HR-3M42	3	50	42	50	250	2.5
	1550HR-3L42	3	50	42	50	300	3.0
	1563HR-4S32	4	63	32	50	150	1.3
	1563HR-4M32	4	63	32	50	250	1.9
	1563HR-4L32	4	63	32	50	300	2.2
	1563HR-4S40	4	63	40	50	150	1.7
	1563HR-4M40	4	63	40	50	250	2.6
	1563HR-4L40	4	63	40	50	300	3.1
	1563HR-4S42	4	63	42	50	150	1.8
1563HR-4M42	4	63	42	50	250	2.8	
1563HR-4L42	4	63	42	50	300	3.3	

Available inserts

WDKT-MH



Designation	Cermet		Coated											Uncoated			page		
	CN2000	CN30	NCM825	NC5330	NCM635	NCM645	PC2505	PC2510	PC3600	PC3700	PC6510	PC9530	PC9540	PC5300	PC5400	ST30A		G10	H01
WDKT 150625ZDSR-MH								●	●	●	●			●	●				E27

Parts

Specification					
Ø50~Ø63	FTGA0513-P	CHH5.5R1	CTX0515	CR04	TW20

Available inserts E27



HRMM08

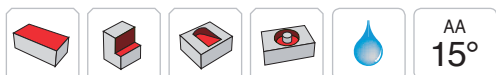
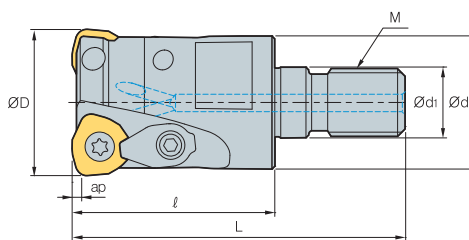

• AR: 7°
• RR: -11°~ -5°

(mm)

Designation		ØD	Ød	Ød1	ℓ	L	M	ap	
HRMM	0820HR-M10	2	20	18	10.5	30	M10	1	0.06
	0821HR-M10	2	21	18	10.5	30	M10	1	0.06
	0825HR-M12	3	25	23	12.5	35	M12	1	0.11
	0826HR-M12	3	26	23	12.5	35	M12	1	0.11
	0828HR-M12	3	28	23	12.5	35	M12	1	0.12
	0832HR-M16	4	32	29	17	40	M16	1	0.21
	0833HR-M16	4	33	29	17	40	M16	1	0.21
	0835HR-M16	4	35	29	17	40	M16	1	0.23
	0840HR-M16	5	40	29	17	40	M16	1	0.25

Available inserts

WDKT-MH



Designation	Cermet		Coated											Uncoated			page		
	CN2000	CN30	NCM325	NC5330	NCM535	NCM545	PC2505	PC2510	PC3800	PC3700	PC6510	PC9530	PC9540	PC5300	PC5400	ST30A		G10	H01
WDKT 080316ZDSR-MH							●	●	●	●	●	●	●	●	●				E27

Available adaptor

Designation	Available adaptor	
HRMM	0820HR-M10	MAT-M10
	0821HR-M10	
	0825HR-M12	
	0826HR-M12	MAT-M12
	0828HR-M12	
	0832HR-M16	
	0833HR-M16	MAT-M16
	0835HR-M16	
	0840HR-M16	

Designation: HRMM0820HR-M10
Modular head threading measure size (M10)

||

Adaptor spec.: MAT-M10-030-S20S
Adaptor threading measure (M10)

Parts

Specification						
Ø20~Ø40	FTNA0306	-	-	-	-	-

Available inserts E27 Available adaptor E371~E372

HRMM10/13

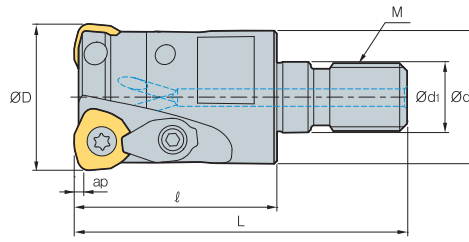

AA **15°**
 • AR: 7°
 • RR: -11° ~ -5°

(mm)

Designation		ØD	Ød	Ød1	l	L	M	ap	
HRMM	1025HR-M12	2	25	23	12.5	35	M12	1.5	0.1
	1026HR-M12	2	26	23	12.5	35	M12	1.5	0.1
	1030HR-M16	2	30	29	17	40	M16	1.5	0.2
	1032HR-M16	3	32	29	17	45	M16	1.5	0.26
	1035HR-M16	3	35	29	17	45	M16	1.5	0.23
	1040HR-M16	4	40	29	17	45	M16	1.5	0.27
HRMM	1332HR-M16	2	32	29	17	40	M16	2	0.17
	1333HR-M16	2	33	29	17	40	M16	2	0.17
	1335HR-M16	2	35	29	17	40	M16	2	0.19
	1340HR-M16	3	40	29	17	45	M16	2	0.24

Available inserts

WDKT-MH



Type	Designation	Cermet		Coated										Uncoated			page			
		CN2000	CN30	NCM325	NC5330	NCM535	NCM545	PC2505	PC2510	PC3600	PC3700	PC6510	PC9530	PC9540	PC5300	PC5400		ST30A	G10	H01
10 type	WDKT 10T320ZDSR-MH							●	●	●	●	●	●	●	●	●				E27
13 type	WDKT 130520ZDSR-MH							●	●	●		●	●		●	●				

Available adaptor

Designation	Available adaptor
HRMM 1025HR-M12	MAT-M12
1026HR-M12	
1030HR-M16	
1032HR-M16	MAT-M16
1035HR-M16	
1040HR-M16	
1332HR-M16	MAT-M16
1333HR-M16	
1335HR-M16	
1340HR-M16	

Designation: HRMM0820HR-M10
Modular head threading measure size (M10)

||

Adaptor spec.: MAT-M10-030-S20S
Adaptor threading measure (M10)

Parts

Specification						
Ø25~Ø40 (10 type)	FTKA0408	CHH3.5R1	CTX03510	CR03	TW15S	-
Ø32, 33, 35 (13 type)	FTGA0510-P	CHH4.5R1	CTX04513H	CR03	-	TW20
Ø40 (13 type)	FTGA0512-P	CHH5.5R1	CTX04513H	CR03	-	TW20

Available inserts E27 Available adaptor E371~E372



THE

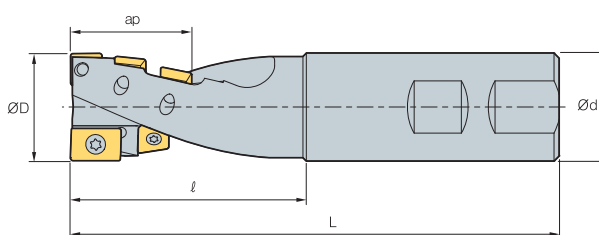

AA
90°
• AR: 5°, 10°
• RR: -5°

(mm)

Designation	ØD	Ød	ℓ	L	ap	No. of flute	kg	Available inserts		
								Lower cutting-edge	External cutting-edge	
THE	25R	25	25	55	120	25	2	0.4	APLT070304R 1z	SPMT060304 4z
	32R	32	32	70	145	40	2	0.5	ADLT150308R 1z	SDMT090308-MM 5z
	40R	40	42	88	175	54	2	1.3	ZPMT1504PPSR-MM 1z	SPMT120408-MM 5z
	50R	50	42	85	175	54	4	1.4	ZPMT1504PPSR-MM 2z	SPMT120408-MM 10z

Available inserts

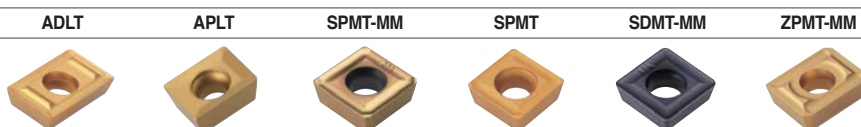

Designation	Cermet		Coated											Uncoated			page		
	CN2000	CN30	NCM325	NC5330	NCM535	NCM545	PC2505	PC2510	PC3600	PC3700	PC6510	PC9530	PC9540	PC5300	PC5400	ST30A		G10	H01
SPMT 060304			●																
SDMT 090308-MM										●				●					E04
SPMT 120408-MM										●				●					E05
APLT 070304R														●					E18
ADLT 150308R			●											●					E25
ZPMT 1504PPSR-MM										●				●					E31

Recommended cutting condition

• Grooving

Workpiece	Cutting Condition		Grades
	vc (m/min)	fz (mm/t)	
P	90~140	0.05~0.2	PC5300
M	50~90	0.05~0.2	PC5300
K	70~120	0.05~0.25	PC5300

• Side cutting

Workpiece	Cutting Condition		Grades
	vc (m/min)	fz (mm/t)	
P	150~240	0.05~0.2	PC5300
M	90~150	0.05~0.2	PC5300
K	120~200	0.10~0.25	PC5300

Parts

Specification	Screw	Wrench	Wrench
Ø25	ETNA02506	TW07P	-
Ø32	ETNA0408	-	TW15S
Ø40	ETNA0511	-	TW20S
Ø50	ETNA0511	-	TW20S

Available inserts E04, E05, E18, E25, E31

E Technical Information for TP2P

This milling tool series with its tangential clamping system increases stable machining and productivity, while improving perpendicularity

Tangen-Pro TP2P new

- Clamping stability gained through tangential clamping system and wedge-shaped inserts
- Excellent surface finish nearly perfect perpendicularity, and highly even flank surface compared to competitors' designs
- Improved productivity due to High-rake angles and sharp cutting-edges which lead to lower cutting resistance
→ Ideally suited for high speed and high feed machining

Code system

• Insert

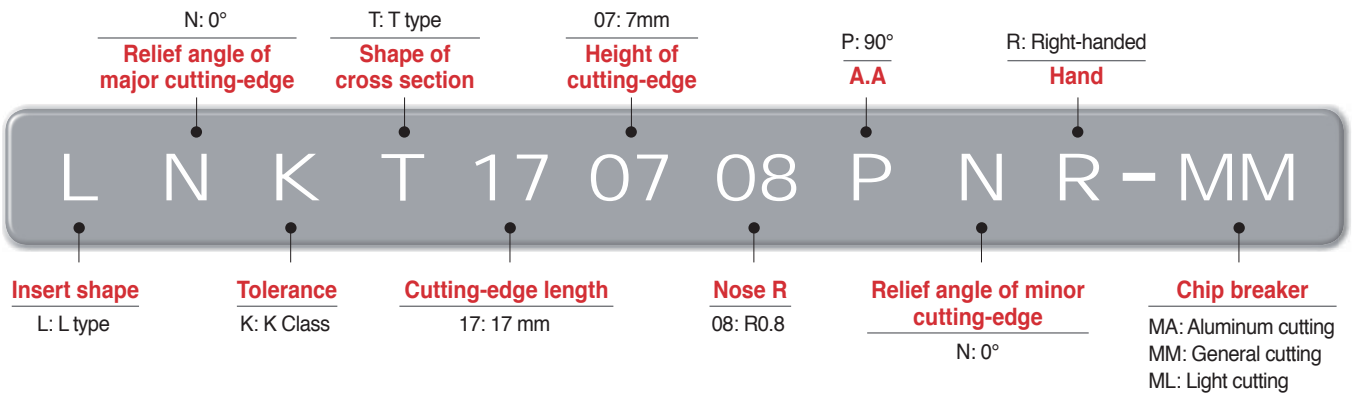

• Shank type

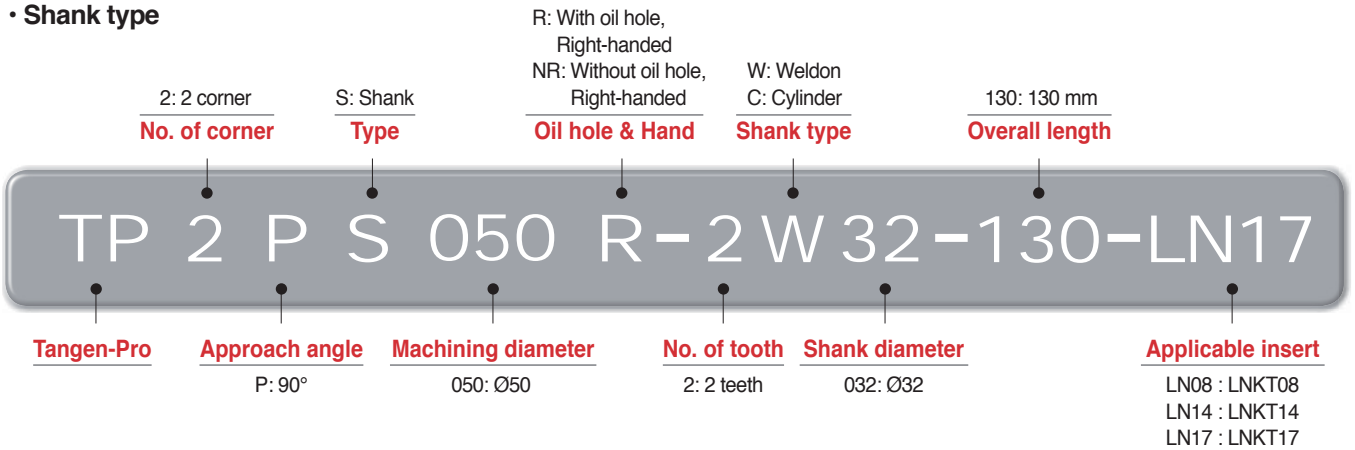

• Cutter type

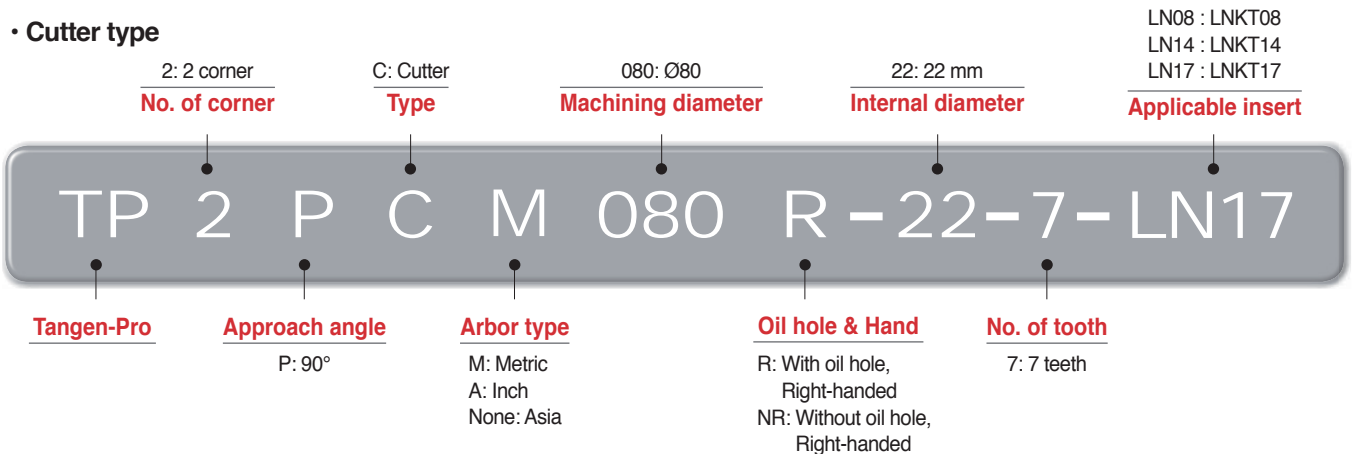

Features of insert

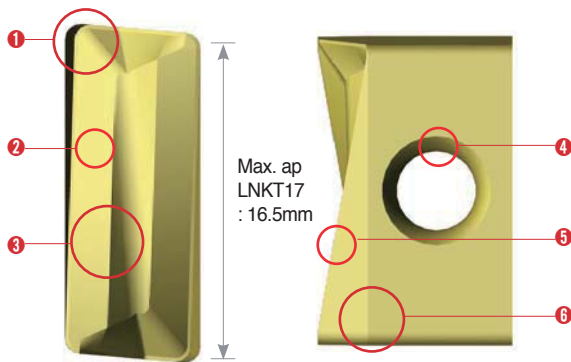

1 Wedge type clamping area

- Clamping in wedge form on seats
→ Creates strong clamping force

2 High-rake angle chip breaker

- High-rake angle applied
- Produces smooth chip flow
→ Extended insert life

3 Convex projection

- Improved chip evacuation
- Enhances rigidity

4 Side hole (tangential type)

- Higher clamping stability

5 High-rake angle cutting-edges

- Improves cutting performance while reducing cutting load

6 2-level flank relief surface

- 1st reverse positive relief surface enhances rigidity
- 2nd negative relief surface enables stable clamping
→ Improved chipping resistance and surface finish

Features of cutter

- Tangential clamping system, wedge-shaped inserts and wide seat area
→ Higher clamping stability
→ Lower vibrations and cutting resistance during machining



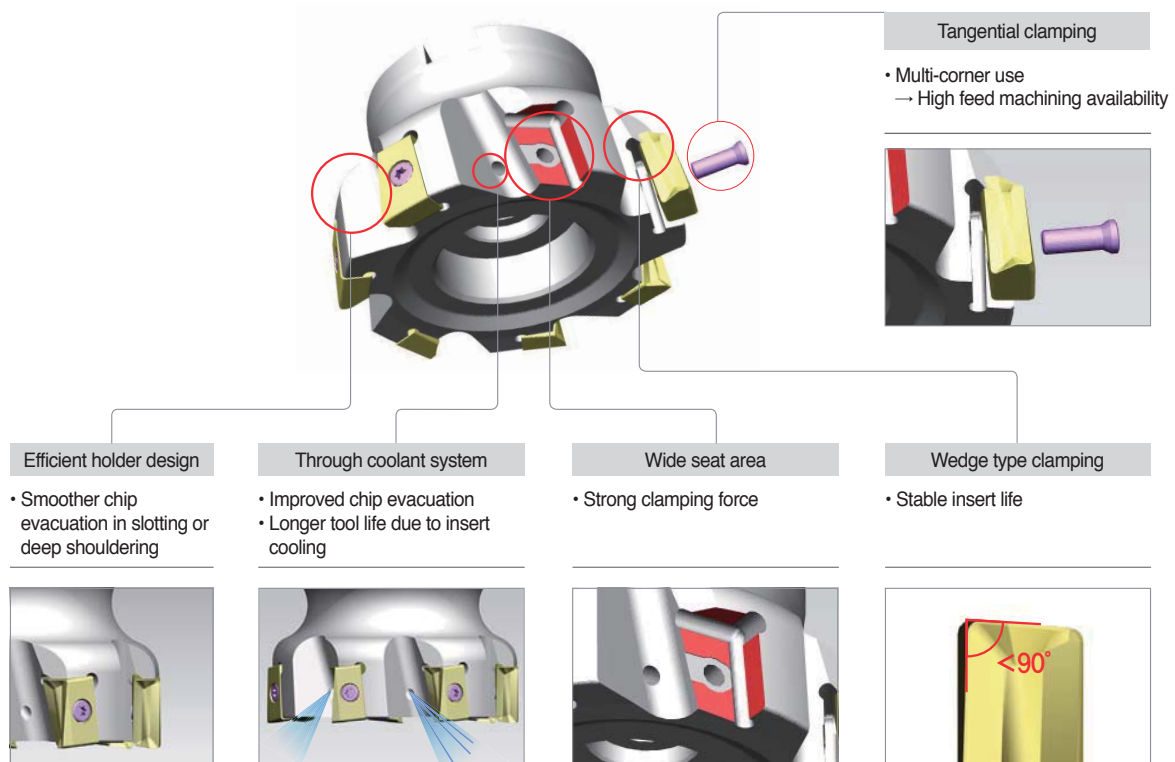



- Optimized H/D design with curved surface for smooth chip flow
→ Excellent chip evacuation in ramping or deep shouldering



Application guideline for grade

Workpiece		P		K	N
		Carbon steel	Alloy steel	Cast iron	Aluminum
Grades	High speed cutting	PC5300	PC5300	PC6510	H01
	General cutting	PC5400	PC5300	PC6510	H01
	Interrupted cutting	PC5400	PC5400	PC5300	H01

Features of chip breaker

Insert	Cutting-edge	Uses	Features
MA 		Aluminum	Exclusive sharp cutting edge for aluminum machining ensures good chip flow due to surface buffing treatment and high welding resistance.
ML 		Light cutting	Chip breaker design for low cutting resistance that provides excellent tool life and quality surface finishes in light cutting and hard-to-cut materials
MM 		General cutting	Universal design for general shoulder milling operations, highly suitable in most applications

Recommended cutting condition

• LNKT08

Workpiece	Grades	vc (m/min)	fz (mm/t)	Max. ap (mm)	Applicable insert
P Steel	PC5300	150~240	0.25~0.05	8.0	LNKT0804□□PNR-MM
	PC5400	130~210	0.25~0.05	8.0	
K Cast iron	PC6510	100~250	0.25~0.05	8.0	LNKT0804□□PNR-ML
	PC5300	100~200	0.25~0.05	8.0	
N Aluminum	H01	500~1000	0.25~0.05	8.0	LNKT0804□□PNR-MA

* The above data refer to general cutting conditions and can be adjustable to the speed of 300m/min and the feed per tooth of 0.5 mm/t depending on user environment.

• LNKT14

Workpiece	Grades	vc (m/min)	fz (mm/t)	Max. ap (mm)	Applicable insert
P Steel	PC5300	150~240	0.25~0.05	12.7	LNKT1406□□PNR-MM
	PC5400	130~210	0.25~0.05	12.7	
K Cast iron	PC6510	100~250	0.25~0.05	12.7	LNKT1406□□PNR-ML
	PC5300	100~200	0.25~0.05	12.7	
N Aluminum	H01	500~1000	0.25~0.05	12.7	LNKT1406□□PNR-MA

* The above data refer to general cutting conditions and can be adjustable to the speed of 300m/min and the feed per tooth of 0.5 mm/t depending on user environment.

• LNKT17

Workpiece	Grades	vc (m/min)	fz (mm/t)	Max. ap (mm)	Applicable insert
P Steel	PC5300	150~240	0.25~0.05	16.5	LNKT1707□□PNR-MM
	PC5400	130~210	0.25~0.05	16.5	
K Cast iron	PC6510	100~250	0.25~0.05	16.5	LNKT1707□□PNR-ML
	PC5300	100~200	0.25~0.05	8.0	
N Aluminum	H01	500~1000	0.25~0.05	16.5	LNKT1707□□PNR-MA

* The above data refer to general cutting conditions and can be adjustable to the speed of 300m/min and the feed per tooth of 0.5 mm/t depending on user environment.

Application area

► Higher speed and feed machining than competitor's increases machinability.

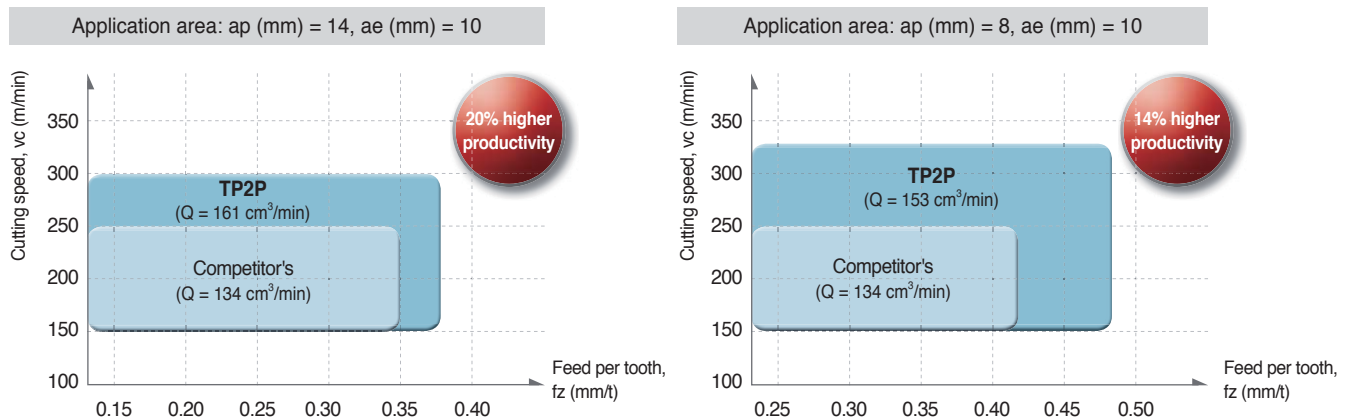

TP2PCM-LN08 new

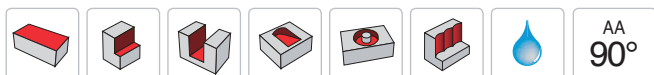
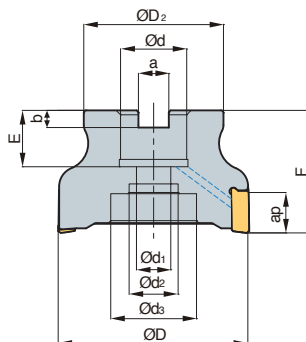

AA **90°**
 • AR: -6°
 • RR: -26° ~ -22°

(mm)

Designation		$\varnothing D$	$\varnothing D_2$	$\varnothing d$	$\varnothing d_1$	$\varnothing d_2$	$\varnothing d_3$	a	b	E	F	ap		
TP2PCM	040R-16-6-LN08	6	40	35	16	9	14	-	8.4	5.6	16	40	8.0	0.19
	040R-16-7-LN08	7	40	35	16	9	14	-	8.4	5.6	16	40	8.0	0.19
	050R-22-7-LN08	7	50	41	22	11	18	-	10.4	6.3	20	40	8.0	0.31
	050R-22-10-LN08	10	50	41	22	11	18	-	10.4	6.3	20	40	8.0	0.31
	063R-22-10-LN08	10	63	49	22	11	18	-	10.4	6.3	20	40	8.0	0.49
	063R-22-11-LN08	11	63	49	22	11	18	-	10.4	6.3	20	40	8.0	0.49

Available inserts

LNKT-MA LNKT-ML LNKT-MM



Designation	Cermet		Coated										Uncoated			page			
	CN2000	CN30	NCM325	NC5330	NCM535	NCM545	PC2505	PC2510	PC3600	PC3700	PC6510	PC9530	PC9540	PC5300	PC5400		ST30A	G10	H01
LNKT	080404PNR-MA																		E10
	080408PNR-MA																		
	080404PNR-ML																		
	080408PNR-ML																		
	080404PNR-MM																		
	080408PNR-MM																		

Available arbors

Designation	NC arbors	
TP2PCM	040R-16-6-LN08	BT□□-FMC16-□□
	040R-16-7-LN08	
	050R-22-7-LN08	
	050R-22-10-LN08	BT□□-FMC22-□□
	063R-22-10-LN08	
	063R-22-11-LN08	

Parts

Specification		
$\varnothing 40 \sim \varnothing 63$	FTKA02565S	TW07S

Available inserts E10 Available arbors and bolt E400~E402

TP2PC(M)-LN14 new

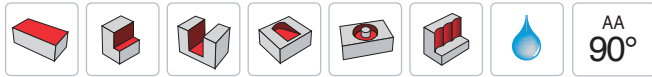
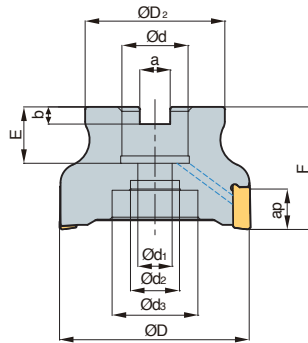

• AR: -6°
• RR: -22° ~ -12°

(mm)

Designation	⊘	ØD	ØD ₂	Ød	Ød ₁	Ød ₂	Ød ₃	a	b	E	F	ap	kg	
TP2PCM	040R-16-4-LN14	4	40	35	16	9	14	—	8,4	5,6	19	40	12,7	0,19
	040R-16-5-LN14	5	40	35	16	9	14	—	8,4	5,6	19	40	12,7	0,19
	050R-22-5-LN14	5	50	42	22	11	18	—	10,4	6,3	20	40	12,7	0,29
	050R-22-6-LN14	6	50	42	22	11	18	—	10,4	6,3	20	40	12,7	0,29
	063R-22-6-LN14	6	63	49	22	11	18	—	10,4	6,3	20	40	12,7	0,49
	063R-22-8-LN14	8	63	49	22	11	18	—	10,4	6,3	20	40	12,7	0,49
	080R-27-7-LN14	7	80	57	27	14	20	35	12,4	7	23	50	12,7	0,94
	080R-27-10-LN14	10	80	57	27	14	20	35	12,4	7	23	50	12,7	0,94
	100R-32-8-LN14	8	100	70	32	18	28	45	14,4	8	28	63	12,7	1,73
	100R-32-13-LN14	13	100	70	32	18	28	45	14,4	8	28	63	12,7	1,73
	125R-40-9-LN14	9	125	90	40	22	32	54	16,4	9	30	63	12,7	2,98
	125R-40-17-LN14	17	125	90	40	22	32	54	16,4	9	30	63	12,7	3,04
TP2PC	080R-25.4-7-LN14	7	80	57	25,4	14	25	38	9,5	6	25	50	12,7	0,95
	080R-25.4-10-LN14	10	80	57	25,4	14	25	38	9,5	6	25	50	12,7	0,96
	100R-31.75-8-LN14	8	100	70	31,75	18	28	45	12,7	8	32	63	12,7	1,76
	100R-31.75-13-LN14	13	100	70	31,75	18	28	45	12,7	8	32	63	12,7	1,81
	125R-38.1-9-LN14	9	125	90	38,1	22	32	54	15,9	10	35	63	12,7	2,99
	125R-38.1-17-LN14	17	125	90	38,1	22	32	54	15,9	10	35	63	12,7	3,07

Available inserts



Designation	Cermet		Coated										Uncoated			page			
	CN2000	CN30	NCM325	NC5330	NCM535	NCM545	PC2505	PC2510	PC3600	PC3700	PC6510	PC9530	PC9540	PC5300	PC5400		ST30A	G10	H01
LNKT 140608PNR-MA																			E10
140608PNR-ML																			
140608PNR-MM																			

Available arbors

Designation	NC arbors	Designation	NC arbors	
TP2PCM	BT□□-FMC16-□□	100R-32-13-LN14	BT□□-FMC32-□□	
		125R-40-9-LN14	BT□□-FMC40-□□	
		125R-40-17-LN14		
		BT□□-FMC22-□□	080R-25.4-7-LN14	BT□□-FMA25.4-□□
	080R-25.4-10-LN14			
	BT□□-FMC27-□□		100R-31.75-8-LN14	BT□□-FMA31.75-□□
			100R-31.75-13-LN14	
	BT□□-FMC32-□□	BT□□-FMA38.1-□□	125R-38.1-9-LN14	
125R-38.1-17-LN14				

Parts

Specification	Screw	Wrench
Ø40 ~ Ø125	FTKA03510	TW15S

Available inserts E10 Available arbors and bolt E400-E402



TP2PC(M)-LN17 new

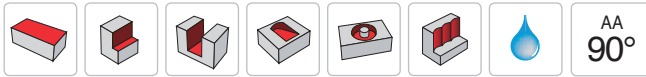
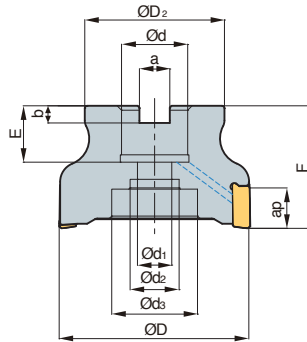

• AR: -6°
• RR: -21° ~ -15°

(mm)

Designation	ØD	ØD2	Ød	Ød1	Ød2	Ød3	a	b	E	F	ap	$\frac{ap}{D}$	
TP2PCM 040R-16-3-LN17	3	40	35	16	9	14	-	8.4	5.6	16	40	16.5	0.17
040R-16-4-LN17	4	40	35	16	9	14	-	8.4	5.6	16	40	16.5	0.17
050R-22-4-LN17	4	50	41	22	11	18	-	10.4	6.3	20	40	16.5	0.27
050R-22-5-LN17	5	50	41	22	11	18	-	10.4	6.3	20	40	16.5	0.26
063R-22-6-LN17	6	63	49	22	11	18	-	10.4	6.3	20	40	16.5	0.46
063R-22-7-LN17	7	63	49	22	11	18	-	10.4	6.3	20	40	16.5	0.47
080R-27-7-LN17	7	80	57	27	14	20	35	12.4	7	23	50	16.5	0.89
080R-27-8-LN17	8	80	57	27	14	20	35	12.4	7	23	50	16.5	0.91
100R-32-8-LN17	8	100	67	32	18	28	45	14.4	8	25	63	16.5	1.68
100R-32-9-LN17	9	100	67	32	18	28	45	14.4	8	25	63	16.5	1.75
125R-40-10-LN17	10	125	90	40	22	32	52	16.4	10	30	63	16.5	2.88
125R-40-11-LN17	11	125	90	40	22	32	52	16.4	10	30	63	16.5	2.88
TP2PC 080R-25.4-7-LN17	7	80	57	25.4	14	20	35	9.5	6	25	50	16.5	0.92
080R-25.4-8-LN17	8	80	57	25.4	14	20	35	9.5	6	25	50	16.5	0.93
100R-31.75-8-LN17	8	100	67	31.75	18	28	45	12.7	8	32	63	16.5	1.73
100R-31.75-9-LN17	9	100	67	31.75	18	28	45	12.7	8	32	63	16.5	1.73
125R-38.1-10-LN17	10	125	90	38.1	22	32	52	15.9	9	35	63	16.5	3.06
125R-38.1-11-LN17	11	125	90	38.1	22	32	52	15.9	9	35	63	16.5	2.91

Available inserts



Designation	Cement								page	Designation	Cement								page			
	CN2000	CN30	NCM325	NC5330	NCM535	NCM545	PC2505	PC2510			PC3600	PC3700	PC6510	PC9530	PC9540	PC5300	PC5400	ST30A		H01		
LNKT 170704PNR-MA 170708PNR-MA 170712PNR-MA 170716PNR-MA 170720PNR-MA 170704PNR-ML 170708PNR-ML 170712PNR-ML										E10	LNKT 170716PNR-ML 170720PNR-ML 170704PNR-MM 170708PNR-MM 170712PNR-MM 170716PNR-MM 170720PNR-MM											E10

Available arbors

Designation	NC arbors	Designation	NC arbors
TP2PCM 040R-16-3-LN17	BT□□-FMC16-□□	TP2PCM 100R-32-9-LN17	BT□□-FMC32-□□
040R-16-4-LN17		125R-40-10-LN17	BT□□-FMC40-□□
050R-22-4-LN17		125R-40-11-LN17	
050R-22-5-LN17	BT□□-FMC22-□□	TP2PC 080R-25.4-7-LN17	BT□□-FMA25.4-□□
063R-22-6-LN17		080R-25.4-8-LN17	BT□□-FMA31.75-□□
063R-22-7-LN17		100R-31.75-8-LN17	
080R-27-7-LN17	100R-31.75-9-LN17		
080R-27-8-LN17	BT□□-FMC27-□□	125R-38.1-10-LN17	BT□□-FMA38.1-□□
100R-32-8-LN17		125R-38.1-11-LN17	

Parts

Specification	Screw	Wrench
Ø40~Ø125	FTKA0412B	TW15S

Available inserts E10 Available arbors and bolt E400~E402

TP2PS-LN08 new

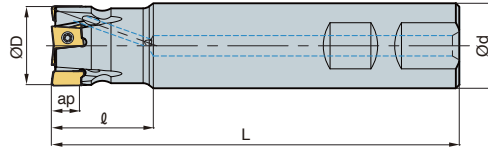

• AR: -6°
• RR: -35° ~ -26°

(mm)

Designation		ØD	Ød	ℓ	L	ap	
TP2PS	020R-2W20-120-LN08	2	20	20	30	120	0.25
	020R-3W20-120-LN08	3	20	20	30	120	0.25
	025R-3W25-120-LN08	3	25	25	30	120	0.39
	025R-4W25-120-LN08	4	25	25	30	120	0.39

Available inserts

LNKT-MA LNKT-ML LNKT-MM



Designation	Cermet		Coated										Uncoated			page			
	CN2000	CN30	NCM325	NC5330	NCM535	NCM545	PC2505	PC2510	PC3600	PC3700	PC6510	PC9530	PC9540	PC5300	PC5400		ST30A	G10	H01
LNKT	080404PNR-MA																		E10
	080408PNR-MA																		
	080404PNR-ML																		
	080408PNR-ML																		
	080404PNR-MM																		
	080408PNR-MM																		

Parts

Specification		
Ø16-Ø25	FTKA02565S	TW07S

Available inserts E10



TP2PS-LN14 new

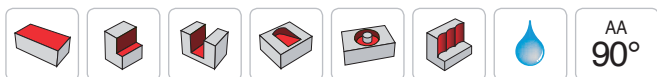
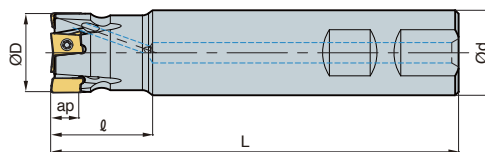

• AR: -6°
• RR: -21° ~ -18°

(mm)

Designation		ØD	Ød	ℓ	L	ap	
TP2PS	025R-2W25-130-LN14	2	25	25	40	130	0.41
	032R-3W32-130-LN14	3	32	32	40	130	0.69
	040R-3W32-130-LN14	3	40	32	40	130	0.75
	040R-4W32-130-LN14	4	40	32	40	130	0.76
	050R-4W32-130-LN14	4	50	32	40	130	0.85
	050R-5W32-130-LN14	5	50	32	40	130	0.84

Available inserts

LNKT-MA LNKT-ML LNKT-MM



Designation	Cermet		Coated										Uncoated			page			
	CN2000	CN30	NCM325	NC5330	NCM535	NCM545	PC2505	PC2510	PC3600	PC3700	PC6510	PC9530	PC9540	PC5300	PC5400		ST30A	G10	H01
LNKT	140608PNR-MA																		E10
	140608PNR-ML																		
	140608PNR-MM																		

Parts

Specification		
Ø25 ~ Ø50	FTKA03510	TW15S

Available inserts E10

TP2PS-LN17 new

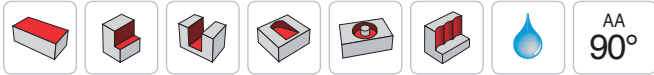
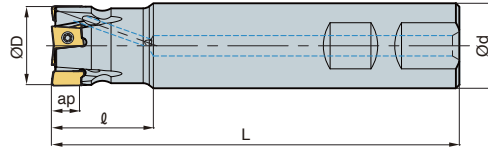

AA
90°
• AR: -6°
• RR: -26° ~ -18°

(mm)

Designation		ØD	Ød	l	L	ap	
TP2PS	032R-2W32-130-LN17	2	32	32	40	130	0.68
	032R-3W32-130-LN17	3	32	32	40	130	0.67
	040R-3W32-130-LN17	3	40	32	40	130	0.73
	040R-4W32-130-LN17	4	40	32	40	130	0.73
	050R-4W32-130-LN17	4	50	32	40	130	0.83
	050R-5W32-130-LN17	5	50	32	40	130	0.83

Available inserts



Designation	Cermet		Coated											Uncoated			page		
	CN2000	CN30	NCM325	NC5330	NCM535	NCM545	PC2505	PC2510	PC3600	PC3700	PC6510	PC9530	PC9540	PC5300	PC5400	ST30A		G10	H01
LNKT 170704PNR-MA																			E10
170708PNR-MA																			
170712PNR-MA																			
170716PNR-MA																			
170720PNR-MA																			
170704PNR-ML																			
170708PNR-ML											•			•	•				
170712PNR-ML																			
170716PNR-ML																			
170720PNR-ML																			
170704PNR-MM																			
170708PNR-MM														•	•				
170712PNR-MM																			
170716PNR-MM																			
170720PNR-MM																			

Parts

Specification		
Ø32-Ø50	FTKA0412B	TW15S

Available inserts E10



Longer tool life guaranteed thanks to the excellent cutting performance of our grades

Laser Mill

- Long tool life has been achieved due to the excellent cutting performance of the insert grade
- Optimum machining of molds has been achieved with the MQL available system
- Easy clamping with simple screw on system
- Various holder line up: steel shank, carbide shank, modular type
- High accuracy indexable endmills for mold finishing

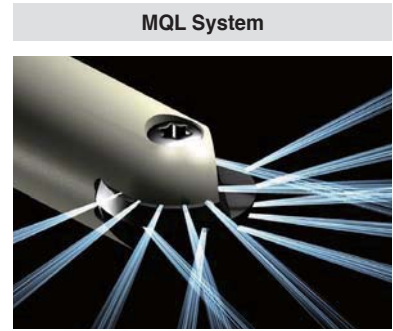

- MQL System**
- Environmental friendly system
 - Decreased coolant cost
 - Lubrication of cutting-edge
 - Improved chip control property
 - Increased tool life & improved surface quality

Clamping system

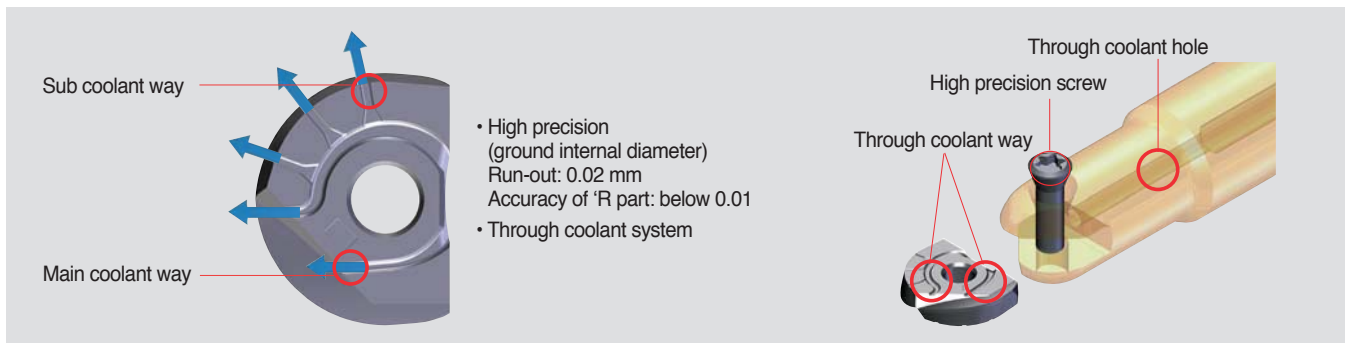

Features



- Six types of inserts are available with one holder
- Single screw for clamping of insert: Easy clamping system
- Various types of holders (Steel shank, Carbide shank, Modular type)
- MQL applicable- environmentally responsible with longer tool life & improved surface quality.

LBS, LR Order-made items

LBH-Ball	LRH-Corner radius	LFH-High feed	LCF-Chamfer	LBS-Ball type	LR-Corner R type
<ul style="list-style-type: none"> • Helical cutting-edge • Suitable for harder material with high feed 	<ul style="list-style-type: none"> • Helical cutting-edge • Variety of nose-R 	<ul style="list-style-type: none"> • Helical cutting-edge • Suitable for high feed 	<ul style="list-style-type: none"> • Straight cutting-edge • Center drilling and chamfering 	<ul style="list-style-type: none"> • Straight cutting-edge • Suitable for precise 	<ul style="list-style-type: none"> • Straight cutting-edge • Variety of nose-R

Features of Laser Mill grades

PC2005	<ul style="list-style-type: none"> • Extremely high hardness grade • The harmony between improved blade design and strong chip breaker • Optimized for machining heat-treated steel and high hardness steel
PC2010	<ul style="list-style-type: none"> • High wear resistance and excellent toughness • The harmony between excellent thermal shock resistance and strong cutting-edges. • Optimized for machining tool steel and pre-hardened steel
PC2015	<ul style="list-style-type: none"> • High welding resistance and excellent toughness • The harmony between tough grade and excellent cutting-edge design • Optimized for machining carbon steel

Application guideline per workpiece

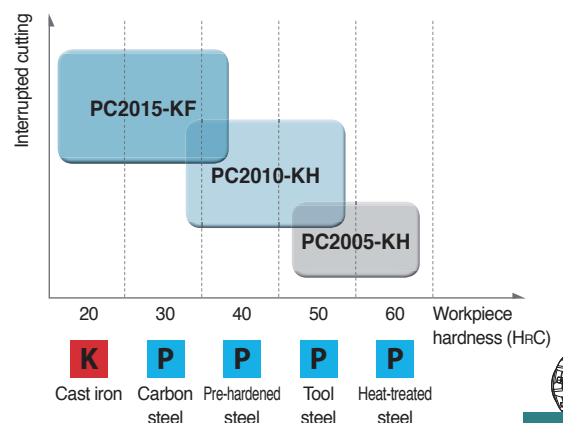

Features of KF/KH chip breaker

- KF: Exclusive chip breaker for stable machining of carbon steel with its characteristics of high wear resistance at center part and improved blade design
- KH: Stronger insert with the combination of rake angle and relief angle that are ideal for machining high hardness workpiece

Type	Shape comparison			
Standard (For general cutting)				
	<ul style="list-style-type: none"> • Proper to general cutting • Insert shape for uniform performance 			
KH (For high hardness steel)				
	<ul style="list-style-type: none"> • Center shaper proper for machining high hardness workpiece and uniformed tool life at center part • Improved cutting-edge design by higher rake angle (α_i°) • Lower relief angle (β°) increases strength of cutting-edges than universal inserts. 			
KF (For carbon steel)				
	<ul style="list-style-type: none"> • Smaller chisel improves wear resistance at center for machining carbon steel. • Improved cutting-edge design by higher rake angle (α_i°) • Longer tool life and better cutting performance with the use of excellent blade design 			

Recommended cutting condition

	Workpiece			Grades	Chip breaker	Recommended cutting conditions				
	ISO	Material	HB (HrC)			vc (m/min)	fz (mm/t)	ap (mm)	ae (mm)	
K	Gray cast iron	GC250	180 (8)	PC2015 PC2010 PC2005	KF	130~210	0.2~0.5	0.07D	0.07D	
	Ductile cast iron	GCD600	250 (24)							
P	Carbon steel	S20C~S50C	150	PC2010 PC2015 PC210F	KH	100~160	0.1~0.3	0.5D	0.5D	
	Alloy steel	SCM21~SCM5H	270 (28)							
	Pre-hardened steel		KP4M	300 (32)	PC2005 PC2010	KH	80~130	0.1~0.2	0.3D	0.3D
			NIMAX	370 (40)						
			CENA1	370 (40)						
			NAK80	400 (43)						
	High speed tool steel	SKH51~SKH59	550 (55)							
Alloy tool steel		STD61 (Hot forging)	630 (60)			70~120	0.1~0.2	0.3D	0.3D	
		STD11 (Cold forging)								

Overhang	vc (m/min)	fz (mm/t)
Under 3D	100%	100%
3D~5D	70%	70%
5D~8D	60%	60%
8D~10D	50%	50%



➤ Cutting condition formula for milling

Practical cutting speed	RPM
-------------------------	-----

$$v_{ce} = \frac{\pi \times D_e \times n}{1000} \text{ (m/min)}$$

$$n = \frac{v_{ce} \times 1000}{\pi \times D_e} \text{ (min}^{-1}\text{)}$$

Feed per tooth	Feed per minute
----------------	-----------------

$$fz = \frac{vf}{z \times n} \text{ (mm/t)}$$

$$vf = fz \times z \times n \text{ (mm/min)}$$

Chip removal amount	Power requirement
---------------------	-------------------

$$Q = \frac{ap \times ae \times vf}{1000} \text{ (cm}^3\text{/min)}$$

$$P_{kw} = \frac{Q \times kc}{60 \times 102 \times \eta} \text{ (kW)}$$

$$P_{hp} = \frac{P_c}{0.75} \text{ (hp)}$$

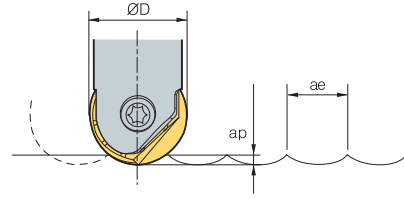

vc = Cutting speed (m/min)	Pkw = Power requirement (kW)
vce = Practical cutting speed (m/min)	Php = Horsepower requirement (hp)
n = Revolution per minute (min ⁻¹)	Q = Chip removal amount (cm ³ /min)
D = Cutting diameter (mm)	ap = Depth of cut (mm)
De = Actual diameter (mm)	ae = Width of cut (mm)
vf = Feed per minute (mm/min)	kc = Specific cutting resistance (kg/mm ²)
fz = Feed per tooth (mm/t)	η = Mechanical efficiency (%)
z = Number of tooth	

➤ Practical cutting speed calculation formulas

1. Formula of actual diameter

• Formula
: Actual diameter

$$D_e = 2 \sqrt{ap(D - ap)}$$

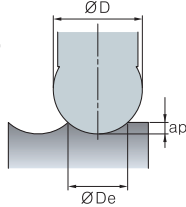

2. θ°Using: Calculating cutting speed at P point
(Cutting speed according to depth of cut when ramping)

• Formula
: Practical cutting speed

$$v_{ce} = \frac{\pi D \sin \theta \times n}{1000} \text{ (m/min)}$$

$$\theta = \cos^{-1} \left(\frac{D - 2ap}{D} \right) + (90 - \alpha^\circ)$$

3. In case of using ap: Calculating cutting speed at Q point

• Formula
: Practical cutting speed

$$v_{ce} = \frac{2\pi n \sqrt{ap(D - ap)}}{1000}$$

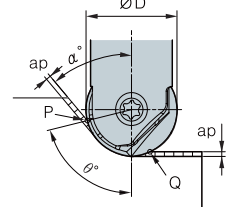

➤ Practical cutting speed calculation formulas

		h (surface roughness) (μm)									
ae (mm)	R (mm)	0.1	0.2	0.3	0.4	0.5	0.6	0.7	0.8	0.9	1.0
5	5	0.3	1.0	2.3	4.0	6.3	9.0	12.3	16.0	20.3	25.0
6	6	0.2	0.8	1.9	3.3	5.2	7.5	10.2	13.3	16.9	20.8
8	8	0.2	0.6	1.4	2.5	3.9	5.6	7.7	10.0	12.7	15.6
10	10	0.1	0.5	1.1	2.0	3.1	4.5	6.1	8.0	10.1	12.5
12.5	12.5	0.1	0.4	0.9	1.6	2.5	3.6	4.9	6.4	8.1	10.0
15	15	0.1	0.3	0.8	1.3	2.1	3.0	4.1	5.3	6.8	8.3
16	16	0.1	0.3	0.7	1.3	2.0	2.8	3.8	5.0	6.3	7.8

$$\text{Formula of surface roughness: } h \text{ (surface finish)} = \frac{(ae)^2}{8R} \times 1000 \text{ (}\mu\text{m)}$$

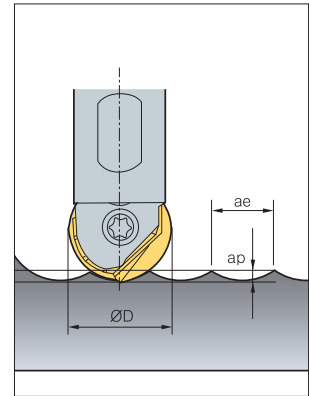

➤ Actual diameter data

ap	ØD	Ø08	Ø10	Ø12	Ø16	Ø20	Ø25	Ø30	Ø32
0.1		1.8	2.0	2.2	2.5	2.8	3.2	3.5	3.6
0.2		2.5	2.8	3.1	3.6	4.0	4.5	4.9	5.0
0.3		3.0	3.4	3.7	4.3	4.9	5.4	6.0	6.2
0.5		3.9	4.4	4.8	5.6	6.2	7.0	7.7	7.9
1.0		5.3	6.0	6.6	7.7	8.7	9.8	10.8	11.1
1.5		6.2	7.1	7.9	9.3	10.5	11.9	13.1	13.5
2.0		6.9	8.0	8.9	10.6	12.0	13.6	15.0	15.5
2.5		7.4	8.7	9.7	11.6	13.2	15.0	16.6	17.2
3.0		7.7	9.2	10.4	12.5	14.3	16.2	18.0	18.7
3.5		7.9	9.5	10.9	13.2	15.2	17.3	19.3	20.0
4.0		8.0	9.8	11.3	13.9	16.0	18.3	20.4	21.2
5.0				11.8	14.8	17.3	20.0	22.4	23.2
6.0				12.0	15.5	18.3	21.4	24.0	25.0
7.0					15.9	19.1	22.4	25.4	26.5
8.0					16.0	19.6	23.3	26.5	27.7
10.0						20.0	24.5	28.3	29.7

Performance evaluation

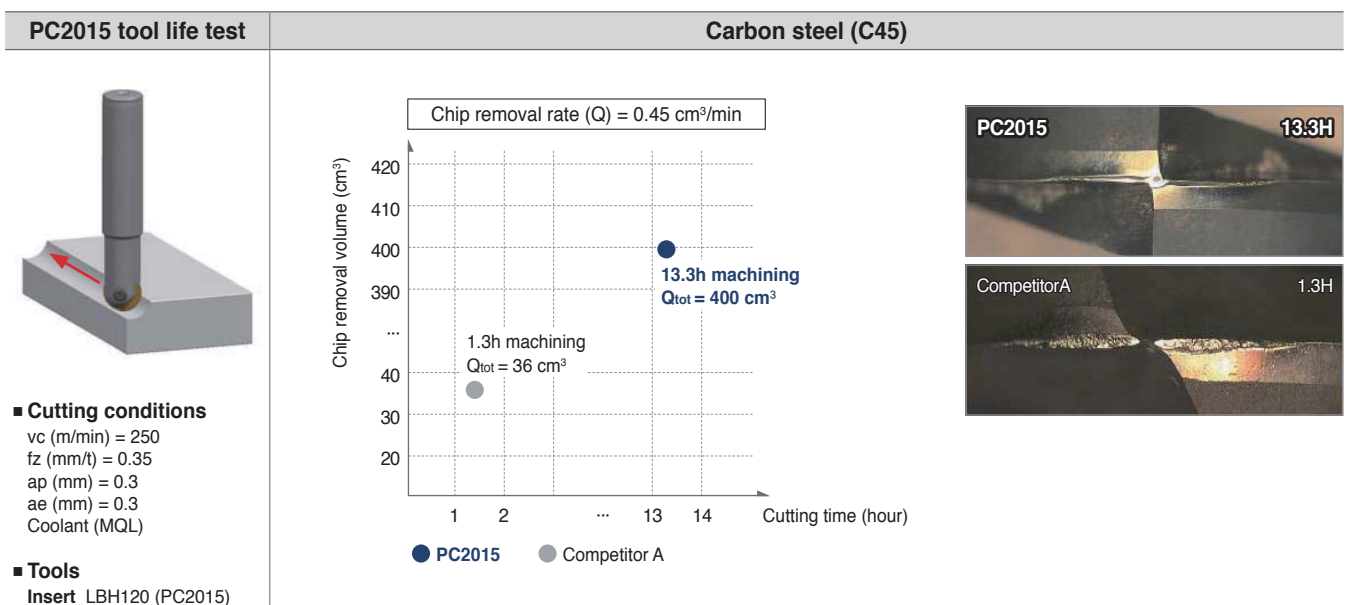
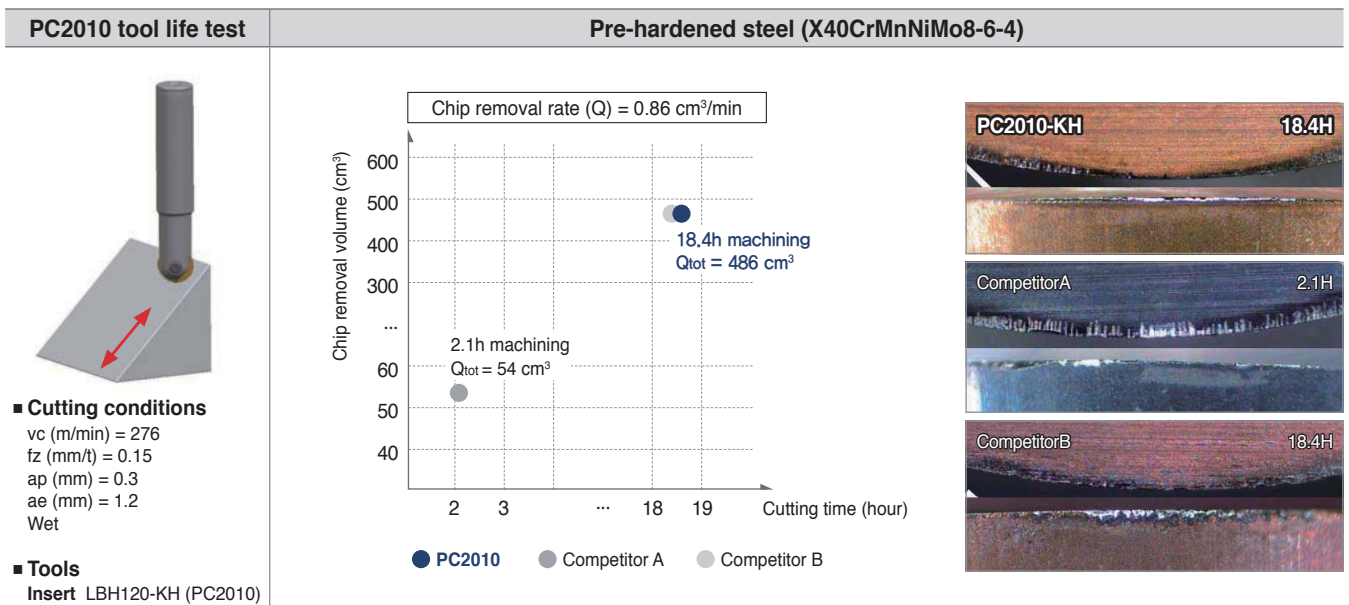
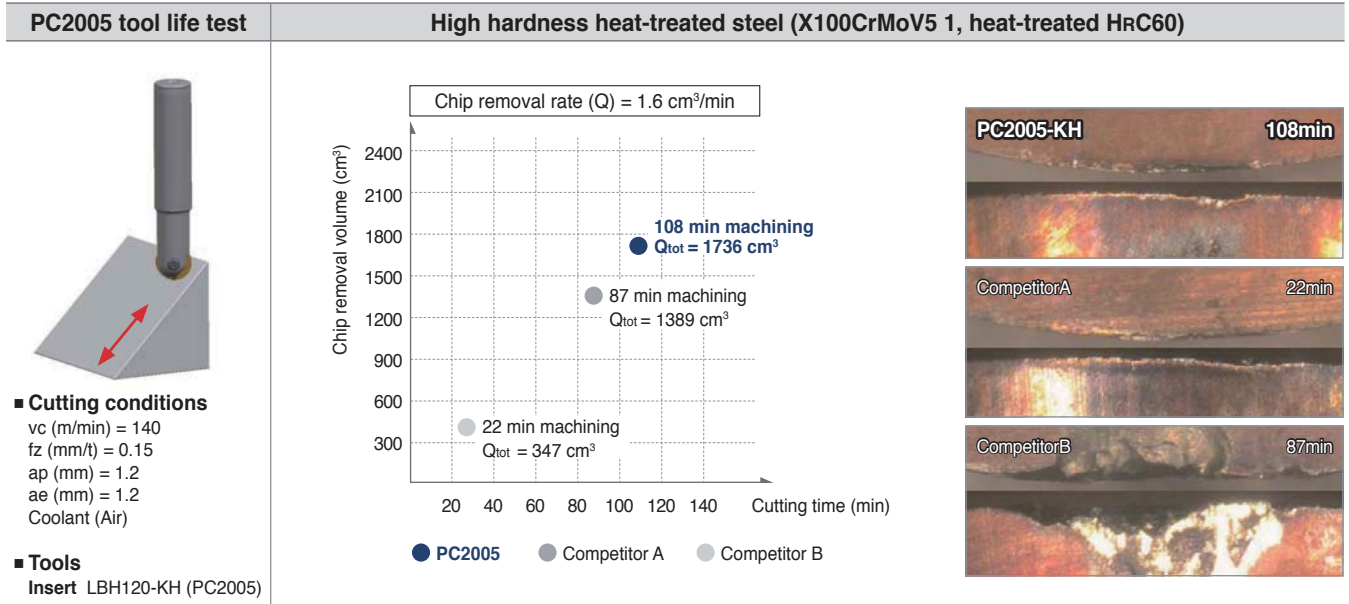

Available inserts

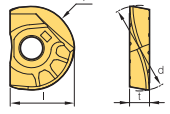
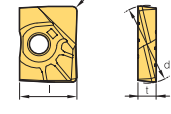
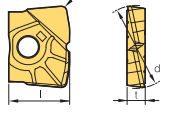
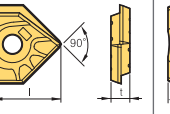
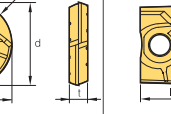
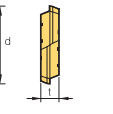
	LBH (Ball type)	LRH (Corner radius type)	LFH (High feed type)	LCF (Chamfer type)	LBS (Ball type)	LR (Corner radius type)
Holders	 R accuracy ± 0.005	 Corner R ± 0.015			 R accuracy ± 0.005	 Corner R ± 0.015
LBE080	LBH080 LBH090 LBH080-KF LBH090-KF LBH080-KH LBH090-KH				LBS080 LBS090	
LBE100 LRE100	LBH100 LBH110 LBH100-KF LBH110-KF LBH100-KH LBH110-KH	LRH100-R05 LRH100-R10 LRH110-R05 LRH100-R20	LFH100		LBS100 LBS110	LR100-R05 LR100-R20 LR100-R10 LR110-R05
LBE120 LRE120	LBH120 LBH130 LBH120-KF LBH130-KF LBH120-KH LBH130-KH	LRH120-R05 LRH120-R10 LRH130-R05 LRH120-R20	LFH120		LBS120 LBS130	LR120-R05 LR120-R20 LR120-R10 LR130-R05
LBE160 LRE160	LBH160 LBH170 LBH160-KF LBH170-KF LBH160-KH LBH170-KH	LRH160-R05 LRH160-R10 LRH170-R05 LRH160-R20 LRH160-R30	LFH160	LCF160-D90	LBS160 LBS170	LR160-R05 LR160-R30 LR160-R10 LR170-R05 LR160-R20
LBE200 LRE200	LBH200 LBH210 LBH200-KF LBH210-KF LBH200-KH LBH210-KH	LRH200-R05 LRH200-R10 LRH210-R05 LRH200-R20 LRH200-R30	LFH200	LCF200-D90	LBS200 LBS210	LR200-R05 LR200-R30 LR200-R10 LR210-R05 LR200-R20
LBE250 LRE250	LBH250 LBH260 LBH250-KF LBH260-KF LBH250-KH LBH260-KH	LRH250-R05 LRH250-R10 LRH260-R05 LRH250-R20 LRH250-R30	LFH250	LCF250-D90	LBS250 LBS260	LR250-R05 LR250-R30 LR250-R10 LR260-R05 LR250-R20
LBE300 LRE300	LBH300 LBH310 LBH300-KF LBH310-KF LBH300-KH LBH310-KH	LRH300-R10 LRH300-R20 LRH310-R05 LRH300-R30	LFH300		LBS300 LBS310	LR300-R10 LR300-R30 LR300-R20 LR310-R05
LBE320 LRE320	LBH320 LBH330 LBH320-KF LBH330-KF LBH320-KH LBH330-KH	LRH320-R10 LRH330-R10 LRH320-R20 LRH330-R20 LRH320-R30 LRH330-R30	LFH320		LBS320	LR320-R10 LR320-R30 LR320-R20

Available inserts **E08, E09**

* LBH for general cutting, LBH-KF for carbon steel, and LBH-KH for high hardened steel.

E Technical Information for GBE

Long tool life due to high hardness grade

GBE

- Indexable ball nose endmill for molds in medium & roughing applications
- Long tool life with high hardness grade
- Helical high accuracy cutting-edge
- Optimized mold machining process with our internal coolant system
- Able to adjust to medium processing in middle & big roughing mold process
- Wide variety of holders in normal & long style holders

Holder code system



Internal	External	
		<ul style="list-style-type: none"> • High accuracy machining & large depth of cut applications <ul style="list-style-type: none"> - Run-out: within 0.05 mm - R accuracy: within 0.05 mm • Various diameters (Ø16, Ø18, Ø20, Ø22, Ø25, Ø26, Ø28, Ø30, Ø32, Ø40, Ø50) • Minimal cutting resistance due to Helical cutting-edge • Anti-rotation of insert due to concave bottom & stable setting by flank support • Long tool life & better processing due to 2 cutting inserts • Better tool life with new grade
Flank support	Concave bottom	

				<ul style="list-style-type: none"> • Various diameters (Ø16, Ø18, Ø20, Ø22, Ø25, Ø26, Ø28, Ø30, Ø32, Ø40, Ø50) • Improved chip treatment with internal coolant (cutting-edge portion) • Long tool life & better processing • Easy insert setting with projection part to prevent vibration during processing
Multi-edge type	Single-edge type	Modular type	Projection	



How to set insert

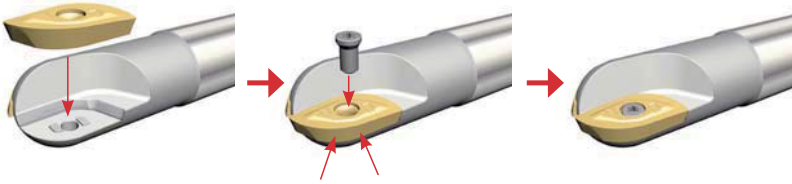

1. Set the insert onto the holder projection seat
2. Push the insert into the pocket as shown by red arrows and screw down with wrench

Performance evaluation

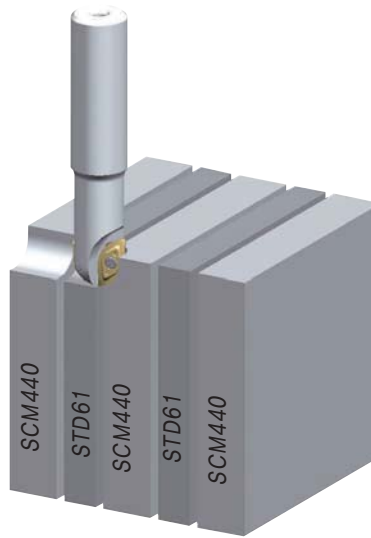
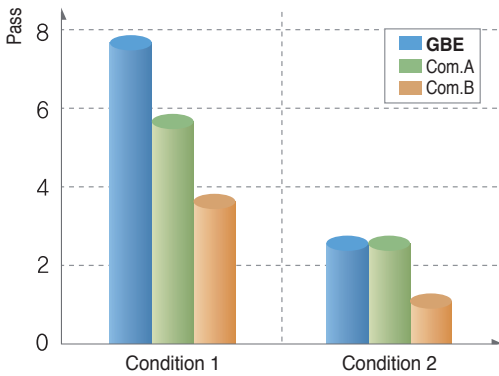

Cutting condition

Class.	Cutting speed (vc)	Feed (fz)	Depth of cut (ap)	Depth of cut (ae)	Workpiece	Etc.
Condition 1	150 m/min	0.15 mm/t	5 mm	8 mm	STD61 (HRC50) + SCM440 (HRC20)	Dry
Condition 2	100 m/min	0.1 mm/t	8 mm	8 mm		

Inserts/parts

Type	Insert			Parts			
	Internal I/S	External I/S	External main I/S	Screw		Wrench	
Dia.	Internal I/S	External I/S	External main I/S	Int./Ext. type	Ext. main type	Int./Ext. type	Ext. main type
Ø16	ZPET080M-MM	ZPET080S-MM	-	FTKA02555S	-	TW08S	-
Ø18	ZPET090M-MM	ZPET090S-MM	-	FTKA0307	-	TW09S	-
Ø20	ZPET100M-MM	ZPET100S-MM	SPMT060304	FTKA0307	ETNA02506	TW09S	TW07P
Ø22	ZPET110M-MM	ZPET110S-MM	SPMT060304	FTKA0408	ETNA02506	TW15S	TW07P
Ø25	ZPET125M-MM	ZPET125S-MM	SPMT060304	FTKA0409	ETNA02506	TW15S	TW07P
Ø26	ZPET130M-MM	ZPET130S-MM	SDMT090308-MM	FTKA0409	ETNA0408	TW15S	TW15S
Ø28	ZPET140M-MM	ZPET140S-MM	SDMT090308-MM	FTGA0511-P	ETNA0408	TW20	TW15S
Ø30	ZPET150M-MM	ZPET150S-MM	SDMT090308-MM	FTGA0511-P	ETNA0408	TW20-100	TW15S
Ø32	ZPET160M-MM	ZPET160S-MM	SDMT090308-MM	FTGA0511-P	ETNA0408	TW20-100	TW15S
Ø40	ZPET200M-MM	ZPET200S-MM	SPMT120408-MM	FTGA0614	ETNA0511	TW20-100	TW20S
Ø50	ZPET250M-MM	ZPET250S-MM	SPMT120408-MM	FTGA0818	ETNA0511	TW25S	TW20S

Recommended cutting condition

Workpiece	Machining type	Hardness (HRC)	vc (m/min)	fz (mm/t)	ap (mm)	ae (mm)
Carbon, Alloy steel	Flank	Under 25	160~250	0.1~0.5	0.3~0.5D	0.2~0.3D
	Groove		120~200	0.1~0.5	0.3~0.5D	-
	Deep flank		160~250	0.1~0.5	1.0~1.5D	0.1~0.2D
Carbon, Alloy steel	Flank	Under 45	120~200	0.1~0.5	0.3~0.5D	0.2~0.3D
	Groove		120~160	0.1~0.5	0.3~0.5D	-
	Deep flank		120~200	0.1~0.5	1.0~1.5D	0.1~0.2D
Mold Alloy steel	Flank	30~40	120~200	0.1~0.3	0.3~0.5D	0.2~0.3D
	Groove		120~160	0.1~0.3	0.3~0.5D	-
	Deep flank		120~200	0.1~0.3	1.0~1.5D	0.1~0.2D
Cast iron (GC, GCD)	Flank	20~30	150~300	0.2~0.7	0.3~0.5D	0.2~0.3D
	Groove		150~300	0.2~0.7	0.3~0.5D	-
	Deep flank		150~300	0.2~0.7	1.0~1.5D	0.1~0.2D
Heat-treated steel	Flank	50~60	40~100	0.1~0.3	0.3~0.5D	0.2~0.3D
	Groove		40~100	0.1~0.3	0.3~0.5D	-
	Deep flank		40~100	0.1~0.3	1.0~1.5D	0.1~0.2D

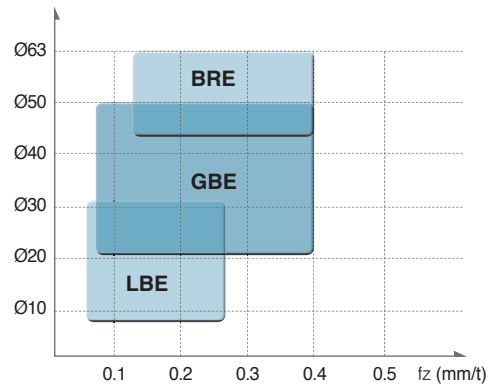

Line-up for indexable ball endmill



Type	Application				
	Quality	Machining Efficiency	Machining Dia. Equivalence	Economical	Flank Machining with LongEdge
Laser Mill	●	○	◐	○	○
GBE	◐	●	◐	◐	●
BRE	○	●	●	●	●

●: Very Good ◐: Good ○: Normal

Test result for wear resistance

Cutting condition		Wear resistance photos				
 <p>Time engaged : 4 Pass</p>	<ul style="list-style-type: none"> Workpiece KP4M (HRC33), Dry Condition vc = 280 m/min fz = 0.25 mm/t ap = 5~10 mm ae = 5~10 mm vf = 1,486 mm/min n = 2,971 rpm Tool Holder: GBE300-S32 Insert: ZPET150M-MM (PC3500) ZPET150S-MM (PC3500) 		GBE			
			Top	Internal	Com.A	Com.B
				External		
			Flank	Internal		
External						
 <p>Time engaged : 4 Pass</p>	<ul style="list-style-type: none"> Workpiece STD11 (HRC20), Dry Condition vc = 250 m/min fz = 0.2 mm/t ap = 5 mm ae = 5 mm vf = 1,062 mm/min n = 2,653 rpm Tool Holder: GBE300-S32 Insert: ZPET150M-MM (PC3500) ZPET150S-MM (PC3500) 		GBE			
			Top	Internal	Com.A	Com.B
				External		
			Flank	Internal		
External						

Better tool life with its anti-breakage special surface treatment

BRE

- Cutting performance: Good chip control & Superior cutting performance with optimal cutting-edge line
- High rigidity body: Better tool life and special surface treatment to strengthen the holder
 - Easy to set and good durability with TCRX screw
 - Good chip control with our 3D flute design & improved external quality
- Insert: Grade available for high speed & feed applications due to its high wear and breakage resistance providing a stable cutting performance with high cutting-edge toughness and a chip breaker featuring a high rake angle

Multi-edge holder ISO View



- Good chip flow
- Good heat emission



- Wider insert ensures cutting-edge strength
- Better setting force by recess



➤ BRE machining type for roughing & Recommended cutting condition

Machining type 1

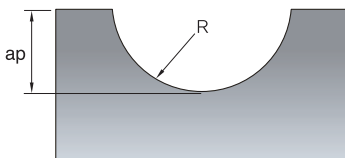

$ap = 0.3D-0.5D$

Machining type 2

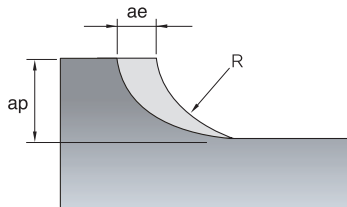

$ae = 0.2D-0.3D$ $ap = 0.3D-0.5D$

Machining type 3

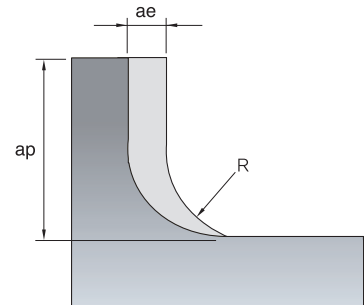

$ae = 0.1D-0.5D$ $ap = 1.2D-1.5D$

Workpiece	Machining type	Cutting speed (m/min)	Feed (mm/t)	Grades
Carbon/alloy steel	1	120~220	0.1~0.4	NCM325
	2	120~220	0.2~0.4	NCM325
	3	100~180	0.1~0.3	NCM325
Alloy steel	1	100~200	0.1~0.4	NCM325
	2	100~200	0.2~0.4	NCM325
	3	80~160	0.1~0.3	NCM325
Tool steel	1	80~150	0.1~0.3	NCM325
	2	80~150	0.15~0.35	NCM325
	3	60~120	0.1~0.3	NCM325
High hardness material (HRC35~45)	1	60~120	0.1~0.3	NCM325
	2	60~120	0.1~0.3	NCM325
	3	50~80	0.1~0.2	NCM325
Cast iron	1	100~180	0.2~0.5	NCM325
	2	100~180	0.2~0.5	NCM325
	3	80~160	0.15~0.4	NCM325

LBE 08/10/12/16/20/25/30/32

Carbide Shank (Ball type)

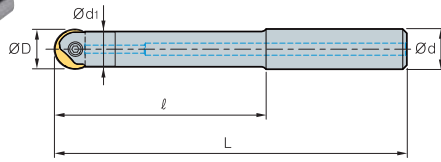

Fig. 1

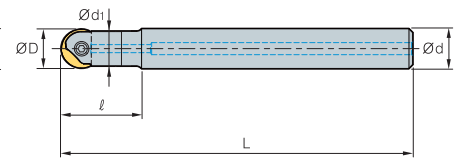

Fig. 2



(mm)

Designation	Dimensions					Parts		Available inserts (Ø)	Fig.
	ØD	Ød	Ød1	ℓ	L	Clamp screw	Wrench		
LBE 080080S-S08C	8, 9	8	7.5	80	136	ETND02506F	TWP07S	8, 9	1
080100S-S08C	8, 9	8	7.5	100	156				
080020S-S08C-130	8, 9	8	7.5	20	130				
080020S-S08C-150	8, 9	8	7.5	20	150	ETND0307F	TWP08S	10, 11	1
100080S-S10C	10, 11	10	9.5	80	136				
100120S-S10C	10, 11	10	9.5	120	176	ETND0307F	TWP08S	10, 11	2
100023S-S10C-130	10, 11	10	9.5	23	130				
100023S-S10C-170	10, 11	10	9.5	23	170				
120100S-S12C	12, 13	12	11.5	100	156	ETND03509	TWP10S	12, 13	1
120150S-S12C	12, 13	12	11.5	150	206				
120025S-S12C-150	12, 13	12	11.5	25	150	ETND03509	TWP10S	12, 13	2
120025S-S12C-200	12, 13	12	11.5	25	200				
160100S-S16C	16, 17	16	15.5	100	160				
160150S-S16C	16, 17	16	15.5	150	210	ETND0413	TWP15S	16, 17	1
160030S-S16C-160	16, 17	16	15.5	30	160				
160030S-S16C-210	16, 17	16	15.5	30	210				
200120S-S20C	20, 21	20	19.5	120	190	ETKD0516	TWP20	20, 21	1
200170S-S20C	20, 21	20	19.5	170	240				
200035S-S20C-190	20, 21	20	19.5	35	190	ETKD0516	TWP20	20, 21	2
200035S-S20C-240	20, 21	20	19.5	35	240				
250140S-S25C	25, 26	25	24.5	140	220				
250170S-S25C	25, 26	25	24.5	170	250	ETKD0620	TWP25	25, 26	1
250040S-S25C-220	25, 26	25	24.5	40	220				
250040S-S25C-250	25, 26	25	24.5	40	250				
300140S-S32C	30, 31	32	29.5	140	230	ETGD0825	TWP40	30, 31	1
300170S-S32C	30, 31	32	29.5	170	260				
300050S-S32C-230	30, 31	32	29.5	50	230	ETGD0825	TWP40	30, 31	2
300050S-S32C-260	30, 31	32	29.5	50	260				
320140S-S32C	32	32	31.5	140	230				
320170S-S32C	32	32	31.5	170	260	ETGD0825	TWP40	32, 33	1
320050S-S32C-230	32	32	31.5	50	230				
320050S-S32C-260	32	32	31.5	50	260				

Available inserts E08, E09



LBE 08/10/12/16/20/25/30/32

Steel Shank (Ball type)

Taper type

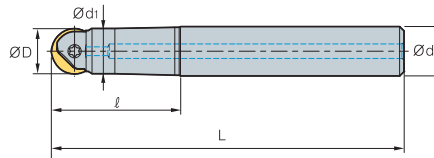

Designation	Dimensions					Parts		Available inserts (Ø)
	ØD	Ød	Ød ₁	ℓ	L	Clamp screw	Wrench	
LBE 080035T-S12	8, 9	12	7.5	35	91	ETND02506F	TWP07S	8, 9
080055T-S12	8, 9	12	7.5	55	111			
080075T-S12	8, 9	12	7.5	75	131			
100035T-S12	10, 11	12	9.5	35	91	ETND0307F	TWP08S	10, 11
100055T-S12	10, 11	12	9.5	55	111			
100075T-S12	10, 11	12	9.5	75	131			
120055T-S12	12, 13	12	10.4	55	111	ETND03509	TWP10S	12, 13
120085T-S16	12, 13	16	11.5	85	145			
160065T-S16	16, 17	16	14	65	125			
160100T-S20	16, 17	20	15.5	100	170	ETND0413	TWP15S	16, 17
200075T-S20	20, 21	20	17.5	75	145			
200115T-S25	20, 21	25	19.5	115	195			
250090T-S25	25, 26	25	22	90	170	ETKD0620	TWP25	25, 26
250135T-S32	25, 26	32	24.5	135	225			
300105T-S32	30, 31	32	29.5	105	195			
300160T-S32	30, 31	32	29.5	160	250	ETGD0825	TWP40	30, 31
320105T-S32	32	32	29	105	195			
320160T-S32	32	32	29	160	250			

Available inserts E08, E09

LBE12/16/20/25/30/32

Steel Shank (Ball type)

Straight type

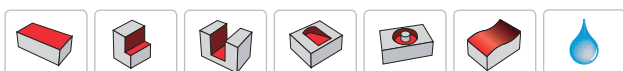
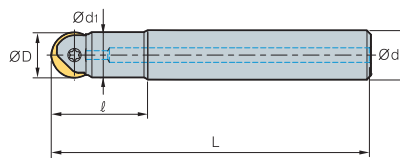

Designation	Dimensions					Parts		Available inserts (Ø)
	ØD	Ød	Ød ₁	ℓ	L	Clamp screw	Wrench	
LBE 120035S-S12	12, 13	12	11.5	35	91	ETND03509	TWP10S	12, 13
160035S-S16	16, 17	16	15.5	35	95	ETND0413	TWP15S	16, 17
200040S-S20	20, 21	20	19.5	40	110	ETKD0516	TWP20	20, 21
250045S-S25	25, 26	25	24.5	40	125	ETKD0620	TWP25	25, 26
300055S-S32	30, 31	32	29.5	55	145	ETGD0825	TWP40	30, 31
320055S-S32	32	32	31.5	55	145	ETGD0825	TWP40	32, 33

Available inserts E08, E09

LRE 10/12/16/20/25/30/32

Carbide Shank (Corner R type)

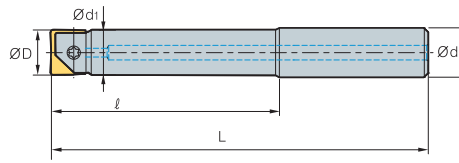

Fig. 1

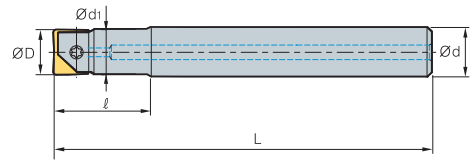

Fig. 2



(mm)

Designation	Dimensions					Parts		Available inserts (Ø)	Fig.
	ØD	Ød	Ød ₁	ℓ	L	Clamp screw	Wrench		
LRE 100080S-S10C	10, 11	10	9.5	80	136	ETND0307F	TWP08S	10, 11	1
	100120S-S10C	10, 11	10	9.5	120				
100023S-S10C-130	10, 11	10	9.5	23	130	ETND0307F	TWP08S	10, 11	2
100023S-S10C-170	10, 11	10	9.5	23	170				
120100S-S12C	12, 13	12	11.5	100	156	ETND03509	TWP10S	12, 13	1
120150S-S12C	12, 13	12	11.5	150	206				
120025S-S12C-150	12, 13	12	11.5	25	150	ETND03509	TWP10S	12, 13	2
120025S-S12C-200	12, 13	12	11.5	25	200				
160100S-S16C	16, 17	16	15.5	100	160	ETND0413	TWP15S	16, 17	1
160150S-S16C	16, 17	16	15.5	150	210				
160030S-S16C-160	16, 17	16	15.5	30	160	ETND0413	TWP15S	16, 17	2
160030S-S16C-210	16, 17	16	15.5	30	210				
200120S-S20C	20, 21	20	19.5	120	190	ETKD0516	TWP20	20, 21	1
200170S-S20C	20, 21	20	19.5	170	240				
200035S-S20C-190	20, 21	20	19.5	35	190	ETKD0516	TWP20	20, 21	2
200035S-S20C-240	20, 21	20	19.5	35	240				
250140S-S25C	25, 26	25	24.5	140	220	ETKD0620	TWP25	25, 26	1
250170S-S25C	25, 26	25	24.5	170	250				
250040S-S25C-220	25, 26	25	24.5	40	220	ETKD0620	TWP25	25, 26	2
250040S-S25C-250	25, 26	25	24.5	40	250				
300140S-S32C	30, 31	32	29.5	140	230	ETGD0825	TWP40	30, 31	1
300170S-S32C	30, 31	32	29.5	170	260				
300050S-S32C-230	30, 31	32	29.5	50	230	ETGD0825	TWP40	30, 31	2
300050S-S32C-260	30, 31	32	29.5	50	260				
320140S-S32C	32	32	31.5	140	230	ETGD0825	TWP40	32, 33	1
320170S-S32C	32	32	31.5	170	260				
320050S-S32C-230	32	32	31.5	50	230	ETGD0825	TWP40	32, 33	2
320050S-S32C-260	32	32	31.5	50	260				

Available inserts E08, E09



LRE 10/12

Steel Shank (Corner R type)

Taper type

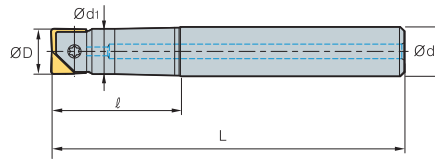

(mm)

Designation	Dimensions					Parts		Available inserts (Ø)	
	ØD	Ød	Ød ₁	ℓ	L	Clamp screw	Wrench		
LRE	100025T-S12	10, 11	12	9.5	25	111	ETND0307F	TWP08S	10,11
	100050T-S12	10, 11	12	9.5	50	150			
	120060T-S16	12, 13	16	11.5	60	160	ETND03509	TWP10S	

➔ Available inserts E08, E09

LRE 12/16/25/30/32

Steel Shank (Corner R type)

Straight type

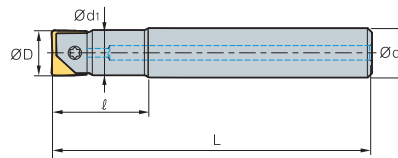

(mm)

Designation	Dimensions					Parts		Available inserts (Ø)	
	ØD	Ød	Ød ₁	ℓ	L	Clamp screw	Wrench		
LRE	120030S-S12	12, 13	12	11.5	30	111	ETND03509	TWP10S	12, 13
	160050S-S16	16, 17	16	15.5	50	131			
	160060S-S16	16, 17	16	15.5	60	160	ETKD0516	TWP20	20, 21
	200060S-S20	20, 21	20	19.5	60	145			
	200080S-S20	20, 21	20	19.5	80	180			
	250070S-S25	25, 26	25	24.5	70	145	ETKD0620	TWP25	25, 26
	250100S-S25	25, 26	25	24.5	100	225			
	300070S-S32	30, 31	32	29.5	70	160	ETGD0825	TWP40	30, 31
	300100S-S32	30, 31	32	29.5	100	225			
	320080S-S32	32	32	31.5	80	160	ETGD0825	TWP40	32, 33
	320100S-S32	32	32	31.5	100	225			

➔ Available inserts E08, E09

LBE-MHD

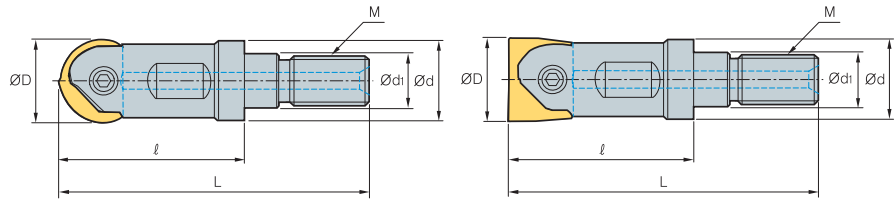

(mm)

Designation	Dimensions						Parts		Available inserts (Ø)
	M	ØD	L	ℓ	Ød	Ød ₁	Clamp screw	Wrench	
LBE 100-MHD-M06	M06	10, 11	40	25	9.5	6.5	ETND0307F	TWP08S	10, 11
120-MHD-M06	M06	12, 13	40	25	11	6.5	ETND03509	TWP10S	12, 13
160-MHD-M08	M08	16, 17	47	30	14.5	8.5	ETND0413	TWP15S	16, 17
200-MHD-M10	M10	20, 21	56	35	18	10.5	ETKD0516	TWP20	20, 21
250-MHD-M12	M12	25, 26	69	45	22.5	12.5	ETKD0620	TWP25	25, 26
300-MHD-M16	M16	30, 31	77	50	28	17	ETGD0825	TWP40	30, 31
320-MHD-M16	M16	32	77	50	29	17	ETGD0825	TWP40	32, 33

Available inserts E08, E09 Available adaptors E371~E372

Designation: LBE320-MHD-M16
Modular head threading measure size (M16)

=

Adaptor spec.: MAT-M16-035-S32S
Adaptor threading measure (M16)



BFE

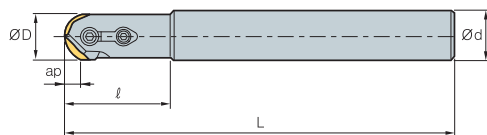

Fig. 1

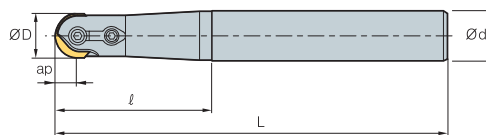

Fig. 2



Designation		ØD	Ød	ℓ	L	ap	kg	Fig.	Available inserts
BFE	16-S	16	16	36	140	8.0	0.2	1	RC16
	16-M	16	20	65	170	8.0	0.3	2	
	16-L	16	25	65	200	8.0	0.5	2	
	20-S	20	20	45	160	10.0	0.4	1	RC20
	20-M	20	25	80	200	10.0	0.6	2	
	20-L	20	25	80	250	10.0	0.8	2	
	25-S	25	25	45	160	12.5	0.7	1	RC25
	25-M	25	32	90	210	12.5	1.1	2	
	25-L	25	32	90	300	12.5	1.7	2	
	30-S	30	32	65	175	15.0	0.9	2	RC30
	30-M	30	32	100	250	15.0	1.4	2	
	30-L	30	32	100	350	15.0	2.0	2	
32-S	32	32	56	175	16.0	0.9	1	RC32	
32-M	32	32	100	250	16.0	1.4	1		
32-L	32	32	100	350	16.0	2.0	1		

(mm)

Available inserts

RC		Coated	
Designation	PC210F	page	
RC 16	●	E15	
20	●		
25	●		
30	●		
32	●		

Recommended cutting condition

	Workpiece	Cutting condition	
		vc (m/min)	fz (mm/t)
P	General steel (SS41, SM25C) Over HB180	150 ~ 250	0.10 ~ 0.30
	Alloy steel (SM55C, SCM) Under HB300	100 ~ 200	0.10 ~ 0.20
K	Cast iron Under HB300	100 ~ 200	0.10 ~ 0.30

Parts

Specification	Screw	Clamp	Clamp screw	Stopper Ring	Wrench
Ø16	FTGA0513	CBH4.5R1	CTX04513	ER03	TW20
Ø20	FTGA0517	CBH4.5R2	CTX04513	ER03	TW20
Ø25	FTGA0621	CBH5R1	CTX0517	ER04	TW20
Ø30, 32	FTGA0826	CBH6R1	CTX0621	ER05	TW25

Available inserts E15

GBE (Single-edge)

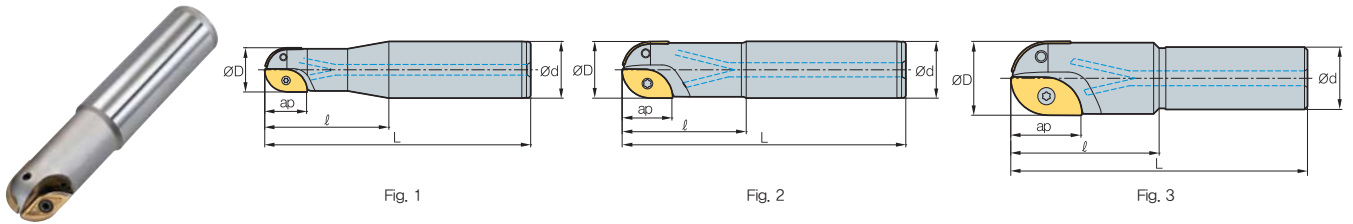

(mm)

Designation	Dimensions					Available inserts		Parts		Fig.
	ØD	Ød	l	L	ap	Internal	External	Screw Int./Ext. type	Wrench Ext. main type	
GBE 160-S20	16	20	50	130	15	ZPET080M-MM	ZPET080S-MM	FTKA02555S	TW08S	1
	160-L20	16	20	90	200	15	ZPET080M-MM	ZPET080S-MM	FTKA02555S	
180-S20	18	20	60	130	17	ZPET090M-MM	ZPET090S-MM	FTKA0307	TW09S	
	180-L20	18	20	80	200	17	ZPET090M-MM	ZPET090S-MM	FTKA0307	
200-S25	20	25	60	140	18	ZPET100M-MM	ZPET100S-MM	FTKA0307	TW09S	
	200-L25	20	25	80	250	18	ZPET100M-MM	ZPET100S-MM	FTKA0307	
220-S25	22	25	70	140	21	ZPET110M-MM	ZPET110S-MM	FTKA0408	TW15S	
	220-L25	22	25	100	250	21	ZPET110M-MM	ZPET110S-MM	FTKA0408	
250-S32	25	32	70	150	23	ZPET125M-MM	ZPET125S-MM	FTKA0409	TW15S	
	250-L32	25	32	100	300	23	ZPET125M-MM	ZPET125S-MM	FTKA0409	
260-S32	26	32	70	150	24.5	ZPET130M-MM	ZPET130S-MM	FTKA0409	TW15S	
	260-L32	26	32	100	300	24.5	ZPET130M-MM	ZPET130S-MM	FTKA0409	
280-S32	28	32	70	150	26	ZPET140M-MM	ZPET140S-MM	FTGA0511-P	TW20	
	280-L32	28	32	120	300	26	ZPET140M-MM	ZPET140S-MM	FTGA0511-P	TW20
300-S32	30	32	70	160	27	ZPET150M-MM	ZPET150S-MM	FTGA0511-P	TW20-100	
	300-L32	30	32	120	350	27	ZPET150M-MM	ZPET150S-MM	FTGA0511-P	TW20-100
320-S32	32	32	70	160	28	ZPET160M-MM	ZPET160S-MM	FTGA0511-P	TW20-100	
	320-L32	32	32	120	350	28	ZPET160M-MM	ZPET160S-MM	FTGA0511-P	TW20-100
400-S42	40	42	100	200	37	ZPET200M-MM	ZPET200S-MM	FTGA0614	TW20-100	
	400-L42	40	42	150	350	37	ZPET200M-MM	ZPET200S-MM	FTGA0614	TW20-100
500-S42	50	42	100	200	47	ZPET250M-MM	ZPET250S-MM	FTGA0818	TW25-100	
	500-L42	50	42	100	350	47	ZPET250M-MM	ZPET250S-MM	FTGA0818	TW25-100

Available inserts E31

GBE-M (Multi-edge)

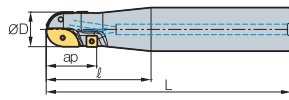

Fig. 1

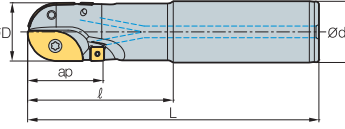

Fig. 2

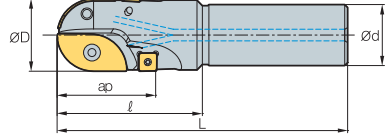

Fig. 3



(mm)

Designation	Dimensions					Available inserts			Parts				Fig.	
	ØD	Ød	ℓ	L	ap	Internal	External	Ext. main	Screw		Wrench			
									Int./Ext. type	Ext. main type	Int./Ext. type	Ext. main type		
GBE 200M-S25	20	25	70	150	28	ZPET100M-MM	ZPET100S-MM	SPMT060304	FTKA0307	ETNA02506	TW09S	TW07P	1	
	200M-L25	20	25	70	250	28	ZPET100M-MM	ZPET100S-MM	SPMT060304	FTKA0307	ETNA02506	TW09S		TW07P
	220M-S25	22	25	80	150	31	ZPET110M-MM	ZPET110S-MM	SPMT060304	FTKA0408	ETNA02506	TW15S		TW07P
	220M-L25	22	25	80	250	31	ZPET110M-MM	ZPET110S-MM	SPMT060304	FTKA0408	ETNA02506	TW15S		TW07P
	250M-S32	25	32	80	180	33	ZPET125M-MM	ZPET125S-MM	SPMT060304	FTKA0409	ETNA02506	TW15S		TW07P
	250M-L32	25	32	80	300	33	ZPET125M-MM	ZPET125S-MM	SPMT060304	FTKA0409	ETNA02506	TW15S		TW07P
	260M-S32	26	32	80	180	39	ZPET130M-MM	ZPET130S-MM	SDMT090308-MM	FTKA0409	ETNA0408	TW15S		TW15S
	260M-L32	26	32	80	300	39	ZPET130M-MM	ZPET130S-MM	SDMT090308-MM	FTKA0409	ETNA0408	TW15S		TW15S
	280M-S32	28	32	80	180	41	ZPET140M-MM	ZPET140S-MM	SDMT090308-MM	FTGA0511-P	ETNA0408	TW20		TW15S
	280M-L32	28	32	80	300	41	ZPET140M-MM	ZPET140S-MM	SDMT090308-MM	FTGA0511-P	ETNA0408	TW20		TW15S
	300M-S32	30	32	100	200	41	ZPET150M-MM	ZPET150S-MM	SDMT090308-MM	FTGA0511-P	ETNA0408	TW20-100		TW15S
	300M-L32	30	32	100	350	41	ZPET150M-MM	ZPET150S-MM	SDMT090308-MM	FTGA0511-P	ETNA0408	TW20-100		TW15S
320M-S32	32	32	100	200	42	ZPET160M-MM	ZPET160S-MM	SDMT090308-MM	FTGA0511-P	ETNA0408	TW20-100	TW15S	2	
	320M-L32	32	32	100	350	42	ZPET160M-MM	ZPET160S-MM	SDMT090308-MM	FTGA0511-P	ETNA0408	TW20-100		TW15S
400M-S42	40	42	100	200	56	ZPET200M-MM	ZPET200S-MM	SPMT120408-MM	FTGA0614	ETNA0511	TW20-100	TW20S	3	
400M-L42	40	42	100	350	56	ZPET200M-MM	ZPET200S-MM	SPMT120408-MM	FTGA0614	ETNA0511	TW20-100	TW20S		
500M-S42	50	42	100	200	67	ZPET250M-MM	ZPET250S-MM	SPMT120408-MM	FTGA0818	ETNA0511	TW25-100	TW20S	3	
500M-L42	50	42	100	350	67	ZPET250M-MM	ZPET250S-MM	SPMT120408-MM	FTGA0818	ETNA0511	TW25-100	TW20S		

Available inserts E25, E31

GBEM

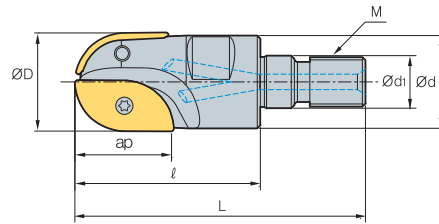

(mm)

Designation	Dimensions							Available inserts		
	ØD	Ød	Ød ₁	l	L	M	ap	Internal	External	
GBEM	160-M08	16	15	8.5	30	47	M08	15	ZPET080M-MM	ZPET080S-MM
	200-M10	20	18.6	10.5	35	56	M10	18	ZPET100M-MM	ZPET100S-MM
	250-M12	25	23.2	12.5	45	69	M12	23	ZPET125M-MM	ZPET125S-MM
	300-M16	30	27.8	17	50	77	M16	27	ZPET150M-MM	ZPET150S-MM
	320-M16	32	29.8	17	50	77	M16	28	ZPET160M-MM	ZPET160S-MM

Available inserts

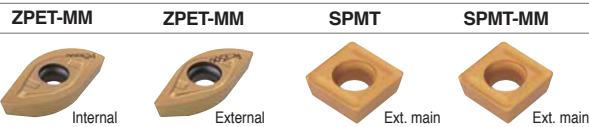

Designation	Coated				page	Designation	Coated				page
	NCM325	PC2510	PC3700	PC5300			NCM325	PC2510	PC3700	PC5300	
SPMT	060304	●			E25	ZPET	080S-MM				E31
	120408-MM		●	●	E25	090S-MM					
SDMT	090308-MM		●	●	E18	100S-MM		●	●	●	
ZPET	080M-MM				E31	110S-MM					
	090M-MM					125S-MM		●	●	●	
	100M-MM	●	●	●		130S-MM					
	110M-MM					140S-MM					
	125M-MM	●		●		150S-MM		●	●	●	
	130M-MM					160S-MM		●	●	●	
	140M-MM					200S-MM			●		
	150M-MM		●	●		250S-MM					
	160M-MM		●	●							
	200M-MM			●							
	250M-MM										

Parts

Specification	Screw		Wrench	
	Int./Ext. type	Ext. main type	Int./Ext. type	Ext. main type
Ø16	FTKA02555	-	TW08S	-
Ø20	FTKA0307	ETNA02506	TW09S	TW07P
Ø25	FTKA0409	ETNA02506	TW15S	TW07P
Ø30	FTGA0511-P	ETNA0408	TW20-100	TW15S
Ø32	FTGA0511-P	ETNA0408	TW20-100	TW15S

Designation: GBEM320-M16
Modular head threading measure size (M16)

II

Adaptor spec.: MAT-M16-035-S32S
Adaptor threading measure (M16)

Available inserts E18, E25, E31 Available adaptors E371-E372



BRE

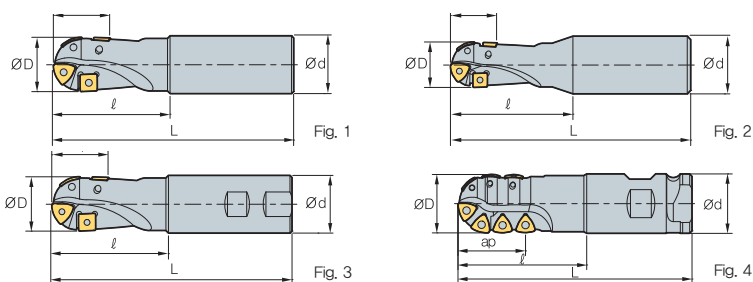

• AR: 0°~10°
• RR: -3°~0°

Designation	Dimensions					Available inserts		Parts		Fig.	
	ØD	Ød	ℓ	L	ap	Internal	External	Screw	Wrench		
BRE	20R-S	20	20	50	125	20	ZDMT080310R-MM	SPMT060304	ETNA02506	TW07P	0.25
	20R-M	20	20	75	150	20					0.31
	20R-L	20	25	100	200	20					0.57
	20R-SL	20	25	65	125	20					0.33
	25R-S	25	25	70	150	23	ZDMT110312.5R-MM	SPMT060304	ETNA02506	TW07P	0.47
	25R-M	25	25	95	175	23					0.56
	25R-L	25	32	100	200	23					0.92
	25R-SL	25	25	75	135	23					0.41
	32R-S	32	32	85	175	31	ZDMT130416R-MM	SDMT090308-MM	ETNA0408	TW15S	0.87
	32R-M	32	32	100	200	31					1.02
32R-L	32	32	150	250	31	1.3					
32R-SL	32	32	75	150	31	0.71					

Available inserts

		SDMT-MM	SPMT	ZDMT-R-MM			
Designation	Coated					page	
	NCM325	PC3700	PC5300	PC3525	PC6510		
SDMT 090308-MM		●	●			E18	
SPMT 060304	●					E25	
ZDMT 080310R-MM		●	●			E30	
110312.5R-MM			●				
130416R-MM		●	●				

Parts

Specification			
Ø20~Ø25	ETNA02506	-	TW07P
Ø32	ETNA0408	TW15S	-

Available inserts E18, E25, E30

BRE

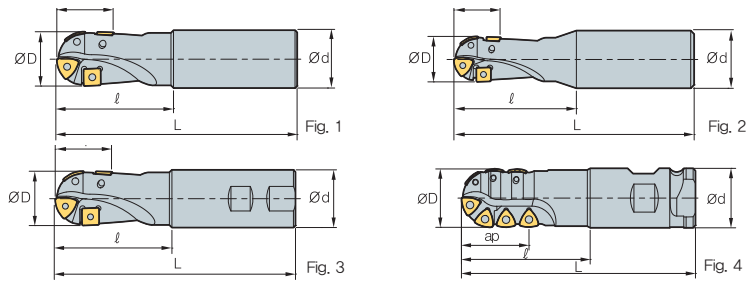

(mm)

Designation	Dimensions					Available inserts		Parts		kg	Fig.
	ØD	Ød	ℓ	L	ap	Main	Ext. main	Screw	Wrench		
BRE 40R-S	40	42	85	175	41	ZPMT160520R-MM	SPMT120408-MM SPMT120508-MMN	ETNA0511	TW20-100	1.37	1
	1.35										
	1.62										
	1.6										
	2.1										
	2										
	1.21										
	1.2										
50R-S	50	42	100	200	45	ZPMT160525R-MM	SPMT120408-MM SPMT120508-MMN	ETNA0511	TW20-100	2.02	1
	1.93										
	3.1										
	2.92										
63R-S	63	42	100	200	52	ZPMT160531.5R-MM	SPMT120408-MM SPMT120508-MMN	ETNA0511	TW20-100	2.41	1
	2.4										
	3.5										
	3.3										
40XR-SC40	40	40	110	200	54	ZPMT160520R-MM		ETNA0511	TW20-100	1.43	4
	1.89										
	2.34										
	3.06										
50XR-SC50.8	50	50.8	110	200	57	ZPMT160525R-MM ZPMT160525R-MR		ETNA0511	TW20-100	2.34	4
	3.06										

Available inserts

SPMT-MM ZPMT-R-MM ZPMT-R-MR



Designation	Coated					page
	NCM325	PC3700	PC5300	PC3525	PC6510	
SPMT 120408-MM		●	●			E25
120508-MMN						
ZPMT 160520R-MM		●	●			E31
160525R-MM		●	●			
160525R-MR						
160531.5R-MM			●			

Parts

Specification	Screw	Wrench
Ø40~Ø63	ETNA0511	TW20-100

Available inserts E25, E31



Multifunctional milling tool for mold making

HAVE

- Tools for Z-axis feed plunge machining to cut faster and more effectively in vertical machining
- Able to utilize the full diameter of the tools, thanks to the position and design of the inserts

Maximum step in vertical machining

ae	Diameter										
	16	17	20	21	25	26	32	33	35	40	50
	max step (mm)										
1	7.7	8	8.7	8.9	9.7	10	11.1	11.3	11.6	12.4	14
2	10.5	10.9	12	12.3	13.5	13.8	15.4	15.7	16.2	17.4	19.5
3	12.4	12.9	14.2	14.6	16.2	16.6	18.6	18.9	19.5	21	23.7
4	13.8	14.4	16	16.4	18.3	18.7	21.1	21.5	22.2	24	27.1
5	14.8	15.4	17.3	17.8	20	20.4	23.2	23.6	24.4	26.4	30
6	15.4	16.2	18.3	18.9	21.3	21.9	24.9	25.4	26.3	28.5	32.4
7	15.8	16.7	19	19.7	22.4	23	26.4	26.9	28	30.3	34.6
8	16	16.9	19.5	20.3	23.3	24	27.7	28.2	29.3	32	36.6
9	15.8	16.9	19.9	20.7	24	24.7	28.7	29.3	30.5	33.4	38.4
10	15.4	16.7	20	20.9	24.4	25.2	29.6	30.3	31.6	34.6	40
11	14.8	16.2	19.9	20.9	24.8	25.6	30.3	31.1	32.4	35.7	41.4
12	13.8	15.4	19.5	20.7	24.9	25.9	30.9	31.7	33.2	36.6	42.7
13	12.4	14.4	19	20.3	24.9	26	31.4	32.2	33.8	37.4	43.8
14	10.5	12.9	18.3	19.7	24.8	25.9	31.7	32.6	34.2	38.1	44.9
15	7.7	10.9	17.3	18.9	24.4	25.6	31.9	32.8	34.6	38.7	45.8
16	-	8	16	17.8	24	25.2	32	32.9	34.8	39.1	46.6
17	-	-	14.2	16.4	23.3	24.7	31.9	32.9	34.9	39.5	47.3
18	-	-	12	14.6	22.4	24	31.7	32.8	34.9	39.7	48
19	-	-	8.7	12.3	21.3	23	31.4	32.6	34.8	39.9	48.5
20	-	-	-	8.9	20	21.9	30.9	32.2	34.6	40	48.9
21	-	-	-	-	18.3	20.4	30.3	31.7	34.2	39.9	49.3
22	-	-	-	-	16.2	18.7	29.6	31.1	33.8	39.7	49.6
23	-	-	-	-	13.5	16.6	28.7	30.3	33.2	39.5	49.8
24	-	-	-	-	9.7	13.8	27.7	29.3	32.4	39.1	49.9
25	-	-	-	-	-	10	26.4	28.2	31.6	38.7	50

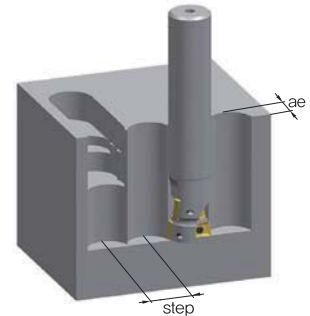

Programming in vertical cutting

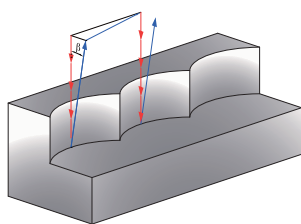

- Vertical machining route
- Rapid feed
- β Angle between tool and workpiece ($\beta \geq 1^\circ$)

- Reduce 30% of feed till 3 mm machining
- Have the tool be away from the workpiece more than 1° (β) after finishing the machining or when moving the tool to the next step.

Cutting condition

Designation	Hardness	Grades	Cutting condition		Ø16, 17		Ø20, 21		Ø25, 26		Ø32, 33		Ø35		Ø40		Ø50	
			vc (m/min)	Feed (mm/rev)	Step (mm)	Feed (mm/rev)	Step (mm)	Feed (mm/rev)	Step (mm)	Feed (mm/rev)	Step (mm)	Feed (mm/rev)	Step (mm)	Feed (mm/rev)	Step (mm)	Feed (mm/rev)	Step (mm)	
P	Mild steel, Low Carbon steel (SS400)	Under 200HB	PC3500	200 (150~250)	0.03	0.20	0.04	0.30	0.05	0.30	0.05	0.30	0.06	0.30	0.06	0.30	0.07	0.30
	Carbon steel, Alloy steel (SM50C, SCM440)	Under 100HrC	PC3500	180 (120~220)	0.03	0.20	0.04	0.30	0.05	0.30	0.05	0.30	0.05	0.30	0.06	0.30	0.06	0.30
M	Stainless steel (STS)	Under 270HB	PC5300	160 (120~200)	0.03	0.15	0.04	0.25	0.05	0.25	0.05	0.25	0.05	0.25	0.06	0.25	0.06	0.25
K	Cast iron (GC, GCD)	350N/mm ²	PC5300	200 (150~250)	0.04	0.40	0.05	0.50	0.06	0.50	0.06	0.50	0.06	0.50	0.07	0.50	0.07	0.50
H	Hardened steel	40~55HrC	PC5300	80 (50~120)	0.03	0.15	0.03	0.25	0.04	0.25	0.04	0.25	0.04	0.25	0.04	0.25	0.05	0.25

* Please note - Step machining is required for aspect ratio under 0.5D or initial drilling

1. Ramping

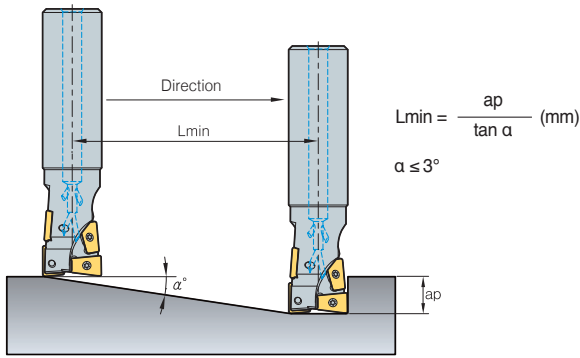

2. Helical cutting

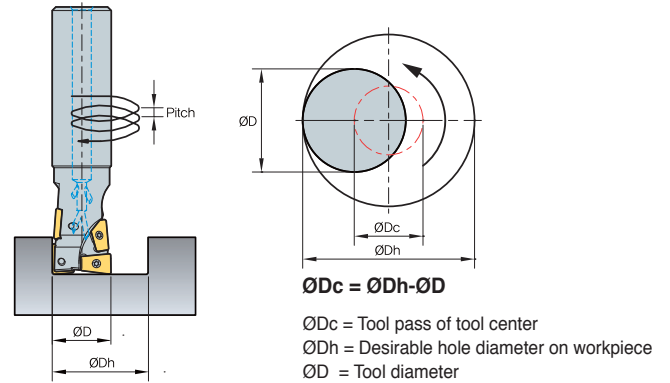

➤ Cutting condition for ramping and helical operation

Designation	Hardness	Grades	Cutting Speed vc (m/min)	Ø16, 17				Ø20, 21				Ø25, 26				Ø32, 33				Ø35				Ø40				Ø50			
				ØDh (mm)	ap (mm/t)	fz (mm/t)	max pitch (mm)	ØDh (mm)	ap (mm/t)	fz (mm/t)	max pitch (mm)	ØDh (mm)	ap (mm/t)	fz (mm/t)	max pitch (mm)	ØDh (mm)	ap (mm/t)	fz (mm/t)	max pitch (mm)	ØDh (mm)	ap (mm/t)	fz (mm/t)	max pitch (mm)	ØDh (mm)	ap (mm/t)	fz (mm/t)	max pitch (mm)				
P Mild steel, Low Carbon steel (SS400)	≤ 200HB	PC3500	200 (150-250)	19 ~30	0.5D ~1D	0.15 ~0.12	0.35 ~1.61	23 ~28	0.5D ~1D	0.18 ~0.12	0.35 ~2.07	29 ~47	0.5D ~1D	0.2 ~0.15	0.46 ~2.53	37 ~60	0.5D ~1D	0.25 ~0.2	0.58 ~3.23	41 ~65	0.5D ~1D	0.28 ~0.2	0.69 ~3.46	47 ~75	0.5D ~1D	0.3 ~0.2	0.81 ~4.03	58 ~95	0.5D ~1D	0.35 ~0.25	0.92 ~5.18
			180 (120-220)	19 ~30	0.5D ~1D	0.15 ~0.1	0.26 ~1.23	23 ~28	0.5D ~1D	0.16 ~0.12	0.26 ~1.58	29 ~47	0.5D ~1D	0.18 ~0.12	0.35 ~1.93	37 ~60	0.5D ~1D	0.2 ~0.15	0.44 ~2.46	41 ~65	0.5D ~1D	0.22 ~0.17	0.53 ~2.63	47 ~75	0.5D ~1D	0.25 ~0.2	0.61 ~3.07	58 ~95	0.5D ~1D	0.28 ~0.25	0.70 ~3.95
M Stainless steel (STS)	≤ 270HB	PC5300	160 (120-200)	19 ~30	0.2D ~0.5D	0.13 ~0.1	0.18 ~0.84	23 ~28	0.2D ~0.5D	0.15 ~0.12	0.18 ~1.09	29 ~47	0.2D ~0.5D	0.18 ~0.12	0.24 ~1.33	37 ~60	0.2D ~0.5D	0.2 ~0.15	0.24 ~1.33	41 ~65	0.2D ~0.5D	0.22 ~0.17	0.36 ~1.81	47 ~75	0.2D ~0.5D	0.25 ~0.2	0.42 ~2.11	58 ~95	0.2D ~0.5D	0.48 ~2.71	
K Cast iron (GC, GCD)	≤ 350N/mm ²	PC5300	200 (150-250)	19 ~30	0.7D ~1D	0.17 ~0.12	0.43 ~2.0	23 ~28	0.7D ~1D	0.2 ~0.12	0.42 ~2.57	29 ~47	0.7D ~1D	0.2 ~0.15	0.57 ~3.14	37 ~60	0.7D ~1D	0.25 ~0.2	0.71 ~3.99	41 ~65	0.7D ~1D	0.28 ~0.2	0.86 ~4.28	47 ~75	0.7D ~1D	0.3 ~0.2	1.0 ~4.99	58 ~95	0.7D ~1D	0.35 ~0.25	1.14 ~6.42
H Hardened steel	40~55HRC	PC5300	80 (50-120)	19 ~30	0.2D ~0.5D	0.1 ~0.05	0.18 ~0.84	23 ~28	0.2D ~0.5D	0.12 ~0.07	0.18 ~1.09	29 ~47	0.2D ~0.5D	0.13 ~0.1	0.24 ~1.33	37 ~60	0.2D ~0.5D	0.15 ~0.12	0.30 ~1.69	41 ~65	0.2D ~0.5D	0.17 ~0.13	0.36 ~1.81	47 ~75	0.2D ~0.5D	0.18 ~0.15	0.42 ~2.11	58 ~95	0.2D ~0.5D	0.2 ~0.15	0.48 ~2.71

➤ Recommended cutting condition in shouldering

Designation	Hardness	Grades	Cutting Speed vc (m/min)	Ø16,17			Ø20,21			Ø25,26			Ø32,33			Ø35			Ø40			Ø50		
				max ap (mm)	max ae (mm)	max fz (mm/t)	max ap (mm)	max ae (mm)	max fz (mm/t)	max ap (mm)	max ae (mm)	max fz (mm/t)	max ap (mm)	max ae (mm)	max fz (mm/t)	max ap (mm)	max ae (mm)	max fz (mm/t)	max ap (mm)	max ae (mm)	max fz (mm/t)	max ap (mm)	max ae (mm)	max fz (mm/t)
P Mild steel, Low Carbon steel (SS400)	≤ 200HB	PC3500	200 (150-250)	17	8	0.25	22	10	0.3	27	13	0.35	35	16	0.4	40	18	0.45	44	20	0.5	55	25	0.6
			180 (120-220)	17	8	0.2	22	10	0.25	27	13	0.3	35	16	0.35	40	18	0.4	44	20	0.4	55	25	0.5
M Stainless steel (STS)	≤ 270HB	PC5300	160 (120-200)	17	8	0.2	22	10	0.25	27	13	0.3	35	16	0.35	40	18	0.4	44	20	0.4	55	25	0.5
K Cast iron (GC, GCD)	≤ 350N/mm ²	PC5300	200 (150-250)	17	8	0.25	22	10	0.3	27	13	0.35	35	16	0.4	40	18	0.45	44	20	0.5	55	25	0.6
H Hardened steel	40~55HRC	PC5300	80 (50-120)	17	5	0.15	22	6	0.2	27	7	0.22	35	8	0.25	40	9	0.3	44	10	0.3	55	14	0.35

➤ Recommended cutting condition in grooving

Designation	Hardness	Grades	Cutting Speed vc (m/min)	Ø16,17		Ø20,21		Ø25,26		Ø32,33		Ø35		Ø40		Ø50	
				max ap (mm)	max fz (mm/t)	max ap (mm)	max fz (mm/t)	max ap (mm)	max fz (mm/t)	max ap (mm)	max fz (mm/t)	max ap (mm)	max fz (mm/t)	max ap (mm)	max fz (mm/t)		
P Mild steel, Low Carbon steel (SS400)	≤ 200HB	PC3500	200 (150-250)	17	0.15	22	0.18	27	0.2	35	0.25	40	0.27	44	0.3	55	0.35
			180 (120-220)	17	0.15	22	0.15	27	0.18	35	0.2	40	0.22	44	0.25	55	0.3
M Stainless steel (STS)	≤ 270HB	PC5300	160 (120-200)	17	0.15	22	0.15	27	0.18	35	0.2	40	0.22	44	0.25	55	0.3
K Cast iron (GC, GCD)	≤ 350N/mm ²	PC5300	200 (150-250)	17	0.15	22	0.18	27	0.2	35	0.25	40	0.27	44	0.3	55	0.35
H Hardened steel	40~55HRC	PC5300	80 (50-120)	12	0.1	14	0.12	17	0.15	22	0.15	25	0.18	28	0.18	35	0.22



HAVE (Multi-edge)

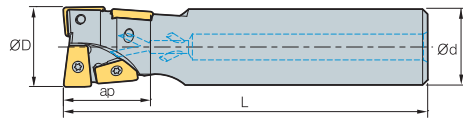

Fig. 1

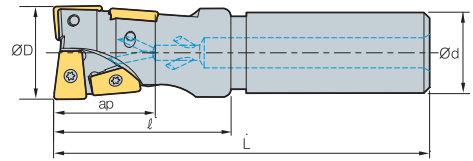

Fig. 2



AA
90°
• AR: 7°~12°
• RR: -12°~ -4°

(mm)

Designation		ØD	Ød	ℓ	L	ap	Available inserts		Fig.
HAVE 0816HR-S16M	4	16	16	30	120	17.6	XPMT0802ER-MM	0.15	1
0816HR-L16M	4	16	16	30	200	17.6		0.26	
0817HR-S16M	4	17	16	30	120	17.6		0.18	2
0817HR-L16M	4	17	16	30	200	17.6		0.27	
1020HR-S20M	4	20	20	35	130	22	XPMT1003ER-MM	0.26	1
1020HR-L20M	4	20	20	35	210	22		0.44	
1021HR-S20M	4	21	20	35	130	22		0.26	2
1021HR-L20M	4	21	20	35	210	22		0.45	
1325HR-S25M	4	25	25	45	140	27	XPMT13T3ER-MM	0.41	1
1325HR-L25M	4	25	25	45	220	27		0.71	
1326HR-S25M	4	26	25	45	140	27		0.45	2
1326HR-L25M	4	26	25	45	220	27		0.68	
1632HR-S32M	4	32	32	50	150	35.2	XPMT1604ER-MM	0.72	1
1632HR-L32M	4	32	32	50	250	35.2		1.32	
1633HR-S32M	4	33	32	50	150	35.2		0.76	2
1633HR-L32M	4	33	32	50	250	35.2		1.27	
1835HR-S32M	4	35	32	50	150	40	XPMT1805ER-MM	0.75	1
1835HR-L32M	4	35	32	50	230	40		1.23	
2040HR-S32M	4	40	32	55	160	44	XPMT2006ER-MM	0.74	2
2040HR-L32M	4	40	32	55	240	44		1.35	
2550HR-S42M	4	50	42	70	170	55	XPMT2507ER-MM	1.53	2
2550HR-L42M	4	50	42	70	250	55		2.60	

Available inserts

XPMT-MM



Designation	Cermet		Coated										Uncoated			page			
	CN2000	CN30	NCM325	NC5330	NCM535	NCM545	PC2505	PC2510	PC3600	PC3700	PC6510	PC9530	PC9540	PC5300	PC5400		ST30A	G10	H01
XPMT 0802ER-MM														●					E30
1003ER-MM									●					●					
13T3ER-MM														●					
1604ER-MM														●					
1805ER-MM														●					
2006ER-MM														●					
2507ER-MM														●					

Parts

Specification		
Ø16~Ø17	FTNA0204	TW06S
Ø20~Ø21	FTNA02205	TW09S
Ø25~Ø26	FTKA0307	TW15S
Ø32~Ø33	FTKA0408	TW20S
Ø35		
Ø40	FTGA0511-P	
Ø50	FTNA0615	

Available inserts E30

HAVE (Single-edge)

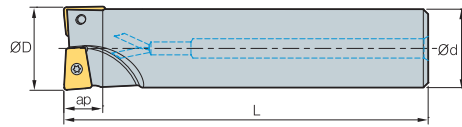

Fig. 1

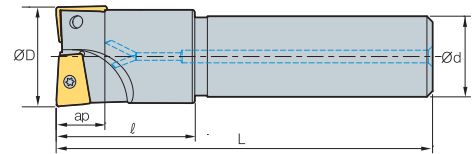

Fig. 2



AA
90°

• AR: 7°~12°
• RR: -12°~-4°

(mm)

Designation		ØD	Ød	ℓ	L	ap	Available inserts		Fig.
HAVE	0816HR-S16	2	16	16	30	120	7.5	0.16	1
	0817HR-S16	2	17	16	30	120	7.5	0.16	2
	1020HR-S20	2	20	20	35	130	9.5	0.28	1
	1021HR-S20	2	21	20	35	130	9.5	0.28	2
	1325HR-S25	2	25	25	45	140	12	0.44	1
	1326HR-S25	2	26	25	45	140	12	0.47	2
	1632HR-S32	2	32	32	50	150	15.4	0.77	1
	1633HR-S32	2	33	32	50	150	15.4	0.81	2
	1835HR-S32	2	35	32	50	150	16.7	0.81	1
	2040HR-S32	2	40	32	55	160	19.3	0.95	2
	2550HR-S42	2	50	42	70	170	24	1.68	2

Available inserts

XPMT-MM



Designation	Cermet		Coated										Uncoated			page			
	CN2000	CN30	NCM325	NC5330	NCM535	NCM545	PC2505	PC2510	PC3600	PC3700	PC6510	PC9530	PC9540	PC5300	PC5400		ST30A	G10	H01
XPMT														●					E30
0802ER-MM														●					
1003ER-MM									●					●					
13T3ER-MM														●					
1604ER-MM														●					
1805ER-MM														●					
2006ER-MM														●					
2507ER-MM														●					

Parts

Specification		
Ø16~Ø17	FTNA0204	TW06S
Ø20~Ø21	FTNA02205	TW09S
Ø25~Ø26	FTKA0307	TW15S
Ø32~Ø33	FTKA0408	TW15S
Ø35		
Ø40	FTGA0511-P	TW20S
Ø50	FTNA0615	

Available inserts E30



High productivity with optimized grade for high speed machining

O-ring Cutter

- Optimized for grooving the seat of an O-ring in a plastic mold
- Guarantees superior surface roughness compared to HSS and brazed tool
- High productivity with optimized grade for high speed machining
- Reduced time for regrinding and tool alignment
- Special types are available for quotation

Holder code system

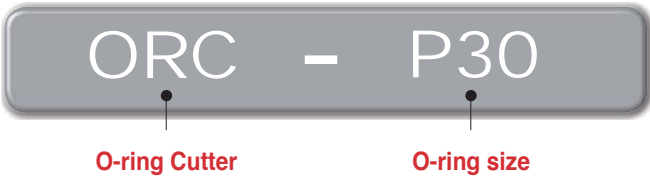

Insert code system



Grooving and assembly of O-ring

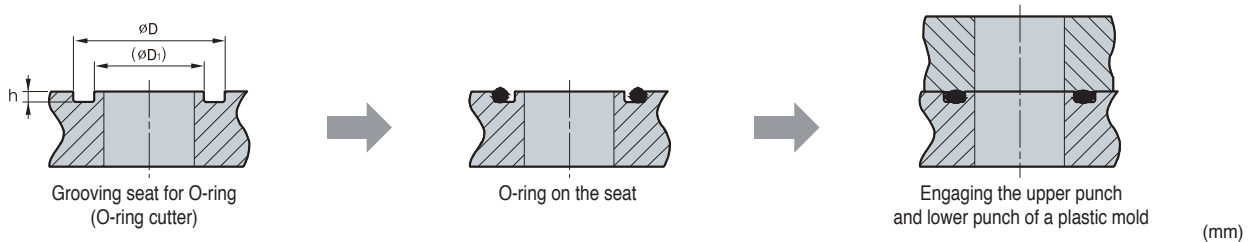

O-ring size	ØD	(ØD ₁)	h ± 0.05
P08	11.0	5.8	1.40
P09	12.0	6.8	
P10	13.0	7.8	
P11	15.0	8.5	
P12	16.0	9.5	
P14	18.0	11.5	1.80
P15	19.0	12.5	
P16	20.0	13.5	
P18	22.0	15.5	
P20	24.0	17.5	
P21	25.0	18.5	2.70
P22	26.0	19.5	
P24	30.0	20.6	
P25	31.0	21.6	

O-ring size	ØD	(ØD ₁)	h ± 0.05
P26	32.0	22.6	2.70
P28	34.0	24.6	
P29	35.0	25.6	
P30	36.0	26.6	
P31	37.0	27.6	
P32	38.0	28.6	
P34	40.0	30.6	
P35	41.0	31.6	
P38	44.0	34.6	
G40	46.0	36.6	
G25	30.0	21.8	2.40
G30	35.0	26.8	
G35	40.0	31.8	
G40	45.0	36.8	

Recommended cutting condition

Workpiece	fz (mm/t)	vc (m/min)
		Coating PC3500
Stainless Steel (STS304)	0.03~0.12	60~130
Carbon Steel (SM□□C)	0.05~0.15	80~150
Alloy Steel (SCM)	0.05~0.15	80~150
Hardened Steel (STD, NAK)	0.03~0.12	60~130

Machining Example

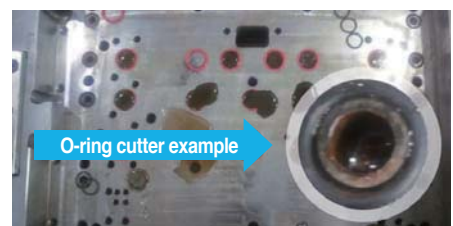

ORC



(mm)

Designation		ØD	Ød1	Ød	ℓ	L	Available inserts	O-Ring size	
ORC -	P08	1	11.0	5.7	16	30	150	ORG265	P08
	P09	1	12.0	6.7	16	30	150	ORG265	P09
	P10	1	13.0	7.7	16	30	150	ORG265	P10
	P11	1	15.0	8.5	16	30	150	ORG325	P11
	P12	2	16.0	9.5	16	30	200	ORG325	P12
	P14	2	18.0	11.5	20	30	200	ORG325	P14
	P15	2	19.0	12.5	20	30	200	ORG325	P15
	P16	2	20.0	13.5	20	30	200	ORG325	P16
	P18	2	22.0	15.5	20	30	200	ORG325	P18
	P20	2	24.0	17.5	25	30	200	ORG325	P20
	P21	2	25.0	18.5	25	30	200	ORG325	P21
	P22	2	26.0	19.5	25	30	200	ORG325	P22
	P24	2	30.0	20.6	32	40	250	ORG470	P24
	P25	2	31.0	21.6	32	40	250	ORG470	P25
	P26	2	32.0	22.6	32	40	250	ORG470	P26
	P28	2	34.0	24.6	32	40	250	ORG470	P28
	P29	2	35.0	25.6	32	40	250	ORG470	P29
	P30	2	36.0	26.6	32	40	250	ORG470	P30
	P31	2	37.0	27.6	32	40	250	ORG470	P31
	P32	2	38.0	28.6	32	40	250	ORG470	P32
P34	2	40.0	30.6	42	40	250	ORG470	P34	
P35	2	41.0	31.6	42	40	250	ORG470	P35	
P38	2	44.0	34.6	42	40	250	ORG470	P38	
P40	2	46.0	36.6	42	40	250	ORG470	P40	
ORC -	G25	2	30.0	21.9	32	40	250	ORG405	G25
	G30	2	35.0	26.9	32	40	250	ORG405	G30
	G35	2	40.0	31.9	42	40	250	ORG405	G35
	G40	2	45.0	36.9	42	40	250	ORG405	G40

Available inserts

ORG



Cutter Designation	Designation	Cermet		Coated										Uncoated			page			
		CN2000	CN30	NCM325	NC5330	NCM535	NCM545	PC2505	PC2510	PC3600	PC3700	PC6510	PC9530	PC9540	PC5300	PC5400		ST30A	G10	H01
ORC-P08~P10	ORG 265																			E14
ORC-P11~P22	325																			
ORC-P24~P40	470																			
ORC-G25~G40	405																			

Parts

Specification		
Ø11~Ø26	FTKA0307	TW09S
Ø30~Ø46	FTGA03508	TW15S
Ø30~Ø45		

Available inserts E14



All applications for chamfers

Chamfer Tool

- All chamfer applications
- Chamfer angles 15°, 30°, 45°, 60° for a variety of customer's needs
- The long cutting-edge provides a wide chamfering range



Back & Front Chamfer Tools



Long Chamfer Tools

Code system

CE	45	-	11	25	R	-	S	20
Chamfer Endmill	Chamfer angle		Inscribed circle of insert	Min. Cutting Dia.	Hand		Overall length	Shank Dia.
	45°		11: SPMT110408-KC 12: SPMN120308 31: XCET310404ER-KC	Ø25	R: Right L: Left		S: Standard M: Middle L: Long	Ø20

Recommended cutting condition

Workpiece	Grades	ØD (Ø5~Ø20)		ØD (Ø25~Ø35)	
		vc (m/min)	fz (mm/t)	vc (m/min)	fz (mm/t)
P	PC3500	160~270	0.05~0.25	160~270	0.05~0.25
	PC5300	190~310		190~310	
	ST30A	60~100		60~100	
M	PC5300	100~160	0.05~0.20	100~160	0.10~0.30
	PC5400	70~120		70~120	
K	PC5300	110~180	0.10~0.30	110~180	0.30~0.50
	G10	50~90		50~90	

Application example

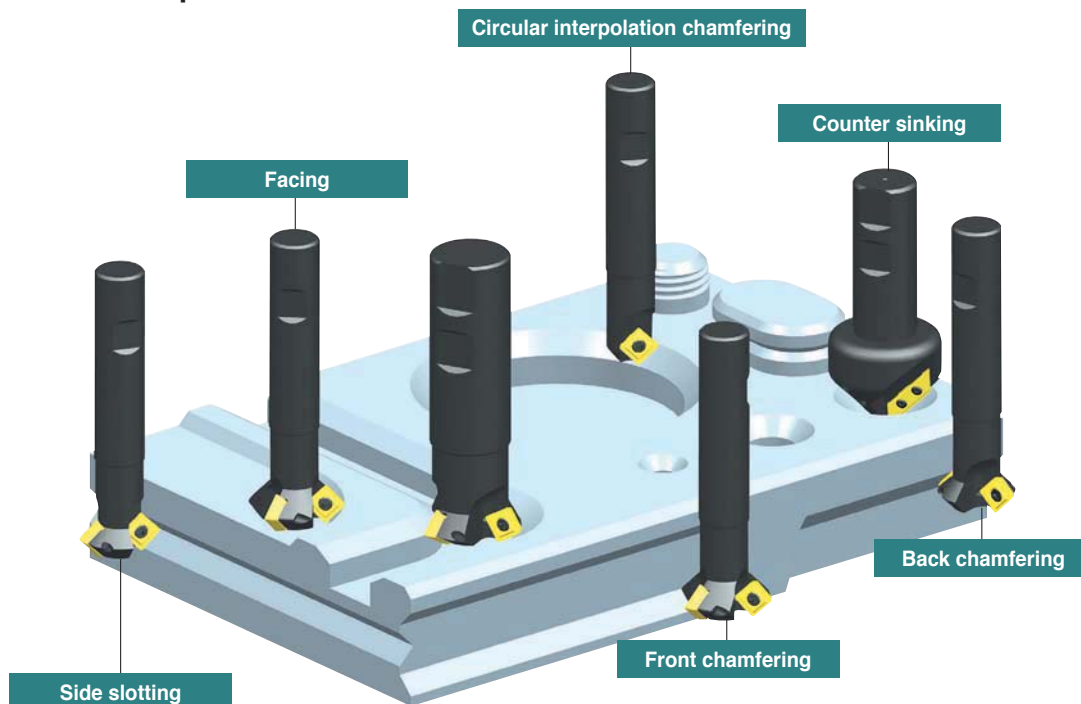

Multi-functional Chamfer Tool

Code system

CE	45	- 16	00	R	- S	20
Chamfer Endmill	Chamfer angle 45°	Inscribed circle of insert 16: TWX16R-KC 22: TWX22R-KC	Min. Cutting Dia. Ø0	Hand R: Right L: Left	Overall length S: 90,110 L: 200	Shank Dia. Ø12 Ø20 Ø25

Application area and recommended cutting condition

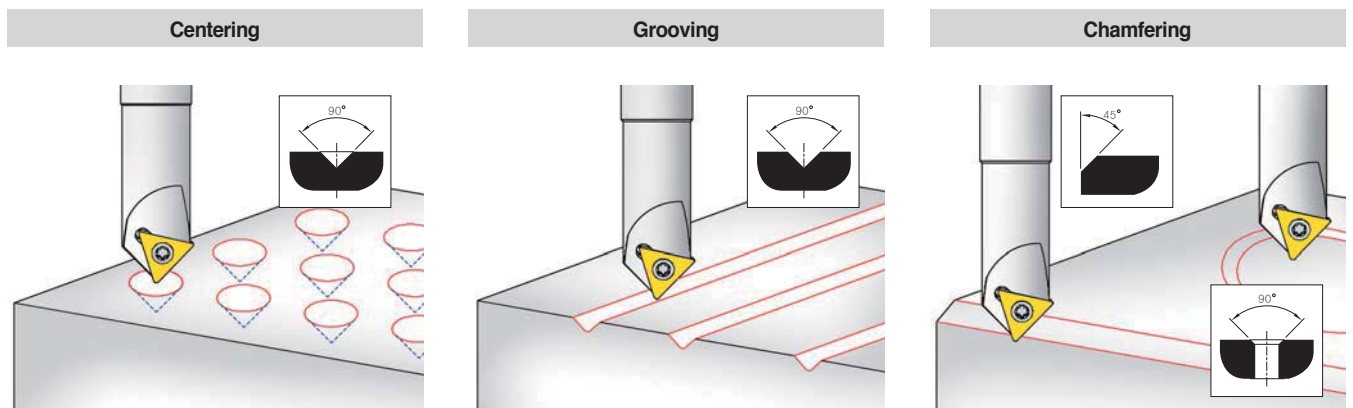

Workpiece	Hardness (HrC)	Centering, Grooving		Chamfering	
		vc (m/min)	fz (mm/t)	vc (m/min)	fz (mm/t)
Mild steel, Carbon steel, Alloy steel	Under HrC 30	80~200	0.01~0.04	100~250	0.04~0.06
High Carbon steel, Alloy steel	HrC 30, 40	150~250	0.02~0.06	150~300	0.05~0.10
Aluminum, Copper	-	150~300	0.04~0.08	150~350	0.05~0.10
Cast iron	-	80~150	0.02~0.06	100~250	0.05~0.10
Stainless steel	-	60~120	0.01~0.03	60~150	0.03~0.06
HRSA	-	60~80	0.01~0.03	60~100	0.03~0.06

Note) Please keep fz. backtouch & chipping one caused by wrong fz

Machining example



Solid Chamfer Tool

Code system

CCT	090	T	-	080	L
Type	Chamfer angle	Cutting-edge		Diameter	Tool length
CCT: Centering & Chamfering Tool CET: Centering & Chamfering Endmill Tool	060: 60° 090: 90° 120: 120°	None: Single T: Twin		080: Ø8.0	None: Standard L: Long

Features

CET (Centering & Chamfering Endmill Tool)

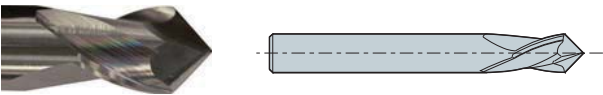

- For internal chamfering up to 0.5 mm
- Can be applied to side milling and easy to regrinding

CCT (Centering & Chamfering Tool)

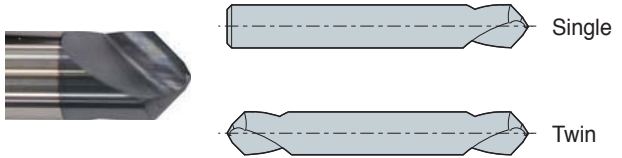

- Chipping resistance realizes machining in high speed due to double point angle
- Lowers cutting load due to web thinning

CET/CCT Application example

Type	Centering	Hole Chamfering	Chamfering (External)	Chamfering (Internal)	Side milling	Slot milling
Applications (CET)						
60°	×	●	●	●~▲	●	×
90°	▲	●	●	●	●	●~▲
120°	●	●	●	●	●	●
Applications (CCT)						
60°	●	●	●~▲	▲~×	×	×
90°	●	●	●~▲	▲~×	×	×
120°	●	●	●	●	×	●

CE (Back & Front)

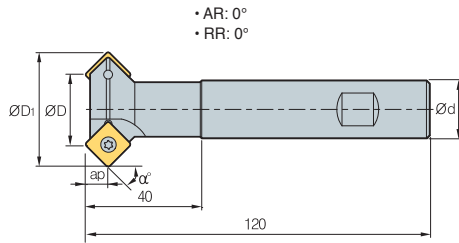

Fig. 1

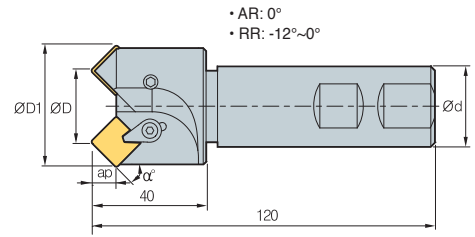

Fig. 2



(mm)

Designation	Z	ØD	ØD ₁	Ød	ap	Fig.	Available inserts	α° (Chamfer angle)		Machining range (Min~Max)	Uses	
								Front	Back			
CE	15-1125R-S20	2	25	30.5	20	9.5	SPMT110408-KC	15°	-	Ø25~Ø30	Front chamfering	
	30-1125R-S20	2	25	35.5	20	8.5		1	30°	60°	Ø25~Ø35	Front, Back chamfering
	45-1107R-S20	1	7	21.9	20	7.0		1	45°	-	Ø7~Ø21	Front chamfering
	45-1119R-S20	2	19	33.9	20	7.0		1	45°	45°	Ø19~Ø33	Front, Back chamfering
	45-1125R-S20	3	25	39.9	20	7.0		1	45°	45°	Ø25~Ø39	Front, Back chamfering
	60-1125R-S32	3	25	43.3	32	5.0		1	60°	30°	Ø25~Ø42	Front, Back chamfering
	45-1207R-S32	1	7	23.3	32	7.8	2	SPMN120308	45°	-	Ø7~Ø22	Front chamfering
	45-1220R-S32	2	20	37.3	32	7.8	2		45°	-	Ø21~Ø36	Front chamfering
	45-1225R-S32	2	25	42.3	32	7.8	2		45°	-	Ø26~Ø41	Front chamfering
	45-1235R-S32	2	35	52.3	32	7.8	2		45°	-	Ø36~Ø51	Front chamfering

Available inserts

SPMT-KC SPMN



Designation	Cermet		Coated										Uncoated			page		
	CN2000	CN30	NCM325	NC5330	NCM535	NCM545	PC2505	PC2510	PC3600	PC3700	PC6510	PC9530	PC9540	PC5300	PC5400		ST30A	G10
SPMT 110408-KC									●							●	●	
SPMN 120308																●		

Parts

Specification	Screw	Clamp	C-Ring	Wrench	Wrench
Ø7~Ø25 (1100 type)	FTKA0408	-	-	TW15S	-
Ø7~Ø35 (1200 type)	CHX0617L	CH6R2	CR05	-	HW30L

Available inserts E25



CE (Long chamfer)

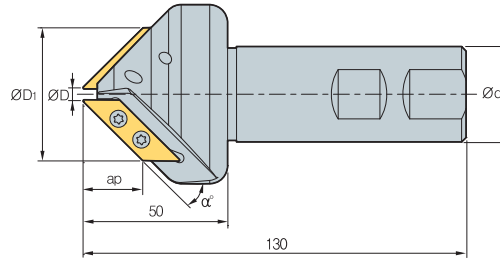

- AR: -5°~1°
- RR: 0°

(mm)

Designation		ØD	ØD ₁	Ød	ap	α° (Chamfer angle)	Machining range (Min-Max)	Uses	
CE	30-3105R-S32	1	5	35	32	26	30°	Ø5~Ø35	Front Chamfering
	45-3105R-S32	2	5	48	32	21	45°	Ø5~Ø48	Front Chamfering
	60-3105R-S32	2	5	57	32	15	60°	Ø5~Ø57	Front Chamfering

Available inserts

XCET-KC



Designation	Cermet		Coated										Uncoated			page			
	CN2000	CN30	NCM325	NC5330	NCM535	NCM545	PC2505	PC2510	PC3800	PC3700	PC6510	PC9530	PC9540	PC5300	PC5400		ST30A	G10	H01
XCET 310404ER-KC									●							●	●		E29

Parts

Specification		
Ø5	FTKA03510	TW15S

Available inserts E29

CE (Multi-functional)

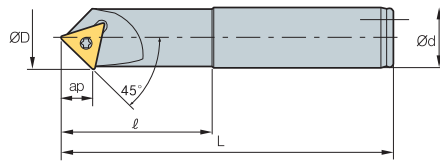

Fig. 1

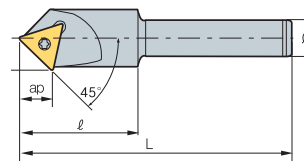
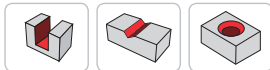

Fig. 2



• AR: -12°~15°
• RR: 0°

(mm)

Designation	ØD	Ød	ℓ	L	ap	Fig.	Available Inserts	Machining range (Min~Max)	Uses	
CE	45-1600R-S12	21.2	12	40	90	10	2	TWX16R-KC	Ø0 ~ Ø20	Centering Grooving Chamfering
	45-1600R-S20	21.2	20	50	110	10	1	TWX16R-KC	Ø0 ~ Ø20	
	45-1600R-L20	21.2	20	60	200	10	1	TWX16R-KC	Ø0 ~ Ø20	
	45-2200R-S12	28.8	12	40	90	14	2	TWX22R-KC	Ø0 ~ Ø27	
	45-2200R-S25	28.8	25	50	110	14	1	TWX22R-KC	Ø0 ~ Ø27	
	45-2200R-L25	28.8	25	60	200	14	1	TWX22R-KC	Ø0 ~ Ø27	



Available inserts

TWX-KC



Designation	Cermet		Coated										Uncoated			page			
	CN2000	CN30	NCM325	NC5330	NCM535	NCM545	PC2505	PC2510	PC3600	PC3700	PC6510	PC9530	PC9540	PC5300	PC5400		ST30A	G10	H01
TWX 16R-KC									●					●					E27
TWX 22R-KC									●										

Parts

Specification	 Screw	 Wrench
Ø22~Ø29	FTNA0408	TW15L

Available inserts E27



CET

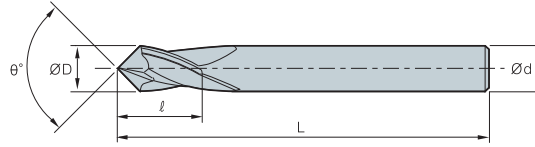

(mm)

Designation	ØD	Ød	ℓ	L	θ°
CET060 -	030	3	3	5.5	60°
	040	4	4	7	
	060	6	6	10	
	080	8	8	13	
	100	10	10	16	
	120	12	12	18	
	160	16	16	24	
CET090 -	030	3	3	5.5	90°
	040	4	4	7	
	060	6	6	10	
	080	8	8	13	
	100	10	10	16	
	120	12	12	18	
	160	16	16	24	
CET120 -	030	3	3	5.5	120°
	040	4	4	7	
	060	6	6	10	
	080	8	8	13	
	100	10	10	16	
	120	12	12	18	
	160	16	16	24	

CCT

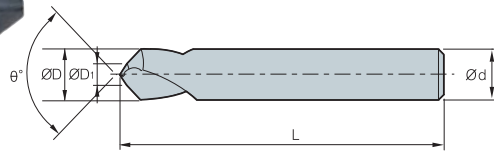

Fig. 1

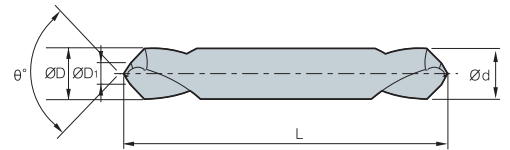

Fig. 2

(mm)

Designation	$\text{OD} = \text{OD}$	OD1	L	θ°	Fig.	
CCT060 -	030	3	1.0	60°	1	
	040	4	1.5			
	060	6	2.0			
	080	8	2.5			
	100	10	3.0			
	120	12	4.0			
	160	16	5.0			
CCT060T -	030	3	1.0		2	
	040	4	1.5			
	060	6	2.0			
	080	8	2.5			
	100	10	3.0			
	120	12	4.0			
	160	16	5.0			
CCT060T -	030L	3	1.0	100	2	
	040L	4	1.5			
	060L	6	2.0			
	080L	8	2.5			
	100L	10	3.0			
	120L	12	4.0			
	150L	12	4.0			
CCT090 -	030	3	1.0	90°	1	
	040	4	1.5			
	060	6	2.0			
	080	8	2.5			
	100	10	3.0			
	120	12	4.0			
	160	16	5.0			
CCT090T -	030	3	1.0		40	2
	040	4	1.5			
	060	6	2.0			
	080	8	2.5			
	100	10	3.0			
	120	12	4.0			
	160	16	5.0			
CCT090T -	030L	3	1.0	100	2	
	040L	4	1.5			
	060L	6	2.0			
	080L	8	2.5			
	100L	10	3.0			
	120L	12	4.0			
	150L	12	4.0			
CCT120 -	030	3	1.0	120°	1	
	040	4	1.5			
	060	6	2.0			
	080	8	2.5			
	100	10	3.0			
	120	12	4.0			
	160	16	5.0			
CCT120T -	030	3	1.0		40	2
	040	4	1.5			
	060	6	2.0			
	080	8	2.5			
	100	10	3.0			
	120	12	4.0			
	160	16	5.0			
CCT120T -	030L	3	1.0	100	2	
	040L	4	1.5			
	060L	6	2.0			
	080L	8	2.5			
	100L	10	3.0			
	120L	12	4.0			
	150L	12	4.0			



TFE

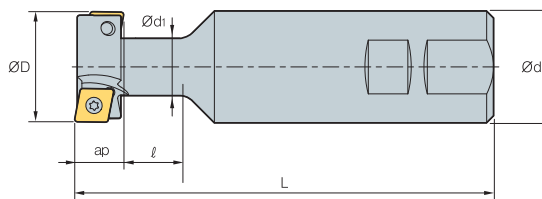

AA
90°

• AR: 5°
• RR: -5°

(mm)

Designation		ØD	Ød	Ød1	ℓ	L	ap	Available inserts	
TFE	2125R/L	2	21	25	10.5	20	109	9	CPMT06
	2525R/L	2	25	25	12.5	21	112	11	CPMT08
	3232R/L	2	32	32	16.5	26	120	14	CPMT09
	4032R/L	2	40	32	20.5	32	130	18	CPMH12
	5032R/L	4	50	32	26.5	38	140	22	CPMH12

Available inserts

CPMT CPMH



Designation	Cermet		Coated											Uncoated			page		
	CN2000	CN30	NCM325	NC5330	NCM535	NCM545	PC2505	PC2510	PC3600	PC3700	PC6510	PC9530	PC9540	PC5300	PC5400	ST30A		G10	H01
CPMT	060204-MM								●										E07
	080308-MM								●										
	09T308-MM								●										
CPMH	120408-MM								●										

Parts

Specification		
	Screw	Wrench
Ø21	FTNA02555	TW08S
Ø25	FTNA0306	TW09S
Ø32	FTNA0407	TW15S
Ø40	PTMA0511A	TW15S
Ø50		

Assembling

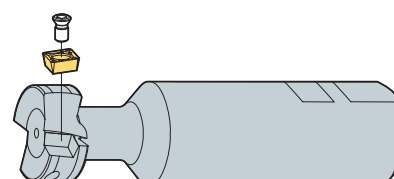

Available inserts E07

E Technical Information for Pro-A Mill

Inserts feature a buffed top surface ensuring better chip control and reducing built-up edge

Pro-A Mill

- Buffed top face of insert ensures good chip control and reduces built-up edge
- Small size modular type for aluminum machining
- Various line up of modular system for aluminum machining
- For shouldering, curved surface and ramping
- High rake angle chip breaker ensures excellent surface roughness, improved cooling effects, and chip control by through coolant system, even in deep pocket machining

Uses

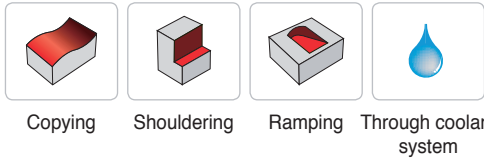

Pro-A Mill series

Type		Available inserts and tool holders	Through coolant system
Application of small-sized Aluminum machining	Pro-A 2000	 <ul style="list-style-type: none"> • Modular: $\varnothing 12\sim\varnothing 42$ • Shank: $\varnothing 12\sim\varnothing 42$ • Insert: VDKT11T210N-MA VDKT11T220N-MA 	○
General application of Aluminum machining	Pro-A 4000	 <ul style="list-style-type: none"> • cutter: $\varnothing 40\sim\varnothing 100$ • Shank: $\varnothing 32\sim\varnothing 40$ • Insert: VCKT220530N-MA 	○

Recommended cutting condition

Workpiece		Cutting speed v_c (m/min)
Aluminum alloy	Rm < 280 MPa	1000
	Rm > 280 MPa	800
Copper alloy	Long chip	250
Thermo plastic	-	300
Aluminum alloy	Si < 12%	800
Copper alloy	Short chip	400
Magnesium alloy	-	400
Duroplastics	-	150



Pro-A Mill ramping & helical cutting technical data

1. Ramping

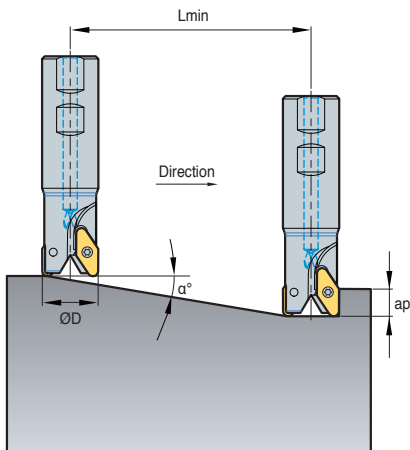

2. Blind hole helical cutting

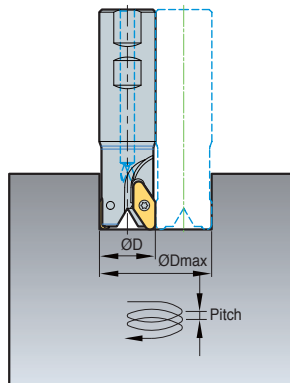

3. Thru hole helical cutting

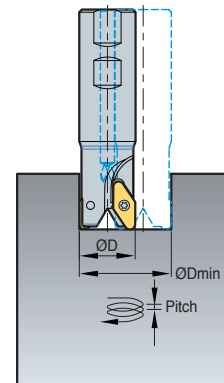

(mm)

Designation	ØD (mm)	Ramping		Blind hole helical cutting				Thru hole helical cutting	
		α° (max)	Lmin (mm)	ØDH Min (mm)	dmax (mm)	ØDH Max (mm)	dmax (mm)	ØDH Min (mm)	dmax (mm)
PAS2012HR	12	11.9	38	21	4.4	23	4.8	19	4.0
PAS2016HR	16	12.5	36	29	6.4	31	6.9	27	6.0
PAS2020HR	20	9.7	47	37	6.3	39	6.7	35	6.0
PAS2025HR	25	7.6	60	47	6.3	49	6.5	45	6.0
PAS2032HR	32	5.8	79	61	6.2	63	6.4	59	6.0
PAS2042HR	42	4.3	105	81	6.2	83	6.3	79	6.0
PAS4032HR	32	24.4	22	54	15.0	59	26.8	40	15.0
PAS4040HR	40	18.4	30	70	15.0	75	25.0	56	15.0
PAS4050HR	50	14.0	40	90	15.0	95	23.8	76	15.0
PAS4063HR	63	10.7	53	116	15.0	121	22.8	102	15.0
PAC(M)4080HR	80	8.1	70	150	15.0	155	22.1	136	15.0
PAC(M)4100HR	100	6.3	90	190	15.0	195	21.7	176	15.0

- Lmin: When ap = 8 mm
- Lmin: Minimum inclination cutting length
- α°: Max. ramping angle
- ap: Depth of cut

$$Lmin = \frac{ap}{\tan \alpha^\circ} \text{ (mm)}$$

E Technical Information for Pro-X Mill

Features a strong clamping provided by the concave grooves on the back surface of the inserts

Pro-X Mill

- Inserts feature a buffed top surface ensuring a smoother chip evacuation and reducing built-up edge
- High rake angle of insert provides good surface finish and low cutting load
- Specially designed for high speed machining of aluminum
- Suitable for square shouldering and curved surface machining

Clamping system for high speed

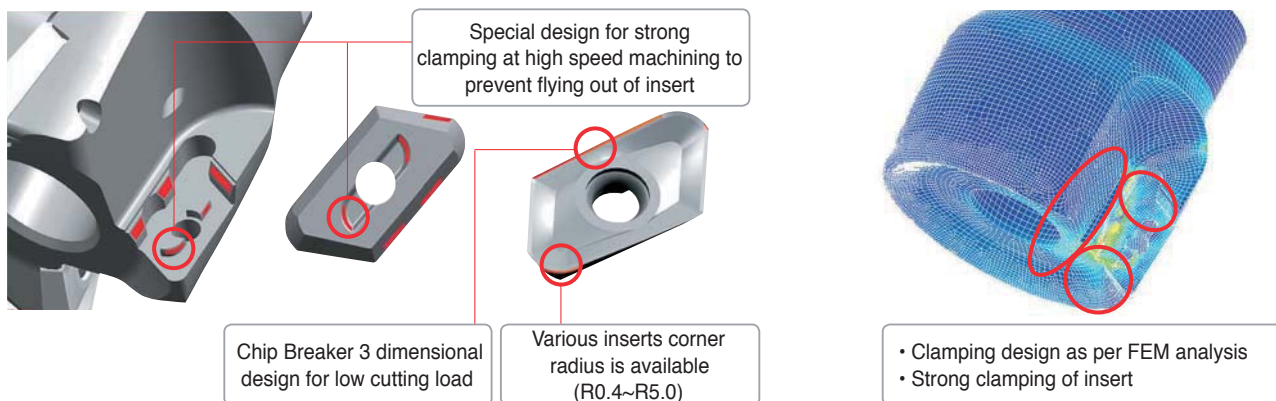

Centrifugal force as per RPM

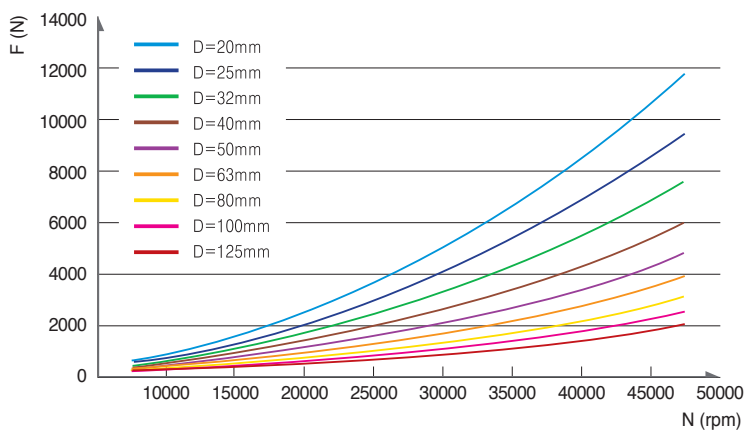

※ Screw Torque = 4 N·m
※ Indexable insert: 6.8g

Marking [· Designation · Max. RPM]



Max. RPM as per cutting diameter

Cutting diameter ØD (mm)	5000 type		6000 type	
	n (min ⁻¹)	vc (m/min)	n (min ⁻¹)	vc (m/min)
20	14,000	879	-	-
25	28,000	2,199	15,000	1,178
32	25,000	2,513	23,000	2,312
40	22,000	2,764	20,000	2,513
50	20,000	3,141	18,000	2,827
63	18,000	3,562	16,000	3,166
80	16,000	4,021	14,000	3,518
100	14,000	4,398	13,000	4,084
125	13,000	5,105	11,000	4,319

Recommended cutting condition

Workpiece		Cutting Speed vc (m/min)	Feed fz (mm/t)
Aluminum alloy	Rm280 < MPa	1200	0.30
	Rm280 > MPa	1000	0.25
Copper alloy Thermo plastic	Long chipping	400	0.20
	-	350	0.15
Aluminum alloy	Si < 12%	1000	0.25
	Si ≥ 12%	300	0.23
Copper alloy	Short chipping	500	0.20
Magnesium alloy	-	450	0.20
Duroplastics	-	200	0.15

※ In case of actual machining accidental breakage of insert or tool could happen even under the written RPM special cover or door is necessary to prevent damage from broken insert or broken tool



Pro-X Mill ramping & helical cutting technical data

1. Ramping

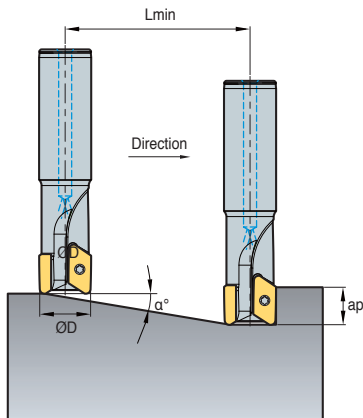

2. Blind hole helical cutting

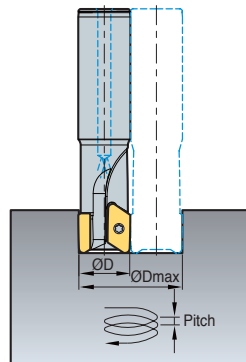

3. Thru hole helical cutting

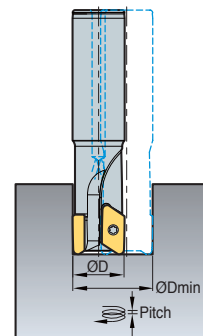

(mm)

Designation	ØD (mm)	Ramping		Blind hole Helical cutting				Thru hole Helical cutting	
		α° (max)	Lmin (mm)	ØDH Min (mm)	dmax (mm)	ØDH Max (mm)	dmax (mm)	ØDH Max (mm)	dmax (mm)
PAXS5020HR	20	8.4	68	32	4.7	34	5.0	27	4.0
PAXS5025HR	25	13.2	43	42	9.9	44	10.4	34	8.0
PAXS5032HR	32	9.5	60	56	9.3	58	9.7	48	8.0
PAXS5040HR	40	7.1	80	72	9.0	74	9.3	64	8.0
PAXCM5050HR	50	5.4	105	92	8.8	94	9.0	84	8.0
PAXCM5063HR	63	4.2	138	118	8.6	120	8.7	110	8.0
PAXC(M)5080HR	80	3.2	180	152	8.4	154	8.6	144	8.0
PAXC(M)5100HR	100	2.5	230	192	8.3	194	8.4	184	8.0
PAXC(M)5125HR	125	2.0	293	242	8.3	244	8.3	234	8.0
PAXS6025HR	25	9.0	63	42	6.6	44	6.9	38	6.0
PAXS6032HR	32	6.6	87	56	6.5	58	6.7	52	6.0
PAXS6040HR	40	12.1	47	72	15.4	74	15.9	56	12.0
PAXCM6050HR	50	9.0	63	92	14.5	94	14.8	76	12.0
PAXCM6063HR	63	6.7	85	118	13.9	120	14.1	102	12.0
PAXC(M)6080HR	80	5.0	113	152	13.4	154	13.6	136	12.0
PAXC(M)6100HR	100	3.9	147	192	13.1	194	13.2	176	12.0
PAXC(M)6125HR	125	3.0	188	242	12.8	244	13.0	226	12.0

• Lmin: When ap = 10mm

• Lmin: Minimum inclination cutting length $Lmin = \frac{ap}{\tan \alpha^\circ}$ (mm)

α°: Max. ramping angle

ap: Depth of cut

Plunging, slotting, drilling technical data

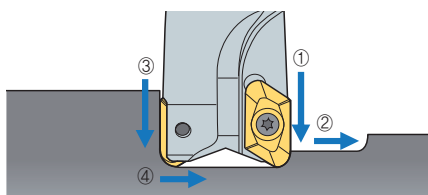

1. When drilling, grooving machining sequence is ① → ② → ③ → ④

2. When drilling, grooving, decrease the feed and cutting speed 30%~50% from the recommended data

• Cutting condition for drilling

Holder	ap (mm)	
	5000 type	6000 type
Ø20	8	-
Ø25	4	11
Ø32	4	6
Ø40~125	4	6

Insert	ap (mm)	
	ap (mm)	
XETK19	4	
XETK25	6	

• Uses

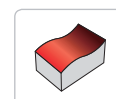

Copying

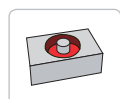

Helical cutting

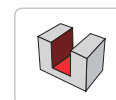

Slotting & Shouldering

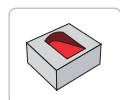

Ramping

E Technical Information for Pro-L Mill

New indexable milling tool for the machining of high quality workpieces

Pro-L Mill

- Improved perpendicularity and lower cutting resistance due to the combined design of the clearance face and high helix edge of these inserts
- Productivity increase due to more than half as much of depth of cut comparing to existing product
- Strong clamping design by adaption of double screw on system
- Improved chip flow due to helical type design of chip pocket and application of coolant system

Uses

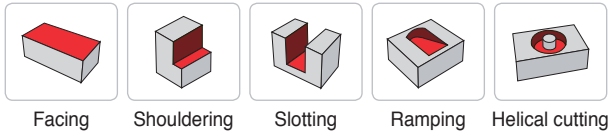

Code system

• Shank type

PAL S 050 H R - 3 S 40

Pro-L Mill	Tool type	Tool Dia.	Coolant type	Hand	No. of tooth	Tool length	Shank Dia.
	S: Shank	050: Ø50	H: Thru-hole Unmarked: None	R: Right M: Multi-edge	3: 3 teeth	S: Standard type M: Middle type L: Long type	40: Ø40

• Cutter type

PAL C M 063 H R

Pro-L Mill	Tool type	Unit	Tool Dia.	Coolant type	Hand
	C: Cutter	M: Metric	063: Ø63	H: Thru-hole Unmarked: None	R: Right M: Multi-edge

Features

- Enhanced chip flow and increased tool life by inner coolant system
- Strong clamping by 2 screw on system
- Set of various Nose-R
- Improved perpendicularity and decreased cutting resistance due to application of high helix

Features of chip breakers

Insert	Cutting-edge	Uses	Features
MA		Al	Edge optimized for aluminum machining and buffed finish ensuring an excellent machining quality
ML		Hard-to-cut material	Design of low cutting resistance chip breaker ensures excellent machining quality for light cutting and hard-to-cut material



➤ Selection of grades and chip breaker

Category	M (Stainless steel)	N (Aluminum alloy)	S (HRSA)
Grades	PC5300/PC5400	H01	PC5300/PC5400
MA	-	○	-
ML	○	-	○

➤ Application examples

Al6061 (H_RC30)

■ Cutting condition

vc = 500 m/min, fz = 0.2 mm/t,
 ap = 30~60 mm,
 ae = 1~5 mm (finishing: 1 mm, roughing: 5 mm)
 z = 3



➤ Pro-L Mill ramping & helical cutting technical data

1. Ramping

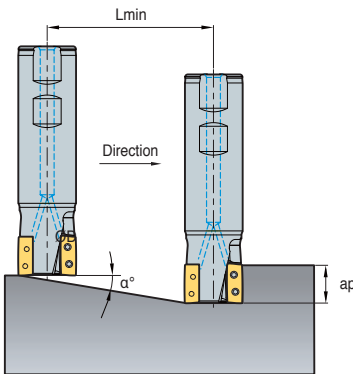

2. Blind hole helical cutting

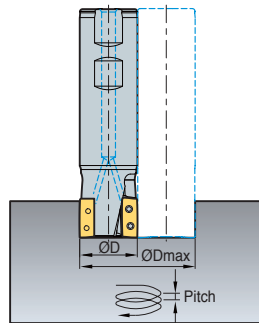

3. Thru hole helical cutting

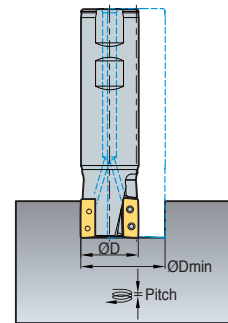

(mm)

Designation	ØD (mm)	Ramping		Blind hole helical cutting				Thru hole helical cutting	
		α° (max)	Lmin (mm)	ØDH Min (mm)	dmax (mm)	ØDH Max (mm)	dmax (mm)	ØDH Min (mm)	dmax (mm)
PALS032HR-2S20	32	3.37	170	60	3.5	62	3.6	55	3.2
PALS032HR-2S25	32	3.37	170	60	3.5	62	3.6	55	3.2
PALS032HR-2S32	32	3.37	170	60	3.5	62	3.6	55	3.2
PALS040HR-2S32	40	2.12	270	76	2.8	78	2.9	71	2.6
PALS040HR-2S40	40	2.12	270	76	2.8	78	2.9	71	2.6
PALS040HR-2S42	40	2.12	270	76	2.8	78	2.9	71	2.6
PALS040HR-3S32	40	2.12	270	76	2.8	78	2.9	71	2.6
PALS040HR-3S40	40	2.12	270	76	2.8	78	2.9	71	2.6
PALS040HR-3S42	40	2.12	270	76	2.8	78	2.9	71	2.6
PALS050HR-3S32	50	2.08	275	96	3.5	98	3.6	91	3.3
PALS050HR-3S40	50	2.08	275	96	3.5	98	3.6	91	3.3
PALS050HR-3S42	50	2.08	275	96	3.5	98	3.6	91	3.3
PALS063HR-4S32	63	1.76	325	122	3.8	124	3.8	117	3.6
PALS063HR-4S40	63	1.76	325	122	3.8	124	3.8	117	3.6
PALS063HR-4S42	63	1.76	325	122	3.8	124	3.8	117	3.6
PALS063HM-4S32	63	1.76	325	122	3.8	124	3.8	117	3.6
PALS063HM-4S40	63	1.76	325	122	3.8	124	3.8	117	3.6
PALS063HM-4S42	63	1.76	325	122	3.8	124	3.8	117	3.6
PALCM063HR	63	1.76	325	122	3.8	124	3.8	117	3.6

• Lmin: When ap = 10 mm

• Lmin: Minimum inclination cutting length $Lmin = \frac{ap}{\tan \alpha^\circ}$ (mm)

α° : Max. ramping angle

ap : Depth of cut

E Technical Information for Pro-XL Mill

Deep cutting milling tools to maximize productivity in aluminum machining

Pro-XL Mill **new**

- **Productivity** - Cutting time is shortened by finishing the process with a single pass of deep shouldering in aluminum machining
- **High quality** - Shouldering within a single pass enables walls with perfect perpendicularity
- **Clamping stability** - Two-Screw On system secures clamping stability

Features of Pro-XL Mill

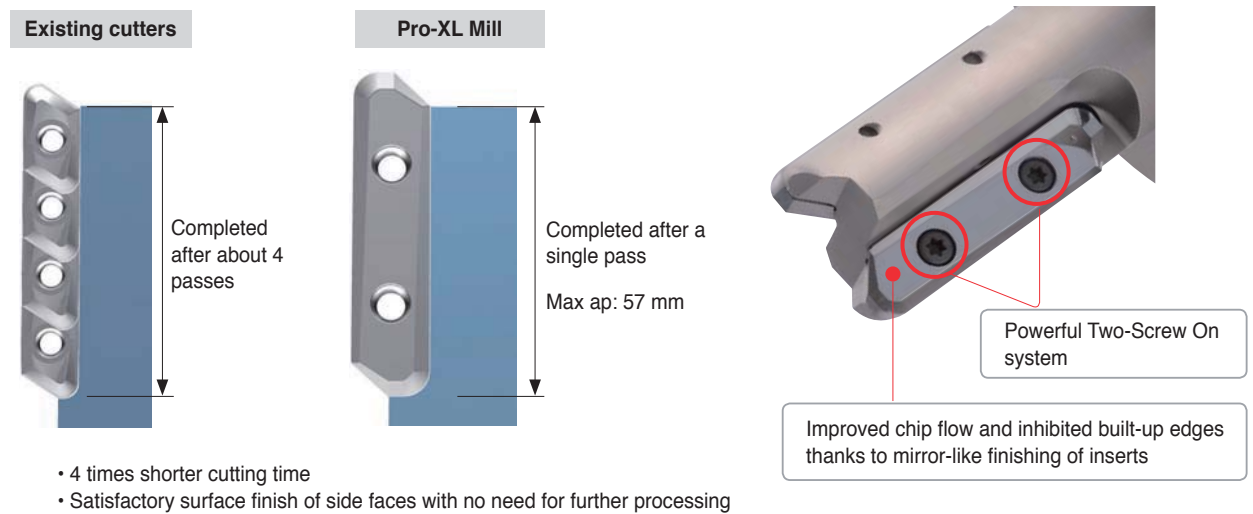

Application examples

Al7075

■ Cutting condition

$vc = 500 \text{ m/min}$, $fz = 0.25 \text{ mm/t}$
 $ap = 56 \text{ mm}$, $ae = 1 \text{ mm}$
 $z = 2$

■ Tools

Insert LDET650550PPFR-MA
Grades H01
Holder BT50-PXL04090HR-2F ($\varnothing D = 40 \text{ mm}$)



The Premium High-Speed Milling Tool for Aluminum

Pro-V Mill **new**

- **Enhanced productivity**- Increased productivity due to high speed capability
- **Improved surface finish**- Excellent surface finish and perpendicularity with high-precision products
- **Excellent clamping stability**- Satisfactory clamping force of inserts by the use of the key shape

➤ Code system

• Shank type

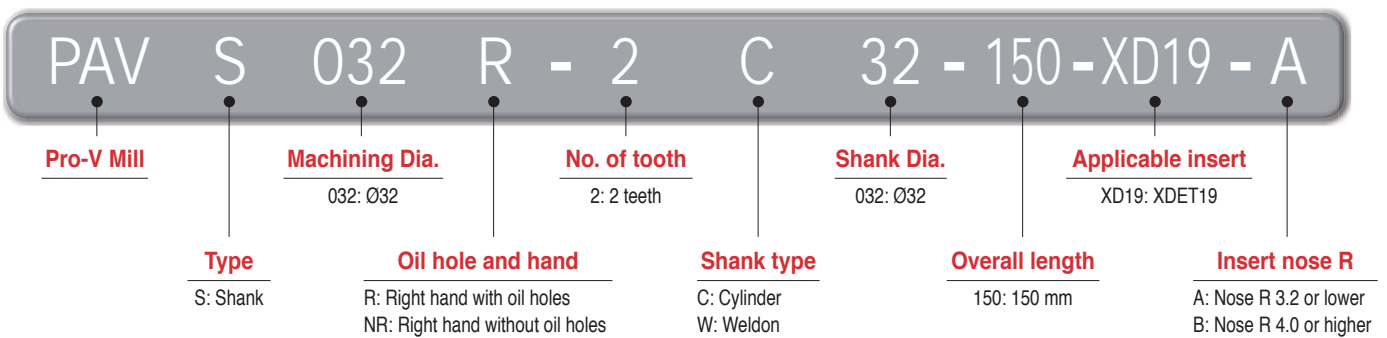

• Cutter Type

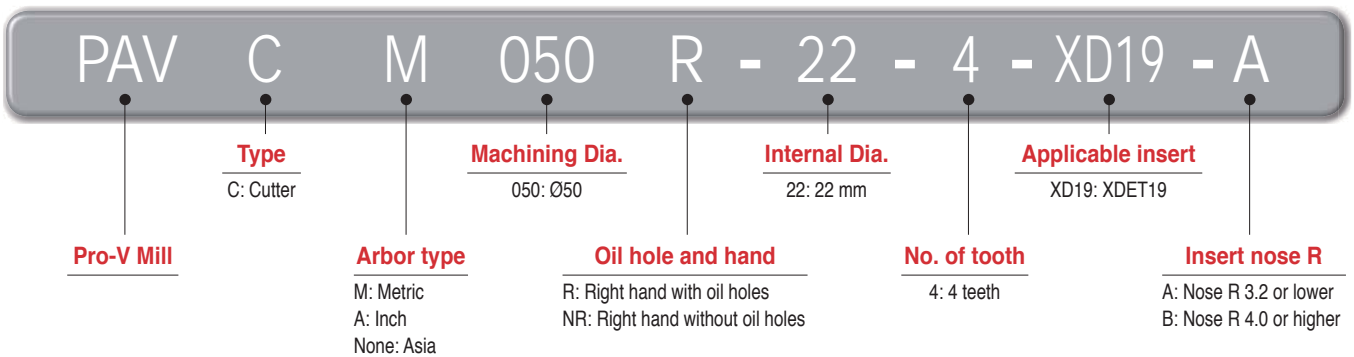

• Tooling System

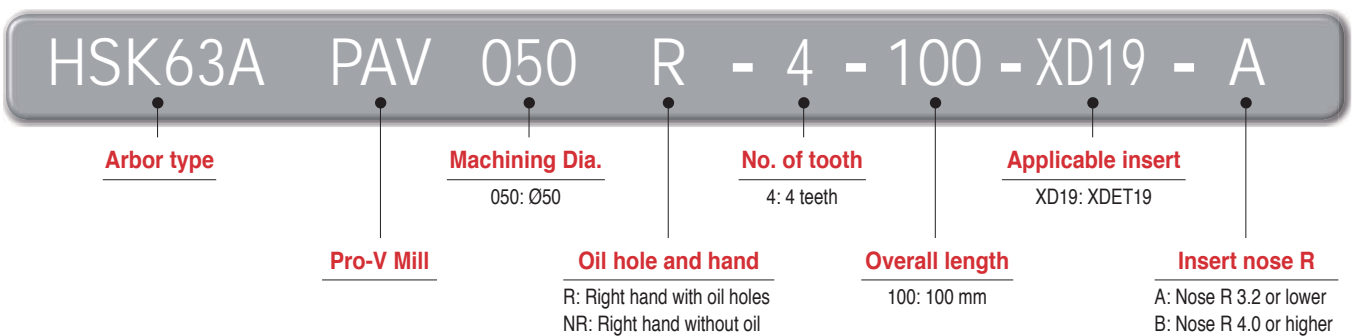

E Technical Information for Pro-V Mill

➤ Cutter Features

- The combined clamping system of the key to key slot structure and simple screw-on type ensures strong clamping force
 - Stable machining / prevention of insert breakage
- Avoiding uplifting problems of insert due to axial acute-angle clamping of cutters
 - Reduced vibrations and excellent surface finish



➤ Insert Features

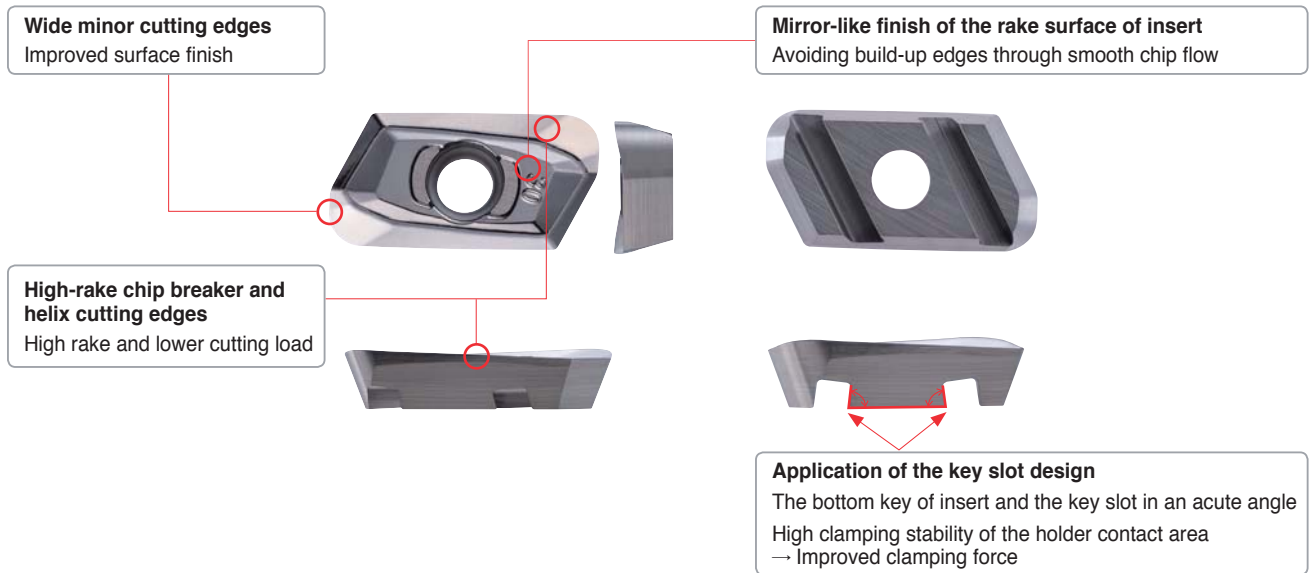

➤ Features of chip breaker

Insert	Cutting-edge	Uses	Features
MA		For non-ferrous metals	Ensuring satisfactory machining quality with the application of mirror-like cutting edges optimized for aluminum machining



Recommended cutting condition

Workpiece		Grade	vc (m/min)	Max. ap (mm)	
N	Aluminum	Si ≤ 5% (Si Lower than 5%)	H01	1,300 (500 - 2,200)	17
			H05	1,000 (300 - 1,700)	
			PD1005	1,500 (500 - 3,000)	
		Si ≤ 10% (Si Lower than 10%)	PD1010	1,200 (300 - 2,200)	

* The recommended cutting conditions above are a general guideline. Their details may vary depending on the machining method of users and other conditions.

Application area

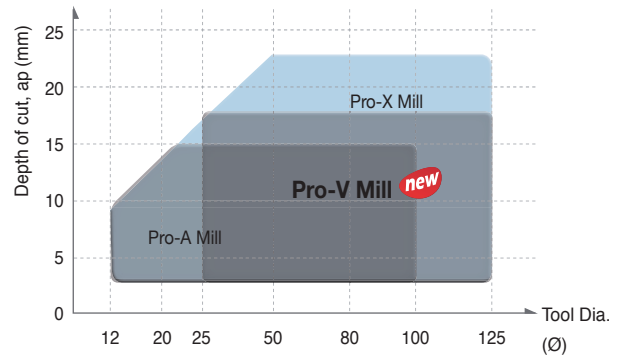
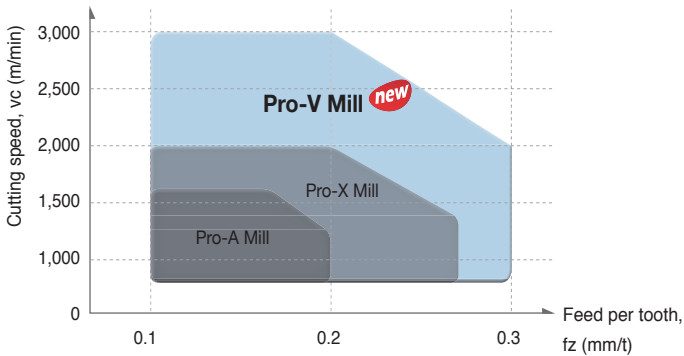

Pro-V Mill ramping & helical cutting technical data

1. Ramping

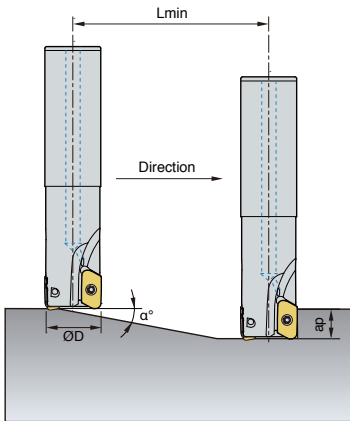

2. Blind hole helical cutting

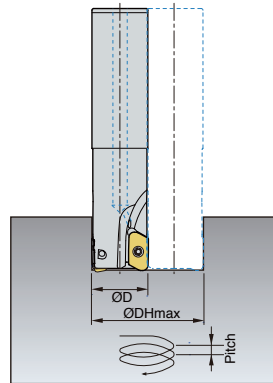

3. Thru hole helical cutting

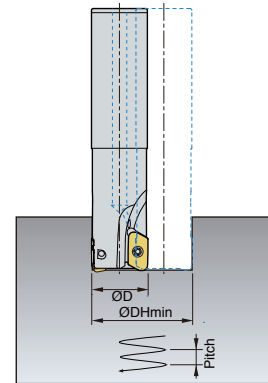

ØD (mm)	Ramping		Blind hole helical cutting				Thru hole helical cutting	
	α° (max)	Lmin (mm)	ØDH Min (mm)	dmax (mm)	ØDH Max (mm)	dmax (mm)	ØDH Min (mm)	dmax (mm)
25	15.0	59	41	13.0	44	15.5	27	2.0
32	10.0	99	55	11.0	58	12.5	41	4.5
40	7.0	142.5	71	10.5	74	11.5	57	6.0
50	5.0	200	91	10.0	94	10.5	77	6.5
63	3.5	286	117	9.2	120	9.5	103	7.0
80	2.6	385	151	9.0	154	9.5	137	7.3
100	2.0	501	191	9.0	194	9.0	177	7.6
125	1.5	668	241	8.5	244	8.5	227	7.5

- When ramping and helical milling, table feed, vf (mm/min) should be lower than 70% of the recommended cutting conditions.
- When helical milling, Max. pitch, DHmax should be lower than max. depth of cut, ap.
- When ramping, the depth of cut should be lower than max. depth of cut, ap.

- Lmin: $ap/\tan(\alpha^\circ)$ (mm)
- Lmin: Minimum inclination cutting length
- α° : Max. ramping angle
- ap: Depth of cut

PAC(M)2000/4000

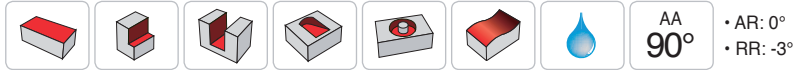
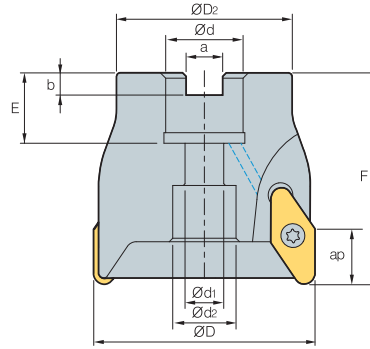

AA
90°
• AR: 0°
• RR: -3°

(mm)

Designation	ØD	ØD2	Ød	Ød1	Ød2	a	b	E	F	ap	$\frac{m}{kg}$		
PACM	2040HR	3	40	34	16	9	14	8.4	5.6	18	40	8.7	0.2
	2050HR	4	50	42	22	11	18	10.4	6.3	22	50	8.7	0.4
	2063HR	5	63	49	22	11	18	10.4	6.3	22	50	8.7	0.6
	2080HR	5	80	57	27	14	20	12.4	7.0	25	50	8.7	0.9
	2100HR	6	100	67	32	18	26	14.4	8.0	30	63	8.7	1.9
	4040HR	3	40	32	16	9	11.5	8.4	5.6	20	55	15	0.2
	4050HR	3	50	40	22	11	18	10.4	6.3	20	55	15	0.3
	4063HR	4	63	50	22	11	18	10.4	6.3	20	60	15	0.6
	4080HR	4	80	60	27	14	20	12.4	7.0	25	60	15	1.0
	4100HR	5	100	80	32	18	26	14.4	8.0	26	60	15	1.6
PAC	2080HR	5	80	57	25.4	14	20	9.5	6.0	25	50	8.7	0.9
	2100HR	6	100	67	31.75	-	44	12.7	8.0	37	63	8.7	1.9
	4080HR	4	80	60	25.4	14	20	9.5	6.0	25	60	15	1.0
	4100HR	5	100	80	31.75	-	44	12.7	8.0	37	60	15	1.6

Available inserts

VCKT-MA



Designation	Cermet		Coated										Uncoated			page			
	CN2000	CN30	NCM325	NC5330	NCM535	NCM545	PC2505	PC2510	PC3600	PC3700	PC6510	PC9530	PC9540	PC5300	PC5400		ST30A	G10	H01
VCKT 220530N-MA																		●	E27

Available arbors

Designation	Ød	Available arbors	Designation	Ød	NC arbors		
PACM	2040HR	16	BT□□-FMC16-□□	PACM	4040HR	16	BT□□-FMC16-□□
	2050HR	22	BT□□-FMC22-□□		4050HR	22	BT□□-FMC22-□□
	2063HR	22	BT□□-FMC22-□□		4063HR	22	BT□□-FMC22-□□
PAC	2080HR	25.4	BT□□-FMC25.4-□□	PAC	4080HR	25.4	BT□□-FMC25.4-□□
		27	BT□□-FMC27-□□			27	BT□□-FMC27-□□
	2100HR	31.75	BT□□-FMC31.75-□□		4100HR	31.75	BT□□-FMC31.75-□□
32		BT□□-FMC32-□□	32	BT□□-FMC32-□□			

Parts

Specification	Screw	Wrench	Arbor Bolt
Ø40~Ø100	FTNC04509(Ø40) FTNC04511	TW 20S	PHMA0834(Ø40)

Available inserts E27 Available arbors and bolt E400~E402



PAS2000/4000

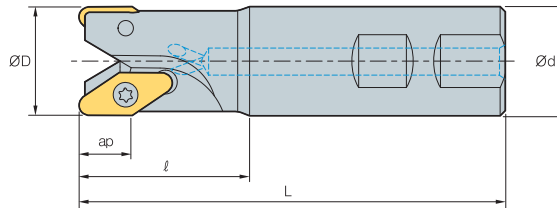

AA **90°**
 • AR: 0°~7°
 • RR: -21°~-3°

(mm)

Designation		ØD	Ød	ℓ	L	ap	
PAS	2012HR	1	12	16	25	85	0.1
	2016HR	2	16	16	25	90	0.11
	* 2016HR-R2.0	2	16	16	25	90	0.11
	2020HR	2	20	20	30	100	0.2
	* 2020HR-R2.0	2	20	20	30	100	0.2
	2025HR	3	25	25	35	115	0.36
	2032HR	4	32	32	40	125	0.66
	2042HR	5	42	32	42	130	0.84
	4032HR	2	32	32	50	125	0.6
	4040HR	3	40	32	50	140	0.8
	4040HR-S40	3	40	40	60	150	1.2
	4040HR-S42	3	40	42	60	150	1.2

Holders marked with an asterisk (*) are only for VDKT11T220N-MA.

Available inserts

VDKT-MA VCKT-MA



Type	Designation	Cermet		Coated										Uncoated			page		
		CN2000	CN30	NCM325	NC5330	NCM535	NCM545	PC2505	PC2510	PC3600	PC3700	PC6510	PC9530	PC9540	PC5300	PC5400		ST30A	G10
2000 type	VDKT 11T210N-MA																		●
	VDKT 11T220N-MA																		●
4000 type	VCKT 220530N-MA																		●

E27

Parts

Specification		
Ø12~Ø42 (2000 type)	ETNA02505*	TW 07S
	ETNA02506	
Ø32~Ø40 (4000 type)	FTNC04509	TW 20S

Available inserts E27

* For PAS2012-2016

PAM2000

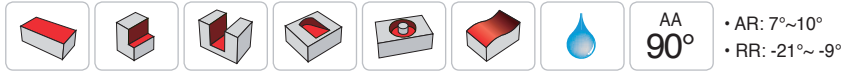
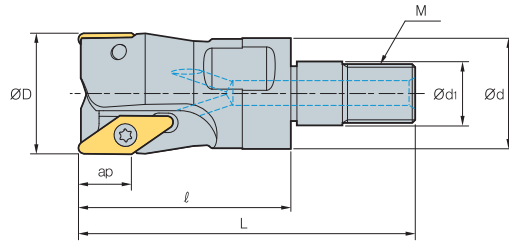

(mm)

Designation		ØD	Ød	Ød ₁	ℓ	L	M	ap	
PAM	2012HR-M06	1	12	11.0	6.5	33	M06	8	0.02
	2016HR-M08	2	16	14.5	8.5	36	M08	8	0.04
	2020HR-M10	2	20	18.0	10.5	36	M10	8	0.06
	2025HR-M12	3	25	22.5	12.5	41	M12	8	0.1
	2032HR-M16	4	32	28.5	17.0	45	M16	8	0.18
2042HR-M16	5	42	28.5	17.0	45	M16	8	0.27	

Available inserts

VDKT-MA



Designation	Cermet		Coated											Uncoated			page		
	CN2000	CN80	NCM325	NC5330	NCM535	NCM545	PC2505	PC2510	PC3600	PC3700	PC6510	PC9530	PC9540	PC5300	PC5400	ST30A		G10	H01
VDKT 11T210N-MA																		●	E27

Available adaptors

Designation	Available adaptors	
PAM	2012HR-M06	MAT-M06
	2016HR-M08	MAT-M08
	2020HR-M10	MAT-M10
	2025HR-M12	MAT-M12
	2032HR-M16	MAT-M16
	2042HR-M16	MAT-M16

Designation: PAM2012HR-M06
Modular head threading measure size (M06)

||

Adaptor spec.: MAT-M06-030-S20S
Adaptor threading measure (M06)

Parts

Specification		
Ø12~Ø42	ETNA02505* ETNA02506	TW 07S

* For PAS2012-2016

Available inserts E27 Available adaptors E371~E372



PAXC(M)5000

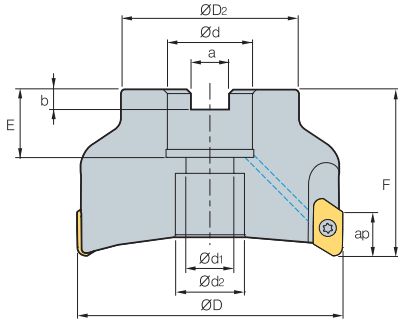

AA 90°

- AR: 8°~17.5°
- RR: -9.5°~-5°

(mm)

Designation		ØD	ØD2	Ød	Ød1	Ød2	a	b	E	F	Max rpm	ap		
PAXCM	5040HR-A,B	3	40	34	16	9	14	8.4	5.6	19	40	25,800	17	0.15
	5050HR-A,B	4	50	42	22	11	18	10.4	6.3	21	50	23,000	17	0.3
	5063HR-A,B	5 (4)	63	49	22	11	18	10.4	6.3	21	50	20,500	17	0.56
PAXC	5080HR-A,B	5	80	57	25.4 (27)	14	20	9.5 (12.4)	6 (7)	2 4(23)	50	18,200	17	1.0
(PAXCM)	5100HR-A,B	6	100	67	31.75 (32)	18	26	12.7 (14.4)	8(8)	32 (26)	63	16,300	17	2.3
	5125HR-A,B	7	125	87	38.1 (40)	22	32	15.9 (16.4)	10 (9)	35 (29)	63	14,600	17	3.2

• A type: Insert NoseR 0.4~3.2, B type: Insert NoseR 4.0~5.0 ()Metric size

Available inserts

XEKT-MA XEKT-ML



Designation	Cermet			Coated						Uncoated			page	Designation	Cermet			Coated						Uncoated			page		
	CN2000 CN30	NC5330 CN30	NC5330 CN30	NCM535 NCM545	PC2505 PC2510	PC3700 PC6510	PC9530 PC9540	PC5300 PC5400	PD2000 PD1010	ST300A G10 H01 H05	page	CN2000 CN30			NC5330 CN30	NCM535 NCM545	PC2505 PC2510	PC3700 PC6510	PC9530 PC9540	PC5300 PC5400	PD2000 PD1010	ST300A G10 H01 H05	page						
XEKT 19M504FR-MA													●●	●●															
19M508FR-MA														●●	●●														
19M512FR-MA														●●	●●														
19M516FR-MA															●●														
19M518FR-MA																●●													
19M520FR-MA																	●●												
19M530FR-MA																		●●											
19M532FR-MA																			●●										
19M540FR-MA																				●●									
19M550FR-MA																					●●								
XEKT 19M504ER-ML																													
19M508ER-ML																													
19M512ER-ML																													
19M516ER-ML																													
19M518ER-ML																													
19M520ER-ML																													
19M530ER-ML																													
19M532ER-ML																													
19M540ER-ML																													
19M550ER-ML																													

Available arbors

Designation	Ød	Available arbors
PAXCM	5040HR-A,B	BT□□-FMC16-□□
	5050HR-A,B	BT□□-FMC22-□□
	5063HR-A,B	
PAXC (PAXCM)	5080HR-A,B	BT□□-FMA25.4-□□
	5100HR-A,B	BT□□-FMC27-□□
		BT□□-FMA31.75-□□
	5125HR-A,B	BT□□-FMC32-□□
BT□□-FMA38.1-□□		
	40	BT□□-FMC40-□□

Parts

Specification	Screw	Wrench
Ø40~Ø125	PTKA0408	TW 15S

Available inserts E29 Available arbors and bolt E400~E402

PAXS5000

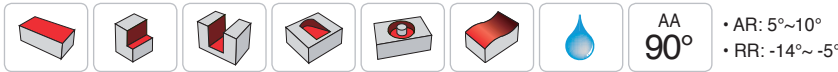
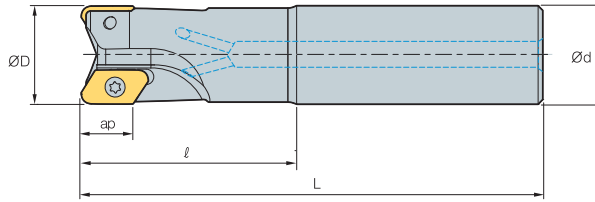

Designation		⊚	ØD	Ød	ℓ	L	Max rpm	ap	⚖ (mm)
PAXS	5020HR-A,B	1	20	20	60	130	15,000	17	0.24
	5025HR-A,B	2	25	25	60	140	32,600	17	0.4
	5025HR-A,B-L200	2	25	25	60	200	32,600	17	0.63
	5032HR-A,B	2	32	32	70	150	28,800	17	0.74
	5032HR-A,B-L220	2	32	32	70	220	28,800	17	1.2
	5040HR-A,B-S32	3	40	32	70	160	25,800	17	1.0
	5040HR-A,B-L220	3	40	32	70	220	25,800	17	1.4
	5040HR-A,B-S40	3	40	40	70	160	25,800	17	1.3
	5040HR-A,B-S42	3	40	42	70	160	25,800	17	1.4

• A type: Insert NoseR 0.4~3.2, B type: Insert NoseR 4.0~5.0

Available inserts

XEKT-MA XEKT-ML



Designation	Cermat			Coated						Uncoated			page	Designation	Cermat			Coated						Uncoated			page												
	CN2000	CN30	NC5330	NCM535	NCM545	PC2505	PC22510	PC3700	PC6510	PC9530	PC9540	PC5300			PD2000	PD1010	ST30A	G10	H01	H05	CN2000	CN30	NC5330	NCM535	NCM545	PC2505		PC22510	PC3700	PC6510	PC9530	PC9540	PC5300	PD2000	PD1010	ST30A	G10	H01	H05
XEKT 19M504FR-MA												••				••																							
19M508FR-MA												••				••																							
19M512FR-MA												••				••																							
19M516FR-MA												•				••																							
19M518FR-MA												•				••																							
19M520FR-MA												••				••																							
19M530FR-MA												•				••																							
19M532FR-MA												••				••																							
19M540FR-MA												••				••																							
19M550FR-MA												••				••																							
XEKT 19M504ER-ML																																							
19M508ER-ML																																							
19M512ER-ML																																							
19M516ER-ML																																							
19M518ER-ML																																							
19M520ER-ML																																							
19M530ER-ML																																							
19M532ER-ML																																							
19M540ER-ML																																							
19M550ER-ML																																							

Parts

Specification		
Ø20	PTKA0407	TW 15S
Ø25~Ø40	PTKA0408	

Available inserts E29

PAXS6000

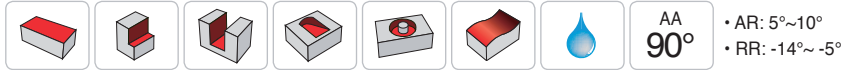
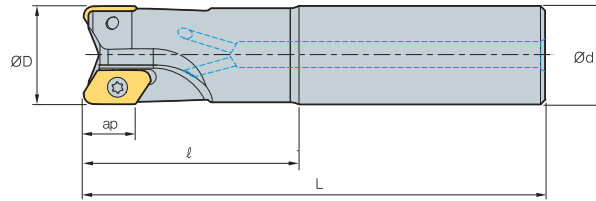

(mm)

Designation		ØD	Ød	l	L	Max rpm	ap	
PAXS 6025HR-A,B	1	25	25	60	140	32,600	23	0.42
6025HR-A,B-L200	1	25	25	60	200	32,600	23	0.63
6032HR-A,B	1	32	32	70	150	28,800	23	0.72
6032HR-A,B-L220	1	32	32	70	220	28,800	23	1.14
6040HR-A,B-S32	2	40	32	70	160	25,800	23	0.88
6040HR-A,B-L220	2	40	32	70	220	25,800	23	1.23
6040HR-A,B-S40	2	40	40	70	160	25,800	23	1.2
6040HR-A,B-S42	2	40	42	70	160	25,800	23	1.3

• A type: Insert NoseR 0.4~3.2, B type: Insert NoseR 4.0~5.0

Available inserts

XEKT-MA XEKT-ML



Designation	Cement										page	Designation	Cement										page				
	CN2000	CN30	NCM325	NC5330	NCM535	NCM545	PC2505	PC2510	PC3600	PC3700			PC6510	PC9530	PC9540	PC5300	PC5400	ST30A	G10	H01	H05	ST30A		G10	H01	H05	
XEKT 250604FR-MA																											
250608FR-MA																											
250612FR-MA																											
250616FR-MA																											
250620FR-MA																											
250630FR-MA																											
250632FR-MA																											
250640FR-MA																											
250650FR-MA																											
XEKT 250604ER-ML																											
250608ER-ML																											
250612ER-ML																											
250616ER-ML																											
250620ER-ML																											
250630ER-ML																											
250632ER-ML																											
250640ER-ML																											
250650ER-ML																											

Parts

Specification		
Ø25~Ø32	FTGA0510-P	TW 20-100
Ø40	FTGA0513-P	

Available inserts E29



PAXM5000

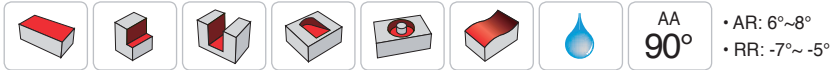
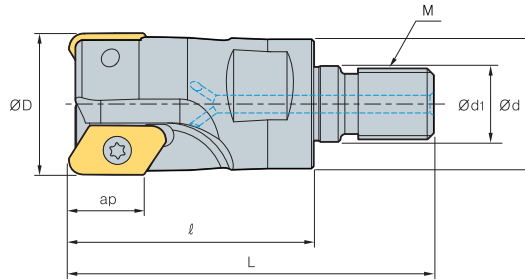

Designation		ØD	Ød	Ød ₁	l	L	M	ap	
PAXM 5025HR-A,B-M12	2	25	23	12.5	55	79	M12	17	0.12
5032HR-A,B-M16	2	32	29	17.0	55	82	M16	17	0.2
5040HR-A,B-M16	3	40	29	17.0	55	82	M16	17	0.4

• A type: Insert NoseR 0.4~3.2, B type: Insert NoseR 4.0~5.0

Available inserts

XEKT-MA XEKT-ML



Designation	Cement										page	Designation	Cement										page																												
	CN2000	CN30	NC5380	NCM535	NCM545	PC2505	PC2510	PC3700	PC6510	PC9530			PC9540	PC5300	PC5400	PD2000	PD1010	ST30A	G10	H01	H05	ST30A		G10	H01	H05																									
XEKT 19M504FR-MA												●	●													XEKT 19M504ER-ML																									
19M508FR-MA												●	●														19M508ER-ML																								
19M512FR-MA												●	●													19M512ER-ML																									
19M516FR-MA												●	●													19M516ER-ML																									
19M518FR-MA																										19M518ER-ML																									
19M520FR-MA												●	●													19M520ER-ML																									
19M530FR-MA												●	●													19M530ER-ML																									
19M532FR-MA												●	●													19M532ER-ML																									
19M540FR-MA												●	●													19M540ER-ML																									
19M550FR-MA												●	●													19M550ER-ML																									

Available adaptor

Designation	Available adaptor
PAXM 5025HR-A,B-M12	MAT-M12
5032HR-A,B-M16	MAT-M16
5040HR-A,B-M16	

Designation: PAXM5025HR-M12
Modular head threading measure size (M12)

II

Adaptor spec.: MAT-M12-030-S25S
Adaptor threading measure (M12)

Parts

Specification		
Ø25~Ø40	PTKA0408	TW 15S

Available inserts E29 Available adaptors E371~E372

HSK63A/100A PAX5000

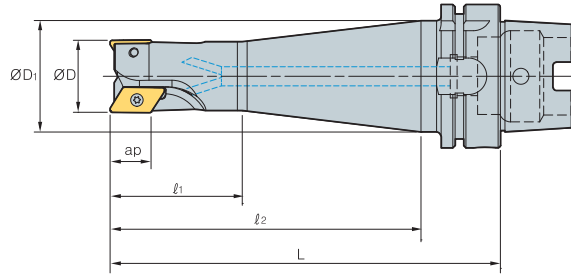

AA
90°
• AR: 5°~17.5°
• RR: -14°~-5°

(mm)

Designation		$\varnothing D$	$\varnothing D_1$	l_1	l_2	L	ap	
HSK63A PAX5032HR-A, B	2	32	53	58	137	163	17	1.14
HSK100A PAXCM5080HR-A, B	5	80	-	-	66	95	17	4
PAXCM5100HR-A, B	6	100	-	-	66	95	17	4.6

- A type: Insert NoseR 0.4~3.2, B type: Insert NoseR 4.0~5.0
- For the maximum rake angle and the rpm limit, please refer to technical information on pp. E346~E347.

Available inserts

XEKT-MA XEKT-ML



Designation	Cement										page	Designation	Cement										page																		
	CN2000	CN30	NC5330	NCM535	NCM545	PC2505	PC2510	PC3700	PC6510	PC9530			PC9540	PC5300	PC5400	PD2000	PD1010	ST30A	G10	H01	H05																				
XEKT 19M504FR-MA											●	●						●	●	E29	XEKT 19M504ER-ML																				E29
19M508FR-MA											●	●						●	●		19M508ER-ML																				
19M512FR-MA											●	●						●	●		19M512ER-ML																				
19M516FR-MA											●	●						●	●		19M516ER-ML																				
19M518FR-MA											●	●						●	●		19M518ER-ML																				
19M520FR-MA											●	●						●	●		19M520ER-ML																				
19M530FR-MA											●	●						●	●		19M530ER-ML																				
19M532FR-MA											●	●						●	●		19M532ER-ML																				
19M540FR-MA											●	●						●	●		19M540ER-ML																				
19M550FR-MA											●	●						●	●		19M550ER-ML																				

Parts

Specification		
$\varnothing 32\sim\varnothing 100$	PTKA0407 PTKA0408	TW 15S

Available inserts E29



PALCM

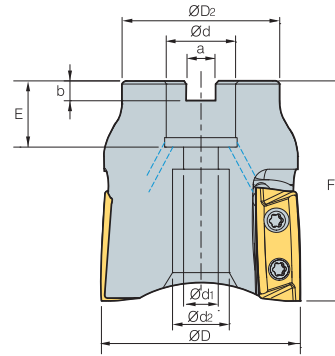

Designation		ØD	ØD ₂	Ød	Ød ₁	Ød ₂	a	b	E	F	ap	
PALCM 063HR	4	63	50	22	11	21	10	6.3	20	70	34	0.57

(mm)

Available inserts

LXET-MA LXET-ML



Designation	Cermet		Coated											Uncoated			page	
	CN2000	CN30	NCM325	NC5330	NCM535	NCM545	PC2505	PC2510	PC3600	PC3700	PC6510	PC9530	PC9540	PC5300	PC5400	ST30A		G10
LXET 340504PEFR-63-MA																		
3405PEFR-63-MA																		●
340512PEFR-63-MA																		
340516PEFR-63-MA																		
340504PEER-63-ML																		
3405PEER-63-ML																		
340512PEER-63-ML																		
340516PEER-63-ML																		

E12

Available arbors

Designation	Ød	Available arbors
PALCM 063HR	22	BT□□-FMC22-□□

Parts

Specification		
Ø63	FTGA0511-P	TW20-100

Available inserts E12 Available arbors and bolt E400~E402

PALS (Single-edge)

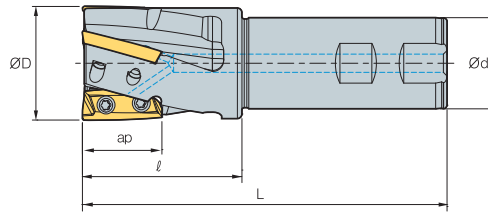

Designation			ØD	Ød	l	L	ap	
PALS	032HR-2S20	2	32	20	50	140	25	0.36
	032HR-2S25	2	32	25	50	140	25	0.48
	032HR-2S32	2	32	32	50	140	25	0.71
	040HR-2S32	2	40	32	50	140	25	0.85
	040HR-2S40	2	40	40	50	140	25	1.16
	040HR-2S42	2	40	42	50	140	25	1.26
	040HR-3S32	3	40	32	50	140	25	0.80
	040HR-3S40	3	40	40	50	140	25	1.10
	040HR-3S42	3	40	42	50	140	25	1.20

Available inserts

LXET-MA LXET-ML



Type	Designation	Cermet		Coated											Uncoated			page				
		CN2000	CN30	NCM325	NC5330	NCM535	NCM545	PC2505	PC2510	PC3600	PC3700	PC6510	PC9530	PC9540	PC5300	PC5400	ST30A		G10	H01		
Ø32	LXET 250404PEFR-32-MA																					
	2504PEFR-32-MA																				●	
	250412PEFR-32-MA																					
	250416PEFR-32-MA																					
	250404PEER-32-ML																					
	2504PEER-32-ML																					
	250412PEER-32-ML																					
	250416PEER-32-ML																					
Ø40	LXET 250404PEFR-40-MA																					
	2504PEFR-40-MA																					
	250412PEFR-40-MA																					
	250416PEFR-40-MA																					
	250404PEER-40-ML																					
	2504PEER-40-ML																					
	250412PEER-40-ML																					
	250416PEER-40-ML																					

Parts

Specification		
Ø32	FTKA0408	TW15S
Ø40	FTKA0410	TW15S



PALS (Single-edge)

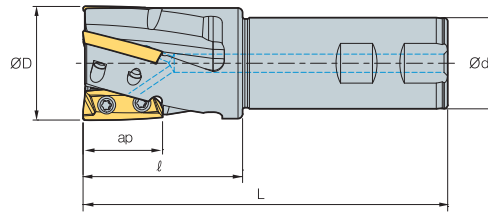

Designation			ØD	Ød	l	L	ap	
PALS	050HR-3S32	3	50	32	70	160	34	1.10
	050HR-3S40	3	50	40	70	160	34	1.40
	050HR-3S42	3	50	42	70	160	34	1.50
	063HR-4S32	4	63	32	70	160	34	1.60
	063HR-4S40	4	63	40	70	160	34	1.92
	063HR-4S42	4	63	42	70	160	34	2.00

(mm)

Available inserts

LXET-MA LXET-ML



Type	Designation	Cermet		Coated										Uncoated			page		
		CN2000	CN30	NCM325	NC5330	NCM535	NCM545	PC2505	PC2510	PC3600	PC3700	PC6510	PC9530	PC9540	PC5300	PC5400		ST30A	G10
Ø50	LXET 340504PEFR-50-MA																		●
	3405PEFR-50-MA																		●
	340512PEFR-50-MA																		
	340516PEFR-50-MA																		
	340504PEER-50-ML																		
	3405PEER-50-ML														●				
	340512PEER-50-ML																		
340516PEER-50-ML																			
Ø63	LXET 340504PEFR-63-MA																		
	3405PEFR-63-MA																		●
	340512PEFR-63-MA																		
	340516PEFR-63-MA																		
	340504PEER-63-ML																		
	3405PEER-63-ML																		
	340512PEER-63-ML																		
340516PEER-63-ML																			

Parts

Specification		
Ø50	FTGA0510-P	TW20-100
Ø63	FTGA0511-P	TW20-100

Available inserts E12

PALS (Multi-edge)

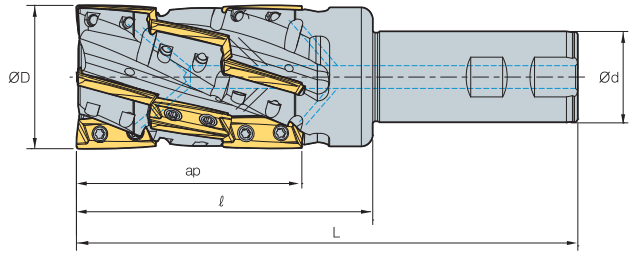

AA
90°
• AR: 16°
• RR: -8°

(mm)

Designation		Ød	Ød1	l	L	ap	
PALS	063HM-4S32	12	63	32	130	220	1.60
	063HM-4S40	12	63	40	130	220	1.92
	063HM-4S42	12	63	42	130	220	2.00

Available inserts

LXET-MA LXET-ML



Designation	Cermet		Coated										Uncoated			page			
	CN2000	CN30	NCM325	NC5330	NCM635	NCM545	PC2505	PC2510	PC3600	PC3700	PC6510	PC9530	PC9540	PC5300	PC5400		ST30A	G10	H01
LXET 340504PEFR-63-MA																			E12
3405PEFR-63-MA																		●	
340512PEFR-63-MA																			
340516PEFR-63-MA																			
340504PEER-63-ML																			
3405PEER-63-ML																			
340512PEER-63-ML																			
340516PEER-63-ML																			

Parts

Specification		
Ø63	FTGA0511-P	TW20-100

Available inserts E12



PXL(S) new

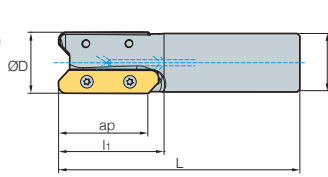

Fig. 1

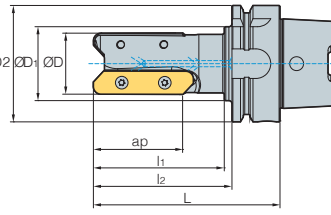

Fig. 2

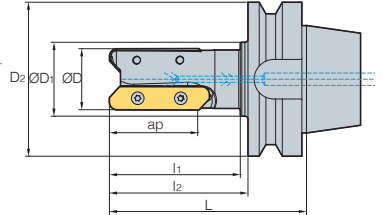
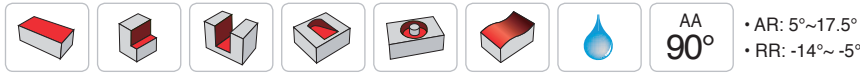

Fig. 3



AA 90°
 • AR: 5°~17.5°
 • RR: -14°~-5°

(mm)

Designation		ØD	ØD1	ØD2	l1	l2	L	ap		Fig.	
PXLS	040HR-2S40	2	40	40	-	85	-	175	57	1.23	1
	040HR-3S40	3	40	40	-	85	-	175	57	1.11	1
	050HR-3S40	3	50	40	-	85	-	185	57	1.51	1
HSK63A	PXL04090HR-2F	2	40	48	63	85	90	116	57	1.13	2
HSK100A	PXL04090HR-3F	3	40	70	100	90	100	129	57	2.74	2
	PXL08090HR-5F	5	80	77	100	-	90	119	57	4.29	2
BT50	PXL04090HR-2F	2	40	48	100	85	90	128	57	4.13	3

Available inserts

LDET-MA



Designation	Cermet		Coated										Uncoated			page			
	CN2000	CN30	NCM325	NC5330	NCM535	NCM545	PC2505	PC2510	PC3600	PC3700	PC6510	PC9530	PC9540	PC5300	PC5400		ST30A	G10	H01
LDET	650540PPFR-MA																		E10
	650550PPFR-MA																		

Parts

Specification		
Ø40~80	FTGA0511-P	TW20-100

Available inserts E10

PAVCM-XD19

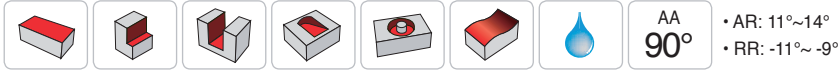
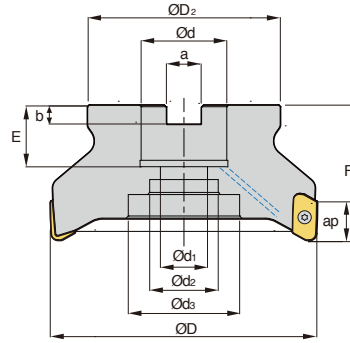

(mm)

Designation	⚙️	ØD	ØD ₂	Ød	Ød ₁	Ød ₂	Ød ₃	a	b	E	F	ap	⚖️	
PAVCM	040R-16-3-XD19-A,B	3	40	34	16	9	13.5	-	8.4	5.6	16	45	17	0.17
	050R-22-4-XD19-A,B	4	50	42	22	11	18	-	10.4	6.3	21	50	17	0.35
	063R-22-5-XD19-A,B	5	63	42	22	11	18	-	10.4	6.3	21	50	17	0.53
	080R-27-5-XD19-A,B	5	80	60	27	14	20	-	12.4	7.0	24	50	17	0.88
	100R-32-6-XD19-A,B	6	100	70	32	18	26	42	14.4	8.0	25	63	17	1.72
	125R-40-7-XD19-A,B	7	125	90	40	22	32	52	16.4	9.0	29	63	17	2.82

- Type A uses Insert Nose R 0.4~3.2, and Type B uses Nose R 4.0 ~ 5.0
- When using a spindle at high speed, please check the balance of tool and use it after replacing with the new screw.

Available inserts

XDET-MA



Designation	Cermet								page	Designation	Coated								page		
	CN2000	CN30	NCM325	NC5330	NCM535	NCM545	PC3600	PC3700			PC6510	PC9530	PC9540	PC5300	PC5400	PD1005	PD1010	Uncoated		H01	H05
XDET	190504PEFR-MA									E10	XDET	190524PEFR-MA									E10
	190508PEFR-MA											190530PEFR-MA									
	190512PEFR-MA											190532PEFR-MA									
	190516PEFR-MA											190540PEFR-MA									
	190520PEFR-MA											190550PEFR-MA									

Available arbors

Designation	Available arbors
PAVCM 040R-16-3-XD19	BT□□-FMC16-□□
050R-22-4-XD19	BT□□-FMC22-□□
063R-22-5-XD19	BT□□-FMC22-□□
080R-27-5-XD19	BT□□-FMC27-□□
100R-32-6-XD19	BT□□-FMC32-□□
125R-40-7-XD19	BT□□-FMC40-□□

Parts

Specification	Screw	Wrench
Ø40~Ø125	PTKA0408-A	TW 15S

Available inserts E10 Available arbors and bolt E400~E402



PAVS-XD19

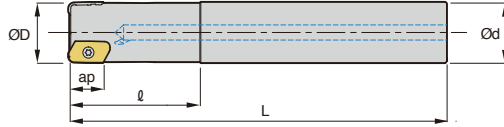

AA
90°

• AR: 8°~11°
• RR: -14°~ -11°

(mm)

Designation			ØD	Ød	l	L	ap	kg
PAVS	025R-2C25-140-XD19-A,B	2	25	25	60	140	17	0.40
	032R-2C32-150-XD19-A,B	2	32	32	70	150	17	0.76
	032R-2C32-200-XD19-A,B	2	32	32	70	200	17	1.06
	040R-3C40-200-XD19-A,B	3	40	40	70	200	17	1.71

- Type A uses Insert Nose R 0.4~3.2, and Type B uses Nose R 4.0~5.0
- When using a spindle at high speed, please check the balance of tool and use it after replacing with the new screw.

Available inserts

XDET-MA



Designation	Cermet		Coated								Uncoated		page	Designation	Cermet		Coated								Uncoated		page							
	CN2000	CN30	NCM325	NC5330	NCM535	NCM545	PC3600	PC3700	PC6510	PC9530	PC9540	PC5300			PC5400	PD1005	PD1010	H01	H05	CN2000	CN30	NCM325	NC5330	NCM535	NCM545	PC3600		PC3700	PC6510	PC9530	PC9540	PC5300	PC5400	PD1005
XDET 190504PEFR-MA																●		XDET 190524PEFR-MA															●	
XDET 190508PEFR-MA																●		XDET 190530PEFR-MA															●	
XDET 190512PEFR-MA																●	E10	XDET 190532PEFR-MA														●	E10	
XDET 190516PEFR-MA																●		XDET 190540PEFR-MA														●		
XDET 190520PEFR-MA																●		XDET 190550PEFR-MA														●		

Parts

Specification		
Ø25~Ø40	PTKA0408-A	TW 15S

- Available inserts E10
- Available arbors and bolt E400~E402



HSK-XD19

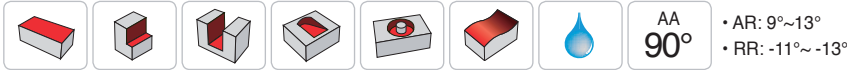
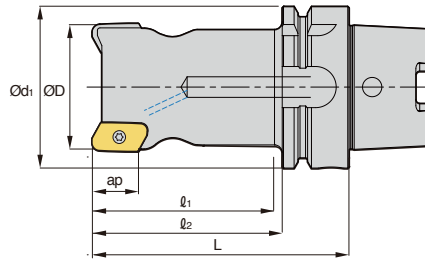

• AR: 9°~13°
• RR: -11°~-13°

(mm)

Designation	Number of Flutes	ØD	Ød1	l1	l2	L	ap	Weight (kg)
HSK63A PAV032R-3-100-XD19-A,B	3	32	63	60	74	100	17	0.97
PAV050R-3-100-XD19-A,B	3	50	63	72	74	100	17	1.37

- Type A uses Insert Nose R 0.4~3.2, and Type B uses Nose R 4.0 ~ 5.0
- When using a spindle at high speed, please check the balance of tool and use it after replacing with the new screw.

Available inserts

XDET-MA



Designation	Cermet		Coated							Uncoated		page	Designation	Cermet		Coated							Uncoated		page													
	CN2000	CN30	NCM825	NC5330	NCM535	NCM545	PC3600	PC3700	PC6510	PC9530	PC9540			PC5300	PC5400	PD1005	PD1010	H01	H05	CN2000	CN30	NCM825	NC5330	NCM535		NCM545	PC3600	PC3700	PC6510	PC9530	PC9540	PC5300	PC5400	PD1005	PD1010	H01	H05	
XDET 190504PEFR-MA													●																					●				
190508PEFR-MA													●																			●						
190512PEFR-MA													●																			●						
190516PEFR-MA													●																			●						
190520PEFR-MA													●																			●						

Parts

Specification	Screw	Wrench
Ø32~Ø50	PTKA0408-A	TW 15S

Available inserts E10 Available arbors and bolt E400~E402



MAT (Steel shank type)

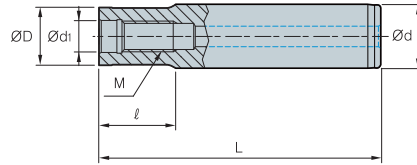

Fig. 1

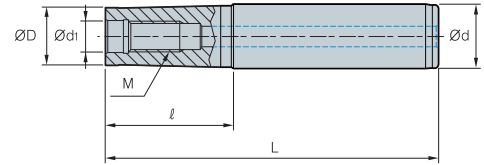

Fig. 2

(mm)

Designation	ØD	Ød	Ød ₁	ℓ	L	M	Fig.
MAT- M06-020-S10S	9.5	10	6.5	20	70	M06	1
M6B-020-S12S	11.0	12	6.5	20	76	M06	1
M6B-040-S12S	11.0	12	6.5	40	96	M06	1
M08-020-S16S	14.5	16	8.5	20	80	M08	1
M10-030-S20S	18.0	20	10.5	30	100	M10	1
M12-030-S25S	22.5	25	12.5	29	110	M12	1
M16-035-S32S	28.5	32	17.0	35	125	M16	1
M06-040-S12T	9.5	12	6.5	40	96	M06	2
M06-065-S16T	9.5	16	6.5	65	125	M06	2
M6B-065-S16T	11.0	16	6.5	65	125	M06	2
M6B-080-S16T	11.0	16	6.5	80	140	M06	2
M08-040-S16T	14.5	16	8.5	40	100	M08	2
M08-065-S16T	14.5	16	8.5	65	125	M08	2
M08-080-S20T	14.5	20	8.5	80	150	M08	2
M08-110-S25T	14.5	25	8.5	110	190	M08	2
M10-050-S20T	18.0	20	10.5	50	120	M10	2
M10-070-S20T	18.0	20	10.5	70	140	M10	2
M10-090-S25T	18.0	25	10.5	90	170	M10	2
M10-110-S25T	18.0	25	10.5	110	190	M10	2
M10-130-S32T	18.0	32	10.5	130	220	M10	2
M12-050-S25T	22.5	25	12.5	50	130	M12	2
M12-070-S25T	22.5	25	12.5	70	150	M12	2
M12-090-S25T	22.5	25	12.5	90	170	M12	2
M12-110-S32T	22.5	32	12.5	110	200	M12	2
M12-175-S40T	22.5	40	12.5	175	300	M12	2
M16-055-S32T	28.5	32	17.0	55	145	M16	2
M16-080-S32T	28.5	32	17.0	80	170	M16	2
M16-120-S32T	28.5	32	17.0	120	210	M16	2
M16-175-S40T	28.5	40	17.0	175	300	M16	2

• S: straight neck adaptor • T: taper neck adaptor

FMRM type  ↻ E244~247, E256~259	LBE-MHD type  ↻ E322	PAM/PAXM type  ↻ E356, 361	AMM type  ↻ E180~182	RM3PM type  ↻ E94	RM4PM/RM4ZM type  ↻ E107, 109
RM6PM type  ↻ E114	HFMDM type  ↻ E267	HFMM type  ↻ E275	HRMM type  ↻ E297, 298	HRMDM type  ↻ E289~291	GBEM type  ↻ E326

↻ Applicable Modular E42, E43 (FMRM, LBE, PAM, AMM, RM4PM, HFMM, RM4ZM, HRMM, PAXM)

MAT-C (Carbide shank type)

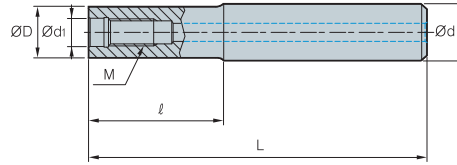

Fig. 1

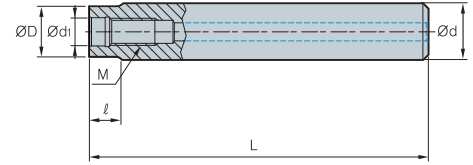

Fig. 2

(mm)

Designation	ØD	Ød	Ød ₁	ℓ	L	M	Fig.
MAT-M06-030-S10S-C-80	9.5	10	6.5	30	80	M06	1
MAT-M06-050-S10S-C-100	9.5	10	6.5	50	100	M06	1
MAT-M06-080-S10S-C-130	9.5	10	6.5	80	130	M06	1
MAT-M6B-030-S12S-C-80	11	12	6.5	30	80	M06	1
MAT-M6B-050-S12S-C-100	11	12	6.5	50	100	M06	1
MAT-M6B-080-S12S-C-130	11	12	6.5	80	130	M06	1
MAT-M08-080-S16S-C	14.5	16	8.5	80	150	M08	1
MAT-M08-110-S16S-C	14.5	16	8.5	110	180	M08	1
MAT-M08-150-S16S-C	14.5	16	8.5	150	250	M08	1
MAT-M08-010-S16S-C-150	14.5	16	8.5	10	150	M08	2
MAT-M08-010-S16S-C-180	14.5	16	8.5	10	180	M08	2
MAT-M08-010-S16S-C-250	14.5	16	8.5	10	250	M08	2
MAT-M10-090-S20S-C	18	20	10.5	90	170	M10	1
MAT-M10-110-S20S-C	18	20	10.5	110	200	M10	1
MAT-M10-175-S20S-C	18	20	10.5	175	300	M10	1
MAT-M10-010-S20S-C-170	18	20	10.5	10	170	M10	2
MAT-M10-010-S20S-C-200	18	20	10.5	10	200	M10	2
MAT-M10-010-S20S-C-300	18	20	10.5	10	300	M10	2
MAT-M12-090-S25S-C	22.5	25	12.5	90	170	M12	1
MAT-M12-110-S25S-C	22.5	25	12.5	110	200	M12	1
MAT-M12-175-S25S-C	22.5	25	12.5	175	300	M12	1
MAT-M12-015-S25S-C-170	22.5	25	12.5	15	170	M12	2
MAT-M12-015-S25S-C-200	22.5	25	12.5	15	200	M12	2
MAT-M12-015-S25S-C-300	22.5	25	12.5	15	300	M12	2
MAT-M16-090-S32S-C	28.5	32	17	90	180	M16	1
MAT-M16-120-S32S-C	28.5	32	17	120	210	M16	1
MAT-M16-175-S32S-C	28.5	32	17	175	300	M16	1
MAT-M16-020-S32S-C-180	28.5	32	17	20	180	M16	2
MAT-M16-020-S32S-C-210	28.5	32	17	20	210	M16	2
MAT-M16-020-S32S-C-300	28.5	32	17	20	300	M16	2



↻ Applicable Modular E42, E43 (FMRM, LBE, PAM, AMM, RM4PM, HFMM, RM4ZM, HRMM, PAXM)



Adjusting side cutter

Code system

P: Plane type
B: Boss type

A: Adjusting side cutter

For half side cutter, minimum width of the cutter will be written only

Adjusting **Cutter type** **Max. width of cutter**

R A FC B 125 14 18 - R

Insert clamping way **Insert configuration** **Cutter Dia.** **Min. width of cutter** **Hand**

R: Radial type
 (Using SDXT)

T: Tangential type
 (Using CNHQ)

FC
 Full side cutter

HC
 Half side cutter

Unmarked	R	L
Neutral	Right	Left
Full side cutter (Plane type)	Half side cutter (Boss type)	

Tangential type (High rigidity)

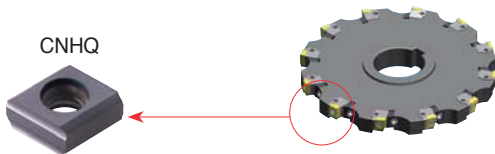

- Medium/Roughing
- Excellent performance at medium to roughing range (14~30 mm) table operation due to the strong rigidity of the cutter
- Good performance in heavy interruption and deep depth of cut application

Radial type (Low cutting load)

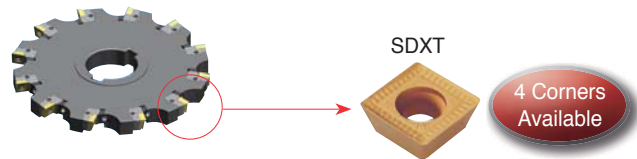

- Medium/Finishing
- Suitable for small width cutting operation (12~24 mm)
- 3 dimensional chip breaker provides smooth cutting operation
- Several chip breakers as per applications are available (MF, MM, FA)
- Economical insert using 4 cutting-edges per insert

Insert features

- Precise adjustable side cutter can control the width of the cutter by 5 μm unit
- Since the width of the cutter is adjustable up to ±1.5 mm, single cutter can cover various cutting width
- Specially designed clamping system of the locator provides excellent rigidity by using elastic deformation of the locator
- Tangential type clamping system of insert provides enough strength can withstand large width cutting operations
- 3-dimensional chip breaker of insert provides smooth cutting with low cutting load at medium to finishing range

Operating manual

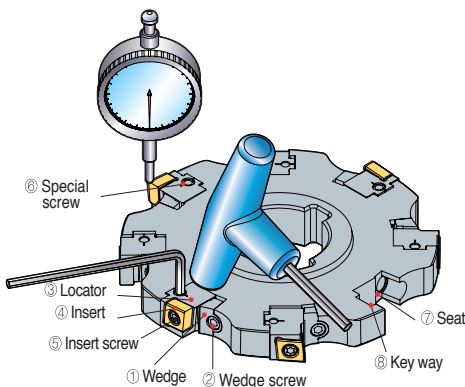

How to assemble the adjusting side cutter

1. Clamp ①wedge slightly on ⑦locator-wedge pocket by using ②wedge screw
2. Put ③locator on ⑦locator-wedge pocket along with the ⑥key-way
3. Tighten the ⑥taper screw little bit to set proper position of locator
4. Tighten the ②wedge screw tightly by using 70~80N.m torque
5. After, put the ④insert on insert pocket of ③locator, clamp it with ⑤insert screw by using 40~50N.m torque

How to adjust Run-out & cutting width

1. Settle the adjusting side cutter after cleaning to the jig for measurement
2. Un-screw the ②Wedge screw first, then tighten ①wedge slightly again by using 8N.m torque
3. Adjusting the height of cutting-edge by using a dial gauge to set the width of the cutter
4. Tighten the ②wedge screw tightly by using 70~80N.m torque
5. To finish the setting, tighten the ⑥taper screw for strong clamp

Tangential type

Cutting width per insert & type of cutter

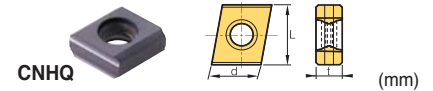

Designation	Coated		Cutting width for half side cutter (ap)	Cutting width for full side cutter (ap)	L	d	t
	NCM325	PC6510					
CNHQ1005	- C0.5		9.0	14~18	10	10	5.4
	- R0.5						
	- C1.0						
	- R1.0						
CNHQ1305	- C0.5		12	18~21/21~24	12.7	10	5.4
	- R0.5		11.5	18~21/21~23			
	- C1.0		11	18~21/21~22			
	- R1.0						
	- C1.5						
	- R1.5						
CNHQ1606	- C0.5		15	24~27/27~30	16	12	6.4
	- R0.5		14.5	24~27/27~29			
	- C1.0		14	24~27/27~28			
	- R1.0		13.5	24~27			
	- C1.5						
	- R1.5						
	- C2.0						
	- R2.0						

Applicable holder E375, E376 Available arbors and bolt E400~E402

Recommended cutting condition

ISO	Grades	vc (m/min)	fz (mm/t)
P	NCM325	190~310	0.10~0.30
	PC3700	160~270	
M	PC5300	90~150	0.10~0.30
	NCM335	180~290	
K	PC6510	140~230	0.10~0.30

Radial type

Cutting width as per insert & type of cutter



Designation	Coated										Uncoated		Cutting width for half side cutter (ap)	Cutting width for full side cutter (ap)	d	t		
	NCM325	NC5330	NCM535	NCM545	PC2505	PC2510	PC3600	PC3700	PC6510	PC9530	PC9540	PC5300					PC5400	H01
SDXT	09M405R-MA																	
	09M405L-MA																	
	09M405R-MF	●					●		●			●	●					
	09M405L-MF																	
	09M405R-MM	●					●		●			●	●					
	09M405L-MM						●		●									
SDXT	130508R-MA													●	●			
	130508L-MA																	
	130508R-MF	●					●		●		●	●						
	130508L-MF																	
	130508R-MM	●					●		●		●	●						
	130508L-MM																	

Applicable holder E377, E378 Available arbors and bolt E400~E402

Recommended cutting condition

ISO	Grades	vc (m/min)	fz (mm/t)
P	NCM325	190~310	0.08~0.30
	NCM335	180~290	0.08~0.25
	PC3700	160~270	0.10~0.25
M	PC9530	90~150	0.10~0.25
	PC5300	90~150	
K	PC8110	140~230	0.10~0.25
	PC6510	140~230	



Tangential type (Full side cutter)

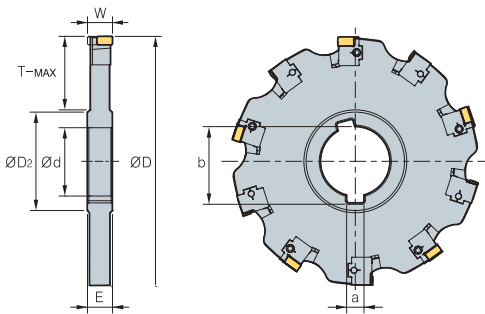

• TAFCP(M)

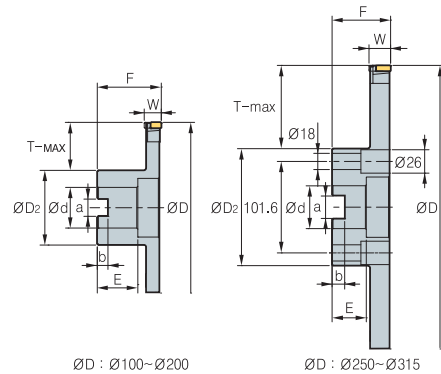

• TAFCB(M)

Designation	Ød	E	ØD2	a	b	T-MAX	Designation	Ød	F	ØD2	a	b	E	T-MAX	Dimensions (mm)				
															ØD	W	No. of tooth		
TAFCP (M) 1001418	31.75 (32)	14	48	7.92 (8)	35.2	24	TAFCB (M) 1001418R/L	31.75 (32)	50	54	12.7 (14.4)	8	28	21	100	14-18	6		
	1251418	38.1 (40)	14	56	9.52 (10)	42.3		32	1251418R/L	38.1 (40)	60	70	15.9 (16.4)	10	30	25	125	14-18	8
	1601418	38.1 (40)	14	56	9.52 (10)	42.3		50	1601418R/L	38.1 (40)	60	70	15.9 (16.4)	10	30	43	160	14-18	10
	2001418	50.8 (50)	14	72	12.7 (12)	55.8		61	2001418R/L	50.8 (40)	65	90	19.0 (16.4)	11	30	53	200	14-18	12
	2501418	50.8 (50)	14	72	12.7 (12)	55.8		86	2501418R/L	47.625 (60)	65	130	25.4 (25.7)	14	38	58	250	14-18	16
	3151418	50.8 (50)	14	72	12.7 (12)	55.8		118	3151418R/L	47.625 (60)	65	130	25.4 (25.7)	14	38	90	315	14-18	20
TAFCP (M) 1001821	31.75 (32)	18	48	7.92 (8)	35.2	24	TAFCB (M) 1001821R/L	31.75 (32)	50	50	12.7 (14.4)	8	28	21	100	18-21	6		
	1251821	38.1 (40)	18	56	9.52 (10)	42.3		32	1251821R/L	38.1 (40)	60	70	15.9 (16.4)	10	30	25	125	18-21	8
	1601821	38.1 (40)	18	56	9.52 (10)	42.3		50	1601821R/L	38.1 (40)	60	70	15.9 (16.4)	10	30	43	160	18-21	10
	2001821	50.8 (50)	18	72	12.7 (12)	55.8		61	2001821R/L	50.8 (40)	65	90	19.0 (16.4)	11	30	53	200	18-21	12
	2501821	50.8 (50)	18	72	12.7 (12)	55.8		86	2501821R/L	47.625 (60)	65	130	25.4 (25.7)	14	38	58	250	18-21	16
	3151821	50.8 (50)	18	72	12.7 (12)	55.8		118	3151821R/L	47.625 (60)	65	130	25.4 (25.7)	14	38	90	315	18-21	20
TAFCP (M) 1002124	31.75 (32)	21	48	7.92 (8)	35.2	24	TAFCB (M) 1002124R/L	31.75 (32)	50	54	12.7 (14.4)	8	28	21	100	21-24	6		
	1252124	38.1 (40)	21	56	9.52 (10)	42.3		32	1252124R/L	38.1 (40)	60	70	15.9 (16.4)	10	30	25	125	21-24	8
	1602124	38.1 (40)	21	56	9.52 (10)	42.3		50	1602124R/L	38.1 (40)	60	70	15.9 (16.4)	10	30	43	160	21-24	10
	2002124	50.8 (50)	21	72	12.7 (12)	55.8		61	2002124R/L	50.8 (40)	65	90	19.0 (16.4)	11	30	53	200	21-24	12
	2502124	50.8 (50)	21	72	12.7 (12)	55.8		86	2502124R/L	47.625 (60)	65	130	25.4 (25.7)	14	38	58	250	21-24	16
	3152124	50.8 (50)	21	72	12.7 (12)	55.8		118	3152124R/L	47.625 (60)	65	130	25.4 (25.7)	14	38	90	315	21-24	20
TAFCP (M) 1252427	38.1 (40)	24	56	9.52 (10)	42.3	32	TAFCB (M) 1252427R/L	38.1 (40)	60	70	15.9 (16.4)	10	30	25	125	24-27	8		
	1602427	38.1 (40)	24	56	9.52 (10)	42.3		50	1602427R/L	38.1 (40)	60	70	15.9 (16.4)	10	30	43	160	24-27	10
	2002427	50.8 (50)	24	72	12.7 (12)	55.8		61	2002427R/L	50.8 (40)	65	90	19.0 (16.4)	11	30	53	200	24-27	12
	2502427	50.8 (50)	24	72	12.7 (12)	55.8		86	2502427R/L	47.625 (60)	65	130	25.4 (25.7)	14	38	58	250	24-27	16
	3152427	50.8 (50)	24	72	12.7 (12)	55.8		118	3152427R/L	47.625 (60)	65	130	25.4 (25.7)	14	38	90	315	24-27	20
	TAFCP (M) 1252730	38.1 (40)	27	56	9.52 (10)	42.3		32	TAFCB (M) 1252730R/L	38.1 (40)	60	70	15.9 (16.4)	10	30	25	125	27-30	8
1602730		38.1 (40)	27	56	9.52 (10)	42.3	50	1602730R/L		38.1 (40)	60	70	15.9 (16.4)	10	30	43	160	27-30	10
2002730		50.8 (50)	27	72	12.7 (12)	55.8	61	2002730R/L		50.8 (40)	65	90	19.0 (16.4)	11	30	53	200	27-30	12
2502730		50.8 (50)	27	72	12.7 (12)	55.8	86	2502730R/L		47.625 (60)	65	130	25.4 (25.7)	14	38	58	250	27-30	16
3152730		50.8 (50)	27	72	12.7 (12)	55.8	118	3152730R/L		47.625 (60)	65	130	25.4 (25.7)	14	38	90	315	27-30	20

Available inserts and Recommended cutting condition **E374** • The ap (Maximum width of cutter) size written above is the number when using insert having corner size C0.5 or R0.5 () Metric size

Parts

Specification	Insert	Locator	Wedge	Insert screw	Wedge screw	Locator screw	Insert wrench	Wedge Wrench	Locator Wrench
□□□1418R/L	CNHQ1005-□□□	LSA-CH10R/L	WSA10N	FTKA0410	DHA0617	SHGA0411	TW15S	HW30	-
□□□1821R/L	CNHQ1305-□□□	LSA-CH13R/L	WSA13N	FTKA0410	DHA0821F	SHGA0411	TW15S	HW40	HW30L
□□□2124R/L	CNHQ1305-□□□	LSA-CH13R/L	WSA13N	FTKA0410	DHA0821F	SHGA0411	TW15S	HW40	HW30L
□□□2427R/L	CNHQ1606-□□□	LSA-CH16R/L	WSA13N	FTGA0513-P	DHA0821F	SHGA0411	TW20S	HW40	HW30L
□□□2730R/L	CNHQ1606-□□□	LSA-CH16R/L	WSA13N	FTGA0513-P	DHA0821F	SHGA0411	TW20S	HW40	HW30L

• Note) The Wedge screw for 1001821, 1002124 cutter is DHA0818F



Tangential type (Half side cutter)

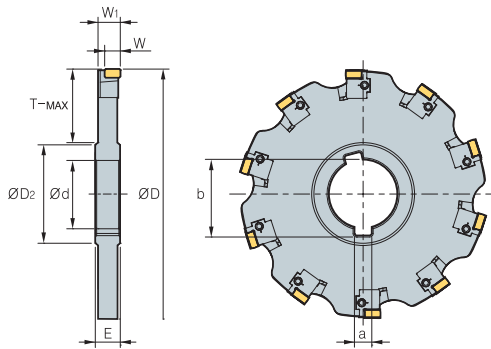

• TAHC(M)

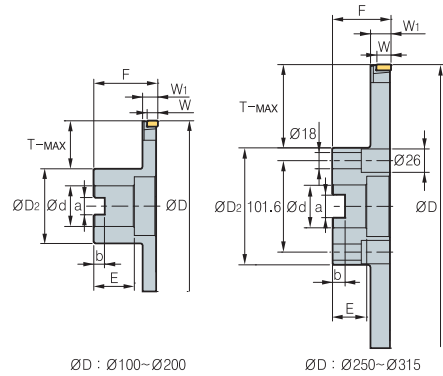

• TAHC(B)

Designation	Ød	E	ØD2	a	b	T-MAX	Designation	Ød	F	ØD2	a	b	E	T-MAX	Dimensions					
															ØD	W	W1	No. of tooth		
TAHCP (M) 10014R/L	31.75 (32)	14	48	7.92 (8)	35.2	24	TAHCB (M) 10014R/L	31.75 (32)	50	54	12.7 (14.4)	8	28	21	100	9	13.25	6		
	12514R/L	38.1 (40)	14	56	9.52 (10)	42.3		32	12514R/L	38.1 (40)	60	70	15.9 (16.4)	10	30	25	125	9	13.25	8
	16014R/L	38.1 (40)	14	56	9.52 (10)	42.3		50	16014R/L	38.1 (40)	60	70	15.9 (16.4)	10	30	43	160	9	13.25	10
	20014R/L	50.8 (50)	14	72	12.7 (12)	55.8		61	20014R/L	50.8 (40)	65	90	19.0 (16.4)	11	30	53	200	9	13.25	12
	25014R/L	50.8 (50)	14	72	12.7 (12)	55.8		86	25014R/L	47.625 (60)	65	130	25.4 (25.7)	14	38	58	250	9	13.25	16
	31514R/L	50.8 (50)	14	72	12.7 (12)	55.8		118	31514R/L	47.625 (60)	65	130	25.4 (25.7)	14	38	90	315	9	13.25	20
TAHCP (M) 10018R/L	31.75 (32)	18	48	7.92 (8)	35.2	24	TAHCB (M) 10018R/L	31.75 (32)	50	50	12.7 (14.4)	8	28	21	100	12	16.75	6		
	12518R/L	38.1 (40)	18	56	9.52 (10)	42.3		32	12518R/L	38.1 (40)	60	70	15.9 (16.4)	10	30	25	125	12	16.75	8
	16018R/L	38.1 (40)	18	56	9.52 (10)	42.3		50	16018R/L	38.1 (40)	60	70	15.9 (16.4)	10	30	43	160	12	16.75	10
	20018R/L	50.8 (50)	18	72	12.7 (12)	55.8		61	20018R/L	50.8 (40)	65	90	19.0 (16.4)	11	30	53	200	12	16.75	12
	25018R/L	50.8 (50)	18	72	12.7 (12)	55.8		86	25018R/L	47.625 (60)	65	130	25.4 (25.7)	14	38	58	250	12	16.75	16
	31518R/L	50.8 (50)	18	72	12.7 (12)	55.8		118	31518R/L	47.625 (60)	65	130	25.4 (25.7)	14	38	90	315	12	16.75	20
TAHCP (M) 10021R/L	31.75 (32)	21	48	7.92 (8)	35.2	24	TAHCB (M) 10021R/L	31.75 (32)	50	54	12.7 (14.4)	8	28	21	100	12	19.75	6		
	12521R/L	38.1 (40)	21	56	9.52 (10)	42.3		32	12521R/L	38.1 (40)	60	70	15.9 (16.4)	10	30	25	125	12	19.75	8
	16021R/L	38.1 (40)	21	56	9.52 (10)	42.3		50	16021R/L	38.1 (40)	60	70	15.9 (16.4)	10	30	43	160	12	19.75	10
	20021R/L	50.8 (50)	21	72	12.7 (12)	55.8		61	20021R/L	50.8 (40)	65	90	19.0 (16.4)	11	30	53	200	12	19.75	12
	25021R/L	50.8 (50)	21	72	12.7 (12)	55.8		86	25021R/L	47.625 (60)	65	130	25.4 (25.7)	14	38	58	250	12	19.75	16
	31521R/L	50.8 (50)	21	72	12.7 (12)	55.8		118	31521R/L	47.625 (60)	65	130	25.4 (25.7)	14	38	90	315	12	19.75	20
TAHCP (M) 12524R/L	38.1 (40)	24	56	9.52 (10)	42.3	32	TAHCB (M) 12524R/L	38.1 (40)	60	70	15.9 (16.4)	10	30	25	125	15	22.75	8		
	16024R/L	38.1 (40)	24	56	9.52 (10)	42.3		50	16024R/L	38.1 (40)	60	70	15.9 (16.4)	10	30	43	160	15	22.75	10
	20024R/L	50.8 (50)	24	72	12.7 (12)	55.8		61	20024R/L	50.8 (40)	65	90	19.0 (16.4)	11	30	53	200	15	22.75	12
	25024R/L	50.8 (50)	24	72	12.7 (12)	55.8		86	25024R/L	47.625 (60)	65	130	25.4 (25.7)	14	38	58	250	15	22.75	16
	31524R/L	50.8 (50)	24	72	12.7 (12)	55.8		118	31524R/L	47.625 (60)	65	130	25.4 (25.7)	14	38	90	315	15	22.75	20
	TAHCP (M) 12527R/L	38.1 (40)	27	56	9.52 (10)	42.3		32	TAHCB (M) 12527R/L	38.1 (40)	60	70	15.9 (16.4)	10	30	25	125	15	25.75	8
16027R/L		38.1 (40)	27	56	9.52 (10)	42.3	50	16027R/L		38.1 (40)	60	70	15.9 (16.4)	10	30	43	160	15	25.75	10
20027R/L		50.8 (50)	27	72	12.7 (12)	55.8	61	20027R/L		50.8 (40)	65	90	19.0 (16.4)	11	30	53	200	15	25.75	12
25027R/L		50.8 (50)	27	72	12.7 (12)	55.8	86	25027R/L		47.625 (60)	65	130	25.4 (25.7)	14	38	58	250	15	25.75	16
31527R/L		50.8 (50)	27	72	12.7 (12)	55.8	118	31527R/L		47.625 (60)	65	130	25.4 (25.7)	14	38	90	315	15	25.75	20

Available inserts and Recommended cutting condition E374 • The ap (Maximum width of cutter) size written above is the number when using insert having corner size C0.5 or R0.5

() Metric size

Parts

Specification	Insert	Locator	Wedge	Insert screw	Wedge screw	Locator screw	Insert wrench	Wedge Wrench	Locator Wrench
□□□1418R/L	CNHQ1005-□□□	LSA-CH10R/L	WSA10N	FTKA0410	DHA0617	SHGA0411	TW15S	HW30	-
□□□1821R/L	CNHQ1305-□□□	LSA-CH13R/L	WSA13N	FTKA0410	DHA0821F	SHGA0411	TW15S	HW40	HW30L
□□□2124R/L	CNHQ1305-□□□	LSA-CH13R/L	WSA13N	FTKA0410	DHA0821F	SHGA0411	TW15S	HW40	HW30L
□□□2427R/L	CNHQ1606-□□□	LSA-CH16R/L	WSA13N	FTGA0513-P	DHA0821F	SHGA0411	TW20S	HW40	HW30L
□□□2730R/L	CNHQ1606-□□□	LSA-CH16R/L	WSA13N	FTGA0513-P	DHA0821F	SHGA0411	TW20S	HW40	HW30L

• (Note) The Wedge screw for 10018, 10021 cutter is DHA0818F



Radial type (Full side cutter)

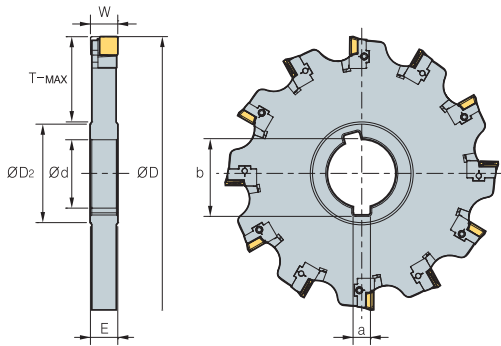

• RAFCP(M)

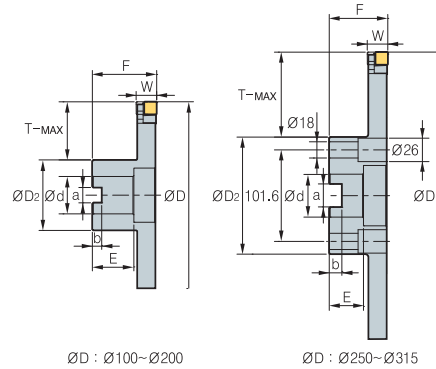

• RAFCB(M)

(mm)

Designation	Ød	E	ØD2	a	b	T-MAX	Designation	Ød	F	ØD2	a	b	E	T-MAX	Dimensions		
															ØD	W	No. of tooth
RAFCP (M) 1001214 1251214 1601214 2001214 2501214 3151214	31.75 (32)	12	48	7.92 (8)	35.2	24	RAFCB (M) 1001214R/L 1251214R/L 1601214R/L 2001214R/L 2501214R/L 3151214R/L	31.75 (32)	50	54	12.7 (14.4)	8	28	21	100	12-14	6
	38.1 (40)	12	56	9.52 (10)	42.3	32		38.1 (40)	60	70	15.9 (16.4)	10	30	25	125	12-14	8
	38.1 (40)	12	56	9.52 (10)	42.3	50		38.1 (40)	60	70	15.9 (16.4)	10	30	43	160	12-14	10
	50.8 (50)	12	72	12.7 (12)	55.8	61		50.8 (40)	65	90	19.0 (16.4)	11	30	53	200	12-14	12
	50.8 (50)	12	72	12.7 (12)	55.8	86		47.625 (60)	65	130	25.4 (25.7)	14	38	58	250	12-14	16
	50.8 (50)	12	72	12.7 (12)	55.8	118		47.625 (60)	65	130	25.4 (25.7)	14	38	90	315	12-14	20
RAFCP (M) 1001416 1251416 1601416 2001416 2501416 3151416	31.75 (32)	14	48	7.92 (8)	35.2	24	RAFCB (M) 1001416R/L 1251416R/L 1601416R/L 2001416R/L 2501416R/L 3151416R/L	31.75 (32)	50	50	12.7 (14.4)	8	28	21	100	14-16	6
	38.1 (40)	14	56	9.52 (10)	42.3	32		38.1 (40)	60	70	15.9 (16.4)	10	30	25	125	14-16	8
	38.1 (40)	14	56	9.52 (10)	42.3	50		38.1 (40)	60	70	15.9 (16.4)	10	30	43	160	14-16	10
	50.8 (50)	14	72	12.7 (12)	55.8	61		50.8 (40)	65	90	19.0 (16.4)	11	30	53	200	14-16	12
	50.8 (50)	14	72	12.7 (12)	55.8	86		47.625 (60)	65	130	25.4 (25.7)	14	38	58	250	14-16	16
	50.8 (50)	14	72	12.7 (12)	55.8	118		47.625 (60)	65	130	25.4 (25.7)	14	38	90	315	14-16	20
RAFCP (M) 1251618 1601618 2001618 2501618 3151618	38.1 (40)	16	56	9.52 (10)	42.3	32	RAFCB (M) 1251618R/L 1601618R/L 2001618R/L 2501618R/L 3151618R/L	38.1 (40)	60	70	15.9 (16.4)	10	30	25	125	16-18	8
	38.1 (40)	16	56	9.52 (10)	42.3	50		38.1 (40)	60	70	15.9 (16.4)	10	30	43	160	16-18	10
	50.8 (50)	16	72	12.7 (12)	55.8	61		50.8 (40)	65	90	19.0 (16.4)	11	30	53	200	16-18	12
	50.8 (50)	16	72	12.7 (12)	55.8	86		47.625 (60)	65	130	25.4 (25.7)	14	38	58	250	16-18	16
	50.8 (50)	16	72	12.7 (12)	55.8	118		47.625 (60)	65	130	25.4 (25.7)	14	38	90	315	16-18	20
	RAFCP (M) 1251820 1601820 2001820 2501820 3151820	38.1 (40)	18	56	9.52 (10)	42.3		32	RAFCB (M) 1251820R/L 1601820R/L 2001820R/L 2501820R/L 3151820R/L	38.1 (40)	60	70	15.9 (16.4)	10	30	25	125
38.1 (40)		18	56	9.52 (10)	42.3	50	38.1 (40)	60		70	15.9 (16.4)	10	30	43	160	18-20	10
50.8 (50)		18	72	12.7 (12)	55.8	61	50.8 (40)	65		90	19.0 (16.4)	11	30	53	200	18-20	12
50.8 (50)		18	72	12.7 (12)	55.8	86	47.625 (60)	65		130	25.4 (25.7)	14	38	58	250	18-20	16
50.8 (50)		18	72	12.7 (12)	55.8	118	47.625 (60)	65		130	25.4 (25.7)	14	38	90	315	18-20	20
RAFCP (M) 1252022 1602022 2002022 2502022 3152022		38.1 (40)	20	56	9.52 (10)	42.3	32	RAFCB (M) 1252022R/L 1602022R/L 2002022R/L 2502022R/L 3152022R/L		38.1 (40)	60	70	15.9 (16.4)	10	30	25	125
	38.1 (40)	20	56	9.52 (10)	42.3	50	38.1 (40)		60	70	15.9 (16.4)	10	30	43	160	20-22	10
	50.8 (50)	20	72	12.7 (12)	55.8	61	50.8 (40)		65	90	19.0 (16.4)	11	30	53	200	20-22	12
	50.8 (50)	20	72	12.7 (12)	55.8	86	47.625 (60)		65	130	25.4 (25.7)	14	38	58	250	20-22	16
	50.8 (50)	20	72	12.7 (12)	55.8	118	47.625 (60)		65	130	25.4 (25.7)	14	38	90	315	20-22	20
	RAFCP (M) 1252224 1602224 2002224 2502224 3152224	38.1 (40)	22	56	9.52 (10)	42.3	32		RAFCB (M) 1252224R/L 1602224R/L 2002224R/L 2502224R/L 3152224R/L	38.1 (40)	60	70	15.9 (16.4)	10	30	25	125
38.1 (40)		22	56	9.52 (10)	42.3	50	38.1 (40)	60		70	15.9 (16.4)	10	30	43	160	22-24	10
50.8 (50)		22	72	12.7 (12)	55.8	61	50.8 (40)	65		90	19.0 (16.4)	11	30	53	200	22-24	12
50.8 (50)		22	72	12.7 (12)	55.8	86	47.625 (60)	65		130	25.4 (25.7)	14	38	58	250	22-24	16
50.8 (50)		22	72	12.7 (12)	55.8	118	47.625 (60)	65		130	25.4 (25.7)	14	38	90	315	22-24	20

↻ Available inserts and Recommended cutting condition **E374** • The ap (Maximum width of cutter) size written above is the number when using insert having corner size C0.5 or R0.5 () Metric size

Parts

Specification	Insert	Locator	WSD09N Wedge	WSA10N Wedge	Insert screw	Wedge screw	Locator screw	Insert wrench	Wedge, locator wrench
□□□1214R/L	SDXT09M40□R/L	LSD09R/L	WSD09N	WSA10N	FTGA03508	DHA0617	SHGA0409	TW15S	HW30
□□□1416R/L	SDXT09M40□R/L	LSD09R/L	WSD09N	WSA10N	FTGA03508	DHA0617	SHGA0409	TW15S	HW30
□□□1618R/L	SDXT13050□R/L	LSD13R/L	WSD09N	WSA10N	FTNC04509	DHA0617	SHGA0411	TW20S	HW30
□□□1820R/L	SDXT13050□R/L	LSD13R/L	WSD09N	WSA10N	FTNC04509	DHA0617	SHGA0411	TW20S	HW30
□□□2022R/L	SDXT13050□R/L	LSD13R/L	WSD09N	WSA10N	FTNC04509	DHA0617	SHGA0411	TW20S	HW30
□□□2224R/L	SDXT13050□R/L	LSD13R/L	WSD09N	WSA10N	FTNC04509	DHA0617	SHGA0411	TW20S	HW30



Radial type (Half side cutter)

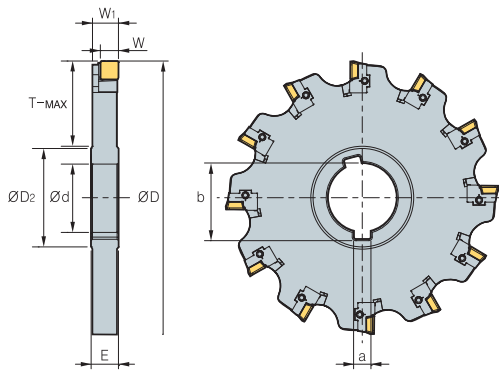

• RAHCP(M)

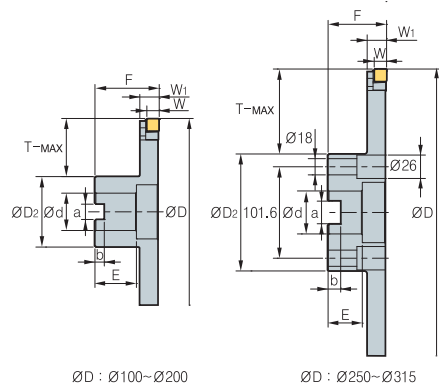

• RAHCB(M)

(mm)

Designation	Ød	E	ØD2	a	b	T-MAX	Designation	Ød	F	ØD2	a	b	E	T-MAX	Dimensions			
															ØD	W	W1	No. of tooth
RAHCP 10012R/L (M)	31.75 (32)	12	48	7.92 (8)	35.2	24	RAHCB 10012R/L (M)	31.75 (32)	50	54	12.7 (14.4)	8	28	21	100	8	11.1	6
12512R/L	38.1 (40)	12	56	9.52 (10)	42.3	32	12512R/L	38.1 (40)	60	70	15.9 (16.4)	10	30	25	125	8	11.1	8
16012R/L	38.1 (40)	12	56	9.52 (10)	42.3	50	16012R/L	38.1 (40)	60	70	15.9 (16.4)	10	30	43	160	8	11.1	10
20012R/L	50.8 (50)	12	72	12.7 (12)	55.8	61	20012R/L	50.8 (40)	65	90	19.0 (16.4)	11	30	53	200	8	11.1	12
25012R/L	50.8 (50)	12	72	12.7 (12)	55.8	86	25012R/L	47.625 (60)	65	130	25.4 (25.7)	14	38	58	250	8	11.1	16
31512R/L	50.8 (50)	12	72	12.7 (12)	55.8	118	31512R/L	47.625 (60)	65	130	25.4 (25.7)	14	38	90	315	8	11.1	20
RAHCP 10014R/L (M)	31.75 (32)	14	48	7.92 (8)	35.2	24	RAHCB 10014R/L (M)	31.75 (32)	50	50	12.7 (14.4)	8	28	21	100	8	13.1	6
12514R/L	38.1 (40)	14	56	9.52 (10)	42.3	32	12514R/L	38.1 (40)	60	70	15.9 (16.4)	10	30	25	125	8	13.1	8
16014R/L	38.1 (40)	14	56	9.52 (10)	42.3	50	16014R/L	38.1 (40)	60	70	15.9 (16.4)	10	30	43	160	8	13.1	10
20014R/L	50.8 (50)	14	72	12.7 (12)	55.8	61	20014R/L	50.8 (40)	65	90	19.0 (16.4)	11	30	53	200	8	13.1	12
25014R/L	50.8 (50)	14	72	12.7 (12)	55.8	86	25014R/L	47.625 (60)	65	130	25.4 (25.7)	14	38	58	250	8	13.1	16
31514R/L	50.8 (50)	14	72	12.7 (12)	55.8	118	31514R/L	47.625 (60)	65	130	25.4 (25.7)	14	38	90	315	8	13.1	20
RAHCP 12516R/L (M)	38.1 (40)	16	56	9.52 (10)	42.3	32	RAHCB 12516R/L (M)	38.1 (40)	60	70	15.9 (16.4)	10	30	25	125	10.5	15	8
16016R/L	38.1 (40)	16	56	9.52 (10)	42.3	50	16016R/L	38.1 (40)	60	70	15.9 (16.4)	10	30	43	160	10.5	15	10
20016R/L	50.8 (50)	16	72	12.7 (12)	55.8	61	20016R/L	50.8 (40)	65	90	19.0 (16.4)	11	30	53	200	10.5	15	12
25016R/L	50.8 (50)	16	72	12.7 (12)	55.8	86	25016R/L	47.625 (60)	65	130	25.4 (25.7)	14	38	58	250	10.5	15	16
31516R/L	50.8 (50)	16	72	12.7 (12)	55.8	118	31516R/L	47.625 (60)	65	130	25.4 (25.7)	14	38	90	315	10.5	15	20
RAHCP 12518R/L (M)	38.1 (40)	18	56	9.52 (10)	42.3	32	RAHCB 12518R/L (M)	38.1 (40)	60	70	15.9 (16.4)	10	30	25	125	10.5	17	8
16018R/L	38.1 (40)	18	56	9.52 (10)	42.3	50	16018R/L	38.1 (40)	60	70	15.9 (16.4)	10	30	43	160	10.5	17	10
20018R/L	50.8 (50)	18	72	12.7 (12)	55.8	61	20018R/L	50.8 (40)	65	90	19.0 (16.4)	11	30	53	200	10.5	17	12
25018R/L	50.8 (50)	18	72	12.7 (12)	55.8	86	25018R/L	47.625 (60)	65	130	25.4 (25.7)	14	38	58	250	10.5	17	16
31518R/L	50.8 (50)	18	72	12.7 (12)	55.8	118	31518R/L	47.625 (60)	65	130	25.4 (25.7)	14	38	90	315	10.5	17	20
RAHCP 12520R/L (M)	38.1 (40)	20	56	9.52 (10)	42.3	32	RAHCB 12520R/L (M)	38.1 (40)	60	70	15.9 (16.4)	10	30	25	125	10.5	19	8
16020R/L	38.1 (40)	20	56	9.52 (10)	42.3	50	16020R/L	38.1 (40)	60	70	15.9 (16.4)	10	30	43	160	10.5	19	10
20020R/L	50.8 (50)	20	72	12.7 (12)	55.8	61	20020R/L	50.8 (40)	65	90	19.0 (16.4)	11	30	53	200	10.5	19	12
25020R/L	50.8 (50)	20	72	12.7 (12)	55.8	86	25020R/L	47.625 (60)	65	130	25.4 (25.7)	14	38	58	250	10.5	19	16
31520R/L	50.8 (50)	20	72	12.7 (12)	55.8	118	31520R/L	47.625 (60)	65	130	25.4 (25.7)	14	38	90	315	10.5	19	20
RAHCP 12522R/L (M)	38.1 (40)	22	56	9.52 (10)	42.3	32	RAHCB 12522R/L (M)	38.1 (40)	60	70	15.9 (16.4)	10	30	25	125	10.5	21	8
16022R/L	38.1 (40)	22	56	9.52 (10)	42.3	50	16022R/L	38.1 (40)	60	70	15.9 (16.4)	10	30	43	160	10.5	21	10
20022R/L	50.8 (50)	22	72	12.7 (12)	55.8	61	20022R/L	50.8 (40)	65	90	19.0 (16.4)	11	30	53	200	10.5	21	12
25022R/L	50.8 (50)	22	72	12.7 (12)	55.8	86	25022R/L	47.625 (60)	65	130	25.4 (25.7)	14	38	58	250	10.5	21	16
31522R/L	50.8 (50)	22	72	12.7 (12)	55.8	118	31522R/L	47.625 (60)	65	130	25.4 (25.7)	14	38	90	315	10.5	21	20

➔ Available inserts and Recommended cutting condition E374

- The ap (Maximum width of cutter) size written above is the number when using insert having corner size R0.5. The ap is subject to change as per insert corner size
- The ap (Maximum width of cutter) size written above is the number when using SDXT09M405R-MM. The ap is subject to change as per insert corner size () Metric size

➔ Parts

Specification									
Edge width (TAHCP/B)	Insert	Locator	WSD09N	WSA10N	Insert screw	Wedge screw	Locator screw	Insert wrench	Wedge, locator wrench
□□□1214R/L	SDXT09M40□R/L	LSD09R/L	WSD09N	WSD09N	FTGA03508	DHA0617	SHGA0409	TW15S	HW30
□□□1416R/L	SDXT09M40□R/L	LSD09R/L	WSD09N	WSD09N	FTGA03508	DHA0617	SHGA0409	TW15S	HW30
□□□1618R/L	SDXT13050□R/L	LSD13R/L	WSA10N	WSA10N	FTNC04509	DHA0617	SHGA0411	TW20S	HW30
□□□1820R/L	SDXT13050□R/L	LSD13R/L	WSA10N	WSA10N	FTNC04509	DHA0617	SHGA0411	TW20S	HW30
□□□2022R/L	SDXT13050□R/L	LSD13R/L	WSA10N	WSA10N	FTNC04509	DHA0617	SHGA0411	TW20S	HW30
□□□2224R/L	SDXT13050□R/L	LSD13R/L	WSA10N	WSA10N	FTNC04509	DHA0617	SHGA0411	TW20S	HW30



SPP(M)

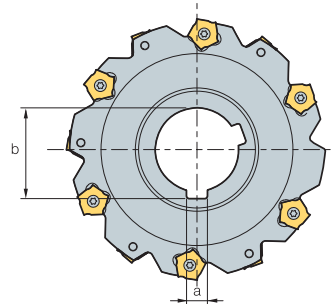
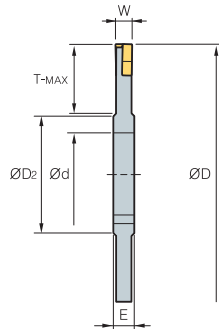

•AR: -2°
•RR: -28°

(mm)

Designation	⊙	ØD	W	T-MAX	Ød	a	b	E	ØDz	Insert	Screw	Wrench
SPP												
(SPPM)												
080-04	8	80	4	20	25.4 (27)	6.35 (7)	28.04 (29.8)	8	40	PNEJ1223N	PTMA0403F	TW15S
080-05	8	80	5	20	25.4 (27)	6.35 (7)	28.04 (29.8)	8	40	PNEJ1230N	PTMA0404F	TW15S
080-06	8	80	6	20	25.4 (27)	6.35 (7)	28.04 (29.8)	8	40	PNEJ1235N	PTMA0405F	TW15S
100-04	10	100	4	24	31.75 (32)	7.94 (8)	35.18 (34.8)	8	47	PNEJ1223N	PTMA0403F	TW15S
100-05	10	100	5	24	31.75 (32)	7.94 (8)	35.18 (34.8)	8	47	PNEJ1230N	PTMA0404F	TW15S
100-06	10	100	6	25	31.75 (32)	7.94 (8)	35.18 (34.8)	8	47	PNEJ1235N	PTMA0405F	TW15S
100-07	10	100	7	25	31.75 (32)	7.94 (8)	35.18 (34.8)	10	47	PNEJ1240N	PTMA0406F	TW15S
100-08	10	100	8	25	31.75 (32)	7.94 (8)	35.18 (34.8)	10	47	PNEJ1245N	PTKA0407F	TW15S
100-09	10	100	9	25	31.75 (32)	7.94 (8)	35.18 (34.8)	12	47	PNEJ1250N	PTKA0408F	TW15S
100-10	10	100	10	25	31.75 (32)	7.94 (8)	35.18 (34.8)	12	47	PNEJ1255N	PTKA0409F	TW15S
125-04	12	125	4	30	38.1 (40)	9.53 (10)	42.32 (43.5)	8	56	PNEJ1223N	PTMA0403F	TW15S
125-05	12	125	5	32	38.1 (40)	9.53 (10)	42.32 (43.5)	8	56	PNEJ1230N	PTMA0404F	TW15S
125-06	12	125	6	32	38.1 (40)	9.53 (10)	42.32 (43.5)	8	56	PNEJ1235N	PTMA0405F	TW15S
125-07	12	125	7	32	38.1 (40)	9.53 (10)	42.32 (43.5)	10	56	PNEJ1240N	PTMA0406F	TW15S
125-08	12	125	8	32	38.1 (40)	9.53 (10)	42.32 (43.5)	10	56	PNEJ1245N	PTKA0407F	TW15S
125-09	12	125	9	32	38.1 (40)	9.53 (10)	42.32 (43.5)	12	56	PNEJ1250N	PTKA0408F	TW15S
125-10	12	125	10	32	38.1 (40)	9.53 (10)	42.32 (43.5)	12	56	PNEJ1255N	PTKA0409F	TW15S
160-04	16	160	4	45	38.1 (40)	9.53 (10)	42.32 (43.5)	8	66	PNEJ1223N	PTMA0403F	TW15S
160-05	16	160	5	45	38.1 (40)	9.53 (10)	42.32 (43.5)	8	66	PNEJ1230N	PTMA0404F	TW15S
160-06	16	160	6	45	38.1 (40)	9.53 (10)	42.32 (43.5)	8	66	PNEJ1235N	PTMA0405F	TW15S
160-07	16	160	7	45	38.1 (40)	9.53 (10)	42.32 (43.5)	10	66	PNEJ1240N	PTMA0406F	TW15S
160-08	16	160	8	45	38.1 (40)	9.53 (10)	42.32 (43.5)	10	66	PNEJ1245N	PTKA0407F	TW15S
160-09	16	160	9	45	38.1 (40)	9.53 (10)	42.32 (43.5)	12	66	PNEJ1250N	PTKA0408F	TW15S
160-10	16	160	10	45	38.1 (40)	9.53 (10)	42.32 (43.5)	12	66	PNEJ1255N	PTKA0409F	TW15S
160-11	16	160	11	45	38.1 (40)	9.53 (10)	42.32 (43.5)	14	66	PNEJ1260N	PTKA0410F	TW15S
160-12	16	160	12	45	38.1 (40)	9.53 (10)	42.32 (43.5)	14	66	PNEJ1265N	PTKA0411F	TW15S
160-13	16	160	13	45	38.1 (40)	9.53 (10)	42.32 (43.5)	16	66	PNEJ1270N	PTKA0412F	TW15S
160-14	16	160	14	45	38.1 (40)	9.53 (10)	42.32 (43.5)	16	66	PNEJ1275N	PTKA0413F	TW15S
200-06	18	200	6	60	50.8 (50)	12.7 (12)	55.83 (53.5)	8	70	PNEJ1235N	PTMA0405F	TW15S
200-07	18	200	7	60	50.8 (50)	12.7 (12)	55.83 (53.5)	10	70	PNEJ1240N	PTMA0406F	TW15S
200-08	18	200	8	60	50.8 (50)	12.7 (12)	55.83 (53.5)	10	70	PNEJ1245N	PTKA0407F	TW15S
200-09	18	200	9	60	50.8 (50)	12.7 (12)	55.83 (53.5)	12	70	PNEJ1250N	PTKA0408F	TW15S
200-10	18	200	10	60	50.8 (50)	12.7 (12)	55.83 (53.5)	12	70	PNEJ1255N	PTKA0409F	TW15S
200-11	18	200	11	60	50.8 (50)	12.7 (12)	55.83 (53.5)	14	70	PNEJ1260N	PTKA0410F	TW15S
200-12	18	200	12	60	50.8 (50)	12.7 (12)	55.83 (53.5)	14	70	PNEJ1265N	PTKA0411F	TW15S
200-13	18	200	13	60	50.8 (50)	12.7 (12)	55.83 (53.5)	16	70	PNEJ1270N	PTKA0412F	TW15S
200-14	18	200	14	60	50.8 (50)	12.7 (12)	55.83 (53.5)	16	70	PNEJ1275N	PTKA0413F	TW15S

() Metric size

Available arbors

Designation	NC arbors		
	BT30	BT40	BT50
SPP			
080-04~06	BT30-SCA25.4-60	BT40-SCA25.4-75/120	BT50-SCA25.4-90/135
100-04~10	-	BT40-SCA31.75-105	BT50-SCA31.75-90/135
125-04~09	-	-	BT50-SCA38.1-90/135
160-04~14	-	-	BT50-SCA38.1-90/135
200-06~14	-	-	-
SPPM			
080-04~06	-	BT40-SCA27-75/120	BT50-SCA27-90/135
100-04~10	-	BT40-SCA32-105	BT50-SCA32-90/135
125-04~09	-	-	BT50-SCA40-90/135
160-04~14	-	-	BT50-SCA40-90/135
200-06~14	-	-	-

Recommended cutting condition

Workpiece	Cutting condition		Grades
	vc (m/min)	fz (mm/t)	
P	190~310 160~270 60~100	0.10~0.25 0.10~0.30 0.10~0.25	NCM325 PC3700 ST30A
M	90~150 80~150	0.10~0.25 0.10~0.30	PC9530 ST30A
K	140~230 50~90	0.10~0.35 0.10~0.40	PC6510 G10

Code system

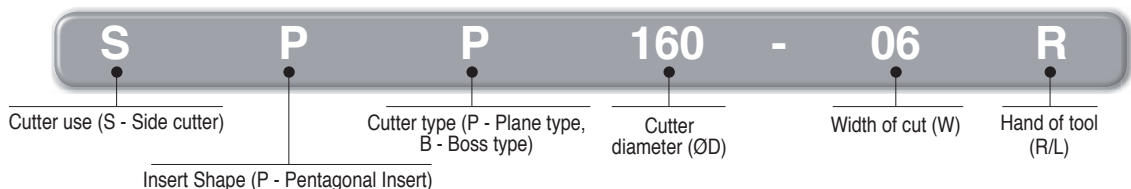

Available inserts **E15** Available arbors and bolt **E400~E402**



SPB(M)

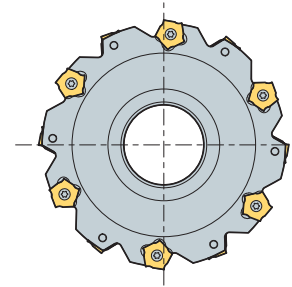
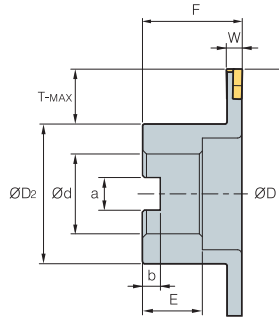

•AR: -2°
•RR: 28°

(mm)

Designation	ØD	W	T-MAX	ØD ₂	Ød	a	b	F	E	Insert	Screw	Wrench
SPB (SPBM)	080-04R/L	8	80	4	18	40	25.4 (27)	9.5 (12.4)	6 (7)	50	25 (22)	PNEJ1223N PTMA0403F TW15S
	080-05R/L	8	80	5	18	40	25.4 (27)	9.5 (12.4)	6 (7)	50	25 (22)	PNEJ1230N PTMA0404F TW15S
	080-06R/L	8	80	6	18	40	25.4 (27)	9.5 (12.4)	6 (7)	50	25 (22)	PNEJ1235N PTMA0405F TW15S
	100-04R/L	10	100	4	21	54	31.75 (32)	12.7 (14.4)	8 (8)	50	32 (28)	PNEJ1223N PTMA0403F TW15S
	100-05R/L	10	100	5	21	54	31.75 (32)	12.7 (14.4)	8 (8)	50	32 (28)	PNEJ1230N PTMA0404F TW15S
	100-06R/L	10	100	6	21	54	31.75 (32)	12.7 (14.4)	8 (8)	50	32 (28)	PNEJ1235N PTMA0405F TW15S
	100-07R/L	10	100	7	21	54	31.75 (32)	12.7 (14.4)	8 (8)	50	32 (28)	PNEJ1240N PTMA0406F TW15S
	100-08R/L	10	100	8	21	54	31.75 (32)	12.7 (14.4)	8 (8)	50	32 (28)	PNEJ1245N PTMA0407F TW15S
	100-09R/L	10	100	9	21	54	31.75 (32)	12.7 (14.4)	8 (8)	50	32 (28)	PNEJ1250N PTMA0408F TW15S
	100-10R/L	10	100	10	21	54	31.75 (32)	12.7 (14.4)	8 (8)	50	32 (28)	PNEJ1255N PTMA0409F TW15S
125-04R/L	12	125	4	25	70	38.1 (40)	15.9 (16.4)	10 (9)	60 (50)	38 (30)	PNEJ1223N PTMA0403F TW15S	
125-05R/L	12	125	5	25	70	38.1 (40)	15.9 (16.4)	10 (9)	60 (50)	38 (30)	PNEJ1230N PTMA0404F TW15S	
125-06R/L	12	125	6	25	70	38.1 (40)	15.9 (16.4)	10 (9)	60 (50)	38 (30)	PNEJ1235N PTMA0405F TW15S	
125-07R/L	12	125	7	25	70	38.1 (40)	15.9 (16.4)	10 (9)	60 (50)	38 (30)	PNEJ1240N PTMA0406F TW15S	
125-08R/L	12	125	8	25	70	38.1 (40)	15.9 (16.4)	10 (9)	60 (50)	38 (30)	PNEJ1245N PTKA0407F TW15S	
125-09R/L	12	125	9	25	70	38.1 (40)	15.9 (16.4)	10 (9)	60 (50)	38 (30)	PNEJ1250N PTKA0408F TW15S	
125-10R/L	12	125	10	25	70	38.1 (40)	15.9 (16.4)	10 (9)	60 (50)	38 (30)	PNEJ1255N PTKA0409F TW15S	
160-04R/L	16	160	4	43	70	38.1 (40)	15.9 (16.4)	10 (9)	60 (50)	38 (30)	PNEJ1223N PTMA0403F TW15S	
160-05R/L	16	160	5	43	70	38.1 (40)	15.9 (16.4)	10 (9)	60 (50)	38 (30)	PNEJ1230N PTMA0404F TW15S	
160-06R/L	16	160	6	43	70	38.1 (40)	15.9 (16.4)	10 (9)	60 (50)	38 (30)	PNEJ1235N PTMA0405F TW15S	
160-07R/L	16	160	7	43	70	38.1 (40)	15.9 (16.4)	10 (9)	60 (50)	38 (30)	PNEJ1240N PTMA0406F TW15S	
160-08R/L	16	160	8	43	70	38.1 (40)	15.9 (16.4)	10 (9)	60 (50)	38 (30)	PNEJ1245N PTKA0407F TW15S	
160-09R/L	16	160	9	43	70	38.1 (40)	15.9 (16.4)	10 (9)	60 (50)	38 (30)	PNEJ1250N PTKA0408F TW15S	
160-10R/L	16	160	10	43	70	38.1 (40)	15.9 (16.4)	10 (9)	60 (50)	38 (30)	PNEJ1255N PTKA0409F TW15S	
160-11R/L	16	160	11	43	70	38.1 (40)	15.9 (16.4)	10 (9)	60 (50)	38 (30)	PNEJ1260N PTKA0410F TW15S	
160-12R/L	16	160	12	43	70	38.1 (40)	15.9 (16.4)	10 (9)	60 (50)	38 (30)	PNEJ1265N PTKA0411F TW15S	
160-13R/L	16	160	13	43	70	38.1 (40)	15.9 (16.4)	10 (9)	60 (50)	38 (30)	PNEJ1270N PTKA0412F TW15S	
160-14R/L	16	160	14	43	70	38.1 (40)	15.9 (16.4)	10 (9)	60 (50)	38 (30)	PNEJ1275N PTKA0413F TW15S	
200-06R/L	18	200	6	53	90	50.8 (40)	19 (16.4)	11 (9)	65	38 (30)	PNEJ1235N PTMA0405F TW15S	
200-07R/L	18	200	7	53	90	50.8 (40)	19 (16.4)	11 (9)	65	38 (30)	PNEJ1240N PTMA0406F TW15S	
200-08R/L	18	200	8	53	90	50.8 (40)	19 (16.4)	11 (9)	65	38 (30)	PNEJ1245N PTKA0407F TW15S	
200-09R/L	18	200	9	53	90	50.8 (40)	19 (16.4)	11 (9)	65	38 (30)	PNEJ1250N PTKA0408F TW15S	
200-10R/L	18	200	10	53	90	50.8 (40)	19 (16.4)	11 (9)	65	38 (30)	PNEJ1255N PTKA0409F TW15S	
200-11R/L	18	200	11	53	90	50.8 (40)	19 (16.4)	11 (9)	65	38 (30)	PNEJ1260N PTKA0410F TW15S	
200-12R/L	18	200	12	53	90	50.8 (40)	19 (16.4)	11 (9)	65	38 (30)	PNEJ1265N PTKA0411F TW15S	
200-13R/L	18	200	13	53	90	50.8 (40)	19 (16.4)	11 (9)	65	38 (30)	PNEJ1270N PTKA0412F TW15S	
200-14R/L	18	200	14	53	90	50.8 (40)	19 (16.4)	11 (9)	65	38 (30)	PNEJ1275N PTKA0413F TW15S	

() Metric size

Notice (When mounting inserts)

- Insert chip breaker should face chip pocket of the cutter
- Fasten screw after insert contacts securely on its seat
- If there is a gap between insert and its seat after mounting it may cause tool troubles

Recommended cutting condition

Workpiece	Cutting condition		Grades
	vc (m/min)	fz (mm/t)	
P	190~310	0.10~0.25	NCM325 PC3700 ST30A
	160~270	0.10~0.30	
	60~100	0.10~0.25	
M	90~150	0.10~0.25	PC9530 ST30A
	80~150	0.10~0.30	
K	140~230	0.10~0.35 0.10~0.40	PC6510 G10

Available inserts **E15** Available arbors and bolt **E400~E402**



SPS

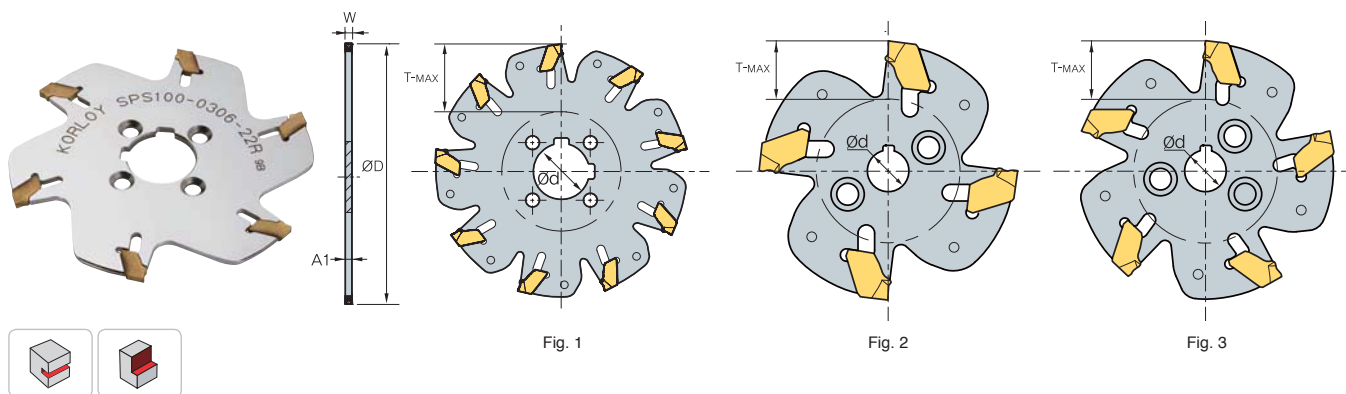

(mm)

Designation	ØD	W	T-MAX	Ød	A1	Fig.	Insert	Adaptor		Wrench
								WS	DF	
SPS										
050-0204-08R	50	2.2	11	8	1.8	2	SPFN 200 ()	WS2528-M4	-	SW17P (separately ordered)
063-0205-10R	63	2.2	15.5	10	1.8	3		WS2532-M5	-	
080-0207-22R/F	80	2.2	20 (17)	22	1.8	1		WS3240-M5	DF22-46	
100-0209-22R/F	100	2.2	30 (27)	22	1.8	1		WS3240-M5	DF22-46	
125-0211-32F	125	2.2	35	32	1.8	1		-	DF32-55	
160-0214-32F	160	2.2	52.5	32	1.8	3	-	DF32-55		
063-0305-10R	63	3	15.5	10	2.55	1	SPFN 300 ()	WS2532-M5	-	
080-0307-22R/F	80	3	20 (17)	22	2.55	1		WS3240-M5	DF22-46	
100-0309-22R/F	100	3	30 (27)	22	2.55	1		WS3240-M5	DF22-46	
125-0311-32F	125	3	35	32	2.55	1		-	DF32-55	
160-0314-32F	160	3	52.5	32	2.55	1		-	DF32-55	
200-0318-40F	200	3	60	40	2.55	1	-	DF40-80		
080-0406-22R/F	80	4	20 (17)	22	3.4	1	SPFN 400 ()	WS3240-M5	DF22-46	
100-0408-22R/F	100	4	30 (27)	22	3.4	1		WS3240-M5	DF22-46	
125-0410-32F	125	4	35	32	3.4	1		-	DF32-55	
160-0413-32F	160	4	52.5	32	3.4	1		-	DF32-55	
200-0417-40F	200	4	60	40	3.4	1		-	DF40-80	

() Metric size

WS()-() (Weldon Shank)

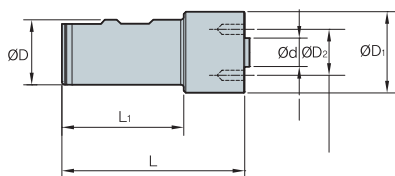

Designation	L	L1	D	D1	D2	d	Screw
WS2528-M4	110	85	25	28	18	8	PTKA0408
WS2532-M5	110	85	25	32	22	10	PTKA0515
WS3240-M5	120	90	32	40	32	22	PTKA0515

DF()-() (Drive Flange set)

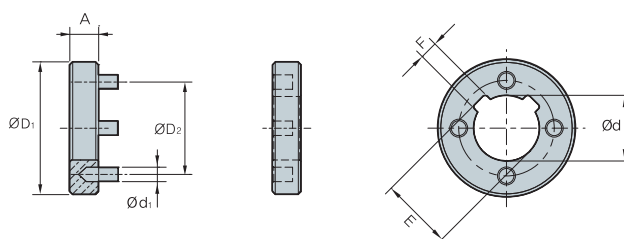

Designation	D1	D2	d	d1	A	E	F
DF22-46	46	32	22	5	10	24.1	6
DF32-55	55	45	32	6	10	34.8	8
DF40-80	80	63	40	11	12	43.5	10
DF50-110	110	80	50	14	14	53.6	12

Recommended cutting condition

Workpiece	Cutting condition		Grades
	vc (m/min)	fz (mm/t)	
P	160~270	0.13~0.25	PC3700
M	90~150	0.10~0.22	PC5300
K	110~180	0.10~0.25	PC6510

Available inserts E25 Available arbors and bolt E400~E402

E Technical Information for Wind Mill

For slotting workpieces with corner radii of varying sizes and widths

Wind Mill

- Optimal machining for slotting applications
- A unique recess design on the minor cutting-edge reduces cutting load and improves tool life
- Special clamping system prevents incorrect clamping and fracture

Item description



Cutter code system

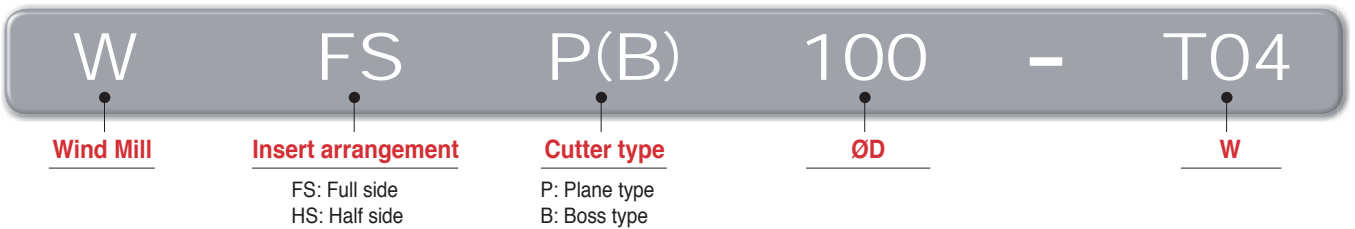

Insert code system

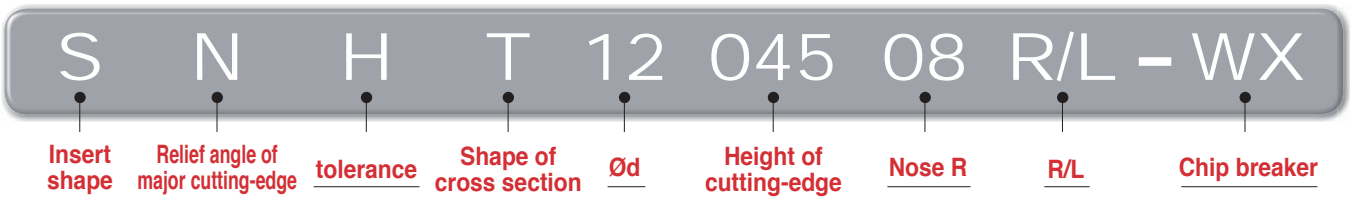

Features

- Ideal geometry for superior surface roughness and extended tool life



- Perpendicular slot

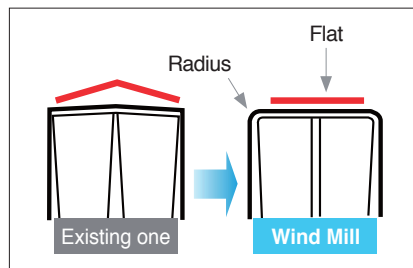

- Protruded part on tip seat prevents wrong clamping and fracture

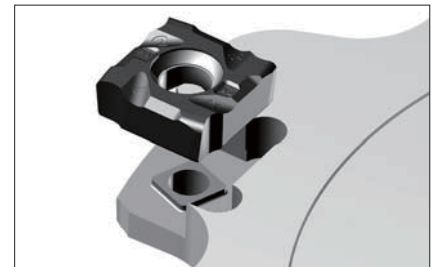

- Workpieces with corner radii of varying size and width (R0.2~R2.0)

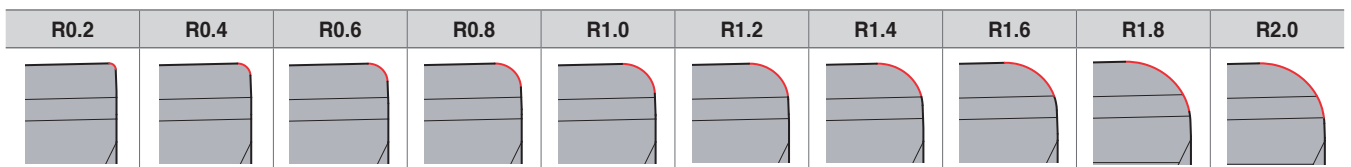

Application example

- **Use** Carriers for Motor Vehicles
- **Workpiece** FCD500K
- **Cutting conditions**
 - vc (m/min) = 200
 - fz (mm/t) = 0.2
 - vf (mm/min) = 600
 - ap (mm) = 2~3
- **Tool**
 - KSF140R-T14-HM-2
 - SNHT1205408R/L-WX (PC5300)

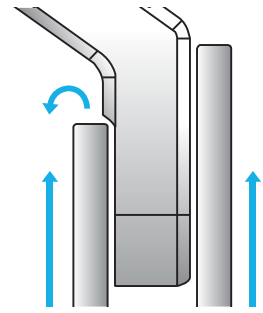
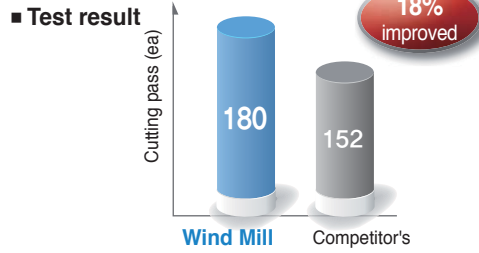

- **Use** Lug for Vessel
- **Workpiece** Mild steel
- **Cutting conditions**
 - vc (m/min) = 560
 - fz (mm/t) = 0.09
 - vf (mm/min) = 750
 - ap (mm) = 6
- **Tool**
 - WFSP178R/L-T06
 - SNHT1203508R/L-WX (PC5300)

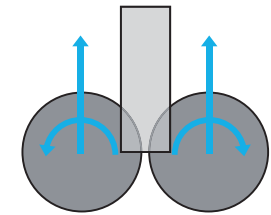
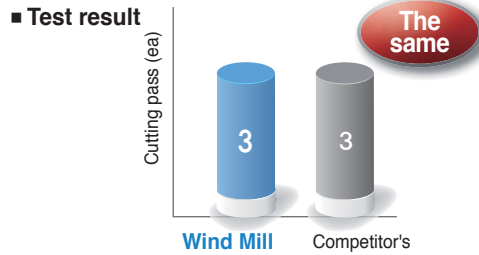

Recommended cutting condition

Workpiece	Cutting conditions		Grades
	vc (m/min)	fz (mm/t)	
P	150~250	0.10~0.25	PC5300
M	120~200	0.10~0.30	PC5300
K	100~150	0.10~0.30	PC5300

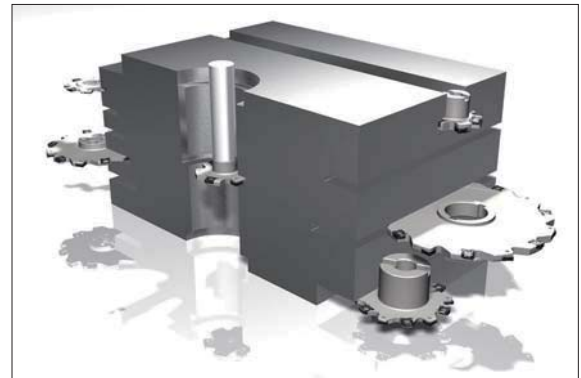

Available inserts

Designation	Coated	Dimensions (mm)				Nose R	Configuration
	PC5300	Ød	Ød ₁	t	W		
SNHT	1102308R/L-WX	●	11.0	4	2.30	4.0	0.2, 0.4, 0.6, 0.8, 1.0, 1.2, 1.4, 1.6
	110308R/L-WX	●	11.0	4	3.00	5.0	0.2, 0.4, 0.6, 0.8, 1.0, 1.2, 1.4, 1.6
	120308R/L-WX		12.7	5	3.25	5.5	0.2, 0.4, 0.6, 0.8, 1.0, 1.2, 1.4, 1.6, 2.0
	1203508R/L-WX	●	12.7	5	3.54	6.0	0.2, 0.4, 0.6, 0.8, 1.0, 1.2, 1.4, 1.6, 2.0
	120408R/L-WX		12.7	5	4.00	7.0	0.2, 0.4, 0.6, 0.8, 1.0, 1.2, 1.4, 1.6, 2.0
	1204508R/L-WX	●	12.7	5	4.54	8.0	0.2, 0.4, 0.6, 0.8, 1.0, 1.2, 1.4, 1.6, 2.0
	120508R/L-WX	●	12.7	5	5.00	9.0	0.2, 0.4, 0.6, 0.8, 1.0, 1.2, 1.4, 1.6, 2.0
	1205408R/L-WX	●	12.7	5	5.47	10.0	0.2, 0.4, 0.6, 0.8, 1.0, 1.2, 1.4, 1.6, 2.0
	120608R/L-WX		12.7	5	6.00	11.0	0.2, 0.4, 0.6, 0.8, 1.0, 1.2, 1.4, 1.6, 2.0
	1206508R/L-WX		12.7	5	6.50	12.0	0.2, 0.4, 0.6, 0.8, 1.0, 1.2, 1.4, 1.6, 2.0
	120708R/L-WX		12.7	5	7.00	13.0	0.2, 0.4, 0.6, 0.8, 1.0, 1.2, 1.4, 1.6, 2.0
	1207508R/L-WX		12.7	5	7.50	14.0	0.2, 0.4, 0.6, 0.8, 1.0, 1.2, 1.4, 1.6, 2.0

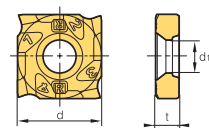

* Available cutter stock requires to be asked separately

WFSB(M)(Boss type)

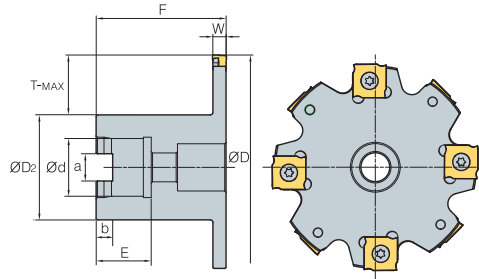

Fig. 1

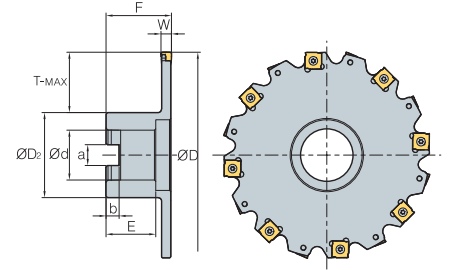

Fig. 2



•AR: -2°
•RR: -12°

(mm)

Designation	ØD	W	T-MAX	ØD ₂	Ød	a	b	F	E	Insert	Screw	Wrench
WFSBM 080R/L-T04	80	4	17	40	22	10.4	6.3	50	21	SNHT11023R/L-WX	PTMA03503	TW09S
080R/L-T05	80	5	17	40	22	10.4	6.3	50	21	SNHT1103R/L-WX	PTMA03504	TW09S
080R/L-T06	80	6	17	40	22	10.4	6.3	50	21	SNHT12035R/L-WX	PTMA04045F	TW15S
WFSB (WFSBM) 100R/L-T04	100	4	21	50 (48)	25.4 (27)	9.5 (12.4)	6 (7)	50	25	SNHT11023R/L-WX	PTMA03503	TW09S
100R/L-T05	100	5	21	50 (48)	25.4 (27)	9.5 (12.4)	6 (7)	50	25	SNHT1103R/L-WX	PTMA03504	TW09S
100R/L-T06	100	6	21	50 (48)	25.4 (27)	9.5 (12.4)	6 (7)	50	25	SNHT12035R/L-WX	PTMA04045F	TW15S
100R/L-T07	100	7	21	50 (48)	25.4 (27)	9.5 (12.4)	6 (7)	50	25	SNHT1204R/L-WX	PTMA0405F	TW15S
100R/L-T08	100	8	21	50 (48)	25.4 (27)	9.5 (12.4)	6 (7)	50	25	SNHT12045R/L-WX	PTMA0406F	TW15S
100R/L-T09	100	9	21	50 (48)	25.4 (27)	9.5 (12.4)	6 (7)	50	25	SNHT1205R/L-WX	PTMA0407F	TW15S
100R/L-T10	100	10	21	50 (48)	25.4 (27)	9.5 (12.4)	6 (7)	50	25	SNHT12054R/L-WX	PTMA0408F	TW15S
125R/L-T04	125	4	30	60 (58)	31.75 (32)	12.7 (14.4)	8	50	32 (30)	SNHT11023R/L-WX	PTMA03503	TW09S
125R/L-T05	125	5	30	60 (58)	31.75 (32)	12.7 (14.4)	8	50	32 (30)	SNHT1103R/L-WX	PTMA03504	TW09S
125R/L-T06	125	6	30	60 (58)	31.75 (32)	12.7 (14.4)	8	50	32 (30)	SNHT12035R/L-WX	PTMA04045F	TW15S
125R/L-T07	125	7	30	60 (58)	31.75 (32)	12.7 (14.4)	8	50	32 (30)	SNHT1204R/L-WX	PTMA0405F	TW15S
125R/L-T08	125	8	30	60 (58)	31.75 (32)	12.7 (14.4)	8	50	32 (30)	SNHT12045R/L-WX	PTMA0406F	TW15S
125R/L-T09	125	9	30	60 (58)	31.75 (32)	12.7 (14.4)	8	50	32 (30)	SNHT1205R/L-WX	PTMA0407F	TW15S
125R/L-T10	125	10	30	60 (58)	31.75 (32)	12.7 (14.4)	8	50	32 (30)	SNHT12054R/L-WX	PTMA0408F	TW15S
160R/L-T04	160	4	43	70	38.1 (40)	15.9 (16.4)	10 (9)	60	38 (32)	SNHT11023R/L-WX	PTMA03503	TW09S
160R/L-T05	160	5	43	70	38.1 (40)	15.9 (16.4)	10 (9)	60	38 (32)	SNHT1103R/L-WX	PTMA03504	TW09S
160R/L-T06	160	6	43	70	38.1 (40)	15.9 (16.4)	10 (9)	60	38 (32)	SNHT12035R/L-WX	PTMA04045F	TW15S
160R/L-T07	160	7	43	70	38.1 (40)	15.9 (16.4)	10 (9)	60	38 (32)	SNHT1204R/L-WX	PTMA0405F	TW15S
160R/L-T08	160	8	43	70	38.1 (40)	15.9 (16.4)	10 (9)	60	38 (32)	SNHT12045R/L-WX	PTMA0406F	TW15S
160R/L-T09	160	9	43	70	38.1 (40)	15.9 (16.4)	10 (9)	60	38 (32)	SNHT1205R/L-WX	PTMA0407F	TW15S
160R/L-T10	160	10	43	70	38.1 (40)	15.9 (16.4)	10 (9)	60	38 (32)	SNHT12054R/L-WX	PTMA0408F	TW15S
160R/L-T11	160	11	43	70	38.1 (40)	15.9 (16.4)	10 (9)	60	38 (32)	SNHT1206R/L-WX	PTKA0409F	TW15S
160R/L-T12	160	12	43	70	38.1 (40)	15.9 (16.4)	10 (9)	60	38 (32)	SNHT12065R/L-WX	PTKA0410F	TW15S
160R/L-T13	160	13	43	70	38.1 (40)	15.9 (16.4)	10 (9)	60	38 (32)	SNHT1207R/L-WX	PTKA0411F	TW15S
160R/L-T14	160	14	43	70	38.1 (40)	15.9 (16.4)	10 (9)	60	38 (32)	SNHT12075R/L-WX	PTKA0412F	TW15S
200R/L-T06	200	6	53	90	50.8 (40)	19.1 (16.4)	11 (9)	65	38 (32)	SNHT12035R/L-WX	PTMA04045F	TW15S
200R/L-T07	200	7	53	90	50.8 (40)	19.1 (16.4)	11 (9)	65	38 (32)	SNHT1204R/L-WX	PTMA0405F	TW15S
200R/L-T08	200	8	53	90	50.8 (40)	19.1 (16.4)	11 (9)	65	38 (32)	SNHT12045R/L-WX	PTMA0406F	TW15S
200R/L-T09	200	9	53	90	50.8 (40)	19.1 (16.4)	11 (9)	65	38 (32)	SNHT1205R/L-WX	PTMA0407F	TW15S
200R/L-T10	200	10	53	90	50.8 (40)	19.1 (16.4)	11 (9)	65	38 (32)	SNHT12054R/L-WX	PTMA0408F	TW15S
200R/L-T11	200	11	53	90	50.8 (40)	19.1 (16.4)	11 (9)	65	38 (32)	SNHT1206R/L-WX	PTKA0409F	TW15S
200R/L-T12	200	12	53	90	50.8 (40)	19.1 (16.4)	11 (9)	65	38 (32)	SNHT12065R/L-WX	PTKA0410F	TW15S
200R/L-T13	200	13	53	90	50.8 (40)	19.1 (16.4)	11 (9)	65	38 (32)	SNHT1207R/L-WX	PTKA0411F	TW15S
200R/L-T14	200	14	53	90	50.8 (40)	19.1 (16.4)	11 (9)	65	38 (32)	SNHT12075R/L-WX	PTKA0412F	TW15S
250R/L-T06	250	6	73 (78)	100 (90)	50.8 (40)	19.1 (16.4)	11 (9)	65	38 (32)	SNHT12035R/L-WX	PTMA04045F	TW15S
250R/L-T07	250	7	73 (78)	100 (90)	50.8 (40)	19.1 (16.4)	11 (9)	65	38 (32)	SNHT1204R/L-WX	PTMA0405F	TW15S
250R/L-T08	250	8	73 (78)	100 (90)	50.8 (40)	19.1 (16.4)	11 (9)	65	38 (32)	SNHT12045R/L-WX	PTMA0406F	TW15S
250R/L-T09	250	9	73 (78)	100 (90)	50.8 (40)	19.1 (16.4)	11 (9)	65	38 (32)	SNHT1205R/L-WX	PTMA0407F	TW15S
250R/L-T10	250	10	73 (78)	100 (90)	50.8 (40)	19.1 (16.4)	11 (9)	65	38 (32)	SNHT12054R/L-WX	PTMA0408F	TW15S
250R/L-T11	250	11	73 (78)	100 (90)	50.8 (40)	19.1 (16.4)	11 (9)	65	38 (32)	SNHT1206R/L-WX	PTKA0409F	TW15S
250R/L-T12	250	12	73 (78)	100 (90)	50.8 (40)	19.1 (16.4)	11 (9)	65	38 (32)	SNHT12065R/L-WX	PTKA0410F	TW15S
250R/L-T13	250	13	73 (78)	100 (90)	50.8 (40)	19.1 (16.4)	11 (9)	65	38 (32)	SNHT1207R/L-WX	PTKA0411F	TW15S
250R/L-T14	250	14	73 (78)	100 (90)	50.8 (40)	19.1 (16.4)	11 (9)	65	38 (32)	SNHT12075R/L-WX	PTKA0412F	TW15S

•Ø80: Fig.1 , Ø100~Ø250: Fig.2 ()Metric size Available inserts E23



WFSP(M)(Plane type)

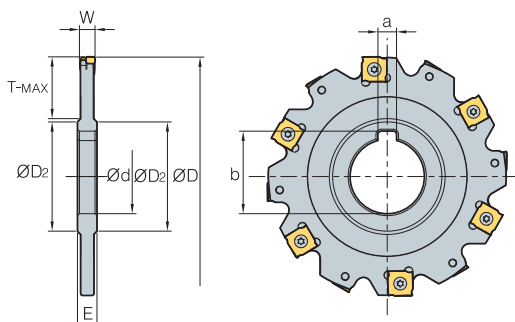

•AR: -2°
•RR: -12°

(mm)

Designation		ØD	W	T-MAX	ØD ₂	Ød	a	b	E	Insert	Screw	Wrench	
WFSP (WFSBM)	080-T04	8	80	4	20	40	25.4 (27)	6.35 (7)	28 (29.8)	8	SNHT11023R/L-WX	PTMA03503	TW09S
	080-T05	8	80	5	20	40	25.4 (27)	6.35 (7)	28 (29.8)	8	SNHT1103R/L-WX	PTMA03504	TW09S
	080-T06	8	80	6	20	40	25.4 (27)	6.35 (7)	28 (29.8)	8	SNHT12035R/L-WX	PTMA04045F	TW15S
	100-T04	10	100	4	24	47	31.75 (32)	7.92 (8)	35.2 (34.8)	8	SNHT11023R/L-WX	PTMA03503	TW09S
	100-T05	10	100	5	24	47	31.75 (32)	7.92 (8)	35.2 (34.8)	8	SNHT1103R/L-WX	PTMA03504	TW09S
	100-T06	10	100	6	24	47	31.75 (32)	7.92 (8)	35.2 (34.8)	8	SNHT12035R/L-WX	PTMA04045F	TW15S
	100-T07	10	100	7	24	47	31.75 (32)	7.92 (8)	35.2 (34.8)	10	SNHT1204R/L-WX	PTMA0405F	TW15S
	100-T08	10	100	8	24	47	31.75 (32)	7.92 (8)	35.2 (34.8)	10	SNHT12045R/L-WX	PTMA0406F	TW15S
	100-T09	10	100	9	24	47	31.75 (32)	7.92 (8)	35.2 (34.8)	12	SNHT1205R/L-WX	PTMA0407F	TW15S
	100-T10	10	100	10	24	47	31.75 (32)	7.92 (8)	35.2 (34.8)	12	SNHT12054R/L-WX	PTMA0408F	TW15S
	125-T04	12	125	4	32	56	38.1 (40)	9.52 (10)	42.3 (43.5)	8	SNHT11023R/L-WX	PTMA03503	TW09S
	125-T05	12	125	5	32	56	38.1 (40)	9.52 (10)	42.3 (43.5)	8	SNHT1103R/L-WX	PTMA03504	TW09S
	125-T06	12	125	6	32	56	38.1 (40)	9.52 (10)	42.3 (43.5)	8	SNHT12035R/L-WX	PTMA04045F	TW15S
	125-T07	12	125	7	32	56	38.1 (40)	9.52 (10)	42.3 (43.5)	10	SNHT1204R/L-WX	PTMA0405F	TW15S
125-T08	12	125	8	32	56	38.1 (40)	9.52 (10)	42.3 (43.5)	10	SNHT12045R/L-WX	PTMA0406F	TW15S	
125-T09	12	125	9	32	56	38.1 (40)	9.52 (10)	42.3 (43.5)	12	SNHT1205R/L-WX	PTMA0407F	TW15S	
125-T10	12	125	10	32	56	38.1 (40)	9.52 (10)	42.3 (43.5)	12	SNHT12054R/L-WX	PTMA0408F	TW15S	
160-T04	16	160	4	45	66	38.1 (40)	9.52 (10)	42.3 (43.5)	8	SNHT11023R/L-WX	PTMA03503	TW09S	
160-T05	16	160	5	45	66	38.1 (40)	9.52 (10)	42.3 (43.5)	8	SNHT1103R/L-WX	PTMA03504	TW09S	
160-T06	16	160	6	45	66	38.1 (40)	9.52 (10)	42.3 (43.5)	8	SNHT12035R/L-WX	PTMA04045F	TW15S	
160-T07	16	160	7	45	66	38.1 (40)	9.52 (10)	42.3 (43.5)	10	SNHT1204R/L-WX	PTMA0405F	TW15S	
160-T08	16	160	8	45	66	38.1 (40)	9.52 (10)	42.3 (43.5)	10	SNHT12045R/L-WX	PTMA0406F	TW15S	
160-T09	16	160	9	45	66	38.1 (40)	9.52 (10)	42.3 (43.5)	12	SNHT1205R/L-WX	PTMA0407F	TW15S	
160-T10	16	160	10	45	66	38.1 (40)	9.52 (10)	42.3 (43.5)	12	SNHT12054R/L-WX	PTMA0408F	TW15S	
160-T11	16	160	11	45	66	38.1 (40)	9.52 (10)	42.3 (43.5)	14	SNHT1206R/L-WX	PTKA0409F	TW15S	
160-T12	16	160	12	45	66	38.1 (40)	9.52 (10)	42.3 (43.5)	14	SNHT12065R/L-WX	PTKA0410F	TW15S	
160-T13	16	160	13	45	66	38.1 (40)	9.52 (10)	42.3 (43.5)	16	SNHT1207R/L-WX	PTKA0411F	TW15S	
160-T14	16	160	14	45	66	38.1 (40)	9.52 (10)	42.3 (43.5)	16	SNHT12075R/L-WX	PTKA0412F	TW15S	
200-T06	18	200	6	60	70	50.8 (50)	12.7 (12)	55.8 (53.5)	8	SNHT12035R/L-WX	PTMA04045F	TW15S	
200-T07	18	200	7	60	70	50.8 (50)	12.7 (12)	55.8 (53.5)	10	SNHT1204R/L-WX	PTMA0405F	TW15S	
200-T08	18	200	8	60	70	50.8 (50)	12.7 (12)	55.8 (53.5)	10	SNHT12045R/L-WX	PTMA0406F	TW15S	
200-T09	18	200	9	60	70	50.8 (50)	12.7 (12)	55.8 (53.5)	12	SNHT1205R/L-WX	PTMA0407F	TW15S	
200-T10	18	200	10	60	70	50.8 (50)	12.7 (12)	55.8 (53.5)	12	SNHT12054R/L-WX	PTMA0408F	TW15S	
200-T11	18	200	11	60	70	50.8 (50)	12.7 (12)	55.8 (53.5)	14	SNHT1206R/L-WX	PTKA0409F	TW15S	
200-T12	18	200	12	60	70	50.8 (50)	12.7 (12)	55.8 (53.5)	14	SNHT12065R/L-WX	PTKA0410F	TW15S	
200-T13	18	200	13	60	70	50.8 (50)	12.7 (12)	55.8 (53.5)	16	SNHT1207R/L-WX	PTKA0411F	TW15S	
200-T14	18	200	14	60	70	50.8 (50)	12.7 (12)	55.8 (53.5)	16	SNHT12075R/L-WX	PTKA0412F	TW15S	
250-T06	20	250	6	88	70	50.8 (50)	12.7 (12)	55.8 (53.5)	8	SNHT12035R/L-WX	PTMA04045F	TW15S	
250-T07	20	250	7	88	70	50.8 (50)	12.7 (12)	55.8 (53.5)	10	SNHT1204R/L-WX	PTMA0405F	TW15S	
250-T08	20	250	8	88	70	50.8 (50)	12.7 (12)	55.8 (53.5)	10	SNHT12045R/L-WX	PTMA0406F	TW15S	
250-T09	20	250	9	88	70	50.8 (50)	12.7 (12)	55.8 (53.5)	12	SNHT1205R/L-WX	PTMA0407F	TW15S	
250-T10	20	250	10	88	70	50.8 (50)	12.7 (12)	55.8 (53.5)	12	SNHT12054R/L-WX	PTMA0408F	TW15S	
250-T11	20	250	11	88	70	50.8 (50)	12.7 (12)	55.8 (53.5)	14	SNHT1206R/L-WX	PTKA0409F	TW15S	
250-T12	20	250	12	88	70	50.8 (50)	12.7 (12)	55.8 (53.5)	14	SNHT12065R/L-WX	PTKA0410F	TW15S	
250-T13	20	250	13	88	70	50.8 (50)	12.7 (12)	55.8 (53.5)	16	SNHT1207R/L-WX	PTKA0411F	TW15S	
250-T14	20	250	14	88	70	50.8 (50)	12.7 (12)	55.8 (53.5)	16	SNHT12075R/L-WX	PTKA0412F	TW15S	

Available inserts **E23**

() Metric size



E Technical Information for High feed Cutter

High feed cutter with extra pitch for cast iron and light alloy steels

High feed Cutter

- High feed cutter employs extra pitch for cast iron and light alloy steels
- Quick change type for reduction of cutter change time
- Cutting-edge chatter is controlled
- Quick change type for cutter size under $\phi 160$, 2 piece types for cutter size over $\phi 200$

Guide of insert setting

- Special equipment has to be used to get precise run out with high feed cutter.

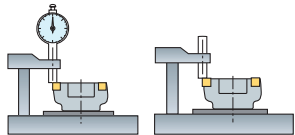
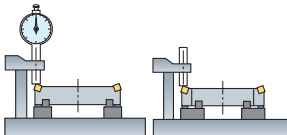
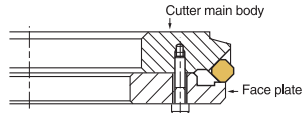
Adaptor type	Roller type	Plate type
		
<ul style="list-style-type: none"> - Mainly under $\phi 160$ diameter is used in 1 piece type - Available for fixed size of cutter and assembling & checking can be done at the same time 	<ul style="list-style-type: none"> - Mainly over $\phi 200$ diameter is used in 2 piece type - Due to 3 adjustable guide rollers, variety size of cutter can be assembled 	<ul style="list-style-type: none"> - Suitable for small size cutter due to the simple structure - It is unnecessary to unclamp the cutter from the machine, it's possible to reassemble the cutter as it mounted on the machine - You should make plate by yourself

Guide of insert setting in adaptor/roller type

1. Clean the cutter and equipment
2. Pointer should be assembled with same height with cutter
3. Move to each insert on tip seat to end of pointer and tighten (torque 2 N.m) wedge
4. Exchange pointer to dial gauge
5. Measure the run-out totally
6. When a insert over run-out, loosen wedge and adjust run-out. (for roughing 10~20 μ , for finishing 5~10 μ)
7. Tighten (torque 7-8 N.m) wedge
8. Measure the final run-out by dial gauge

Note: When you clamp wedge too tightly, run-out will get worse due to cutter distortion.
When you clamp the wedge, use torque wrench to set precisely.

Adaptor ($\phi 200 \sim \phi 450$)

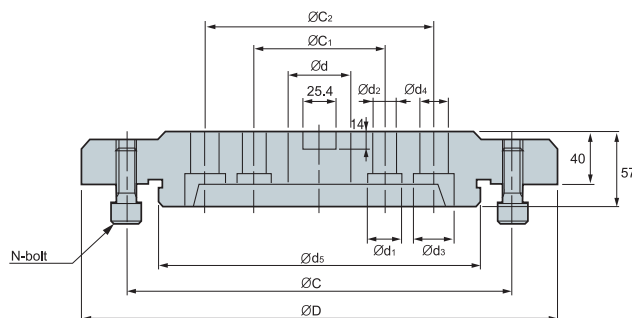

Designation	ϕD	ϕd	ϕd_1	ϕd_2	ϕd_3	ϕd_4	ϕd_5	ϕC	ϕC_1	ϕC_2	N	Cutter
APR 200	180	47.625	26	18	-	-	80	120	101.6	-	4	$\phi 200$
250	230	47.625	26	18	-	-	120	170	101.6	-	4	$\phi 250$
315	295	47.625	26	18	32	22	180	230	101.6	177.8	6	$\phi 315$
355	335	63.50	26	18	32	22	220	270	101.6	177.8	6	$\phi 355$
400	370	63.50	26	18	32	22	250	300	101.6	177.8	8	$\phi 400$
450	420	63.50	26	18	32	22	300	350	101.6	177.8	8	$\phi 450$

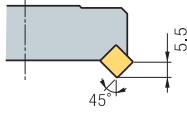
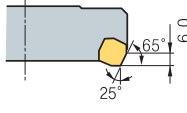
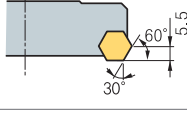
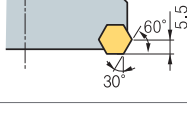
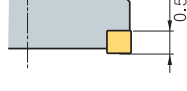
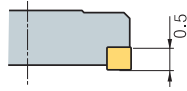

High feed cutters type and features

Designation	Cutter diameter	Workpiece, Application range	Min. surface roughness	Approach angle and Max. cutting depth is for 5000 type	Axial rake angle	Radial rake angle	Available insert
ANH4000 ANH5000	Ø100~Ø450	Cast iron Roughing	25Z		-5°	-6°	SNCN1204ENN SNCN1504ENN
CDH4000 CDH5000	Ø100~Ø450	Cast iron Roughing Finishing	18Z		+10°	+5°	SDCN42R SDCN53R
DEH5000	Ø100~Ø450	Al alloy Roughing	20Z		+14°	+6°	HECN090408FN
DPH5000	Ø100~Ø450	Cast iron Roughing Finishing	12Z		+5°	-3°	HPEN090408 HPEN090408-WC
PNH4000 PNH5000	Ø125~Ø450	Cast iron Finishing	12Z		-5°	-6°	SNEF435 SNEF535
PPH4000	Ø125~Ø450	Cast iron Finishing	12Z		+5°	-5°	SPEN120416-WC

Recommended cutting condition

Workpiece	Cutting condition		Grades	Remark
	vc (m/min)	fz (mm/t)		
Cast iron	100~230	0.05~0.20	PC6510	PVD Coated
	80~150	0.05~0.20	H01, G10	Uncoated
Al alloy	400	0.10~0.30	PC6510	PVD Coated
	400	0.05~0.20	H01, G10	Uncoated

E Technical Information for Cube Mill

Special Korloy cutter for cast iron roughing

Cube Mill

- Special Korloy cutter for cast iron roughing
- 8-corner using insert (maximum 16-corner available with 2 cutter, R/L cutter)
- Excellent cutting performance with positive rake angle made by 3-dimensional chip breaker
- Excellent tool life by a wide combination of grade varieties and chip breakers to match most working conditions
- 2 different type of inserts (chamfer/nose R) are available with 1 type cutter



Roughing for cast iron

Code system

CBM	E	3	250	R	(2)	- 28Z
Cutter	AA	Inscribed circle of insert	Cutter Dia	Hand	Cutter shape	No. of tooth (Z)
CBM: CUBE MILL	Q: 88° C: 65° F: 85° A: 45° E: 75°	3: 9.525 4: 12.7	Ø250	R: Right L: Left	Unmarked: Normal type 2: Quick change type (2 pieces type)	

• Cube Mill and Cube Mill Couple are available by order made.

Insert (R/L type)

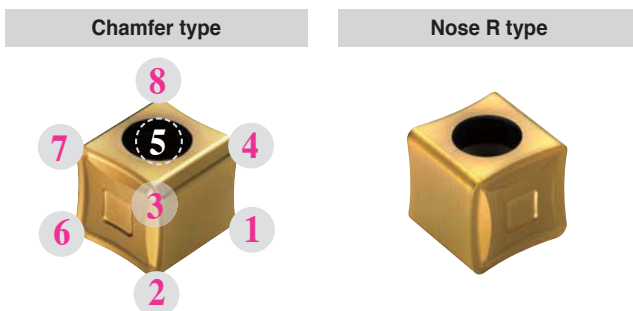

Cutter body

Cutter diameter (Ø)	General	Quick change
	Ø80~315 mm	Ø200~450 mm
	3 1/4~12 1/2 Inch	8~18 Inch

AA: 88°, 85°, 75°, 65°, 45°

Cutter



- Special design to make actual positive rake angle
- Simple screw on system

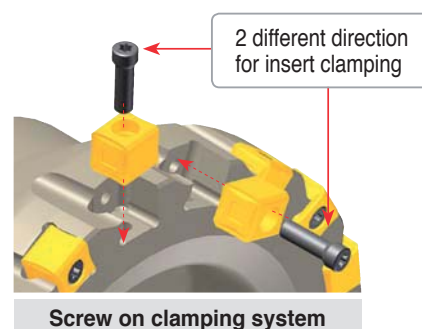

Parts

<p>Cube Mill 3000</p>	<p>Screw</p>	<p>Wrench</p>
	FTGA0417CBM	TW15-100
	ETGA0520CBM	TW20-100



Ideal combination of aluminum body with cast iron high feed cutter

Couple Mill

- Ideal combination of Aluminum body with cast iron high feed cutter
- Since the weight of the cutter has been reduced 50% vs. a steel cutter, it is very easy to handle and very effective in preventing loading accidents
- Applicable for Cube Mill, Storm Mill

☛ Cube-couple code system

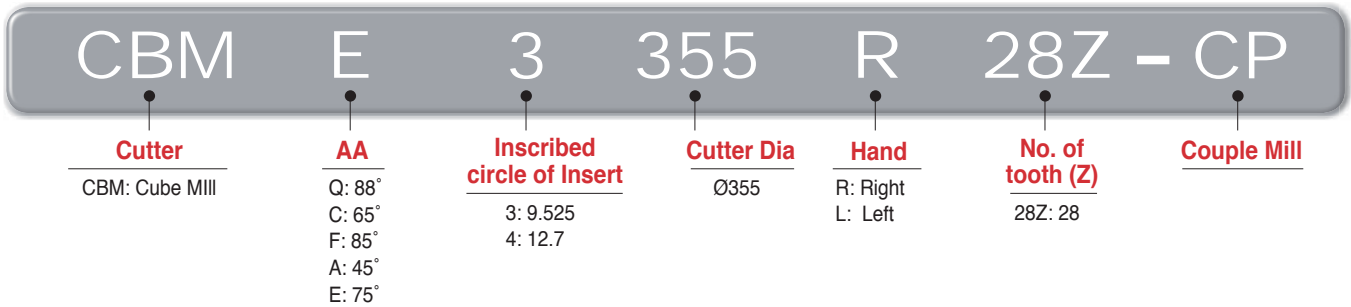

☛ Storm-couple code system

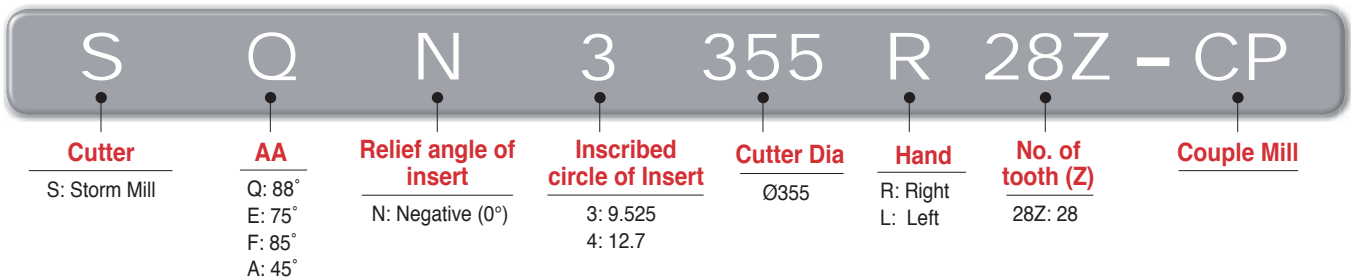

☛ Assembling structure

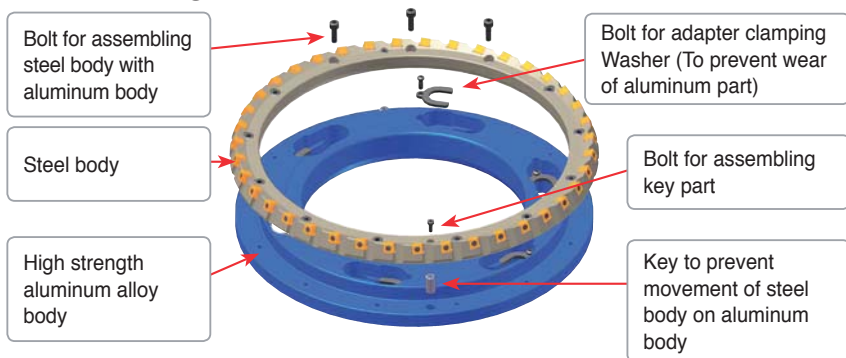

☛ Cutter body

Cutter diameter (Ø)	Quick change	
	Metric	Ø355~450 mm
Inch	14 1/4~18 Inch	

☛ Parts

Parts	Image	Part Name	Part Number	Part Name	Part Number	Part Name	Part Number
Cube-Couple		Screw	FTGA0417CBM	Wrench	TW15-100	Bolt for body	BHA0616
		Screw	ETGA0520CBM	Wrench	TW20-100	Bolt for key	MHBO410
Storm-Couple		Screw	FTNA0513	Wrench	TW15S	Key for body	PN1019-DRV

E Technical Information for Couple Mill

Application range of high feed cutters for cast iron

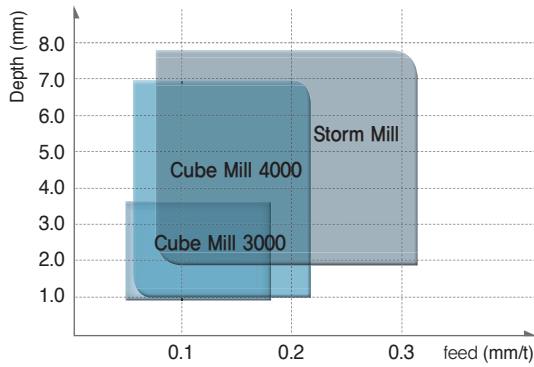

Recommended cutting condition

Cube Mill		Gray cast iron		Ductile cast iron	
		vc (m/min)	fz (mm/t)	vc (m/min)	fz (mm/t)
PVD	PC6510	150~300	0.08~0.18	100~200	0.08~0.18
Uncoated	G10	90~120	0.05~0.18	60~130	0.05~0.18

Available arbors and adaptors

Designation	Available arbors and adaptors		
	Arbors	General arbor	Adaptor
CBMQ			
(CBMF)			
(CBME)			
(CBMC)			
(CBMA)			
3080R/L-00Z	BT□□-FMA25.4-□□	NT*□□(M/U)-FMA25.4-25	
3100R/L-00Z	BT□□-FMA31.75-□□	NT*□□(M/U)-FMA31.75-□□	
3125R/L-00Z	BT□□-FMA38.1-□□	NT*□□(M/U)-FMA38.1-□□	
3160R/L-00Z	BT□□-FMA50.8-□□	NT*□□(M/U)-FMA50.8-□□	
3200R/L-00Z	BT□□-FMA47.625-□□	NT*□□(M/U)-FMA47.625-25, KCP-8***	
3250R/L-00Z	BT□□-FMA47.625-□□	KNT*□□(M/U)-FMA47.625-25, KCP-8***	
3315R/L-00Z		KCP-8*** (Centering Plug)	
3200R/L2-00Z			APR200
3250R/L2-00Z			APR250
3315R/L2-00Z			APR315
3355R/L2-00Z			APR355
3400R/L2-00Z			APR400
3450R/L2-00Z			APR450
SQN			
(SFN)			
(SEN)			
(SAN)			
3080R/L-00Z	BT□□-FMA25.4-□□	NT*□□(M/U)-FMA25.4-25	
3100R/L-00Z	BT□□-FMA31.75-□□	NT*□□(M/U)-FMA31.75-□□	
3125R/L-00Z	BT□□-FMA38.1-□□	NT*□□(M/U)-FMA38.1-□□	
3160R/L-00Z	BT□□-FMA50.8-□□	NT*□□(M/U)-FMA50.8-□□	
3200R/L-00Z	BT□□-FMA47.625-□□	NT*□□(M/U)-FMA47.625-25, KCP-8***	
3250R/L-00Z	BT□□-FMA47.625-□□	NT*□□(M/U)-FMA47.625-25, KCP-8***	
3315R/L-00Z		KCP-8*** (Centering Plug)	
3200R/L2-00Z			APR200
3250R/L2-00Z			APR250
3315R/L2-00Z			APR315
3355R/L2-00Z			APR355
3400R/L2-00Z			APR400
3450R/L2-00Z			APR450

*□□-NT number / **□□-BT number / ***Milling over 5
 <Arbors **add>
 ex) BT**□□



Excellent tool life achieved by the wide variety of grades to match work conditions

Storm Mill

- Conventional cutter with wide coverage
- Using 4 corners (Maximum 8 corner available with R/L type cutter)
- Effective on large depth of cut applications due to the long cutting-edge
- Excellent tool life guaranteed by wide variety of grades to suit any working conditions
- 2 different types of inserts (chamfer/nose R) are available with 1 type of cutter

Code system

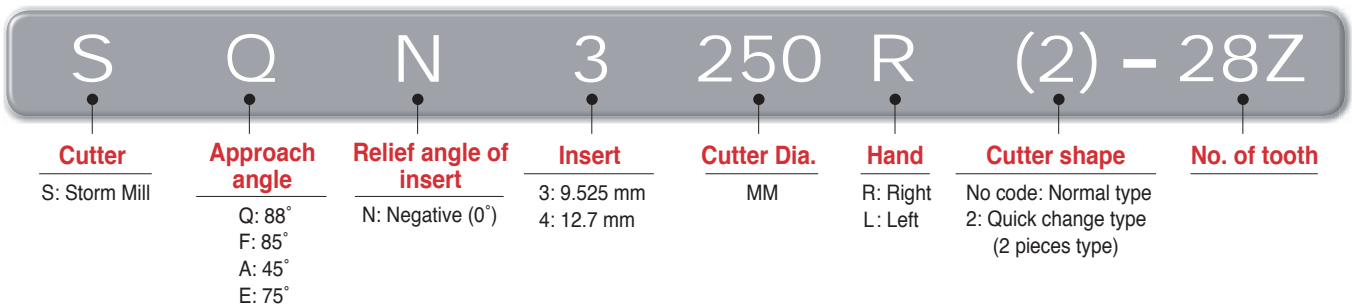

Features

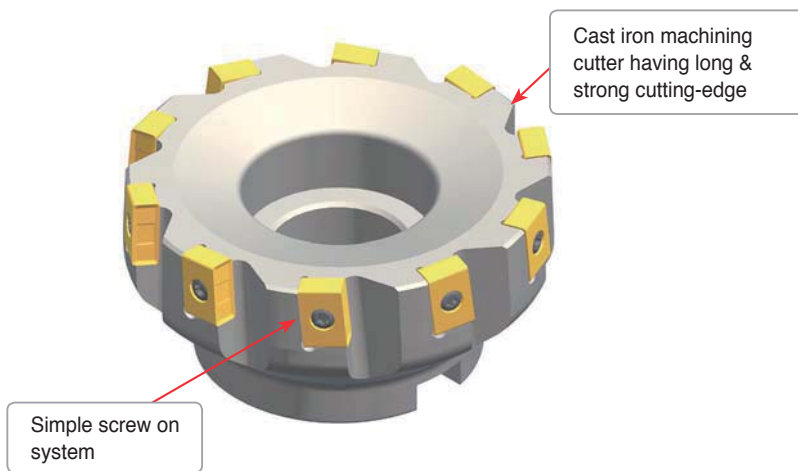

Clamping of insert

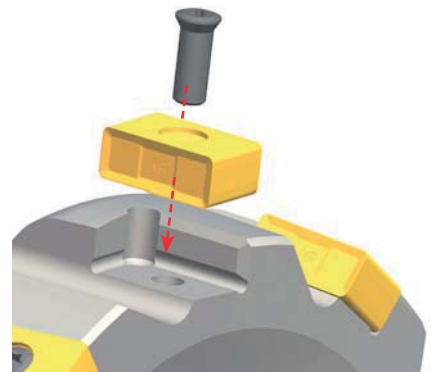

Recommended cutting condition

Grades	Designation	Gray cast iron		Ductile cast iron	
		GC		GCD	
		vc (m/min)	fz (mm/t)	vc (m/min)	fz (mm/t)
PC3500		150~250	0.08~0.28	100~180	0.08~0.28
PC6510		150~300	0.10~0.28	100~200	0.10~0.28
PC5400		150~250	0.08~0.22	100~180	0.08~0.22
H01		100~200	0.08~0.22	70~140	0.08~0.22
G10		90~120	0.08~0.28	60~130	0.08~0.28

E Technical Information for Shave Mill

Optimal cutter for steel and cast iron machining with easily adjustable run-out

Shave Mill

- Adjustable Range (Adjustable range: 0.1 mm, Adjustable allowance: within 2 μm)
- Wiper crown type 8-cornered insert reduces machining cost and realizes excellent surface roughness
- Grades with high toughness and wear resistance ensures long tool life
- The cBN grade achieves superior surface finish

➤ Cutter code system

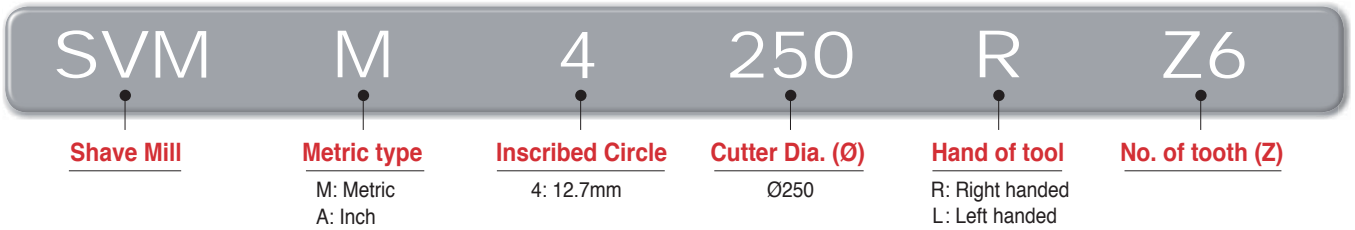

➤ Insert code system

■ Carbide

Nose R type	SNEU120420-MF
Chamfer type	SNEU1204ANN-MF
Low cutting type	SNEU1204-WMF

■ cBN

SNEU1204-TBW
T: Nagaland B: cBN W: Wiper

➤ Features

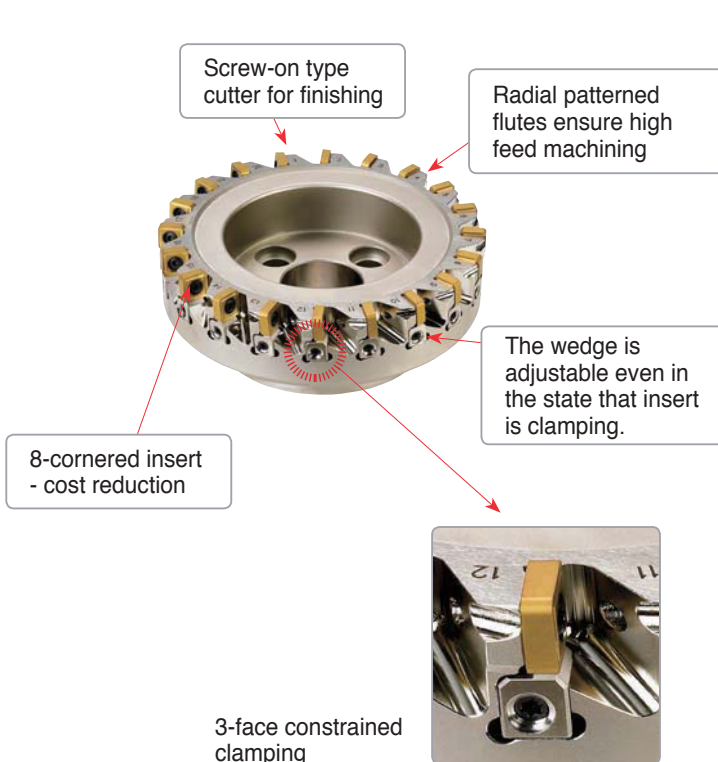

➤ Adjustment

- Adjustable range: 0.1 mm
- Adjustability: below 2 μm
- Operation: easy and simple



Features of insert

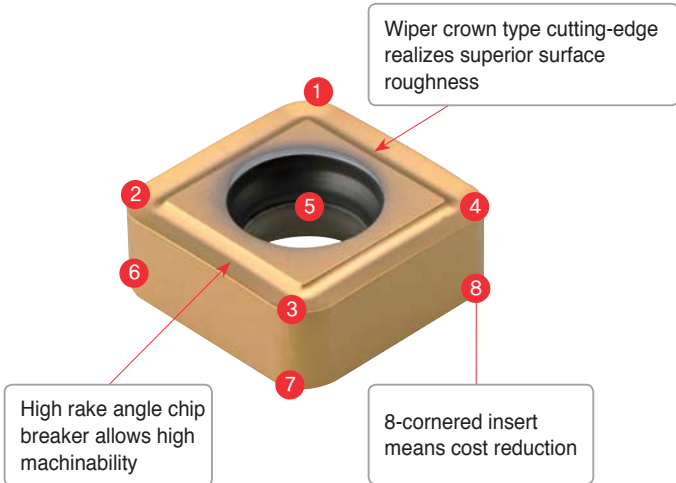

Recommended cutting condition

Workpiece	Cutting condition			Grades
	vc (m/min)	fz (mm/t)	ap (mm)	
P	160~270	0.05~0.2	~0.5	PC3700
K	140~230	0.05~0.3	~0.5	PC6510
	600~1000	0.05~0.2	~0.5	DBN920

Application example

- Workpiece: Cylinder head (facing)
- Cutting conditions: vc = 200, fz = 0.15, ap = 0.5, Dry
- Tools: Cutter SVMM4250R, Insert PC6510 SNEU120420-MF

- Workpiece: FC25 (HB250) Cylinder head (facing)
- Cutting conditions: vc = 700, fz = 0.1, ap = 0.5, Dry
- Tools: Cutter SVMM4160R, Insert DBN920 SNEU1204-cBN

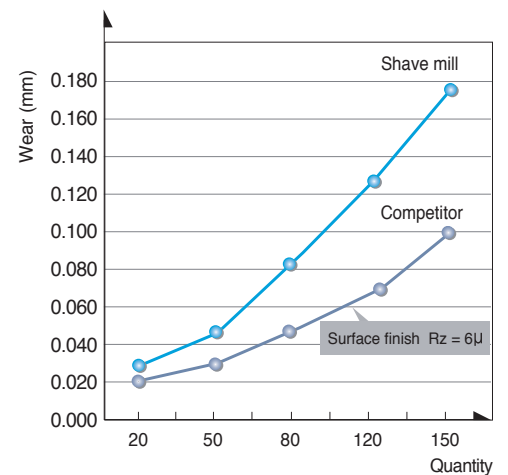

Results

	Tool life	Surface finish	Machinability
Shave Mill	250 pcs	Rz = 3µ	High
Competitor	180 pcs	Rz = 3.5µ	Normal

Korloy's Shave Mills ensure twice the machinability, adjustability, and surface roughness than competitor's, along with twice the tool life.

E Technical Information for Shave Mill-Ultra

Better tool life with special grade which has both toughness and wear resistance

Shave Mill-Ultra

- Superior surface roughness for this Finishing cutter when applied to heavy work pieces
- Easy to handle and good rigidity with simple screw on system
- Superior surface finishes due to the wiper crown cutting-edge
- Better tool life with special grade which has both toughness and wear resistance
- Two different types: economical normal type and adjustable run-out type 'B'

Code system of cutter

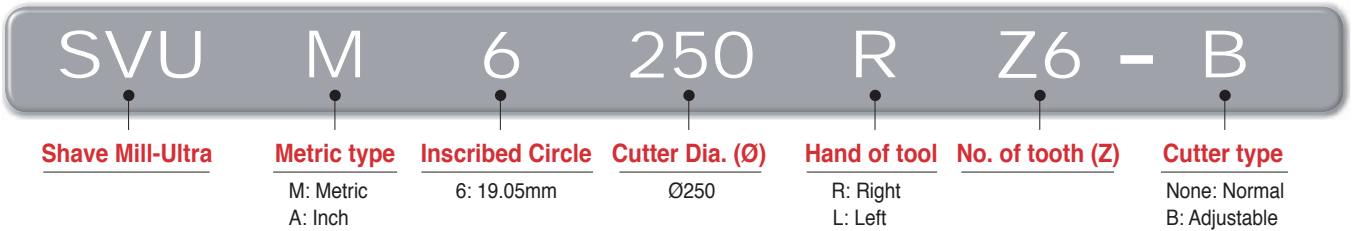

Code System of Insert



Features

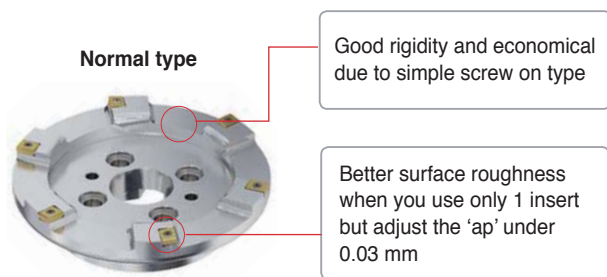

Adjustable cutting-edge (Type B)

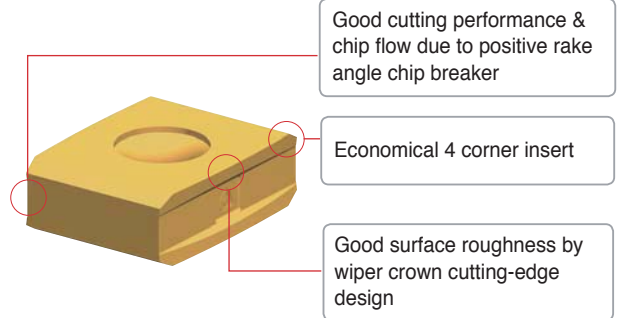
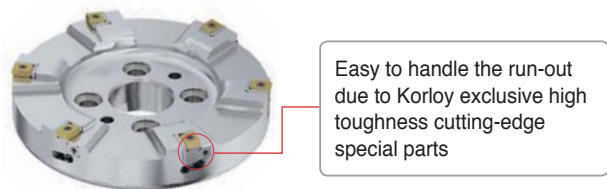

Adjustable Range

- Range: 1.0 mm
- Allowance: Within 2 μ

Recommended cutting condition

Workpiece	Cutting condition			Tooth	Grades
	vc (m/min)	fz (mm/t)	ap (mm)		
P	160~270	0.05~0.20	~0.50	Full use	PC3700
	160~270	2~5	~0.03	1 use	
K	140~230	0.05~0.20	~0.50	Full use	PC6510
	140~230	2~5	~0.03	1 use	



PNH4000/5000

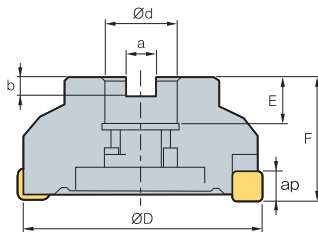

Fig. 1

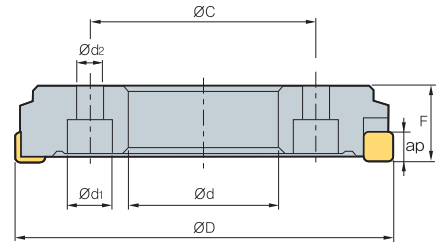

Fig. 2



AA
90°

- AR: -5°
- RR: -6°

(mm)

Designation		$\varnothing D$	$\varnothing d$	$\varnothing d_1$	$\varnothing d_2$	a	b	E	F	$\varnothing C$	ap		Fig.
PNH	4125R/L	10	125	38.1	-	15.9	10	27	63	-	Max 0.5	3.4	1
	4160R/L	14	160	50.8	-	19.0	11	27	63	-	Max 0.5	5.5	1
	4200R/L	18	200	80	24	14	-	-	40	120	Max 0.5	5.5	2
	4250R/L	24	250	120	30	18	-	-	40	170	Max 0.5	7.7	2
	4315R/L	30	315	180	30	18	-	-	40	230	Max 0.5	10.5	2
	4355R/L	34	355	220	30	18	-	-	40	270	Max 0.5	12.9	2
	4400R/L	38	400	250	30	18	-	-	40	300	Max 0.5	16.1	2
	4450R/L	44	450	300	30	18	-	-	40	350	Max 0.5	19.1	2
PNH	5125R/L	10	125	38.1	-	15.9	10	27	63	-	Max 0.5	3.4	1
	5160R/L	14	160	50.8	-	19.0	11	27	63	-	Max 0.5	5.3	1
	5200R/L	18	200	80	24	14	-	-	40	120	Max 0.5	5.4	2
	5250R/L	24	250	120	30	18	-	-	40	170	Max 0.5	7.6	2
	5315R/L	30	315	180	30	18	-	-	40	230	Max 0.5	10.4	2
	5355R/L	34	355	220	30	18	-	-	40	270	Max 0.5	12.8	2
	5400R/L	38	400	250	30	18	-	-	40	300	Max 0.5	15.9	2
	5450R/L	44	450	300	30	18	-	-	40	350	Max 0.5	18.9	2

Available inserts

SNEF



Designation	Cermet		Coated										Uncoated			page			
	CN2000	CN30	NCM325	NC5330	NCM635	NCM645	PC2505	PC2010	PC3600	PC3700	PC6510	PC9530	PC9540	PC5300	PC5400		ST30A	G10	H01
SNEF 435											●								E21

Available arbors

Designation	NC arbors
PNH 125R/L	NT*□□(M/U)-FMA38.1-□□
160R/L	NT*□□(M/U)-FMA50.8-□□
200R/L	- APR200
250R/L	- APR250
315R/L	- APR315
355R/L	- APR355
400R/L	- APR400
450R/L	- APR450

Recommended cutting condition

Workpiece	Cutting condition		Grades
	vc (m/min)	fz (mm/t)	
K	140~230	0.05~0.30	PC6510
	135~220	0.10~0.30	H01
	50~90	0.10~0.30	G10

Assembling

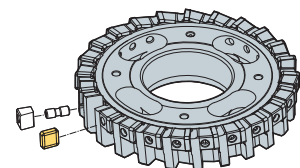

Parts

Specification			
$\varnothing 125\sim\varnothing 450$	WPNH4N	DHA0821F	HW40
$\varnothing 125\sim\varnothing 450$	WPNH5N		

Available inserts E21 Available arbors and bolt E400~E402

PPH4000

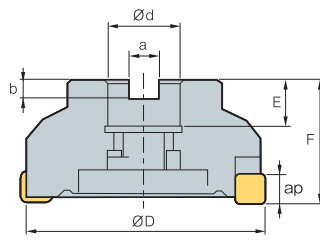

Fig. 1

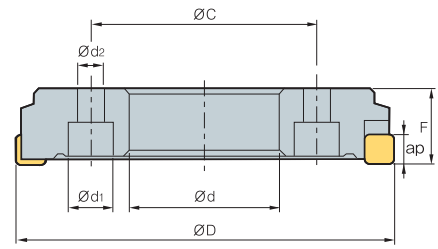

Fig. 2



AA
90°

• AR: 5°
• RR: -6°

(mm)

Designation		$\varnothing D$	$\varnothing d$	$\varnothing d_1$	$\varnothing d_2$	a	b	E	F	$\varnothing C$	ap		Fig.
PPH 4125R/L	10	125	38.1	-	-	15.9	10	27	63	-	Max 0.5	3.4	1
4160R/L	14	160	50.8	-	-	19.0	11	27	63	-	Max 0.5	5.3	1
4200R/L	18	200	80	24	14	-	-	-	40	120	Max 0.5	5.5	2
4250R/L	24	250	120	24	14	-	-	-	40	170	Max 0.5	7.7	2
4315R/L	30	315	180	30	18	-	-	-	40	230	Max 0.5	10.5	2
4355R/L	34	355	220	30	18	-	-	-	40	270	Max 0.5	13	2
4400R/L	38	400	250	30	18	-	-	-	40	300	Max 0.5	16	2
4450R/L	44	450	300	30	18	-	-	-	40	350	Max 0.5	19	2

Available inserts

SPEN-WC



Designation	Cermet		Coated										Uncoated			page			
	CN2000	CN30	NCM325	NC5330	NCM535	NCM545	PC2505	PC2010	PC3600	PC3700	PC6510	PC9530	PC9540	PC5300	PC5400		ST30A	G10	H01
SPEN 120416-WC																			E24

Available arbors

Designation	NC arbors
PPH 4125R/L	NT*□□(M/U)-FMA38.1-□□ -
4160R/L	NT*□□(M/U)-FMA50.8-□□ -
4200R/L	- APR200
4250R/L	- APR250
4315R/L	- APR315
4355R/L	- APR355
4400R/L	- APR400
4450R/L	- APR450

Recommended cutting condition

Workpiece	Cutting condition		Grades
	vc (m/min)	fz (mm/t)	
K	140~230	0.05~0.30	PC6510
	135~220	0.10~0.30	H01
	50~90	0.10~0.30	G10

Assembling

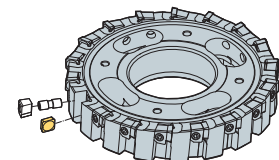

Parts

Specification			
$\varnothing 125 \sim \varnothing 450$	WPPH4R/L	DHA0821F	HW40

Available inserts E24

Available arbors and bolt E400~E402



SVM(M)4000

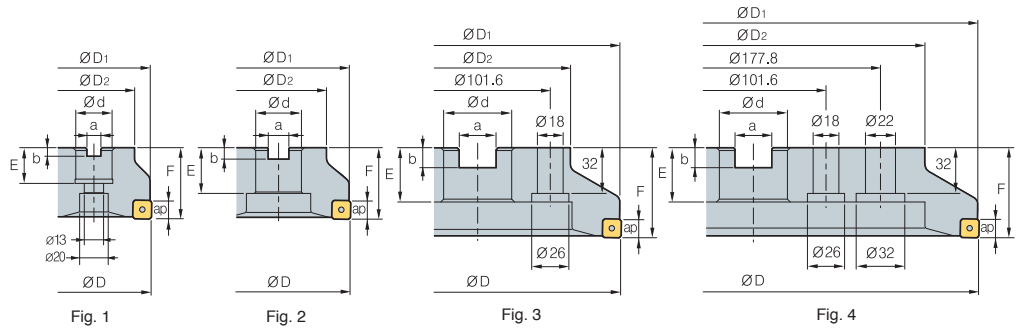

(mm)

Designation		ØD	ØD ₁	ØD ₂	Ød	a	b	E	F	ap		Fig.	
SVM	4080R/L-Z8	8	80	79	57	25.4	12.4	6	25	50	1.0	1.2	1
	4100R/L-Z12	12	100	99	67	31.75	14.4	8	32	63	1.0	2.3	1
	4125R/L-Z16	16	125	124	87	38.1	16.4	10	38	63	1.0	3.5	2
	4160R/L-Z20	20	160	159	107	50.8	16.4	11	38	63	1.0	5	2
	4200R/L-Z24	24	200	199	130	47.625	25.7	14	38	63	1.0	7.2	3
	4250R/L-Z30	30	250	249	180	47.625	25.7	14	38	63	1.0	12	3
	4315R/L-Z36	36	315	314	240	47.625	25.7	14	38	63	1.0	19.5	4
SVMM	4080R/L-Z8	8	80	79	57	27	12.4	7	22	50	1.0	1.2	1
	4100R/L-Z12	12	100	99	67	32	14.4	8	28	63	1.0	2.3	1
	4125R/L-Z16	16	125	124	87	40	16.4	9	30	63	1.0	3.5	2
	4160R/L-Z20	20	160	159	107	40	16.4	9	30	63	1.0	5	3
	4200R/L-Z24	24	200	199	130	60	25.7	14	38	63	1.0	7.2	3
	4250R/L-Z30	30	250	249	180	60	25.7	14	38	63	1.0	12	3
	4315R/L-Z36	36	315	314	240	60	25.7	14	38	63	1.0	19.5	4

Available inserts

SNEU-MF SNEU1204ANN-MF SNEU-WMF SNEU-TBW



Designation	Cermet		Coated											추경		page		
	CN2000	CN30	NCM325	NC5330	NCM535	NCM545	PC2505	PC2010	PC3600	PC3700	PC6510	PC9530	PC9540	PC5300	PC5400		ST30A	H01
SNEU 120420-MF											●							E21 E22
1204ANN-MF																		
1204R-WMF																		
1204-TBW																		

Parts

Specification				
Ø80-Ø315	WKAJ3	DTA0619	XTKA0412	TW15-100

Available inserts E21, E22



SVUM6000

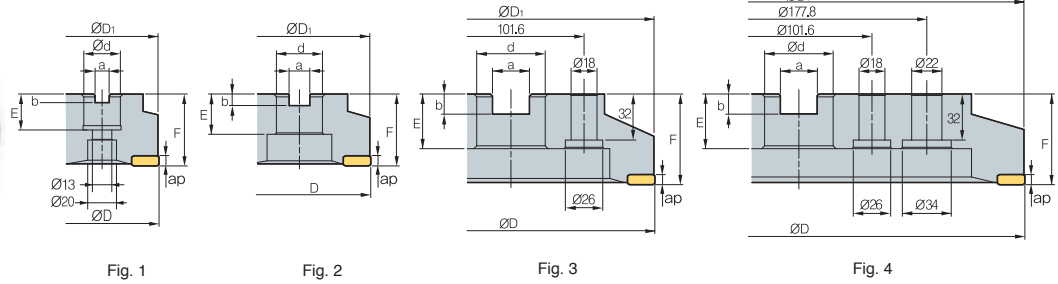

(mm)

Designation		ØD	ØD ₁	ØD ₂	Ød	a	b	E	F	ap		Fig.	
SVUM	6080R/L-Z4	4	80	79	57	27	12.4	7	22	50	0.5	1.2	1
	6100R/L-Z4	4	100	100	67	32	14.4	8	28	63	0.5	2.3	1
	6125R/L-Z4	4	125	125	87	40	16.4	9	30	63	0.5	3.5	2
	6160R/L-Z4	4	160	160	107	40	16.4	9	30	63	0.5	5	3
	6200R/L-Z6	6	200	200	130	60	25.7	14	38	63	0.5	7.2	3
	6250R/L-Z6	6	250	250	180	60	25.7	14	38	63	0.5	12	3
	6315R/L-Z8	8	315	315	240	60	25.7	14	38	63	0.5	19.5	4

Available inserts

LNCS (R3.0)

LNCS (C1.5)

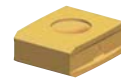
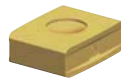

Designation	Cermet		Coated										Uncoated			page			
	CN2000	CN30	NCM325	NC5330	NCM535	NCM545	PC2505	PC2010	PC3600	PC3700	PC6510	PC9530	PC9540	PC5300	PC5400		ST30A	G10	H01
LNCS	1907-R3.0-WC																		E10
	1907-C1.5-WC																		

Parts

Specification		
Ø80~Ø315	FTNA0513	TW20-100

Available inserts E10



SVUM6000-B

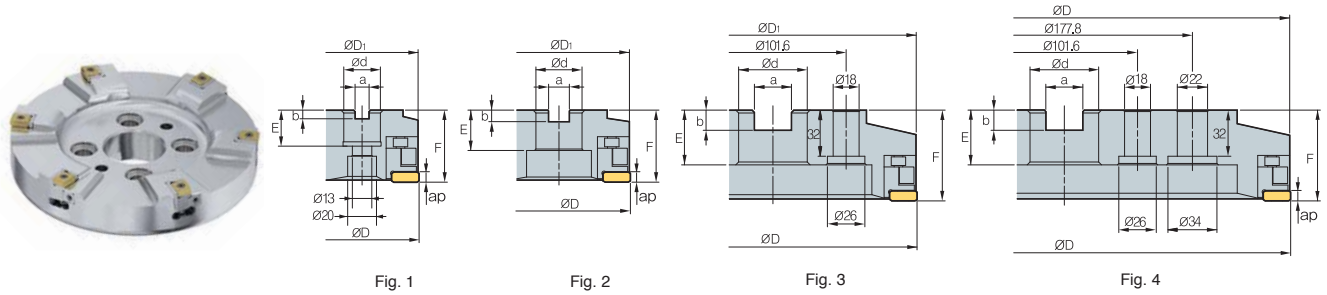

(mm)

Designation		ØD	ØD1	ØD2	Ød	a	b	E	F	ap		Fig.
SVUM 6080R/L-Z4-B	4	80	79	57	27	12.4	7	22	50	0.5	1.2	1
6100R/L-Z4-B	4	100	99	67	32	14.4	8	28	63	0.5	2.3	1
6125R/L-Z4-B	4	125	124	87	40	16.4	9	30	63	0.5	3.5	2
6160R/L-Z4-B	4	160	160	107	40	16.4	9	30	63	0.5	5	3
6200R/L-Z6-B	6	200	200	130	60	25.7	14	38	63	0.5	7.2	3
6250R/L-Z6-B	6	250	250	180	60	25.7	14	38	63	0.5	12	3
6315R/L-Z8-B	8	315	315	240	60	25.7	14	38	63	0.5	19.5	4

Available inserts

LNCS(R3.0)

LNCS(C1.5)

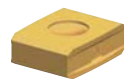
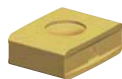

Designation	Cermet		Coated											Uncoated			page		
	CN2000	CN30	NCM325	NC5330	NCM535	NCM545	PC2505	PC2010	PC3600	PC3700	PC6510	PC9530	PC9540	PC5300	PC5400	ST30A		G10	H01
LNCS 1907-R3.0-WC																			E10
1907-C1.5-WC																			

Parts

Specification						
Ø80-Ø315	LSH4R	WSH4	DHA0724F	AZ0619F-D	FTNA0512	TW20-100

Available inserts E10

Inch

Actual designations of milling cutter

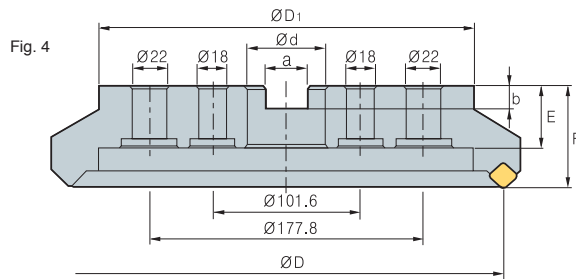
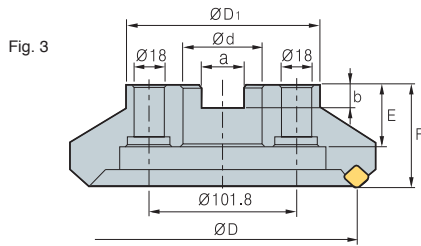
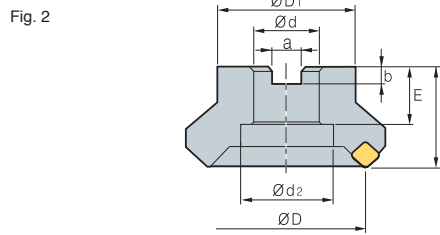
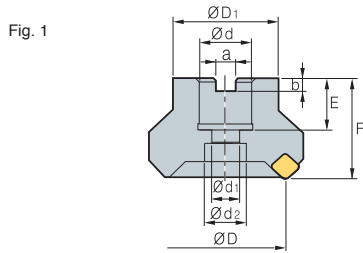

Inch type

ØD	Ød	Dimensions (mm)				Fig.	Available arbors
		a	b	E	F		
40	16	8.4	5.6	18	40	1	FMC16, SMA16
50	22	10.4	6.3	20	40	1	FMC22
63	22	10.4	6.3	20	40	1	FMC22
80	25.4	9.5	6	25	50	1	FMA25.4
100	31.75	12.7	8	32	50	2	FMA31.75, SMB31.75
125	38.1	15.9	10	38	63	2	FMA38.1
160	50.8	19	11	38	63	2	FMA50.8
200	47.625	25.4	14	38	63	3	FMA47.625
250	47.625	25.4	14	38	63	3	FMA47.625
315	47.625	25.4	14	38	63	4	-

Wrench bolt

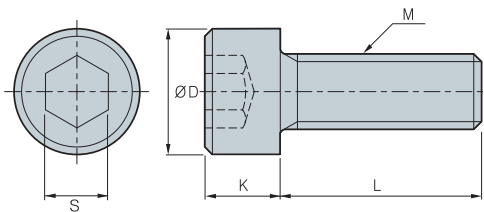

Designation	ØD	S	K	L	M	Cutter size
SB0825	13	6	8	25	M08×1.25	Ø40
SB1025	16	8	10	25	M10×1.50	Ø50, Ø63
SB1035	16	8	10	35	M10×1.50	Ø50, Ø63 (HRM)
SB1230	18	10	12	30	M12×1.75	Ø80
SB1630	24	14	16	30	M16×2.0	Ø100
SB1645	24	14	16	45	M16×2.0	Ø80, Ø100 (HRM)
SB2040	30	17	20	40	M20×2.5	Ø125

Clamp bolt

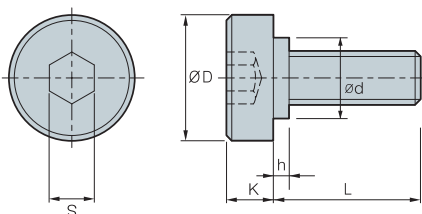

Designation	Dimensions (mm)						Cutter size
	D	L	K	S	h	d	
M8×1.25	20	20	7	6	-	-	Ø40
M10×1.5	28	24	9	8	-	-	Ø50, Ø63
M12×1.75	33	28	10	10	2	23	Ø80
M16×2	40	32	10	14	5	23	Ø100
M20×2.5	50	40	14	17	5	27	Ø125
M24×3	64	46	14	19	9	37	Ø160



Metric - ISO6462, DIN138

Clamping part of milling cutter

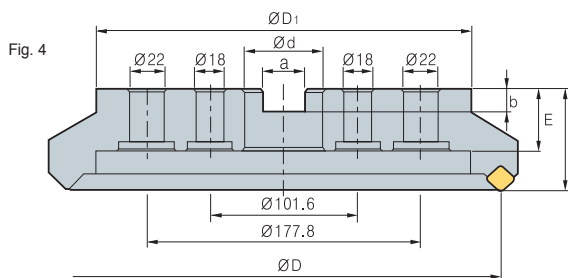
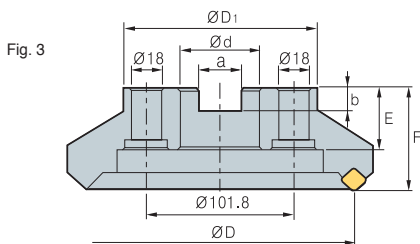
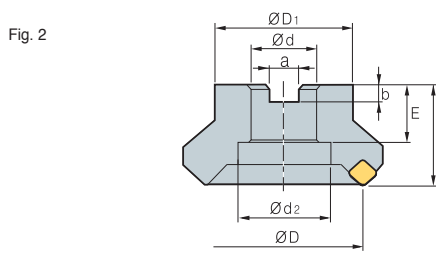
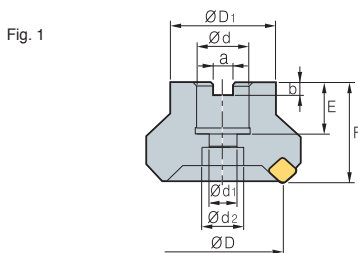

Metric type

Dimensions (mm)									Fig.	Available arbors
ØD	Ød	a	b	E	F	ØD ₁	Ød ₁	Ød ₂		
40	16	8.4	5.6	18	40	34	9	14	1	FMC16, SMA16
50	22	10.4	6.3	20	40	42	11	18	1	FMC22
63	22	10.4	6.3	20	40	49	11	18	1	FMC22
80	27	12.4	7	22	50	57	14	20	1	FMC27
100	32	14.4	8	28	50	67	-	45	2	FMC32
125	40	16.4	9	32	63	87	-	56	2	FMB40
160	40	16.4	9	32	63	107	-	-	2	FMB40
200	60	25.7	14	38	63	130	-	-	3	FMB60
250	60	25.7	14	38	63	180	-	-	3	FMB60
315	60	25.7	14	38	63	240	-	-	4	-

Wrench bolt

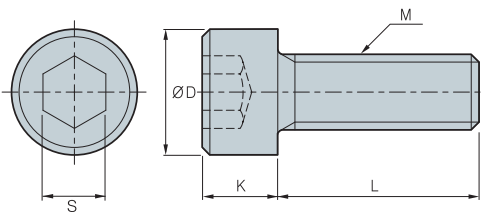

Designation	ØD	S	K	L	M	Cutter size
SB0825	13	6	8	25	M08x1.25	Ø40
SB1025	16	8	10	25	M10x1.50	Ø50, Ø63
SB1035	16	8	10	35	M10x1.50	Ø50, Ø63 (HRM)
SB1230	18	10	12	30	M12x1.75	Ø80
SB1245	18	10	12	45	M12x1.75	Ø80 (HRM)
SB1630	24	14	16	30	M16x2.0	Ø100
SB1645	24	14	16	45	M16x2.0	Ø100 (HRM)
SB2040	30	17	20	40	M20x2.5	Ø125

Clamp bolt

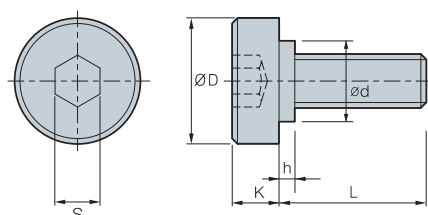

Specifications	Dimensions (mm)						Cutter size
	D	L	K	S	h	d	
M12x1.75	33	28	10	10	2	23	Ø80
M16x2	40	32	10	14	5	23	Ø100
M20x2.5	50	40	14	17	5	27	Ø125, Ø160

Clamping part of milling cutter (Oil-hole)

Clamping part of milling cutter

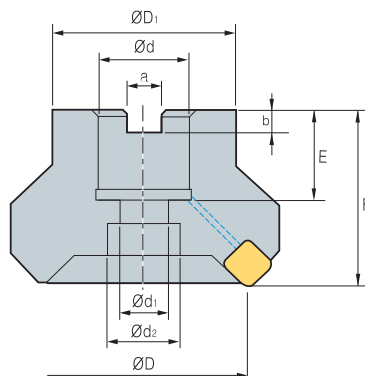

Inch type

Dimensions (mm)									Available arbors
ØD	Ød	a	b	E	F	ØD1	Ød1	Ød2	
40	16	8.4	5.6	19	40	34	9	14	FMC16, SMA16
50	22	10.4	6.3	21	40	42	11	18	FMC22
63	22	10.4	6.3	21	40	49	11	18	FMC22
80	25.4	9.5	6	24	50	57	14	20	FMA25.4, FMB25.4
100	31.75	12.7	8	32	63	67	18	26	FMA31.75, SMB31.75
125	38.1	15.9	10	35	63	87	22	32	FMA38.1, FMB38.1, FMC38.1

Metric type

Dimensions (mm)									Available arbors
ØD	Ød	a	b	E	F	ØD1	Ød1	Ød2	
40	16	8.4	5.6	19	40	34	9	14	FMC16, SMA16
50	22	10.4	6.3	21	40	42	11	18	FMC22
63	22	10.4	6.3	21	40	49	11	18	FMC22
80	27	12.4	7.0	23	50	57	14	20	FMC27
100	32	14.4	8.0	25	50	67	18	26	FMC32
125	40	16.4	9.0	29	63	87	22	32	FMB40/FMC40

Wrench bolt

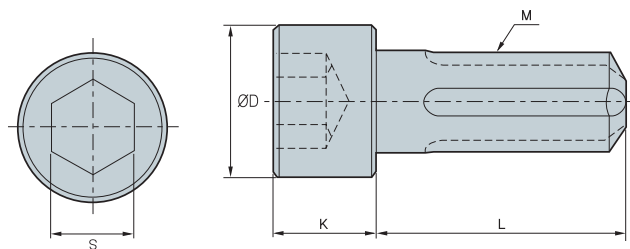





Designation	ØD	S	K	L	M	Cutter size
CB0825	13	6	8	25	M08x1.25	Ø40
CB1025	16	8	10	25	M10x1.50	Ø50, Ø63
CB1035	16	8	10	35	M10x1.50	Ø50, Ø63 (HRM)
CB1230	18	10	12	30	M12x1.75	Ø80
CB1245	18	10	12	45	M12x1.75	Ø80 (HRM)
CB1630	24	14	16	30	M16x2.0	Ø100
CB1645	24	14	16	45	M16x2.0	Ø100 (HRM)
CB2040	30	17	20	40	M20x2.5	Ø125







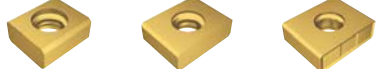

Gear cutter applicable example

Applicable example-external tooth gear

Finishing: M20	Semi-finishing	Roughing
 <ul style="list-style-type: none"> ■ Cutter Dia: Ø400 ■ Tooth No: 20 tooth ■ External tooth gear: Formal cutter for gear processing which can be expected to KS 4 level accuracy ■ Cutter can simultaneously chamfer while milling  <p>M20XZ130-EX</p>	 <ul style="list-style-type: none"> ■ Cutter Dia: Ø280 ■ Tooth No: 48 tooth ■ Designed for processing of external gear involute curve line shape ■ Possible to work for gear root portion R with optimal insert R design  <p>M20-M22-ROU</p>	 <ul style="list-style-type: none"> ■ Cutter Dia: Ø300 ■ Tooth No: 60 tooth ■ High feed rate with low cutting resistance due to V shape insert setting design  <p>LNE333-02-1 LNE434-02-1 KEL1906-C0.6-MF</p>

Applicable example-internal tooth gear

Finishing: M16	Semi-finishing	Roughing
 <ul style="list-style-type: none"> ■ Cutter Dia: Ø400 ■ Tooth No: 20 tooth ■ Internal tooth gear: Formal cutter for gear processing which can be expected to KS 4 level accuracy ■ Cutter can simultaneously chamfer while milling  <p>M16XZ130</p>	 <ul style="list-style-type: none"> ■ Cutter Dia: Ø280 ■ Tooth No: 48 tooth ■ The semi-finishing cutter was designed for processing of external gear involute curb line shape  <p>M16-M18-ROU LNE433-R60</p>	 <ul style="list-style-type: none"> ■ Cutter Dia: Ø560 ■ Tooth No: 40 tooth ■ Possible to use for gear processing of all module due to step type of insert setting design  <p>KEL1906-C0.6-MF LNE434-02-1</p>

Gear cutter machining example





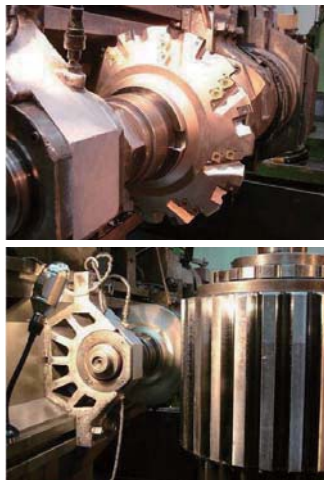





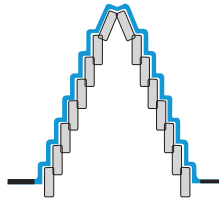

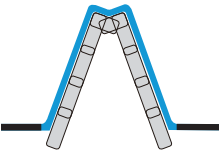

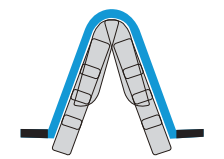

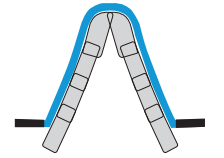
- **Machine**
Gleason-PFAUTER CNC Hobbing Machine (Power: 52kW)
- **Cutting condition**
vc = 119.98 m/min (n = 86.8 rpm)
fz = 0.518 mm/t (vf = 450 mm/min)
ae = 36 mm
Dry
- **Tools**
M16-PT-RACK-KOR03 (Ø440xW90)
- **Semi-finishing cutter (low cut, low resistance)**

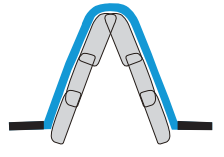

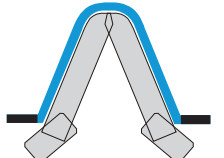
- **Machine**
KARATS (30kw)
- **Cutting condition**
vc = 150 m/min, n = 119 rpm
fz = 0.09 mm/t, vf = 81.6 mm/min
ae = 45 mm
Dry
- **Tools**
M24 Semi-finishing External type Applicable Insert
M40-ROU (Main),
CPE424-01 (Flank)

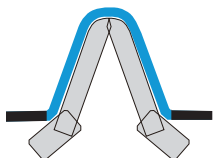
E Gear Cutter Table

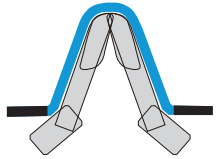
Type	Cutter shape	Cutting-edge shape	Type	Figure
Roughing			Step type	<ul style="list-style-type: none"> • Working for big sized gear tooth • Low cutting resistance with step type insert setting
			V shape type	<ul style="list-style-type: none"> • Low cutting resistance with V shape cutting insert setting • Optimal cutting-edge line setting according to Rach type & cutting-edge shape
Semi-finishing			Low cutting resistance type	<ul style="list-style-type: none"> • 4-Corner insert on Root portion • 3D chip breaker shape on flank • Optimal cutting-edge line setting for low cutting resistance
			External gear high rigidity type	<ul style="list-style-type: none"> • Optimal R type insert setting on Root portion • Superior Semi-finishing cutting with high rigidity shape of cutter & insert
			Internal gear high rigidity type	<ul style="list-style-type: none"> • Exclusive semi-finishing Internal Gear insert • Optimal cutting-edge line setting with Internal tooth shape
Finishing			External gear	<ul style="list-style-type: none"> • Concave shape of cutting-edge line according to external gear type • Optimal cutting insert setting design according to a customer conditions
			Internal gear	<ul style="list-style-type: none"> • 2-corner insert setting on right & left side and chamfering insert setting • Adjustable chamfering cartridge use for chamfering control
			2 STEP type	<ul style="list-style-type: none"> • Exclusive insert for machining the root part • 4-cornered insert

• Optimal cutting insert setting design according to customer condition



Gear Roughing Cutter (Step type)

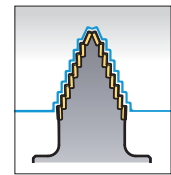
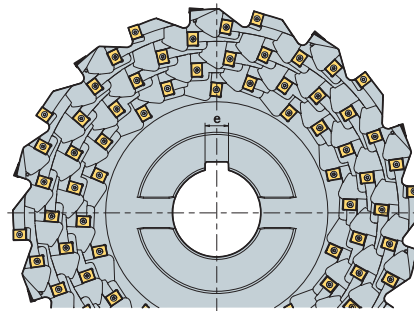
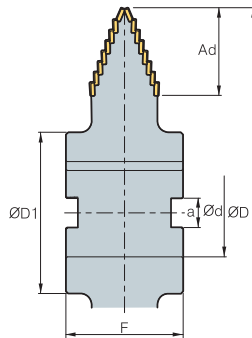

(mm)

m		ØD	Ad	Ød	ØD ₁	a	e	F
30	96	450	90	100	180	25	14	140
	108	500	90	100	180	25	14	140
	120	560	90	120	220	40	32	160
40	112	450	105	100	180	25	14	140
	126	500	105	100	180	25	14	140
	140	560	105	120	220	40	32	160
50	160	560	119	120	220	40	32	160

Available inserts

(mm)

Picture	Designation	Coated				Uncoated		Dimensions					Configuration
		NC5330	PC9530	PC3500	PC5300	H01	G10	l	d	t	d ₁	c	
 Reinforced cutting-edge	LNE 434-02-1			○	◎			19.05	14.29	6.35	5.4	0.6	
	KEL 1906-C0.6-MF 190610-MR			○	◎			19.05	14.29	6.35	5.4	0.6	
 Low cutting resistance				○	◎			19.05	14.29	6.35	5.4	-	

※ The above specification is subject to change according to customer related condition & Korloy technical condition

©: 1st Rec ○: 2nd Rec

Gear Roughing Cutter (V shape type)

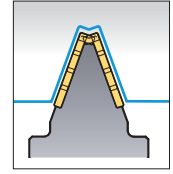
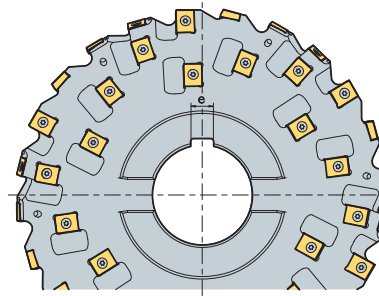
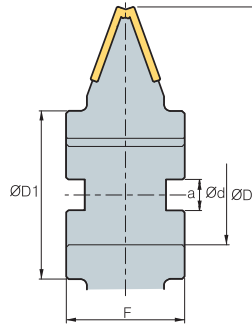

(mm)

m	Type		$\varnothing D$	$\varnothing d$	$\varnothing D_1$	a	e	F
20	rack	48	280	80	135	25	18	95
22	rack	48	280	80	135	25	18	95
24	rack	48	320	80	145	25	18	105
26	rack	60	320	80	145	25	18	105
28	rack	96	400	100	180	25	24	130
30	rack	96	400	100	180	25	24	130
32	rack	96	400	100	180	25	24	130
34	rack	112	400	100	180	25	24	130
36	rack	112	450	100	180	25	24	130
38	rack	112	450	100	180	25	24	130
40	rack	128	450	100	180	25	24	160
42	rack	128	450	100	180	25	24	160
44	rack	128	560	120	220	32	32	160
46	rack	144	560	120	220	32	32	160
48	rack	144	560	120	220	32	32	160
50	rack	144	560	120	220	32	32	160

Available inserts

(mm)

Picture	Designation	Coated				Uncoated		Dimensions					Configuration
		NC5330	PC9530	PC3500	PC5300	H01	G10	l	d	t	d _t	c	
 Reinforced cutting-edge	LNE 434-02-1			○	◎			19.05	14.29	6.35	5.4	0.6	
 Low cutting resistance	LNE 1906-C0.6-MF 190610-MR			○	◎			19.05	14.29	6.35	5.4	-	
 Reinforced cutting-edge	KEL 333-02-1			○	◎			14.3	12.7	6.35	5.8	0.8	
 Reinforced cutting-edge	CNHQ 1005-C0.5							10	10	5.4	-	-	

* The above specification is subject to change according to customer related condition & Korloy technical condition

◎: 1st Rec ○: 2nd Rec



Gear Semi-finishing Cutter (Low cutting resistance type)

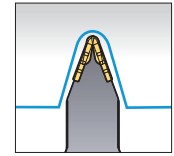
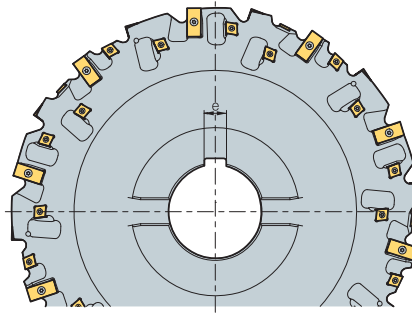
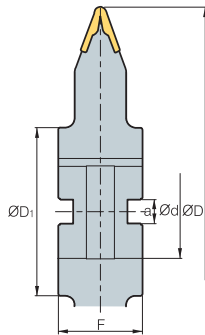

(mm)

m	No. of teeth		ØD	Ød	ØD ₁	a	e	F
6	30,60,120	18	250	60	100	25	18	70
8	30,60,120	18	250	60	100	25	18	80
10	30,60,120	24	250	60	100	25	18	80
12	30,60,120	24	250	60	100	25	18	90
14	30,60,120	24	280	80	135	25	24	95
16	30,60,120	32	280	80	135	25	24	100
18	30,60,120	32	320	80	145	25	24	105
20	30,60,120	64	400	100	180	25	24	110
22	30,60,120	64	400	100	180	25	24	110
24	30,60,120	64	400	100	180	25	24	120

Available inserts

(mm)

Picture	Designation	Coated				Uncoated		Dimensions					Configuration
		NC5330	PC9530	PC3500	PC5300	H01	G10	l	d	t	d ₁	c	
	M6-2ST			○	◎			19.05	11.6	3.8	4.4	2.25	
	M8-2ST			○	◎			19.05	11.6	4	4.4	3	
	M10-2ST			○	◎			19.05	11.6	4.76	4.4	3.75	
	M12-2ST			○	◎			19.05	14.3	6.35	5.5	4.5	
	M14-2ST			○	◎			25.4	14.3	6.35	5.5	5.25	
	M16-2ST			○	◎			31.8	14.3	7.14	5.5	6	
	M18-2ST			○	◎			31.8	14.3	7.14	5.5	6.75	
	M20-2ST			○	◎			31.8	14.3	9.52	5.5	7.5	
	M22-2ST			○	◎			31.8	14.3	9.52	5.5	8.25	
M24-2ST			○	◎			31.8	14.3	9.52	5.5	9		
	KEC 120606-MX			○	◎			12	12.7	6.35	4.5	-	
	150708-MX			○	◎			15.15	15	7.6	5.8	-	

※ The above specification is subject to change according to customer related condition & Korloy technical condition

◎: 1st Rec ○: 2nd Rec

Gear Semi-finishing Cutter (High rigid edge type, External gear)

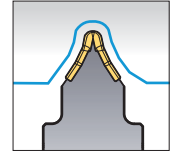
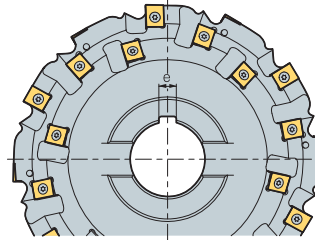
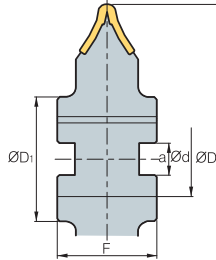

(mm)

m	No. of teeth		ØD	Ød	ØD ₁	a	e	F
12	30, 60, 120	24	250	60	100	25	14	70
14	30, 60, 120	36	250	60	100	25	14	80
16	30, 60, 120	36	250	60	100	25	14	80
18	30, 60, 120	36	250	60	100	25	14	90
20	30, 60, 120	48	280	80	135	25	18	95
22	30, 60, 120	48	280	80	135	25	18	100
24	30, 60, 120	48	320	80	145	25	18	105
26	30, 60, 120	72	400	100	180	25	24	110
28	30, 60, 120	72	400	100	180	25	24	110
30	30, 60, 120	72	400	100	180	25	24	120
32	30, 60, 120	84	400	100	180	25	24	130
34	30, 60, 120	84	400	100	180	25	24	130

Available inserts

(mm)

Picture	Designation	Coated				Uncoated		Dimensions					Configuration	
		NC5330	PC9530	PC3500	PC5300	H01	G10	l	d	t	d ₁	R		c
	M8-ROU			○	◎			15.875	11	4.76	4.6	4.6	-	
	M12-M14-ROU			○	◎			19.05	14.29	6.35	5.4	5.4	-	
	M16-M18-ROU			○	◎			19.05	14.29	7	5.4	5.4	-	
	M20-M22-ROU			○	◎			19.05	14.29	7.94	5.4	5.4	-	
	M40-ROU			○	◎			25.4	14.29	9.52	5.4	5.4	-	
	LNE 434-02-1			○	◎			19.05	14.29	6.35	5.4	-	0.6	
	KEL 1906-C0.6-MF			○	◎			19.05	14.29	6.35	5.4	-	0.6	
	190610-MR			○	◎			19.05	14.29	6.35	5.4	-	-	

※ The above specification is subject to change according to customer related condition & Korloy technical condition

©: 1st Rec ○: 2nd Rec



Gear Semi-finishing Cutter (High rigid edge type, Internal gear)

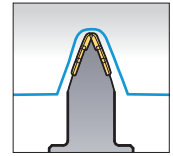
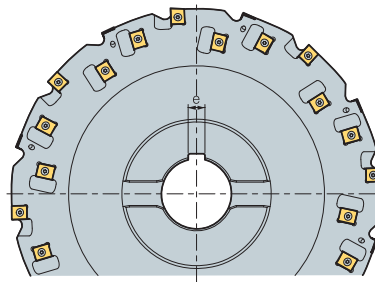
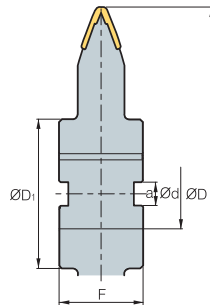

(mm)

m	No. of teeth		ØD	Ød	ØD ₁	a	e	F
12	30,60,120	24	250	60	100	25	14	70
14	30,60,120	36	250	60	100	25	14	80
16	30,60,120	36	250	60	100	25	14	80
18	30,60,120	36	250	60	100	25	14	90
20	30,60,120	48	280	80	135	25	18	95
22	30,60,120	48	280	80	135	25	18	100
24	30,60,120	48	320	80	145	25	18	105
26	30,60,120	72	400	100	180	25	24	110
28	30,60,120	72	400	100	180	25	24	110
30	30,60,120	72	400	100	180	25	24	120
32	30,60,120	84	400	100	180	25	24	130
34	30,60,120	84	400	100	180	25	24	130

Available inserts

(mm)

Picture	Designation	Coated				Uncoated		Dimensions					Configuration
		NC5330	PC9530	PC3500	PC5300	H01	G10	l	d	t	d ₁	c	
	M8-ROU			○	◎			15.875	11	4.76	4.6	2	
	M12-M14-ROU			○	◎			19.05	14.29	6.35	5.4	3	
	M16-M18-ROU			○	◎			19.05	14.29	7	5.4	5	
	M20-M22-ROU			○	◎			19.05	14.29	7.94	5.4	7	
	M40-ROU			○	◎			25.4	14.29	9.52	5.4	10	
	LNE 433-R80			○	◎			19.05	14.29	5.56	5.4	2.5	

* The above specification is subject to change according to customer related condition & Korloy technical condition

◎: 1st Rec ○: 2nd Rec

Gear Finishing Cutter (1 Step type, External gear)

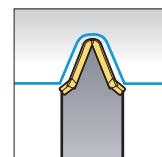
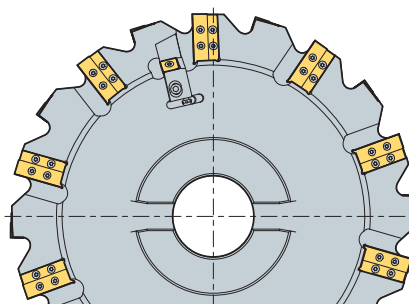
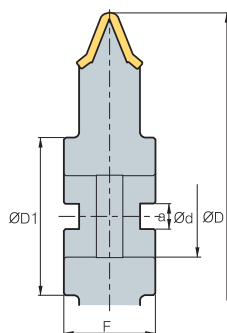

(mm)

m		ØD	Ød	ØD ₁	a	F
6	20	400	80	155	25	90
8	20	400	80	155	25	90
10	20	400	80	155	25	90
12	20	400	80	155	25	90
14	20	400	80	155	25	90
16	20	400	80	155	25	90
18	20	400	80	155	25	90
20	20	400	80	155	25	90
22	20	400	80	155	25	90
24	20	400	80	155	25	90

Available inserts

(mm)

Picture	Designation	Coated				Uncoated		Dimensions					Configuration
		NC5330	PC9530	PC3500	PC5300	H01	G10	l	d	t	d ₁	R	
	M6			○	◎			19	14.3	5	5.5	2.25	
	M8			○	◎			27	14.3	5.4	5.5	3	
	M10			○	◎			29	14.3	6.35	5.5	3.75	
	M12			○	◎			33	14.3	6.35	5.5	4.5	
	M14			○	◎			39	14.3	6.35	5.5	5.25	
	M16			○	◎			43	14.3	7.94	5.5	6	
	M18			○	◎			50	14.3	7.94	5.5	6.75	
	M20			○	◎			54	14.3	9.53	5.5	7.5	
	M22			○	◎			57	14.3	9.53	5.5	8.25	
M24			○	◎			64	14.3	9.53	5.5	9		
	SNEQ 1507-C0.8			○	◎			15.875	15.875	7.94	-	-	

※ The above specification is subject to change according to customer related condition & Korloy technical condition

◎: 1st Rec ○: 2nd Rec



Gear Finishing Cutter (1 Step type, Internal gear)

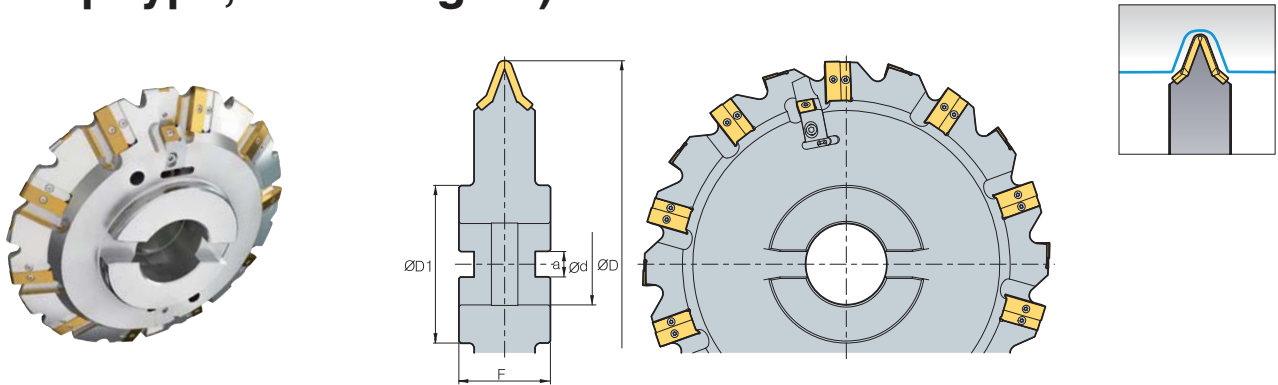

(mm)

m		ØD	Ød	ØD ₁	a	F
6	20	400	80	155	25	90
8	20	400	80	155	25	90
10	20	400	80	155	25	90
12	20	400	80	155	25	90
14	20	400	80	155	25	90
16	20	400	80	155	25	90
18	20	400	80	155	25	90
20	20	400	80	155	25	90
22	20	400	80	155	25	90
24	20	400	80	155	25	90

Available inserts

(mm)

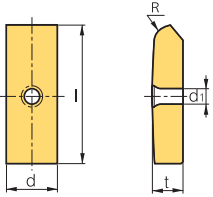
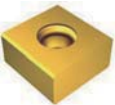
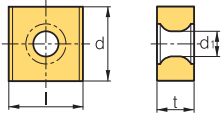
Picture	Designation	Coated				Uncoated		Dimensions					Configuration
		NC5330	PC9530	PC3500	PC5300	H01	G10	l	d	t	d ₁	R	
	M6			○	◎			19	14.3	5	5.5	2.25	
	M8			○	◎			27	14.3	5.4	5.5	3	
	M10			○	◎			29	14.3	6.35	5.5	3.75	
	M12			○	◎			33	14.3	6.35	5.5	4.5	
	M14			○	◎			39	14.3	6.35	5.5	5.25	
	M16			○	◎			43	14.3	7.94	5.5	6	
	M18			○	◎			50	14.3	7.94	5.5	6.75	
	M20			○	◎			54	14.3	9.53	5.5	7.5	
	M22			○	◎			57	14.3	9.53	5.5	8.25	
	M24			○	◎			64	14.3	9.53	5.5	9	
	SNEQ 1507-C0.8			○	◎			15.875	15.875	7.94	-	-	

* The above specification is subject to change according to customer related condition & Korloy technical condition

◎: 1st Rec ○: 2nd Rec

Gear Finishing Cutter (2 Step type, Internal/External gear)

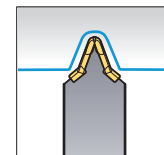
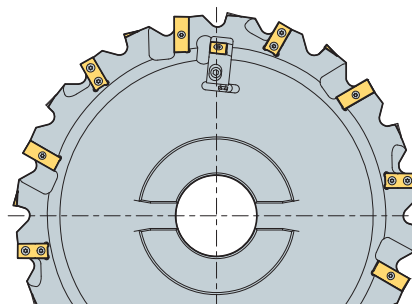
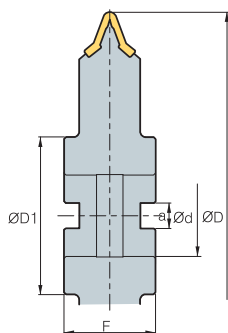



(mm)

m		ØD	Ød	ØD ₁	a	F
6	24	400	80	155	25	90
8	24	400	80	155	25	90
10	24	400	80	155	25	90
12	24	400	80	155	25	90
14	24	400	80	155	25	90
16	24	400	80	155	25	90
18	24	400	80	155	25	90
20	24	400	80	155	25	90
22	24	400	80	155	25	90
24	24	400	80	155	25	90

Available inserts

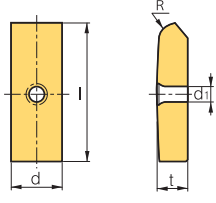
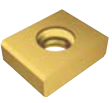
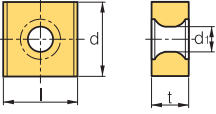
(mm)

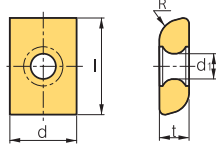
Picture	Designation	Coated				Uncoated		Dimensions					Configuration
		NC5330	PC9530	PC3500	PC5300	H01	G10	l	d	t	d ₁	R	
	M6		○		◎			19	14.3	5	5.5	2.25	
	M8		○		◎			27	14.3	5.4	5.5	3	
	M10		○		◎			29	14.3	6.35	5.5	3.75	
	M12		○		◎			33	14.3	6.35	5.5	4.5	
	M14		○		◎			39	14.3	6.35	5.5	5.25	
	M16		○		◎			43	14.3	7.94	5.5	6	
	M18		○		◎			50	14.3	7.94	5.5	6.75	
	M20		○		◎			54	14.3	9.53	5.5	7.5	
	M22		○		◎			57	14.3	9.53	5.5	8.25	
M24		○		◎			64	14.3	9.53	5.5	9		
	SNEQ 1507-C0.8		○		◎			15.875	15.875	7.94	-	-	
	M6-2ST							19.05	11.6	3.8	4.4	2.25	
	M8-2ST							19.05	11.6	4	4.4	3	
	M10-2ST							19.05	11.6	4.76	4.4	3.75	
	M12-2ST							19.05	14.3	6.35	5.5	4.5	
	M14-2ST							25.4	14.3	6.35	5.5	5.25	
	M16-2ST							31.8	14.3	7.14	5.5	6	
	M18-2ST							31.8	14.3	7.14	5.5	6.75	
	M20-2ST							31.8	14.3	9.52	5.5	7.5	
	M22-2ST							31.8	14.3	9.52	5.5	8.25	
M24-2ST							31.8	14.3	9.52	5.5	9		

※ The above specification is subject to change according to customer related condition & Korloy technical condition

◎: 1st Rec ○: 2nd Rec



➤ Gear cutter order form

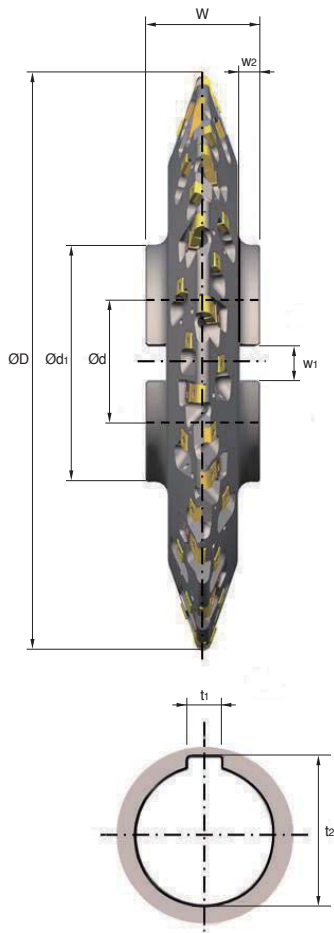

Cutter type

- | | | |
|--|---|---|
| <input type="checkbox"/> Roughing | <input type="checkbox"/> Semi-finishing | <input type="checkbox"/> Finishing |
| <input type="checkbox"/> Step | <input type="checkbox"/> Low cutting resistance | <input type="checkbox"/> 1 Step |
| <input type="checkbox"/> V shape | <input type="checkbox"/> High rigid edge | <input type="checkbox"/> 2 Step |

■ Stock for finishing (one side) (mm):

■ Outside diameter D (mm):

■ Bore diameter d (mm):

■ Hub diameter d1 (mm):

■ Cutter width W (mm):

■ Radial keyway w1 (mm):

■ Radial keyway w2 (mm):

■ Axial keyway t1 (mm):

■ Axial keyway t2 (mm):

➤ Involute gear data

- | | | |
|---|---|---|
| <input type="checkbox"/> External gear | <input type="checkbox"/> Internal gear | <input type="checkbox"/> Rack gear |
|---|---|---|

■ Module M (mm):

■ No. of teeth Z (mm):

■ Pressure angle α (°):

■ Helix angle β (°):

■ Addendum modification coefficient x:

■ Tip diameter d_a (mm):

■ Root diameter d_f (mm):

■ Root radius ρ_{fp} (mm)

■ Base tangent length W_k (mm)

■ No. of measuring teeth K:

■ Dimensions/Dimension over balls M_d (mm):

■ Ball diameter D_M (mm):

■ Gear quality (DIN, JIS):

Indexable HOB

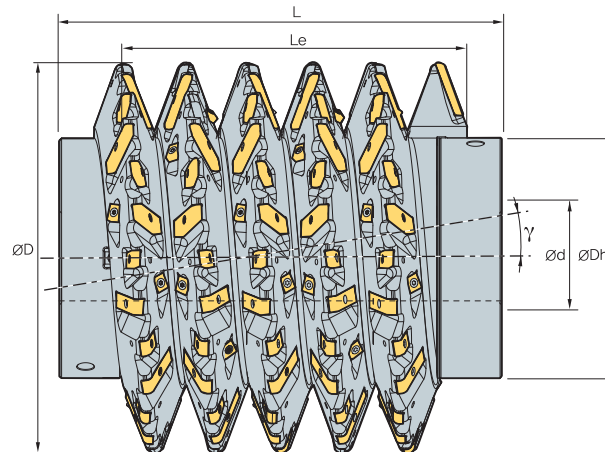

(mm)

Gear module	$\varnothing D$	$\varnothing D_h$	$\varnothing d$	No.Segm. (Pitch)	L_e	Segment insert	Total insert	γ (Lead Ang.)
6	180	125	40	6	(113)	15	90	2.084
	210	125	50	6	(113)	17	102	1.763
	240	160	60	6	(113)	19	114	1.528
7	180	125	40	6	(132)	15	90	2.469
	210	125	50	6	(132)	17	102	2.084
	240	160	60	6	(132)	19	114	1.803
8	210	125	50	6	(151)	17	102	2.413
	240	160	60	6	(151)	19	114	2.084
	270	180	80	6	(151)	21	126	1.834
9	210	125	50	6	(169)	17	102	2.751
	240	160	60	6	(169)	19	114	2.372
	270	180	80	6	(169)	21	126	2.084
10	210	125	50	6	(189)	17	102	3.099
	240	160	60	6	(189)	19	114	2.666
	270	180	80	6	(189)	21	126	2.339
12	240	140	60	6	(226)	18	108	3.276
	270	180	80	6	(226)	22	132	2.866
	350	215	80	6	(226)	26	156	2.149
14	270	180	80	6	(264)	22	132	3.415
	350	215	80	6	(264)	26	156	2.547
16	270	160	80	6	(302)	22	132	3.989
	350	215	80	6	(302)	26	156	2.959
18	270	145	80	5	(283)	22	110	4.589
	350	215	80	5	(283)	26	130	3.383
20	350	215	80	5	(314)	26	130	3.823
	450	265	100	5	(314)	34	170	2.866



Indexable HOB

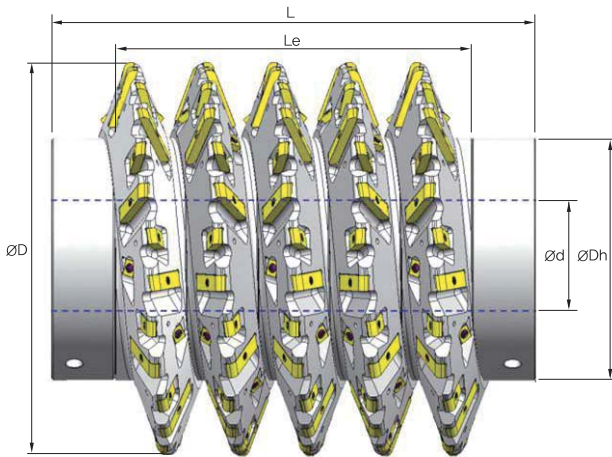

Tool SPEC.

■ Outside diameter ØD (mm):

■ Bore diameter Ød (mm):

■ Hub diameter ØDh (mm):

■ Hob length L (mm):

■ Cutting length L_e (mm):

■ Spiral direction RH/LH:

■ Quality class acc. to DIN 3968:

Profile of hob [Module m6~]

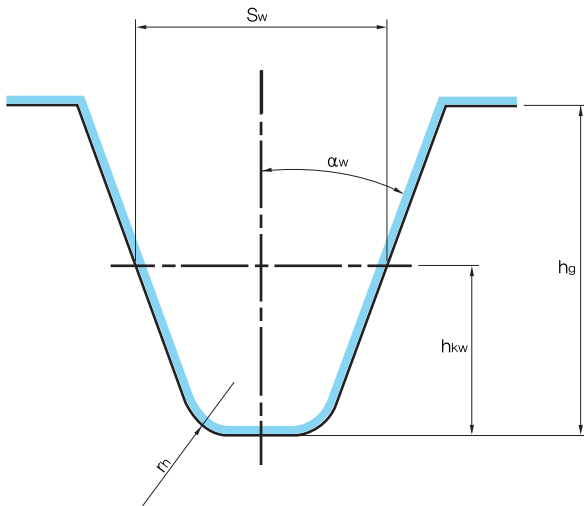

■ Module M (mm):

■ Addendum h_{kw} (mm):

■ Tooth thickness S_w (mm):

■ Tooth depth h_g (mm):

Profile of roughing hob [Module m8~]

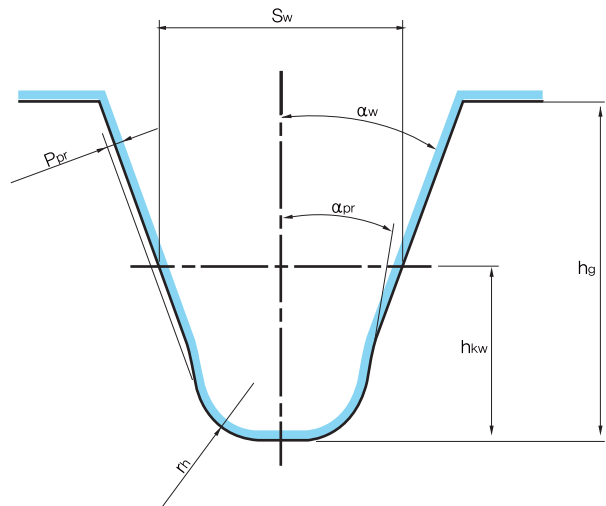

■ Pressure angle α_w (mm):

■ Protuberance amount P_{pr} (mm):

■ Protuberance angle α_{pr} (mm):

■ Tip radius r_h (mm):

E Special Boring Tool Order Form

Special drill holder for multi-purpose

Drilling & Chamfering & Counter Boring

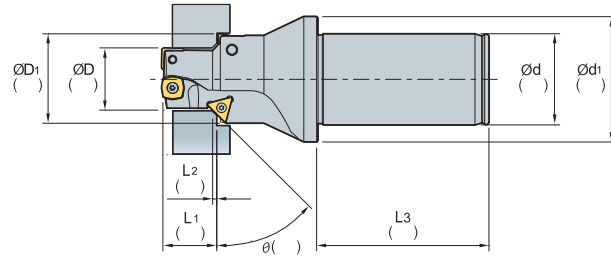

Drilling & Counter Boring

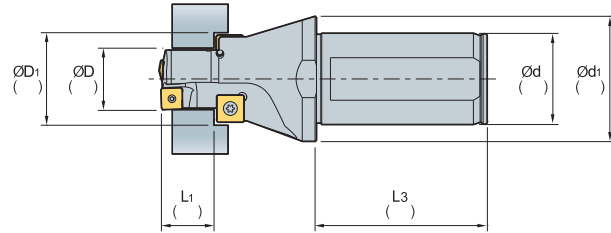

Drilling & Chamfering

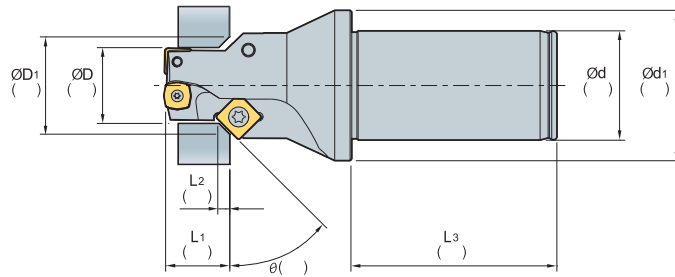

* Order-made items available outer above configurations

Available inserts

(mm)

Picture	Designation	Coated		Dimensions					Available screw	Configuration	
		PC5300	PC3600	l	d	t	r	d ₁			
	SPMT	050204-BC	●		4.2	5	2.48	0.4	2.25	FTNA0204	
		060204-BC	●		5.2	6	2.48	0.4	2.61	FTNA02205	
		07T308-BC	●		6.34	7.94	3.97	0.8	2.85	FTKA02565	
		090408-BC	●		7.9	9.525	4.3	0.8	4.05	FTNA03508	
		110408-BC	●		9.9	11.5	5	0.8	4.45	FTKA0408	
		120408-BC	●		11.1	12.7	5	0.8	4.45	FTKA0408	
		140512-BC	●		11.9	14.3	5.4	1.2	5.75	FTNA0510	
	TCMT	090204-MP			8.6	5.56	2.38	0.4	2.50	FTKA02206	
		090208-MP			7.6	5.56	2.38	0.8	2.50	FTKA02206	
		110202-MP			10.5	6.35	2.38	0.2	2.80	FTKA2565	
		110204-MP			10.0	6.35	2.38	0.4	2.80	FTKA2565	
		110208-MP	●		9.0	6.35	2.38	0.8	2.80	FTKA2565	
		16T304-MP	●		15.5	9.525	3.97	0.4	4.40	FTGA3512	
		16T308-MP	●		14.5	9.525	3.97	0.8	4.40	FTGA3512	

● Stock item



Special Boring holder for multi-purpose

Boring & Counter Boring

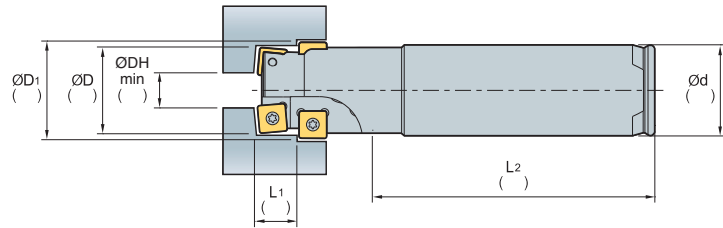

Boring & Chamfering

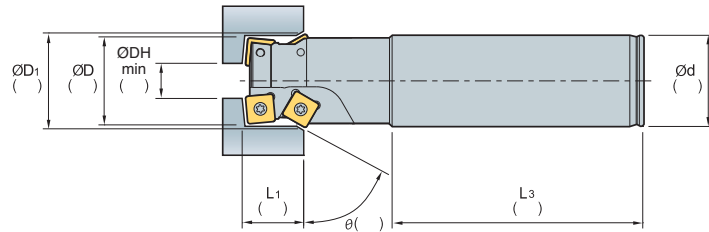

Boring & Chamfering & Counter Boring

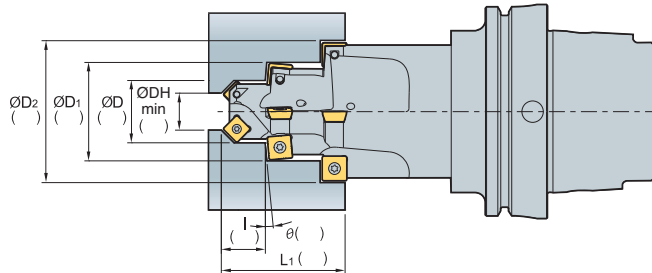

* Order-made items available outer above configurations

Available inserts

(mm)

Picture	Designation	Coated		Dimensions					Available screw	Configuration	
		PC5300	PC3600	l	d	t	r	d _i			
	SPMT	050204-BC	●		4.2	5	2.48	0.4	2.25	FTNA0204	
		060204-BC	●		5.2	6	2.48	0.4	2.61	FTNA02205	
		07T308-BC	●		6.34	7.94	3.97	0.8	2.85	FTKA02565	
		090408-BC	●		7.9	9.525	4.3	0.8	4.05	FTNA03508	
		110408-BC	●		9.9	11.5	5	0.8	4.45	FTKA0408	
		120408-BC	●		11.1	12.7	5	0.8	4.45	FTKA0408	
		140512-BC	●		11.9	14.3	5.4	1.2	5.75	FTNA0510	
	TCMT	090204-MP			8.6	5.56	2.38	0.4	2.50	FTKA02206	
		090208-MP			7.6	5.56	2.38	0.8	2.50	FTKA02206	
		110202-MP			10.5	6.35	2.38	0.2	2.80	FTKA2565	
		110204-MP			10.0	6.35	2.38	0.4	2.80	FTKA2565	
		110208-MP	●		9.0	6.35	2.38	0.8	2.80	FTKA2565	
		16T304-MP	●		15.5	9.525	3.97	0.4	4.40	FTGA3512	
		16T308-MP	●		14.5	9.525	3.97	0.8	4.40	FTGA3512	

● Stock item



F

ENDMILLS

Korloy Endmills, with New technology and our technical know-how, are the best for increasing productivity and machinability



Technical Information for Endmills

- F02 Endmill Code System
- F04 KORLOY Endmills

Solid Endmills

- F09 Technical Information for H Endmill
- F12 H Endmill
- F14 Technical Information for V Endmill
- F16 V Endmill
- F17 Technical Information for Z Endmill
- F20 Z Endmill
- F24 Technical Information for F Endmill
- F26 F Endmill
- F27 Technical Information for T Endmill
- F29 T Endmill Order Form
- F30 Technical Information for D Endmill
- F32 D Endmill
- F37 Technical Information for Solid Endmills for Aluminum
- F38 Solid Endmills for Aluminum
- F40 Technical Information for C-Max
- F41 C-Max
- F44 Technical Information for Super Endmill
- F46 Super Endmill

Solid Endmills

- F51 Technical Information for Composite Router Endmill
- F52 Composite Router Endmill
- F57 Technical Information for I+ Endmill
- F60 I+ Endmill
- F72 Technical Information for Z+ Endmill
- F75 Z+ Endmill
- F89 Technical Information for S+ Endmill
- F91 S+ Endmill
- F92 Technical Information for R+ Endmill
- F97 R+ Endmill
- F103 Technical Information for A+ Endmill
- F105 A+ Endmill

Brazed Endmills

- F114 Technical Information for PCD Endmill
- F115 PCD Endmill
- F116 Technical Information for Brazed Endmill
- F118 Brazed Endmill

Special Endmill order Form

- F123 Special Endmill Order Form

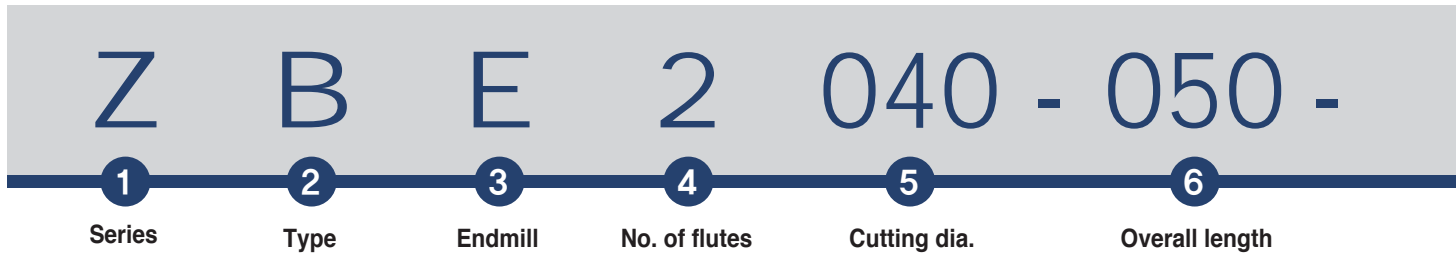

1 Series
Z B E 2 040 - 050 - R T - V N S

Z, IP, ZP: Endmill for general usage
 P: High speed/ hardness Endmill
 C: Copper, Copper alloy Endmill
 D: Graphite, Non-Ferrous Endmill
 V: Variable Endmill
 FM: High feed Endmill

SSEA, AP: Aluminum Endmill
 SP: Stainless Endmill
 CC: Composite Router Endmill
 T: Dental Endmill

2 Type
Z B E 2 040 - 050 - R T - V N S

Flat type
F

Ball type
B

Radius type
R

3 Endmill
Z B E 2 040 - 050 - R T - V N S

4 No. of flutes
Z B E **2** 040 - 050 - R T - V N S

2 Flutes

2

3 Flutes

3

4 Flutes

4

6 Flutes

6

5 Cutting dia
Z B E 2 **040** - 050 - R T - V N S

Notation	ØD (mm)
040	Ø4.0
060	Ø6.0
080	Ø8.0
100	Ø10.0

6 Overall length
Z B E 2 040 - **050** - R T - V N S

Overall length	
Notation	L (mm)
050	50
080	80
100	100

※ The above code system is not applied for SSEA (Aluminum Endmill) and ZSE (Brazing Endmill)



R02 T00 - V05 N12 S06

7

Corner radius

8

Taper angle

9

Flute length

10

Neck length

11

Shank diameter

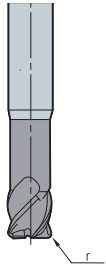
7**Corner radius**Z B E 2 040 - 050 - **R** T - V N S

Corner radius	
Notation	R (mm)
R02	r 0.2
R05	r 0.5
R10	r 1.0
R15	r 1.5

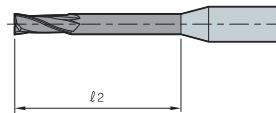
10**Neck length**Z B E 2 040 - 050 - R T - V **N** S

Long Neck

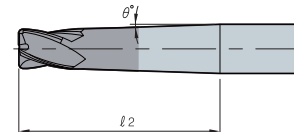

Taper Long Neck

 l_2 (mm): Neck LengthT (θ°): Taper Angle

Long neck	
Notation	l_2 (mm)
N05	5
N08	8
N10	10
N12	12

Taper long neck	
Notation	$l_2 + T(\theta^\circ)$
N0510	5+1°
N0815	8+1.5°
N1020	10+2°
N1225	12+2.5°

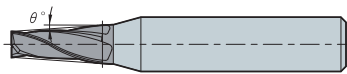
8**Taper angle**Z B E 2 040 - 050 - R **T** - V N ST (θ°): Taper Angle

Taper angle	
Notation	T (θ°)
T10	1°
T15	1.5°
T20	2°

11**Shank diameter**Z B E 2 040 - 050 - R T - V N **S**

Shank diameter	
Notation	$\varnothing d$ (mm)
S06	$\varnothing 6$
S08	$\varnothing 8$
S10	$\varnothing 10$
S12	$\varnothing 12$
S16	$\varnothing 16$

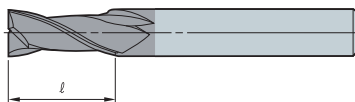
9**Flute length**Z B E 2 040 - 050 - R T - **V** N S

Taper length	
Notation	(mm)
V05	5
V10	10
V15	15



















※ This code system is also for special endmills

F KORLOY Endmills

Type	Shape	Designation	Grade	Figure	Coated	Used	No. of flute	Size		Workpiece						page
								Min	Max	P	M	K	N	S	H	
										Steel	Stainless steel	Cast iron	Non-ferrous metal	High resistant alloy, titanium alloy	Hardened steel	
H Endmill <small>new</small>	Ball	PBE2000	PC303S		○	High speed High hardness	2	0.5	12	◎	◎	◎	○	◎	F12	
	Radius	PRE4000	PC310U		○	High speed High hardness	4	3	12	◎	◎	◎	○	◎	F13	
V Endmill	Flat	VFE4000	PC215F		○	General	4	2.5	16	◎	○	○	○	○	F16	
Z Endmill <small>new</small>	Flat	ZFE2000	PC315E		○	General	2	1	16	◎	○	◎	○	○	F20	
		ZFE4000	PC315E		○	General	4	1	16	◎	○	◎	○	○	F21	
	Short flat	ZSFE2000	PC315E		○	General	2	1	12	◎	○	◎	○	○	F22	
		ZSFE4000	PC315E		○	General	4	1	12	◎	○	◎	○	○	F22	
	Ball	ZBE2000	PC315E		○	General	2	1	12	◎	○	◎	○	○	F23	
F Endmill	High feed	FME4000	PC203F		○	High speed High hardness	4	6	12	○	○	○	◎	◎	F26	
	High feed long	FMLE4000	PC203F		○	High speed High hardness	4	6	12	○	○	○	◎	◎	F26	
T Endmill <small>new</small>		TZBE	ND3000		○	Dental, Zirconia	2	0.6	3				◎		F27	
	Ball	TTBE	PC2510		○	Dental, Metal	2	0.6	3					◎	F27	
		TWBE	H01		-	Dental, Wax	2	0.6	3				◎		F27	
D Endmill <small>new</small>	Flat	DFE2000	ND3000		○	Graphite, Ceramics	2	1	12				◎		F32	
		DFE4000	ND3000		○	Graphite, Ceramics	4	2	12				◎		F33	
	Ball	DBE2000	ND3000		○	Graphite, Ceramics	2	0.6	12				◎		F34 F35	
		DBE4000	ND3000		○	Graphite, Ceramics	4	2	12				◎		F36	

◎: Excellent ○: Good



















Type	Shape	Designation	Grade	Figure	Coated	Used	No. of flute	Size		Workpiece						page
								Min	Max	P	M	K	N	S	H	
										Steel	Stainless steel	Cast iron	Non-ferrous metal	Heat resistant alloy, Titanium alloy	Hardened steel	
Solid Endmills for aluminum	Flat	SSEA2000	H01 PD3000		— (○)	Aluminum	2	1	20	○	○	○	◎	○	○	F38
	Flat	SSEA3000	H01 PD3000		— (○)	Aluminum	3	2	16	○	○	○	◎	○	○	F38
	Ball	SSBEA2000	H01 PD3000		— (○)	Aluminum	2	1	20	○	○	○	◎	○	○	F39
C-Max	Flat	CFE2000	PC210C		○	Copper, Copper alloy	2	1	12	○	○	○	◎	○	○	F41
	Long neck flat	CFNE2000	PC210C		○	Copper, Copper alloy	2	0.5	4	○	○	○	◎	○	○	F41
	Ball	CBE2000	PC210C		○	Copper, Copper alloy	2	1	12	○	○	○	◎	○	○	F42
	Long neck ball	CBNE2000	PC210C		○	Copper, Copper alloy	2	0.5	4	○	○	○	◎	○	○	F42
	Radius	CRE2000	PC210C		○	Copper, Copper alloy	2	2	12	○	○	○	◎	○	○	F43
	Long neck radius	CRNE2000	PC210C		○	Copper, Copper alloy	2	1	4	○	○	○	◎	○	○	F43
Super Endmill	Radius	SRES4000	SL		○	HRSA	4	3	20	○	○	○	○	◎	○	F46~F50
Composite Router Endmill	Flat	CCDR4000	ND2100		○	Composite CFRP, GFRP	4	6	8	○	○	○	◎	○	○	F52
		CCDR6000	ND2100		○	Composite CFRP, GFRP	6	10	12	○	○	○	◎	○	○	F52
		CCHR4000	ND2100		○	Composite CFRP, GFRP	4	6	8	○	○	○	◎	○	○	F53
		CCHR6000	ND2100		○	Composite CFRP, GFRP	6	10	12	○	○	○	◎	○	○	F53
		CCR2000	ND2100		○	Composite CFRP, GFRP	2	4	12	○	○	○	◎	○	○	F54
		CCLR4000	ND2100		○	Composite CFRP, GFRP	4	4	12	○	○	○	◎	○	○	F55
		CCRR6000	ND2100		○	Composite CFRP, GFRP	6	6	8	○	○	○	◎	○	○	F56
		CCRR8000	ND2100		○	Composite CFRP, GFRP	8	10	12	○	○	○	◎	○	○	F56

◎: Excellent ○: Good



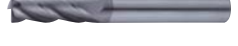

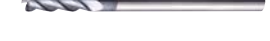















F KORLOY Endmills

Type	Shape	Designation	Grade	Figure	Coated	Used	No. of flute	Size		Workpiece						page
								Min	Max	P	M	K	N	S	H	
										Steel	Stainless steel	Cast iron	Nonferrous metal	High resistance, titanium	Hardened steel	
I+ Endmill	Flat	IPFE2000	PC320		○	General	2	1	20	◎	○	◎	○	○	○	F60
		IPFE4000	PC320		○	General	4	1	20	◎	○	◎	○	○	○	F62
	Long flat	IPLFE2000	PC320		○	General	2	1	20	◎	○	◎	○	○	○	F61
		IPLFE4000	PC320		○	General	4	1	20	◎	○	◎	○	○	○	F63
	Ball	IPBE2000	PC320		○	General	2	1	20	◎	○	◎	○	○	○	F64
		IPBE4000	PC320		○	General	4	1	20	◎	○	◎	○	○	○	F66
	Long ball	IPLBE2000	PC320		○	General	2	1	16	◎	○	◎	○	○	○	F65
	Radius	IPRE2000	PC320		○	General	2	1	12	◎	○	◎	○	○	○	F67 F68
		IPRE4000	PC320		○	General	4	2	12	◎	○	◎	○	○	○	F70
	Long radius	IPLRE2000	PC320		○	General	2	3	12	◎	○	◎	○	○	○	F69
		IPLRE4000	PC320		○	General	4	3	12	◎	○	◎	○	○	○	F71
	Z+ Endmill <small>new</small>	Flat	ZPFE2000	PC320U		○	General	2	1	20	◎	○	◎	○	○	F75
Short flat		ZPSFE2000	PC320U		○	General	2	1	16	◎	○	◎	○	○	F76	
Long flat		ZPLFE2000	PC320U		○	General	2	2	20	◎	○	◎	○	○	F76	
Long flute		ZPLFE2000	PC320U		○	General	2	2	20	◎	○	◎	○	○	F77	
Flat		ZPFE4000	PC320U		○	General	4	1	20	◎	○	◎	○	○	F78	
Short flat		ZPSFE4000	PC320U		○	General	4	1	16	◎	○	◎	○	○	F79	
Long flat		ZPLFE4000	PC320U		○	General	4	2	20	◎	○	◎	○	○	F80	

◎: Excellent ○: Good





















Type	Shape	Designation	Grade	Figure	Coated	Used	No. of flute	Size		Workpiece						page
								Min	Max	P	M	K	N	S	H	
										Steel	Stainless steel	Cast iron	Non-ferrous metal	Heat resistant alloy, Titanium alloy	Hardened steel	
Z+ Endmill <small>new</small>	Long flute	ZPLFE4000	PC320U		○	General	4	1	20	◎	○	◎	○	○	○	F81
	Flat	ZPFE3000	PC320U		○	General	3	2	25	◎	○	◎	○	○	○	F82
		ZPFE6000	PC320U		○	General	6	6	20	◎	○	◎	○	○	○	F82
	Ball	ZPBE2000	PC320U		○	General	2	0.8	20	◎	○	◎	○	○	○	F83
	Long ball	ZPLBE2000	PC320U		○	General	2	2	12	◎	○	◎	○	○	○	F84
	Ball	ZPBE4000	PC320U		○	General	4	2	20	◎	○	◎	○	○	○	F84
	Radius	ZPRE2000	PC320U		○	General	2	1	16	◎	○	◎	○	○	○	F85
	Long radius	ZPLRE2000	PC320U		○	General	2	6	16	◎	○	◎	○	○	○	F86
	Radius	ZPRE4000	PC320U		○	General	4	1.5	16	◎	○	◎	○	○	○	F87
	Long radius	ZPLRE4000	PC320U		○	General	4	6	16	◎	○	◎	○	○	○	F88
S+ Endmill <small>new</small>	Flat	SPFE4000	PC320S		-	STS	4	1	12	○	◎	○	◎	○	○	F91
	Long flat	SPLFE4000	PC320S		-	STS	4	1	12	○	◎	○	◎	○	○	F91
R+ Endmill	Roughing	RPAE	FN30T		-	Aluminum	3	6	25				◎			F97
		RPE-FP-H	PC30T		○	General	4	5	20	◎	○	◎	○	○	○	F97
		RPLE-FP-H	PC30T		○	General	4	5	20	◎	○	◎	○	○	○	F98
		RPE-XG	PC30T		○	General	4	6	20	◎	○	◎	○	○	○	F98
		RPE-FP-L	PC30T		○	General	4	5	20	◎	○	◎	○	○	○	F99
		RPE-RG	PC40T		○	General	4	5	20	◎	○	◎	○	○	○	F99

◎: Excellent ○: Good



F KORLOY Endmills

Type	Shape	Designation	Grade	Figure	Coated	Used	No. of flute	Size		Workpiece						page
								Min	Max	P	M	K	N	S	H	
										Steel	Stainless steel	Cast iron	Non-ferrous metal	High resistant alloy, titanium alloy	Hardened steel	
R+ Endmill	Roughing	RPE-RG	HN30T HC30T		○	General	4	6	20	◎	○	◎	○	○	○	F100
		RPE-FF	HC30T		○	General	4	6	20	◎	○	◎	○	○	○	F100
		RPE-FP	HC30T		○	General	4	6	20	◎	○	◎	○	○	○	F101
		RPE-RG	HN20T HC10T HC20T		○	General	4	6	50	◎	○	◎	○	○	○	F102
A+ Endmill	Flat	APFE2000	H05S		-	Aluminum	2	1	20	◎	○	◎	○	○	○	F105
		APFE3000	H05S		-	Aluminum	3	1	20	◎	○	◎	○	○	○	F105
	Middle flat	APMFE2000	H05S		-	Aluminum	2	3	20	◎	○	◎	○	○	○	F106
		APMFE3000	H05S		-	Aluminum	3	3	20	◎	○	◎	○	○	○	F106
PCD Endmill	Flat	PDE1000	DP200		-	Nonferrous, High speed	1	4.6	6	◎	○	◎	○	○	○	F115
		PDE2000	DP200		-	Nonferrous, High speed	2	6	12	◎	○	◎	○	○	○	F115
Brazeed Endmill	Flat	ZSE200	FCC PC221F		- (○)	Cast iron, Steel	2	14	50	○	○	◎	○	○	○	F118
		ZSE300	FCC PC221F		- (○)	Cast iron, Steel	3	14	50	○	○	◎	○	○	○	F118 F119
		ZSE400	FCC PC221F		- (○)	Cast iron, Steel	4	14	50	○	○	◎	○	○	○	F119
		ZSE600	FCC PC221F		- (○)	Cast iron, Steel	6	34	50	○	○	◎	○	○	○	F119
		ZSEA200	FCC		-	Aluminum, Copper	2	15	50	◎	○	◎	○	○	○	F120
	Long flat	ZSEL200	FCC PC221F		-	Cast iron, Steel	2	14	50	○	○	◎	○	○	○	F121
		ZSEL400	FCC PC221F		-	Cast iron, Steel	4	16	40	○	○	◎	○	○	○	F121
		ZSEXL200	FCC PC221F		-	Cast iron, Steel	2	20	25	○	○	◎	○	○	○	F121
	Ball	ZSBE200	FCC PC221F		-	Cast iron, Steel	2	13	50	○	○	◎	○	○	○	F122

◎: Excellent ○: Good



Endmill for high speed machining for high hardened steel

H Endmill **new**

- For cutting high hardened and heat-treated steel under HRC70
- New coating technology improves wear resistance
- A new shape improves machinability
- High speed and highly accurate machining available

Features

- New grade (PC303S, PC310U) - Ultra fine substrate and AlTiSiN coating guarantee excellent wear resistance
- Special edge treatment - Special cutting edge design was applied for less chipping and longer tool life
- High accuracy with tolerance h5 - High quality production system enables tolerance-h5 throughout the whole series

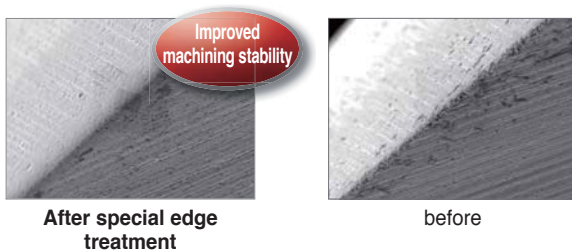

PBE (Ball)

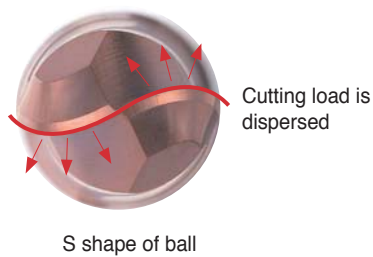

- The S shape of ball disperses cutting loads
- The tolerance of ball R is under ± 0.005 mm

PRE (Radius)

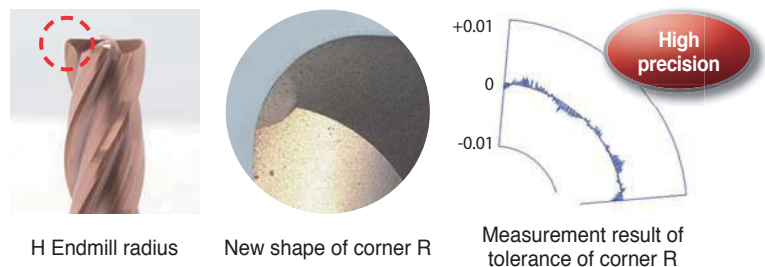

- The new shape of corner R reduces cutting loads
- The tolerance of corner R is under ± 0.005 mm

Performance evaluation

- **Workpiece** STD11 (HRC60)
- **Cutting conditions** Diameter = $\varnothing 8.0$, n (min^{-1}) = 4,000, vc (m/min) = 100
 vf (mm/min) = 800, fz (mm/t) = 0.05
 ap (mm) = 8.0, ae (mm) = 0.25, dry
- **Tools** PRE4080-100-R05

* Special cutting edge design reduces cutting loads and prolongs tool life

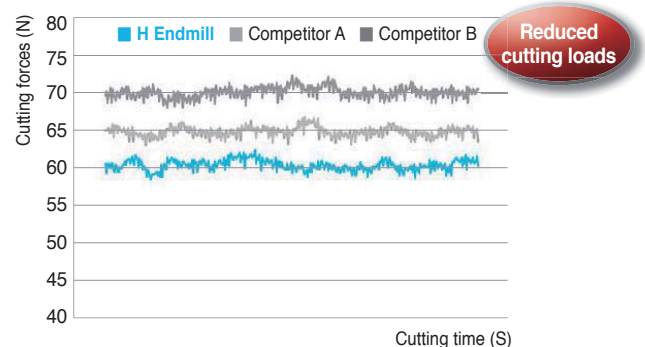

F Technical Information for H Endmill

Recommended cutting conditions (PRE4000 Radius)

Workpiece Conditions Diameter (Ø)	Above HRC40 (HPM1, KP4M, etc.)		Below HRC55 (NAK55, NAK80, STAVAX, etc.)		HRC55~HRC70 (STD11, STD61, etc.)	
	R.P.M n (min ⁻¹)	Feed vf (mm/min)	R.P.M n (min ⁻¹)	Feed vf (mm/min)	R.P.M n (min ⁻¹)	Feed vf (mm/min)
3	17,300	1,250	11,500	840	7,500	256
4	13,200	1,300	8,800	880	5,600	268
5	12,500	1,500	8,300	1,000	5,100	296
6	10,350	1,400	6,900	950	4,200	280
8	7,800	1,350	5,200	900	3,200	264
10	6,150	1,260	4,100	840	2,550	248
12	5,250	1,260	3,500	840	2,100	240

Application tip

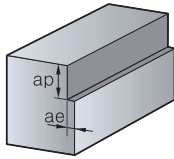

- Shouldering depth (ap) and radial depth (ae)
 - $ap = 0.1D$
 - $ae = 0.03D$

* Workpiece should be clamped rigidly. In case of vibration, reduce R.P.M and feed rate by the same ratio

Recommended cutting conditions (PRE4000 Radius)

Workpiece Conditions Diameter (Ø)	Above HRC40 (HPM1, KP4M, etc.)		Below HRC55 (NAK55, NAK80, STAVAX, etc.)		HRC55~HRC70 (STD11, STD61, etc.)	
	R.P.M n (min ⁻¹)	Feed vf (mm/min)	R.P.M n (min ⁻¹)	Feed vf (mm/min)	R.P.M n (min ⁻¹)	Feed vf (mm/min)
3	17,300	544	11,500	336	7,500	128
4	13,200	560	8,800	352	5,600	136
5	12,500	644	8,300	400	5,100	144
6	10,350	616	6,900	384	4,200	144
8	7,800	576	5,200	356	3,200	132
10	6,150	544	4,100	332	2,550	124
12	5,250	544	3,500	332	2,100	124

Application tip

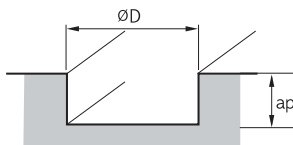

- Slotting depth (ap)
 - $ap = 0.05D$
 - $ae = 1.0D$

* Workpiece should be clamped rigidly. In case of vibration, reduce R.P.M and feed rate by the same ratio



Recommended cutting conditions (PBE2000 Ball)

Workpiece Conditions Diameter(Ø)	Above HRC40 (HPM1, KP4M, etc.)		Under HRC55 (NAK55, NAK80, STAVAX, etc.)		HRC55~HRC70 (STD11, STD61, etc.)	
	R.P.M n (min ⁻¹)	Feed vf (mm/min)	R.P.M n (min ⁻¹)	Feed vf (mm/min)	R.P.M n (min ⁻¹)	Feed vf (mm/min)
0.5	35,000	1,470	31,500	1,330	28,000	1,050
1	35,000	2,940	31,500	2,660	28,000	2,000
1.2	33,600	3,010	30,100	2,695	26,600	2,100
1.5	33,600	3,150	30,100	2,800	25,900	2,150
2	33,460	3,360	28,000	2,800	24,500	2,200
2.5	25,900	3,710	22,400	2,800	17,500	2,200
3	22,260	3,710	18,550	2,800	16,500	2,200
4	16,730	3,710	14,000	2,800	13,000	2,200
5	17,800	4,900	15,000	3,750	12,500	2,100
6	13,400	4,100	11,000	3,100	10,000	2,500
8	10,700	3,500	9,000	2,700	8,000	2,150
10	8,900	3,100	7,500	2,400	6,600	1,900
12	6,680	2,500	5,600	1,900	5,000	1,550

Application tip

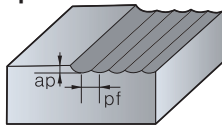

- $ap = 0.02D$
- $pf = 0.05D$

* Workpiece should be clamped rigidly. In case of vibration, reduce R.P.M and feed rate by the same ratio

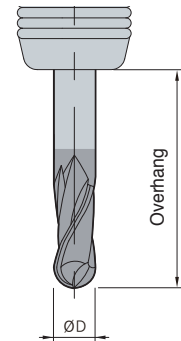

Cutting condition by overhang

- For shank taper type, Cutting conditions are based on the case of being clamped at neck part
 - When the overhang is increased by 1D in comparison to the overhang, decrease R.P.M and feed by 10%
- In case of the straight type adjust conditions according to the overhang
 - Ex: When the overhang is 3D and is increased by 1D, decrease R.P.M and feed by 10%

Cutting speed formulas (Ball endmills)

- Efficient cutting speed $V_{eff} = (\pi \times Deff \times n)/1000$ ($n = \text{min}^{-1}$)
- Efficient diameter $Deff$ calculation formula $Deff = (2\sqrt{ap(D-ap)} \times \alpha)$
 $D = \varnothing$ (Tool diameter), $Deff = \text{Efficient diameter}$
- Efficient cutting speed formulas: When slope \varnothing is 0° $V_{eff} = (\pi \times Deff \times n)/1000$
 $Deff = \text{Efficient diameter}$ Calculate $Deff$ as ap with various ball endmills

$\alpha = 1$	Slope angle $\theta = 0^\circ$
$\alpha = 1.2$	Slope angle $\theta = 7^\circ$
$\alpha = 1.5$	Slope angle $\theta = 15^\circ$
$\alpha = 1.7$	Slope angle $\theta = 30^\circ$
$\alpha = 2.17$	Slope angle $\theta = 45^\circ$
$\alpha = 2.3$	Slope angle $\theta = 60^\circ$

Cutting speed formulas (Ball endmills, slope angle = 0°)

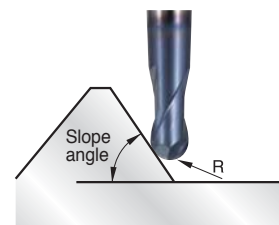
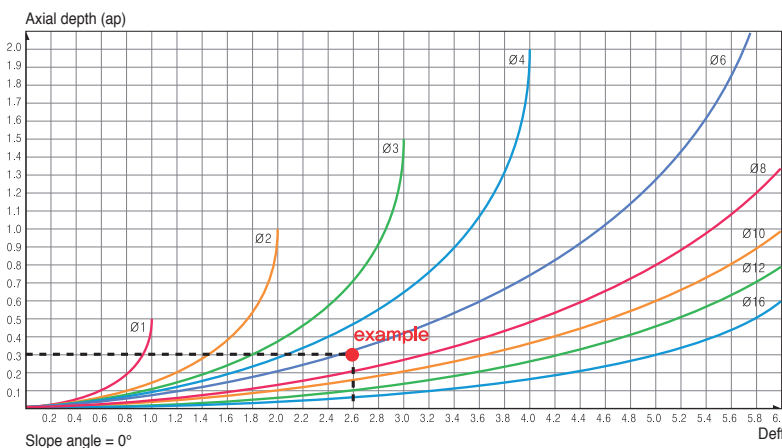

Ex) Diameter: 6 mm, $ap = 0.3$ mm,
 $Deff = 2.6$ mm, $N = 14,000$ (min⁻¹)
 Slope angle 0° : $V_{eff} = 113.7$ (m/min)
 Slope angle 15° : $V_{eff} = 113.7 \times 1.5 = 170.6$ (m/min)

Notice

- Cutting conditions are up to the machine's condition and the shape of cutting
- Use cutting fluid that is proper to the workpiece and produces few temperature reactions

PBE2000 (Ball)

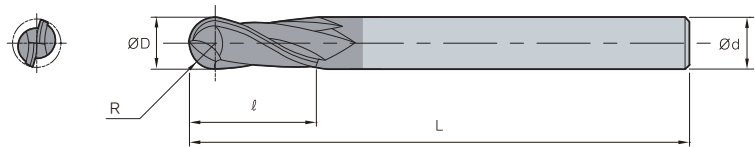

ØD	Tolerance
~Ø5.9	0.00~-0.015
Ø6.0~	0.00~-0.025



(mm)

Designation	R	ØD	Ød	ℓ	L
PBE					
2005-040	0.25	0.5	6	1	40
2010-050	0.5	1	6	2.5	50
2012-050	0.6	1.2	6	3	50
2015-050	0.75	1.5	6	4	50
2020-050	1	2	6	5	50
2025-060	1.25	2.5	6	7	60
2030-060	1.5	3	6	8	60
2040-070	2	4	6	8	70
2050-080	2.5	5	6	10	80
2060-090	3	6	6	12	90
2080-100	4	8	8	14	100
2100-100	5	10	10	18	100
2120-110	6	12	12	22	110



PRE4000 (Radius)

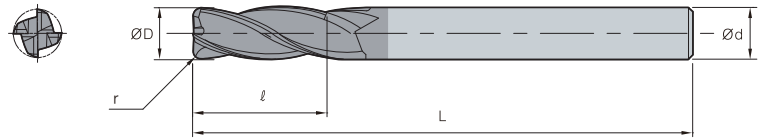

ØD	Tolerance
~Ø5.9	0.00~-0.015
Ø6.0~	0.00~-0.025



(mm)

Designation	ØD	Ød	ℓ	L	r
PRE					
4 4030-060-R01	3	6	8	60	0.1
4030-060-R02	3	6	8	60	0.2
4030-060-R03	3	6	8	60	0.3
4030-060-R05	3	6	8	60	0.5
4040-070-R01	4	6	10	70	0.1
4040-070-R02	4	6	10	70	0.2
4040-070-R03	4	6	10	70	0.3
4040-070-R05	4	6	10	70	0.5
4040-070-R10	4	6	10	70	1
4060-090-R02	6	6	15	90	0.2
4060-090-R03	6	6	15	90	0.3
4060-090-R05	6	6	15	90	0.5
4060-090-R10	6	6	15	90	1
4080-100-R02	8	8	20	100	0.2
4080-100-R03	8	8	20	100	0.3
4080-100-R05	8	8	20	100	0.5
4080-100-R10	8	8	20	100	1
4100-100-R03	10	10	25	100	0.3
4100-100-R05	10	10	25	100	0.5
4100-100-R10	10	10	25	100	1
4120-110-R03	12	12	30	110	0.3
4120-110-R05	12	12	30	110	0.5
4120-110-R10	12	12	30	110	1

F Technical Information for V Endmill

Improved productivity with effective machining due to less vibration

V Endmill

Variable Endmill

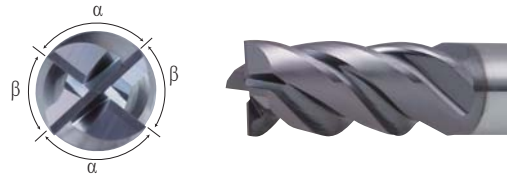

- Irregular helix angle
- Irregular indexing angle

* Irregular flute spacing = Decreased vibration by setting up cutting edges position variably

Features

- 30% increased cutting speed (vc) and feed rate (vf) to boost productivity
- High quality machining is ensured thanks to minimized tool vibrations and excellent surface finish

Performance (Vibration test)

- **Workpiece** SCM440
- **Cutting condition** D = Ø8.0, n (m/min) = 3183, vc (m/min) = 80, vf (mm/min) = 713, fz (mm/t) = 0.055, ap (mm) = 8.0, ae (mm) = 8, dry
- **Tools** V Endmill VFE4080-060, Conventional endmill

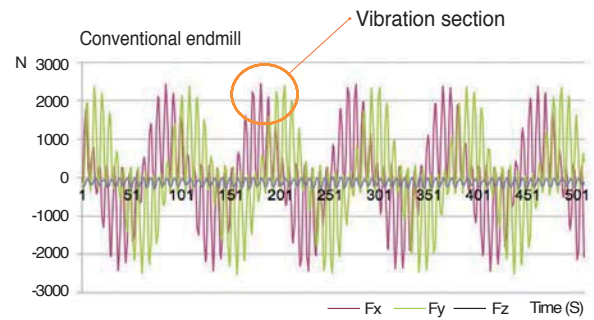
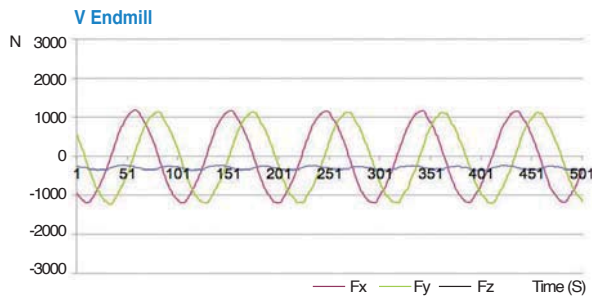

Performance (Surface finish)

- **Workpiece** STS304
- **Cutting condition** D = Ø8.0, n (min⁻¹) = 3979, vc (m/min) = 100, vf (mm/min) = 796, fz (mm/t) = 0.05, ap (mm) = 12, ae (mm) = 0.8, dry
- **Tools** VFE4080-060

Edge			
Surface finish			
Division	V Endmill	Competitor A Irregular flute spacing endmill	Competitor B Irregular flute spacing endmill

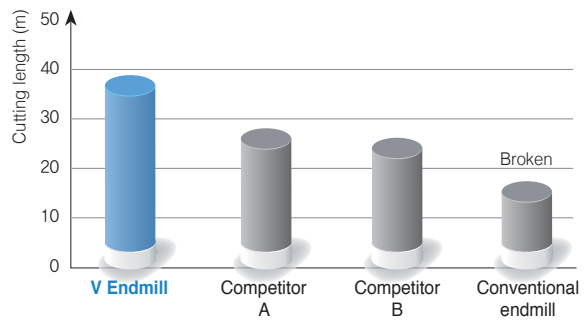

Application examples

- **Workpiece** SNCM439 (HRC 43~45)
- **Cutting condition** D = Ø8.0, n (m/min) = 6000, vc (m/min) = 150, vf (mm/min) = 600, fz (mm/t) = 0.025, ap (mm) = 7, ae (mm) = 0.8, wet (Water-soluble)
- **Tools** VFE4080-060



V Endmill



Conventional endmill

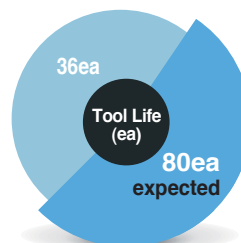

V Endmill(VFE4080)

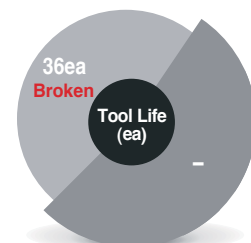

Conventional endmill



Recommended cutting conditions

Shouldering

Diameter (ØD)	Alloy & Carbon steel, HRC25 or less (SM, SCM)				Mold steel, HRC35~45 (STS, KP4M)			
	R.P.M (min ⁻¹)	Feed (mm/min)	ap (mm)	ae (mm)	R.P.M (min ⁻¹)	Feed (mm/min)	ap (mm)	ae (mm)
2.5	15,915	1,241	3.8	0.7	12,732	891	0.3	0.3
3.0	13,263	1,241	4.5	0.8	10,610	891	0.3	0.3
3.5	11,368	1,241	5.3	0.9	9,095	891	0.4	0.4
4.0	9,947	1,241	6.0	1.1	7,958	891	0.4	0.4
5.0	7,958	1,241	7.5	1.4	6,366	891	0.5	0.5
6.0	6,631	1,241	9.0	1.6	5,305	891	0.6	0.6
7.0	5,684	1,241	10.5	1.9	4,547	891	0.7	0.7
8.0	4,974	1,194	12.0	2.2	3,979	891	0.8	0.8
9.0	4,421	1,194	13.5	2.4	3,537	891	0.9	0.9
10.0	3,979	1,194	15.0	2.7	3,183	891	1.0	1.0
12.0	3,316	1,194	18.0	3.2	2,653	891	1.2	1.2
14.0	2,842	1,194	21.0	3.8	2,274	891	1.4	1.4
16.0	2,487	1,194	24.0	4.3	1,989	891	1.6	1.6

Application tip

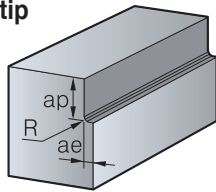

※ Cutting condition by overhang

1. Standard overhang: Follow cutting condition above
2. Long overhang: When the overhang is increased by 10 mm, decrease feed 5% & ae 5%

Slotting

Diameter (ØD)	Alloy & Carbon steel, HRC25 or less (SM, SCM)			Mold steel, HRC35~45 (STS, KP4M)		
	R.P.M (min ⁻¹)	Feed (mm/min)	ap (mm)	R.P.M (min ⁻¹)	Feed (mm/min)	ap (mm)
2.5	15,915	1,035	2.8	12,732	700	2.5
3.0	13,263	1,035	3.3	10,610	700	3.0
3.5	11,268	1,035	3.9	9,095	700	3.5
4.0	9,947	1,035	4.4	7,958	700	4.0
5.0	7,958	1,035	5.5	6,366	700	5.0
6.0	6,631	1,035	6.6	5,305	700	6.0
7.0	5,687	1,035	7.7	4,549	700	7.0
8.0	4,974	1,035	8.8	3,979	700	8.0
9.0	4,421	1,035	9.9	3,537	700	9.0
10.0	3,979	1,035	11.0	3,183	700	10.0
12.0	3,316	1,035	13.2	2,653	700	12.0
14.0	2,842	1,035	15.4	2,274	700	14.0
16.0	2,487	1,035	17.6	1,989	700	16.0

Application tip

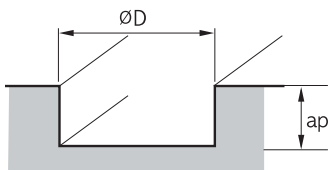

※ Cutting condition by overhang

1. Standard overhang: Follow cutting condition above
2. Long overhang: When the overhang is increased by 10 mm, decrease feed 5% & ae 5%

VFE4000 (Flat)

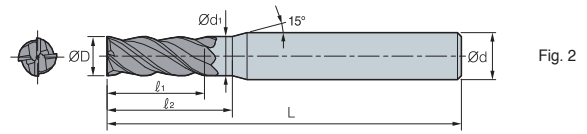
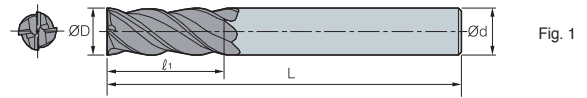

ØD	Tolerance
Ø2.5~Ø9	0.00~ -0.02
Ø10~Ø16	0.00~ -0.03



(mm)

Designation	ØD	Ød	d ₁	ℓ ₁	ℓ ₂	L	Fig.
VFE 4025-045	2.5	6.0	2.48	6.0	8.0	45	2
4030-050	3.0	6.0	2.98	7.0	9.5	50	2
4035-050	3.5	6.0	3.48	8.0	11.0	50	2
4040-050	4.0	6.0	3.98	9.0	12.0	50	2
4050-050	5.0	6.0	4.98	12.0	16.0	50	2
4060-050	6.0	6.0	-	14.0	-	50	1
4070-060	7.0	8.0	6.97	16.0	21.0	60	2
4080-060	8.0	8.0	-	19.0	-	60	1
4090-070	9.0	10.0	8.97	20.0	27.0	70	2
4100-075	10.0	10.0	-	23.0	-	75	1
4120-080	12.0	12.0	-	27.0	-	80	1
4140-085	14.0	14.0	-	31.0	-	85	1
4160-090	16.0	16.0	-	36.0	-	90	1



Fine performance and high quality Endmill for general cutting

Z Endmill **new**

- Endmill for general cutting of various workpieces under HRC45 (carbon steel, alloy steel, cast iron, pre-hardened steel, etc.)
- New shape and coating improves performance and tool life
- Optimized edge design for less chipping and stable machining

Features

- New grade (PC315E) - Fine substrate and lubricative coating guarantee excellent performance at high speed and high temperature
- Special edge treatment - Special cutting-edge design was applied for less chipping and longer tool life
- High accuracy with tolerance-h5 - High quality production system enables tolerance-h5 throughout the whole series

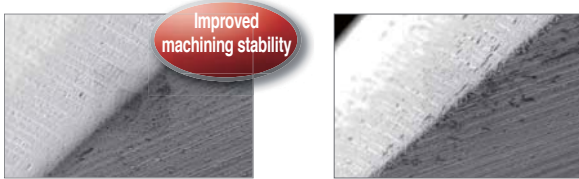

After special edge treatment

before

ZFE (Flat)

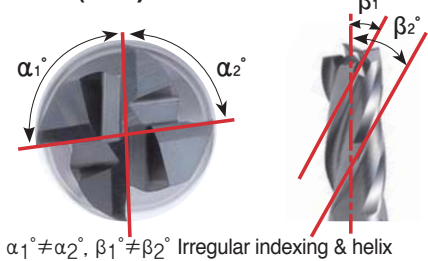

- Irregular indexing & helix prevent chattering and improve surface

ZBE (Ball)

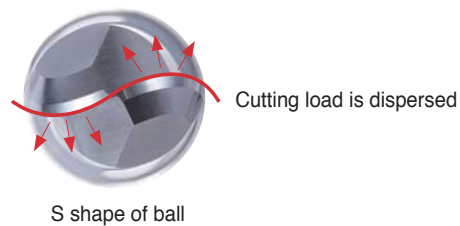

- The S shape of ball disperses cutting loads
- The tolerance of ball R is under ± 0.005 mm

Application examples

- **Workpiece** Carbon steel (SM45C, ~ HRC20)
- **Cutting condition** $D = \varnothing 8.0$, n (min^{-1}) = 7,165, vc (m/min) = 180, vf (mm/min) = 1.433, fz (mm/t) = 0.05, ap (mm) = 8, ae (mm) = 0.8, dry
- **Tools** ZFE4080-070



Z Endmill



Competitor

Test result

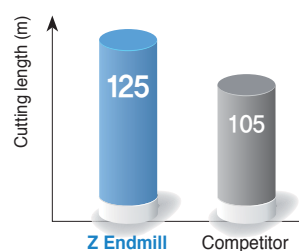

- Cutting edge treatment for less chipping

- **Workpiece** Carbon steel (SM45C, ~ HRC20)
- **Cutting condition** $D = \varnothing 8.0$, n (min^{-1}) = 5,175, vc (m/min) = 130, vf (mm/min) = 1.035, fz (mm/t) = 0.1, ap (mm) = 0.5, ae (mm) = 1.6, dry
- **Tools** ZFE2080-100



Z Endmill



Competitor

Test result

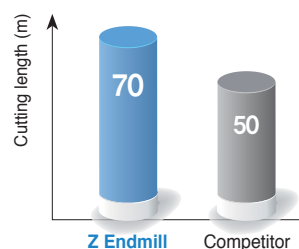

- New grade improves wear resistance

F Technical Information for Z Endmill

Recommended cutting conditions (ZFE2000/ZSFE2000 Flat)

Workpiece Condition	Alloy steel & carbon steel (under HRC30)		Pre-hardened steel (HRC30~45)		Stainless steel	
	R.P.M n (min ⁻¹)	Feed vf (mm/min)	R.P.M n (min ⁻¹)	Feed vf (mm/min)	R.P.M n (min ⁻¹)	Feed vf (mm/min)
Diameter (Ø)						
1	19,745	175	13,057	100	10,500	70
2	11,560	190	7,560	120	6,300	90
3	8,920	210	5,560	140	4,620	120
4	7,560	300	4,620	180	3,880	150
5	6,300	320	3,780	190	3,160	160
6	5,560	350	3,360	220	2,840	180
8	4,200	380	2,520	200	2,100	180
10	3,260	330	2,000	160	1,680	160
12	2,740	280	1,680	130	1,360	130
16	2,200	220	1,360	110	1,060	110

Application tip

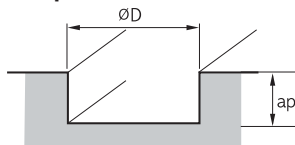

- Slotting depth (ap)
 - D ≤ Ø3 (ap = 0.2D)
 - D > Ø3 (ap = 0.5D)

* Workpiece should be clamped rigidly. In case of vibration, reduce R.P.M and feed rate by the same ratio

Recommended cutting conditions (ZFE4000/ZSFE4000 Flat)

Workpiece Condition	Alloy steel & carbon steel (under HRC30)		Pre-hardened steel (HRC30~45)		Stainless steel	
	R.P.M n (min ⁻¹)	Feed vf (mm/min)	R.P.M n (min ⁻¹)	Feed vf (mm/min)	R.P.M n (min ⁻¹)	Feed vf (mm/min)
Diameter (Ø)						
2	11,560	280	7,560	170	6,300	140
3	8,920	320	5,560	200	4,620	170
4	7,560	570	4,620	350	3,880	280
5	6,300	600	3,780	360	3,160	300
6	5,560	660	3,360	410	2,840	330
8	4,200	710	2,520	380	2,100	350
10	3,260	610	2,000	300	1,680	300
12	2,740	520	1,680	250	1,360	240
16	2,200	410	1,360	200	1,100	200

Application tip

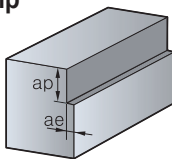

- Shouldering depth (ap) and radial depth (ae)
 - ap = 1.0D
 - ae = 0.05D

* Workpiece should be clamped rigidly. In case of vibration, reduce R.P.M and feed rate by the same ratio



Recommended cutting conditions (ZBE2000 Ball)

Workpiece Condition Diameter (Ø)	Alloy steel & carbon steel (under HRC30)		Pre-hardened steel (HRC30~45)	
	R.P.M n (min ⁻¹)	Feed vf (mm/min)	R.P.M n (min ⁻¹)	Feed vf (mm/min)
1	30,000	2,880	30,000	2,520
1.2	30,000	3,060	28,800	2,580
1.5	30,000	3,240	28,800	2,700
2	29,820	3,420	28,680	2,880
3	19,860	3,600	19,080	3,180
4	14,940	3,600	14,340	3,180
5	11,160	3,480	10,680	2,940
6	8,340	2,910	8,040	2,460
8	6,660	2,520	6,420	2,100
10	5,580	2,220	5,340	1,860
12	4,170	1,770	4,008	1,500

Application tip

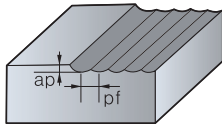

- $ap = 0.03D$
- $pf = 0.05D$

* Workpiece should be clamped rigidly. In case of vibration, reduce R.P.M and feed rate by the same ratio

Cutting condition by overhang

- For shank taper type, Cutting conditions are based on the case of being clamped at neck part
 - When the overhang is increased by 1D in comparison to the overhang, decrease R.P.M and feed by 10%
- In case of the straight type adjust conditions according to the overhang
 - Ex: When the overhang is 3D and is increased by 1D, decrease R.P.M and feed by 10%

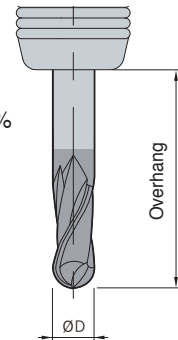

Notice

- Cutting conditions are up to the machine's condition and the shape of cutting
- Use cutting fluid that is proper to the workpiece and produces few temperature reactions

ZFE2000 (Flat)

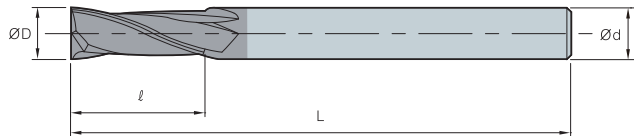

ØD	Tolerance
~Ø5.9	0.00~-0.015
Ø6.0~	0.00~-0.025



(mm)

Designation	ØD	Ød	ℓ	L
ZFE 2010-050-S4	1	4	2.5	50
2010-050-S6	1	6	2.5	50
2012-050-S4	1.2	4	3	50
2012-050-S6	1.2	6	3	50
2015-050-S4	1.5	4	4	50
2015-050-S6	1.5	6	4	50
2020-050-S4	2	4	6	50
2020-050-S6	2	6	6	50
2025-050-S4	2.5	4	7.5	50
2025-050-S6	2.5	6	7.5	50
2030-050-S4	3	4	9	50
2030-050-S6	3	6	9	50
2035-050	3.5	6	10	50
2040-050-S4	4	4	11	50
2040-050-S6	4	6	11	50
2045-050	4.5	6	14	50
2050-060	5	6	15	60
2055-060	5.5	6	15	60
2060-060	6	6	15	60
2065-060	6.5	8	18	60
2070-060	7	8	20	60
2075-060	7.5	8	20	60
2080-070	8	8	20	70
2085-070	8.5	10	22	70
2090-070	9	10	22	70
2095-070	9.5	10	24	70
2100-075	10	10	25	75
2120-080	12	12	30	80
2140-100	14	14	35	100
2160-100	16	16	40	100



ZFE4000 (Flat)

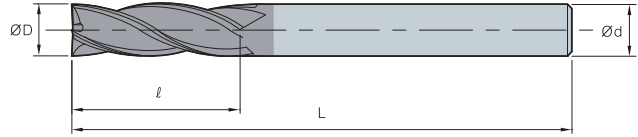

ØD	Tolerance
~Ø5.9	0.00~-0.015
Ø6.0~	0.00~-0.025



(mm)

Designation	ØD	Ød	ℓ	L
ZFE				
4 4010-050-S4	1	4	2.5	50
4010-050-S6	1	6	2.5	50
4012-050-S4	1.2	4	3	50
4012-050-S6	1.2	6	3	50
4015-050-S4	1.5	4	4	50
4015-050-S6	1.5	6	4	50
4020-050-S4	2	4	6	50
4020-050-S6	2	6	6	50
4025-050-S4	2.5	4	7.5	50
4025-050-S6	2.5	6	7.5	50
4030-050-S4	3	4	9	50
4030-050-S6	3	6	9	50
4035-050	3.5	6	10	50
4040-050-S4	4	4	11	50
4040-050-S6	4	6	11	50
4045-050	4.5	6	14	50
4050-060	5	6	15	60
4055-060	5.5	6	15	60
4060-060	6	6	15	60
4065-060	6.5	8	18	60
4070-060	7	8	20	60
4075-060	7.5	8	20	60
4080-070	8	8	20	70
4085-070	8.5	10	22	70
4090-070	9	10	22	70
4095-070	9.5	10	24	70
4100-075	10	10	25	75
4120-080	12	12	30	80
4140-100	14	14	35	100
4160-100	16	16	40	100

ZSFE2000/4000 (Short flat)

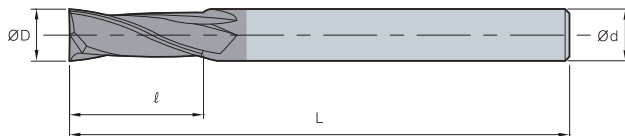

ØD	Tolerance
~Ø5.9	0.00~ -0.015
Ø6.0~	0.00~ -0.025



(mm)

Designation	ØD	Ød	ℓ	L	
ZSFE 2	2010-040-S4	1	4	1.5	40
	2010-040-S6	1	6	1.5	40
	2012-040-S4	1.2	4	1.5	40
	2012-040-S6	1.2	6	1.5	40
	2015-040-S4	1.5	4	2.2	40
	2015-040-S6	1.5	6	2.2	40
	2020-040-S4	2	4	3	40
	2020-040-S6	2	6	3	40
	2025-040-S4	2.5	4	4	40
	2025-040-S6	2.5	6	4	40
	2030-045-S4	3	4	4.5	45
	2030-045-S6	3	6	4.5	45
	2040-045-S4	4	4	6	45
	2040-045-S6	4	6	6	45
	2060-050	6	6	9	50
	2080-060	8	8	12	60
	2100-065	10	10	15	65
2120-070	12	12	18	70	
ZSFE 4	4010-040-S4	1	4	1.5	40
	4010-040-S6	1	6	1.5	40
	4012-040-S4	1.2	4	1.5	40
	4012-040-S6	1.2	6	1.5	40
	4015-040-S4	1.5	4	2.2	40
	4015-040-S6	1.5	6	2.2	40
	4020-040-S4	2	4	3	40
	4020-040-S6	2	6	3	40
	4025-040-S4	2.5	4	4	40
	4025-040-S6	2.5	6	4	40
	4030-045-S4	3	4	4.5	45
	4030-045-S6	3	6	4.5	45
	4040-045-S4	4	4	6	45
	4040-045-S6	4	6	6	45
	4060-050	6	6	9	50
	4080-060	8	8	12	60
	4100-065	10	10	15	65
4120-070	12	12	18	70	



ZBE2000 (Ball)

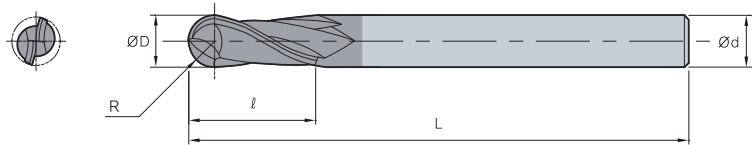

ØD	Tolerance
~Ø5.9	0.00~-0.015
Ø6.0~	0.00~-0.025



(mm)

Designation	R	ØD	Ød	ℓ	L
ZBE					
2010-050-S4	0.5	1	4	2.5	50
2010-050-S6	0.5	1	6	2.5	50
2012-050-S4	0.6	1.2	4	3	50
2012-050-S6	0.6	1.2	6	3	50
2015-050-S4	0.75	1.5	4	4	50
2015-050-S6	0.75	1.5	6	4	50
2020-050-S4	1	2	4	5	50
2020-050-S6	1	2	6	5	50
2025-060-S4	1.25	2.5	4	6	60
2025-060-S6	1.25	2.5	6	6	60
2030-060-S4	1.5	3	4	8	60
2030-060-S6	1.5	3	6	8	60
2035-070	1.75	3.5	6	8	70
2040-070-S4	2	4	4	8	70
2040-070-S6	2	4	6	8	70
2045-080	2.25	4.5	6	9	80
2050-080	2.5	5	6	10	80
2055-090	2.75	5.5	6	11	90
2060-090	3	6	6	12	90
2065-090	3.25	6.5	8	13	90
2070-090	3.5	7	8	14	90
2080-100	4	8	8	14	100
2085-100	4.25	8.5	10	16	100
2090-100	4.5	9	10	18	100
2100-100	5	10	10	18	100
2120-110	6	12	12	22	110

F Technical Information for F Endmill

High efficiency and high feed machining

F Endmill

Feed-up Endmill

- Improved productivity and shortened working time thanks to high feed capability
- Manufacturing cost reduction could be expected as it enables to apply highly efficient machining

Feature



- Highly efficient operation by setting up wider chip pocket area
- High feed machining is possible by dispersing cutting forces

Application by workpiece

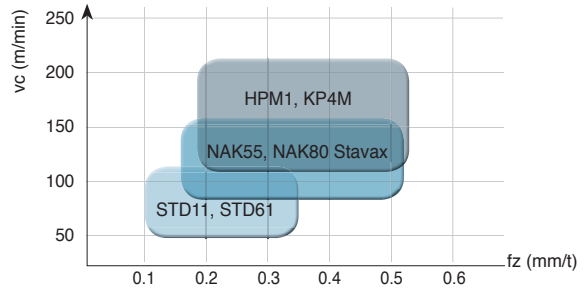

Productivity example

Type	Speed (vc)	Feed (fz)	D.O.C		Machining volume (mm ³ /min)
			ap	ae	
F Endmill (High feed)	180	0.30	0.5	5.0	135,000
Radius endmill	200	0.09	1.0	5.0	90,000
Flat endmill	120	0.05	8.0	0.2	48,000

Higher productivity by feed increase. 2.8 times

Productivity comparison

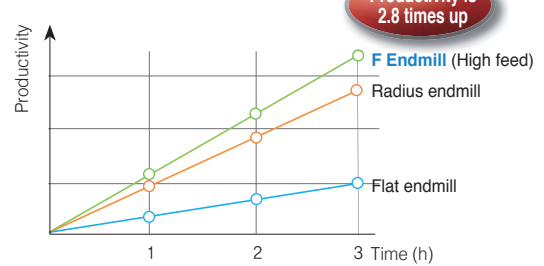

Programing information

Ramping	Ramping angle	Feed
	1°	100%
	2°	80%
	3°	60%
	4°	50%

Helical	Diameter (ØD)	Min. diameter	Max. diameter
	6	7.8	12
	8	10.2	16
	10	12.4	20
	12	14.9	24

* ØDc: Feed (Tool center) * ØDh: Machining area

CAM Ramping	Diameter (ØD)	Endmill-R	CAM-Radius	Un-cut part
	6	0.5	0.7	0.21
	8	0.5	0.8	0.32
	10	1.0	1.3	0.36
	12	1.2	1.6	1.45



Application examples

- **Workpiece** STD61+SKT (HRC45~50)
- **Cutting condition** D = Ø12, n (min⁻¹) = 4000, vc (m/min) = 150.8, vf (mm/min) = 4000, fz (mm/t) = 0.25, ap (mm) = 3.6, ae (mm) = 0.6, dry
- **Tools** FME4120-075-R12



Test result

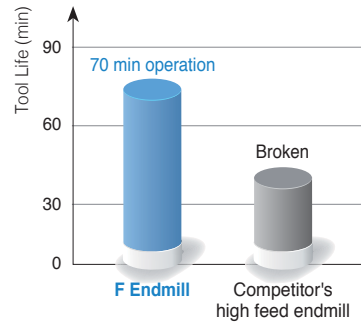

Recommended cutting conditions

■ Cusp height by radial depth of cut

Diameter (ØD)	Radial depth ae (mm)					
	0.1xD	0.2xD	0.3xD	0.4xD	0.5xD	0.6xD
6	0	0	0	0.02	0.06	0.11
8	0	0	0	0.04	0.10	0.15
10	0	0	0.01	0.07	0.14	0.21
12	0	0	0.01	0.08	0.17	0.25

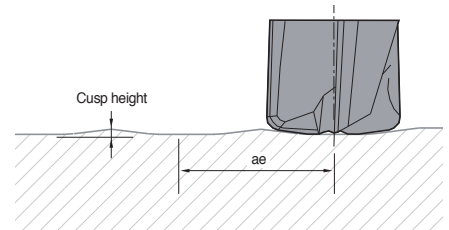

■ Medium cut

Diameter (ØD)	Mold steel Hrc35~45 (HPM1, KP4M)				Mold steel Hrc45~55 (NAK55, NAK80, STAVAX)				Heat treated steel Hrc55~ (SKD11, STD61)			
	RPM n (min ⁻¹)	Feed vf (mm/min)	ap (mm)	ae (mm)	RPM n (min ⁻¹)	Feed vf (mm/min)	ap (mm)	ae (mm)	RPM n (min ⁻¹)	Feed vf (mm/min)	ap (mm)	ae (mm)
6	11,600	11,200	0.24	1.6	9,000	7,570	0.21	1.6	5,800	3,500	0.18	1.6
8	8,700		0.32	2.2	6,700		0.28	2.2	4,300		0.24	2.2
10	7,000		0.40	2.7	5,400		0.35	2.7	3,500		0.30	2.7
12	5,800		0.48	3.3	4,500		0.42	3.3	2,900		0.36	3.3

■ Roughing cut

Diameter (ØD)	Mold steel Hrc35~45 (HPM1, KP4M)				Mold steel Hrc45~55 (NAK55, NAK80, STAVAX)				Heat treated steel Hrc55~ (SKD11, STD61)			
	RPM n (min ⁻¹)	Feed vf (mm/min)	ap (mm)	ae (mm)	RPM n (min ⁻¹)	Feed vf (mm/min)	ap (mm)	ae (mm)	RPM n (min ⁻¹)	Feed vf (mm/min)	ap (mm)	ae (mm)
6	8,488	9,167	0.27	3.0	6,366	6,112	0.24	3.0	4,244	2,546	0.21	3.0
8	6,366		0.36	4.0	4,775		0.32	4.0	3,183		0.28	4.0
10	5,093		0.45	5.0	3,820		0.40	5.0	2,546		0.35	5.0
12	4,244		0.54	6.0	3,183		0.48	6.0	2,122		0.42	6.0

* Cutting condition by overhang

1. Standard overhang: Follow cutting conditions above
2. Long type: Apply 80% feed & 80% ae
3. Long overhang: When the overhang is increased by 10 mm from the standard items, decrease feed 5% & ae 5%

FME4000 (High feed)

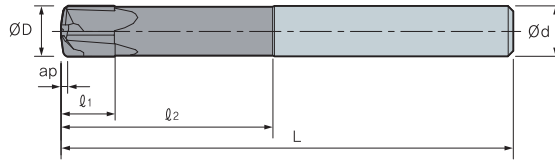

ØD	Tolerance
Ø6~Ø12	-0.01~-0.03

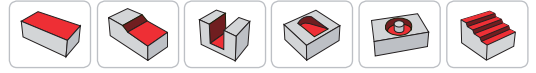

(mm)

Designation	R	ØD	Ød	l ₁	l ₂	L	Max. ap (mm)	CAM-Radius	
FME 	4060-050-R05	0.5	6	6	4.5	18	50	0.35	0.7
	4080-060-R05	0.5	8	8	6	24	60	0.45	0.8
	4100-070-R10	1.0	10	10	7.5	30	70	0.65	1.3
	4120-075-R12	1.2	12	12	9	36	75	0.78	1.6

FMLE4000 (High feed long)

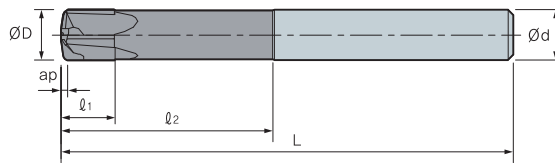

ØD	Tolerance
Ø6~Ø12	-0.01~-0.03

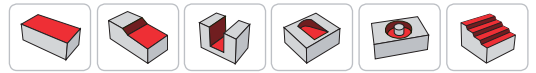

(mm)

Designation	R	ØD	Ød	l ₁	l ₂	L	Max. ap (mm)	CAM-Radius	
FMLE 	4060-090-R05	0.5	6	6	4.5	30	90	0.35	0.7
	4080-090-R05	0.5	8	8	6	40	90	0.45	0.8
	4100-100-R10	1.0	10	10	7.5	50	100	0.65	1.3
	4120-110-R12	1.2	12	12	9	60	110	0.78	1.6



Endmill for machining dental prostheses

T Endmill **new**

- For machining dental prostheses made of zirconia, titanium, Co-Cr, wax, PMMA, etc
- Optimized cutting performance by matching a proper grade with each type of materials
- Inhibited unevenness and excellent finish in machined surfaces due to the optimized cutting-edge design
- Specialized tool shape for each machine type

Code system

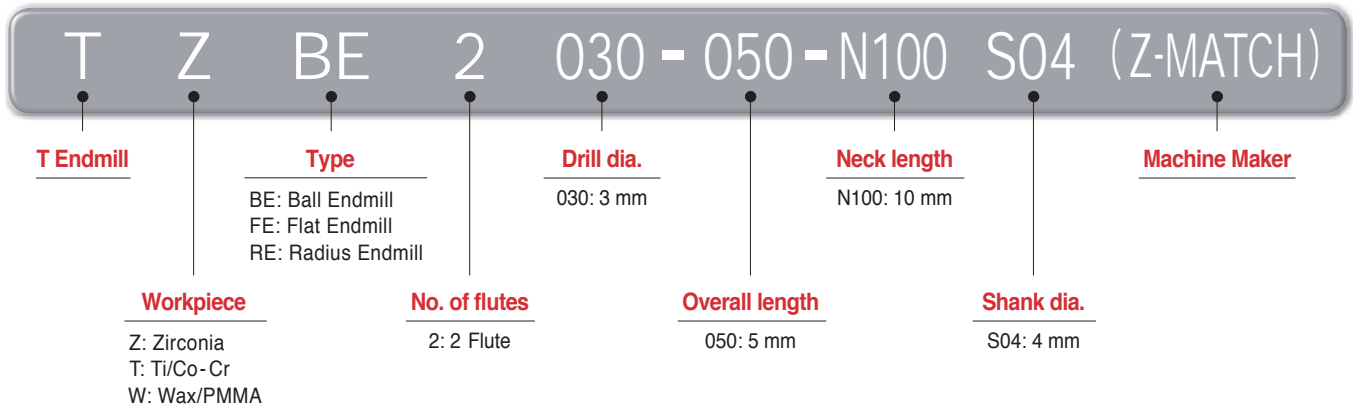

Features

- A dedicated tool for each machine - Meets marketplace demands
- A specialized grade for each workpiece - Provides optimized performance for various materials of implants
- Optimized cutting-edge design - Enables excellent machinability

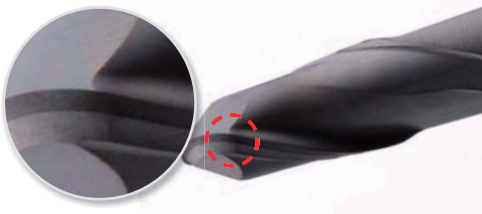

Tangential cutting-edge shape

- One-Pass Grinding applied
- Inhibited unevenness and excellent finish in machined surfaces

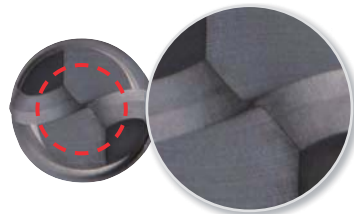

Center-Matched ball shape

- Optimized center shape ensures relief angle at the ball point
- Cutting edges of the ball point shape provide excellent wear resistance and cutting performance

Grade solution for zirconia

- **Development of ND3000 (Diamond-coated grade)**
 - High hardness diamond coating that is excellent in machining graphite and ceramic
 - Optimized for high speed and medium duty cutting thanks to its excellent grip to coated layers

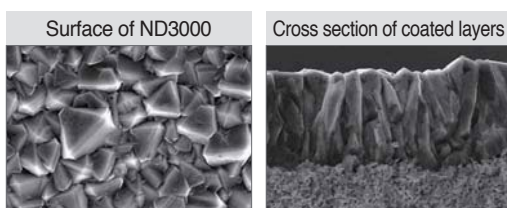

High hardness diamond coating (Hv 10,000) provides excellent wear resistance

Specialized grade for Zirconia provides excellent adhesion

Grade solution for titanium

- **Development of PC2510 (Coated grade for high hardened steel)**
 - Post-coating treatment was applied to improve surface finish
 - A grade optimized for interrupted machining of high hardness steels and wet treatment accompanying high thermal shock. Its ultrafine substrate features high toughness which allows stable performance

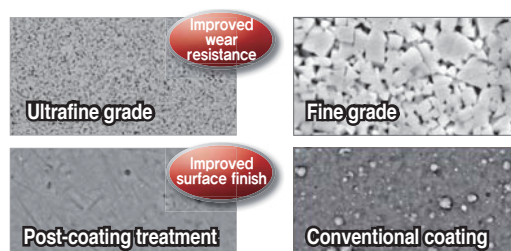

Improved wear resistance

Ultrafine grade

Fine grade

Improved surface finish

Post-coating treatment

Conventional coating

F Technical Information for T Endmill

Performance evaluation

- **Workpiece** Co-Cr
- **Cutting conditions**
 - vc (m/min) = 150,
 - fz (mm/t) = 0.08
 - ap (mm) = 0.13
 - ae (mm) = 0.7, wet
- **Tools** TTBE2030-050

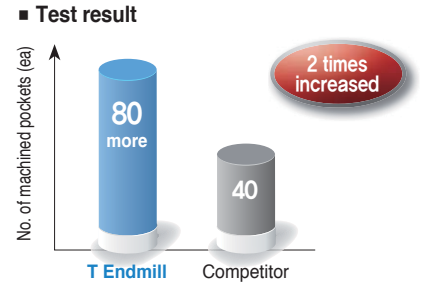
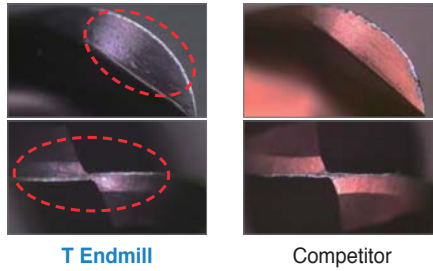

Excellent resistance to toughness and wear thanks to the new grade PC2510

Application examples

- **Use** Implant crowns
- **Workpiece** Zirconia
- **Cutting conditions**
 - vc (m/min) = 140
 - fz (mm/t) = 0.05
 - ae (mm) = 0.6, dry
- **Tools** TZBE2020-044-N200S03 (DOF)

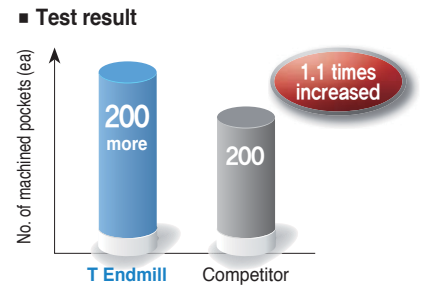

Recommended cutting conditions (Titanium & Co-Cr)

Diameter (Ø)	Application	ap (mm)	ae (mm)	n (min ⁻¹)	vf (mm/min)
3.0	Roughing	0.12	0.7	10,500	1,150
2.5	Medium	0.08	0.53	11,500	850
2.0	Medium	0.08	0.42	14,500	850
1.5	Finishing	0.04	0.32	19,000	850
1.0	Finishing	0.02	0.07	28,500	850
0.6	Finishing	0.02	0.07	28,500	850

Recommended cutting conditions for zirconia

Diameter (Ø)	Application	ap (mm)	ae (mm)	n (min ⁻¹)	vf (mm/min)
3.0	Roughing	0.5	1.5	23,500	1,600
2.5	Medium	0.3	1.25	28,000	1,200
2.0	Finishing	0.3	1.0	35,000	1,200
1.0	Finishing	0.1	0.2	38,500	1,050
0.6	Finishing	0.1	0.2	63,500	630



Special T Endmill order form

- Stop rings and other tool resources can be made to order

[Data sheet]

Type of machine	
Workpiece	
Dental material	
Cutting diameter (D1)	
Shank diameter (D2)	
Cutting length (L1)	
Neck length (L2)	
Stop ring position (L3)	
Overall length (L4)	
Stop ring shape	

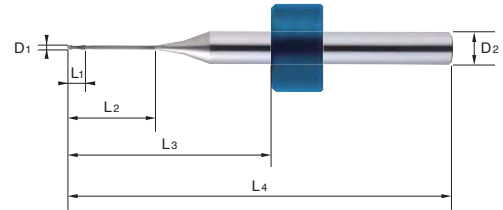

* Should you make a special order, please complete this form and send it to an adjacent KORLOY sales office

[Stop ring specification]

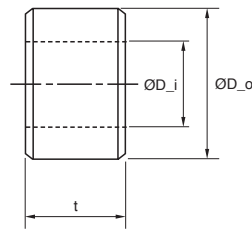

< Plastic ring >

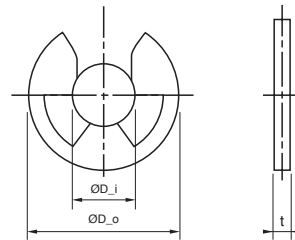

< E type ring >

(mm)

Type	Stop ring			Shank diameter		
	ØD_o	ØD_i	t	Ø3	Ø4	Ø6
Plastic ring	Ø7.55	Ø3	4.45	●		
	Ø7.7	Ø4	5.0		●	
	Ø10.5	Ø6	6.5			●
E type ring	Ø6.0	Ø2.5	0.4	●		

* Stop ring can be made to order when specified sizes are send to an adjacent KORLOY sales office



F Technical Information for D Endmill

Diamond coated endmill

D Endmill new

- Tangential cutting-edge geometries for excellent surface finish
- Excellent wear resistance due to high hardness and high purity diamond coating
- Advanced surface finish and cutting performance thanks to sharp edges and tangential tool geometries

Features



Tangential cutting-edge geometries

- One-Pass grinding system
- Prevents stepped cone on the machined surface
- 2-flutes and 4-flutes tooling with a ball nose

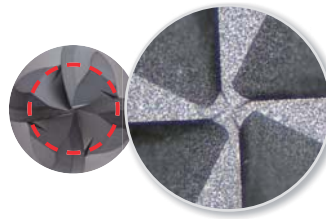

Center-matched ball shape (4-flutes)

- Ball point shape for high feed machining
- Improved rigidity and excellent surface finish

Application examples

- **Workpiece** Graphite mold
- **Cutting conditions**
 - vc (m/min) = 100,
 - fz (mm/t) = 0.11
 - ap (mm) = 0.26, dry
- **Tools** DBE4060-110-N250S06

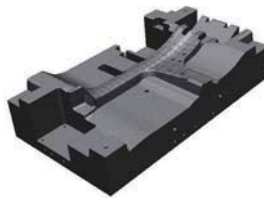

Test result

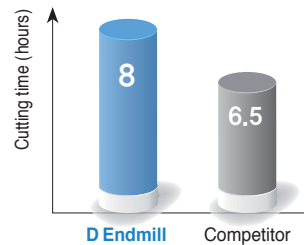

20% longer tool life

- **Workpiece** Graphite mold
- **Cutting conditions**
 - vc (m/min) = 180,
 - fz (mm/t) = 0.1
 - ap (mm) = 0.2, dry
- **Tools** DBE2060-110-N250S06

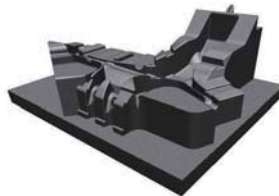

Test result

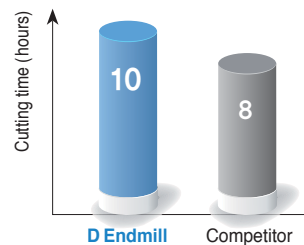

25% longer tool life

- **Workpiece** Graphite mold
- **Cutting conditions**
 - vc (m/min) = 300,
 - fz (mm/t) = 0.1
 - ap (mm) = 0.15, dry
- **Tools** DBE2060-080-N250S06



Test result

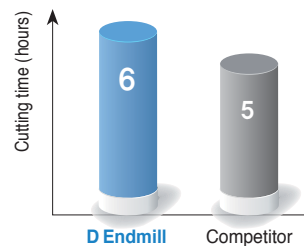

25% longer tool life



Recommended cutting conditions (Flat)

Tool	DFE2000 (Slotting)		DFE2000 (Shouldering)		DFE4000 (Shouldering)	
Workpiece	Graphite					
Conditions	R.P.M n (min ⁻¹)	Feed vf (mm/min)	R.P.M n (min ⁻¹)	Feed vf (mm/min)	RPM n (min-1)	Feed vf (mm/min)
Diameter (Ø)						
1	40,000	500	40,000	700	-	-
2	25,000	570	25,000	800	25,000	1,600
3	20,000	570	20,000	800	20,000	1,600
4	18,000	680	18,000	950	18,000	1,900
5	14,000	960	14,000	1,200	14,000	2,400
6	11,000	1,000	11,000	1,400	11,000	2,800
8	8,000	930	8,000	1,300	8,000	2,600
10	6,500	860	6,500	1,200	6,500	2,400
12	5,500	860	5,500	1,200	5,500	2,400

Application tip

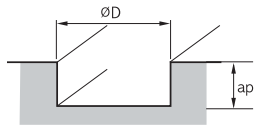

- Slotting depth (ap)
 - $D \leq \varnothing 2.5$, $ap = 0.3D$
 - $D > \varnothing 2.5$, $ap = 0.5D$

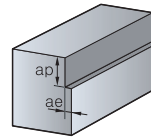

- Shouldering depth (ap)
 - $D \leq \varnothing 2.5$, $ap = 1.5D$, $ae = 0.05D$
 - $D > \varnothing 2.5$, $ap = 1.5D$, $ae = 0.1D$

※ Workpiece should be clamped rigidly. In case of vibrations, reduce R.P.M and feed rate by the same ratio

Recommended cutting conditions (Ball)

Tool	DBE2000		DBE4000	
Workpiece	Graphite			
Conditions	R.P.M n (min ⁻¹)	Feed vf (mm/min)	R.P.M n (min ⁻¹)	Feed vf (mm/min)
Diameter (Ø)				
1	16,000	400	-	-
2	16,000	800	16,000	1,200
3	16,000	1,450	16,000	2,000
4	16,000	2,100	16,000	3,100
5	15,500	2,550	15,000	3,800
6	15,000	2,950	15,000	4,400
8	13,000	3,000	13,000	4,500
10	11,500	3,000	12,000	4,600
12	10,700	3,200	10,000	4,700

Application tip

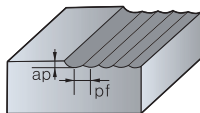

- Depth of cut (ap)
 - $ap = 0.2D$
 - $pf = 0.2D$

※ Workpiece should be clamped rigidly. In case of vibrations, reduce R.P.M and feed rate by the same ratio

Notice

- Cutting conditions are up to the machine's condition and the shape of cutting
- Workpiece should be clamped rigidly. In case of vibrations, reduce RPM and feed rate by the same ratio
- When the overhang is longer than 3D, reduce RPM and feed rate

DFE2000 (Flat)

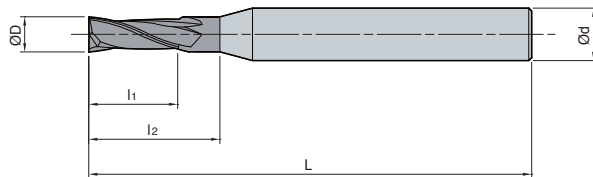

ØD	Tolerance
~Ø5.9	0.00~-0.02
Ø6.0~	0.00~-0.03

(mm)

Designation	ØD	Ød	l ₁	l ₂	L
DFE					
2010-045-N050S04	1	4	3	5	45
2010-060-N050S04	1	4	3	5	60
2010-060-N100S04	1	4	3	10	60
2010-060-N150S04	1	4	3	15	60
2010-060-N200S04	1	4	3	20	60
2010-060-N250S04	1	4	3	25	60
2015-060-N050S04	1.5	4	4	5	60
2015-060-N100S04	1.5	4	4	10	60
2015-060-N150S04	1.5	4	4	15	60
2015-060-N200S04	1.5	4	4	20	60
2015-060-N250S04	1.5	4	4	25	60
2020-045-N080S04	2	4	6	8	45
2020-080-N080S04	2	4	6	8	80
2020-080-N100S04	2	4	6	10	80
2020-080-N150S04	2	4	6	15	80
2020-080-N200S04	2	4	6	20	80
2020-080-N250S04	2	4	6	25	80
2020-080-N300S04	2	4	6	30	80
2020-080-N400S04	2	4	6	40	80
2030-050-N100S06	3	6	9	10	50
2030-080-N100S04	3	4	9	10	80
2030-080-N200S04	3	4	9	20	80
2030-080-N250S04	3	4	9	25	80
2030-080-N300S04	3	4	9	30	80
2030-080-N400S04	3	4	9	40	80
2040-050-N160S06	4	6	12	16	50
2040-080-N160S04	4	4	12	16	80
2050-060-N200S06	5	6	15	20	60
2050-110-N200S06	5	6	15	20	110
2060-060-N180S06	6	6	18	-	60
2060-110-N250S06	6	6	18	25	110
2060-150-N250S06	6	6	18	25	150
2080-070-N250S08	8	8	25	-	70
2080-150-N400S08	8	8	25	40	150
2100-080-N300S10	10	10	30	-	80
2100-150-N500S10	10	10	30	50	150
2120-080-N350S12	12	12	35	-	80
2120-150-N600S12	12	12	35	60	150



DFE4000 (Flat)

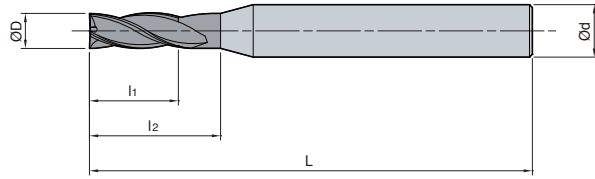

ØD	Tolerance
~Ø5.9	0.00~ -0.02
Ø6.0~	0.00~ -0.03

Designation		ØD	Ød	l ₁	l ₂	L
DFE	4020-045-N060S04	2	4	6	8	45
	4020-060-N100S04	2	4	10	12	60
	4030-050-N100S06	3	6	10	12	50
	4030-060-N150S04	3	4	15	18	60
	4040-050-N150S06	4	6	15	18	50
	4040-080-N200S04	4	4	20	-	80
	4060-060-N180S06	6	6	18	-	60
	4060-110-N300S06	6	6	30	-	110
	4060-150-N300S06	6	6	30	-	150
	4080-070-N250S08	8	8	25	-	70
	4080-110-N400S08	8	8	40	-	110
	4080-150-N400S08	8	8	40	-	150
	4100-080-N250S10	10	10	25	-	80
	4100-110-N400S10	10	10	40	-	110
	4100-150-N500S10	10	10	50	-	150
	4120-080-N300S12	12	12	30	-	80
	4120-110-N400S12	12	12	40	-	110
	4120-150-N500S12	12	12	50	-	150

(mm)

DBE2000 (Ball)

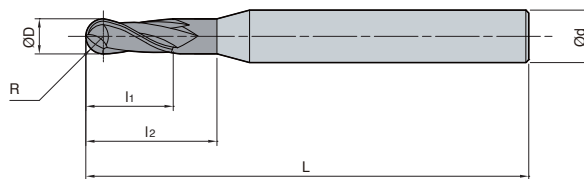

ØD	Tolerance
~Ø5.9	0.00~-0.02
Ø6.0~	0.00~-0.03

(mm)

Designation	R	ØD	Ød	l ₁	l ₂	L
DBE						
2006-045-N020S04	0.3	0.6	4	2	2	45
2006-045-N050S04	0.3	0.6	4	2	5	45
2006-045-N080S04	0.3	0.6	4	2	8	45
2006-045-N100S04	0.3	0.6	4	2	10	45
2008-045-N030S04	0.4	0.8	4	2.5	3	45
2008-045-N050S04	0.4	0.8	4	2.5	5	45
2008-045-N100S04	0.4	0.8	4	2.5	10	45
2010-060-N030S04	0.5	1	4	3	3	60
2010-060-N050S04	0.5	1	4	3	5	60
2010-060-N080S04	0.5	1	4	3	8	60
2010-060-N100S04	0.5	1	4	3	10	60
2010-060-N120S04	0.5	1	4	3	12	60
2010-060-N150S04	0.5	1	4	3	15	60
2010-060-N200S04	0.5	1	4	3	20	60
2010-080-N250S04	0.5	1	4	3	25	80
2010-080-N300S04	0.5	1	4	3	30	80
2010-080-N350S04	0.5	1	4	3	35	80
2010-080-N400S04	0.5	1	4	3	40	80
2015-060-N050S04	0.75	1.5	4	4	5	60
2015-080-N100S04	0.75	1.5	4	4	10	80
2015-080-N150S04	0.75	1.5	4	4	15	80
2015-080-N200S04	0.75	1.5	4	4	20	80
2015-080-N250S04	0.75	1.5	4	4	25	80
2015-080-N300S04	0.75	1.5	4	4	30	80
2015-080-N350S04	0.75	1.5	4	4	35	80
2015-080-N400S04	0.75	1.5	4	4	40	80
2020-060-N080S04	1	2	4	6	8	60
2020-080-N100S04	1	2	4	6	10	80
2020-080-N150S04	1	2	4	6	15	80
2020-080-N200S04	1	2	4	6	20	80
2020-080-N250S04	1	2	4	6	25	80
2020-080-N300S04	1	2	4	6	30	80
2020-080-N350S04	1	2	4	6	35	80
2020-100-N400S04	1	2	4	6	40	100
2020-100-N450S04	1	2	4	6	45	100
2020-100-N500S04	1	2	4	6	50	100



DBE2000 (Ball)

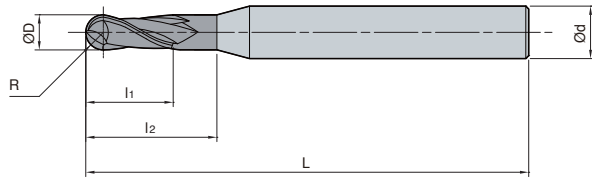

ØD	Tolerance
~Ø5.9	0.00~-0.02
Ø6.0~	0.00~-0.03

Designation		R	ØD	Ød	l ₁	l ₂	L
DBE	2030-060-N100S04	1.5	3	4	9	10	60
	2030-100-N150S04	1.5	3	4	9	15	100
	2030-100-N200S04	1.5	3	4	9	20	100
	2030-100-N250S04	1.5	3	4	9	25	100
	2030-100-N300S04	1.5	3	4	9	30	100
	2030-100-N350S04	1.5	3	4	9	35	100
	2030-100-N400S04	1.5	3	4	9	40	100
	2030-100-N500S04	1.5	3	4	9	50	100
	2040-060-N160S04	2	4	4	12	16	60
	2040-080-N160S04	2	4	4	12	16	80
	2040-080-N300S04	2	4	4	12	30	80
	2040-100-N160S04	2	4	4	12	16	100
	2040-100-N400S04	2	4	4	12	40	100
	2040-130-N160S04	2	4	4	12	16	130
	2040-130-N400S04	2	4	4	12	40	130
	2050-110-N200S06	2.5	5	6	15	20	110
	2060-080-N250S06	3	6	6	20	25	80
	2060-110-N250S06	3	6	6	20	25	110
	2060-150-N300S06	3	6	6	20	30	150
	2080-080-N300S08	4	8	8	25	30	80
	2080-110-N300S08	4	8	8	25	30	110
	2080-150-N500S08	4	8	8	25	50	150
	2080-200-N400S08	4	8	8	25	40	200
	2100-080-N400S10	5	10	10	30	40	80
	2100-110-N400S10	5	10	10	30	40	110
	2100-150-N600S10	5	10	10	30	60	150
	2100-200-N500S10	5	10	10	30	50	200
	2120-110-N500S12	6	12	12	35	50	110
	2120-150-N500S12	6	12	12	35	50	150
	2120-200-N600S12	6	12	12	35	60	200

(mm)



DBE4000 (Ball)

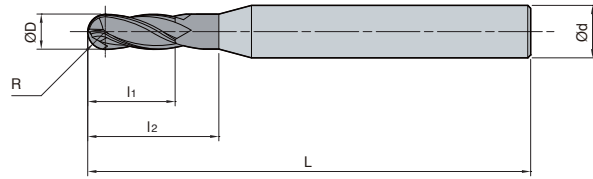

ØD	Tolerance
~Ø5.9	0.00~-0.02
Ø6.0~	0.00~-0.03

(mm)

Designation	R	ØD	Ød	l ₁	l ₂	L
DBE						
4020-060-N080S04	1	2	4	6	8	60
4020-080-N100S04	1	2	4	6	10	80
4020-080-N200S04	1	2	4	6	20	80
4020-080-N300S04	1	2	4	6	30	80
4020-080-N400S04	1	2	4	6	40	80
4030-060-N100S04	1.5	3	4	9	10	60
4030-100-N150S04	1.5	3	4	9	15	100
4030-100-N200S04	1.5	3	4	9	20	100
4030-100-N300S04	1.5	3	4	9	30	100
4030-100-N400S04	1.5	3	4	9	40	100
4030-100-N500S04	1.5	3	4	9	50	100
4040-060-N160S04	2	4	4	12	16	60
4040-080-N160S04	2	4	4	12	16	80
4040-100-N160S04	2	4	4	12	16	100
4040-130-N160S04	2	4	4	12	16	130
4060-080-N250S06	3	6	6	20	25	80
4060-110-N250S06	3	6	6	20	25	110
4060-150-N300S06	3	6	6	20	30	150
4080-080-N300S08	4	8	8	25	30	80
4080-110-N300S08	4	8	8	25	30	110
4080-150-N350S08	4	8	8	25	35	150
4080-200-N400S08	4	8	8	25	40	200
4100-080-N350S10	5	10	10	30	35	80
4100-110-N350S10	5	10	10	30	35	110
4100-150-N400S10	5	10	10	30	40	150
4100-200-N500S10	5	10	10	30	50	200
4120-110-N500S12	6	12	12	35	50	110
4120-150-N500S12	6	12	12	35	50	150
4120-200-N600S12	6	12	12	35	60	200



Good chip evacuation and fine resistance for built up edge

Solid Endmills for Aluminum

- Good surface finish with minimized cutting load and built-up edge occurrence
- DLC coating
 - Higher hardness (Hv3000-7000), About 3 to 6 times longer tool life comparing uncoated endmill
 - Fine surface roughness on workpiece with excellent lubricative effect by low friction co-efficient ($\mu < 0.1$)
- Superior in Aluminum, Aluminum alloys, Copper and Copper alloys

Features of copper & aluminum machining

- Built-up edge is easily generated though the workpiece has low cutting resistance and chip-removal is fine
- As it has high coefficient of thermal expansion, deflection degree due to machining heat is huge, and it also influences to workpiece quality and residual stress
- While machining, chips can easily damage on the workpiece's surface as the workpiece has low hardness, and tool life is over due to flank wear in general

Trouble shooting for copper & aluminum machining

- Use a higher rake angled tool with sharper edges, and minimizes cutting load and built-up edge generating by using oil (MQL) mist
- Increase V_c and reduce the depth of cut for a better surface finish and productivity

Recommended cutting conditions (SSEA2000)

Workpiece Condition Diameter (\varnothing)	Shouldering				Slotting			
	Aluminum alloy (A7075)		Aluminum alloy (cast) (AC4B)		Aluminum alloy (A7075)		Aluminum alloy (cast) (AC4B)	
	R.P.M n (min^{-1})	Feed vf (mm/min)	R.P.M n (min^{-1})	Feed vf (mm/min)	R.P.M n (min^{-1})	Feed vf (mm/min)	R.P.M n (min^{-1})	Feed vf (mm/min)
1	40,000	480	40,000	368	40,000	368	40,000	280
2	40,000	880	38,000	680	38,000	680	32,000	440
3	32,000	1,120	25,000	760	25,000	760	21,000	480
4	24,000	1,200	19,000	800	19,000	800	13,000	520
5	19,000	1,280	15,000	880	15,000	800	13,000	560
6	16,000	1,520	13,000	960	13,000	880	11,000	600
8	12,000	1,520	9,500	960	9,500	960	8,000	640
10	9,500	1,520	7,600	960	7,600	960	6,400	640
12	8,000	1,520	6,400	960	6,400	960	5,300	640
16	6,000	1,520	4,800	960	4,800	800	4,000	576
20	4,800	1,200	3,800	800	3,800	776	3,200	528

Application tip

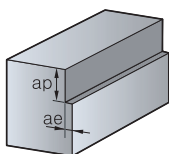

Shouldering depth (ap) and radial depth (ae)

- $a_p \leq 2.0D$
- $a_e \leq 0.2D$ ($D < \varnothing 3$)
- $a_e \leq 0.5D$ ($D \geq \varnothing 3$)

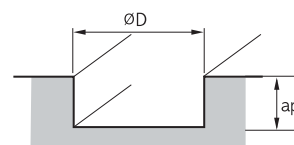

Slotting depth (ap)

- $a_p \leq D$ (max: 12 mm)

* Workpiece should be clamped rigidly In case of vibrations, reduce R.P.M and feed rate by the same ratio

SSEA2000/3000 (Flat)

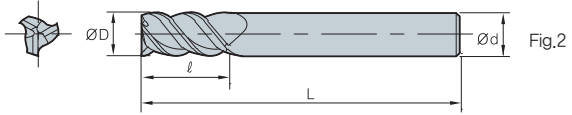
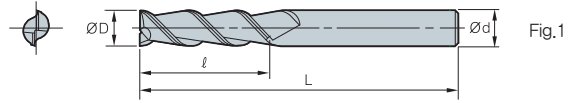

ØD	Tolerance
Ø1~Ø6	-0.010~-0.030
Ø7~Ø10	-0.015~-0.040
Ø11~Ø20	-0.020~-0.050

(mm)

Designation		ØD	Ød	ℓ	L	Fig.
SSEA	2010	1	6	3	40	1
	2015	1.5	6	4	40	1
	2020	2	6	6	40	1
	2025	2.5	6	7	40	1
	2030	3	6	10	45	1
	2035	3.5	6	10	45	1
	2040	4	6	12	45	1
	2050	5	6	15	50	1
	2060	6	6	15	50	1
	2070	7	8	20	60	1
	2080	8	8	20	60	1
	2090	9	10	20	70	1
	2100	10	10	25	70	1
	2110	11	12	25	75	1
	2120	12	12	30	75	1
	2130	13	16	30	90	1
	2140	14	16	35	90	1
	2150	15	16	40	90	1
	2160	16	16	40	90	1
	SSEA	3020	2	6	6	40
3030		3	6	10	45	2
3035		3.5	6	10	45	2
3040		4	6	12	45	2
3050		5	6	15	50	2
3060		6	6	15	50	2
3070		7	8	20	60	2
3080		8	8	20	60	2
3090		9	10	20	70	2
3100		10	10	25	70	2
3110		11	12	25	75	2
3120		12	12	30	75	2
3130		13	16	30	90	2
3140		14	16	35	90	2
3150		15	16	40	90	2
3160		16	16	40	90	2

Special endmills order: SSEA○○○○○-L

Ex.1) 3 flutes, diameter: 6.3.I: 17, L: 60 SSEA3063 17-60L

Ex.2) 3 flutes, diameter: 6.3.standard type SSEA3063



SSBEA2000 (Ball)

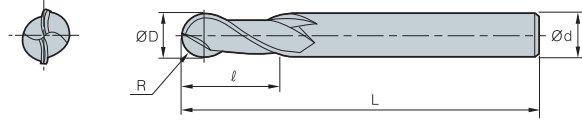

ØD	Tolerance
All	0~-0.03

(mm)

Designation	R	ØD	Ød	ℓ	L
SSBEA					
2010	0.5	1	6	3	70
2015	0.75	1.5	6	4	70
2020	1	2	6	6	70
2025	1.25	2.5	6	8	70
2030	1.5	3	6	10	70
2035	1.75	3.5	6	10	70
2040	2	4	6	12	70
2045	2.25	4.5	6	15	80
2050	2.5	5	6	15	80
2055	2.75	5.5	6	15	80
2060	3	6	6	15	80
2065	3.25	6.5	8	20	90
2070	3.5	7	8	20	90
2075	3.75	7.5	8	20	90
2080	4	8	8	20	90
2085	4.25	8.5	10	25	100
2090	4.5	9	10	25	100
2100	5	10	10	25	100
2110	5.5	11	12	30	110
2120	6	12	12	30	110
2130	6.5	13	16	35	120
2140	7	14	16	35	120
2150	7.5	15	16	40	120
2160	8	16	16	40	120
2170	8.5	17	20	40	130
2180	9	18	20	45	130
2190	9.5	19	20	45	130
2200	10	20	20	45	130

Special endmills order: SSBEA2000-L

Ex.1) 2 flutes, diameter: 6.3. L: 60 SSBEA3063 17-60L

Ex.2) 2 flutes, diameter: 6.3. standard type SSBEA3063

F Technical Information for C-Max (Copper)

Long tool life and good surface roughness for copper based electrode machining

C-Max Copper

- Superior lubricity, wear resistance & chipping resistance due to the K-Silver coating layer and optimal substrate
- Optimal for copper and non-ferrous metal machining
- Wide line up (ball, flat, radius & long neck type)

Features

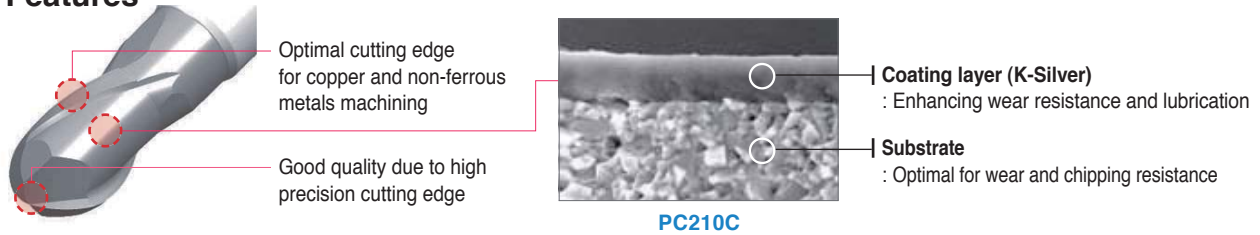

Application example

- **Workpiece** Cu, Electrode machining
- **Cutting conditions** vc (m/min) = 70, fz (mm/t) = 0.083, ap (mm) = 0.6, ae (mm) = 3.0
- **Tools** CRE4100-070-R10

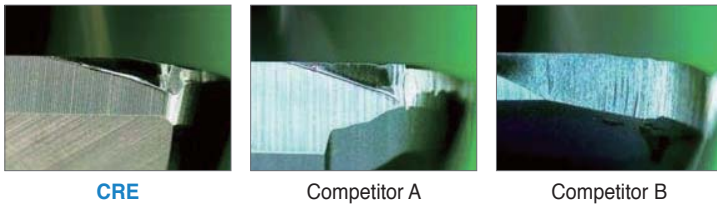

Test result

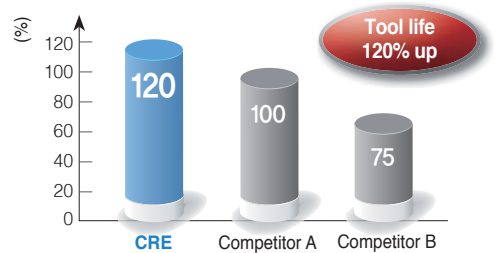

Recommended cutting conditions

Workpiece	CBE/CBNE		CFE/CFNE		CRE/CRNE	
	Copper alloys					
Condition Diameter (Ø)	R.P.M n (min ⁻¹)	Feed vf (mm/min)	R.P.M n (min ⁻¹)	Feed vf (mm/min)	R.P.M n (min ⁻¹)	Feed vf (mm/min)
0.5	40,000	2,600	40,000	1,800	-	-
1	40,000	2,800	40,000	2,000	40,000	2,000
1.5	40,000	3,200	40,000	2,400	30,000	2,400
2	40,000	3,600	30,000	1,800	30,000	1,800
3	40,000	4,000	23,000	1,380	20,000	1,380
4	32,000	3,200	15,000	900	15,000	900
5	25,000	2,500	12,000	750	12,000	750
6	21,000	2,100	10,000	600	10,000	600
8	16,000	1,600	8,000	480	8,000	480
10	13,000	1,300	6,400	384	6,400	384
12	9,000	900	5,400	324	5,400	324

Application tip

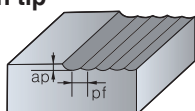

- $ap = 0.1D$
- $pf = 0.2D$

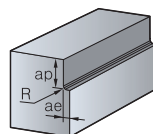

- $ap = 1.5D$
- $ae = 0.1D$

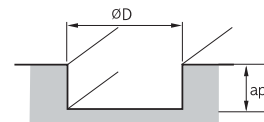

- $ap \leq 1.5D$

※ Workpiece should be clamped rigidly. In case of vibrations, reduce R.P.M and feed rate by the same ratio



CFE2000 (Flat)

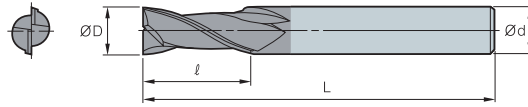

ØD	Tolerance
Ø0.5~Ø6	0.00~0.01
Ø8~Ø12	0.00~0.02

(mm)

Designation	ØD	Ød	ℓ	L
CFE				
2010-040	1	4	2.5	40
2015-040	1.5	4	4	40
2020-045	2	4	5	45
2030-045	3	6	8	45
2040-050	4	6	11	50
2050-060	5	6	13	60
2060-060	6	6	13	60
2080-060	8	8	19	60
2100-070	10	10	22	70
2120-075	12	12	26	75

CFNE2000 (Long neck flat)

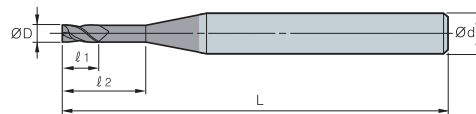

ØD	Tolerance
Ø0.5~Ø6	0.00~0.01
Ø8~Ø12	0.00~0.02

(mm)

Designation	ØD	Ød	ℓ ₁	ℓ ₂	L
CFNE					
2005-045-N2	0.5	4	0.8	2	45
2005-045-N4	0.5	4	0.8	4	45
2005-045-N6	0.5	4	0.8	6	45
2005-050-N8	0.5	4	0.8	8	50
2010-045-N4	1	4	1.5	4	45
2010-045-N6	1	4	1.5	6	45
2010-050-N8	1	4	1.5	8	50
2010-050-N10	1	4	1.5	10	50
2015-045-N6	1.5	4	2.3	6	45
2015-050-N8	1.5	4	2.3	8	50
2015-050-N10	1.5	4	2.3	10	50
2015-050-N12	1.5	4	2.3	12	50
2020-045-N6	2	4	3	6	45
2020-050-N8	2	4	3	8	50
2020-050-N10	2	4	3	10	50
2020-055-N12	2	4	3	12	50
2030-050-N10	3	4	4.5	10	50
2030-050-N12	3	4	4.5	12	50
2030-060-N14	3	4	4.5	14	60
2030-060-N16	3	4	4.5	16	60
2040-050-N12	4	6	6	12	50
2040-050-N16	4	6	6	16	50
2040-060-N20	4	6	6	20	60

CBE2000 (Ball)

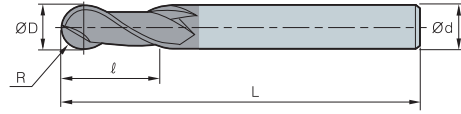

ØD	Tolerance	R Tolerance
Ø0.5~Ø6	0.00~0.01	±0.005
Ø8~Ø12	0.00~0.02	±0.005

(mm)

Designation	R	ØD	Ød	ℓ	L
CBE 2010-050	0.5	1	4	2.5	50
2015-050	0.75	1.5	4	4	50
2020-050	1	2	4	5	50
2030-060	1.2	3	6	8	60
2040-070	2	4	6	8	70
2050-080	2.5	5	6	10	80
2060-080	3	6	6	12	80
2080-090	4	8	8	14	90
2100-100	5	10	10	18	100
2120-110	6	12	12	22	110

CBNE2000 (Long neck ball)

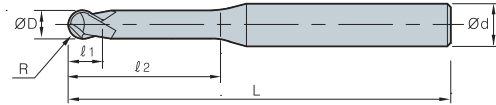

ØD	Tolerance
Ø0.5~Ø6	0.00~0.01
Ø8~Ø12	0.00~0.02

(mm)

Designation	R	ØD	Ød	ℓ ₁	ℓ ₂	L
CBNE 2005-045-N2	0.25	0.5	4	0.5	2	45
2005-045-N4	0.25	0.5	4	0.5	4	45
2005-045-N6	0.25	0.5	4	0.5	6	45
2005-050-N8	0.25	0.5	4	0.5	8	50
2010-045-N4	0.5	1	4	1	4	45
2010-045-N6	0.5	1	4	1	6	45
2010-050-N8	0.5	1	4	1	8	50
2010-050-N10	0.5	1	4	1	10	50
2015-050-N8	0.75	1.5	4	1.5	8	50
2015-050-N10	0.75	1.5	4	1.5	10	50
2015-050-N12	0.75	1.5	4	1.5	12	50
2015-055-N14	0.75	1.5	4	1.5	14	55
2020-050-N8	1	2	4	2	8	50
2020-050-N10	1	2	4	2	10	50
2020-050-N12	1	2	4	2	12	50
2020-055-N14	1	2	4	2	14	55
2030-050-N10	1.5	3	4	3	10	50
2030-050-N12	1.5	3	4	3	12	50
2030-055-N14	1.5	3	4	3	14	55
2030-055-N16	1.5	3	4	3	16	60
2040-060-N16	2	4	6	4	16	60
2040-060-N20	2	4	6	4	20	60
2040-070-N25	2	4	6	4	25	70
2040-070-N30	2	4	6	4	30	70



CRE2000 (Radius)

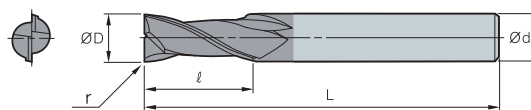

ØD	Tolerance	R Tolerance
Ø0.5~Ø6	0.00~0.01	±0.005
Ø8~Ø12	0.00~0.02	±0.005

(mm)

Designation	r	ØD	Ød	l	L
CRE 2020-045-R05	0.5	2	4	5	45
2030-045-R05	0.5	3	6	8	45
2040-050-R05	0.5	4	6	11	50
2050-060-R05	0.5	5	6	13	60
2060-060-R05	0.5	6	6	13	60
2080-060-R10	1	8	8	19	60
2100-070-R10	1	10	10	22	70
2120-075-R10	1	12	12	26	75

CRNE2000 (Long neck radius)

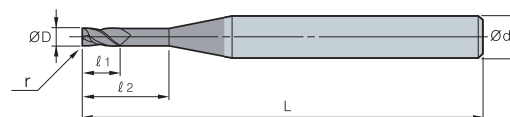

ØD	Tolerance	R Tolerance
Ø0.5~Ø6	0.00~0.01	±0.005
Ø8~Ø12	0.00~0.02	±0.005

(mm)

Designation	r	ØD	Ød	l ₁	l ₂	L
CRNE 2010-045-R02N4	0.2	1	4	1.5	4	45
2010-045-R02N6	0.2	1	4	1.5	6	45
2010-050-R02N8	0.2	1	4	1.5	8	50
2010-050-R02N10	0.2	1	4	1.5	10	50
2015-045-R02N6	0.2	1.5	4	2.3	6	45
2015-050-R02N8	0.2	1.5	4	2.3	8	50
2015-050-R02N10	0.2	1.5	4	2.3	10	50
2015-050-R02N12	0.2	1.5	4	2.3	12	50
2020-045-R05N6	0.5	2	4	3	6	45
2020-050-R05N8	0.5	2	4	3	8	50
2020-050-R05N10	0.5	2	4	3	10	50
2020-055-R05N12	0.5	2	4	3	12	50
2030-050-R05N10	0.5	3	4	4.5	10	50
2030-050-R05N12	0.5	3	4	4.5	12	50
2030-060-R05N14	0.5	3	4	4.5	14	60
2030-060-R05N16	0.5	3	4	4.5	16	60
2040-050-R05N12	0.5	4	6	6	12	50
2040-050-R05N16	0.5	4	6	6	16	50
2040-060-R05N20	0.5	4	6	6	20	60

F Technical information for Super Endmill for HRSA

Endmill for Ni series HRSA machining (Inconel, Hastelloy, Waspaloy and etc.)

Super Endmill for HRSA new

- Exclusive endmill for plane engines, generator and turbine parts.
- Optimal endmill for Ni Based super alloy HRSA machining (Inconel, Hastelloy, Waspaloy and etc.)

* HRSA: Heat Resistance Super Alloy. Heating resisting alloy

Code system

S	RE	S	4	120	- 080	- R30
Super Endmill	Type	Workpiece	No. of flutes	Tool diameter	Overall length	Corner R
	R: Radius Endmill	S: Super alloy T: Titanium/STS	4: 4 Flute	120: Ø12.0 mm	080: 80 mm	30: 30 mm

Features

- Aerospace and generator industries: Exclusive endmill for HRSA and machining parts of engine and turbine
- Irregular flute spacing and helix angle: Reducing chattering and improving stability in machining
- High rigidity core web design: Improving chip evacuation and stability in machining
- Sharp cutting edge: Reducing cutting load and work hardening
- Excellent tool life: New grade with excellent wear resistance coating and high toughness substrate

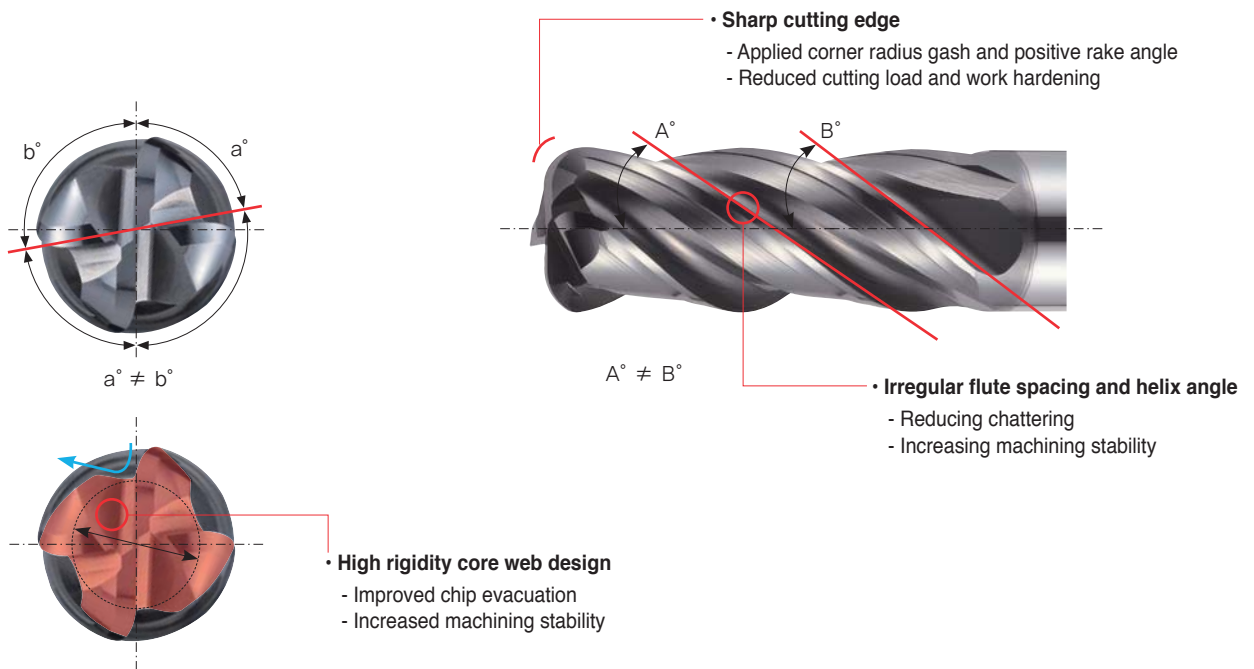

Features of grade

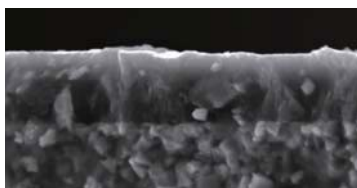

Super Lubricating Coating

- **High lubricative coating and special surface treatment technology**
 - Surface treatment technology improves welding resistance and machining stability



Performance evaluation

- **Workpiece** Inconel718 (HRC43~46)
- **Cutting conditions** Diameter = $\varnothing 12$, vc (m/min) = 40, fz (mm/t) = 0.05, ap (mm) = 18, ae (mm) = 0.6, wet (Emulsion)
- **Tools** SRES4120-080-R10(SL Coating)

High quality due to high toughness substrate and improved machining stability



- **Workpiece** Inconel718 (HRC43~46)
- **Cutting conditions** Diameter = $\varnothing 12$, vc (m/min) = 40, fz (mm/t) = 0.05, ap (mm) = 18, ae (mm) = 0.6, wet (Soluble)
- **Tools** SRES4120-080-R10(SL Coating)

High quality due to high toughness substrate and improved machining stability

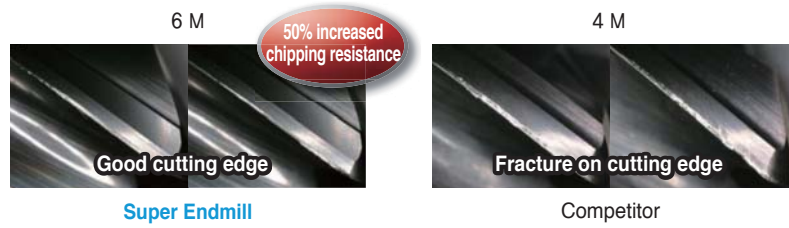

- **Workpiece** Waspaloy (HRC36~38)
- **Cutting conditions** Diameter = $\varnothing 12$, vc (m/min) = 30, fz (mm/t) = 0.04, ap (mm) = 6, ae (mm) = 18, Trochoidal machining wet (Soluble)
- **Tools** SRES4120-080-R10(SL Coating)

High quality due to high toughness substrate and improved machining stability



Recommended cutting conditions

Workpiece Condition Diameter (\varnothing)	Ni based heat resistant super alloy (Inconel718, 625)			
	RPM n (min ⁻¹)	Feed vf (mm/min)	RPM n (min ⁻¹)	Feed vf (mm/min)
3	3,800	220	2,500	125
4	3,000	240	1,900	135
5	2,450	245	1,500	145
6	2,100	250	1,250	145
8	1,600	225	945	155
10	1,250	215	760	145
12	1,050	210	630	145
16	765	210	475	110
20	635	200	380	110

Application tip

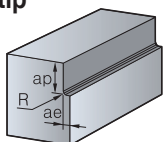

Shouldering depth (ap)

- ap : $\leq 1.5D$
- ae : $\leq 0.05D$

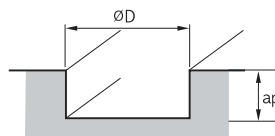

Slotting depth (ap)

- ap : $\leq 0.2D$

Notice

- Please adjust the recommended cutting conditions properly, according to the condition of your machines, the target shapes, and your purpose for machining
- Please set the machine with high rigidity and check the workpiece clamping
- Please select proper coolant for workpiece materials and check the pressure and amount of coolant enough for machining
- In case of chattering, reduce RPM and feed rate by the same ratio

SRES4000 (Radius)

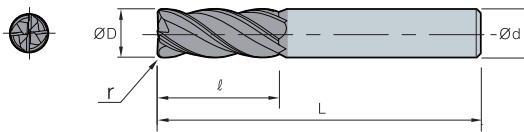

ØD	Tolerance	R Tolerance
Ø1~Ø6	0.00 ~ -0.015	±0.01
Ø6.1~Ø20	0.00 ~ -0.020	±0.01



(mm)

	Designation	ØD	Ød	ℓ	L	r
SRES 4	4030-055-R02	3	6	8	55	0.2
	4030-055-R03	3	6	8	55	0.3
	4030-055-R05	3	6	8	55	0.5
	4040-055-R02	4	6	10	55	0.2
	4040-055-R03	4	6	10	55	0.3
	4040-055-R05	4	6	10	55	0.5
	4040-070-R02	4	6	10	70	0.2
	4040-070-R03	4	6	10	70	0.3
	4040-070-R05	4	6	10	70	0.5
	4050-055-R02	5	6	15	55	0.2
	4050-055-R03	5	6	15	55	0.3
	4050-055-R05	5	6	15	55	0.5
	4050-090-R02	5	6	15	90	0.2
	4050-090-R03	5	6	15	90	0.3
	4050-090-R05	5	6	15	90	0.5
	4060-060-R03	6	6	15	60	0.3
	4060-060-R05	6	6	15	60	0.5
	4060-060-R08	6	6	15	60	0.8
	4060-060-R10	6	6	15	60	1
	4060-060-R15	6	6	15	60	1.5
4060-060-R20	6	6	15	60	2	
4060-090-R03	6	6	15	90	0.3	
4060-090-R05	6	6	15	90	0.5	
4060-090-R08	6	6	15	90	0.8	
4060-090-R10	6	6	15	90	1	
4060-090-R15	6	6	15	90	1.5	
4060-090-R20	6	6	15	90	2	



SRES4000 (Radius)

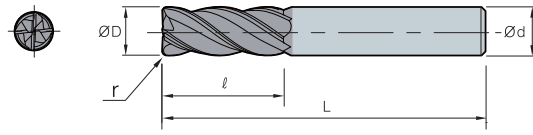

ØD	Tolerance	R Tolerance
Ø1~Ø6	0.00 ~ -0.015	±0.01
Ø6.1~Ø20	0.00 ~ -0.020	±0.01



(mm)

Designation	ØD	Ød	l	L	r
SRES					
4 4080-070-R03	8	8	20	70	0.3
4080-070-R05	8	8	20	70	0.5
4080-070-R08	8	8	20	70	0.8
4080-070-R10	8	8	20	70	1
4080-070-R15	8	8	20	70	1.5
4080-070-R20	8	8	20	70	2
4080-070-R25	8	8	20	70	2.5
4080-070-R30	8	8	20	70	3
4080-100-R03	8	8	20	100	0.3
4080-100-R05	8	8	20	100	0.5
4080-100-R08	8	8	20	100	0.8
4080-100-R10	8	8	20	100	1
4080-100-R15	8	8	20	100	1.5
4080-100-R20	8	8	20	100	2
4080-100-R25	8	8	20	100	2.5
4080-100-R30	8	8	20	100	3
4100-075-R03	10	10	25	75	0.3
4100-075-R05	10	10	25	75	0.5
4100-075-R08	10	10	25	75	0.8
4100-075-R10	10	10	25	75	1
4100-075-R15	10	10	25	75	1.5
4100-075-R20	10	10	25	75	2
4100-075-R25	10	10	25	75	2.5
4100-075-R30	10	10	25	75	3
4100-100-R03	10	10	25	100	0.3
4100-100-R05	10	10	25	100	0.5
4100-100-R08	10	10	25	100	0.8
4100-100-R10	10	10	25	100	1
4100-100-R15	10	10	25	100	1.5
4100-100-R20	10	10	25	100	2
4100-100-R25	10	10	25	100	2.5
4100-100-R30	10	10	25	100	3

SRES4000 (Radius)

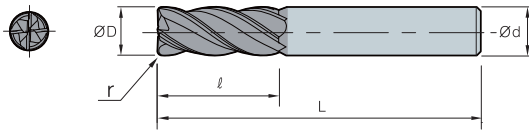

ØD	Tolerance	R Tolerance
Ø1~Ø6	0.00 ~ -0.015	±0.01
Ø6.1~Ø20	0.00 ~ -0.020	±0.01



(mm)

	Designation	ØD	Ød	ℓ	L	r
SRES 4	4120-080-R05	12	12	30	80	0.5
	4120-080-R08	12	12	30	80	0.8
	4120-080-R10	12	12	30	80	1
	4120-080-R15	12	12	30	80	1.5
	4120-080-R20	12	12	30	80	2
	4120-080-R25	12	12	30	80	2.5
	4120-080-R30	12	12	30	80	3
	4120-080-R35	12	12	30	80	3.5
	4120-080-R40	12	12	30	80	4
	4120-110-R05	12	12	30	110	0.5
	4120-110-R08	12	12	30	110	0.8
	4120-110-R10	12	12	30	110	1
	4120-110-R15	12	12	30	110	1.5
	4120-110-R20	12	12	30	110	2
	4120-110-R25	12	12	30	110	2.5
	4120-110-R30	12	12	30	110	3
	4120-110-R35	12	12	30	110	3.5
	4120-110-R40	12	12	30	110	4
	4140-090-R05	14	14	35	90	0.5
	4140-090-R08	14	14	35	90	0.8
	4140-090-R10	14	14	35	90	1
	4140-090-R15	14	14	35	90	1.5
	4140-090-R20	14	14	35	90	2
	4140-090-R30	14	14	35	90	3
	4140-150-R05	14	14	35	150	0.5
	4140-150-R08	14	14	35	150	0.8
	4140-150-R10	14	14	35	150	1
	4140-150-R15	14	14	35	150	1.5
	4140-150-R20	14	14	35	150	2
	4140-150-R30	14	14	35	150	3



SRES4000 (Radius)

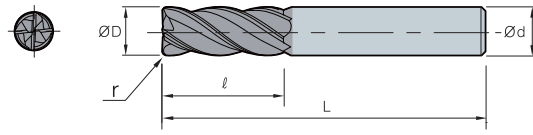

ØD	Tolerance	R Tolerance
Ø1~Ø6	0.00 ~ -0.015	±0.01
Ø6.1~Ø20	0.00 ~ -0.020	±0.01



(mm)

Designation	ØD	Ød	l	L	r
SRES					
4					
4160-100-R05	16	16	42	100	0.5
4160-100-R08	16	16	42	100	0.8
4160-100-R10	16	16	42	100	1
4160-100-R15	16	16	42	100	1.5
4160-100-R20	16	16	42	100	2
4160-100-R25	16	16	42	100	2.5
4160-100-R30	16	16	42	100	3
4160-100-R35	16	16	42	100	3.5
4160-100-R40	16	16	42	100	4
4160-100-R50	16	16	42	100	5
4160-100-R60	16	16	42	100	6
4160-150-R05	16	16	42	150	0.5
4160-150-R08	16	16	42	150	0.8
4160-150-R10	16	16	42	150	1
4160-150-R15	16	16	42	150	1.5
4160-150-R20	16	16	42	150	2
4160-150-R25	16	16	42	150	2.5
4160-150-R30	16	16	42	150	3
4160-150-R35	16	16	42	150	3.5
4160-150-R40	16	16	42	150	4
4160-150-R50	16	16	42	150	5
4160-150-R60	16	16	42	150	6
4180-100-R05	18	20	45	100	0.5
4180-100-R08	18	20	45	100	0.8
4180-100-R10	18	20	45	100	1
4180-100-R15	18	20	45	100	1.5
4180-100-R20	18	20	45	100	2
4180-100-R30	18	20	45	100	3
4180-150-R05	18	20	45	150	0.5
4180-150-R08	18	20	45	150	0.8
4180-150-R10	18	20	45	150	1
4180-150-R15	18	20	45	150	1.5
4180-150-R20	18	20	45	150	2
4180-150-R30	18	20	45	150	3

SRES4000 (Radius)

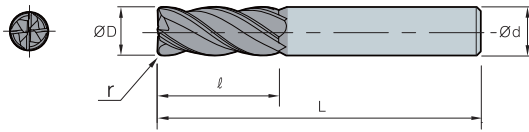

ØD	Tolerance	R Tolerance
Ø1~Ø6	0.00 ~ -0.015	±0.01
Ø6.1~Ø20	0.00 ~ -0.020	±0.01



(mm)

	Designation	ØD	Ød	ℓ	L	r
SRES 4	4200-100-R05	20	20	48	100	0.5
	4200-100-R10	20	20	48	100	1
	4200-100-R15	20	20	48	100	1.5
	4200-100-R20	20	20	48	100	2
	4200-100-R25	20	20	48	100	2.5
	4200-100-R30	20	20	48	100	3
	4200-100-R35	20	20	48	100	3.5
	4200-100-R40	20	20	48	100	4
	4200-100-R50	20	20	48	100	5
	4200-100-R60	20	20	48	100	6
	4200-150-R05	20	20	48	150	0.5
	4200-150-R10	20	20	48	150	1
	4200-150-R15	20	20	48	150	1.5
	4200-150-R20	20	20	48	150	2
	4200-150-R25	20	20	48	150	2.5
	4200-150-R30	20	20	48	150	3
	4200-150-R35	20	20	48	150	3.5
	4200-150-R40	20	20	48	150	4
	4200-150-R50	20	20	48	150	5
	4200-150-R60	20	20	48	150	6



Router endmill for machining composite materials

Composite Router Endmill **new**

- Router endmills optimized for machining composite materials (CFRP/GFRP)
- Excellent tool life thanks to nano-crystal diamond coating
- Blade design for reducing flaking and burrs
- Improved productivity through high efficiency machining

Features

- Diamond-coated grade ND2100 for machining composite materials
- High hardness diamond coating (over Hv 8,000)
- Nano-diamond coating with excellent resistance to friction and welding
- Improved resistance to flaking thanks by applying the specialized grade for diamond coating

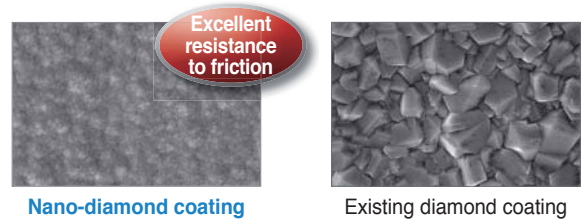

Nano-diamond coating

Existing diamond coating

CCDR (Dual Helix Router Endmill)

- Dual helix design to inhibit flaking on upper and lower faces of workpieces
- Endmill for finishing, profiling, and grooving



CCHR (High-performance Router Endmill)

- Multi flute nick shaped for high efficient machining
- Endmill for shape contouring, grooving, roughing



CCR (Router Endmill)

- Down cut design for low vibrations and cutting force
- Endmill for roughing, profiling, and grooving



CCLR (Low Helix Router Endmill)

- Fewer burrs thanks to the low axial cutting force
- Endmill for finishing, profiling, and blind groove making



CCRR (Reverse Helix Router Endmill)

- Reverse helix design to inhibit a drift in the workpiece's course
- Endmill for finishing, profiling, and through groove making



CCDR4000/6000 (Flat)

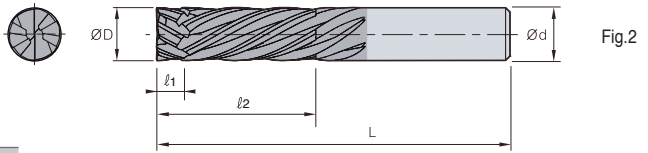
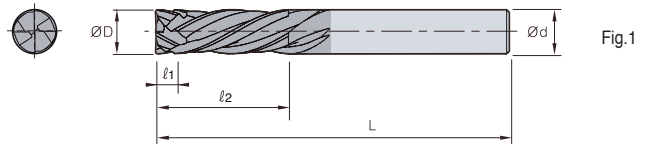
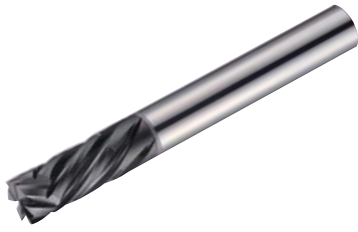

ØD	Tolerance
Ø6~12	0.00~-0.03 mm

(mm)

Designation		ØD	Ød	ℓ ₁	ℓ ₂	L	Fig.
CCDR 4	4060-065	6	6	3	18	65	1
	4080-075	8	8	4	24	75	1
CCDR 6	6100-085	10	10	5	30	85	2
	6120-100	12	12	6	36	100	2



ØD	Tolerance
Ø0.250~0.500	0.0000~-0.0012 inch

(inch)

Designation		ØD	Ød	ℓ ₁	ℓ ₂	L	Fig.
CCDR 4	402500	1/4 0.250	0.250	0.125	0.750	2.500	1
	402500L	1/4 0.250	0.250	0.125	1.500	4.000	1
CCDR 6	603750	3/8 0.375	0.375	0.125	1.000	3.250	2
	603750L	3/8 0.375	0.375	0.125	1.500	4.000	2
	605000	1/2 0.500	0.500	0.125	1.000	3.250	2
	605000L	1/2 0.500	0.500	0.125	1.500	4.000	2



CCHR4000/6000 (Flat)

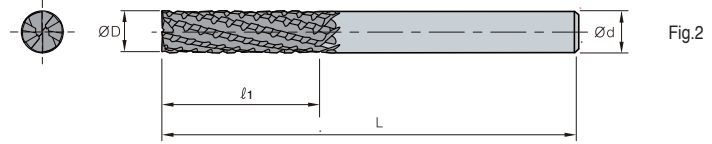
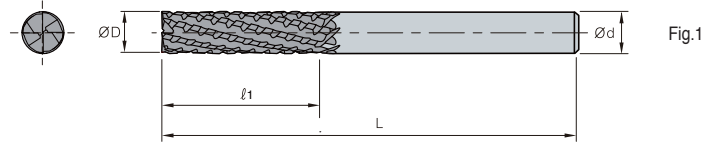

ØD	Tolerance
Ø6~12	0.00 ~ -0.05 mm

(mm)

Designation		ØD	Ød	ℓ ₁	L	Fig.
CCHR 4	4060-065	6	6	18	65	1
	4080-075	8	8	24	75	1
CCHR 6	6100-085	10	10	30	85	2
	6120-100	12	12	36	100	2



ØD	Tolerance
Ø0.250~0.500	0.0000 ~ -0.002 inch

(inch)

Designation		ØD	Ød	ℓ ₁	L	Fig.
CCHR 4	402500	1/4 0.250	0.250	0.750	2.500	1
	402500L	1/4 0.250	0.250	1.500	4.000	1
CCHR 6	603750	3/8 0.375	0.375	1.000	3.250	2
	603750L	3/8 0.375	0.375	1.500	4.000	2
	605000	1/2 0.500	0.500	1.000	3.250	2
	605000L	1/2 0.500	0.500	1.500	4.000	2

CCR2000 (Flat)

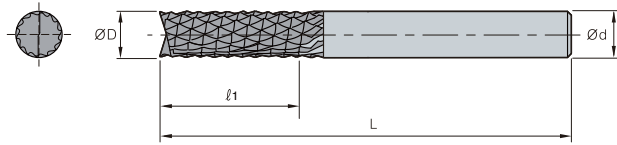

ØD	Tolerance
Ø4~12	-0.02 ~ -0.08 mm

(mm)

Designation		ØD	Ød	ℓ ₁	L
CCR	2040-050	4	4	12	50
	2050-050	5	5	15	50
	2060-065	6	6	18	65
	2080-075	8	8	24	75
	2100-085	10	10	30	85
	2120-100	12	12	36	100



ØD	Tolerance
Ø0.250~0.500	-0.0008 ~ -0.0032 inch

(inch)

Designation		ØD	Ød	ℓ ₁	L
CCR	202500	1/4 0.250	0.250	0.750	2.500
	202500L	1/4 0.250	0.250	1.500	4.000
	203750	3/8 0.375	0.375	1.000	3.250
	203750L	3/8 0.375	0.375	1.500	4.000
	205000	1/2 0.500	0.500	1.000	3.250
	205000L	1/2 0.500	0.500	1.500	4.000



CCLR4000 (Flat)

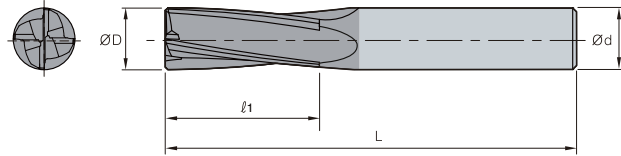

ØD	Tolerance
Ø4~12	0.00 ~ -0.03 mm

(mm)

Designation	ØD	Ød	l ₁	L	
CCLR 4	4040-050	4	4	12	50
	4050-050	5	5	15	50
	4060-065	6	6	18	65
	4080-075	8	8	24	75
	4100-085	10	10	30	85
	4120-100	12	12	36	100



ØD	Tolerance
Ø0.250~0.500	0.0000 ~ -0.0012 inch

(inch)

Designation	ØD	Ød	l ₁	L	
CCLR 4	402500	1/4 0.250	0.250	0.750	2.500
	402500L	1/4 0.250	0.250	1.500	4.000
	403750	3/8 0.375	0.375	1.000	3.250
	403750L	3/8 0.375	0.375	1.500	4.000
	405000	1/2 0.500	0.500	1.000	3.250
	405000L	1/2 0.500	0.500	1.500	4.000

CCRR6000/8000 (Flat)

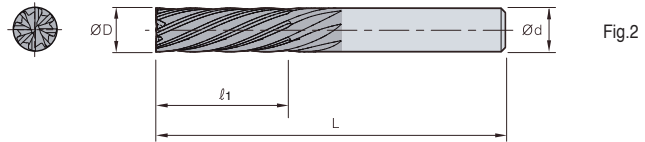
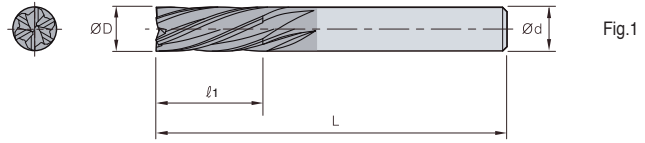

ØD	Tolerance
Ø6~12	0.00 ~ -0.03 mm

(mm)

Designation		ØD	Ød	ℓ1	L	Fig.
CCRR	6060-065	6	6	18	65	1
	6080-075	8	8	24	75	1
CCRR	8100-085	10	10	30	85	2
	8120-100	12	12	36	100	2



ØD	Tolerance
Ø0.250~0.500	0.0000 ~ -0.0012 inch

(inch)

Designation		ØD	Ød	ℓ1	L	Fig.
CCRR	602500	1/4 0.250	0.250	0.750	2.500	1
	602500L	1/4 0.250	0.250	1.500	4.000	1
CCRR	803750	3/8 0.375	0.375	1.000	3.250	2
	803750L	3/8 0.375	0.375	1.500	4.000	2
	805000	1/2 0.500	0.500	1.000	3.250	2
	805000L	1/2 0.500	0.500	1.500	4.000	2



Stable performance guaranteed for workpiece workpieces under Hrc45

I⁺ Endmill

- Tough substrate & wear-resisting coating technology applied
- Wide application range in general use
 - Stable performance guaranteed for workpiece which is under 45HRC
- Saving cost by higher productivity

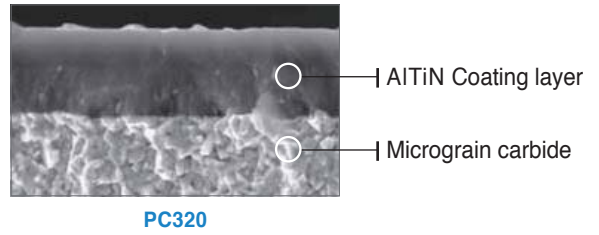

Product line-up

- IPBE: I Plus Ball Endmill (Ø1~Ø20)
- IPFE: I Plus Flat Endmill (Ø1~Ø20)
- IPRE: I Plus Radius Endmill (Ø1~Ø12)

Application area

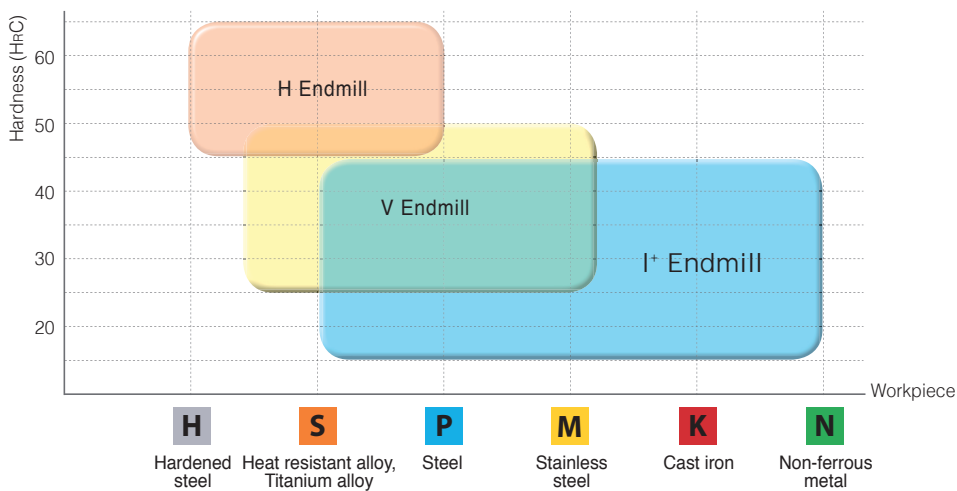

Performance evaluation

- Workpiece SM45C
- Cutting conditions Diameter = Ø8.0, n (min⁻¹) = 5173, vc (m/min) = 130.0, vf (mm/min) = 1034, fz (mm/t) = 0.1, ap (mm) = 0.5, ae (mm) = 1.6, dry
- Tools IPBE2080-060

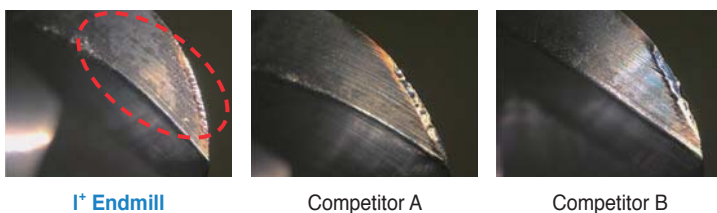

Test result

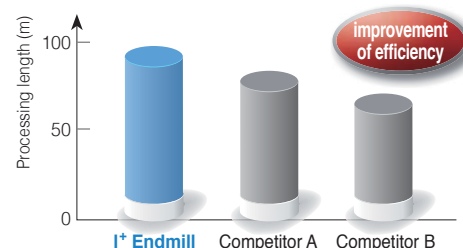

Recommended cutting conditions (Flat)

IPFE2000

Diameter (ØD)	Carbon steel, Alloy steel~HrC30 (SM50C, SCM, GC250, Cast iron)			Alloy steel, High speed steel HrC30~45 (Pre-hardened steels, STD61, NAK)			Stainless steel (STS304, STS316)		
	R.P.M n (min ⁻¹)	Feed vf (mm/min)		R.P.M n (min ⁻¹)	Feed vf (mm/min)		R.P.M n (min ⁻¹)	Feed vf (mm/min)	
		Shouldering	Slotting		Shouldering	Slotting		Shouldering	Slotting
1.0	30,000	600	480	20,000	400	320	12,600	300	180
1.5	20,000	600	480	14,000	400	320	8,400	300	180
2.0	15,000	600	480	10,000	400	400	6,300	300	180
2.5	12,000	600	480	8,200	400	320	5,100	300	180
3.0	10,000	600	480	7,000	400	320	4,200	300	180
4.0	7,500	600	480	5,200	400	320	3,100	300	180
5.0	6,000	600	480	4,200	400	320	2,500	300	180
6.0	5,000	600	480	3,500	400	320	2,100	300	180
8.0	4,000	520	410	2,800	350	280	1,600	260	150
10.0	3,200	450	360	2,200	300	240	1,300	230	130
12.0	2,700	410	320	1,900	270	210	1,100	210	120
16.0	2,000	240	190	1,400	210	160	840	160	100
20.0	1,600	200	160	1,100	170	130	680	140	80

Application tip

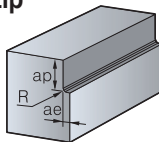

- Shouldering depth (ap) and radial depth (ae)
 - ap: ≤ 1.5 (All dia.)
 - ae: ≤ 0.1D (D ≤ Ø3) ≤ 0.2D (D > Ø3)

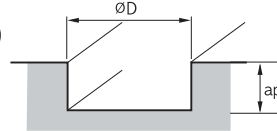

- Slotting depth (ap)
 - ap: ≤ 0.1D (D ≤ Ø2) ≤ 0.2D (D > Ø2)

IPFE4000

Diameter (ØD)	Carbon steel, Alloy steel ~HrC30 (SM50C, SCM, GC250, Cast iron)			Alloy steel, High speed steel HrC30~45 (Pre-hardened steels, STD61, NAK)			Stainless steel (STS304, STS316)		
	R.P.M n (min ⁻¹)	Feed vf (mm/min)		R.P.M n (min ⁻¹)	Feed vf (mm/min)		R.P.M n (min ⁻¹)	Feed vf (mm/min)	
		Shouldering	Slotting		Shouldering	Slotting		Shouldering	Slotting
1.0	30,000	900	720	20,000	600	480	12,600	450	270
1.5	20,000	900	720	14,000	600	480	8,400	450	270
2.0	15,000	900	720	10,000	600	480	6,300	450	270
2.5	12,000	900	720	8,200	600	480	5,100	450	270
3.0	10,000	900	720	7,000	600	480	4,200	450	270
4.0	7,500	900	720	5,200	600	480	3,100	450	270
5.0	6,000	900	720	4,200	600	480	2,500	450	270
6.0	5,000	900	720	3,500	600	480	2,100	450	270
8.0	4,000	780	620	2,800	520	410	1,600	390	230
10.0	3,200	680	540	2,200	450	360	1,300	340	200
12.0	2,700	620	490	1,900	410	320	1,100	310	180
16.0	2,000	360	280	1,400	310	240	840	240	140
20.0	1,600	300	240	1,100	250	200	680	210	120

Application tip

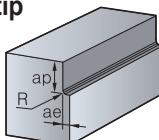

- Shouldering depth (ap) and radial depth (ae)
 - ap: ≤ 1.5 (All dia.)
 - ae: ≤ 0.1D (D ≤ Ø3) ≤ 0.2D (D > Ø3)

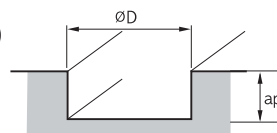

- Slotting depth (ap)
 - ap: ≤ 0.1D (D ≤ Ø2) ≤ 0.2D (D > Ø2)

Recommended cutting conditions (Ball)

■ IPBE2000

Diameter (ØD)	Carbon steel (SM50C)		Alloy steel (SCM, STD, STS, KP4M, NAK)		Mold steel ~HRC45 (STD61)		Non-ferrous metal (Aluminum)	
	R.P.M n (min ⁻¹)	Feed vf (mm/min)	R.P.M n (min ⁻¹)	Feed vf (mm/min)	R.P.M n (min ⁻¹)	Feed vf (mm/min)	R.P.M n (min ⁻¹)	Feed vf (mm/min)
1.0	40,000	1,200	38,000	1,200	29,000	900	40,000	1,000
1.5	30,000	1,270	25,500	1,100	19,000	700	40,000	1,360
2.0	24,000	1,160	19,000	800	14,300	600	40,000	2,000
2.5	19,000	1,000	15,300	670	11,500	510	38,000	2,400
3.0	16,000	930	13,000	600	9,600	460	32,000	2,400
3.5	13,700	930	11,400	580	8,200	450	27,300	2,400
4.0	12,000	930	10,000	570	7,200	450	24,000	2,400
5.0	9,600	930	8,000	560	5,700	450	19,000	2,400
6.0	8,000	930	6,400	540	4,800	450	16,000	2,400
8.0	6,000	900	4,800	540	3,600	450	12,000	2,400
10.0	4,800	900	3,800	540	2,900	450	9,600	2,300
12.0	4,000	900	3,200	540	2,400	450	8,000	2,100
14.0	3,400	900	2,750	540	2,050	450	6,800	2,000
16.0	3,000	900	2,400	540	1,800	450	6,000	2,000
20.0	2,400	900	1,900	520	1,450	450	4,800	2,000

Application tip

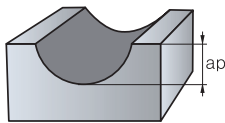

■ Slotting depth (ap)

- ap: 0.1×R (~45HRC)
- 0.08×R (~50HRC)

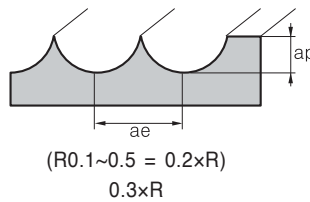

■ Shouldering depth (ap) and radial depth (ae)

- ~0.16×R R ≤ 0.3 (~45HRC)
- ~0.25×R R ≤ 3 (~45HRC)
- ~0.17×R R ≤ 4 (~45HRC)
- ~0.05×R (~50HRC)

Recommended cutting conditions (Radius)

■ IPRE2000

Diameter (ØD)	Carbon steel, Alloy steel ~HRC30 (SM50C, SCM, GC250, Cast iron)			Alloy steel, High speed steel HRC30~45 (Pre-hardened steels, STD61, NAK)			Stainless steel (STS304, STS316)		
	R.P.M n (min ⁻¹)	Feed vf (mm/min)		R.P.M n (min ⁻¹)	Feed vf (mm/min)		R.P.M n (min ⁻¹)	Feed vf (mm/min)	
		Shouldering	Slotting		Shouldering	Slotting		Shouldering	Slotting
2.0	11,000	180	180	7,200	110	110	6,000	90	90
3.0	8,500	200	160	5,300	130	100	4,400	110	66
4.0	7,200	360	290	4,400	220	180	3,000	180	110
5.0	6,000	380	300	3,600	230	180	2,400	190	110
6.0	5,300	420	340	3,200	240	190	2,200	210	130
8.0	4,000	450	360	2,400	240	190	1,600	220	130
10.0	3,200	390	310	1,900	190	150	1,300	190	110
12.0	2,700	330	260	1,600	160	130	1,000	150	90

Application tip

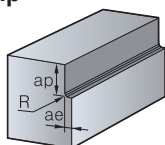

■ Shouldering depth (ap) and radial depth (ae)

- ap: ≤ 1.5D
- ap: ≤ 0.1D

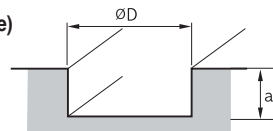

■ Slotting depth (ap)

- ap: ≤ 0.3D

IPFE2000 (Flat)

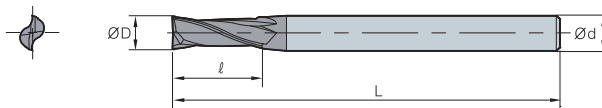

ØD	Tolerance
Ø1~Ø12	0.00~ -0.02
Ø12.1~Ø20	0.00~ -0.03



(mm)

Designation	ØD	Ød	ℓ	L
IPFE				
2010-050-S3	1	3	3	50
2010-050-S4	1	4	3	50
2010-050	1	6	3	50
2015-050-S3	1.5	3	4	50
2015-050-S4	1.5	4	4	50
2015-050	1.5	6	4	50
2020-050-S3	2	3	6	50
2020-050-S4	2	4	6	50
2020-050	2	6	6	50
2025-050-S3	2.5	3	8	50
2025-050-S4	2.5	4	8	50
2025-050	2.5	6	8	50
2030-050-S3	3	3	8	50
2030-050-S4	3	4	8	50
2030-050	3	6	8	50
2035-050-S4	3.5	4	10	50
2035-050	3.5	6	10	50
2040-050-S4	4	4	11	50
2040-050	4	6	11	50
2045-050	4.5	6	13	50
2050-050	5	6	13	50
2055-050	5.5	6	13	50
2060-050	6	6	16	50
2065-060	6.5	8	16	60
2070-060	7	8	16	60
2075-060	7.5	8	19	60
2080-060	8	8	20	60
2085-075	8.5	10	20	75
2090-075	9	10	20	75
2095-075	9.5	10	25	75
2100-075	10	10	25	75
2105-075	10.5	12	25	75
2110-075	11	12	30	75
2115-075	11.5	12	30	75
2120-075	12	12	32	75
2140-100	14	16	40	100
2160-100	16	16	40	100
2180-100	18	20	45	100
2200-100	20	20	45	100

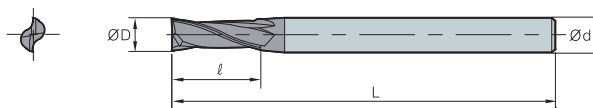

IPLFE2000 (Long flat)

ØD	Tolerance
Ø1~Ø12	0.00~-0.02
Ø12.1~Ø20	0.00~-0.03

**Long shank type**

(mm)

Designation	ØD	Ød	ℓ	L
IPLFE 2	2060-075	6	16	75
	2060-100	6	16	100
	2080-075	8	20	75
	2080-100	8	20	100
	2100-100	10	25	100
	2100-150	10	25	150
	2120-100	12	32	100
	2120-150	12	32	150

Long flute type

(mm)

Designation	ØD	Ød	ℓ	L
IPLFE 2	2010-050-V7S4	1	7	50
	2015-050-V9S4	1.5	9	50
	2020-050-V12S4	2	12	50
	2025-050-V12S4	2.5	12	50
	2030-060-V15S6	3	15	60
	2035-060-V15S6	3.5	15	60
	2040-075-V20S6	4	20	75
	2045-075-V20S6	4.5	20	75
	2050-075-V25S6	5	25	75
	2055-075-V25S6	5.5	25	75
	2060-075-V30S6	6	30	75
	2070-100-V30S8	7	30	100
	2080-100-V40S8	8	40	100
	2090-100-V40S10	9	40	100
	2100-100-V40S10	10	40	100
	2110-100-V40S12	11	40	100
	2120-100-V50S12	12	50	100
	2140-150-V50S16	14	50	150
	2160-150-V60S16	16	60	150
	2200-200-V90S20	20	90	200

IPFE4000 (Flat)

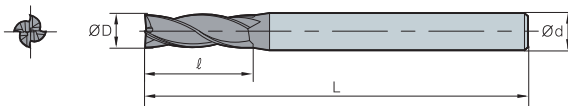

ØD	Tolerance
Ø1~Ø12	0.00~ -0.02
Ø12.1~Ø20	0.00~ -0.03



(mm)

Designation	ØD	Ød	ℓ	L
IPFE				
4010-050-S3	1	3	3	50
4010-050-S4	1	4	3	50
4010-050	1	6	3	50
4015-050-S3	1.5	3	4	50
4015-050-S4	1.5	4	4	50
4015-050	1.5	6	4	50
4020-050-S3	2	3	6	50
4020-050-S4	2	4	6	50
4020-050	2	6	6	50
4025-050-S3	2.5	3	8	50
4025-050-S4	2.5	4	8	50
4025-050	2.5	6	8	50
4030-050-S3	3	3	8	50
4030-050-S4	3	4	8	50
4030-050	3	6	8	50
4035-050-S4	3.5	4	10	50
4035-050	3.5	6	10	50
4040-050-S4	4	4	11	50
4040-050	4	6	11	50
4045-050	4.5	6	13	50
4050-050	5	6	13	50
4055-050	5.5	6	13	50
4060-050	6	6	16	50
4065-060	6.5	8	16	60
4070-060	7	8	16	60
4075-060	7.5	8	19	60
4080-060	8	8	20	60
4085-075	8.5	10	20	75
4090-075	9	10	20	75
4095-075	9.5	10	25	75
4100-075	10	10	30	75
4105-075	10.5	12	30	75
4110-075	11	12	30	75
4115-075	11.5	12	30	75
4120-075	12	12	32	75
4140-100	14	16	40	100
4160-100	16	16	40	100
4180-100	18	20	45	100
4200-100	20	20	45	100

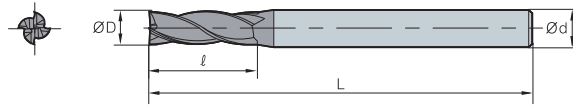

IPLFE4000 (Long flat)

ØD	Tolerance
Ø1~Ø12	0.00~-0.02
Ø12.1~Ø20	0.00~-0.03

**Long shank type**

(mm)

Designation	ØD	Ød	ℓ	L
IPLFE 4	4060-075	6	16	75
	4060-100	6	16	100
	4080-075	8	20	75
	4080-100	8	20	100
	4100-100	10	30	100
	4100-150	10	30	150
	4120-100	12	32	100
	4120-150	12	32	150

Long flute type

(mm)

Designation	ØD	Ød	ℓ	L
IPLFE 4	4010-050-V6S4	1	6	50
	4015-050-V9S4	1.5	9	50
	4020-050-V12S4	2	12	50
	4025-050-V12S4	2.5	12	50
	4030-060-V15S6	3	15	60
	4035-060-V15S6	3.5	15	60
	4040-075-V20S6	4	20	75
	4045-075-V20S6	4.5	20	75
	4050-075-V25S6	5	25	75
	4055-075-V25S6	5.5	25	75
	4060-075-V30S6	6	30	75
	4070-100-V30S8	7	30	100
	4080-100-V40S8	8	40	100
	4090-100-V40S10	9	40	100
	4100-100-V40S10	10	40	100
	4110-100-V40S12	11	40	100
	4120-100-V50S12	12	50	100
	4140-150-V50S16	14	50	150
	4160-150-V60S16	16	60	150
	4200-200-V90S20	20	90	200

IPBE2000 (Ball)

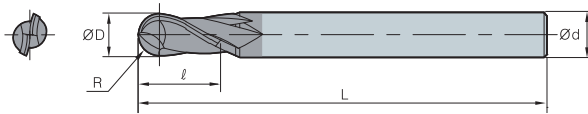

ØD	Tolerance
Ø1~Ø12	0.00~ -0.02
Ø12.1~Ø20	0.00~ -0.03



(mm)

Designation	R	ØD	Ød	ℓ	L	
IPBE	2010-050-S3	0.5	1	3	2	50
	2010-050-S4	0.5	1	4	2	50
	2010-050	0.5	1	6	2	50
	2015-050-S3	0.75	1.5	3	3	50
	2015-050-S4	0.75	1.5	4	3	50
	2015-050	0.75	1.5	6	3	50
	2020-050-S3	1	2	3	4	50
	2020-050-S4	1	2	4	4	50
	2020-050	1	2	6	4	50
	2025-050-S3	1.25	2.5	3	5	50
	2025-050-S4	1.25	2.5	4	5	50
	2025-050	1.25	2.5	6	5	50
	2030-050-S3	1.5	3	3	6	50
	2030-050-S4	1.5	3	4	6	50
	2030-050	1.5	3	6	6	50
	2035-050-S4	1.75	3.5	4	7	50
	2035-050	1.75	3.5	6	7	50
	2040-050-S4	2	4	4	8	50
	2040-050	2	4	6	8	50
	2045-050	2.25	4.5	6	9	50
2050-050	2.5	5	6	10	50	
2060-050	3	6	6	12	50	
2070-060	3.5	7	8	14	60	
2080-060	4	8	8	16	60	
2090-075	4.5	9	10	18	75	
2100-075	5	10	10	20	75	
2120-075	6	12	12	24	75	
2140-100	7	14	16	28	100	
2160-100	8	16	16	32	100	
2180-100	9	18	20	36	100	
2200-100	10	20	20	40	100	



IPLBE2000 (Long ball)

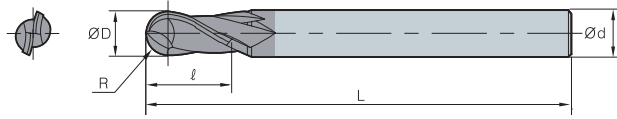
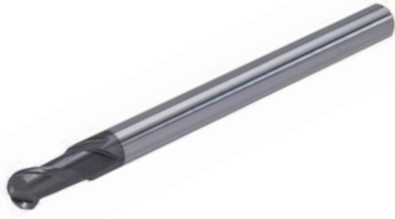

ØD	Tolerance
Ø1~Ø12	0.00~-0.02
Ø12.1~Ø16	0.00~-0.03



(mm)

Designation	R	ØD	Ød	ℓ	L	
IPLBE 2	2010-075	0.5	1	6	2	75
	2010-100	0.5	1	6	2	100
	2015-075	0.75	1.5	6	3	75
	2015-100	0.75	1.5	6	3	100
	2020-075	1	2	6	4	75
	2020-100	1	2	6	4	100
	2025-075	1.25	2.5	6	5	75
	2025-100	1.25	2.5	6	5	100
	2030-075	1.5	3	6	6	75
	2030-100	1.5	3	6	6	100
	2035-100	1.75	3.5	6	7	100
	2040-075	2	4	6	8	75
	2040-100	2	4	6	8	100
	2050-075	2.5	5	6	10	75
	2050-100	2.5	5	6	10	100
	2060-075	3	6	6	12	75
	2060-100	3	6	6	12	100
	2060-150	3	6	6	12	150
	2080-075	4	8	8	16	75
	2080-100	4	8	8	16	100
	2080-150	4	8	8	16	150
	2100-100	5	10	10	20	100
	2100-150	5	10	10	20	150
	2100-200	5	10	10	20	200
	2120-100	6	12	12	24	100
	2120-150	6	12	12	24	150
	2120-200	6	12	12	24	200
	2160-150	8	16	16	32	150
	2160-200	8	16	16	32	200

IPBE4000 (Ball)

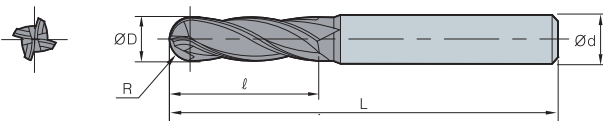

ØD	Tolerance
Ø1~Ø12	0.00~-0.02
Ø12.1~Ø20	0.00~-0.03



(mm)

Designation	R	ØD	Ød	ℓ	L
IPBE					
4010-050-S4	0.5	1	4	2	50
4010-050	0.5	1	6	2	50
4015-050-S4	0.75	1.5	4	3	50
4015-050	0.75	1.5	6	3	50
4020-050-S4	1	2	4	4	50
4020-050	1	2	6	4	50
4025-050-S4	1.25	2.5	4	5	50
4025-050	1.25	2.5	6	5	50
4030-050-S3	1.5	3	3	6	50
4030-050-S4	1.5	3	4	6	50
4030-050	1.5	3	6	6	50
4035-050-S4	1.75	3.5	4	7	50
4035-050	1.75	3.5	6	7	50
4040-050-S4	2	4	4	8	50
4040-050	2	4	6	8	50
4045-050	2.25	4.5	6	9	50
4050-050	2.5	5	6	10	50
4060-050	3	6	6	12	50
4070-060	3.5	7	8	14	60
4080-060	4	8	8	16	60
4090-075	4.5	9	10	18	75
4100-075	5	10	10	20	75
4120-075	6	12	12	24	75
4140-100	7	14	16	28	100
4160-100	8	16	16	32	100
4180-100	9	18	20	36	100
4200-100	10	20	20	40	100



IPRE2000 (Radius)

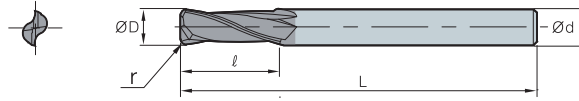

ØD	Tolerance
Ø1~Ø12	0.00~-0.02



(mm)

Designation	ØD	Ød	ℓ	L	r	
IPRE 2	2010-050-R01	1	4	3	50	0.1
	2010-050-R02	1	4	3	50	0.2
	2010-050-R03	1	4	3	50	0.3
	2015-050-R02	1.5	4	4	50	0.2
	2015-050-R03	1.5	4	4	50	0.3
	2020-050-R02	2	4	6	50	0.2
	2020-050-R03	2	4	6	50	0.3
	2020-050-R05	2	4	6	50	0.5
	2025-050-R02	2.5	4	8	50	0.2
	2030-050-R02-S3	3	3	8	50	0.2
	2030-050-R03-S3	3	3	8	50	0.3
	2030-050-R05-S3	3	3	8	50	0.5
	2030-050-R10-S3	3	3	8	50	1
	2030-050-R02	3	4	8	50	0.2
	2030-050-R03	3	4	8	50	0.3
	2030-050-R05	3	4	8	50	0.5
	2030-050-R10	3	4	8	50	1
	2040-050-R02	4	4	10	50	0.2
	2040-050-R03	4	4	10	50	0.3
	2040-050-R05	4	4	10	50	0.5
	2040-050-R10	4	4	10	50	1
	2040-050-R15	4	4	10	50	1.5
	2050-050-R02	5	6	13	50	0.2
	2050-050-R03	5	6	13	50	0.3
	2050-050-R05	5	6	13	50	0.5
	2050-050-R10	5	6	13	50	1
	2060-050-R02	6	6	15	50	0.2
	2060-050-R03	6	6	15	50	0.3
	2060-050-R05	6	6	15	50	0.5
	2060-050-R10	6	6	15	50	1
	2060-050-R15	6	6	15	50	1.5
	2060-050-R20	6	6	15	50	2

IPRE2000 (Radius)

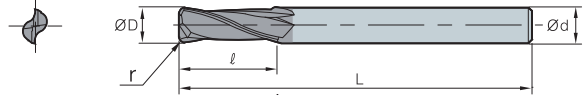

ØD	Tolerance
Ø1~Ø12	0.00~-0.02



(mm)

Designation		ØD	Ød	ℓ	L	r
IPRE	2080-060-R03	8	8	20	60	0.3
	2080-060-R05	8	8	20	60	0.5
	2080-060-R10	8	8	20	60	1
	2080-060-R15	8	8	20	60	1.5
	2080-060-R20	8	8	20	60	2
	2080-060-R25	8	8	20	60	2.5
	2080-060-R30	8	8	20	60	3
	2100-075-R03	10	10	25	75	0.3
	2100-075-R05	10	10	25	75	0.5
	2100-075-R10	10	10	25	75	1
	2100-075-R15	10	10	25	75	1.5
	2100-075-R20	10	10	25	75	2
	2100-075-R25	10	10	25	75	2.5
	2100-075-R30	10	10	25	75	3
	2120-075-R03	12	12	30	75	0.3
	2120-075-R05	12	12	30	75	0.5
	2120-075-R10	12	12	30	75	1
	2120-075-R15	12	12	30	75	1.5
	2120-075-R20	12	12	30	75	2
	2120-075-R25	12	12	30	75	2.5
2120-075-R30	12	12	30	75	3	



IPLRE2000 (Long radius)

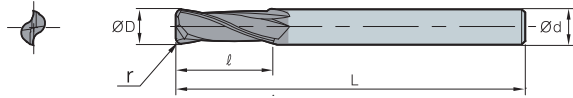

ØD	Tolerance
Ø3~Ø12	0.00~-0.02



(mm)

Designation	ØD	Ød	ℓ	L	r	
IPLRE 2	2030-075-R03	3	3	8	75	0.3
	2030-075-R05	3	3	8	75	0.5
	2030-075-R10	3	3	8	75	1
	2040-075-R03	4	4	10	75	0.3
	2040-075-R05	4	4	10	75	0.5
	2040-075-R10	4	4	10	75	1
	2040-075-R15	4	4	10	75	1.5
	2060-100-R03	6	6	15	100	0.3
	2060-100-R05	6	6	15	100	0.5
	2060-100-R10	6	6	15	100	1
	2060-100-R15	6	6	15	100	1.5
	2060-100-R20	6	6	15	100	2
	2080-100-R03	8	8	20	100	0.3
	2080-100-R05	8	8	20	100	0.5
	2080-100-R10	8	8	20	100	1
	2080-100-R15	8	8	20	100	1.5
	2080-100-R20	8	8	20	100	2
	2080-100-R25	8	8	20	100	2.5
	2080-100-R30	8	8	20	100	3
	2100-100-R03	10	10	25	100	0.3
	2100-100-R05	10	10	25	100	0.5
	2100-100-R10	10	10	25	100	1
	2100-100-R15	10	10	25	100	1.5
	2100-100-R20	10	10	25	100	2
	2100-100-R25	10	10	25	100	2.5
	2100-100-R30	10	10	25	100	3
	2120-100-R03	12	12	30	100	0.3
	2120-100-R05	12	12	30	100	0.5
	2120-100-R10	12	12	30	100	1
	2120-100-R15	12	12	30	100	1.5
	2120-100-R20	12	12	30	100	2
	2120-100-R25	12	12	30	100	2.5
2120-100-R30	12	12	30	100	3	

IPRE4000 (Radius)

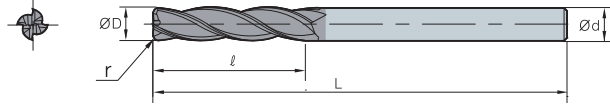

ØD	Tolerance
Ø2~Ø12	0.00~-0.02



(mm)

Designation	ØD	Ød	ℓ	L	r
IPRE 4020-050-R02	2	4	6	50	0.2
4020-050-R03	2	4	6	50	0.3
4020-050-R05	2	4	6	50	0.5
4025-050-R02	2.5	4	8	50	0.2
4030-050-R02-S3	3	3	8	50	0.2
4030-050-R03-S3	3	3	8	50	0.3
4030-050-R05-S3	3	3	8	50	0.5
4030-050-R10-S3	3	3	8	50	1
4030-050-R02	3	4	8	50	0.2
4030-050-R03	3	4	8	50	0.3
4030-050-R05	3	4	8	50	0.5
4030-050-R10	3	4	8	50	1
4040-050-R02	4	4	10	50	0.2
4040-050-R03	4	4	10	50	0.3
4040-050-R05	4	4	10	50	0.5
4040-050-R10	4	4	10	50	1
4040-050-R15	4	4	10	50	1.5
4050-050-R02	5	6	13	50	0.2
4050-050-R03	5	6	13	50	0.3
4050-050-R05	5	6	13	50	0.5
4050-050-R10	5	6	13	50	1
4060-050-R02	6	6	15	50	0.2
4060-050-R03	6	6	15	50	0.3
4060-050-R05	6	6	15	50	0.5
4060-050-R10	6	6	15	50	1
4060-050-R15	6	6	15	50	1.5
4060-050-R20	6	6	15	50	2
4080-060-R03	8	8	20	60	0.3
4080-060-R05	8	8	20	60	0.5
4080-060-R10	8	8	20	60	1
4080-060-R15	8	8	20	60	1.5
4080-060-R20	8	8	20	60	2
4080-060-R25	8	8	20	60	2.5
4080-060-R30	8	8	20	60	3
4100-075-R03	10	10	25	75	0.3
4100-075-R05	10	10	25	75	0.5
4100-075-R10	10	10	25	75	1
4100-075-R15	10	10	25	75	1.5
4100-075-R20	10	10	25	75	2
4100-075-R25	10	10	25	75	2.5
4100-075-R30	10	10	25	75	3
4120-075-R03	12	12	30	75	0.3
4120-075-R05	12	12	30	75	0.5
4120-075-R10	12	12	30	75	1
4120-075-R15	12	12	30	75	1.5
4120-075-R20	12	12	30	75	2
4120-075-R25	12	12	30	75	2.5
4120-075-R30	12	12	30	75	3

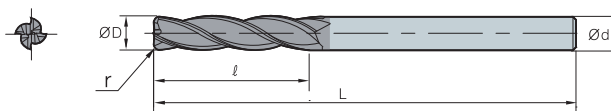

IPLRE4000 (Long radius)

ØD	Tolerance
Ø3~Ø12	0.00~-0.02



(mm)

Designation	ØD	Ød	ℓ	L	r
IPLRE					
4					
4030-075-R03	3	3	8	75	0.3
4030-075-R05	3	3	8	75	0.5
4030-075-R10	3	3	8	75	1
4040-075-R03	4	4	10	75	0.3
4040-075-R05	4	4	10	75	0.5
4040-075-R10	4	4	10	75	1
4040-075-R15	4	4	10	75	1.5
4060-100-R03	6	6	15	100	0.3
4060-100-R05	6	6	15	100	0.5
4060-100-R10	6	6	15	100	1
4060-100-R15	6	6	15	100	1.5
4060-100-R20	6	6	15	100	2
4080-100-R03	8	8	20	100	0.3
4080-100-R05	8	8	20	100	0.5
4080-100-R10	8	8	20	100	1
4080-100-R15	8	8	20	100	1.5
4080-100-R20	8	8	20	100	2
4080-100-R25	8	8	20	100	2.5
4080-100-R30	8	8	20	100	3
4100-100-R03	10	10	25	100	0.3
4100-100-R05	10	10	25	100	0.5
4100-100-R10	10	10	25	100	1
4100-100-R15	10	10	25	100	1.5
4100-100-R20	10	10	25	100	2
4100-100-R25	10	10	25	100	2.5
4100-100-R30	10	10	25	100	3
4120-100-R03	12	12	30	100	0.3
4120-100-R05	12	12	30	100	0.5
4120-100-R10	12	12	30	100	1
4120-100-R15	12	12	30	100	1.5
4120-100-R20	12	12	30	100	2
4120-100-R25	12	12	30	100	2.5
4120-100-R30	12	12	30	100	3

F Technical Information for Z⁺ Endmill

Highly efficient and economical endmill for general cutting

Z⁺ Endmill

- Wide application range from roughing to finishing on various types of workpiece materials up to H_RC47
- Increased tool life thanks to a new substrate and advanced coating layers
- Prevention of chipping and extended cutting time thanks to its optimized edge design

Features

- Wide range of workpiece materials - Carbon steel, alloy steel, cast iron, etc
- Extended tool life - Newly invented substrate and high-tech coating layers applied
- Higher productivity - Wide application range from roughing to finishing

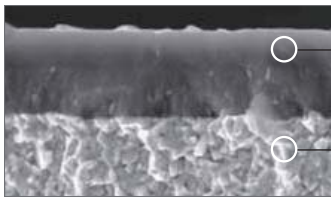

PC320U

AICrSiN coating layer
: Coating lubrication making possible high temperature/high speed machining

Ultra-fine substrate
: Substrate with excellent wear resistance applied

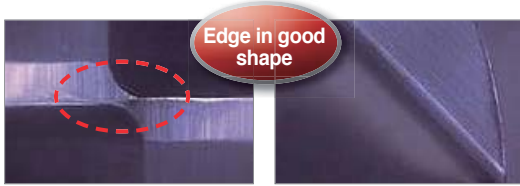
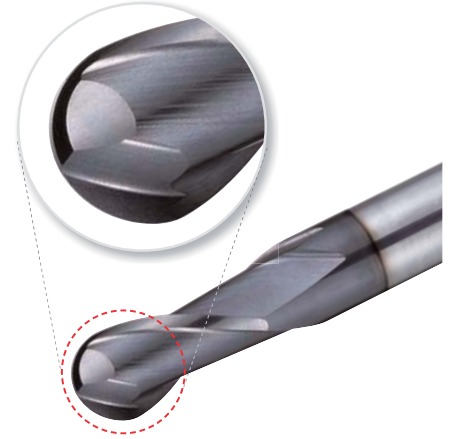

Edge in good shape

Z⁺ Endmill

Exceptional cutting edge rigidity

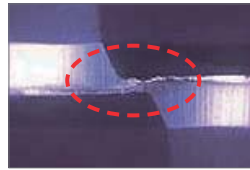

Competitor

Application examples

- **Workpiece** Carbon steel (C45, ~H_RC20)
- **Cutting conditions** vc (m/min) = 180, fz (mm/t) = 0.05
ap (mm) = 8, dry
- **Tools** ZPFE4080-060

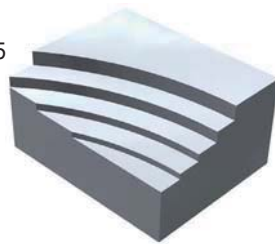

Test result

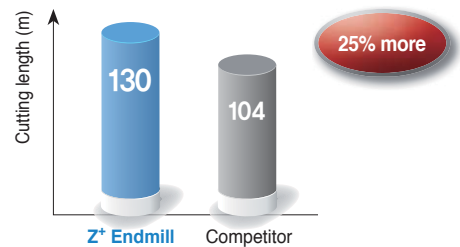

- **Workpiece** Carbon steel (C45, ~H_RC20)
- **Cutting conditions** vc (m/min) = 130, fz (mm/t) = 0.1
ap (mm) = 0.5, dry
- **Tools** ZPBE2080-100

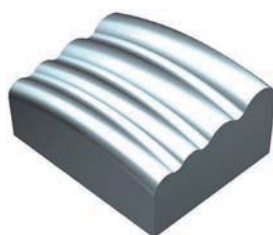

Test result

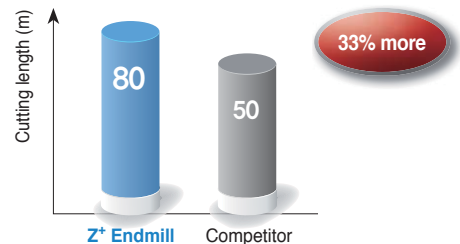

Recommended cutting conditions (ZPFE2000/ZPSFE2000 Flat)

Workpiece Cutting conditions Diameter (Ø)	Alloy steel and Carbon steel (under HRC30)		Pre-hardened steel, Mold steel (HRC30~47)		Stainless steel	
	RPM n (min-1)	Feed vf (mm/min)	RPM n (min-1)	Feed vf (mm/min)	RPM n (min-1)	Feed vf (mm/min)
1	19,745	175	13,057	100	10,500	70
2	11,560	190	7,560	120	6,300	90
3	8,920	210	5,560	140	4,620	120
4	7,560	300	4,620	180	3,880	150
5	6,300	320	3,780	190	3,160	160
6	5,560	350	3,360	220	2,840	180
8	4,200	380	2,520	200	2,100	180
10	3,260	330	2,000	160	1,680	160
12	2,740	280	1,680	130	1,360	130
16	2,200	220	1,360	110	1,060	110

Application tip

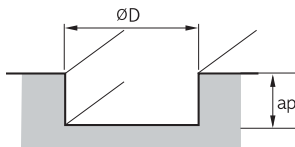

Slotting depth (ap)

- $D \leq \varnothing 2.5$ ($ap = 0.3D$)
- $D > \varnothing 2.5$ ($ap = 0.5D$)

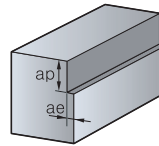

Shouldering depth (ap)

- $D \leq \varnothing 2.5$ ($ap = 1.5D$, $ae = 0.05D$)
- $D > \varnothing 2.5$ ($ap = 1.5D$, $ae = 0.1D$)

* Workpiece should be clamped rigidly. In case of vibrations, reduce RPM and feed rate by the same ratio

Recommended cutting conditions (ZPFE4000/ZPSFE4000 Flat)

Workpiece Cutting conditions Diameter (Ø)	Alloy steel and Carbon steel (under HRC30)		Pre-hardened steel, Mold steel (HRC30~47)		Stainless steel	
	RPM n (min-1)	Feed vf (mm/min)	RPM n (min-1)	Feed vf (mm/min)	RPM n (min-1)	Feed vf (mm/min)
2	11,560	280	7,560	170	6,300	140
3	8,920	320	5,560	200	4,620	170
4	7,560	570	4,620	350	3,880	280
5	6,300	600	3,780	360	3,160	300
6	5,560	660	3,360	410	2,840	330
8	4,200	710	2,520	380	2,100	350
10	3,260	610	2,000	300	1,680	300
12	2,740	520	1,680	250	1,360	240
16	2,200	410	1,360	200	1,100	200

Application tip

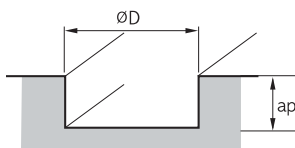

Slotting depth (ap)

- $D \leq \varnothing 2.5$ ($ap = 0.3D$)
- $D > \varnothing 2.5$ ($ap = 0.5D$)

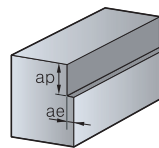

Shouldering depth (ap)

- $D \leq \varnothing 2.5$ ($ap = 1.5D$, $ae = 0.05D$)
- $D > \varnothing 2.5$ ($ap = 1.5D$, $ae = 0.1D$)

* Workpiece should be clamped rigidly. In case of vibrations, reduce RPM and feed rate by the same ratio

F Technical Information for Z⁺ Endmill

Recommended cutting conditions (ZPBE2000 Ball)

Workpiece Cutting conditions Diameter (Ø)	Alloy steel and Carbon steel (under HRC30)		Pre-hardened steel, Mold steel (HRC30~47)	
	RPM n (min-1)	Feed vf (mm/min)	RPM n (min-1)	Feed vf (mm/min)
1	30,000	2,880	30,000	2,520
1.2	30,000	3,060	28,800	2,580
1.5	30,000	3,240	28,800	2,700
2	29,820	3,420	28,680	2,880
3	19,860	3,600	19,080	3,180
4	14,940	3,600	14,340	3,180
5	11,160	3,480	10,680	2,940
6	8,340	2,910	8,040	2,460
8	6,660	2,520	6,420	2,100
10	5,580	2,220	5,340	1,860
12	4,170	1,770	4,008	1,500

Application tip

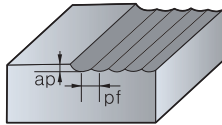

- $ap = 0.03D$
- $pf = 0.05D$

※ Workpiece should be clamped rigidly. In case of vibrations, reduce RPM and feed rate by the same ratio

Recommended cutting conditions (ZPRE2000 Radius)

Workpiece Cutting conditions Diameter (Ø)	Alloy steel and Carbon steel (under HRC30)		Pre-hardened steel, Mold steel (HRC30~47)		Stainless steel	
	RPM n (min-1)	Feed vf (mm/min)	RPM n (min-1)	Feed vf (mm/min)	RPM n (min-1)	Feed vf (mm/min)
6	5,300	420	3,200	240	2,400	180
8	4,000	450	2,700	210	2,040	150
10	3,200	390	2,400	180	1,600	120
12	2,700	330	2,040	150	1,300	100
14	2,400	270	1,600	120	1,000	70
16	2,040	200	1,300	100	1,300	60

Application tip

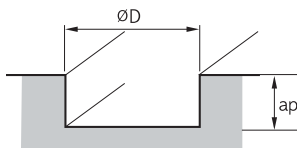

- Slotting depth (ap)
- $ap: \leq 0.3D$

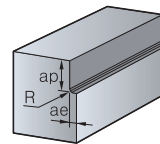

- Shouldering depth (ap)
- $ap: \leq 1.5D$
- $ae: \leq 0.1D$

※ Workpiece should be clamped rigidly. In case of vibrations, reduce RPM and feed rate by the same ratio

Notice

- Please adjust the recommended cutting conditions properly, according to the condition of your machines, the target shapes, and your purpose for machining
- Workpiece should be clamped rigidly. In case of vibrations, reduce RPM and feed rate by the same ratio
- In case of overhang over 3D, reduce RPM and feed rate



ZPFE2000 (Flat)

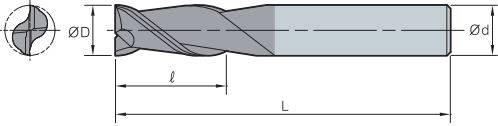

ØD	Tolerance
~Ø11.9	0.00~ -0.02
Ø12~	0.00~ -0.03

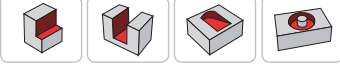

(mm)

Designation	ØD	Ød	ℓ	L
ZPFE				
2010-050-S4	1.0	4	3	50
2015-050-S4	1.5	4	4	50
2020-050-S4	2.0	4	6	50
2025-050-V6S4	2.5	4	6	50
2025-050-V8S4	2.5	4	8	50
2030-050-S4	3.0	4	9	50
2030-050	3.0	6	9	50
2035-050-S4	3.5	4	9	50
2035-050	3.5	6	9	50
2040-050-S4	4.0	4	11	50
2040-050	4.0	6	11	50
2045-050	4.5	6	11	50
2050-050	5.0	6	13	50
2060-050	6.0	6	16	50
2065-060	6.5	8	16	60
2070-060	7.0	8	20	60
2075-060	7.5	8	20	60
2080-060	8.0	8	20	60
2085-075	8.5	10	23	75
2090-075	9.0	10	23	75
2095-075	9.5	10	25	75
2100-075	10.0	10	25	75
2105-075	10.5	12	26	75
2110-075	11.0	12	28	75
2120-075	12.0	12	30	75
2140-100	14.0	14	34	100
2150-090	15.0	16	36	90
2160-100	16.0	16	36	100
2170-100	17.0	20	40	100
2180-100	18.0	18	40	100
2190-100	19.0	20	40	100
2200-100	20.0	20	40	100



ZPSFE2000 (Short flat)

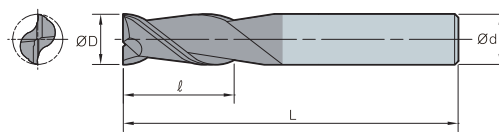

ØD	Tolerance
~Ø11.9	0.00~ -0.02
Ø12~	0.00~ -0.03



(mm)

Designation	ØD	Ød	ℓ	L
ZPSFE				
2010-050-S4	1.0	4	2	50
2015-050-S4	1.5	4	2	50
2020-050-S4	2.0	4	3	50
2025-050-S4	2.5	4	4	50
2030-050-S4	3.0	4	5	50
2040-050-S4	4.0	4	6	50
2050-050	5.0	6	8	50
2060-050	6.0	6	9	50
2070-050	7.0	8	10	50
2080-050	8.0	8	12	50
2100-075	10.0	10	15	75
2120-075	12.0	12	18	75
2160-100	16.0	16	24	100

ZPLFE2000 (Long flat)

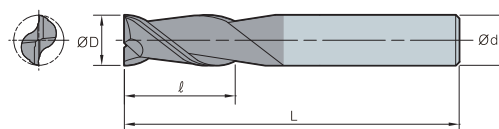

ØD	Tolerance
~Ø11.9	0.00~ -0.02
Ø12~	0.00~ -0.03



(mm)

Designation	ØD	Ød	ℓ	L
ZPLFE				
2020-075-S4	2.0	4	6	75
2030-075-S4	3.0	4	9	75
2030-075	3.0	6	12	75
2040-075-S4	4.0	4	11	75
2050-075	5.0	6	20	75
2060-100	6.0	6	16	100
2060-100-V20S6	6.0	6	20	100
2080-075	8.0	8	20	75
2080-100	8.0	8	25	100
2100-100	10.0	10	30	100
2120-100	12.0	12	35	100
2160-150	16.0	16	36	150
2200-150	20.0	20	45	150



ZPLFE2000 (Long flute)

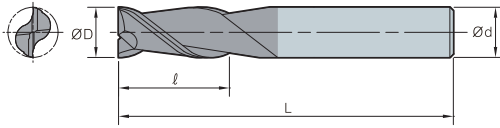

ØD	Tolerance
~Ø11.9	0.00~ -0.02
Ø12~	0.00~ -0.03



(mm)

Designation	ØD	Ød	ℓ	L
ZPLFE				
2020-075-V15S4	2.0	4	15	75
2030-075-V25S4	3.0	4	25	75
2040-075-V30S4	4.0	4	30	75
2050-075-V30S6	5.0	6	30	75
2060-075-V35S6	6.0	6	35	75
2080-100-V40S8	8.0	8	40	100
2100-100-V45S10	10.0	10	45	100
2120-100-V50S12	12.0	12	50	100
2140-100-V55S14	14.0	14	55	100
2160-150-V50S16	16.0	16	50	150
2160-150-V60S16	16.0	16	60	150
2180-150-V65S18	18.0	18	65	150
2200-150-V70S20	20.0	20	70	150



ZPFE4000 (Flat)

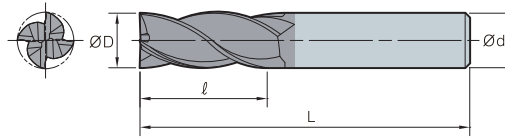

ØD	Tolerance
~Ø11.9	0.00~ -0.02
Ø12~	0.00~ -0.03



(mm)

Designation	ØD	Ød	ℓ	L
ZPFE				
4 4010-050-S4	1.0	4	3	50
4015-050-S4	1.5	4	5	50
4015-050	1.5	6	5	50
4020-050-S4	2.0	4	6	50
4020-050	2.0	6	6	50
4025-050-S4	2.5	4	8	50
4025-050	2.5	6	8	50
4030-050	3.0	6	6	50
4030-050-S4	3.0	4	9	50
4030-050-V9S6	3.0	6	9	50
4035-050-S4	3.5	4	11	50
4035-050	3.5	6	9	50
4040-050-S4	4.0	4	11	50
4040-050	4.0	6	11	50
4045-050	4.5	6	11	50
4050-050	5.0	6	8	50
4050-050-V13S6	5.0	6	13	50
4055-050	5.5	6	16	50
4060-050	6.0	6	16	50
4065-060	6.5	8	16	60
4070-060	7.0	8	20	60
4075-060	7.5	8	20	60
4080-060	8.0	8	20	60
4085-075	8.5	10	23	75
4090-075	9.0	10	23	75
4095-075	9.5	10	23	75
4100-075	10.0	10	25	75
4110-075	11.0	12	28	75
4120-075	12.0	12	30	75
4130-100	13.0	14	32	100
4140-075	14.0	14	32	75
4140-100	14.0	14	34	100
4150-100	15.0	16	36	100
4160-100	16.0	16	36	100
4160-100-V40S16	16.0	16	40	100
4160-100-V45S16	16.0	16	45	100
4170-100-S18	17.0	18	38	100
4180-100-S18	18.0	18	45	100
4200-100-S20	20.0	20	45	100



ZPSFE4000 (Short flat)

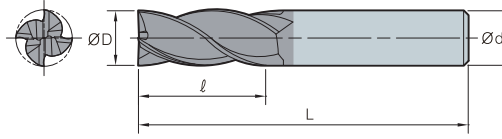

ØD	Tolerance
~Ø11.9	0.00~ -0.02
Ø12~	0.00~ -0.03



(mm)

Designation	ØD	Ød	ℓ	L
ZPSFE				
4010-050-S4	1.0	4	2	50
4015-050-S4	1.5	4	2	50
4020-050-S4	2.0	4	3	50
4025-050-S4	2.5	4	4	50
4030-050-S4	3.0	4	5	50
4040-050-S4	4.0	4	6	50
4050-050	5.0	6	8	50
4060-050	6.0	6	9	50
4070-050	7.0	8	10	50
4080-050	8.0	8	12	50
4100-075	10.0	10	15	75
4120-075	12.0	12	18	75
4160-100	16.0	16	24	100

ZPLFE4000 (Long flat)

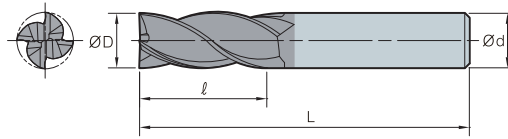

ØD	Tolerance
~Ø11.9	0.00~ -0.02
Ø12~	0.00~ -0.03



(mm)

Designation	ØD	Ød	ℓ	L
ZPLFE				
4020-075-S4	2.0	4	10	75
4030-075-S4	3.0	4	12	75
4040-075-S4	4.0	4	11	75
4040-050-V15S4	4.0	4	15	75
4050-075	5.0	6	20	75
4060-075	6.0	6	16	75
4060-075-V20S6	6.0	6	20	75
4080-075	8.0	8	20	75
4080-100-S8	8.0	8	25	100
4100-100	10.0	10	30	100
4100-100-V35S10	10.0	10	35	100
4120-100	12.0	12	35	100
4160-150	16.0	16	36	150
4200-150	20.0	20	45	150



ZPLFE4000 (Long flute)

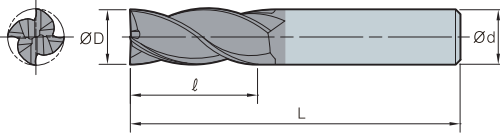

ØD	Tolerance
~Ø11.9	0.00~ -0.02
Ø12~	0.00~ -0.03

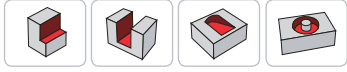

(mm)

Designation	ØD	Ød	ℓ	L
ZPLFE				
4010-050-V04S4	1.0	4	4	50
4020-050-V10S4	2.0	4	10	50
4030-060-V15S4	3.0	4	15	60
4030-060-V16S6	3.0	6	16	60
4040-060-V20S4	4.0	4	20	60
4040-075-V20S6	4.0	6	20	75
4040-075-V30S4	4.0	4	30	75
4050-075-V25S6	5.0	6	25	75
4050-075-V30S6	5.0	6	30	75
4060-075-V30S6	6.0	6	30	75
4060-075-V35S6	6.0	6	35	75
4080-100-V35S8	8.0	8	35	100
4080-100-V40S8	8.0	8	40	100
4100-100-V45S10	10.0	10	45	100
4100-100-V50S10	10.0	10	50	100
4120-100-V45S12	12.0	12	45	100
4120-100-V50S12	12.0	12	50	100
4140-100-V45S14	14.0	14	45	100
4160-150-V50S16	16.0	16	50	150
4160-150-V60S16	16.0	16	60	150
4160-150-V70S16	16.0	16	70	150
4180-150-V70S18	18.0	18	70	150
4200-150-V70S20	20.0	20	70	150

ZPFE3000 (Flat)

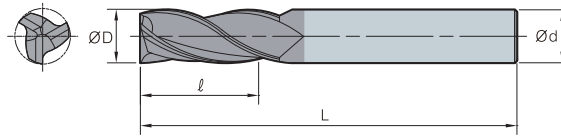

ØD	Tolerance
~Ø11.9	0.00~ -0.02
Ø12~	0.00~ -0.03



(mm)

Designation	ØD	Ød	ℓ	L	
ZPFE 3	3020-050-S4	2.0	4	6	50
	3030-050-S4	3.0	4	9	50
	3040-050-S4	4.0	4	11	50
	3050-050	5.0	6	13	50
	3060-050	6.0	6	16	50
	3065-060	6.5	8	16	60
	3080-060	8.0	8	20	60
	3095-075	9.5	10	24	75
	3100-075	10.0	10	25	75
	3120-075	12.0	12	30	75
	3106-100	16.0	16	36	100
	3180-100	18.0	18	40	100
	3200-100	20.0	20	45	100
	3250-100	25.0	25	50	100

ZPFE6000 (Flat)

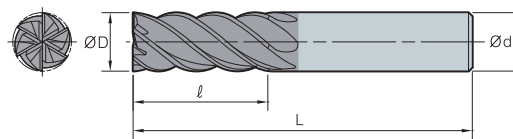

ØD	Tolerance
~Ø11.9	0.00~ -0.02
Ø12~	0.00~ -0.03



(mm)

Designation	ØD	Ød	ℓ	L	
ZPFE 6	6060-050	6.0	6	15	50
	6080-060	8.0	8	20	60
	6100-075	10.0	10	25	75
	6120-075	12.0	12	30	75
	6160-100	16.0	16	36	100
	6200-100	20.0	20	45	100



ZPBE2000 (Ball)

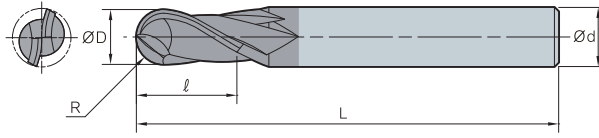

ØD	Tolerance
~Ø11.9	0.00~ -0.02
Ø12~	0.00~ -0.03



(mm)

Designation	R	ØD	Ød	ℓ	L
ZPBE					
2008-050-S4	0.4	0.8	4	1.6	50
2009-050-S4	0.5	0.9	4	1.8	50
2010-050-S4	0.5	1.0	4	2	50
2015-050-S4	0.8	1.5	4	3	50
2020-050-S4	1.0	2.0	4	4	50
2020-050	1.0	2.0	6	4	50
2025-050-S4	1.3	2.5	4	5	50
2030-050-S4	1.5	3.0	4	6	50
2030-050	1.5	3.0	6	6	50
2040-050-S4	2.0	4.0	4	8	50
2040-050	2.0	4.0	6	8	50
2050-050	2.5	5.0	6	10	50
2060-050	3.0	6.0	6	12	50
2070-060	3.5	7.0	8	14	60
2080-060	4.0	8.0	8	14	60
2090-075	4.5	9.0	10	16	75
2100-075	5.0	10.0	10	18	75
2110-075	5.5	11.0	12	20	75
2120-075	6.0	12.0	12	22	75
2130-090	6.5	13.0	14	26	90
2140-090	7.0	14.0	14	26	90
2150-090	7.5	15.0	16	30	90
2160-100	8.0	16.0	16	30	100
2200-100	10.0	20.0	20	38	100

ZPLBE2000 (Long ball)

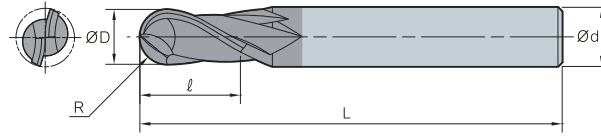

ØD	Tolerance
~Ø11.9	0.00~ -0.02
Ø12~	0.00~ -0.03



(mm)

Designation	R	ØD	Ød	ℓ	L	
ZPLBE 2	2020-075-S4	1.0	2.0	4	75	
	2030-075-S4	1.5	3.0	4	75	
	2030-075	1.5	3.0	6	75	
	2040-075-S4	2.0	4.0	4	75	
	2040-075	2.0	4.0	6	75	
	2050-075	2.5	5.0	6	10	75
	2060-075	3.0	6.0	6	12	75
	2080-100	4.0	8.0	8	14	100
	2100-100	5.0	10.0	10	18	100
	2120-100	6.0	12.0	12	20	100

ZPBE4000 (Ball)

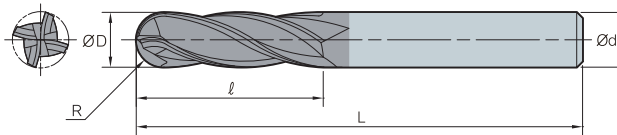

ØD	Tolerance
~Ø11.9	0.00~ -0.02
Ø12~	0.00~ -0.03



(mm)

Designation	R	ØD	Ød	ℓ	L	
ZPBE 4	4020-050-S4	1.0	2.0	4	50	
	4025-050-S4	1.3	2.5	4	50	
	4030-050-S4	1.5	3.0	4	50	
	4030-050	1.5	3.0	6	50	
	4040-050-S4	2.0	4.0	4	50	
	4040-050	2.0	4.0	6	50	
	4050-050	2.5	5.0	6	10	50
	4060-050	3.0	6.0	6	12	50
	4070-060	3.5	7.0	8	14	60
	4080-060	4.0	8.0	8	14	60
	4090-075	4.5	9.0	10	16	75
	4100-075	5.0	10.0	10	18	75
	4110-075	5.5	11.0	12	20	75
	4120-075	6.0	12.0	12	22	75
	4140-075	7.0	14.0	14	24	75
	4160-100	8.0	16.0	16	30	100
	4200-100	10.0	20.0	20	38	100



ZPRE2000 (Radius)

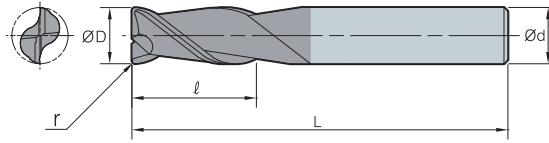

ØD	Tolerance
~Ø11.9	0.00~-0.02
Ø12~	0.00~-0.03

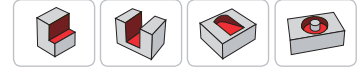

(mm)

Designation	ØD	Ød	ℓ	L	r
ZPRE					
2010-050-S4-R02	1.0	4	3	50	0.2
2020-050-S4-R02	2.0	4	6	50	0.2
2030-050-S4-R02	3.0	4	9	50	0.2
2030-050-R02	3.0	6	9	50	0.2
2030-050-S4-R03	3.0	4	9	50	0.3
2030-050-R03	3.0	6	9	50	0.3
2030-050-S4-R05	3.0	4	9	50	0.5
2030-050-R05	3.0	6	9	50	0.5
2040-050-S4-R02	4.0	4	11	50	0.2
2040-050-R02	4.0	6	11	50	0.2
2040-050-S4-R03	4.0	4	11	50	0.3
2040-050-R03	4.0	6	11	50	0.3
2040-050-S4-R05	4.0	4	11	50	0.5
2040-050-R05	4.0	6	11	50	0.5
2040-050-S4-R10	4.0	4	11	50	1.0
2050-050-R02	5.0	6	13	50	0.2
2050-050-R03	5.0	6	13	50	0.3
2050-050-R05	5.0	6	13	50	0.5
2050-050-R010	5.0	6	13	50	1.0
2060-050-R05	6.0	6	16	50	0.5
2060-050-R10	6.0	6	16	50	1.0
2060-050-R15	6.0	6	16	50	1.5
2060-050-R20	6.0	6	16	50	2.0
2080-060-R03	8.0	8	20	60	0.3
2080-060-R05	8.0	8	20	60	0.5
2080-060-R10	8.0	8	20	60	1.0
2080-060-R15	8.0	8	20	60	1.5
2080-060-R20	8.0	8	20	60	2.0
2100-075-R03	10.0	10	25	75	0.3
2100-075-R06	10.0	10	25	75	0.6
2100-075-R10	10.0	10	25	75	1.0
2100-075-R15	10.0	10	25	75	1.5
2100-075-R20	10.0	10	25	75	2.0
2100-075-R30	10.0	10	25	75	3.0
2120-075-R05	12.0	12	30	75	0.5
2120-075-R10	12.0	12	30	75	1.0
2120-075-R15	12.0	12	30	75	1.5
2120-075-R20	12.0	12	30	75	2.0
2120-075-R30	12.0	12	30	75	3.0
2160-100-R10	16.0	16	36	100	1.0
2160-100-R20	16.0	16	36	100	2.0
2160-100-R30	16.0	16	36	100	3.0

ZPLRE2000 (Long radius)

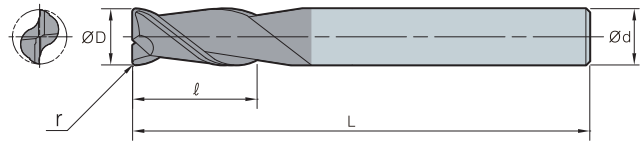

ØD	Tolerance
~Ø11.9	0.00~ -0.02
Ø12~	0.00~ -0.03



(mm)

Designation	ØD	Ød	ℓ	L	r
ZPLRE					
2060-075-R05	6.0	6	16	75	0.5
2060-075-R10	6.0	6	16	75	1.0
2060-075-R15	6.0	6	16	75	1.5
2080-100-R05	8.0	8	20	100	0.5
2080-100-R10	8.0	8	20	100	1.0
2080-100-R15	8.0	8	20	100	1.5
2100-100-R05	10.0	10	25	100	0.5
2100-100-R10	10.0	10	25	100	1.0
2100-100-R15	10.0	10	25	100	1.5
2100-100-R20	10.0	10	25	100	2.0
2120-100-R05	12.0	12	30	100	0.5
2120-100-R10	12.0	12	30	100	1.0
2120-100-R15	12.0	12	30	100	1.5
2120-100-R20	12.0	12	30	100	2.0
2160-150-R05	16.0	16	36	150	0.5
2160-150-R10	16.0	16	36	150	1.0
2160-150-R15	16.0	16	36	150	1.5
2160-150-R20	16.0	16	36	150	2.0



ZPRE4000 (Radius)

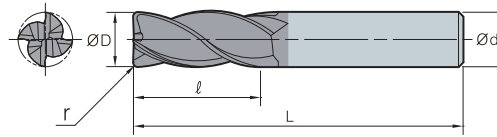

ØD	Tolerance
~Ø11.9	0.00~ -0.02
Ø12~	0.00~ -0.03



(mm)

Designation	ØD	Ød	ℓ	L	r
ZPRE					
4 4015-050-S4-R02	1.5	4	5	50	0.2
4020-050-S4-R02	2.0	4	6	50	0.2
4030-050-S4-R02	3.0	4	9	50	0.2
4030-050-S4-R03	3.0	4	9	50	0.3
4030-050-S4-R05	3.0	4	9	50	0.5
4040-050-S4-R02	4.0	4	11	50	0.2
4040-050-S4-R03	4.0	4	11	50	0.3
4040-050-S4-R05	4.0	4	11	50	0.5
4040-050-S4-R10	4.0	4	11	50	1.0
4045-050-R10	4.5	6	12	50	1.0
4050-050-R02	5.0	6	13	50	0.2
4050-050-R05	5.0	6	13	50	0.5
4050-050-R10	5.0	6	13	50	1.0
4050-050-R15	5.0	6	13	50	1.5
4060-050-R05	6.0	6	16	50	0.5
4060-050-R10	6.0	6	16	50	1.0
4060-050-R15	6.0	6	16	50	1.5
4080-060-R03	8.0	8	20	60	0.3
4080-060-R05	8.0	8	20	60	0.5
4080-060-R10	8.0	8	20	60	1.0
4080-060-R15	8.0	8	20	60	1.5
4080-060-R20	8.0	8	20	60	2.0
4100-075-R03	10.0	10	25	75	0.3
4100-075-R05	10.0	10	25	75	0.5
4100-075-R10	10.0	10	25	75	1.0
4100-075-R15	10.0	10	25	75	1.5
4100-075-R20	10.0	10	25	75	2.0
4100-075-R25	10.0	10	25	75	2.5
4100-075-R30	10.0	10	25	75	3.0
4120-075-R05	12.0	12	30	75	0.5
4120-075-R10	12.0	12	30	75	1.0
4120-075-R15	12.0	12	30	75	1.5
4120-075-R20	12.0	12	30	75	2.0
4120-075-R25	12.0	12	30	75	2.5
4120-075-R30	12.0	12	30	75	3.0
4160-100-R05	16.0	16	36	100	0.5
4160-100-R10	16.0	16	36	100	1.0
4160-100-R20	16.0	16	36	100	2.0
4160-100-R30	16.0	16	36	100	3.0

ZPLRE4000 (Long radius)

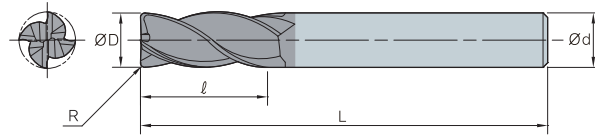

ØD	Tolerance
~Ø11.9	0.00~ -0.02
Ø12~	0.00~ -0.03



(mm)

Designation	ØD	Ød	ℓ	L	r	
ZPLRE 4	4060-075-R05	6.0	6	16	75	0.5
	4060-075-R10	6.0	6	16	75	1.0
	4060-075-R15	6.0	6	16	75	1.5
	4080-100-R05	8.0	8	20	100	0.5
	4080-100-R10	8.0	8	20	100	1.0
	4080-100-R15	8.0	8	20	100	1.5
	4080-100-R20	8.0	8	20	100	2.0
	4100-100-R05	10.0	10	25	100	0.5
	4100-100-R10	10.0	10	25	100	1.0
	4100-100-R15	10.0	10	25	100	1.5
	4100-100-R20	10.0	10	25	100	2.0
	4120-100-R05	12.0	12	30	100	0.5
	4120-100-R10	12.0	12	30	100	1.0
	4120-100-R15	12.0	12	30	100	1.5
	4120-100-R20	12.0	12	30	100	2.0
	4120-100-R30	12.0	12	30	100	3.0
	4160-150-R05	16.0	16	36	150	0.5
	4160-150-R10	16.0	16	36	150	1.0
	4160-150-R15	16.0	16	36	150	1.5
	4160-150-R20	16.0	16	36	150	2.0
4160-150-R30	16.0	16	36	150	3.0	



Endmill for Stainless steel machining

S⁺ Endmill

- Strong cutting edge ensures long tool life
- Special coating with high oxidation resistance
- High rake angle and curvilinear chip pocket allow chip evacuation
- Special cutting edge prevents hardening of tools
- Optimal machinability in stainless steel machining
- Available for steel, alloy steel and hardening steel machining
- Available for multiple operations (Shouldering, slotting and ramping etc.)

Application area

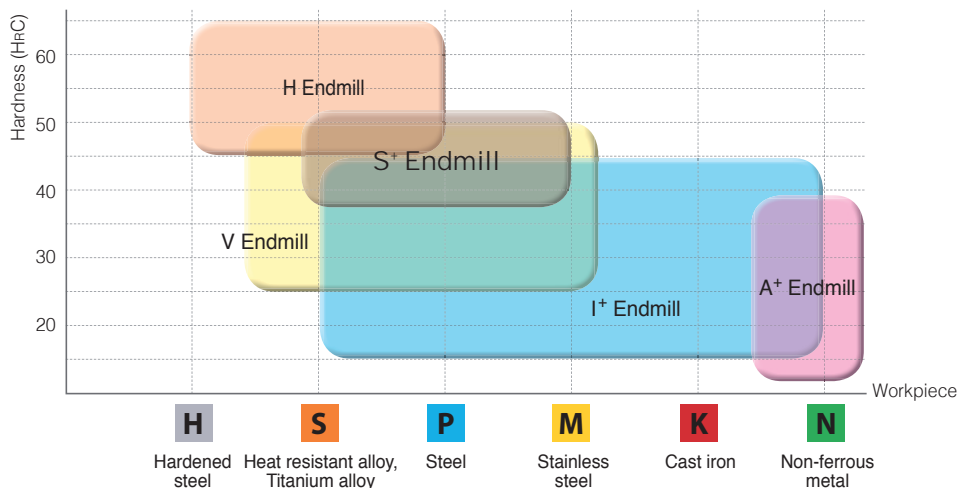

Performance evaluation

- **Workpiece** STS304
- **Cutting conditions** Diameter = Ø8.0, n (min⁻¹) = 4.000, vc (m/min) = 100, vf (mm/min) = 480, fz (mm/t) = 0.04, ap (mm) = 8, ae (mm) = 0.8, dry
- **Tools** SPFE4080-060



S⁺ Endmill

Competitor A

Competitor B

Test result

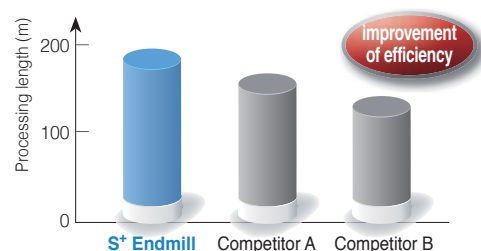

F Technical Information for S⁺ Endmill

Recommend cutting conditions

Workpiece Condition Diameter (Ø)	Stainless steel STS		Titanium alloy /Inconel		Normal steel (SS, SM) (Under HRC 25)		Alloy steel (SCM) (HRC 25~35)		Hardened steel (STD) (HRC 40~50)	
	R.P.M n (min ⁻¹)	Feed vf (mm/min)	R.P.M n (min ⁻¹)	Feed vf (mm/min)	R.P.M n (min ⁻¹)	Feed vf (mm/min)	R.P.M n (min ⁻¹)	Feed vf (mm/min)	R.P.M n (min ⁻¹)	Feed vf (mm/min)
2	5,500	240	2,600	90	9,000	540	6,000	3,200	4,000	240
4	4,000	260	2,000	90	6,600	600	4,500	340	3,000	280
6	3,000	360	1,200	90	4,800	720	3,000	360	2,500	280
8	2,000	390	1,000	100	3,600	750	2,200	460	2,000	300
10	1,700	410	800	120	2,800	750	1,800	460	1,500	300
12	1,500	380	700	100	2,400	710	1,500	410	1,200	280
14	1,200	320	600	95	2,200	660	1,300	370	1,000	270
16	1,000	270	500	90	1,800	490	1,100	320	800	230
20	750	250	400	85	900	270	900	270	600	200

Application tip

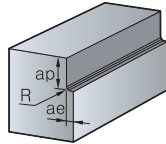

- **Shouldering depth (ap) and radial depth (ae)**
 - Normal steel, Alloy steel, Stainless steel: ap = 1.5D, ae = 0.1D
 - Titanium alloy, Inconel, Hardened steel: ap = 1.5D, ae = 0.05D

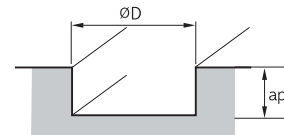

- **Slotting depth (ap)**
 - Normal steel, Alloy steel: ap = 1.0D
 - Stainless steel: ap = 0.3D
 - Titanium alloy, Inconel, Hardened steel: ap = 0.2D

Stainless steel machining

- Low thermal conductivity of stainless steel alloy causes conducting heat to the tool and fracture and chipping
- Stainless steel alloy has high cutting resistance, and it easily causes wear on tools
- High temperature in stainless steel alloy machining lowers cutting conditions and decrease the quality of surface roughness

Trouble shooting for stainless steel

- Getting low cutting conditions
- Getting deeper ap than the work hardened layer and use tools with sharp cutting edge
- Use coolant

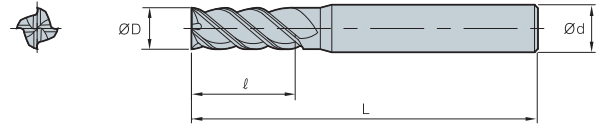

SPFE4000 (Flat)

ØD	Tolerance
Ø1~Ø12	0.00~-0.02

(mm)

Designation	ØD	Ød	ℓ	L	
SPFE 	4010-050	1.0	4	3	50
	4015-050	1.5	4	4	50
	4020-050	2.0	4	6	50
	4025-050	2.5	4	8	50
	4030-050	3.0	4	9	50
	4030-050-S6	3.0	6	9	50
	4040-050	4.0	4	11	50
	4040-050-S6	4.0	6	11	50
	4050-050	5.0	6	13	50
	4060-050	6.0	6	16	50
	4080-060	8.0	8	20	60
	4100-075	10.0	10	30	75
	4120-075	12.0	12	32	75

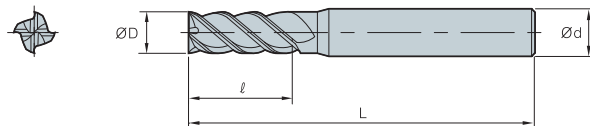
SPLFE4000 (Long flat)

ØD	Tolerance
Ø1~Ø12	0.00~-0.02

(mm)

Designation	ØD	Ød	ℓ	L	
SPLFE 	4010-050	1.0	4	4	50
	4015-050	1.5	4	6	50
	4020-050	2.0	4	8	50
	4025-050	2.5	4	10	50
	4030-050-S6	3.0	6	12	50
	4040-050-S6	4.0	6	16	50
	4050-060	5.0	6	20	60
	4060-060	6.0	6	24	60
	4080-075	8.0	8	35	75
	4100-100	10.0	10	45	100
	4120-100	12.0	12	45	100

F Technical Information for R⁺ Endmill

High efficient roughing endmill

R⁺ Endmill new

- Cost-effective cutting-edge design for rough machining
- Decreased cutting load by implementing specifically designed edges, irregular flute spacing, and unequal lead angle

Feature

- Excellent machining efficiency - Special design for medium to rough cutting
- Longer cutting life - Extended tool cost thanks to newly applied grades
- Higher cutting performance - Blade design ideal for roughing



Lower cutting load

- Ideal for medium to rough cutting
- Special edge design

Smooth cutting

- Serrated cutting edges
- 3 Combo R

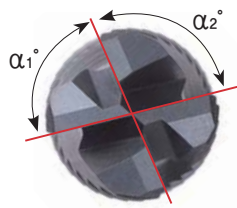

- Irregular flute spacing to prevent chattering
($\alpha_1 \neq \alpha_2$)



- Irregular lead angles to disperse cutting force
($\beta_1 \neq \beta_2$)

Grade system

Carbide roughing		HSS roughing	
FN30T	Carbide, uncoated	HN30T	HSS PM, uncoated
PC10T	Carbide, TiCN coated	HN20T	HSS, uncoated
PC20T	Carbide, TiN coated	HC10T	HSS, TiCN coated
PC30T	Carbide, TiAlN coated	HC20T	HSS, TiN coated
PC40T	Carbide, TiAlCrN coated	HC30T	HSS PM, TiAlN coated

Application examples

- **Workpiece** Mold
- **Cutting conditions** vc (m/min) = 57, fz (mm/t) = 0.03
 ap (mm) = 8, dry
- **Tools** RPE4080-075-FF

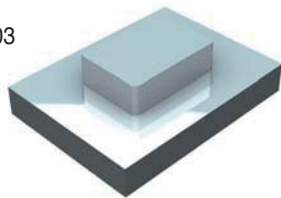

Test result

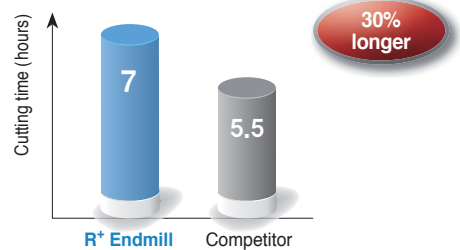

- **Workpiece** Mold
- **Cutting conditions** vc (m/min) = 68, fz (mm/t) = 0.06
 ap (mm) = 8, dry
- **Tools** RPE4080-063-FF-H

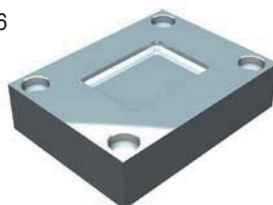

Test result

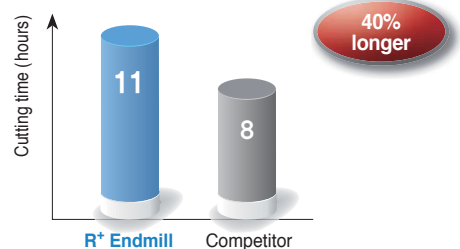

Recommended cutting conditions (RPAE)

* For Carbide

Workpiece Conditions Diameter (∅)	Aluminum, Non-ferrous metal		Aluminum, Non-ferrous metal	
	RPM n (min-1)	Feed vf (mm/min)	RPM n (min-1)	Feed vf (mm/min)
6	13,000	1,125	13,000	1,400
8	10,400	1,300	10,400	1,600
10	10,400	1,585	10,400	2,000
12	10,400	1,950	10,400	1,650
14	7,800	1,675	7,800	2,050
16	7,800	1,755	7,800	2,250
18	5,200	1,300	5,200	1,700
20	5,200	1,495	5,200	1,800
25	5,000	1,495	5,000	1,800

Application tip

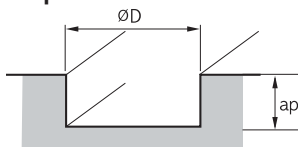

- Slotting depth (ap)
 - ap : ≤ 0.2D

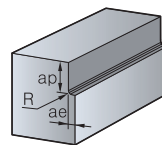

- Shouldering depth (ap)
 - ap : ≤ 1.5D
 - ae : ≤ 0.15D

* Workpiece should be clamped rigidly. In case of vibrations, reduce R.P.M and feed rate by the same ratio

Recommended cutting conditions (RP(L)E-FP-H)

* For Carbide

Workpiece Conditions Diameter (∅)	Alloy steel, Carbon steel (≤ HRC25)		Alloy steel, Carbon steel, Pre-hardened steel (HRC25~HRC40)		Alloy steel, Carbon steel (≤ HRC25)		Alloy steel, Carbon steel, Pre-hardened steel (HRC25~HRC40)	
	RPM n (min-1)	Feed vf (mm/min)	RPM n (min-1)	Feed vf (mm/min)	RPM n (min-1)	Feed vf (mm/min)	RPM n (min-1)	Feed vf (mm/min)
6	12,000	1,550	10,600	1,100	15,800	2,570	14,300	1,850
8	9,000	1,650	8,100	1,180	11,900	2,700	10,700	1,950
10	7,200	1,650	6,400	1,180	9,500	2,700	8,500	1,950
12	6,000	1,540	5,400	1,140	8,000	2,570	7,100	1,850
14	5,200	1,540	4,750	1,095	7,000	2,510	6,250	1,800
16	4,500	1,540	4,100	1,050	6,000	2,450	5,400	1,750
18	4,400	1,435	3,650	975	5,400	2,295	4,850	1,625
20	3,600	1,330	3,200	900	4,800	2,140	4,300	1,500
25	3,200	1,200	2,800	850	4,400	2,000	3,800	1,400

Application tip

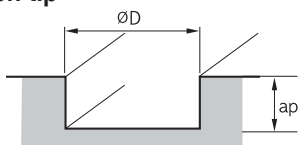

- Slotting depth (ap)
 - ap : ≤ 1.0D (≤ HRC25)
 - ≤ 0.8D (HRC25~40)

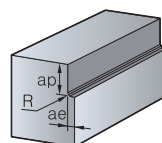

- Shouldering depth (ap)
 - ap : ≤ 1.0D
 - ae : ≤ 0.5D (≤ HRC25)
 - ≤ 0.35D (HRC25~40)

* Workpiece should be clamped rigidly. In case of vibrations, reduce R.P.M and feed rate by the same ratio

F Technical Information for R⁺ Endmill

Recommended cutting conditions (RPE-XG)

* For Carbide

Workpiece Conditions Diameter (Ø)	Alloy steel, Carbon steel (≤ HRC25)		Alloy steel, Carbon steel, Pre-hardened steel (HRC25~HRC40)		Alloy steel, Carbon steel (≤ HRC25)		Alloy steel, Carbon steel, Pre-hardened steel (HRC25~HRC40)	
	RPM n (min-1)	Feed vf (mm/min)	RPM n (min-1)	Feed vf (mm/min)	RPM n (min-1)	Feed vf (mm/min)	RPM n (min-1)	Feed vf (mm/min)
6	12,000	1,090	10,600	770	15,800	1,800	14,300	1,300
8	9,000	1,160	8,100	830	11,900	1,890	10,700	1,370
10	7,200	1,160	6,400	830	9,500	1,890	8,500	1,370
12	6,000	1,080	5,400	800	8,000	1,800	7,100	1,300
14	5,200	1,080	4,750	770	7,000	1,760	6,250	1,260
16	4,500	1,080	4,100	740	6,000	1,720	5,400	1,230
18	4,400	1,000	3,650	680	5,400	1,610	4,850	1,140
20	3,600	930	3,200	630	4,800	1,500	4,300	1,050
25	3,200	840	2,800	600	4,400	1,400	3,800	980

Application tip

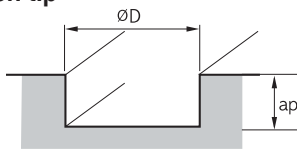

Slotting depth (ap)

- ap: ≤ 1.0D (≤ HRC25)
- ap: ≤ 0.8D (HRC25~40)

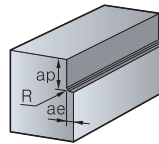

Shouldering depth (ae)

- ae: ≤ 1.0D
- ae: ≤ 0.5D (≤ HRC25)
- ae: ≤ 0.35D (HRC25~40)

* Workpiece should be clamped rigidly. In case of vibrations, reduce R.P.M and feed rate by the same ratio

Recommended cutting conditions (RPE-FP-L)

* For Carbide

Workpiece Conditions Diameter (Ø)	Alloy steel, Carbon steel (≤ HRC35)		Pre-hardened steel (HRC35~HRC45)		High hardened steel (HRC45~HRC55)	
	RPM n (min-1)	Feed vf (mm/min)	RPM n (min-1)	Feed vf (mm/min)	RPM n (min-1)	Feed vf (mm/min)
6	12,400	840	8,400	570	3,400	260
8	9,200	840	6,300	570	2,400	240
10	7,600	840	5,100	570	2,000	290
12	6,000	840	4,200	570	1,680	260
14	5,200	840	3,600	570	1,400	200
16	4,800	760	3,300	510	1,200	160
18	4,400	720	2,700	420	1,100	150
20	3,600	560	2,400	360	1,000	150
25	3,200	620	2,160	410	900	160

Application tip

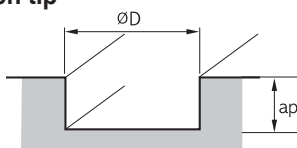

Slotting depth (ap)

- ap: ≤ 0.3D (≤ HRC45)
- ap: ≤ 0.05D (HRC45~55)

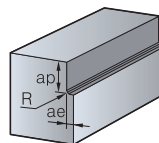

Shouldering depth (ae)

- ae: ≤ 1.0D
- ae: ≤ 0.3D (≤ HRC45)
- ae: ≤ 0.05D (HRC45~55)

* Workpiece should be clamped rigidly. In case of vibrations, reduce R.P.M and feed rate by the same ratio



Recommended cutting conditions (RPE-RG)

* For Carbide

Workpiece Conditions	Alloy steel, Carbon steel (\leq HRC25)		Alloy steel, Carbon steel, Pre-hardened steel (HRC25~HRC40)		Alloy steel, Carbon steel (\leq HRC25)		Alloy steel, Carbon steel, Pre-hardened steel (HRC25~HRC40)	
	RPM n (min-1)	Feed vf (mm/min)	RPM n (min-1)	Feed vf (mm/min)	RPM n (min-1)	Feed vf (mm/min)	RPM n (min-1)	Feed vf (mm/min)
Diameter (ϕ)								
6	12,000	1,240	10,600	880	15,800	2,060	14,300	1,480
8	9,000	1,320	8,100	940	11,900	2,160	10,700	1,560
10	7,200	1,320	6,400	940	9,500	2,160	8,500	1,560
12	6,000	1,230	5,400	910	8,000	2,060	7,100	1,480
14	5,200	1,230	4,750	880	7,000	2,010	6,250	1,440
16	4,500	1,230	4,100	840	6,000	1,960	5,400	1,400
18	4,400	1,150	3,650	780	5,400	1,840	4,850	1,300
20	3,600	1,060	3,200	720	4,800	1,710	4,300	1,200
25	3,200	960	2,800	680	4,400	1,600	3,800	1,120

Application tip

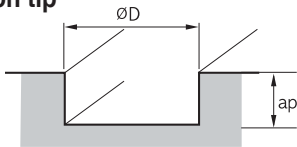

Slotting depth (ap)

- ap: $\leq 1.0D$ (\leq HRC25)
- $\leq 0.8D$ (HRC25~40)

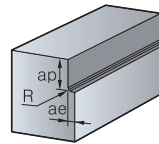

Shouldering depth (ap)

- ap: $\leq 1.0D$
- ae: $\leq 0.5D$ (\leq HRC25)
- $\leq 0.35D$ (HRC25~40)

* Workpiece should be clamped rigidly. In case of vibrations, reduce R.P.M and feed rate by the same ratio

Recommended cutting conditions (RPE-FF, FP, RG)

* For HSS PM

Workpiece Conditions	Alloy steel, Carbon steel, High speed steel		Alloy steel, Carbon steel, High speed steel (\leq HRC20)		Alloy steel, Carbon steel, High speed steel (HRC20~HRC30)		Alloy steel, Carbon steel, High speed steel (HRC30~HRC40)	
	RPM n (min-1)	Feed vf (mm/min)	RPM n (min-1)	Feed vf (mm/min)	RPM n (min-1)	Feed vf (mm/min)	RPM n (min-1)	Feed vf (mm/min)
Diameter (ϕ)								
6	2,700	200	2,100	155	1,500	100	1,250	90
8	2,300	250	1,800	200	1,300	140	1,000	110
10	1,800	360	1,400	275	1,000	170	850	140
12	1,500	360	1,150	290	850	200	700	155
14	1,300	360	1,000	290	720	200	600	155
16	1,150	360	900	290	625	200	520	155
18	1,000	360	850	290	580	200	470	155
20	920	370	720	290	500	200	420	155
22	850	370	620	290	450	200	380	155
25	750	360	570	275	400	190	340	155

Application tip

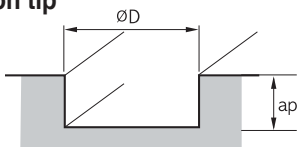

Slotting depth (ap)

- ap: $\leq 0.15D$

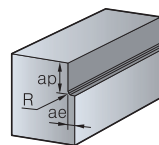

Shouldering depth (ap)

- ap: $\leq 1.5D$ (All dia.)
- ae: $\leq 0.5D$ (All dia.)

* Workpiece should be clamped rigidly. In case of vibrations, reduce R.P.M and feed rate by the same ratio

F Technical Information for R⁺ Endmill

Recommended cutting conditions (RPE-RG)

* For HSS Co

Workpiece Conditions Diameter (Ø)	Alloy steel, Carbon steel, High speed steel		Alloy steel, Carbon steel, High speed steel (≤ HRC20)		Alloy steel, Carbon steel, High speed steel (HRC20~HRC30)		Alloy steel, Carbon steel, High speed steel (HRC30~HRC40)	
	RPM n (min-1)	Feed vf (mm/min)	RPM n (min-1)	Feed vf (mm/min)	RPM n (min-1)	Feed vf (mm/min)	RPM n (min-1)	Feed vf (mm/min)
6	1,800	80	1,600	60	1,200	55	800	30
8	1,400	105	1,100	75	900	65	560	45
10	1,100	150	900	120	800	110	450	60
12	900	180	800	140	630	110	400	70
14	800	180	700	140	560	110	350	70
16	700	180	560	140	450	110	280	70
18	630	180	500	140	400	110	250	70
20	560	180	450	140	400	110	220	70
22	500	220	450	170	350	140	220	70
25	450	220	400	170	310	140	180	85
28	400	210	350	160	280	130	160	85
30	350	210	310	160	250	130	160	85
32	350	210	280	160	220	130	140	85
36	310	210	250	160	200	130	120	85
40	280	200	220	150	180	120	110	80
50	220	200	180	170	160	140	90	80

Application tip

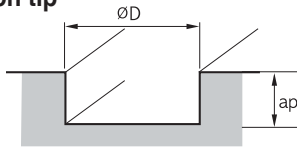

■ Slotting depth (ap)

- ap: ≤ 0.15D

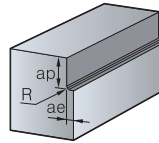

■ Shouldering depth (ap)

- ap: ≤ 1.5D
- ae: ≤ 0.1D

* Workpiece should be clamped rigidly. In case of vibrations, reduce R.P.M and feed rate by the same ratio



RPAE (Wave roughing endmill for Al)

Carbide

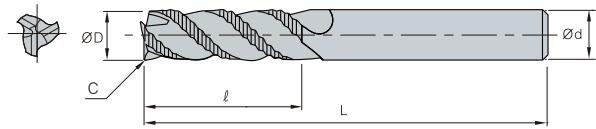

ØD	Tolerance
Ø6 ~ Ø25	0.00 ~ -0.05



(mm)

Designation	ØD	Ød	ℓ	L	C
RPAE					
3060-063	6.0	6	18	63	0.3
3070-063	7.0	8	23	63	0.3
3080-063	8.0	8	23	63	0.3
3090-080	9.0	10	30	80	0.3
3100-080	10.0	10	30	80	0.3
3110-080	11.0	12	32	80	0.5
3120-080	12.0	12	32	80	0.5
3140-080	14.0	14	32	80	0.5
3160-105	16.0	16	48	105	0.5
3180-105	18.0	18	48	105	0.5
3200-105	20.0	20	50	105	0.5
3250-105	25.0	25	50	105	0.5

RPE-FP-H (Fine pitch standard type roughing endmill)

Carbide, High helix angle, irregular flute spacing and lead

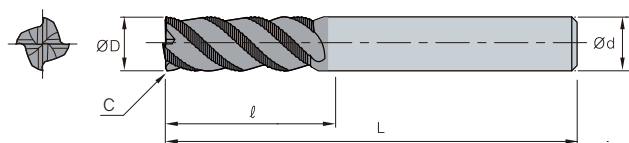

ØD	Tolerance
Ø5 ~ Ø20	0.00 ~ -0.05



(mm)

Designation	ØD	Ød	ℓ	L	C
RPE					
4050-057-FP-H	5.0	6	13	57	0.3
4060-057-FP-H	6.0	6	13	57	0.5
4080-063-FP-H	8.0	8	19	63	0.5
4100-072-FP-H	10.0	10	22	72	0.5
4120-082-FP-H	12.0	12	26	82	0.5
4140-082-FP-H	14.0	16	26	82	0.6
4160-092-FP-H	16.0	16	32	92	0.6
4180-092-FP-H	18.0	20	32	92	0.6
4200-0104-FP-H	20.0	20	38	104	0.6

RPLE-FP-H (Fine pitch long type roughing endmill)

Carbide, High helix angle, irregular flute spacing and lead

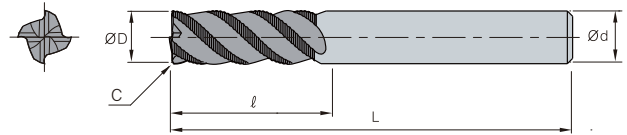

ØD	Tolerance
Ø5 ~ Ø20	0.00 ~ -0.05



(mm)

Designation	ØD	Ød	ℓ	L	C	
RPLE 4	4050-063-FP-H	5.0	6	19	63	0.3
	4060-063-FP-H	6.0	8	19	63	0.5
	4080-072-FP-H	8.0	8	28	72	0.5
	4100-082-FP-H	10.0	10	34	82	0.5
	4120-097-FP-H	12.0	12	40	97	0.5
	4140-097-FP-H	14.0	16	40	97	0.6
	4160-108-FP-H	16.0	16	48	108	0.6
	4180-108-FP-H	18.0	20	48	108	0.6
	4200-122-FP-H	20.0	20	56	122	0.6

RPE-XG (Endmill for finishing and roughing)

Carbide

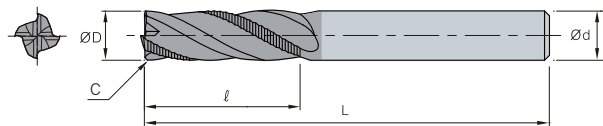

ØD	Tolerance
Ø6 ~ Ø20	0.00 ~ -0.05



(mm)

Designation	ØD	Ød	ℓ	L	C	
RPE 4	4060-052-XG	6.0	6	14	52	0.25
	4070-063-XG	7.0	8	18	63	0.3
	4080-063-XG	8.0	8	18	63	0.3
	4090-080-XG	9.0	10	22	80	0.3
	4100-080-XG	10.0	10	22	80	0.3
	4110-080-XG	11.0	12	26	80	0.4
	4120-080-XG	12.0	12	26	80	0.4
	4140-080-XG	14.0	14	30	80	0.4
	4160-105-XG	16.0	16	34	105	0.6
	4180-105-XG	18.0	18	38	105	0.6
4200-105-XG	20.0	20	42	105	0.6	



RPE-FP-L (Roughing endmill for fine pitches)

Carbide,
irregular flute spacing and lead

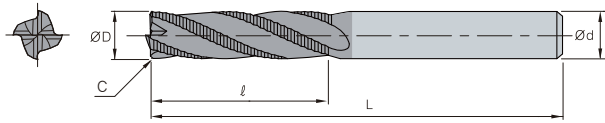

ØD	Tolerance
Ø5 ~ Ø20	0.00 ~ -0.05



(mm)

Designation	ØD	Ød	ℓ	L	C	
RPE 4	4050-060-FP-L	5.0	6	13	60	0.3
	4060-080-FP-L	6.0	8	13	80	0.5
	4080-080-FP-L	8.0	8	19	80	0.5
	4100-080-FP-L	10.0	10	22	80	0.5
	4120-080-FP-L	12.0	12	26	80	0.5
	4140-085-FP-L	14.0	16	26	85	0.6
	4160-100-FP-L	16.0	16	32	100	0.6
	4180-100-FP-L	18.0	20	32	100	0.6
	4200-105-FP-L	20.0	20	38	105	0.6

RPE-RG (Standard roughing endmill)

Carbide

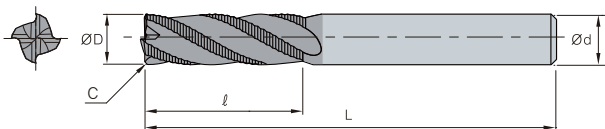

ØD	Tolerance
Ø5 ~ Ø20	0.00 ~ -0.05



(mm)

Designation	ØD	Ød	ℓ	L	C	
RPE 4	4050-050-RG	5.0	6	13	50	0.3
	4060-050-RG	6.0	6	16	50	0.3
	4080-060-RG	8.0	8	20	60	0.3
	4100-075-RG	10.0	10	25	75	0.3
	4120-080-RG	12.0	12	30	80	0.4
	4140-100-RG	14.0	16	35	100	0.6
	4160-100-RG	16.0	16	40	100	0.6
	4180-110-RG	18.0	20	40	110	0.6
	4200-110-RG	20.0	20	45	110	0.6

RPE-RG (4F roughing endmill)

HSS PM

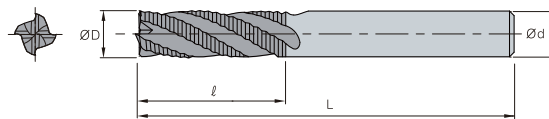

ØD	Tolerance
Ø6 ~ Ø20	±0.1



(mm)

Designation	ØD	Ød	ℓ	L
RPE				
4060-060-RG	6.0	6	20	60
4070-070-RG	7.0	10	20	70
4080-075-RG	8.0	10	25	75
4090-075-RG	9.0	10	30	75
4100-085-RG	10.0	10	35	85
4120-100-RG	12.0	12	40	100
4140-100-RG	14.0	16	40	100
4160-110-RG	16.0	16	50	110
4180-110-RG	18.0	20	50	110
4200-125-RG	20.0	20	60	125

RPE-FF (Roughing endmill for fine pitches)

HSS PM, Irregular flute spacing

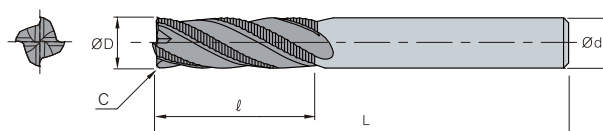

ØD	Tolerance
Ø6 ~ Ø20	±0.1



(mm)

Designation	ØD	Ød	ℓ	L	C
RPE					
4060-060-FF	6.0	6	20	60	0.5
4070-070-FF	7.0	10	20	70	0.5
4080-075-FF	8.0	10	25	75	0.5
4090-075-FF	9.0	10	30	75	0.5
4100-085-FF	10.0	10	35	85	0.5
4120-100-FF	12.0	12	40	100	0.6
4140-100-FF	14.0	12	40	100	0.6
4160-110-FF	16.0	16	50	110	0.6
4180-110-FF	18.0	16	50	110	0.6
4200-125-FF	20.0	20	60	125	0.6



RPE-FP (Roughing endmill for fine pitches)

HSS PM,
irregular flute spacing and lead

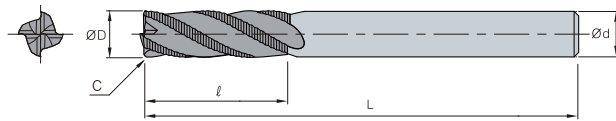

ØD	Tolerance
Ø6 ~ Ø12.0	0.00 ~ -0.05
Ø12.1 ~ Ø20.0	0.00 ~ -0.1



(mm)

Designation		ØD	Ød	ℓ	L	C
RPE	4060-080-FP	6.0	6	13	80	0.5
	4070-080-FP	7.0	10	16	80	0.5
	4080-085-FP	8.0	10	19	85	0.5
	4090-095-FP	9.0	10	19	95	0.5
	4100-100-FP	10.0	10	22	100	0.5
	4120-110-FP	12.0	12	26	110	0.6
	4140-110-FP	14.0	12	26	110	0.6
	4160-125-FP	16.0	16	32	125	0.6
	4180-125-FP	18.0	16	32	125	0.6
	4200-140-FP	20.0	20	38	140	0.6

RPE-RG (Roughing endmill)

HSS

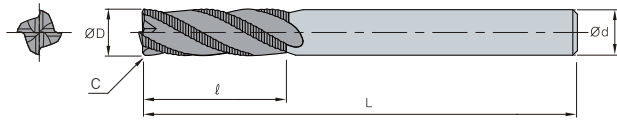

ØD	Tolerance
Ø6 ~ Ø50	±0.1



(mm)

Designation	ØD	Ød	ℓ	L
RPE				
4060-060-RG	6.0	6	15	60
4070-065-RG	7.0	8	20	65
4080-065-RG	8.0	8	20	65
4090-075-RG	9.0	10	25	75
4100-075-RG	10.0	10	25	75
4110-080-RG	11.0	12	30	80
4120-080-RG	12.0	12	30	80
4130-090-RG	13.0	12	35	90
4140-090-RG	14.0	12	35	90
4150-095-RG	15.0	12	40	95
4160-095-RG	16.0	16	40	95
4170-095-RG	17.0	16	40	95
4180-105-RG	18.0	16	40	105
4190-110-RG	19.0	16	45	110
4200-110-RG	20.0	20	45	110
4210-110-RG	21.0	20	45	110
4220-110-RG	22.0	20	45	110
4230-110-RG	23.0	20	45	110
4240-120-RG	24.0	25	50	120
4250-120-RG	25.0	25	50	120
4260-120-RG	26.0	25	50	120
4270-125-RG	27.0	25	55	125
4280-125-RG	28.0	25	55	125
4300-125-RG	30.0	25	55	125
4320-145-RG	32.0	32	60	145
4340-145-RG	34.0	32	60	145
4350-145-RG	35.0	32	60	145
4360-145-RG	36.0	32	60	145
4380-150-RG	38.0	32	65	150
4400-150-RG	40.0	32	65	150
4420-155-RG	42.0	42	65	155
4440-155-RG	44.0	42	65	155
4450-160-RG	45.0	42	70	160
4460-160-RG	46.0	42	70	160
4500-160-RG	50.0	42	70	160



Endmill series for aluminum machining

A⁺ Endmill

- Endmills for rough, medium to finish cutting of aluminum
- Optimized solutions for each application type - A wide selection of tools provided for various machining processes
- Higher machining efficiency - advanced flute design and cutting edge technology applied

Features

APFE

Sharp cutting edges and double relief angles

- Reduced cutting force
- Inhibited tool breakage due to reinforced cutting edges

U-shaped flutes with mirror-like finishing

- Efficient chip evacuation through wide chip pockets
- Inhibited build-up edges due to mirror-like finishing

AFE

Sharp cutting edges

- Long tool life and improved cost efficiency
- Reduced cutting force

Mirror-like flute surface

- Inhibited chip welding
- Reduced cutting force due to less build-up edges

RPAE

Blade design of wave form

- Lower cutting force
- Efficient chip evacuation through chip breaking

Sharp cutting edges

- Lower cutting force
- Reduced loads over equipment

Application examples

- **Workpiece** Jig (A7075)
- **Cutting conditions** vc (m/min) = 200, fz (mm/t) = 0.05
ap (mm) = 8, ae (mm) = 2, wet
- **Tools** APFE3080-060

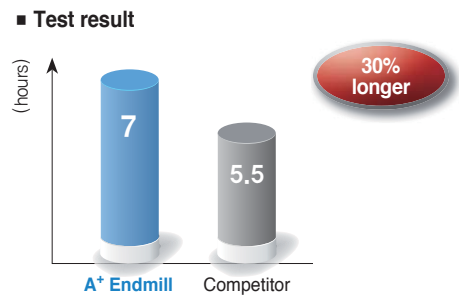
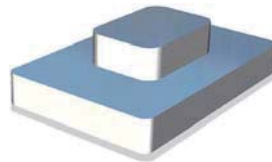

- **Workpiece** Inside milling of smart phones (Al60 series)
- **Cutting conditions** vc (m/min) = 65, fz (mm/t) = 0.02
ap (mm) = 1, ae (mm) = 1, wet
- **Tools** AFE3010-050-V3S6

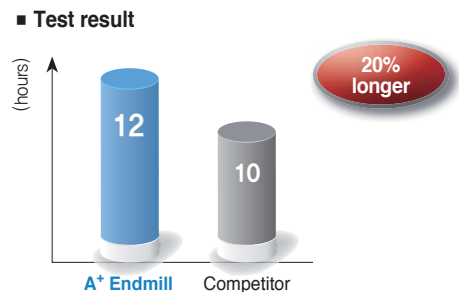

- **Workpiece** Roughing aluminum rectangular tubes (Al70 series)
- **Cutting conditions** vc (m/min) = 330, fz (mm/t) = 0.05
ap (mm) = 15, ae (mm) = 1.5, dry
- **Tools** RPAE3100-080

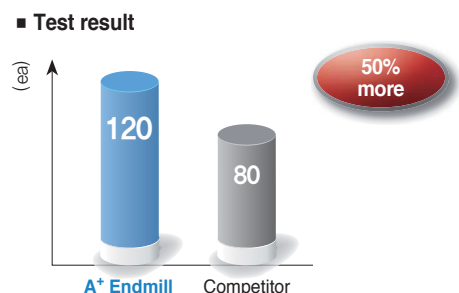

F Technical Information for A⁺ Endmill

Recommended Cutting Conditions (APFE/AFE)

Workpiece Conditions Diameter (Ø)	Shouldering				Slotting			
	Aluminum alloy (A7075)		Aluminum alloy mold (AC4B)		Aluminum alloy (A7075)		Aluminum alloy mold (AC4B)	
	RPM n (min ⁻¹)	Feed vf (mm/min)	RPM n (min ⁻¹)	Feed vf (mm/min)	RPM n (min ⁻¹)	Feed vf (mm/min)	RPM n (min ⁻¹)	Feed vf (mm/min)
1	40,000	480	40,000	368	40,000	368	40,000	280
2	40,000	880	38,000	680	38,000	680	32,000	440
3	32,000	1,120	25,000	760	25,000	760	21,000	480
4	24,000	1,200	19,000	800	19,000	800	13,000	520
5	19,000	1,280	15,000	880	15,000	800	13,000	560
6	16,000	1,520	13,000	960	13,000	880	11,000	600
8	12,000	1,520	9,500	960	9,500	960	8,000	640
10	9,500	1,520	7,600	960	7,600	960	6,400	640
12	8,000	1,520	6,400	960	6,400	960	5,300	640
16	6,000	1,520	4,800	960	4,800	800	4,000	576
20	4,800	1,200	3,800	800	3,800	776	3,200	528

Application tip

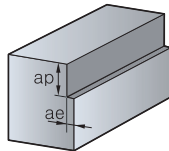

Shouldering depth (ap)

- ap : ≤ 2,0D
- ae : ≤ 0,2D (D < Ø3)
: ≤ 0,5D (D ≥ Ø3)

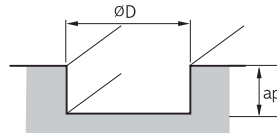

Slotting depth (ap)

- ap : ≤ D (Maximum 12 mm)

* Workpiece should be clamped rigidly. In case of vibrations, reduce R.P.M and feed rate by the same ratio

Recommended Cutting Conditions (RPAE/APRE)

Workpiece Conditions Diameter (Ø)	Shouldering				Slotting			
	Aluminum alloy (A7075)		Aluminum alloy mold (AC4B)		Aluminum alloy (A7075)		Aluminum alloy mold (AC4B)	
	RPM n (min ⁻¹)	Feed vf (mm/min)	RPM n (min ⁻¹)	Feed vf (mm/min)	RPM n (min ⁻¹)	Feed vf (mm/min)	RPM n (min ⁻¹)	Feed vf (mm/min)
4	20,000	8,000	16,000	6,400	15,000	5,000	12,000	4,000
5	16,000	6,500	12,800	5,200	12,000	4,000	9,600	3,200
6	13,500	6,000	10,800	4,800	10,500	3,800	8,400	3,100
8	10,500	4,700	8,400	3,800	8,000	3,000	6,400	2,400
10	8,500	3,800	6,800	3,100	6,500	2,500	5,200	2,000
12	6,800	3,050	5,500	2,500	5,250	2,000	4,200	1,600
14	5,800	2,600	4,700	2,100	4,500	1,700	3,600	1,400
16	5,200	2,350	4,200	1,900	4,000	1,500	3,200	1,200
18	4,700	2,100	3,800	1,700	3,550	1,300	2,900	1,100
20	4,200	1,900	3,400	1,600	3,200	1,200	2,600	1,000
25	3,400	1,500	2,800	1,200	2,550	1,000	2,100	800

Application tip

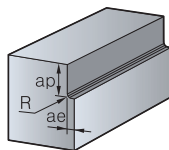

Shouldering depth (ap)

- ap : ≤ 1,5D
- ae : ≤ 0,5D

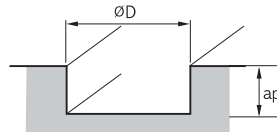

Slotting depth (ap)

- ap : ≤ 1,5D

* Workpiece should be clamped rigidly. In case of vibrations, reduce R.P.M and feed rate by the same ratio



APFE2000/3000 (Flat)

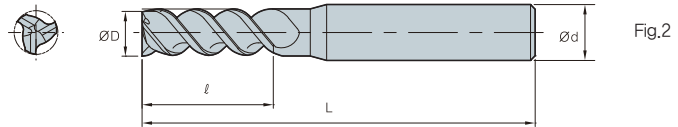
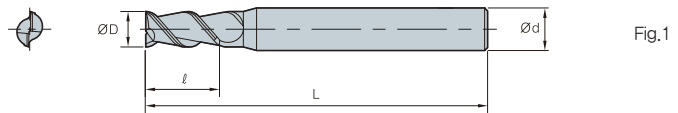

ØD	Tolerance
Ø1 ~ Ø6	-0.00 ~ -0.02
Ø6.1 ~ Ø8	-0.00 ~ -0.025
Ø8.1 ~ Ø20	-0.00 ~ -0.03



(mm)

Designation	ØD	Ød	ℓ	L	Fig.
APFE					
2 2010-050-S6	1	6	3	50	1
2015-050-S6	1.5	6	4	50	1
2020-050-S4	2	4	6	50	1
2025-050	2.5	6	8	50	1
2030-050	3.0	6	9	50	1
2040-050	4.0	6	12	50	1
2050-050	5.0	6	15	50	1
2060-050	6.0	6	18	50	1
2080-060	8.0	8	20	60	1
2100-075	10.0	10	30	75	1
2120-075	12.0	12	32	75	1
2160-100	16.0	16	45	100	1
2200-100	20.0	20	45	100	1
APFE					
3 3010-050-S4	1	4	3	50	2
3015-050-S4	1.5	4	4	50	2
3020-050-S4	2	4	6	50	2
3025-050	2.5	6	8	50	2
3030-050	3.0	6	9	50	2
3040-050	4.0	6	12	50	2
3050-050	5.0	6	15	50	2
3060-050	6.0	6	18	50	2
3080-060	8.0	8	20	60	2
3100-075	10.0	10	30	75	2
3120-075	12.0	12	32	75	2
3160-100	16.0	16	45	100	2
3200-100	20.0	20	45	100	2

APMFE2000/3000 (Middle flat)

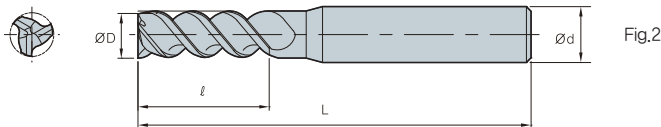
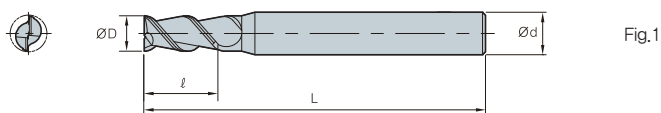

ØD	Tolerance
Ø1 ~ Ø6	0.00 ~ 0.02
Ø6.1 ~ Ø8	0.00 ~ 0.025
Ø8.1 ~ Ø20	0.00 ~ 0.03



(mm)

Designation		ØD	Ød	ℓ	L	Fig.
APMFE 2	2030-060	3.0	6	11	60	1
	2040-060	4.0	6	14	60	1
	2050-060	5.0	6	17	60	1
	2060-065	6.0	6	22	65	1
	2080-065	8.0	8	25	65	1
	2100-080	10.0	10	37	80	1
	2120-080	12.0	12	40	80	1
	2160-110	16.0	16	55	110	1
2200-125	20.0	20	60	125	1	
APMFE 3	3030-060	3.0	6	11	60	2
	3040-060	4.0	6	14	60	2
	3050-060	5.0	6	17	60	2
	3060-065	6.0	6	22	65	2
	3080-065	8.0	8	25	65	2
	3100-080	10.0	10	37	80	2
	3120-080	12.0	12	40	80	2
	3160-110	16.0	16	55	110	2
3200-125	20.0	20	60	125	2	



APLFE2000/3000 (Long flat)

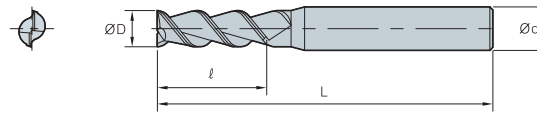

Fig.1

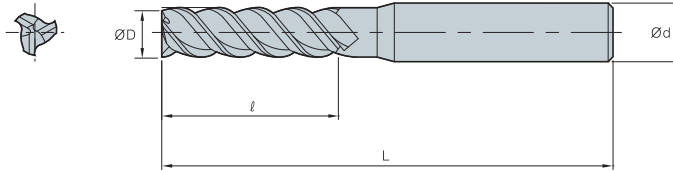

Fig.2



ØD	Tolerance
Ø1 ~ Ø6	0.00 ~ 0.02
Ø6.1 ~ Ø8	0.00 ~ 0.025
Ø8.1 ~ Ø20	0.00 ~ 0.03



(mm)

Designation	ØD	Ød	ℓ	L	Fig.	
APLFE 2	2030-060	3.0	6	12	60	1
	2040-060	4.0	6	16	60	1
	2050-060	5.0	6	20	60	1
	2060-075	6.0	6	25	75	1
	2080-075	8.0	8	32	75	1
	2100-100	10.0	10	45	100	1
	2120-100	12.0	12	45	100	1
	2160-150	16.0	16	65	150	1
	2200-150	20.0	20	75	150	1
APLFE 3	3030-060	3.0	6	12	60	2
	3040-060	4.0	6	16	60	2
	3050-060	5.0	6	20	60	2
	3060-075	6.0	6	25	75	2
	3080-075	8.0	8	32	75	2
	3100-100	10.0	10	45	100	2
	3120-100	12.0	12	45	100	2
	3160-150	16.0	16	65	150	2
	3200-150	20.0	20	75	150	2

APBE2000 (Ball)

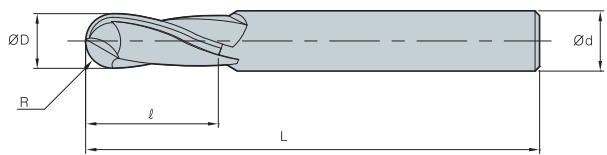

ØD	Tolerance
Ø1 ~ Ø6	0.00 ~ 0.02
Ø6.1 ~ Ø8	0.00 ~ 0.025
Ø8.1 ~ Ø20	0.00 ~ 0.03



(mm)

Designation	ØD	Ød	ℓ	L
APBE				
2010-050	1.0	4	2	50
2015-050	1.5	4	3	50
2020-050	2.0	4	4	50
2025-050	2.5	4	5	50
2030-050	3.0	4	6	50
2035-050	3.5	4	7	50
2040-050	4.0	4	8	50
2045-050	4.5	6	9	50
2050-050	5.0	6	10	50
2055-050	5.5	6	11	50
2060-050	6.0	6	12	50
2080-060	8.0	8	16	60
2100-075	10.0	10	20	75
2120-075	12.0	12	24	75



AFE3000 (Short flat)

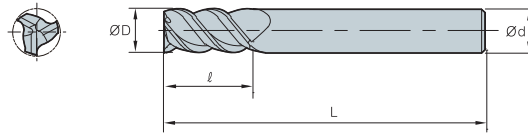

ØD	Tolerance
Ø1 ~ Ø12	0.00 ~ -0.02
Ø12.1 ~ Ø20	0.00 ~ -0.03



(mm)

Designation	ØD	Ød	ℓ	L
AFE				
3010-040-V2S6	1	6	2	40
3010-040-V2.5S6	1	6	2.5	40
3015-040-V3S6	1.5	6	3	40
3020-040-V3S6	2	6	3	40
3030-045-V4S6	3	6	4	45
3030-045-V8S6	3	6	8	45
3040-045-V5S6	4	6	5	45
3040-045-V8S6	4	6	8	45
3040-045-V11S6	4	6	11	45
3050-045-V6S6	5	6	6	45
3060-050-V7S6	6	6	7	50
3060-050-V13S6	6	6	13	50
3080-060-V9S8	8	8	9	60
3080-060-V19S8	8	8	19	60
3100-065-V11S10	10	10	11	65
3100-065-V22S10	10	10	22	65
3120-070-V13S12	12	12	13	70
3120-070-V26S12	12	12	26	70
3160-090-V18S16	16	16	18	90
3160-090-V32S16	16	16	32	90
3200-090-V22S20	20	20	22	90
3200-090-V38S20	20	20	38	90

AFE3000 (Flat)

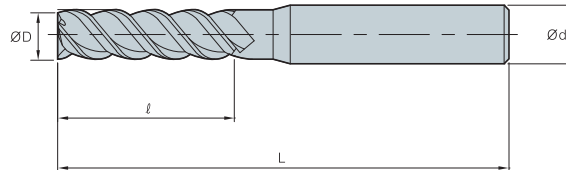

ØD	Tolerance
Ø1 ~ Ø12	0.00 ~ -0.02
Ø12.1 ~ Ø20	0.00 ~ -0.03



(mm)

Designation	ØD	Ød	ℓ	L
AFE				
3010-050-V3S6	1	6	3	50
3015-050-V5S6	1.5	6	5	50
3020-050-V6S6	2	6	6	50
3030-055-V11S6	3	6	11	55
3040-055-V13S6	4	6	13	55
3050-055-V17S6	5	6	17	55
3060-060-V17S6	6	6	17	60
3080-070-V22S8	8	8	22	70
3100-075-V27S10	10	10	27	75
3120-080-V32S12	12	12	32	80
3160-100-V42S16	16	16	42	100
3200-100-V48S20	20	20	48	100



AFE3000 (Long flat)

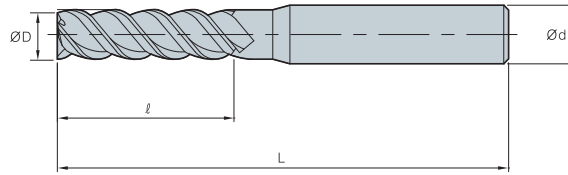

ØD	Tolerance
Ø1 ~ Ø12	0.00 ~ -0.02
Ø12.1 ~ Ø20	0.00 ~ -0.03



(mm)

Designation	ØD	Ød	ℓ	L
AFE 3010-060-V4S6	1	6	4	60
3010-060-V6S6	1	6	6	60
3015-060-V6S6	1.5	6	6	60
3015-060-V8S6	1.5	6	8	60
3015-060-V10S6	1.5	6	10	60
3020-060-V8S6	2	6	8	60
3020-060-V10S6	2	6	10	60
3020-060-V12S6	2	6	12	60
3030-065-V15S6	3	6	15	65
3030-070-V20S6	3	6	20	70
3030-075-V25S6	3	6	25	75
3030-080-V30S6	3	6	30	80
3040-065-V16S6	4	6	16	65
3040-070-V20S6	4	6	20	70
3040-075-V26S6	4	6	26	75
3040-080-V30S6	4	6	30	80
3060-060-V22S6	6	6	22	60
3060-070-V25S6	6	6	25	70
3060-075-V30S6	6	6	30	75
3060-080-V35S6	6	6	35	80
3060-090-V42S6	6	6	42	90
3060-100-V50S6	6	6	50	100
3080-080-V28S8	8	8	28	80
3080-080-V30S8	8	8	30	80
3080-085-V35S8	8	8	35	85
3080-090-V40S8	8	8	40	90
3080-095-V45S8	8	8	45	95
3080-100-V50S8	8	8	50	100
3080-105-V55S8	8	8	55	105
3080-110-V65S8	8	8	65	110

AFE3000 (Long flat)

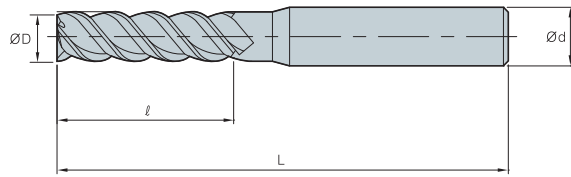

ØD	Tolerance
Ø1 ~ Ø12	0.00 ~ -0.02
Ø12.1 ~ Ø20	0.00 ~ -0.03



(mm)

Designation		ØD	Ød	ℓ	L
AFE	3100-090-V32S10	10	10	32	90
	3100-090-V35S10	10	10	35	90
	3100-090-V40S10	10	10	40	90
	3100-100-V45S10	10	10	45	100
	3100-100-V50S10	10	10	50	100
	3100-110-V55S10	10	10	55	110
	3100-110-V60S10	10	10	60	110
	3100-120-V65S10	10	10	65	120
	3120-095-V40S12	12	12	40	95
	3120-100-V45S12	12	12	45	100
	3120-100-V50S12	12	12	50	100
	3120-110-V55S12	12	12	55	110
	3120-110-V60S12	12	12	60	110
	3120-120-V65S12	12	12	65	120
	3120-120-V70S12	12	12	70	120
	3120-135-V75S12	12	12	75	135
	3160-105-V52S16	16	16	52	105
	3160-110-V55S16	16	16	55	110
	3160-130-V65S16	16	16	65	130
	3160-150-V75S16	16	16	75	150
	3160-160-V85S16	16	16	85	160
	3160-180-V95S16	16	16	95	180
	3160-190-V105S16	16	16	105	190
	3160-200-V115S16	16	16	115	200
	3200-110-V55S20	20	20	55	110
	3200-130-V65S20	20	20	65	130
	3200-150-V75S20	20	20	75	150
	3200-160-V85S20	20	20	85	160
	3200-180-V95S20	20	20	95	180
	3200-190-V105S20	20	20	105	190
	3200-200-V115S20	20	20	115	200
	3200-220-V125S20	20	20	125	220



APRE3000 (Roughing)

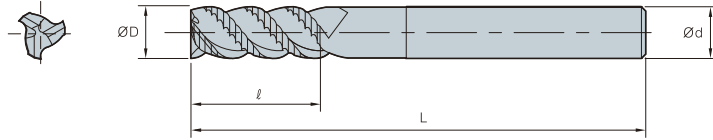

ØD	Tolerance
Ø4 ~ Ø8	0.00 ~ -0.07
Ø8.1 ~ Ø25	0.00 ~ -0.10



(mm)

Designation		ØD	Ød	ℓ	L
APRE	3040-050	4.0	6	8	50
	3050-050	5.0	6	13	50
	3060-050	6.0	6	15	50
	3065-060	6.5	8	16	60
	3070-060	7.0	8	16	60
	3075-060	7.5	8	20	60
	3080-060	8.0	8	20	60
	3085-075	8.5	10	20	75
	3090-075	9.0	10	20	75
	3095-075	9.5	10	22	75
	3100-075	10.0	10	25	75
	3110-075	11.0	12	30	75
	3120-075	12.0	12	30	75
	3130-075	13.0	14	30	75
	3140-075	14.0	16	32	75
	3150-075	15.0	16	32	75
	3160-100	16.0	16	35	100
	3170-100	17.0	20	35	100
	3180-100	18.0	20	35	100
	3200-100	20.0	20	45	100
3250-105	25.0	25	50	105	

RPAE3000 (Wave roughing)

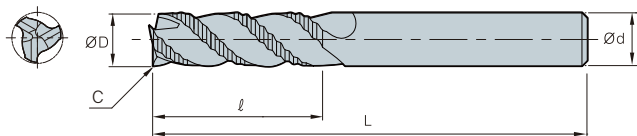

ØD	Tolerance
Ø6 ~ Ø10	0.000 ~ -0.058
Ø10 ~ Ø18	0.000 ~ -0.070
Ø18 ~ Ø25	0.000 ~ -0.084



(mm)

Designation		ØD	Ød	ℓ	L	L
RPAE	3060-063	6.0	6	18	63	0.3
	3070-063	7.0	8	23	63	0.3
	3080-063	8.0	8	23	63	0.3
	3090-080	9.0	10	30	80	0.3
	3100-080	10.0	10	30	80	0.3
	3110-080	11.0	12	32	80	0.5
	3120-080	12.0	12	32	80	0.5
	3140-080	14.0	14	32	80	0.5
	3160-105	16.0	16	48	105	0.5
	3180-105	18.0	18	48	105	0.5
	3200-105	20.0	20	50	105	0.5
	3250-105	25.0	25	50	105	0.5

F Technical Information for PCD Endmill

Longer tool life and good surface finishes

PCD Endmill

- Longer tool life and good surface roughness
- Reducing burrs at non-ferrous metals machining
- 1000 type: Ultra finishing for non-ferrous metals
- 2000 type: Optimal for aluminum alloy, carbon steel, graphite and reinforced Plastic machining



PCD endmill code system

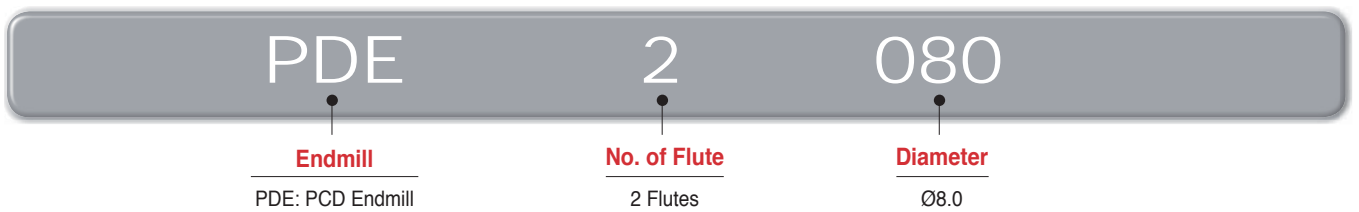

Recommended cutting conditions

Workpiece	vc (m/min)	n (min ⁻¹)	fz (mm/t)
Aluminum alloy, Copper	30~300	2,000~12,000	0.02~0.07
Reinforced plastic	35~300	2,800~16,000	0.04~0.12
Carbon steel, Graphite	10~100	5,300~16,000	0.04~0.2

Special endmill order form

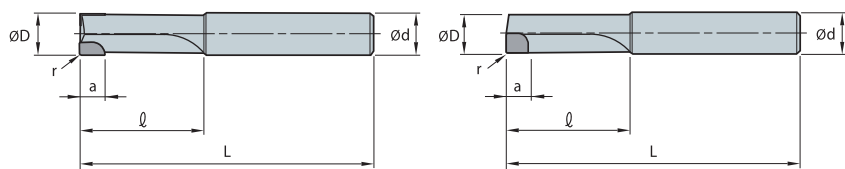

Fig.1

Fig.2

Designation	Fig.	No. of Flute	Dimension (mm)					
			ØD	Ød	r	a	l	L
PDES								

※ Depending on customer requests, we can make special Endmill

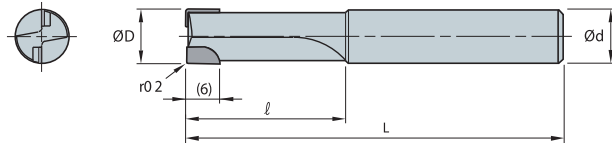

PDE1000/2000 (Flat)

1

2



(mm)

Designation		ØD	Ød	ℓ	L
PDE 1	1040	4	6	15	45
	1050	5	6	15	50
	1060	6	6	20	60
PDE 2	2060	6	8	20	60
	2070	7	8	20	60
	2080	8	8	20	60
	2090	9	10	25	70
	2100	10	10	25	70
	2120	12	12	25	75

F Technical Information for Brazed Endmill

High precision machining with our high stiffness design

Brazed Endmills

- Applicable for high speed machining as it reduced frictional resistance while improving its wear resistance by implementing exclusive substrate and PVD coating
- Long tool life due to absorbing impact through brazed body in heavy interruption
- General steel, alloy steel, mild steel, dice steel, stainless steel, cast iron, ductile cast iron
- ZSEA: Aluminum, Aluminum alloy, Copper, Copper alloy, Non-ferrous materials
- Coating brazed endmills (special) – Guaranteed long tool life due to high new-concept hardness and oxidation resistant coating

Features

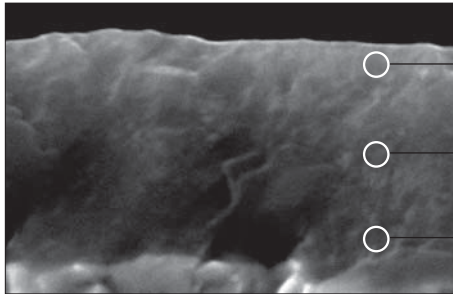

- Top layer
Improvement of hardness and oxidation resistance
- Main layer
Improvement of adhesion and chipping resistance
- Ultra fine substrate

PC221F Coating

Brazed Endmills code system

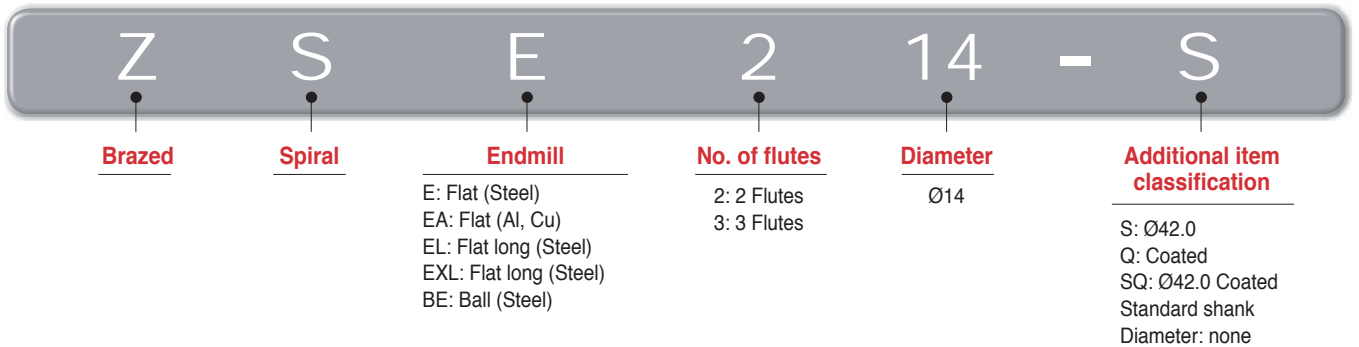

Wear resistance test



Coated ZSE(PC221F)

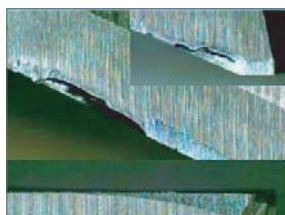

Carbide ZSE

Double tool life



Recommended cutting conditions (ZSE200 Flat)

Workpiece Condition Diameter (Ø)	SM50C,SCM,GC (~HRC30)		STD61,STD11 (HRC30~45)		STD61 (HRC45~55)	
	R.P.M n (min ⁻¹)	Feed vf (mm/min)	R.P.M n (min ⁻¹)	Feed vf (mm/min)	R.P.M n (min ⁻¹)	Feed vf (mm/min)
20	1,600	152	950	88	560	44
25	1,300	136	750	72	450	36
30	1,100	120	650	64	370	32
40	800	96	500	56	280	24
50	650	88	400	48	220	20

Application tip

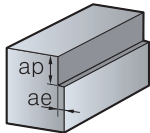

Side milling (under HRC45)

- ap: ≤ 1.5D
- ae: ≤ 0.1D

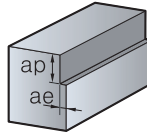

Side milling (over HRC45)

- ap: ≤ 1D (Max: 1 mm)

- ※ Above table based on side milling, when it enters to ae direction, you should apply reduced cutting condition
- ※ When it enters to ae direction, for finishing you should increase revolution speed and feed in the table

Recommended cutting conditions (ZSE400 Flat)

Workpiece Condition Diameter (Ø)	SM50C,SCM,GC (~HRC30)		STD61,STD11 (HRC30~45)		STD61 (HRC45~55)	
	R.P.M n (min ⁻¹)	Feed vf (mm/min)	R.P.M n (min ⁻¹)	Feed vf (mm/min)	R.P.M n (min ⁻¹)	Feed vf (mm/min)
20	1,600	230	950	133	560	66
25	1,300	205	750	109	450	54
30	1,100	180	650	96	370	48
40	800	145	500	85	280	36
50	650	135	400	72	220	30

Application tip

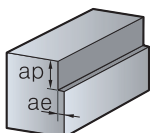

Side milling (under HRC45)

- ap: ≤ 1.5D
- ae: ≤ 0.1D

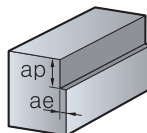

Side milling (over HRC45)

- ap: ≤ 1D (Max: 1 mm)

- ※ Above table based on side milling, when it enters to ae direction, you should apply reduced cutting condition
- ※ When it enters to ae direction, for finishing you should increase revolution speed and feed in the table

ZSE200/300 (Flat)

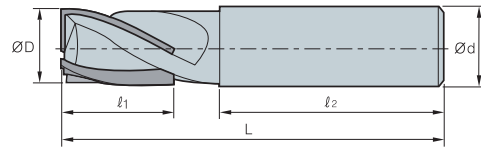
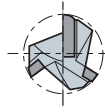

ØD	Tolerance
All	0.00~ -0.05

(mm)

Designation	ØD	Ød	l ₁	l ₂	L
ZSE					
214	14	16	28	57	95
215	15	16	28	57	95
216(Q)	16	16	28	55	95
217	17	20	30	70	115
218	18	20	30	70	115
219	19	20	30	70	115
220(Q)	20	20	30	70	115
221	21	20	35	65	115
222	22	20	35	65	115
223	23	25	35	75	125
224	24	25	35	75	125
225	25	25	35	75	125
226(Q)	26	25	35	75	125
227	27	25	35	75	125
228	28	25	35	75	125
229	29	32	40	95	150
230(Q)	30	32	40	95	150
231	31	32	40	95	150
232	32	32	45	90	150
233	33	32	45	90	150
234	34	32	50	85	150
235	35	32	50	85	150
236	36	32	50	85	150
237	37	32	55	80	150
238	38	32	55	80	150
238S	38	42	55	80	150
240(Q)	40	32	60	75	150
240S	40	42	60	75	150
242	42	32	60	75	150
244	44	32	65	80	160
245	45	32	65	80	160
245S	45	42	65	80	160
247	47	32	65	80	160
248	48	32	65	80	160
248S	48	42	65	80	160
250	50	32	65	80	160
250S	50	42	65	80	160
ZSE					
314	14	16	28	57	95
315	15	16	28	57	95
316	16	16	28	55	95
317	17	20	30	70	115
318	18	20	30	70	115
319	19	20	30	70	115
320	20	20	30	70	115
322	22	20	35	65	115
325	25	25	35	75	125
326	26	25	35	75	125
328	28	25	35	75	125
330	30	32	40	95	150
331	31	32	40	95	150



ZSE300/400/600 (Flat)

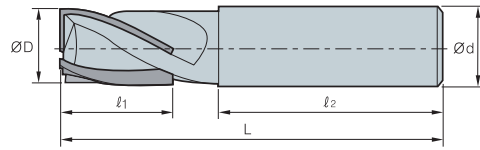
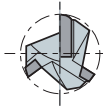

ØD	Tolerance
All	0.00~-0.05

(mm)

Designation		ØD	Ød	ℓ ₁	ℓ ₂	L
ZSE 	332	32	32	45	90	150
	333	33	32	45	90	150
	334	34	32	50	85	150
	335	35	32	50	85	150
	338	38	32	55	80	150
	338S	38	42	55	80	150
	340	40	32	60	75	150
	340S	40	42	60	75	150
	342	42	32	60	75	150
	345	45	32	65	80	160
	345S	45	42	65	80	160
	350	50	32	65	80	160
	350S	50	42	65	80	160
	ZSE 	414	14	16	28	57
415		15	16	28	57	95
416(Q)		16	16	28	55	95
417		17	20	30	70	115
418		18	20	30	70	115
419		19	20	30	70	115
420(Q)		20	20	30	70	115
421		21	20	35	65	115
422		22	20	35	65	115
423		23	25	35	75	125
424		24	25	35	75	125
425(Q)		25	25	35	75	125
426		26	25	35	75	125
427		27	25	35	75	125
428		28	25	35	75	125
429		29	32	40	95	150
430		30	32	40	95	150
432(Q)		32	32	45	90	150
435		35	32	50	80	150
438		38	32	55	85	150
438S		38	42	55	85	150
440(Q)		40	32	60	75	150
440S		40	42	60	75	150
445		45	32	65	80	160
445S		45	42	65	80	160
450		50	32	65	80	160
450S	50	42	65	80	160	
ZSE 	634	34	32	50	85	150
	635	35	32	50	85	150
	638	38	32	55	80	150
	638S	38	42	55	80	150
	640	40	32	60	75	150
	640S	40	42	60	75	150
	645	45	32	65	80	160
	645S	45	42	65	80	160
	650	50	32	65	80	160
	650S	50	42	65	80	160

Special Endmills order: ZSE○○○○○L

Ex.1) 2 flutes, diameter: 6.3, l: 10, L: 60 ZSBE2063 10-60L

Ex.2) 2 flutes, diameter: 6.3, standard type ZSE2063

ZSEA200 (Flat)

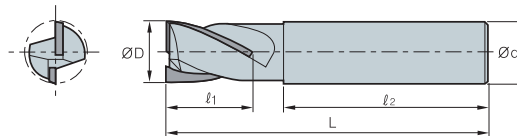

ØD	Tolerance
All	0.00~-0.05

(mm)

Designation	ØD	Ød	l ₁	l ₂	L	
ZSEA	215	15	16	28	57	95
2	216	16	16	28	55	95
	218	18	20	30	70	115
	219	19	20	30	70	115
	220	20	20	30	70	115
	221	21	20	35	65	115
	222	22	20	35	65	115
	223	23	25	35	75	125
	224	24	25	35	75	125
	225	25	25	35	75	125
	228	28	25	35	75	125
	230	30	32	40	95	150
	232	32	32	45	90	150
	238	38	32	55	80	150
	240	40	32	60	75	150
	250	50	32	65	80	160



ZSEL200/400, ZSEXL200 (Long flat)

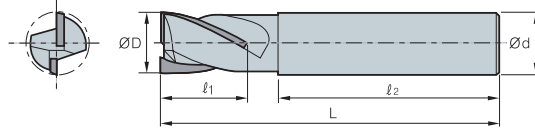

ØD	Tolerance
All	0.00~-0.05

(mm)

Designation		ØD	Ød	ℓ ₁	ℓ ₂	L
ZSEL 	214	14	16	50	55	120
	216	16	16	50	55	120
	218	18	20	60	65	140
	220	20	20	60	65	140
	222	22	20	60	65	140
	225	25	25	70	65	150
	230	30	32	80	85	180
	232	32	32	90	85	190
	235	35	32	100	85	200
	240	40	42	100	105	220
	245	45	42	120	95	230
	250	50	42	120	95	230
	ZSEL 	416	16	16	50	55
420		20	20	60	65	140
425		25	25	70	65	150
430		30	32	80	85	180
435		35	32	100	85	200
440		40	42	100	105	220
ZSEXL 		220	20	20	120	65
	222	22	20	120	65	200
	225	25	25	140	65	220

ZSBE200 (Ball)

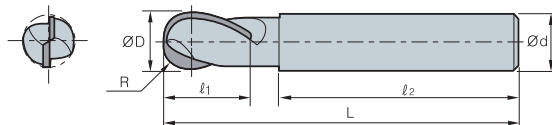

ØD	Tolerance
All	0.00~ -0.05

(mm)

Designation	R	ØD	Ød	ℓ ₁	ℓ ₂	L
ZSBE 213	6.5	13	16	30	60	100
214	7	14	16	30	65	100
215	7.5	15	16	35	55	100
216Q	8	16	16	35	55	100
217	8.5	17	20	35	65	110
218	9	18	20	35	65	110
219	9.5	19	20	35	65	110
220Q	10	20	20	35	65	110
221	10.5	21	20	35	65	110
222	11	22	20	35	65	110
223	11.5	23	25	40	65	120
224	12	24	25	40	70	120
225	12.5	25	25	40	70	120
230	15	30	32	40	70	130
231	15.5	31	32	40	80	130
232	16	32	32	50	75	140
233	16.5	33	32	50	75	140
234	17	34	32	50	85	150
235	17.5	35	32	50	85	150
235S	17.5	35	42	50	85	150
236	18	36	32	50	85	150
236S	18	36	42	50	85	150
237	18.5	37	32	50	95	160
237S	18.5	37	42	50	95	160
238	19	38	32	50	95	160
238S	19	38	42	50	95	160
239	19.5	39	32	50	95	160
239S	19.5	39	42	50	95	160
240	20	40	32	50	95	160
240S	20	40	42	50	95	160
245	22.5	45	32	50	105	170
245S	22.5	45	42	50	105	170
250	25	50	32	50	105	170
250S	25	50	42	50	105	170

• ZSBE200

Special Endmills order: ZSBE200-I-L

Ex.1) 2 flutes diameter: 6.3, l: 10 L: 60 ZSBE 206310-60L

Ex.2) 2 flutes, diameter: 6.3, standard type ZSBE2063

• ZSEA200

Special Endmills order : ZSEA200-I-L

Ex.1) 2 flutes, diameter: 16.3, l: 28, L: 95 ZSEA2163 28-95L

Ex.2) 2 flutes, diameter: 17.0, standard type ZSEA2170

• ZSEL200/400, ZSEXL200

Special Endmills order: ZSEL200-I-L



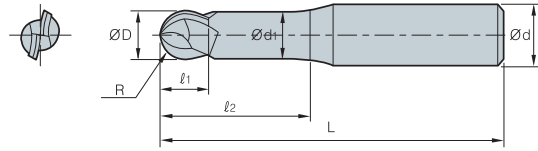

Designation	Flute	R	ØD	Ød	Ød ₁	l ₁	l ₂	L

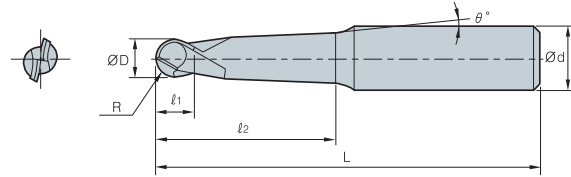

Designation	Flute	R	ØD	Ød	l ₁	l ₂	L	θ°

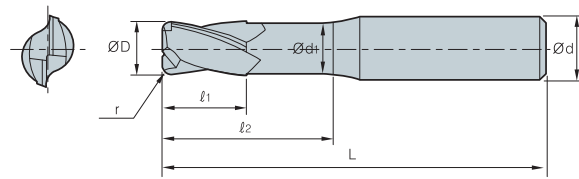

Designation	Flute	ØD	Ød	Ød ₁	r	l ₁	l ₂	L

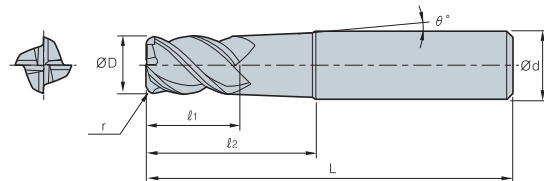

Designation	Flute	ØD	r	Ød	l ₁	l ₂	L	θ°

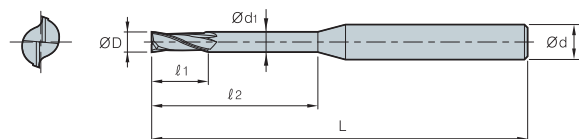

Designation	Flute	ØD	Ød	Ød ₁	l ₁	l ₂	L



G

DRILL

Korloy drills provide a total solution for hole making, based on tooling know-how as well as extensive research and development for our tools.



Technical Information for Drills

- G02 KORLOY Drills
- G04 Available Insert

Indexable Drills











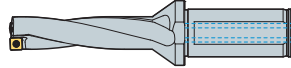
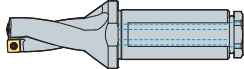

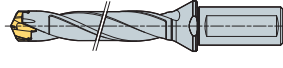

- G06 Technical Information for King Drill
- G12 King Drill
- G21 Technical information of King Drill
(for through coolant system with a lathe)
- G22 King Drill (for through coolant system with a lathe)
- G25 Technical Information for King Drill
(for large diameter drilling)
- G26 King Drill (for large diameter drilling)
- G27 Technical Information for TPDC
- G31 TPDC
- G34 Technical Information for TPDB Plus
- G38 TPDB Plus
- G44 Technical Information for TPDB-H
- G47 TPDB-H
- G51 Technical Information for WPDC
- G54 Center Drill
- G55 WPDC

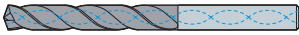
Solid Drills













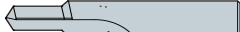

- G57 Technical Information for Mach Solid Drill Plus
- G59 Mach Solid Drill Plus
- G64 Technical Information for Mach Solid Drill Plus-S
- G66 Mach Solid Drill Plus-S
- G70 Technical Information for Mach Solid Drill plus CFRP
- G72 Mach Solid Drill Plus CFRP
- G73 Technical Information for Mach Solid Flat Drill
- G76 Mach Solid Flat Drill
- G82 Technical Information for Mach long Drill Plus
- G84 Mach long Drill Plus
- G87 Mach step Drills Order Form
- G88 Technical Information for Vulcan Drill
- G89 Vulcan Drill
- G91 Technical Information for ESD Plus
- G93 ESD Plus
- G98 Technical Information for Carbide Drill (SSDP)
- G99 Carbide Drill (SSDP)
- G101 Burnishing Drill
- G102 Top Solid Drill
- G103 PCD Drill
- G104 Technical Information for Gun Drill
- G108 Gun Drill

Reamer

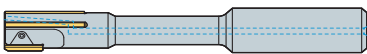
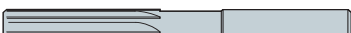
- G110 Technical Information for Indexable Reamer
- G113 Indexable Reamer
- G116 Chucking/Machine Reamer
- G119 PCD Reamer
- G120 Cermet Reamer
- G121 Broach Reamer

Type	Designation		Shape	Drills dia.	Aspect ratio	Page
Indexable Drills	King Drill	K□D	 Available insert: SP□T, XO□T	Ø12.0~Ø60.5	2D~5D	G12 ~ G20
	King Drill HP	K□D..HP	 Available insert: SP□T, XO□T	Ø12.0~Ø60.5	2D~4D	G22 ~ G24
	King Drill (for large diameter drilling)	K□D	 Available insert: SP□T, XO□T	Ø61.0~Ø100.0	2D~4D	G26
	TPDC <small>new</small>	TPDC	 Available insert: TPD□□□□CP	Ø12.0~Ø30.9	3D~12D	G32 ~ G33
	TPDB Plus <small>new</small>	TPDB-P	 Available insert: TPD□□□B	Ø10.0~Ø32.9	3D~12D	G39 ~ G43
	TPDB-H <small>new</small>	TPDB-H	 Available insert: TPD□□□B-H	Ø14.0~Ø30.4	3D~8D	G48 ~ G50
	Indexable Drills & Drill with center	WPDC	 Available insert: WC□T	Ø25.0~Ø80.0	5D~8D	G55 ~ G56
Solid Drills	Mach Solid Drill Plus <small>new</small>	MSDP		Ø1.0~Ø20.0	3D~7D	G59 ~ G63
		MSDPH		Ø2.5~Ø20.0	3D~7D	G60 ~ G63
	Mach Solid Drill Plus-S <small>new</small>	MSDPH-S		Ø3.0~Ø16.0	3D~5D	G66 ~ G69
	Mach Solid Drill Plus CFRP <small>new</small>	MSDP-C		Ø3.0~Ø12.7	5D	G72
	Mach Solid Flat Drill <small>new</small>	MSFD		Ø2.5~Ø16.0	2D	G76 ~ G78
		MSFDH		Ø2.5~Ø16.0	3D	G79 ~ G81
	Mach Long Drill Plus <small>new</small>	MLD□□□□N		Ø3.0~Ø10.0	10D~25D	G84 ~ G86
	Vulcan Drill	VZD		Ø12.6~Ø40.5	-	G89 ~ G90
	ESD Plus <small>new</small>	ESDP		Ø1.0~Ø20.0	3D~7D	G93 ~ G97









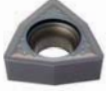
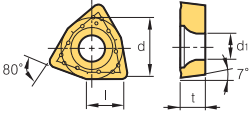

Type	Designation		Shape	Drills dia.	Aspect ratio	Page
Solid Drills	Carbide Drill <small>new</small>	SSDP		Ø1.0~Ø15.0	-	G99 ~ G100
	Burnishing Drill	BDS		Ø4.0~Ø16.0	5D~7D	G101
		BDT		Ø4.2~Ø10.3	2D~4D	G101
	Top solid Drill	TSDM		Ø8.0~Ø25.0	5D~8D	G102
	PCD Drill	PDD		Ø5.0~Ø12.0	5D	G103
	Gun Drill	KGDS		Ø2.0~Ø33.0	50D~100D	G108
		KGDT		Ø6.0~Ø26.5	50D~100D	G109
	Reamer	Indexable Reamer	IRT	 Available Insert: RI	Ø10.0~Ø31.0	3D~5D
IRB			 Available Insert: RI	Ø10.0~Ø31.0	3D~5D	G115
Chucking/Machine Reamer		SCRS		Ø5.0~Ø20.0	2D~3D	G117
		SCRH		Ø5.0~Ø20.0	2D~3D	G117
		TCRS		Ø7.0~Ø30.0	2D~3D	G118
		TMRS		Ø7.0~Ø30.0	3D~5D	G118
PCD Reamer		PDR		Ø5.0~Ø20.0	3D~5D	G119
Cermet Reamer		KCR		Ø6.0~Ø30.0	3D~7D	G120
Broach Reamer		HBRE		Ø3.0~Ø25.0	3D~7D	G121

Available insert

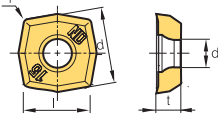
Picture	Designation	Coated								Uncoated	Dimensions (mm)					Configuration	Page
		NC5330	NCM535	PC3700	PC5335	PC9530	PC6510	PC5300	PC5400		H01	l	d	t	r		
 SPET-ND	040204-ND									●	4.7	-	2.4	0.4	2.3		G12 ~ G26
	050204-ND									●	5.1	-	2.4	0.4	2.3		
	060205-ND									●	6.2	-	2.5	0.5	2.5		
	07T208-ND									●	7.5	-	2.8	0.7	2.8		
	090308-ND									●	9.2	-	3.3	0.8	3.4		
	11T308-ND									●	11.0	-	4.0	0.8	4.0		
	130410-ND									●	13.0	-	4.5	1.0	4.5		
	15M510-ND									●	15.2	-	5.0	1.0	5.5		
	180510-ND									●	18.2	-	5.5	1.0	6.0		
 SPMT-LD	060205-LD				●						6.2	-	2.5	0.5	2.5		G12 ~ G26
	07T208-LD				●						7.5	-	2.8	0.7	2.8		
	090308-LD				●						9.2	-	3.3	0.8	3.4		
	11T308-LD				●						11.0	-	4.0	0.8	4.0		
	130410-LD				●						13.0	-	4.5	1.0	4.5		
	15M510-LD				●						15.2	-	5.0	1.0	5.5		
	180510-LD				●						18.2	-	5.5	1.0	6.0		
 SPMT-PD	040204-PD	●	●					●	●		4.7	-	2.4	0.4	2.3		G12 ~ G26
	050204-PD	●	●					●	●		5.1	-	2.4	0.4	2.3		
	060205-PD	●	●					●	●		6.2	-	2.5	0.5	2.5		
	07T208-PD	●	●					●	●		7.5	-	2.8	0.7	2.8		
	090308-PD	●	●					●	●		9.2	-	3.3	0.8	3.4		
	11T308-PD	●	●					●	●		11.0	-	4.0	0.8	4.0		
	130410-PD	●	●					●	●		13.0	-	4.5	1.0	4.5		
	15M510-PD	●	●					●	●		15.2	-	5.0	1.0	5.5		
	180510-PD	●	●					●	●		18.2	-	5.5	1.0	6.0		
 WCMT-C20N	030208-C20N				●						3.8	5.56	2.38	0.8	2.8		-
	040208-C20N				●						4.3	6.35	2.38	0.8	3.0		
	050308-C20N				●						5.4	7.94	3.18	0.8	3.4		
	06T308-C20N				●						6.5	9.525	3.97	0.8	3.7		
	080408-C20N				●						8.7	12.7	4.76	0.8	4.3		
	080412-C20N				●						8.7	12.7	4.76	1.2	4.3		

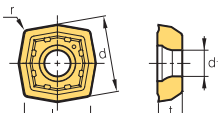
●: Stock Item

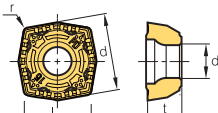
Available insert

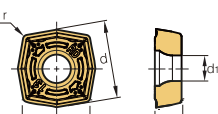
Picture	Designation	Coated								Uncoated HD1	Dimensions (mm)					Configuration	Page
		NC5330	NCM535	PC3700	PC5335	PC9530	PC6510	PC5300	PC5400		l	d	t	r	d ₁		
	030204-C21N				●						3.8	5.56	2.38	0.4	2.55		G55 G56
	040204-C21N				●						4.3	6.35	2.38	0.4	2.8		
	040208-C21N				●						4.3	6.35	2.38	0.8	2.8		
	050308-C21N				●						5.4	7.94	3.18	0.8	3.4		
	06T308-C21N				●						6.5	9.525	3.97	0.8	4.4		
	080408-C21N				●						8.7	12.7	4.76	0.8	5.5		
	040204-ND								●		4.3	4.9	2.4	0.4	2.3		G12 ~ G26
	050204-ND								●		4.8	5.4	2.4	0.4	2.3		
	060204-ND								●		5.8	6.6	2.5	0.4	2.5		
	07T205-ND								●		6.9	7.8	2.8	0.5	2.8		
	090305-ND								●		8.4	9.6	3.3	0.5	3.4		
	11T306-ND								●		10.0	11.4	4.0	0.6	4.0		
	130406-ND								●		11.9	13.6	4.5	0.6	4.5		
	15M508-ND								●		13.9	15.9	5.0	0.8	5.5		
180508-ND								●		16.5	18.9	5.5	0.8	6.0			
	060204-LD				●						5.8	6.6	2.5	0.4	2.5		G12 ~ G26
	07T205-LD				●						6.9	7.8	2.8	0.5	2.8		
	090305-LD				●						8.4	9.6	3.3	0.5	3.4		
	11T306-LD				●						10.0	11.4	4.0	0.6	4.0		
	130406-LD				●						11.9	13.6	4.5	0.6	4.5		
	15M508-LD				●						13.9	15.9	5.0	0.8	5.5		
	180508-LD				●						16.5	18.9	5.5	0.8	6.0		
	040204-PD								●		4.3	4.9	2.4	0.4	2.3		G12 ~ G26
	050204-PD								●		4.8	5.4	2.4	0.4	2.3		
	060204-PD								●		5.8	6.6	2.5	0.4	2.5		
	07T205-PD								●		6.9	7.8	2.8	0.5	2.8		
	090305-PD								●		8.4	9.6	3.3	0.5	3.4		
	11T306-PD								●		10.0	11.4	4.0	0.6	4.0		
	130406-PD								●		11.9	13.6	4.5	0.6	4.5		
	15M508-PD								●		13.9	15.9	5.0	0.8	5.5		
	180508-PD								●		16.5	18.9	5.5	0.8	6.0		
	07T207-RD								●		6.9	7.8	2.8	0.7	2.8		G12 ~ G26
	090308-RD								●		8.4	9.6	3.3	0.8	3.4		
	11T309-RD								●		10.0	11.4	4.0	0.9	4.0		
	130410-RD								●		11.9	13.6	4.5	1.0	4.5		
	15M511-RD								●		13.9	15.9	5.0	1.1	5.5		
	180512-RD								●		16.5	18.9	5.5	1.2	6.0		

● : Stock Item



G Technical Information for King Drill

Optimized insert design for maximum drilling efficiency

King Drill

Code system of holder

K	5D	200	25	□	-	07
KING/KORLOY	Aspect ratio (L/D) 2D, 3D, 4D, 5D	Drill Dia. Ø20.0 (One decimal place marked)	Shank Dia Ø20, Ø25 Ø32, Ø40	Shank shape		Inscribed circle of insert 04, 05, 06, 07, 09 11 13, 15, 18
				No mark: Flange Shank, Weldone HP: Flange Shank, Weldon, PT Tap F1: Flange Shank, Whistle Notch F2: Flange Shank, Without Side Lock S: Straight Shank, Weldone S1: Straight Shank, Whistle Notch S2: Straight Shank, Without Side Lock M0, M1, M2, M3...: MT0, MT1, MT2, MT3... H63, H100: HSK63, HSK100 B30, B40, B50: BT30, BT40, BT50		

Features

- Optimized design of inserts for maximum drilling efficiency
- Excellent cutting performance and chip control due to the optimized geometry and chip breaker of both inserts, central & peripheral
- Different inserts, optimized for the central and peripheral insert locations in order to maximize cutting tool life

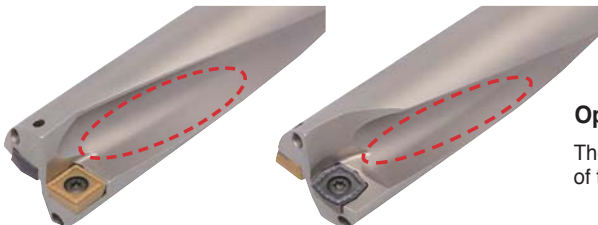

Optimized flute system - 2 coolant holes applied

The optimized shape of the flute increases the rigidity of the drill body and improves chip evacuation

Features of chip breaker

Chip breaker	PD		LD		ND		RD	
Features	- Universal - At medium speed and medium feed		- Superior chip control for machining mild steel and stainless steel - Light cutting (at low ~ medium speed and low feed)		- Sharp cutting edge for aluminum machining - Insert surface buffed for high quality result - E Class Tolerance		- Improved chipping resistance - Excellent performance in case of frequent fracture and chipping on the cutting edge	
Insert	Peripheral insert	Central insert	Peripheral insert	Central insert	Peripheral insert	Central insert	Central insert	
Shape								
Grades for workpiece	NC5330: P, M, K PC3500: P PC5300: P, M, K, S PC6510: K		PC5300: P, M, K, S		PC5335: P, M		H01: N	PC5300: P, M, K, S



Application examples

- **Use** Track link bush
- **Workpiece** SM45C
- **Cutting conditions** vc (m/min) = 120, fn (mm/rev) = 0.1
Through coolant system
- **Tools** **inserts** SPMT07T208-PD (PC3500)
XOMT07T205-PD (PC5300)
Holder K5D20025-07
- **Machine** Drilling machine

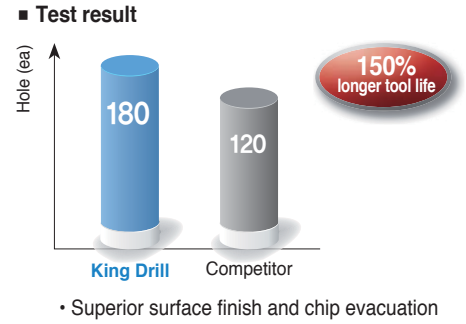

- **Use** Track link bush
- **Workpiece** SCM415H
- **Cutting conditions** King Drill: vc (m/min) = 140, fn (mm/rev) = 0.12
Competitor: vc (m/min) = 125, fn (mm/rev) = 0.1
- **Tools** **inserts** SPMT090308-PD (PC3500)
XOMT090305-PD (PC5300)
Holder K3D27032-09
- **Machine** MCT

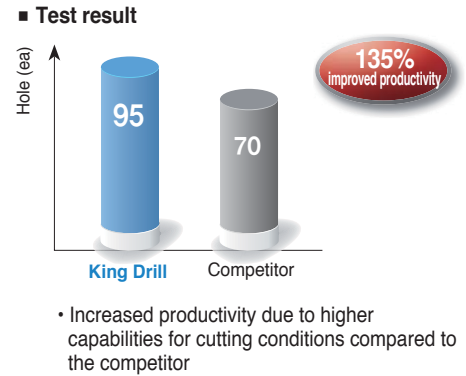

Recommended cutting condition

Workpiece		Insert		vc (m/min)	Aspect ratio (L/D) = 2D, 3D, 4D							
ISO	Workpiece	Hardness (HB)	Chip breaker		Grade		Feed rate (mm/rev) per drill dia. (mm)					
					Central	Peripheral	Ø12~Ø16	Ø17~Ø23	Ø24~Ø29	Ø30~Ø42	Ø43~Ø60	
P	Carbon steel	80~180	LD	PC5335	PC5335	120 (60~170)						
			PD/RD	PC5300	PC3500	150 (120~180)	0.04~0.08	0.04~0.08	0.04~0.08	0.04~0.08	0.04~0.08	
					NC5330	180 (140~220)						
	High carbon steel	180~280	PD	PC5300	PC3500	120 (90~150)	0.04~0.10	0.04~0.12	0.05~0.16	0.06~0.16	0.06~0.18	
					NC5330	150 (110~190)	0.04~0.06	0.04~0.07	0.04~0.08	0.04~0.08	0.04~0.08	
						180 (140~190)						
Alloy steel	Low alloy steel	140~260	LD	PC5335	PC5335	120 (60~160)	0.06~0.10	0.06~0.10	0.06~0.12	0.06~0.14	0.06~0.14	
			PD	PC5300	PC3500	150 (120~170)	0.06~0.12	0.06~0.12	0.06~0.14	0.06~0.16	0.06~0.16	
	Hardened low alloy steel	200~400	PD	PC5300	PC5300	100 (50~150)	0.04~0.10	0.06~0.10	0.06~0.12	0.06~0.14	0.06~0.14	
					PC3500	100 (50~160)	0.05~0.11	0.05~0.11	0.05~0.13	0.05~0.15	0.05~0.15	
					70 (30~120)	0.04~0.08	0.06~0.08	0.06~0.10	0.06~0.12	0.06~0.12		
High alloy steel	260~320	PD	PC5300	PC3500	100 (50~160)	0.05~0.11	0.05~0.11	0.05~0.13	0.05~0.15	0.05~0.15		
				70 (30~120)	0.04~0.08	0.06~0.08	0.06~0.10	0.06~0.12	0.06~0.12			
Hardened high alloy steel	300~450	PD	PC5300	PC5300	100 (50~160)	0.05~0.11	0.05~0.11	0.05~0.13	0.05~0.15	0.05~0.15		
				70 (30~120)	0.04~0.08	0.06~0.08	0.06~0.10	0.06~0.12	0.06~0.12			
M	Stainless steel	135-275	LD	PD5335	PC5335	120 (80~140)	0.04~0.07	0.04~0.07	0.04~0.07	0.04~0.08	0.04~0.08	
			PD	PC5300	PC5300	130 (100~160)	0.04~0.07	0.04~0.07	0.04~0.07	0.04~0.08	0.04~0.08	
K	Cast iron	Gray cast iron	150~230	PD	PC5300	PC6510	190 (150~250)	0.04~0.12	0.05~0.14	0.06~0.18	0.10~0.22	0.10~0.26
		Ductile cast iron	150~230	PD	PC5300	PC6510	130 (100~160)	0.04~0.07	0.04~0.08	0.04~0.10	0.05~0.12	0.05~0.12
S	Heat resisting alloy	Ni-heat resisting alloy	130~400	PD	PC5300	PC5300	50 (30~100)	0.04~0.10	0.04~0.10	0.04~0.10	0.04~0.10	0.04~0.10
		Ti-heat resisting alloy	130~400	LD	PC5335	PC5335	60 (40~80)	0.04~0.08	0.04~0.10	0.06~0.12	0.06~0.14	0.06~0.16
				PD	PC5300	PC5300	60 (40~80)	0.04~0.08	0.04~0.10	0.06~0.12	0.06~0.14	0.06~0.16
		High hardened steel	over 400	PD	PC5300	PC5300	40 (20~80)	0.04~0.05	0.04~0.06	0.04~0.08	0.04~0.08	0.04~0.08
N	Aluminium	Aluminium	30~150	ND	H01	H01	300 (250~400)	0.05~0.14	0.06~0.16	0.10~0.20	0.10~0.22	0.12~0.25
		Alloyed copper	150-160	ND	H01	H01	250 (200~300)	0.05~0.14	0.06~0.16	0.10~0.20	0.10~0.22	0.12~0.25

- The Max. feed of 5D holders is 70%~80% of the max. conditions of 2D/3D/4D holders
- In interrupted machining part, reduce 30~50% of feed from the above machining around interrupted part

Required cutting power

- The graphs below show the cutting force required in drilling
- Machining with the King Drill and a machine with high rigidity and power

■ **Workpiece** SCM440 (240HB)

■ **Cutting conditions** vc (m/min) = 100, Through coolant system

fn (mm/rev) = 0.13 fn (mm/rev) = 0.10 fn (mm/rev) = 0.07

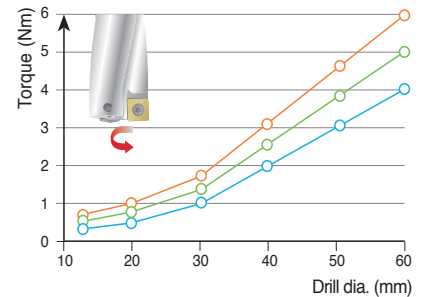
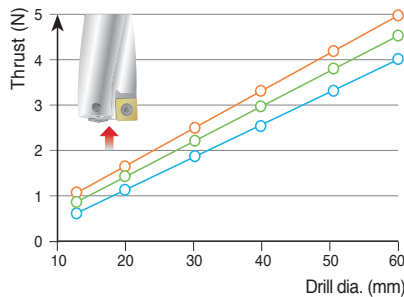
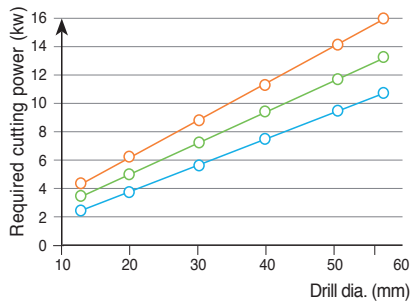

Cutting oil quantity

■ **Workpiece** SCM440 (240HB)

■ **Cutting conditions** vc (m/min) = 100, Through coolant system

- The data of the graph above could be changed depending on workpiece and cutting condition

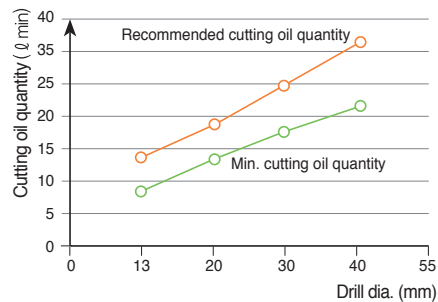

Drill tolerance and hole tolerance

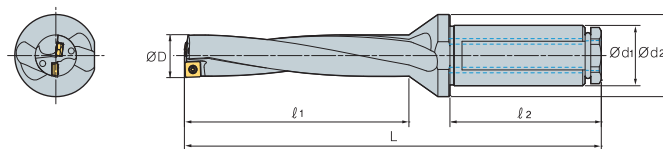

(mm)

Drill dia.		Ø12~Ø29	Ø30~Ø45	Ø46~Ø60.5
2D~3D	Drill tolerance (ØD)	0~-0.15	0~-0.15	0~-0.15
	Hole tolerance	+0.2~-0.1	+0.25~-0.1	+0.28~-0.1
4D~5D	Drill tolerance (ØD)	0~-0.15	0~-0.15	0~-0.15
	Hole tolerance	+0.25~-0.05	+0.3~-0.05	+0.33~-0.05

Notice for setting the drill in the lathe

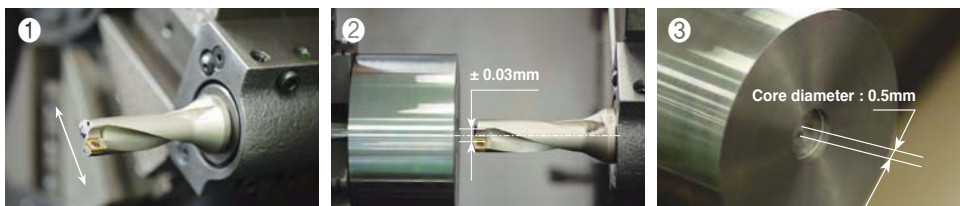

- Set the peripheral insert parallel to the X axis. (based on the side lock)
- If the machined core is 0.5 mm after machining 5 mm, that is the proper setting
- ※ Please make sure that the location of the side lock could be different depending on manufacturers of machine

◀ Range of adjusting machining diameter in the lathe

- In machining in the lathe, the King Drill can extend and reduce the machining diameter by adjusting the x-axis. Please refer to the table showing the range of adjusting drilling diameter below
- The more the drilling diameter is extended or reduced, the more the drill loses drilling balance. In this case, reduce the feed or cutting speed in machining
- Reducing the machining diameter excessively could damage the holder

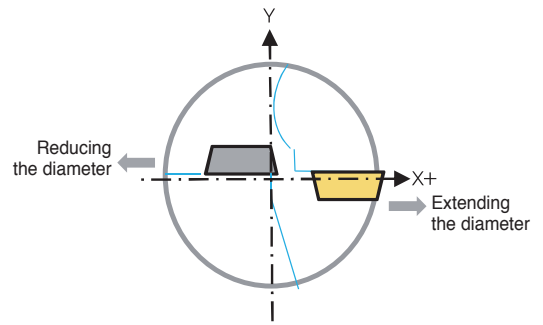

Drill dia. (Ø)	Range of adjusting drilling diameter (Ø)	Drill dia. (Ø)	Range of adjusting drilling diameter (Ø)	Drill dia. (Ø)	Range of adjusting drilling diameter (Ø)	Drill dia. (Ø)	Range of adjusting drilling diameter (Ø)
12.0	11.7~12.4	24.5	23.9~25.1	37.0	36.3~37.7	49.5	48.7~50.2
12.5	12.2~12.9	25.0	24.4~25.6	37.5	36.8~38.2	50.0	49.2~50.7
13.0	12.7~13.4	25.5	24.9~26.1	38.0	37.3~38.7	50.5	49.7~51.2
13.5	13.2~13.9	26.0	25.4~26.6	38.5	37.8~39.2	51.0	50.2~51.7
14.0	13.6~14.5	26.5	25.9~27.1	39.0	38.3~39.7	51.5	50.7~52.2
14.5	14.1~15.0	27.0	26.4~27.6	39.5	38.8~40.2	52.0	51.2~52.7
15.0	14.6~15.5	27.5	26.9~28.1	40.0	39.3~40.7	52.5	51.7~53.2
15.5	15.1~16.0	27.8	27.4~28.6	40.5	39.8~41.2	53.0	52.2~53.7
16.0	15.6~16.5	28.5	27.9~29.1	41.0	40.3~41.7	53.5	52.7~54.2
16.5	16.0~17.0	29.0	28.4~29.6	41.5	40.8~42.2	54.0	53.2~54.7
17.0	16.5~17.5	29.5	28.9~30.1	42.0	41.3~42.7	54.5	53.7~55.2
17.5	17.0~18.0	30.0	29.3~30.7	42.5	41.8~43.2	55.0	54.2~55.7
18.0	17.5~18.5	30.5	29.8~31.2	43.0	42.2~43.7	55.5	54.7~56.2
18.5	18.0~19.0	31.0	30.3~31.7	43.5	42.7~44.2	56.0	55.2~56.7
19.0	18.5~19.5	31.5	30.8~32.2	44.0	43.2~44.7	56.5	55.7~57.2
19.5	19.0~20.0	32.0	31.3~32.7	44.5	43.7~45.2	57.0	56.2~57.7
20.0	19.4~20.6	32.5	31.8~33.2	45.0	44.2~45.7	57.5	56.7~58.2
20.5	19.9~21.1	33.0	32.3~33.7	45.5	44.7~46.2	58.0	57.2~58.7
21.0	20.4~21.6	33.5	32.8~34.2	46.0	45.2~46.7	58.5	57.7~59.2
21.5	20.9~22.1	34.0	33.3~34.7	46.5	45.7~47.2	59.0	58.2~59.7
22.0	21.4~22.6	34.5	33.8~35.2	47.0	46.2~47.7	59.5	58.7~60.2
22.5	21.9~23.1	35.0	34.3~35.7	47.5	46.7~48.2	60.0	59.2~60.7
23.0	22.4~23.6	35.5	34.8~36.2	48.0	47.2~48.7	60.5	59.7~61.2
23.5	22.9~24.1	36.0	35.3~36.7	48.5	47.7~49.2		
24.0	23.4~24.6	36.5	35.8~37.2	49.0	48.2~49.7		

◀ Insert and parts

Drill dia. (mm)	Peripheral insert	Central insert	Screw	Wrench	Torque (N·m)
Ø12.0~Ø13.5	SP□T040204-□□	XO□T040204-□□	FTNA0204	TW06P	0.4
Ø13.6~Ø16.0	SP□T050204-□□	XO□T050204-□□	FTNA0204	TW06P	0.4
Ø16.1~Ø19.5	SP□T060205-□□	XO□T060204-□□	FTKA02206S	TW07P	0.8
Ø19.6~Ø23.5	SP□T07T208-□□	XO□T07T205-□□	FTKA02565	TW07S	0.8
Ø23.6~Ø29.5	SP□T090308-□□	XO□T090305-□□	FTKA0307	TW09S	1.2
Ø29.6~Ø35.5	SP□T11T308-□□	XO□T11T306-□□	FTKA03508	TW15S	3
Ø35.6~Ø42.5	SP□T130410-□□	XO□T130406-□□	FTKA0410	TW15S	3
Ø42.6~Ø50.5	SP□T15M510-□□	XO□T15M508-□□	FTNC04511	TW20S	5
Ø50.6~Ø60.5	SP□T180510-□□	XO□T180508-□□	FTNA0511	TW20-100	5

- In clamping an insert, please clean the tip seat and apply CASMOLY1000 on the screw
- Please make sure to use a Korloy-produced wrench and screw only

G Technical Information for King Drill

King Drill - for machining a tap foundation hole

- There are two types of specifications of tap, metric and inch. The King Drill is available for machining both thru tap and blind tap

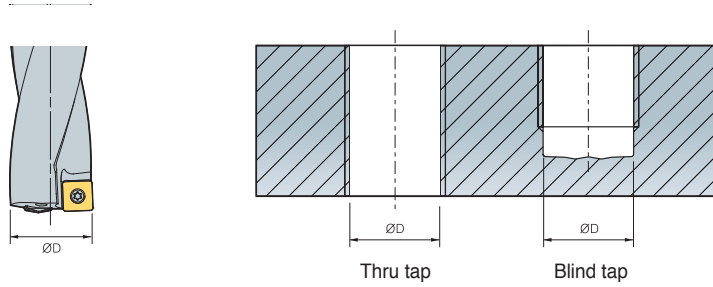

(mm)

Tap type	Thread	ØD	Designation	Reference
Metric	M14 x 2.0	12.0	K3D12020-04	G14
	M16 x 2.0	14.0	K3D14020-05	G14
	M18 x 2.5	15.5	K3D15520-05	G14
	M20 x 2.5	17.5	K3D17525-06	G14
	M22 x 2.5	19.5	K3D19525-06	G14
	M24 x 3.0	21.0	K3D21025-07	G14
	M27 x 3.0	24.0	K3D24032-09	G14
	M30 x 3.5	26.5	K3D26532-09	G14
	M33 x 4.0	29.0	K3D29032-09	G14
	M36 x 4.0	32.0	K3D32032-11	G15
	M39 x 4.0	35.0	K3D35032-11	G15
	M42 x 4.5	37.5	K3D37540-13	G15
Inch	9/16-12 UNC	12.2	K3D12220-04	G14
	5/8-11 UNC	13.5	K3D13520-04	G14
	3/4-10 UNC	16.5	K3D16525-06	G14
	7/8-9 UNC	19.5	K3D19525-06	G14
	9/16-18 UNF	12.9	K3D12920-04	G14
	5/8-18 UNF	14.5	K3D14520-05	G14
	3/4-16 UNF	17.5	K3D17525-06	G14



Special drill order form

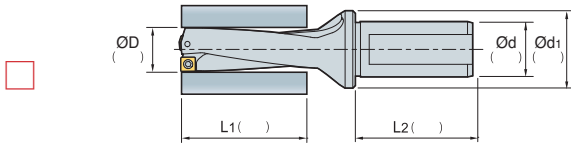
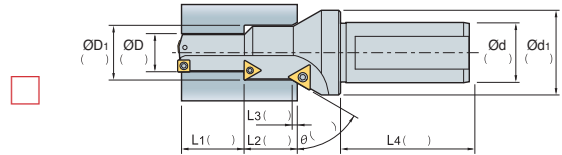
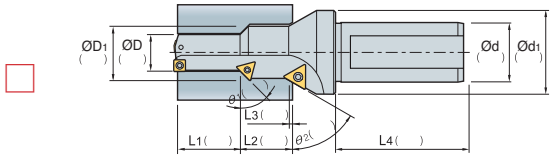
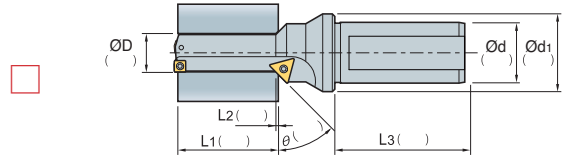
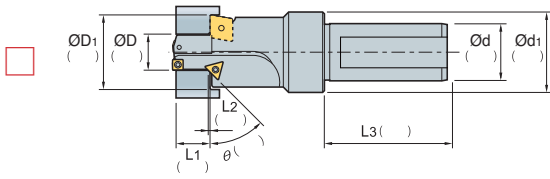

■ Coolant type

Through coolant Plug Type (Standard) Through coolant Non Plug Type No coolant

■ Hole type

Blind hole Thru hole

■ Types of shank

Flat Type

Weldon Type

Whistle Notch Type

■ Location of side lock

Parallel to peripheral insert (standard)

90° angle to peripheral insert (standard)

180° angle to peripheral insert (standard)

270° angle to peripheral insert (standard)



■ Note

- Currently using tool:
- Current cutting condition
 - RPM or vc (m/min):
 - vf (mm/min) or fn (mm/rev):
 - Depth of cut (mm):
- Standard of measuring tool life:
- Currently using machine
 - Machining center:
 - General lathe:
 - CNC lathe:

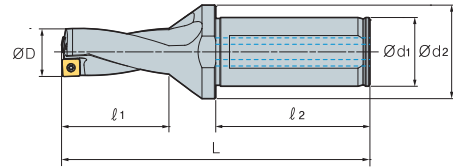
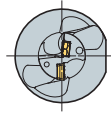
King Drill (2D)



(mm)

Designation	ØD	Ød ₁	Ød ₂	l ₁	l ₂	L	Insert	Screw 	Wrench 
K2D 12020-04	12.0	20	25	27	50	91	SP□T040204-□□ XO□T040204-□□	FTNA0204	TW06P
12520-04	12.5	20	25	27	50	91			
13020-04	13.0	20	25	29	50	93			
13520-04	13.5	20	25	29	50	93	SP□T050204-□□ XO□T050204-□□	FTNA0204	TW06P
14020-05	14.0	20	25	31	50	96			
14520-05	14.5	20	25	31	50	96			
15020-05	15.0	20	25	33	50	99	SP□T060205-□□ XO□T060204-□□	FTKA02206S	TW07P
15520-05	15.5	20	25	33	50	99			
16020-05	16.0	20	25	35	50	101			
16525-06	16.5	25	34	35	56	107	SP□T07T208-□□ XO□T07T205-□□	FTKA02565	TW07S
17025-06	17.0	25	34	37	56	109			
17525-06	17.5	25	34	37	56	109			
18025-06	18.0	25	34	39	56	112	SP□T090308-□□ XO□T090305-□□	FTKA0307	TW09S
18525-06	18.5	25	34	39	56	112			
19025-06	19.0	25	34	41	56	114			
19525-06	19.5	25	34	41	56	114	SP□T11T308-□□ XO□T11T306-□□	FTKA03508	TW15S
20025-07	20.0	25	34	43	56	118			
20525-07	20.5	25	34	43	56	118			
21025-07	21.0	25	34	45	56	120	SP□T11T308-□□ XO□T11T306-□□	FTKA03508	TW15S
21525-07	21.5	25	34	45	56	120			
22025-07	22.0	25	34	47	56	122			
22525-07	22.5	25	34	47	56	122	SP□T11T308-□□ XO□T11T306-□□	FTKA03508	TW15S
23025-07	23.0	25	34	49	56	126			
23525-07	23.5	25	34	49	56	126			
24032-09	24.0	32	44	51	60	133	SP□T11T308-□□ XO□T11T306-□□	FTKA03508	TW15S
24532-09	24.5	32	44	51	60	133			
25032-09	25.0	32	44	53	60	135			
25532-09	25.5	32	44	53	60	135	SP□T11T308-□□ XO□T11T306-□□	FTKA03508	TW15S
26032-09	26.0	32	44	55	60	137			
26532-09	26.5	32	44	55	60	137			
27032-09	27.0	32	44	57	60	140	SP□T11T308-□□ XO□T11T306-□□	FTKA03508	TW15S
27532-09	27.5	32	44	57	60	140			
28032-09	28.0	32	44	59	60	143			
28532-09	28.5	32	44	59	60	143	SP□T11T308-□□ XO□T11T306-□□	FTKA03508	TW15S
29032-09	29.0	32	44	61	60	145			
29532-09	29.5	32	44	61	60	145			
30032-11	30.0	32	44	63	60	150	SP□T11T308-□□ XO□T11T306-□□	FTKA03508	TW15S
30532-11	30.5	32	44	63	60	150			
31032-11	31.0	32	44	65	60	152			
31532-11	31.5	32	44	65	60	152	SP□T11T308-□□ XO□T11T306-□□	FTKA03508	TW15S
32032-11	32.0	32	44	67	60	154			
32532-11	32.5	32	44	67	60	154			
33032-11	33.0	32	44	69	60	157	SP□T11T308-□□ XO□T11T306-□□	FTKA03508	TW15S
33532-11	33.5	32	44	69	60	157			
34032-11	34.0	32	44	71	60	159			
34532-11	34.5	32	44	71	60	159	SP□T11T308-□□ XO□T11T306-□□	FTKA03508	TW15S
35032-11	35.0	32	44	73	60	161			
35532-11	35.5	32	44	73	60	161			

 Applicable inserts G04-05



King Drill (2D)

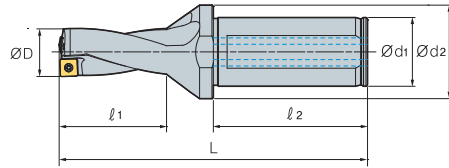
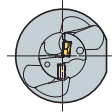



		(mm)											
Designation	ØD	Ød ₁	Ød ₂	l ₁	l ₂	L	Insert	Screw	Wrench				
K2D	36040-13	36.0	40	48	76	70	176	SP□T130410-□□ XO□T130406-□□	FTKA0410	TW15S			
	36540-13	36.5	40	48	76	70	176						
	37040-13	37.0	40	48	78	70	178						
	37540-13	37.5	40	48	78	70	178						
	38040-13	38.0	40	48	80	70	181						
	38540-13	38.5	40	48	80	70	181						
	39040-13	39.0	40	48	82	70	183						
	39540-13	39.5	40	48	82	70	183						
	40040-13	40.0	40	48	84	70	186						
	40540-13	40.5	40	48	84	70	186						
	41040-13	41.0	40	48	86	70	188						
	41540-13	41.5	40	48	86	70	188						
	42040-13	42.0	40	48	88	70	191						
	42540-13	42.5	40	48	88	70	191						
	43040-15	43.0	40	58	91	70	196				SP□T15M510-□□ XO□T15M508-□□	FTNC04511	TW20S
	43540-15	43.5	40	58	91	70	196						
	44040-15	44.0	40	58	93	70	198						
	44540-15	44.5	40	58	93	70	198						
	45040-15	45.0	40	58	95	70	201						
	45540-15	45.5	40	58	95	70	201						
	46040-15	46.0	40	58	97	70	203						
	46540-15	46.5	40	58	97	70	203						
	47040-15	47.0	40	58	99	70	206						
	47540-15	47.5	40	58	99	70	206						
48040-15	48.0	40	58	101	70	208							
48540-15	48.5	40	58	101	70	208							
49040-15	49.0	40	58	103	70	210							
49540-15	49.5	40	58	103	70	210							
50040-15	50.0	40	58	105	70	212							
50540-15	50.5	40	58	105	70	212							
51040-18	51.0	40	68	108	70	218	SP□T180510-□□ XO□T180508-□□	FTNA0511	TW20-100				
51540-18	51.5	40	68	108	70	218							
52040-18	52.0	40	68	110	70	220							
52540-18	52.5	40	68	110	70	220							
53040-18	53.0	40	68	112	70	222							
53540-18	53.5	40	68	112	70	222							
54040-18	54.0	40	68	114	70	224							
54540-18	54.5	40	68	114	70	224							
55040-18	55.0	40	68	116	70	226							
55540-18	55.5	40	68	116	70	226							
56040-18	56.0	40	68	118	70	230							
56540-18	56.5	40	68	118	70	230							
57040-18	57.0	40	68	121	70	233							
57540-18	57.5	40	68	121	70	233							
58040-18	58.0	40	68	124	70	236							
58540-18	58.5	40	68	124	70	236							
59040-18	59.0	40	68	127	70	239							
59540-18	59.5	40	68	127	70	239							
60040-18	60.0	40	68	130	70	242							
60540-18	60.5	40	68	130	70	242							

↻ Applicable inserts G04-05

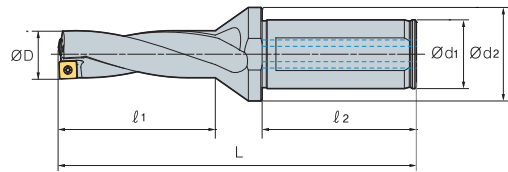
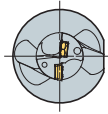
King Drill (3D)



(mm)

Designation	ØD	Ød ₁	Ød ₂	l ₁	l ₂	L	Insert	Screw 	Wrench 
K3D 12020-04 *	12.0	20	25	39	50	103	SP□T040204-□□ XO□T040204-□□	FTNA0204	TW06P
12220-04	12.2	20	25	39	50	103			
12520-04	12.5	20	25	39	50	103			
12920-04	12.9	20	25	42	50	106			
13020-04	13.0	20	25	42	50	106			
13520-04	13.5	20	25	42	50	106			
14020-05 *	14.0	20	25	45	50	110	SP□T050204-□□ XO□T050204-□□	FTNA0204	TW06P
14520-05	14.5	20	25	45	50	110			
15020-05	15.0	20	25	48	50	114			
15520-05 *	15.5	20	25	48	50	114			
16020-05	16.0	20	25	51	50	117			
16525-06	16.5	25	34	51	56	123			
17025-06	17.0	25	34	54	56	126			
17525-06 *	17.5	25	34	54	56	126			
18025-06	18.0	25	34	57	56	130			
18525-06	18.5	25	34	57	56	130			
19025-06	19.0	25	34	60	56	133	SP□T07T208-□□ XO□T07T205-□□	FTKA02565	TW07S
19525-06 *	19.5	25	34	60	56	133			
20025-07	20.0	25	34	63	56	138			
20525-07	20.5	25	34	63	56	138			
21025-07 *	21.0	25	34	66	56	141			
21525-07	21.5	25	34	66	56	141			
22025-07	22.0	25	34	69	56	144	SP□T090308-□□ XO□T090305-□□	FTKA0307	TW09S
22525-07	22.5	25	34	69	56	144			
23025-07	23	25	34	72	56	149			
23525-07	23.5	25	34	72	56	149			
24032-09 *	24.0	32	44	75	60	157			
24532-09	24.5	32	44	75	60	157			
25032-09	25.0	32	44	78	60	160	SP□T090308-□□ XO□T090305-□□	FTKA0307	TW09S
25532-09	25.5	32	44	78	60	160			
26032-09	26.0	32	44	81	60	163			
26532-09 *	26.5	32	44	81	60	163			
27032-09	27.0	32	44	84	60	167			
27532-09	27.5	32	44	84	60	167			
28032-09	28.0	32	44	87	60	171	SP□T090308-□□ XO□T090305-□□	FTKA0307	TW09S
28532-09	28.5	32	44	87	60	171			
29032-09 *	29.0	32	44	90	60	174			
29532-09	29.5	32	44	90	60	174			



↻ Applicable inserts G04-05

The items marked * can machine a tap foundation hole (Reference G09p)

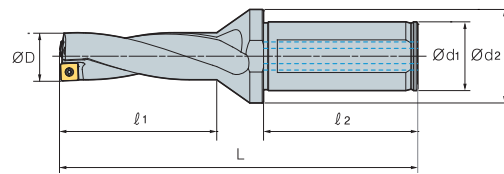
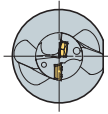

King Drill (3D)



Designation		ØD	Ød ₁	Ød ₂	l ₁	l ₂	L	Insert	Screw 	Wrench 			
K3D	30032-11 *	30.0	32	44	93	60	180	SP□T11T308-□□ XO□T11T306-□□	FTKA03508	TW15S			
	30532-11	30.5	32	44	93	60	180						
	31032-11	31.0	32	44	96	60	183						
	31532-11	31.5	32	44	96	60	183						
	32032-11	32.0	32	44	99	60	186						
	32532-11	32.5	32	44	99	60	186						
	33032-11	33.0	32	44	102	60	190						
	33532-11	33.5	32	44	102	60	190						
	34032-11	34.0	32	44	105	60	193						
	34532-11	34.5	32	44	105	60	193						
	35032-11 *	35.0	32	44	108	60	196						
	35532-11	35.5	32	44	108	60	196						
	36040-13	36.0	40	48	112	70	212				SP□T130410-□□ XO□T130406-□□	FTKA0410	TW15S
	36540-13	36.5	40	48	112	70	212						
	37040-13	37.0	40	48	115	70	215						
	37540-13	37.5	40	48	115	70	215						
	38040-13	38.0	40	48	118	70	219						
	38540-13	38.5	40	48	118	70	219						
	39040-13	39.0	40	48	121	70	222						
	39540-13	39.5	40	48	121	70	222						
	40040-13	40.0	40	48	124	70	226						
	40540-13	40.5	40	48	124	70	226						
41040-13	41.0	40	48	127	70	229							
41540-13	41.5	40	48	127	70	229							
42040-13	42.0	40	48	130	70	233	SP□T15M510-□□ XO□T15M508-□□	FTNC04511	TW20S				
42540-13	42.5	40	48	130	70	233							
43040-15	43.0	40	58	134	70	239							
43540-15	43.5	40	58	134	70	239							
44040-15	44.0	40	58	137	70	242							
44540-15	44.5	40	58	137	70	242							
45040-15	45.0	40	58	140	70	246							
45540-15	45.5	40	58	140	70	246							
46040-15	46.0	40	58	143	70	249							
46540-15	46.5	40	58	143	70	249							
47040-15	47.0	40	58	146	70	253							
47540-15	47.5	40	58	146	70	253							
48040-15	48.0	40	58	149	70	256							
48540-15	48.5	40	58	149	70	256							
49040-15	49.0	40	58	152	70	259							
49540-15	49.5	40	58	152	70	259							
50040-15	50.0	40	58	155	70	262							
50540-15	50.5	40	58	155	70	262							

↻ Applicable inserts G04-05

The items marked * can machine a tap foundation hole (Reference G09p)

King Drill (3D)

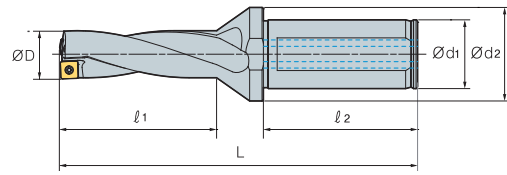
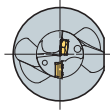

(mm)

Designation	ØD	Ød ₁	Ød ₂	l ₁	l ₂	L	Insert	Screw	Wrench
K3D									
51040-18	51.0	40	68	159	70	269			
51540-18	51.5	40	68	159	70	269			
52040-18	52.0	40	68	162	70	272			
52540-18	52.5	40	68	162	70	272			
53040-18	53.0	40	68	165	70	275			
53540-18	53.5	40	68	165	70	275			
54040-18	54.0	40	68	168	70	278			
54540-18	54.5	40	68	168	70	278			
55040-18	55.0	40	68	171	70	281			
55540-18	55.5	40	68	171	70	281	SP□T180510-□□	FTNA0511	TW20-100
56040-18	56.0	40	68	174	70	286	XO□T180508-□□		
56540-18	56.5	40	68	174	70	286			
57040-18	57.0	40	68	178	70	290			
57540-18	57.5	40	68	178	70	290			
58040-18	58.0	40	68	182	70	294			
58540-18	58.5	40	68	182	70	294			
59040-18	59.0	40	68	186	70	298			
59540-18	59.5	40	68	186	70	298			
60040-18	60.0	40	68	190	70	302			
60540-18	60.5	40	68	190	70	302			

↻ Applicable inserts G04~05

King Drill (4D)

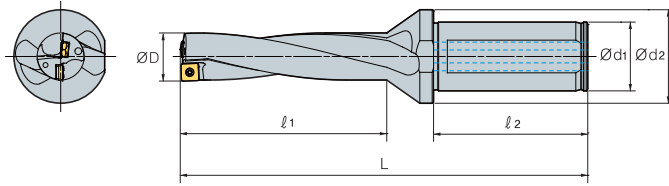



Designation		ØD	Ød ₁	Ød ₂	l ₁	l ₂	L	Insert	Screw	Wrench
K4D	12020-04	12.0	20	25	51	50	115	SP□T040204-□□ XO□T040204-□□	FTNA0204	TW06P
	12520-04	12.5	20	25	51	50	115			
	13020-04	13.0	20	25	55	50	119			
	13520-04	13.5	20	25	55	50	119			
	14020-05	14.0	20	25	59	50	124	SP□T050204-□□ XO□T050204-□□	FTNA0204	TW06P
	14520-05	14.5	20	25	59	50	124			
	15020-05	15.0	20	25	63	50	129			
	15520-05	15.5	20	25	63	50	129			
	16020-05	16.0	20	25	67	50	133	SP□T060205-□□ XO□T060204-□□	FTKA02206S	TW07P
	16525-06	16.5	25	34	67	56	139			
	17025-06	17.0	25	34	71	56	143			
	17525-06	17.5	25	34	71	56	143			
	18025-06	18.0	25	34	75	56	148			
	18525-06	18.5	25	34	75	56	148			
	19025-06	19.0	25	34	79	56	152			
	19525-06	19.5	25	34	79	56	152			
	20025-07	20.0	25	34	83	56	158	SP□T07T208-□□ XO□T07T205-□□	FTKA02565	TW07S
	20525-07	20.5	25	34	83	56	158			
	21025-07	21.0	25	34	87	56	162			
	21525-07	21.5	25	34	87	56	162			
	22025-07	22.0	25	34	91	56	166			
	22525-07	22.5	25	34	91	56	166			
	23025-07	23.0	25	34	95	56	172			
	23525-07	23.5	25	34	95	56	172			
	24032-09	24.0	32	44	99	60	181	SP□T090308-□□ XO□T090305-□□	FTKA0307	TW09S
	24532-09	24.5	32	44	99	60	181			
	25032-09	25.0	32	44	103	60	185			
	25532-09	25.5	32	44	103	60	185			
	26032-09	26.0	32	44	107	60	189			
	26532-09	26.5	32	44	107	60	189			
	27032-09	27.0	32	44	111	60	194			
	27532-09	27.5	32	44	111	60	194			
	28032-09	28.0	32	44	115	60	199			
	28532-09	28.5	32	44	115	60	199			
	29032-09	29.0	32	44	119	60	203			
	29532-09	29.5	32	44	119	60	203			
	30032-11	30.0	32	44	123	60	210	SP□T11T308-□□ XO□T11T306-□□	FTKA03508	TW15S
	30532-11	30.5	32	44	123	60	210			
	31032-11	31.0	32	44	127	60	214			
	31532-11	31.5	32	44	127	60	214			
32032-11	32.0	32	44	131	60	218				
32532-11	32.5	32	44	131	60	218				
33032-11	33.0	32	44	135	60	223				
33532-11	33.5	32	44	135	60	223				
34032-11	34.0	32	44	139	60	227				
34532-11	34.5	32	44	139	60	227				
35032-11	35.0	32	44	143	60	231				
35532-11	35.5	32	44	143	60	231				

↻ Applicable inserts G04-05

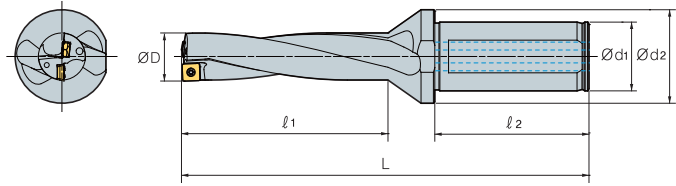
King Drill (4D)



(mm)

Designation	ØD	Ød ₁	Ød ₂	l ₁	l ₂	L	Insert	Screw 	Wrench 
K4D									
36040-13	36.0	40	48	148	70	248	SP□T130410-□□ XO□T130406-□□	FTKA0410	TW15S
36540-13	36.5	40	48	148	70	248			
37040-13	37.0	40	48	152	70	252			
37540-13	37.5	40	48	152	70	252			
38040-13	38.0	40	48	156	70	257			
38540-13	38.5	40	48	156	70	257			
39040-13	39.0	40	48	160	70	261			
39540-13	39.5	40	48	160	70	261			
40040-13	40.0	40	48	164	70	266			
40540-13	40.5	40	48	164	70	266			
41040-13	41.0	40	48	168	70	270			
41540-13	41.5	40	48	168	70	270			
42040-13	42.0	40	48	172	70	275			
42540-13	42.5	40	48	172	70	275			
43040-15	43.0	40	58	177	70	282	SP□T15M510-□□ XO□T15M508-□□	FTNC04511	TW20S
43540-15	43.5	40	58	177	70	282			
44040-15	44.0	40	58	181	70	286			
44540-15	44.5	40	58	181	70	286			
45040-15	45.0	40	58	185	70	291			
45540-15	45.5	40	58	185	70	291			
46040-15	46.0	40	58	189	70	295			
46540-15	46.5	40	58	189	70	295			
47040-15	47.0	40	58	193	70	300			
47540-15	47.5	40	58	193	70	300			
48040-15	48.0	40	58	197	70	304			
48540-15	48.5	40	58	197	70	304			
49040-15	49.0	40	58	201	70	308			
49540-15	49.5	40	58	201	70	308			
50040-15	50.0	40	58	205	70	312	SP□T180510-□□ XO□T180508-□□	FTNA0511	TW20-100
50540-15	50.5	40	58	205	70	312			
51040-18	51.0	40	68	210	70	320			
51540-18	51.5	40	68	210	70	320			
52040-18	52.0	40	68	214	70	324			
52540-18	52.5	40	68	214	70	324			
53040-18	53.0	40	68	218	70	328			
53540-18	53.5	40	68	218	70	328			
54040-18	54.0	40	68	222	70	332			
54540-18	54.5	40	68	222	70	332			
55040-18	55.0	40	68	226	70	336			
55540-18	55.5	40	68	226	70	336			
56040-18	56.0	40	68	230	70	342			
56540-18	56.5	40	68	230	70	342			
57040-18	57.0	40	68	235	70	347			
57540-18	57.5	40	68	235	70	347			
58040-18	58.0	40	68	240	70	352			
58540-18	58.5	40	68	240	70	352			
59040-18	59.0	40	68	245	70	357			
59540-18	59.5	40	68	245	70	357			
60040-18	60.0	40	68	250	70	362			
60540-18	60.5	40	68	250	70	362			

↻ Applicable inserts G04~05



King Drill (5D)

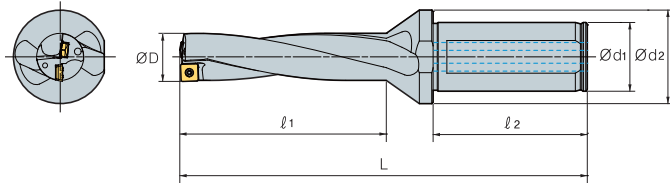

Designation		ØD	Ød ₁	Ød ₂	l ₁	l ₂	L	Insert	Screw	Wrench
K5D	12020-04	12.0	20	25	63	50	127	SP□T040204-□□ XO□T040204-□□	FTNA0204	TW06P
	12520-04	12.5	20	25	63	50	127			
	13020-04	13.0	20	25	68	50	132			
	13520-04	13.5	20	25	68	50	132			
	14020-05	14.0	20	25	73	50	138	SP□T050204-□□ XO□T050204-□□	FTNA0204	TW06P
	14520-05	14.5	20	25	73	50	138			
	15020-05	15.0	20	25	78	50	144			
	15520-05	15.5	20	25	78	50	144			
	16020-05	16.0	20	25	83	50	149	SP□T060205-□□ XO□T060204-□□	FTKA02206S	TW07P
	16525-06	16.5	25	34	83	56	155			
	17025-06	17.0	25	34	88	56	160			
	17525-06	17.5	25	34	88	56	160			
	18025-06	18.0	25	34	93	56	166			
	18525-06	18.5	25	34	93	56	166			
	19025-06	19.0	25	34	98	56	171			
	19525-06	19.5	25	34	98	56	171			
	20025-07	20.0	25	34	103	56	178	SP□T07T208-□□ XO□T07T205-□□	FTKA02565	TW07S
	20525-07	20.5	25	34	103	56	178			
	21025-07	21.0	25	34	108	56	183			
	21525-07	21.5	25	34	108	56	183			
	22025-07	22.0	25	34	113	56	188			
	22525-07	22.5	25	34	113	56	188			
	23025-07	23.0	25	34	118	56	195			
	23525-07	23.5	25	34	118	56	195			
	24032-09	24.0	32	44	123	60	205	SP□T090308-□□ XO□T090305-□□	FTKA0307	TW09S
	24532-09	24.5	32	44	123	60	205			
	25032-09	25.0	32	44	128	60	210			
	25532-09	25.5	32	44	128	60	210			
	26032-09	26.0	32	44	133	60	215			
	26532-09	26.5	32	44	133	60	215			
	27032-09	27.0	32	44	138	60	221			
	27532-09	27.5	32	44	138	60	221			
	28032-09	28.0	32	44	143	60	227			
	28532-09	28.5	32	44	143	60	227			
	29032-09	29.0	32	44	148	60	232			
	29532-09	29.5	32	44	148	60	232			
	30032-11	30.0	32	44	153	60	240	SP□T11T308-□□ XO□T11T306-□□	FTKA03508	TW15S
	30532-11	30.5	32	44	153	60	240			
	31032-11	31.0	32	44	158	60	245			
	31532-11	31.5	32	44	158	60	245			
32032-11	32.0	32	44	163	60	250				
32532-11	32.5	32	44	163	60	250				
33032-11	33.0	32	44	168	60	256				
33532-11	33.5	32	44	168	60	256				
34032-11	34.0	32	44	173	60	261				
34532-11	34.5	32	44	173	60	261				
35032-11	35.0	32	44	178	60	266				
35532-11	35.5	32	44	178	60	266				



(mm)

→ Applicable inserts G04-05

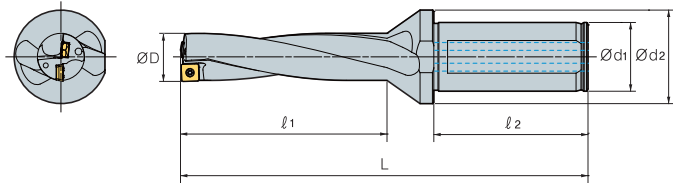
King Drill (5D)



(mm)

Designation	ØD	Ød ₁	Ød ₂	l ₁	l ₂	L	Insert	Screw 	Wrench 
K5D									
36040-13	36.0	40	48	184	70	284	SP□T130410-□□ XO□T130406-□□	FTKA0410	TW15S
36540-13	36.5	40	48	184	70	284			
37040-13	37.0	40	48	189	70	289			
37540-13	37.5	40	48	189	70	289			
38040-13	38.0	40	48	194	70	295			
38540-13	38.5	40	48	194	70	295			
39040-13	39.0	40	48	199	70	300			
39540-13	39.5	40	48	199	70	300			
40040-13	40.0	40	48	204	70	306			
40540-13	40.5	40	48	204	70	306			
41040-13	41.0	40	48	209	70	311			
41540-13	41.5	40	48	209	70	311			
42040-13	42.0	40	48	214	70	317			
42540-13	42.5	40	48	214	70	317			
43040-15	43.0	40	58	220	70	325	SP□T15M510-□□ XO□T15M508-□□	FTNC04511	TW20S
43540-15	43.5	40	58	221	70	326			
44040-15	44.0	40	58	225	70	330			
44540-15	44.5	40	58	225	70	330			
45040-15	45.0	40	58	230	70	336			
45540-15	45.5	40	58	230	70	336			
46040-15	46.0	40	58	235	70	341			
46540-15	46.5	40	58	235	70	341			
47040-15	47.0	40	58	240	70	347			
47540-15	47.5	40	58	240	70	347			
48040-15	48.0	40	58	245	70	352			
48540-15	48.5	40	58	245	70	352			
49040-15	49.0	40	58	250	70	357			
49540-15	49.5	40	58	250	70	357			
50040-15	50.0	40	58	255	70	362	SP□T180510-□□ XO□T180508-□□	FTNA0511	TW20-100
50540-15	50.5	40	58	255	70	362			
51040-18	51.0	40	68	261	70	371			
51540-18	51.5	40	68	261	70	371			
52040-18	52.0	40	68	266	70	376			
52540-18	52.5	40	68	266	70	376			
53040-18	53.0	40	68	271	70	381			
53540-18	53.5	40	68	271	70	381			
54040-18	54.0	40	68	276	70	386			
54540-18	54.5	40	68	276	70	386			
55040-18	55.0	40	68	281	70	391			
55540-18	55.5	40	68	281	70	391			
56040-18	56.0	40	68	286	70	398			
56540-18	56.5	40	68	286	70	398			
57040-18	57.0	40	68	292	70	404			
57540-18	57.5	40	68	292	70	404			
58040-18	58.0	40	68	298	70	410			
58540-18	58.5	40	68	298	70	410			
59040-18	59.0	40	68	304	70	416			
59540-18	59.5	40	68	304	70	416			
60040-18	60.0	40	68	310	70	422			
60540-18	60.5	40	68	310	70	422			

Applicable inserts G04~05



Drill with through coolant system for general lathe and
CNC lathe without through coolant system

King Drill (For through coolant system with a lathe)

- Through coolant system with drill holder, plug, oil-hole hose and oil-hole pump
- PT TAP in the plug is combined to PT TAP connected to oil hose
- Available to use the drill without a plug in milling machine

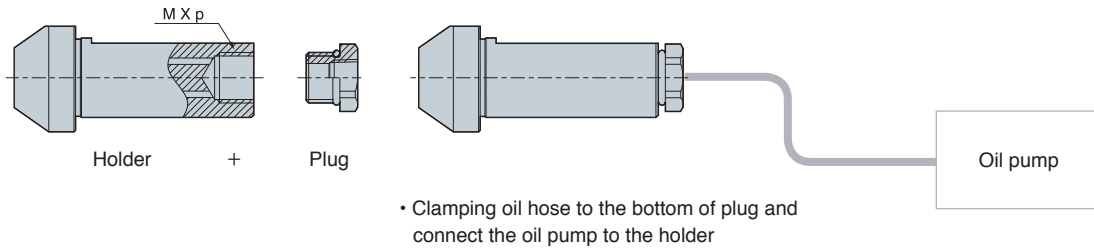

Tap type	Diameter	Shank dia.	M x p	Plug
K□D120~16020HP-□□	Ø12.0~Ø16.0	Ø20	M12x1.5	PLG12PT18
K□D161~23525HP-□□	Ø16.1~Ø23.5	Ø25	M16x1.5	PLG16PT18
K□D236~35532HP-□□	Ø23.6~Ø35.5	Ø32	M20x2.0	PLG20PT14
K□D356~60940HP-□□	Ø35.6~Ø60.5	Ø40	M27x2.0	PLG27PT38

(mm)

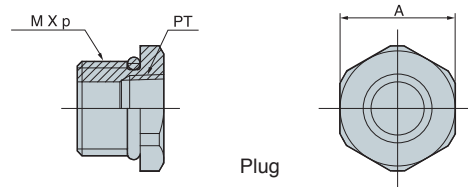

• Plug is assembled

Plug type	M x p	PT tap	A
PLG12PT18	M12x1.5	1/8	16
PLG16PT18	M16x1.5	1/8	19
PLG20PT14	M20x2.0	1/4	26
PLG27PT38	M27x2.0	3/8	35

King Drill (2D)

For through coolant system with a lathe

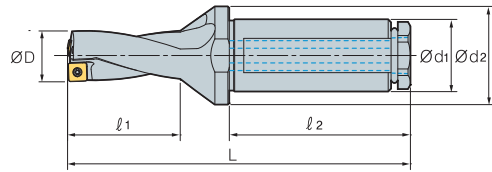
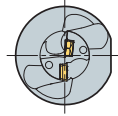

(mm)

Designation	ØD	Ød ₁	Ød ₂	l ₁	l ₂	L	Insert	Screw	Wrench	
K2D	13020HP-04	13.0	20	25	29	50	93	SP□T040204-□□ XO□T040204-□□	FTNA0204	TW06P
	13520HP-04	13.5	20	25	29	50	93			
	14020HP-05	14.0	20	25	31	50	96			
	15020HP-05	15.0	20	25	33	50	99	SP□T050204-□□ XO□T050204-□□	FTNA0204	TW06P
	16020HP-05	16.0	20	25	35	50	101			
	17025HP-06	17.0	25	34	37	56	109			
	18025HP-06	18.0	25	34	39	56	112	SP□T060205-□□ XO□T060204-□□	FTKA02206S	TW07P
	19025HP-06	19.0	25	34	41	56	114			
	20025HP-07	20.0	25	34	43	56	118			
	21025HP-07	21.0	25	34	45	56	120	SP□T07T208-□□ XO□T07T205-□□	FTKA02565	TW07S
	22025HP-07	22.0	25	34	47	56	122			
	23025HP-07	23.0	25	34	49	56	126			
	24032HP-09	24.0	32	44	51	60	133			
	25032HP-09	25.0	32	44	53	60	135			
	26032HP-09	26.0	32	44	55	60	137	SP□T090308-□□ XO□T090305-□□	FTKA0307	TW09S
	27032HP-09	27.0	32	44	57	60	140			
	28032HP-09	28.0	32	44	59	60	143			
	29032HP-09	29.0	32	44	61	60	145			

Applicable inserts G04~05

King Drill (3D)

For through coolant system with a lathe

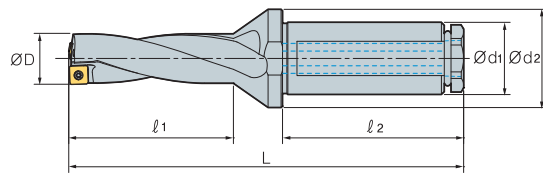
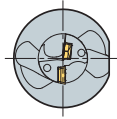

(mm)

Designation	ØD	Ød ₁	Ød ₂	l ₁	l ₂	L	Insert	Screw	Wrench	
K3D	13020HP-04	13.0	20	25	42	50	106	SP□T040204-□□ XO□T040204-□□	FTNA0204	TW06P
	13520HP-04	13.5	20	25	42	50	106			
	14020HP-05	14.0	20	25	45	50	110			
	14520HP-05	14.5	20	25	45	50	110			
	15020HP-05	15.0	20	25	48	50	114	SP□T050204-□□ XO□T050204-□□	FTNA0204	TW06P
	15520HP-05	15.5	20	25	48	50	114			
	16020HP-05	16.0	20	25	51	50	117			
	16525HP-06	16.5	25	34	51	56	123			
	17025HP-06	17.0	25	34	54	56	126			
	17525HP-06	17.5	25	34	54	56	126			
	18025HP-06	18.0	25	34	57	56	130	SP□T060205-□□ XO□T060204-□□	FTKA02206S	TW07P
	18525HP-06	18.5	25	34	57	56	130			
	19025HP-06	19.0	25	34	60	56	133			
	19525HP-06	19.5	25	34	60	56	133			
	20025HP-07	20.0	25	34	63	56	138			
	20525HP-07	20.5	25	34	63	56	138			
	21025HP-07	21.0	25	34	66	56	141			
	21525HP-07	21.5	25	34	66	56	141	SP□T07T208-□□ XO□T07T205-□□	FTKA02565	TW07S
	22025HP-07	22.0	25	34	69	56	144			
	22525HP-07	22.5	25	34	69	56	144			
	23025HP-07	23.0	25	34	72	56	149			
	23525HP-07	23.5	25	34	72	56	149			
	24032HP-09	24.0	32	44	75	60	157			
	24532HP-09	24.5	32	44	75	60	157			
	25032HP-09	25.0	32	44	78	60	160			
	25532HP-09	25.5	32	44	78	60	160			
	26032HP-09	26.0	32	44	81	60	163			
	26532HP-09	26.5	32	44	81	60	163	SP□T090308-□□ XO□T090305-□□	FTKA0307	TW09S
	27032HP-09	27.0	32	44	84	60	167			
	27532HP-09	27.5	32	44	84	60	167			
28032HP-09	28.0	32	44	87	60	171				
28532HP-09	28.5	32	44	87	60	171				
29032HP-09	29.0	32	44	90	60	174				
29532HP-09	29.5	32	44	90	60	174				

↻ Applicable inserts G04-05

King Drill (4D)

For through coolant system with a lathe

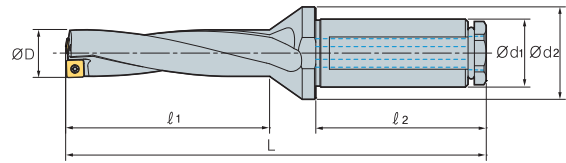
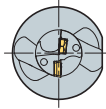

(mm)

Designation	ØD	Ød ₁	Ød ₂	l ₁	l ₂	L	Insert	Screw	Wrench
K4D 13020HP-04	13.0	20	25	29	50	93	SP□T040204-□□	FTNA0204	TW06P
	13.5	20	25	29	50	93	XO□T040204-□□		
14020HP-05	14.0	20	25	59	50	124	SP□T050204-□□ XO□T050204-□□	FTNA0204	TW06P
15020HP-05	15.0	20	25	63	50	129			
16020HP-05	16.0	20	25	67	50	133	SP□T060205-□□ XO□T060204-□□	FTKA02206S	TW07P
17025HP-06	17.0	25	34	71	56	143			
18025HP-06	18.0	25	34	75	56	148	SP□T07T208-□□ XO□T07T205-□□	FTKA02565	TW07S
19025HP-06	19.0	25	34	79	56	152			
20025HP-07	20.0	25	34	83	56	158	SP□T090308-□□ XO□T090305-□□	FTKA0307	TW09S
21025HP-07	21.0	25	34	87	56	162			
22025HP-07	22.0	25	34	91	56	166	SP□T090308-□□ XO□T090305-□□	FTKA0307	TW09S
23025HP-07	23.0	25	34	95	56	172			
24032HP-09	24.0	32	44	99	60	181	SP□T090308-□□ XO□T090305-□□	FTKA0307	TW09S
25032HP-09	25.0	32	44	103	60	185			
26032HP-09	26.0	32	44	107	60	189	SP□T090308-□□ XO□T090305-□□	FTKA0307	TW09S
27032HP-09	27.0	32	44	111	60	194			
28032HP-09	28.0	32	44	115	60	199	SP□T090308-□□ XO□T090305-□□	FTKA0307	TW09S
29032HP-09	29.0	32	44	119	60	203			

↻ Applicable inserts G04~05

High rigidity drill produces cost efficiency due to cartridge replacement

King Drill (For large diameter drilling)

- Cartridge type for $\varnothing 61 \sim \varnothing 100$ drilling
- Peripheral cartridge can adjust the drilling diameter within 5 mm
- Easy to adjust drilling diameter with adjusting bolt

Structure of King Drill (for large diameter) parts

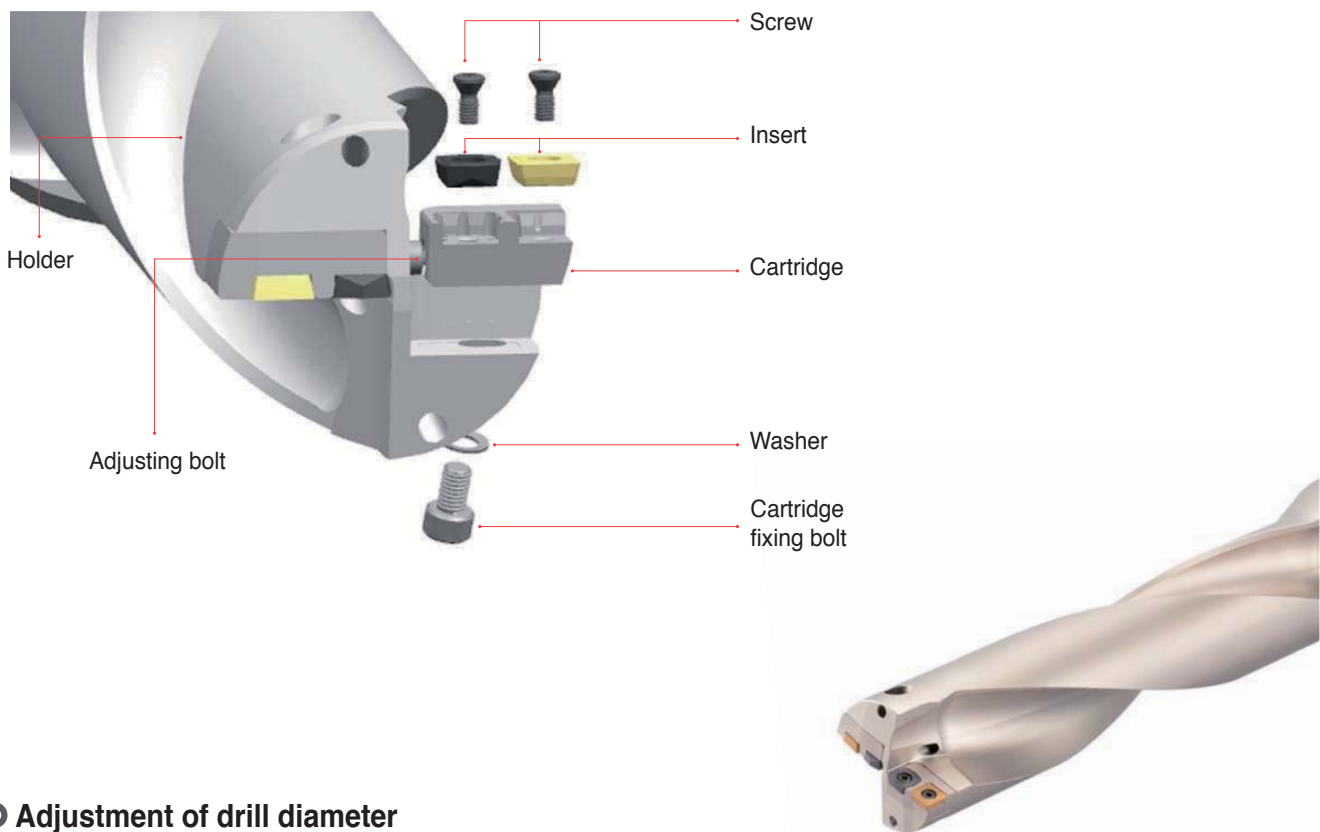

Adjustment of drill diameter

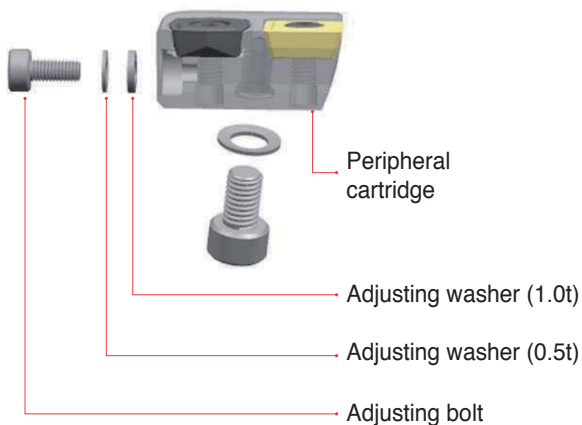

Adjustment \varnothing (mm)	Adjusting washer	
	Designation	Width (mm)
1	WA0305	0.5
2	WA0310	1.0
3	WA0305+WA0310	1.5
4	WA0310x2	2.0
5	WA0305+WA0310x2	2.5

※ Adjusting washer adjusts the drilling diameter within 5 mm

King Drill

For large diameter drilling

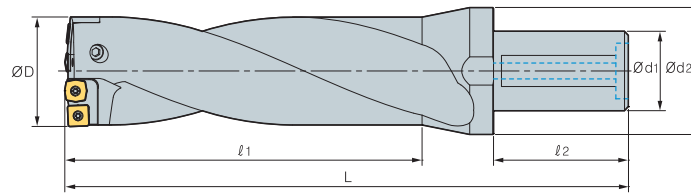

(mm)

Designation	ØD	Ød ₁	Ød ₂	l ₁	l ₂	L	Cartridge		Screw	Wrench	
							Internal	External			
K2D	616550-11	61~65	50	80	130	80	255	KDC6165C	KDC6165P	FTKA03508	TW15S
	657050-13	65~70	50	88	140	80	265	KDC6570C	KDC6570P	FTKA0410	TW15S
	707550-13	70~75	50	88	150	80	275	KDC7075C	KDC7075P	FTKA0410	TW15S
	758050-13	75~80	50	88	160	80	285	KDC7580C	KDC7580P	FTKA0410	TW15S
	808550-15	80~85	50	88	170	80	295	KDC8085C	KDC8085P	FTNC04511	TW20S
	859050-15	85~90	50	95	180	80	305	KDC8590C	KDC8590P	FTNC04511	TW20S
	909550-15	90~95	50	95	190	80	315	KDC9095C	KDC9095P	FTNC04511	TW20S
	9510050-18	95~100	50	95	200	80	325	KDC95100C	KDC95100P	FTNA0511	TW20-100
K3D	616550-11	61~65	50	80	195	80	320	KDC6165C	KDC6165P	FTKA03508	TW15S
	657050-13	65~70	50	88	210	80	335	KDC6570C	KDC6570P	FTKA0410	TW15S
	707550-13	70~75	50	88	225	80	350	KDC7075C	KDC7075P	FTKA0410	TW15S
	758050-13	75~80	50	88	240	80	365	KDC7580C	KDC7580P	FTKA0410	TW15S
	808550-15	80~85	50	88	255	80	380	KDC8085C	KDC8085P	FTNC04511	TW20S
	859050-15	85~90	50	95	270	80	395	KDC8590C	KDC8590P	FTNC04511	TW20S
	909550-15	90~95	50	95	285	80	410	KDC9095C	KDC9095P	FTNC04511	TW20S
	9510050-18	95~100	50	95	300	80	425	KDC95100C	KDC95100P	FTNA0511	TW20-100
K4D	616550-11	61~65	50	80	260	80	385	KDC6165C	KDC6165P	FTKA03508	TW15S
	657050-13	65~70	50	88	280	80	405	KDC6570C	KDC6570P	FTKA0410	TW15S
	707550-13	70~75	50	88	300	80	425	KDC7075C	KDC7075P	FTKA0410	TW15S
	758050-13	75~80	50	88	320	80	445	KDC7580C	KDC7580P	FTKA0410	TW15S
	808550-15	80~85	50	88	340	80	465	KDC8085C	KDC8085P	FTNC04511	TW20S
	859050-15	85~90	50	95	360	80	485	KDC8590C	KDC8590P	FTNC04511	TW20S
	909550-15	90~95	50	95	380	80	505	KDC9095C	KDC9095P	FTNC04511	TW20S
	9510050-18	95~100	50	95	400	80	525	KDC95100C	KDC95100P	FTNA0511	TW20-100

↻ Applicable inserts G04~05

↻ Parts

Cartridge		Range (Ø)	Insert				Screw	Wrench
Internal	External		Designation	Quantity	Designation	Quantity		
KDC6165C	KDC6165P	61 ~ 65	XO□T11T306-□□	2	SP□T11T308-□□	2	FTKA03508	TW15S
KDC6570C	KDC6570P	65 ~ 70	XO□T130406-□□	2	SP□T130410-□□	2	FTKA0410	TW15S
KDC7075C	KDC7075P	70 ~ 75	XO□T130406-□□	2	SP□T130410-□□	2	FTKA0410	TW15S
KDC7580C	KDC7580P	75 ~ 80	XO□T130406-□□	2	SP□T130410-□□	2	FTKA0410	TW15S
KDC8085C	KDC8085P	80 ~ 85	XO□T15M508-□□	2	SP□T15M510-□□	2	FTNC04511	TW20S
KDC8590C	KDC8590P	85 ~ 90	XO□T15M508-□□	2	SP□T15M510-□□	2	FTNC04511	TW20S
KDC9095C	KDC9095P	90 ~ 95	XO□T15M508-□□	2	SP□T15M510-□□	2	FTNC04511	TW20S
KDC95100C	KDC95100P	95 ~ 100	XO□T180508-□□	2	SP□T180510-□□	2	FTNA0511	TW20-100



Cone shaped head indexable drill

TPDC **new**

- Clamping design
 - One step clamp system → Increased stability
 - Clamping system allowing to change inserts while the holder is attached on the machine → Shortened setting time
- Optimized blade design
 - Excellent chip control → Wide application range in various types of materials.
- Helical shaped coolant hole system
 - Wide chip pocket area secured → Better lubrication + chip flow improved
- Material technology
 - Ultra-fine substrate + Multi-layer coating applied → Excellent anti chipping & wear resistance

➤ Code system of holder

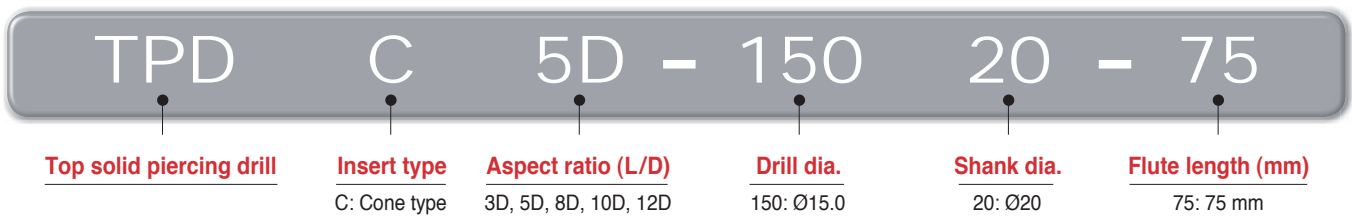

➤ Code system of insert



➤ Features

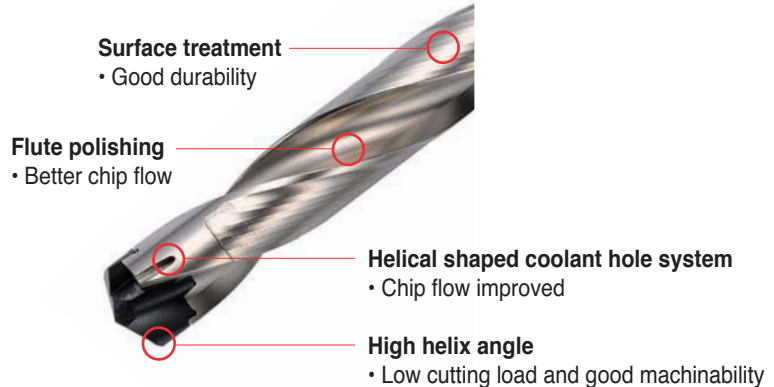
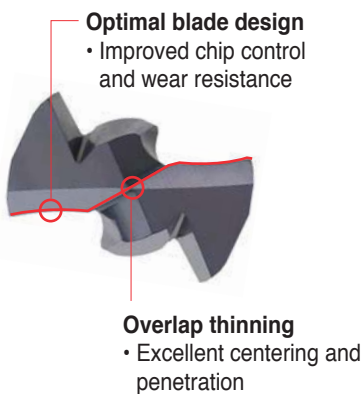

Features of clamping system

- One Step Clamp System → Easy and quick tool change with good repeatability
 - Clamping area: Easy and fast tool change
 - Anti-rotating area: Performs as a stopper
 - Clamping and anti-rotating area make an acute angle to prevent insert rotation while machining

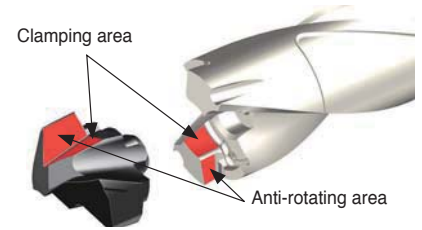

Performance evaluation

Durability test

- **Workpiece** SCM440 (HRC22)
 - Drill dia.(mm) = \varnothing 15.0
 - vc (m/min) = 90, fn (mm/rev) = 0.25
 - ap (mm) = 60, wet
- **Tools**
 - Inserts** TPD1500CP (PC5335)
 - Holder** TPDC5D-15020-75

After using 40 inserts, the setting run-out remains below $15\mu\text{m}$

Sustainability test

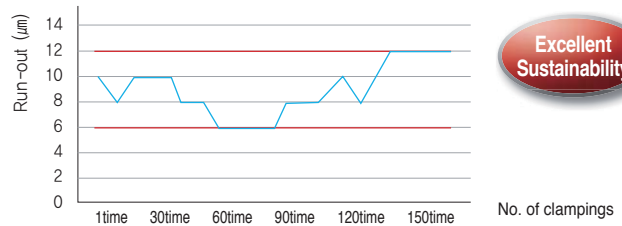

After clamping 150 times, the drill run-out remains

Application examples

- **Use** Part of machine
- **Workpiece** Alloy steel (SCM440, HRC22)
- **Cutting conditions**
 - Drill dia.(mm) = \varnothing 19.0
 - vc (m/min) = 100
 - fn (mm/rev) = 0.3
 - ap (mm) = 90, wet
- **Tools**
 - Inserts** TPD1900CP (PC5335)
 - Holder** TPDC5D-19025-95



Competitor

Test result

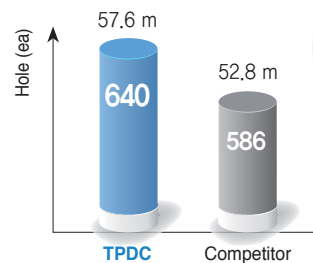

Lubricative multi-layer coating prevents chipping on cutting edges

- **Use** Part of machine
- **Workpiece** Carbon steel (SM45C, HRC40)
- **Cutting conditions**
 - Drill dia.(mm) = \varnothing 18.0
 - vc (m/min) = 60
 - fn (mm/rev) = 0.15
 - ap (mm) = 65, wet
- **Tools**
 - Inserts** TPD1800CP (PC5335)
 - Holder** TPDC5D-18025-90



Test result

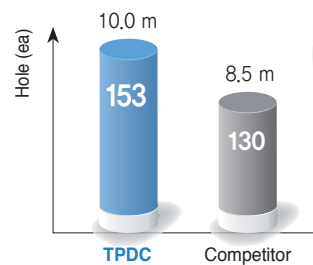

Lubricative multi-layer coating enhances wear resistance

Recommended cutting condition

Workpiece			Grade	vc (m/min)	Aspect ratio (L/D) = 3D, 5D			
ISO	Workpiece	HB			Feed rate (mm/rev) per drill dia. (mm)			
					Ø12.00~Ø15.99	Ø16.00~Ø25.99	Ø25.00~Ø30.99	
P	Carbon steel	Low carbon steel	80~120	PC5335 PC330P	110(80~140)	0.15~0.30	0.20~0.35	0.25~0.40
		High carbon steel	180~280	PC5335 PC330P	100(70~130)	0.15~0.30	0.20~0.35	0.25~0.40
	Alloy steel	Low alloy steel	140~260	PC5335 PC5300	110(80~140)	0.18~0.35	0.23~0.38	0.28~0.43
		Hardened low alloy steel	200~400	PC5335 PC5300	75(50~100)	0.18~0.35	0.23~0.38	0.28~0.43
		High alloy steel	260~320	PC5335	70(50~90)	0.18~0.30	0.20~0.35	0.25~0.40
		Hardened high alloy steel	300~450	PC5335 PC5300	60(40~80)	0.18~0.30	0.20~0.35	0.25~0.40
M	Stainless steel	Austenite series	135~275	PC330N	60(40~80)	0.05~0.15	0.10~0.20	0.15~0.25
		Ferrite series	135~275	PC330N	70(50~90)	0.10~0.20	0.15~0.30	0.20~0.35
		Martensite series	135~275	PC330N	70(50~90)	0.10~0.20	0.15~0.30	0.20~0.35
N	Non-ferrous metal	Aluminum alloy	30~150	H01	200(90~220)	0.35~0.45	0.40~0.50	0.45~0.55
		Copper alloy	150~160	H01	200(90~220)	0.35~0.45	0.40~0.50	0.45~0.55

- In case of 8D, reduce the cutting condition 40~50% lower than above after machining the beginning of hole(1.5D)
- In case of interrupted machining, reduce the feed to 0.1~0.15 around the interrupted part
- In case of 10D ~12D, follow the recommended cutting conditions below.
- In case of stainless steel machining, machine under low feed first then, set the best cutting condition checking machinability gradually

Coolant tip

- **Workpiece** SCM440 (HRC22)
- **Cutting conditions** vc (m/min) = 100, wet

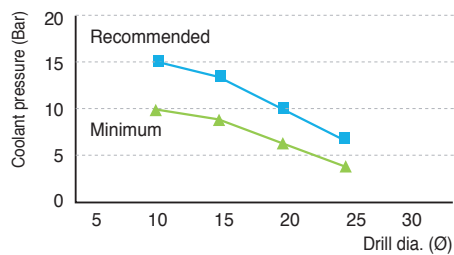
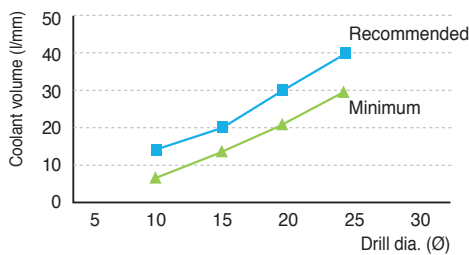

How to make good insert clamping



① Clean the mounting seat with air or cloth

② Put an insert on the holder

③ A part of wrench and B part of insert must be parallel to each other before clamp the insert
Turn the wrench clockwise to finish clamping

Clamped state

Precautions when setting

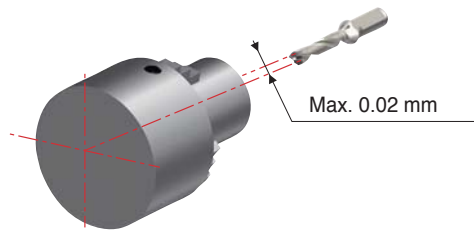

Setting of the horizontal equipment

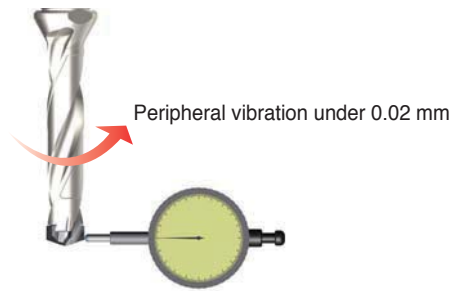

Setting of the vertical equipment

Precautions when drilling

Ramping	Overlapped	Plunging	Boring
<ol style="list-style-type: none"> 1. A slope inclined more than 6° is not allowed 2. When entering, reduce the feed to 30~50% 	<ol style="list-style-type: none"> 1. Space between panels affects chip evacuation problem 2. Do not make space between panels 	Not allowed	Not allowed

Recommended cutting conditions in deep hole (10D, 12D) drilling

• Drill with a pilot drill (recommended)

1. Drill a beginning hole (with a pilot drill)	2. Start drilling
Drill a beginning hole to the depth of 0.5D and 70% less cutting speed using a 1.5D or a 3D drill.	After replacing the drill to a new one, start drilling under the recommended cutting conditions.

• Drilling without a pilot drill

1. Drill a beginning hole (without a pilot drill)	2. Stop drilling	3. Ready for drilling	4. Start drilling
After drilling to the depth of 0.5D with 70% less cutting speed, stop drilling for 2~3 seconds without taking out the drill.	After taking out the drill without the injection of the coolant to the hole, stop machining for 2~3 seconds.	Insert the drill to the depth of 2~3 mm higher than the surface of the bottom of the hole and be ready to machine during 2~3 seconds after starting the injection of the coolant.	Start drilling under the recommended cutting conditions

TPDC Insert new

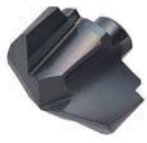

CP

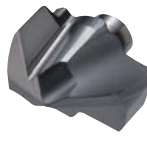

CM

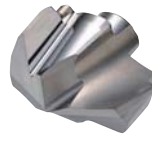

CN

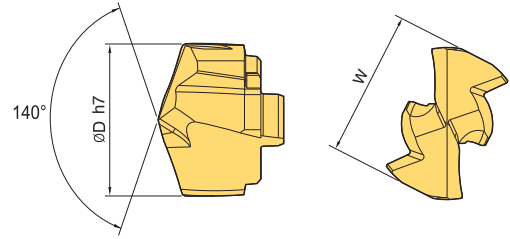

(mm)

Designation	Drill dia. (ØD)	Coated			Uncoated H01	Holder	Wrench
		PC5335	PC330P	PC330N			
TPD 1200CP,CM,CN	12.0	●				TPDC□D-12016-□	TPDC-W12
1220CP,CM,CN	12.2	●				TPDC□D-12516-□	
1250CP,CM,CN	12.5	●				TPDC□D-13016-□	
1260CP,CM,CN	12.6	●				TPDC□D-13516-□	TPDC-W13
1300CP,CM,CN	13.0	●				TPDC□D-14016-□	
1350CP,CM,CN	13.5	●				TPDC□D-14516-□	TPDC-W14
1400CP,CM,CN	14.0	●				TPDC□D-15020-□	
1420CP,CM,CN	14.2	●				TPDC□D-16020-□	TPDC-W15
1430CP,CM,CN	14.3	●				TPDC□D-17020-□	
1450CP,CM,CN	14.5	●				TPDC□D-18025-□	TPDC-W16
1500CP,CM,CN	15.0	●				TPDC□D-19025-□	
1550CP,CM,CN	15.5	●				TPDC□D-20025-□	TPDC-W17
1600CP,CM,CN	16.0	●				TPDC□D-21025-□	
1630CP,CM,CN	16.3	●				TPDC□D-22025-□	TPDC-W18
1650CP,CM,CN	16.5	●				TPDC□D-23025-□	
1670CP,CM,CN	16.7	●				TPDC□D-24032-□	TPDC-W19
1700CP,CM,CN	17.0	●				TPDC□D-25032-□	
1750CP,CM,CN	17.5	●				TPDC□D-26032-□	TPDC-W20
1770CP,CM,CN	17.7	●				TPDC□D-27032-□	
1800CP,CM,CN	18.0	●				TPDC□D-28032-□	TPDC-W21
1810CP,CM,CN	18.1	●				TPDC□D-29032-□	
1850CP,CM,CN	18.5	●				TPDC□D-30032-□	TPDC-W22
1860CP,CM,CN	18.6	●					
1870CP,CM,CN	18.7	●					TPDC-W23
1900CP,CM,CN	19.0	●					
1920CP,CM,CN	19.2	●					TPDC-W24
1950CP,CM,CN	19.5	●					
1970CP,CM,CN	19.7	●					TPDC-W25
2000CP,CM,CN	20.0	●					
2050CP,CM,CN	20.5	●					TPDC-W26
2100CP,CM,CN	21.0	●					
2150CP,CM,CN	21.5	●					TPDC-W27
2200CP,CM,CN	22.0	●					
2250CP,CM,CN	22.5	●					TPDC-W28
2260CP,CM,CN	22.6	●					
2270CP,CM,CN	22.7	●					TPDC-W29
2300CP,CM,CN	23.0	●					
2350CP,CM,CN	23.5	●					TPDC-W30
2400CP,CM,CN	24.0	●					
2450CP,CM,CN	24.5	●					TPDC-W31
2500CP,CM,CN	25.0	●					
2530CP,CM,CN	25.3	●					TPDC-W32
2550CP,CM,CN	25.5	●					
2580CP,CM,CN	25.8	●					TPDC-W33
2590CP,CM,CN	25.9	●					
2600CP,CM,CN	26.0	●					TPDC-W34
2650CP,CM,CN	26.5	●					
2700CP,CM,CN	27.0	●					TPDC-W35
2750CP,CM,CN	27.5	●					
2800CP,CM,CN	28.0	●					TPDC-W36
2850CP,CM,CN	28.5	●					
2900CP,CM,CN	29.0	●					TPDC-W37
2950CP,CM,CN	29.5	●					
3000CP,CM,CN	30.0	●					TPDC-W38
3050CP,CM,CN	30.5	●					

* We can provide if you order diameter 12.0~30.9 except for the stock items above ● : Stock Item

Parts (Recommended torque per wrench)

(mm)

Designation	Drill dia. (ØD)	Torque (N·m)
TPDC-W12	12	2.5
TPDC-W13	13	2.5
TPDC-W14	14	2.5
TPDC-W15	15	2.5
TPDC-W16	16	2.5
TPDC-W17	17	2.5

Designation	Drill dia. (ØD)	Torque (N·m)
TPDC-W18	18	2.5
TPDC-W19	19	2.5
TPDC-W20	20	3.5
TPDC-W21	21	3.5
TPDC-W22	22	3.5
TPDC-W23	23	3.5

Designation	Drill dia. (ØD)	Torque (N·m)
TPDC-W24	24	3.5
TPDC-W25	25	3.5
TPDC-W26	26	4.5
TPDC-W27	27	4.5
TPDC-W28	28	4.5
TPDC-W29	29	4.5
TPDC-W30	30	4.5



TPDC (3D/5D/8D/10D/12D) new

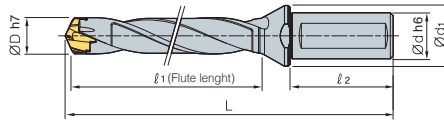

Fig.1

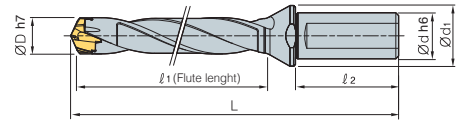

Fig.2

(mm)

Designation	ØD	Ød	Ød ₁	ℓ ₁	ℓ ₂	L	Insert	Fig.
TPDC 3D-12016-36	12.0~12.4	16	20	36	48	99	TPD1200C□-1249C□	1
3D-12516-38	12.5~12.9	16	20	38	48	101	TPD1250C□-1299C□	1
3D-13016-39	13.0~13.4	16	20	39	48	103	TPD1300C□-1349C□	1
3D-13516-41	13.5~13.9	16	20	41	48	105	TPD1350C□-1399C□	1
3D-14016-42	14.0~14.4	16	20	42	48	106	TPD1400C□-1449C□	1
3D-14516-44	14.5~14.9	16	20	44	48	107	TPD1450C□-1499C□	1
3D-15020-45	15.0~15.9	20	25	45	50	113	TPD1500C□-1599C□	2
3D-16020-48	16.0~16.9	20	25	48	50	117	TPD1600C□-1699C□	2
3D-17020-51	17.0~17.9	20	25	51	50	120	TPD1700C□-1799C□	2
3D-18025-54	18.0~18.9	25	33	54	56	132	TPD1800C□-1899C□	2
3D-19025-57	19.0~19.9	25	33	57	56	135	TPD1900C□-1999C□	2
3D-20025-60	20.0~20.9	25	33	60	56	138	TPD2000C□-2099C□	2
3D-21025-63	21.0~21.9	25	33	63	56	141	TPD2100C□-2199C□	2
3D-22025-66	22.0~22.9	25	33	66	56	145	TPD2200C□-2299C□	2
3D-23025-69	23.0~23.9	25	33	69	56	149	TPD2300C□-2399C□	2
3D-24032-72	24.0~24.9	32	43	72	60	159	TPD2400C□-2499C□	2
3D-25032-75	25.0~25.9	32	43	75	60	162	TPD2500C□-2599C□	2
3D-26032-78	26.0~26.9	32	43	78	60	173	TPD2600C□-2699C□	2
3D-27032-81	27.0~27.9	32	43	81	60	176	TPD2700C□-2799C□	2
3D-28032-84	28.0~28.9	32	43	84	60	180	TPD2800C□-2899C□	2
3D-29032-87	29.0~29.9	32	43	87	60	185	TPD2900C□-2999C□	2
3D-30032-90	30.0~30.9	32	43	90	60	188	TPD3000C□-3099C□	2
5D-12016-60	12.0~12.9	16	20	60	48	123	TPD1200C□-1249C□	1
5D-12516-63	12.5~12.9	16	20	63	48	126	TPD1250C□-1299C□	1
5D-13016-65	13.0~13.9	16	20	65	48	129	TPD1300C□-1349C□	1
5D-13516-68	13.5~13.9	16	20	68	48	132	TPD1350C□-1399C□	1
5D-14016-70	14.0~14.9	16	20	70	48	134	TPD1400C□-1449C□	1
5D-14516-73	14.5~14.9	16	20	73	48	136	TPD1450C□-1499C□	1
5D-15020-75	15.0~15.9	20	25	75	50	143	TPD1500C□-1599C□	2
5D-16020-80	16.0~16.9	20	25	80	50	149	TPD1600C□-1699C□	2
5D-17020-85	17.0~17.9	20	25	85	50	154	TPD1700C□-1799C□	2
5D-18025-90	18.0~18.9	25	33	90	56	168	TPD1800C□-1899C□	2
5D-19025-95	19.0~19.9	25	33	95	56	173	TPD1900C□-1999C□	2
5D-20025-100	20.0~20.9	25	33	100	56	178	TPD2000C□-2099C□	2
5D-21025-105	21.0~21.9	25	33	105	56	183	TPD2100C□-2199C□	2
5D-22025-110	22.0~22.9	25	33	110	56	189	TPD2200C□-2299C□	2
5D-23025-115	23.0~23.9	25	33	115	56	195	TPD2300C□-2399C□	2
5D-24032-120	24.0~24.9	32	43	120	60	207	TPD2400C□-2499C□	2
5D-25032-125	25.0~25.9	32	43	125	60	212	TPD2500C□-2599C□	2
5D-26032-130	26.0~26.9	32	43	130	60	225	TPD2600C□-2699C□	2
5D-27032-135	27.0~27.9	32	43	135	60	230	TPD2700C□-2799C□	2
5D-28032-140	28.0~28.9	32	43	140	60	236	TPD2800C□-2899C□	2
5D-29032-145	29.0~29.9	32	43	145	60	243	TPD2900C□-2999C□	2
5D-30032-150	30.0~30.9	32	43	150	60	248	TPD3000C□-3099C□	2
8D-12016-96	12.0~12.9	16	20	96	48	159	TPD1200C□-1249C□	1
8D-12516-100	12.5~12.9	16	20	100	48	163	TPD1250C□-1299C□	1
8D-13016-104	13.0~13.9	16	20	104	48	168	TPD1300C□-1349C□	1
8D-13516-108	13.5~13.9	16	20	108	48	173	TPD1350C□-1399C□	1
8D-14016-112	14.0~14.9	16	20	112	48	176	TPD1400C□-1449C□	1
8D-14516-116	14.5~14.9	16	20	116	48	180	TPD1450C□-1499C□	1
8D-15020-120	15.0~15.9	20	25	120	50	188	TPD1500C□-1599C□	2
8D-16020-128	16.0~16.9	20	25	128	50	197	TPD1600C□-1699C□	2
8D-17020-136	17.0~17.9	20	25	136	50	205	TPD1700C□-1799C□	2
8D-18025-144	18.0~18.9	25	33	144	56	222	TPD1800C□-1899C□	2
8D-19025-152	19.0~19.9	25	33	152	56	230	TPD1900C□-1999C□	2

↻ Applicable inserts G31

※ The shank is based on DIN6535 and ISO9677



TPDC (3D/5D/8D/10D/12D) new

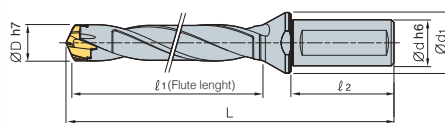

Fig.1

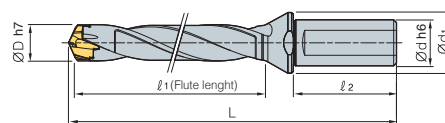

Fig.2

		(mm)							
Designation	ØD	Ød	Ød ₁	l ₁	l ₂	L	Insert	Fig.	
TPDC	8D-20025-160	20.0~20.9	25	33	160	56	238	TPD2000C□-2099C□	2
	8D-21025-168	21.0~21.9	25	33	168	56	246	TPD2100C□-2199C□	2
	8D-22025-176	22.0~22.9	25	33	176	56	255	TPD2200C□-2299C□	2
	8D-23025-184	23.0~23.9	25	33	184	56	264	TPD2300C□-2399C□	2
	8D-24032-192	24.0~24.9	32	43	192	60	279	TPD2400C□-2499C□	2
	8D-25032-200	25.0~25.9	32	43	200	60	287	TPD2500C□-2599C□	2
	8D-26032-208	26.0~26.9	32	43	208	60	303	TPD2600C□-2699C□	2
	8D-27032-216	27.0~27.9	32	43	216	60	311	TPD2700C□-2799C□	2
	8D-28032-224	28.0~28.9	32	43	224	60	320	TPD2800C□-2899C□	2
	8D-29032-232	29.0~29.9	32	43	232	60	330	TPD2900C□-2999C□	2
	8D-30032-240	30.0~30.9	32	43	240	60	338	TPD3000C□-3099C□	2
	10D-12016-120	12.0~12.4	16	20	120	48	183	TPD1200C□-1249C□	1
	10D-12516-125	12.5~12.9	16	20	125	48	188	TPD1250C□-1299C□	1
	10D-13016-130	13.0~13.4	16	20	130	48	194	TPD1300C□-1349C□	1
	10D-13516-135	13.5~13.9	16	20	135	48	199	TPD1350C□-1399C□	1
	10D-14016-140	14.0~14.4	16	20	140	48	204	TPD1400C□-1449C□	1
	10D-14516-145	14.5~14.9	16	20	145	48	208	TPD1450C□-1499C□	1
	10D-15020-150	15.0~15.9	20	25	150	50	218	TPD1500C□-1599C□	1
	10D-16020-160	16.0~16.9	20	25	160	50	229	TPD1600C□-1699C□	1
	10D-17020-170	17.0~17.9	20	25	170	50	239	TPD1700C□-1799C□	1
	10D-18025-180	18.0~18.9	25	33	180	56	258	TPD1800C□-1899C□	1
	10D-19025-190	19.0~19.9	25	33	190	56	268	TPD1900C□-1999C□	1
	10D-20025-200	20.0~20.9	25	33	200	56	278	TPD2000C□-2099C□	1
	10D-21025-210	21.0~21.9	25	33	210	56	288	TPD2100C□-2199C□	1
	10D-22025-220	22.0~22.9	25	33	220	56	299	TPD2200C□-2299C□	1
	10D-23025-230	23.0~23.9	25	33	230	56	310	TPD2300C□-2399C□	1
	10D-24032-240	24.0~24.9	32	43	240	60	327	TPD2400C□-2499C□	2
	10D-25032-250	25.0~25.9	32	43	250	60	337	TPD2500C□-2599C□	2
	10D-26032-260	26.0~26.9	32	43	260	60	355	TPD2600C□-2699C□	2
	10D-27032-270	27.0~27.9	32	43	270	60	365	TPD2700C□-2799C□	2
	10D-28032-280	28.0~28.9	32	43	280	60	376	TPD2800C□-2899C□	2
	10D-29032-290	29.0~29.9	32	43	290	60	388	TPD2900C□-2999C□	2
	10D-30032-300	30.0~30.9	32	43	300	60	398	TPD3000C□-3099C□	2
12D-12016-144	12.0~12.4	16	20	144	48	207	TPD1200C□-1249C□	1	
12D-12516-150	12.5~12.9	16	20	150	48	213	TPD1250C□-1299C□	1	
12D-13016-156	13.0~13.4	16	20	156	48	220	TPD1300C□-1349C□	1	
12D-13516-162	13.5~13.9	16	20	162	48	226	TPD1350C□-1399C□	1	
12D-14016-168	14.0~14.4	16	20	168	48	232	TPD1400C□-1449C□	1	
12D-14516-174	14.5~14.9	16	20	174	48	237	TPD1450C□-1499C□	1	
12D-15020-180	15.0~15.9	20	25	180	50	248	TPD1500C□-1599C□	1	
12D-16020-192	16.0~16.9	20	25	192	50	261	TPD1600C□-1699C□	1	
12D-17020-204	17.0~17.9	20	25	204	50	273	TPD1700C□-1799C□	1	
12D-18025-216	18.0~18.9	25	33	216	56	294	TPD1800C□-1899C□	1	
12D-19025-228	19.0~19.9	25	33	228	56	306	TPD1900C□-1999C□	1	
12D-20025-240	20.0~20.9	25	33	240	56	318	TPD2000C□-2099C□	1	
12D-21025-252	21.0~21.9	25	33	252	56	330	TPD2100C□-2199C□	1	
12D-22025-264	22.0~22.9	25	33	264	56	343	TPD2200C□-2299C□	1	
12D-23025-276	23.0~23.9	25	33	276	56	356	TPD2300C□-2399C□	1	
12D-24032-288	24.0~24.9	32	43	288	60	375	TPD2400C□-2499C□	2	
12D-25032-300	25.0~25.9	32	43	300	60	387	TPD2500C□-2599C□	2	
12D-26032-312	26.0~26.9	32	43	312	60	407	TPD2600C□-2699C□	2	
12D-27032-324	27.0~27.9	32	43	324	60	419	TPD2700C□-2799C□	2	
12D-28032-336	28.0~28.9	32	43	336	60	432	TPD2800C□-2899C□	2	
12D-29032-348	29.0~29.9	32	43	348	60	446	TPD2900C□-2999C□	2	
12D-30032-360	30.0~30.9	32	43	360	60	458	TPD3000C□-3099C□	2	

↻ Applicable inserts **G31**

※ The shank is based on DIN6535 and ISO9677

G Technical Information for TPDB Plus

Highly precise and efficient top solid indexable drill

TPDB Plus new

- Highly precise clamping system - Superior clamping precision with auto-centering system and highly precise grinding clamping parts
- Screw on clamping system - Easy to replace inserts
- Sharp cutting edge - Low cutting load and good chip control
- Holder with excellent durability - Holder with high rigidity and excellent wear resistance due to special surface treatment
- Holder with excellent chip control - Low cutting resistance and outstanding chip evaluation applying high helix angle

Code system of holder



Code system of insert



Features

- Special surface treatment**
 - Improved durability of a holder
- Screw on clamping system**
- Auto-centering system**
- High helix angle**
 - High productivity
 - Stable chip evacuation realizes stable machinability
 - Improved cutting conditions decrease cycle time.
 - High processing grade
 - Good surface finish and regular size of the hole
- Advanced chip control due to a chip breaker**
- Cutting edge with low cutting resistance**
 - Low cutting load and excellent chip control
- 20% higher productivity**
 - Applying flute with higher helix angle than TPDB's

The diagram compares the TPDB Plus (left) with the standard TPDB (right), showing that the TPDB Plus has a higher helix angle and a chip breaker, leading to 20% higher productivity.

Application range

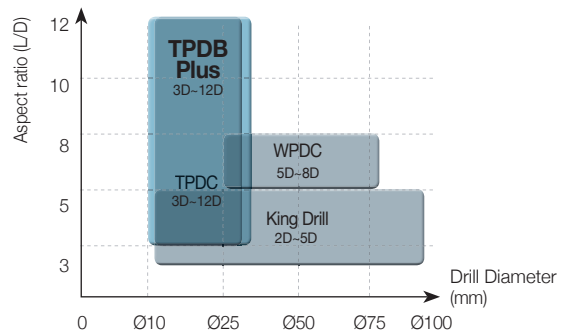
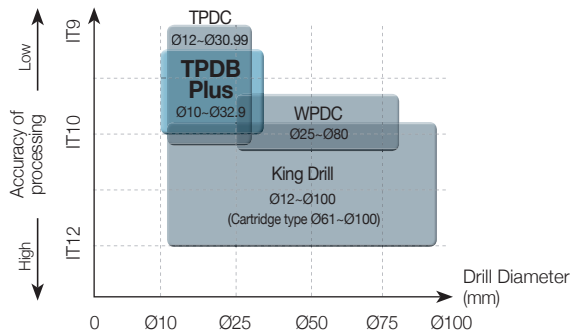

Tools	Application range					
	Drill Diameter (Ø)	Aspect ratio (L/D)	Tolerance of drill dia.	Tolerance	Surface finish of hole (Ra)	Workpiece
TPDB Plus	10-32.9 mm	3, 5, 8, 10, 12	h7	IT10	≤ 2.0µm	P, K

Performance evaluation

Run-out

- **Workpiece** Alloy steel (SCM440)
- **Cutting conditions** Drill dia.(mm) = Ø25, vc (m/min) = 90
fn (mm/rev) = 0.25, ap (mm) = 120, wet (20 bar)
- **Tools** TPDB250-32-5-P(PC5300)

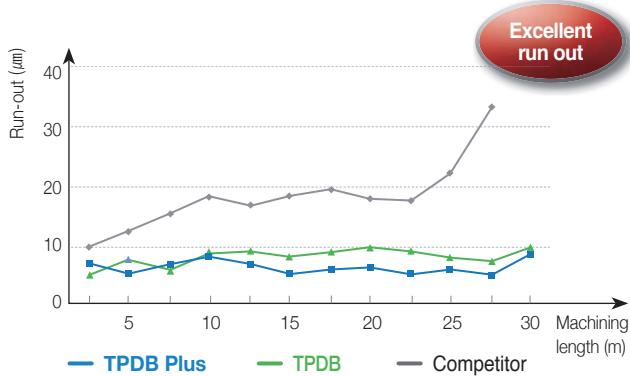

Cutting load

- **Workpiece** Alloy steel (SCM440)
- **Cutting conditions** Drill dia.(mm) = Ø25, vc (m/min) = 120
fn (mm/rev) = 0.25, ap (mm) = 120, wet (20 bar)
- **Tools** TPDB250-32-5-P (PC5300)

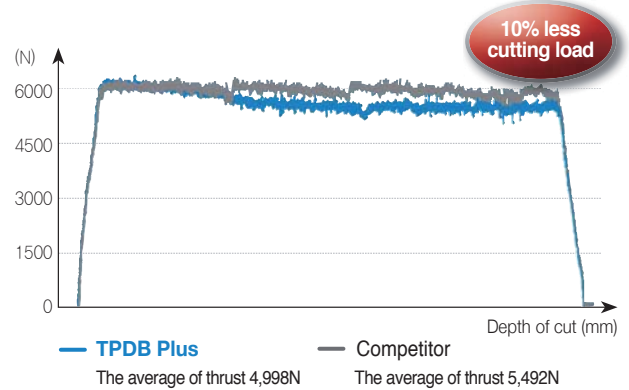

Outstanding roundness of hole

- **Workpiece** Alloy steel (SCM440)
- **Cutting conditions** Drill dia.(mm) = Ø25, vc (m/min) = 90/120, fn (mm/rev) = 0.25/0.35, ap (mm) = 120, wet (20 bar)
- **Tools** TPDB250-32-5-P (PC5300)

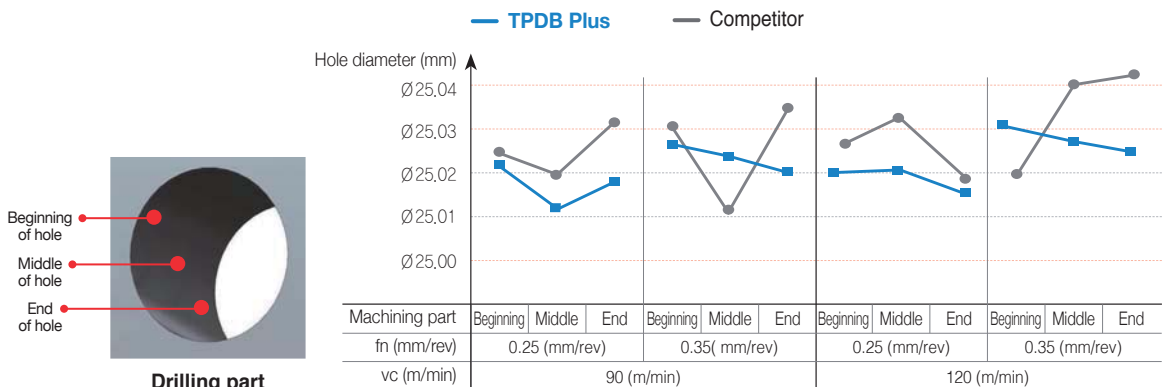

Recommended Cutting Conditions





Workpiece			Grade	vc (m/min)	Aspect ratio (L/D) = 3D, 5D			
ISO	Workpiece	HB			Feed rate (mm/rev) per drill dia. (mm)			
					Ø10~Ø16.9	Ø17~Ø26.9	Ø27~Ø32.9	
P	Carbon steel	Low carbon steel	80~120	PC5335 PC330P	110(80~140)	0.15~0.30	0.20~0.35	0.25~0.40
		High carbon steel	180~280	PC5335 PC330P	100(70~130)	0.15~0.30	0.20~0.35	0.25~0.40
	Alloy steel	Low alloy steel	140~260	PC5300	110(80~140)	0.18~0.35	0.23~0.38	0.28~0.43
		Low alloy heat treated steel	200~400	PC5300	75(50~100)	0.18~0.35	0.23~0.38	0.28~0.43
		High alloy steel	50~260	PC5300	70(50~90)	0.18~0.30	0.20~0.35	0.25~0.40
		High alloy heat treated steel	220~450	PC5300	60(40~80)	0.18~0.30	0.20~0.35	0.25~0.40
K	Cast iron	Gray cast iron	150~230	PC5300	110(80~140)	0.18~0.35	0.20~0.40	0.25~0.45
		Ductile cast iron	160~260	PC5300	100(70~130)	0.18~0.35	0.20~0.40	0.25~0.45

※ In case of 8D, machine in 20-30% lower cutting conditions than the mentioned above, or machine the beginning of hole (1.5D) before drilling.

※ In interrupted machining, reduce the feed to 0.1-0.15 machining around the interrupted part.

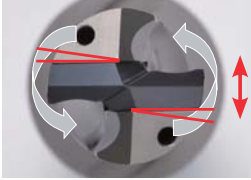
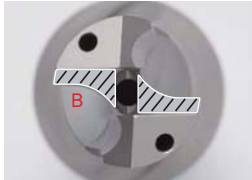
※ Prefer to the 'Recommended drilling method' on the page 37 for drilling of 10D -12D

Replacement of Holders and Screws

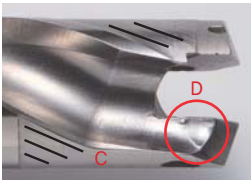
Worn part	How to check	Description
[Pic.1] 	[Pic.2] Check the gap 	<ul style="list-style-type: none"> In case of drilling for a long time as shown in the [Pic.1] the 'A' part is torn and twisted due to torque. As shown in the [Pic.2] check the gap between the insert and the tip seat turning the clamped insert from side to side. If there is a gap between them, replace the used holder to a new one.
[Pic.3] 	[Pic.4] Check the moving 	<ul style="list-style-type: none"> The insert could move up or down due to the load on the Z-axis in drilling over an extended period of time which causes wear on the 'B' part as shown the [Pic.3]. After clamping an insert, if the insert is moving or there is a gap between the insert and the tip seat as shown in the [Pic.4] replace the used holder to a new one.
[Pic.5] 	Check the moving 	<ul style="list-style-type: none"> After an extended period of use, the screw can be worn as shown in the 'E' part of [Pic.5] which could decrease the clamping force of the insert. When the screw is worn, replace the old screw to a new one among the enclosed extras. Spreading the grease on the screw makes it last longer.
[Pic.6] ① Check the 'C' and 'D' parts as shown in the [Pic.6] ② Check whether the chips are getting longer or not.		<ul style="list-style-type: none"> Winding or jamming of long and tiny chips in drilling causes wear or scratch on the 'C' part as shown in the [Pic.6] due to chattering from machining in improper cutting conditions. In that case, reset the cutting conditions and check the Run-out before machining. The excessive wear of the part 'D' as shown in the [Pic.6] relating to chip curling might cause long chips.

How to Clamp a TPDB Plus Insert

Clamping an insert to a holder



- ❶ Put an insert on the tip seat of the holder.
- ❷ As the [Pic.1], push the insert to the v-shaped groove of the holder.
- ❸ Screw and clamp the insert.

Changing the used insert to a new one



- ❶ Unscrew and separate the used insert from the holder.
- ❷ As the [Pic.2], clean the insert seat.
- ❸ Put a new insert on the tip seat.
- ❹ As the [Pic.3], clamp the insert pushing it with a hand not to separate from the holder.

Precaution in Drilling

Drilling of angled entrance



1. The approach angle between drill and the workpiece at the beginning should be less than 6°.
2. Reduce the feed to 30-50% than general cutting conditions at the beginning and the end of angled surface.

Drilling of stacked plates



1. Gap between the plates could make wrong chip evacuation causing fracture of the drill.
2. Place the workpiece, stacked plates without any gap between each.

Plunging



1. Irregular cutting resistance in plunging could cause fracture and deformation of the drill.

Boring



1. Boring is not recommended due to wear and chipping in the corner of the insert.

Check Point in Drilling

- Condition of the clamped workpiece
- Revolution of the main axis of the machine
- Condition of the holder
- Run-out of the clamped drill (Max. 0.03 mm)
- Condition of supplying coolant (pressure, floconcentration)
- Chip evacuation

Supply of Coolant

- Supply enough coolant to the beginning of the hole.
- Minimum pressure of oil coolant: 5 bar
- Minimum flow of coolant: 5 l/min

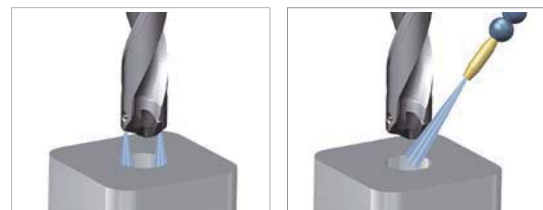

Recommended Drilling Method (10D, 12D)

Machine a beginning hole (with a pilot drill)



- Machine a beginning hole with the depth of cut as 0.5D and at 30% lower speed using a 1.5D or 3D drill.

Start drilling

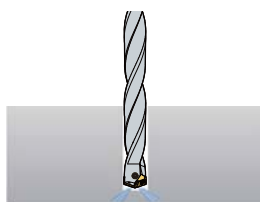

- After machining the beginning hole, replace the pilot drill to a drill for drilling and machine in recommended cutting conditions.

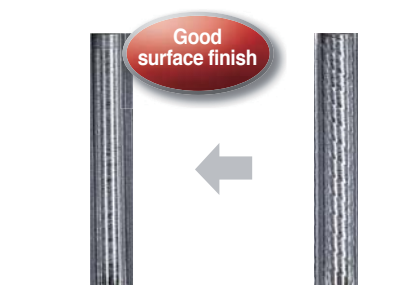

Result of recommended drilling

Result of general drilling

TPDB Plus Insert new

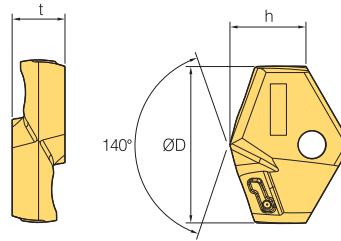
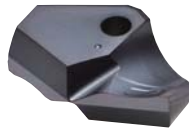

Designation	Coated			ØD	h	t
	PC5300	PC5335	PC330P			
TPD 100B~109B	●			10.0 ~ 10.9	5.5	3.5
110B~119B	●	●		11.0 ~ 11.9	5.8	3.5
120B~129B	●	●		12.0 ~ 12.9	6.3	3.5
130B~139B	●			13.0 ~ 13.9	6.5	4.0
140B~149B	●	●		14.0 ~ 14.9	6.8	4.0
150B~159B	●	●		15.0 ~ 15.9	7.0	4.0
160B~169B	●	●		16.0 ~ 16.9	7.7	5.5
170B~179B	●	●		17.0 ~ 17.9	7.9	5.5
180B~189B	●	●		18.0 ~ 18.9	8.1	6.0
190B~199B	●	●		19.0 ~ 19.9	8.3	6.0
200B~209B	●	●		20.0 ~ 20.9	9.7	6.5
210B~219B	●	●		21.0 ~ 21.9	9.4	6.5
220B~229B	●	●		22.0 ~ 22.9	9.6	7.0
230B~239B	●	●		23.0 ~ 23.9	9.8	7.0
240B~249B	●	●		24.0 ~ 24.9	10.7	7.5
250B~259B	●	●		25.0 ~ 25.9	10.9	7.5
260B~269B	●	●		26.0 ~ 26.9	11.0	8.5
270B~279B	●			27.0 ~ 27.9	11.8	8.5
280B~289B	●			28.0 ~ 28.9	12.6	9.5
290B~299B	●			29.0 ~ 29.9	12.9	9.5
300B~309B	●			30.0 ~ 30.9	13.0	10.0
310B~319B	●			31.0 ~ 31.9	13.2	10.0
320B~329B	●			32.0 ~ 32.9	13.4	10.0

● : Stock Item

Parts

Designation	Drill dia. (ØD)	Screw	Wrench	Torque (N·m)
TPD 100B~129B	10.0 ~ 12.9	FTNB0209-P	TW06P	0.4
130B~149B	13.0 ~ 14.9	FTNB02512-P	TW07S	0.8
150B~179B	15.0 ~ 17.9	FTNB02514-P	TW07S	0.8
180B~199B	18.0 ~ 19.9	FTNB0316-P	TW09S	1.2
200B~239B	20.0 ~ 23.9	FTNB0319	TW09S	1.2
240B~259B	24.0 ~ 25.9	FTNB03522	TW15S	3.0
260B~279B	26.0 ~ 27.9	FTNB03524	TW15S	3.0
280B~299B	28.0 ~ 29.9	FTNB0426	TW15S	3.0
300B~329B	30.0 ~ 32.9	FTNB0528	TW20-100	4.0



TPDB Plus (3D) new

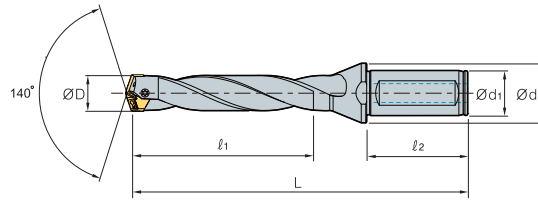

(mm)

Designation	ØD	Ød ₁	Ød ₂	ℓ ₁	ℓ ₂	L	Insert
TPDB 100-16-3-P	10.0 ~ 10.4	16	20	30.0	48	95	TPD100B ~ 104B
105-16-3-P	10.5 ~ 10.9	16	20	31.5	48	96	TPD105B ~ 109B
110-16-3-P	11.0 ~ 11.4	16	20	33.0	48	98	TPD110B ~ 114B
115-16-3-P	11.5 ~ 11.9	16	20	34.5	48	99	TPD115B ~ 119B
120-16-3-P	12.0 ~ 12.4	16	20	36.0	48	102	TPD120B ~ 124B
125-16-3-P	12.5 ~ 12.9	16	20	37.5	48	104	TPD125B ~ 129B
130-16-3-P	13.0 ~ 13.4	16	20	39.0	48	107	TPD130B ~ 134B
135-16-3-P	13.5 ~ 13.9	16	20	40.5	48	109	TPD135B ~ 139B
140-16-3-P	14.0 ~ 14.4	16	20	42.0	48	111	TPD140B ~ 144B
145-16-3-P	14.5 ~ 14.9	16	20	43.5	48	114	TPD145B ~ 149B
150-20-3-P	15.0 ~ 15.4	20	25	45.0	50	118	TPD150B ~ 154B
155-20-3-P	15.5 ~ 15.9	20	25	46.5	50	120	TPD155B ~ 159B
160-20-3-P	16.0 ~ 16.4	20	25	48.0	50	122	TPD160B ~ 164B
165-20-3-P	16.5 ~ 16.9	20	25	49.5	50	124	TPD165B ~ 169B
170-20-3-P	17.0 ~ 17.4	20	25	51.0	50	127	TPD170B ~ 174B
175-20-3-P	17.5 ~ 17.9	20	25	52.5	50	129	TPD175B ~ 179B
180-25-3-P	18.0 ~ 18.4	25	33	54.0	56	137	TPD180B ~ 184B
185-25-3-P	18.5 ~ 18.9	25	33	55.5	56	139	TPD185B ~ 189B
190-25-3-P	19.0 ~ 19.4	25	33	57.0	56	142	TPD190B ~ 194B
195-25-3-P	19.5 ~ 19.9	25	33	58.5	56	144	TPD195B ~ 199B
200-25-3-P	20.0 ~ 20.4	25	33	60.0	56	146	TPD200B ~ 204B
205-25-3-P	20.5 ~ 20.9	25	33	61.5	56	148	TPD205B ~ 209B
210-25-3-P	21.0 ~ 21.4	25	33	63.0	60	151	TPD210B ~ 214B
215-25-3-P	21.5 ~ 21.9	25	33	64.5	60	153	TPD215B ~ 219B
220-25-3-P	22.0 ~ 22.4	25	33	66.0	60	155	TPD220B ~ 224B
225-25-3-P	22.5 ~ 22.9	25	33	67.5	60	157	TPD225B ~ 229B
230-25-3-P	23.0 ~ 23.4	25	33	69.0	60	160	TPD230B ~ 234B
235-25-3-P	23.5 ~ 23.9	25	33	70.5	60	162	TPD235B ~ 239B
240-32-3-P	24.0 ~ 24.4	32	43	72.0	60	168	TPD240B ~ 244B
245-32-3-P	24.5 ~ 24.9	32	43	73.5	60	170	TPD245B ~ 249B
250-32-3-P	25.0 ~ 25.4	32	43	75.0	60	173	TPD250B ~ 254B
255-32-3-P	25.5 ~ 25.9	32	43	76.5	60	175	TPD255B ~ 259B
260-32-3-P	26.0 ~ 26.9	32	43	78.0	60	177	TPD260B ~ 269B
270-32-3-P	27.0 ~ 27.9	32	43	81.0	60	182	TPD270B ~ 279B
280-32-3-P	28.0 ~ 28.9	32	43	84.0	60	186	TPD280B ~ 289B
290-32-3-P	29.0 ~ 29.9	32	43	87.0	60	191	TPD290B ~ 299B
300-32-3-P	30.0 ~ 30.9	32	43	90.0	60	195	TPD300B ~ 309B
310-32-3-P	31.0 ~ 31.9	32	43	93.0	60	200	TPD310B ~ 319B
320-32-3-P	32.0 ~ 32.9	32	43	96.0	60	204	TPD320B ~ 329B

↻ Applicable inserts G38

TPDB Plus (5D) new

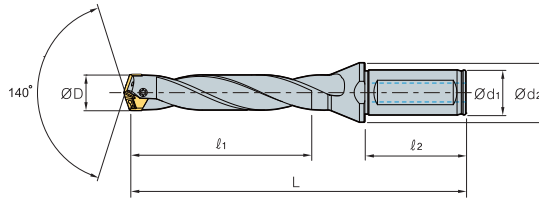

(mm)

Designation	ØD	Ød ₁	Ød ₂	ℓ ₁	ℓ ₂	L	Insert
TPDB 100-16-5-P	10.0 ~ 10.4	16	20	50.0	48	115	TPD100B ~ 104B
105-16-5-P	10.5 ~ 10.9	16	20	52.5	48	117	TPD105B ~ 109B
110-16-5-P	11.0 ~ 11.4	16	20	55.0	48	120	TPD110B ~ 114B
115-16-5-P	11.5 ~ 11.9	16	20	57.5	48	123	TPD115B ~ 119B
120-16-5-P	12.0 ~ 12.4	16	20	60.0	48	126	TPD120B ~ 124B
125-16-5-P	12.5 ~ 12.9	16	20	62.5	48	129	TPD125B ~ 129B
130-16-5-P	13.0 ~ 13.4	16	20	65.0	48	133	TPD130B ~ 134B
135-16-5-P	13.5 ~ 13.9	16	20	67.5	48	136	TPD135B ~ 139B
140-16-5-P	14.0 ~ 14.4	16	20	70.0	48	139	TPD140B ~ 144B
145-16-5-P	14.5 ~ 14.9	16	20	72.5	48	143	TPD145B ~ 149B
150-20-5-P	15.0 ~ 15.4	20	25	75.0	50	148	TPD150B ~ 154B
155-20-5-P	15.5 ~ 15.9	20	25	77.5	50	151	TPD155B ~ 159B
160-20-5-P	16.0 ~ 16.4	20	25	80.0	50	154	TPD160B ~ 164B
165-20-5-P	16.5 ~ 16.9	20	25	82.5	50	157	TPD165B ~ 169B
170-20-5-P	17.0 ~ 17.4	20	25	85.0	50	161	TPD170B ~ 174B
175-20-5-P	17.5 ~ 17.9	20	25	87.5	50	164	TPD175B ~ 179B
180-25-5-P	18.0 ~ 18.4	25	33	90.0	56	173	TPD180B ~ 184B
185-25-5-P	18.5 ~ 18.9	25	33	92.5	56	176	TPD185B ~ 189B
190-25-5-P	19.0 ~ 19.4	25	33	95.0	56	180	TPD190B ~ 194B
195-25-5-P	19.5 ~ 19.9	25	33	97.5	56	183	TPD195B ~ 199B
200-25-5-P	20.0 ~ 20.4	25	33	100.0	56	186	TPD200B ~ 204B
205-25-5-P	20.5 ~ 20.9	25	33	102.5	56	189	TPD205B ~ 209B
210-25-5-P	21.0 ~ 21.4	25	33	105.0	60	193	TPD210B ~ 214B
215-25-5-P	21.5 ~ 21.9	25	33	107.5	60	196	TPD215B ~ 219B
220-25-5-P	22.0 ~ 22.4	25	33	110.0	60	199	TPD220B ~ 224B
225-25-5-P	22.5 ~ 22.9	25	33	112.5	60	202	TPD225B ~ 229B
230-25-5-P	23.0 ~ 23.4	25	33	115.0	60	206	TPD230B ~ 234B
235-25-5-P	23.5 ~ 23.9	25	33	117.5	60	209	TPD235B ~ 239B
240-32-5-P	24.0 ~ 24.4	32	43	120.0	60	216	TPD240B ~ 244B
245-32-5-P	24.5 ~ 24.9	32	43	122.5	60	219	TPD245B ~ 249B
250-32-5-P	25.0 ~ 25.4	32	43	125.0	60	223	TPD250B ~ 254B
255-32-5-P	25.5 ~ 25.9	32	43	127.5	60	226	TPD255B ~ 259B
260-32-5-P	26.0 ~ 26.9	32	43	130.0	60	229	TPD260B ~ 269B
270-32-5-P	27.0 ~ 27.9	32	43	135.0	60	236	TPD270B ~ 279B
280-32-5-P	28.0 ~ 28.9	32	43	140.0	60	242	TPD280B ~ 289B
290-32-5-P	29.0 ~ 29.9	32	43	145.0	60	249	TPD290B ~ 299B
300-32-5-P	30.0 ~ 30.9	32	43	150.0	60	255	TPD300B ~ 309B
310-32-5-P	31.0 ~ 31.9	32	43	155.0	60	262	TPD310B ~ 319B
320-32-5-P	32.0 ~ 32.9	32	43	160.0	60	268	TPD320B ~ 329B

↻ Applicable inserts **G38**



TPDB Plus (8D) new

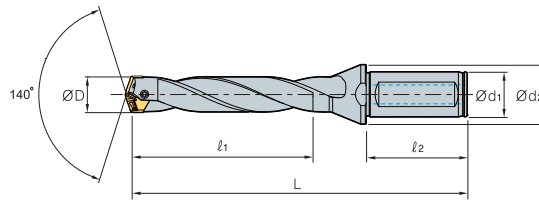

(mm)

Designation	ØD	Ød ₁	Ød ₂	ℓ ₁	ℓ ₂	L	Insert
TPDB 100-16-8-P	10.0 ~ 10.4	16	20	80	48	145	TPD100B ~ 104B
105-16-8-P	10.5 ~ 10.9	16	20	84	48	149	TPD105B ~ 109B
110-16-8-P	11.0 ~ 11.4	16	20	88	48	153	TPD110B ~ 114B
115-16-8-P	11.5 ~ 11.9	16	20	92	48	157	TPD115B ~ 119B
120-16-8-P	12.0 ~ 12.4	16	20	96	48	162	TPD120B ~ 124B
125-16-8-P	12.5 ~ 12.9	16	20	100	48	166.5	TPD125B ~ 129B
130-16-8-P	13.0 ~ 13.4	16	20	104	48	172	TPD130B ~ 134B
135-16-8-P	13.5 ~ 13.9	16	20	108	48	176.5	TPD135B ~ 139B
140-16-8-P	14.0 ~ 14.4	16	20	112	48	181	TPD140B ~ 144B
145-16-8-P	14.5 ~ 14.9	16	20	116	48	186.5	TPD145B ~ 149B
150-20-8-P	15.0 ~ 15.4	20	25	120	50	193	TPD150B ~ 154B
155-20-8-P	15.5 ~ 15.9	20	25	124	50	197.5	TPD155B ~ 159B
160-20-8-P	16.0 ~ 16.4	20	25	128	50	202	TPD160B ~ 164B
165-20-8-P	16.5 ~ 16.9	20	25	132	50	206.5	TPD165B ~ 169B
170-20-8-P	17.0 ~ 17.4	20	25	136	50	212	TPD170B ~ 174B
175-20-8-P	17.5 ~ 17.9	20	25	140	50	216.5	TPD175B ~ 179B
180-25-8-P	18.0 ~ 18.4	25	33	144	56	227	TPD180B ~ 184B
185-25-8-P	18.5 ~ 18.9	25	33	148	56	231.5	TPD185B ~ 189B
190-25-8-P	19.0 ~ 19.4	25	33	152	56	237	TPD190B ~ 194B
195-25-8-P	19.5 ~ 19.9	25	33	156	56	241.5	TPD195B ~ 199B
200-25-8-P	20.0 ~ 20.4	25	33	160	56	246	TPD200B ~ 204B
205-25-8-P	20.5 ~ 20.9	25	33	164	56	250.5	TPD205B ~ 209B
210-25-8-P	21.0 ~ 21.4	25	33	168	60	256	TPD210B ~ 214B
215-25-8-P	21.5 ~ 21.9	25	33	172	60	260.5	TPD215B ~ 219B
220-25-8-P	22.0 ~ 22.4	25	33	176	60	265	TPD220B ~ 224B
225-25-8-P	22.5 ~ 22.9	25	33	180	60	269.5	TPD225B ~ 229B
230-25-8-P	23.0 ~ 23.4	25	33	184	60	275	TPD230B ~ 234B
235-25-8-P	23.5 ~ 23.9	25	33	188	60	279.5	TPD235B ~ 239B
240-32-8-P	24.0 ~ 24.4	32	43	192	60	288	TPD240B ~ 244B
245-32-8-P	24.5 ~ 24.9	32	43	196	60	292.5	TPD245B ~ 249B
250-32-8-P	25.0 ~ 25.4	32	43	200	60	298	TPD250B ~ 254B
255-32-8-P	25.5 ~ 25.9	32	43	204	60	302.5	TPD255B ~ 259B
260-32-8-P	26.0 ~ 26.9	32	43	208	60	307	TPD260B ~ 269B
270-32-8-P	27.0 ~ 27.9	32	43	216	60	317	TPD270B ~ 279B
280-32-8-P	28.0 ~ 28.9	32	43	224	60	326	TPD280B ~ 289B
290-32-8-P	29.0 ~ 29.9	32	43	232	60	336	TPD290B ~ 299B
300-32-8-P	30.0 ~ 30.9	32	43	240	60	344	TPD300B ~ 309B
310-32-8-P	31.0 ~ 31.9	32	43	248	60	354	TPD310B ~ 319B
320-32-8-P	32.0 ~ 32.9	32	43	256	60	361	TPD320B ~ 329B

↻ Applicable inserts G38

TPDB Plus (10D) new

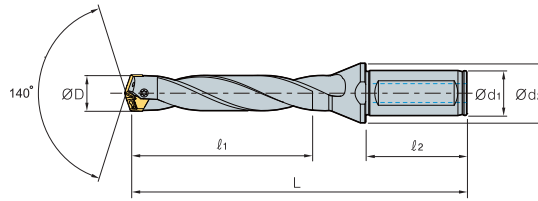

(mm)

Designation	ØD	Ød ₁	Ød ₂	ℓ ₁	ℓ ₂	L	Insert
TPDB 100-16-10-P	10.0 ~ 10.4	16	20	100	48	165	TPD100B ~ 104B
105-16-10-P	10.5 ~ 10.9	16	20	105	48	170	TPD105B ~ 109B
110-16-10-P	11.0 ~ 11.4	16	20	110	48	175	TPD110B ~ 114B
115-16-10-P	11.5 ~ 11.9	16	20	115	48	180	TPD115B ~ 119B
120-16-10-P	12.0 ~ 12.4	16	20	120	48	186	TPD120B ~ 124B
125-16-10-P	12.5 ~ 12.9	16	20	125	48	191.5	TPD125B ~ 129B
130-16-10-P	13.0 ~ 13.4	16	20	130	48	198	TPD130B ~ 134B
135-16-10-P	13.5 ~ 13.9	16	20	135	48	203.5	TPD135B ~ 139B
140-16-10-P	14.0 ~ 14.4	16	20	140	48	209	TPD140B ~ 144B
145-16-10-P	14.5 ~ 14.9	16	20	145	48	215.5	TPD145B ~ 149B
150-20-10-P	15.0 ~ 15.4	20	25	150	50	223	TPD150B ~ 154B
155-20-10-P	15.5 ~ 15.9	20	25	155	50	228.5	TPD155B ~ 159B
160-20-10-P	16.0 ~ 16.4	20	25	160	50	234	TPD160B ~ 164B
165-20-10-P	16.5 ~ 16.9	20	25	165	50	239.5	TPD165B ~ 169B
170-20-10-P	17.0 ~ 17.4	20	25	170	50	246	TPD170B ~ 174B
175-20-10-P	17.5 ~ 17.9	20	25	175	50	251.5	TPD175B ~ 179B
180-25-10-P	18.0 ~ 18.4	25	33	180	56	263	TPD180B ~ 184B
185-25-10-P	18.5 ~ 18.9	25	33	185	56	268.5	TPD185B ~ 189B
190-25-10-P	19.0 ~ 19.4	25	33	190	56	275	TPD190B ~ 194B
195-25-10-P	19.5 ~ 19.9	25	33	195	56	280.5	TPD195B ~ 199B
200-25-10-P	20.0 ~ 20.4	25	33	200	56	286	TPD200B ~ 204B
205-25-10-P	20.5 ~ 20.9	25	33	205	56	291.5	TPD205B ~ 209B
210-25-10-P	21.0 ~ 21.4	25	33	210	60	298	TPD210B ~ 214B
215-25-10-P	21.5 ~ 21.9	25	33	215	60	303.5	TPD215B ~ 219B
220-25-10-P	22.0 ~ 22.4	25	33	220	60	309	TPD220B ~ 224B
225-25-10-P	22.5 ~ 22.9	25	33	225	60	314.5	TPD225B ~ 229B
230-25-10-P	23.0 ~ 23.4	25	33	230	60	321	TPD230B ~ 234B
235-25-10-P	23.5 ~ 23.9	25	33	235	60	326.5	TPD235B ~ 239B
240-32-10-P	24.0 ~ 24.4	32	43	240	60	336	TPD240B ~ 244B
245-32-10-P	24.5 ~ 24.9	32	43	245	60	341.5	TPD245B ~ 249B
250-32-10-P	25.0 ~ 25.4	32	43	250	60	348	TPD250B ~ 254B
255-32-10-P	25.5 ~ 25.9	32	43	255	60	353.5	TPD255B ~ 259B
260-32-10-P	26.0 ~ 26.9	32	43	260	60	359	TPD260B ~ 269B
270-32-10-P	27.0 ~ 27.9	32	43	270	60	371	TPD270B ~ 279B
280-32-10-P	28.0 ~ 28.9	32	43	280	60	382	TPD280B ~ 289B
290-32-10-P	29.0 ~ 29.9	32	43	290	60	394	TPD290B ~ 299B
300-32-10-P	30.0 ~ 30.9	32	43	300	60	404	TPD300B ~ 309B
310-32-10-P	31.0 ~ 31.9	32	43	310	60	416	TPD310B ~ 319B
320-32-10-P	32.0 ~ 32.9	32	43	320	60	425	TPD320B ~ 329B

Applicable inserts G38



TPDB Plus (12D) new

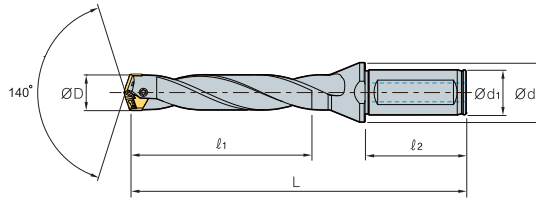

(mm)

Designation	ØD	Ød ₁	Ød ₂	ℓ ₁	ℓ ₂	L	Insert
TPDB 100-16-12-P	10.0 ~ 10.4	16	20	120	48	185	TPD100B ~ 104B
105-16-12-P	10.5 ~ 10.9	16	20	126	48	191	TPD105B ~ 109B
110-16-12-P	11.0 ~ 11.4	16	20	132	48	197	TPD110B ~ 114B
115-16-12-P	11.5 ~ 11.9	16	20	138	48	203	TPD115B ~ 119B
120-16-12-P	12.0 ~ 12.4	16	20	144	48	210	TPD120B ~ 124B
125-16-12-P	12.5 ~ 12.9	16	20	150	48	216.5	TPD125B ~ 129B
130-16-12-P	13.0 ~ 13.4	16	20	156	48	224	TPD130B ~ 134B
135-16-12-P	13.5 ~ 13.9	16	20	162	48	230.5	TPD135B ~ 139B
140-16-12-P	14.0 ~ 14.4	16	20	168	48	237	TPD140B ~ 144B
145-16-12-P	14.5 ~ 14.9	16	20	174	48	244.5	TPD145B ~ 149B
150-20-12-P	15.0 ~ 15.4	20	25	180	50	253	TPD150B ~ 154B
155-20-12-P	15.5 ~ 15.9	20	25	186	50	259.5	TPD155B ~ 159B
160-20-12-P	16.0 ~ 16.4	20	25	192	50	266	TPD160B ~ 164B
165-20-12-P	16.5 ~ 16.9	20	25	198	50	272.5	TPD165B ~ 169B
170-20-12-P	17.0 ~ 17.4	20	25	204	50	280	TPD170B ~ 174B
175-20-12-P	17.5 ~ 17.9	20	25	210	50	286.5	TPD175B ~ 179B
180-25-12-P	18.0 ~ 18.4	25	33	216	56	299	TPD180B ~ 184B
185-25-12-P	18.5 ~ 18.9	25	33	222	56	305.5	TPD185B ~ 189B
190-25-12-P	19.0 ~ 19.4	25	33	228	56	313	TPD190B ~ 194B
195-25-12-P	19.5 ~ 19.9	25	33	234	56	319.5	TPD195B ~ 199B
200-25-12-P	20.0 ~ 20.4	25	33	240	56	326	TPD200B ~ 204B
205-25-12-P	20.5 ~ 20.9	25	33	246	56	332.5	TPD205B ~ 209B
210-25-12-P	21.0 ~ 21.4	25	33	252	60	340	TPD210B ~ 214B
215-25-12-P	21.5 ~ 21.9	25	33	258	60	346.5	TPD215B ~ 219B
220-25-12-P	22.0 ~ 22.4	25	33	264	60	353	TPD220B ~ 224B
225-25-12-P	22.5 ~ 22.9	25	33	270	60	359.5	TPD225B ~ 229B
230-25-12-P	23.0 ~ 23.4	25	33	276	60	367	TPD230B ~ 234B
235-25-12-P	23.5 ~ 23.9	25	33	282	60	373.5	TPD235B ~ 239B
240-32-12-P	24.0 ~ 24.4	32	43	288	60	384	TPD240B ~ 244B
245-32-12-P	24.5 ~ 24.9	32	43	294	60	390.5	TPD245B ~ 249B
250-32-12-P	25.0 ~ 25.4	32	43	300	60	398	TPD250B ~ 254B
255-32-12-P	25.5 ~ 25.9	32	43	306	60	404.5	TPD255B ~ 259B
260-32-12-P	26.0 ~ 26.9	32	43	312	60	411	TPD260B ~ 269B
270-32-12-P	27.0 ~ 27.9	32	43	324	60	425	TPD270B ~ 279B
280-32-12-P	28.0 ~ 28.9	32	43	336	60	438	TPD280B ~ 289B
290-32-12-P	29.0 ~ 29.9	32	43	348	60	452	TPD290B ~ 299B
300-32-12-P	30.0 ~ 30.9	32	43	360	60	464	TPD300B ~ 309B
310-32-12-P	31.0 ~ 31.9	32	43	372	60	478	TPD310B ~ 319B
320-32-12-P	32.0 ~ 32.9	32	43	384	60	489	TPD320B ~ 329B

↻ Applicable inserts G38

G Technical Information for TPDB-H

The exclusive top solid indexable drill for steel-frame structure, H-Beam

TPDB-H new

- The highly efficient and exclusive top solid indexable drill for steel-frame structures such as H-Beam, steel sheet, etc
- High precision clamping system: High precision clamping due highly precise grinding and auto-centering
- Screw on clamping system: Easy to replace insert
- Edge design with excellent centering: Low cutting load and good chip control
- High durability holder: Improved wear resistance and durability with special surface treatment implementation
- Holder with good chip evacuation: Good chip evacuation and reduced cutting load with high helix angle
- Optimally designed oil hole: Long tool life

🔗 Code system of holder



🔗 Code system of insert

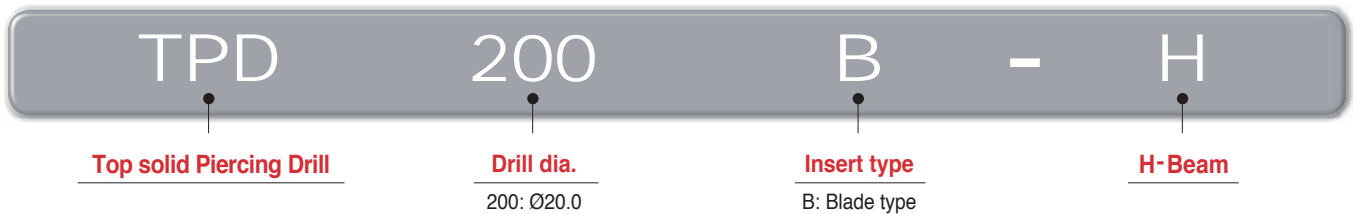

🔗 Features of insert

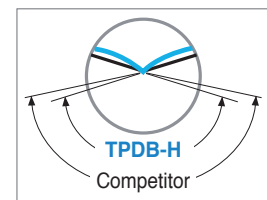
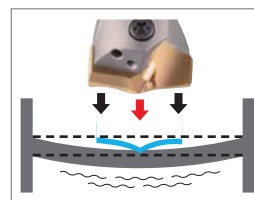
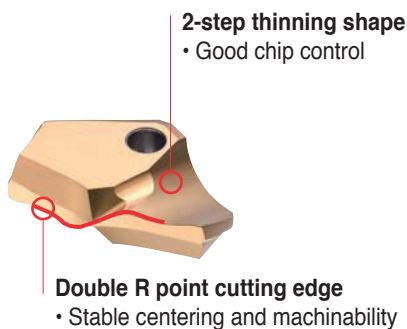

- ↓ Applied Double R point edge design is optimized for excellent centering and stable machinability
- ↓ Machinability and productivity are improved by minimizing both workpiece's bending and chipping at edge corner section

Features of holder

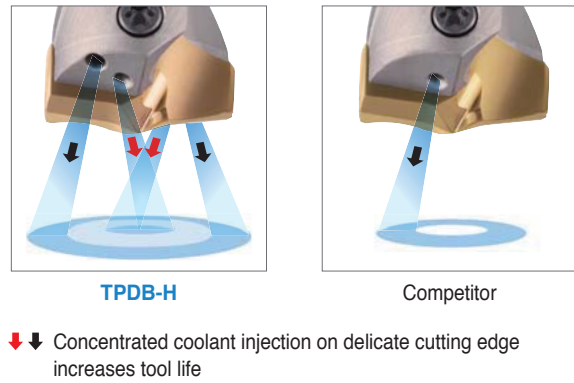
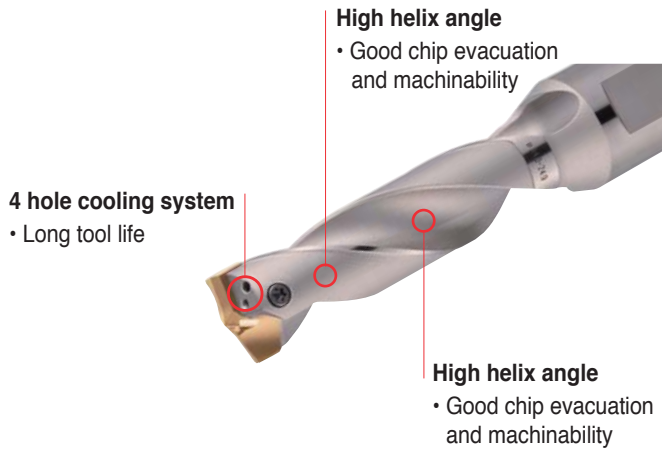

Grade selection

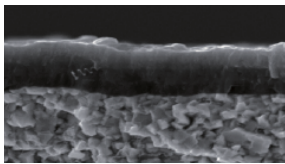

- **PC340Q**
 - Application of high hardness lubricative PVD coating technology with excellent resistance on wear, welding, and chipping
 - The special surface treatment improves chip evacuation and reduces wear on the rake surface and relief face
 - High hardness ultra-fine substrate ensures high rigidity of cutting edge and good chipping resistance

Performance evaluation

Chip control

- **Workpiece** Carbon steel (SS400, SM490A)
- **Cutting conditions** Drill dia.(mm) = $\varnothing 27$, vc (m/min) = 80
fn (mm/rev) = 0.2, ap (mm) = 30, wet
- **Tools** Inserts TPD270B-H (PC340Q)
Holder TPDB270-32-4-H



SS400



SM490A



Wear resistance

- **Workpiece** Carbon steel (SS400)
- **Cutting conditions** Drill dia.(mm) = $\varnothing 22$, vc (m/min) = 65
fn (mm/rev) = 0.25, ap (mm) = 30, wet
- **Tools** Inserts TPD220B-H (PC340Q)
Holder TPDB220-25-4-H

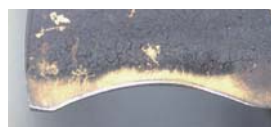

SS400

- **Workpiece** Carbon steel (SM490A)
- **Cutting conditions** Drill dia.(mm) = $\varnothing 27$, vc (m/min) = 70
fn (mm/rev) = 0.25, ap (mm) = 30, wet
- **Tools** Inserts TPD270B-H (PC340Q)
Holder TPDB270-32-4-H





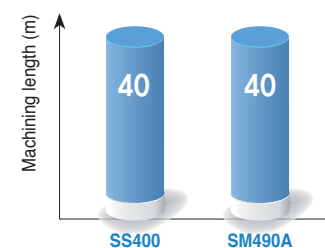

SM490A

Test result



Normal wear and still usable

Workpiece and recommended cutting conditions

Workpiece			Grade	vc (m/min)	Aspect ratio (L/D) = 3D, 4D Feed rate (mm/rev) per drill dia. (mm)		
ISO	Workpiece	Workpiece materials			Ø14.0~Ø21.0	Ø22.0~Ø30.0	
P	H-Beam		SS400 SM490 SHN490	PC340Q	65 (60~75)	0.22 (0.2~0.25)	0.25 (0.2~0.3)
	Angle		SS400 SM490 SHN490	PC340Q	65 (60~75)	0.22 (0.2~0.25)	0.25 (0.2~0.3)
	Plate		SS400 SM490 SHN490	PC340Q	65 (60~75)	0.22 (0.2~0.25)	0.25 (0.2~0.3)
	Plate (Stacked)		SS400 SM490 SHN490	PC340Q	60 (55~65)	0.2 (0.15~0.25)	0.2 (0.15~0.25)

How to clamp a TPDB-H insert

Clamping an insert to a holder



[Pic.1]

- Put an insert on the tip seat of the holder
- As the [pic.1], push the insert to the v-shaped groove of the holder
- Screw and clamp the insert

Changing the used insert to a new one



[Pic.2]



[Pic.3]

- Unscrew and separate the used insert from the holder
- As the [Pic.2], clean the insert seat
- Put a new insert on the tip seat
- As the [pic.3], clamp the insert pushing it with a hand not to separate from the holder

Precaution in drilling

Drilling of angled entrance



- The approach angle between drill and the workpiece at the beginning should be less than 6°
- Reduce the feed to 30~50% than general cutting conditions at the beginning and the end of angled surface.

Drilling of stacked plates



- Gap between the plates could make wrong chip evacuation causing fracture of the drill.
- Place stacked plates without any gap between each

Plunging

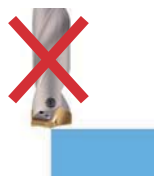

- Irregular cutting resistance in plunging could cause fracture and deformation of the drill.

Boring



- Boring is not recommended due to wear and chipping in the corner of the insert.

TPDB-H Insert **new**

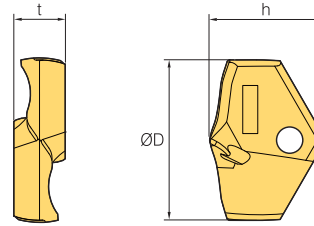
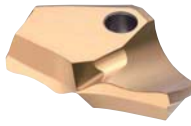

Designation		Coated	ØD	h	t
		PC340Q			
TPD	140B-H~149B-H		14.0-14.9	10.0	4.0
	150B-H~159B-H		15.0-15.9	10.5	4.0
	160B-H~169B-H		16.0-16.9	11.5	5.5
	170B-H~179B-H		17.0-17.9	12.0	5.5
	180B-H~189B-H		18.0-18.9	13.0	6.0
	190B-H~199B-H		19.0-19.9	13.5	6.0
	200B-H~209B-H		20.0-20.9	14.5	6.5
	210B-H~219B-H		21.0-21.9	15.0	6.5
	220B-H~229B-H		22.0-22.9	15.5	7.0
	230B-H~239B-H		23.0-23.9	16.0	7.0
	240B-H~249B-H		24.0-24.9	16.5	7.5
	250B-H~259B-H		25.0-25.9	17.0	7.5
	260B-H~269B-H		26.0-26.9	17.5	8.5
	270B-H~279B-H		27.0-27.9	18.5	8.5
	280B-H~289B-H		28.0-28.9	19.5	9.5
	290B-H~299B-H		29.0-29.9	20.0	9.5
300B-H~309B-H		30.0-30.9	20.5	10.0	

(mm)

● : Stock Item

Parts

Designation		Drill dia. (ØD)	Screw	Wrench	Torque (N·m)
TPD	140B-H~149B-H	14.0-14.9	FTNB02512-P	TW07S	0.8
	150B-H~179B-H	15.0-17.9	FTNB02514-P	TW07S	0.8
	180B-H~199B-H	18.0-19.9	FTNB0316-P	TW09S	1.2
	200B-H~239B-H	20.0-23.9	FTNB0319	TW09S	1.2
	240B-H~259B-H	24.0-25.9	FTNB03522	TW15S	3.0
	260B-H~279B-H	26.0-27.9	FTNB03524	TW15S	3.0
	280B-H~299B-H	28.0-29.9	FTNB0426	TW15S	3.0
	300B-H~309B-H	30.0-30.9	FTNB0528	TW20-100	4.0

(mm)

TPDB-H (3D) new

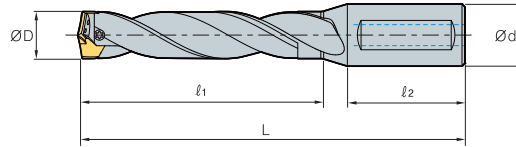

(mm)

Designation	ØD	Ød	l ₁	l ₂	L	Insert	
TPDB	140-16-3-H	14.0-14.4	16	42	48	97.5	TPD140B-144B-H
	145-16-3-H	14.5-14.9	16	43.5	48	99.5	TPD145B-149B-H
	150-20-3-H	15.0-15.4	20	45	50	103.0	TPD150B-154B-H
	155-20-3-H	15.5-15.9	20	46.5	50	105.0	TPD155B-159B-H
	160-20-3-H	16.0-16.4	20	48	50	106.5	TPD160B-164B-H
	165-20-3-H	16.5-16.9	20	49.5	50	108.5	TPD165B-169B-H
	170-20-3-H	17.0-17.4	20	51	50	110.0	TPD170B-174B-H
	175-20-3-H	17.5-17.9	20	52.5	50	112.0	TPD175B-179B-H
	180-20-3-H	18.0-18.4	20	54	50	113.5	TPD180B-184B-H
	185-20-3-H	18.5-18.9	20	55.5	50	115.5	TPD185B-189B-H
	190-20-3-H	19.0-19.4	20	57	50	117.0	TPD190B-194B-H
	195-20-3-H	19.5-19.9	20	58.5	50	119.0	TPD195B-199B-H
	200-25-3-H	20.0-20.4	25	60	56	126.5	TPD200B-204B-H
	205-25-3-H	20.5-20.9	25	61.5	56	128.5	TPD205B-209B-H
	210-25-3-H	21.0-21.4	25	63	56	130.0	TPD210B-214B-H
	215-25-3-H	21.5-21.9	25	64.5	56	132.0	TPD215B-219B-H
	220-25-3-H	22.0-22.4	25	66	56	133.5	TPD220B-224B-H
	225-25-3-H	22.5-22.9	25	67.5	56	135.5	TPD225B-229B-H
	230-25-3-H	23.0-23.4	25	69	56	137.0	TPD230B-234B-H
	235-25-3-H	23.5-23.9	25	70.5	56	139.0	TPD235B-239B-H
	240-32-3-H	24.0-24.4	32	72	60	144.5	TPD240B-244B-H
	245-32-3-H	24.5-24.9	32	73.5	60	146.5	TPD245B-249B-H
	250-32-3-H	25.0-25.4	32	75	60	148.0	TPD250B-254B-H
	255-32-3-H	25.5-25.9	32	76.5	60	150.0	TPD255B-259B-H
	260-32-3-H	26.0-26.4	32	78	60	151.5	TPD260B-264B-H
	265-32-3-H	26.5-26.9	32	79.5	60	153.5	TPD265B-269B-H
	270-32-3-H	27.0-27.4	32	81	60	155.0	TPD270B-274B-H
	275-32-3-H	27.5-27.9	32	82.5	60	157.0	TPD275B-279B-H
	280-32-3-H	28.0-28.4	32	84	60	158.5	TPD280B-284B-H
	285-32-3-H	28.5-28.9	32	85.5	60	160.5	TPD285B-289B-H
290-32-3-H	29.0-29.4	32	87	60	162.0	TPD290B-294B-H	
295-32-3-H	29.5-29.9	32	88.5	60	164.0	TPD295B-299B-H	
300-32-3-H	30.0-30.4	32	90	60	165.5	TPD300B-304B-H	

↻ Applicable inserts G47



TPDB-H (4D) **new**

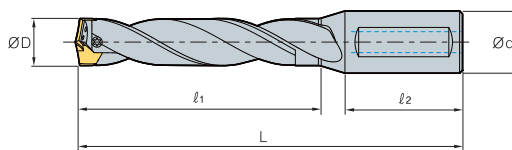

Designation		ØD	Ød	l ₁	l ₂	L	Insert
TPDB	140-16-4-H	14.0-14.4	16	56	48	111.5	TPD140B-144B-H
	145-16-4-H	14.5-14.9	16	58	48	114.0	TPD145B-149B-H
	150-20-4-H	15.0-15.4	20	60	50	118.0	TPD150B-154B-H
	155-20-4-H	15.5-15.9	20	62	50	120.5	TPD155B-159B-H
	160-20-4-H	16.0-16.4	20	64	50	122.5	TPD160B-164B-H
	165-20-4-H	16.5-16.9	20	66	50	125.0	TPD165B-169B-H
	170-20-4-H	17.0-17.4	20	68	50	127.0	TPD170B-174B-H
	175-20-4-H	17.5-17.9	20	70	50	129.5	TPD175B-179B-H
	180-20-4-H	18.0-18.4	20	72	50	131.5	TPD180B-184B-H
	185-20-4-H	18.5-18.9	20	74	50	134.0	TPD185B-189B-H
	190-20-4-H	19.0-19.4	20	76	50	136.0	TPD190B-194B-H
	195-20-4-H	19.5-19.9	20	78	50	138.5	TPD195B-199B-H
	200-25-4-H	20.0-20.4	25	80	56	146.5	TPD200B-204B-H
	205-25-4-H	20.5-20.9	25	82	56	149.0	TPD205B-209B-H
	210-25-4-H	21.0-21.4	25	84	56	151.0	TPD210B-214B-H
	215-25-4-H	21.5-21.9	25	86	56	153.5	TPD215B-219B-H
	220-25-4-H	22.0-22.4	25	88	56	155.5	TPD220B-224B-H
	225-25-4-H	22.5-22.9	25	90	56	158.0	TPD225B-229B-H
	230-25-4-H	23.0-23.4	25	92	56	160.0	TPD230B-234B-H
	235-25-4-H	23.5-23.9	25	94	56	162.5	TPD235B-239B-H
	240-32-4-H	24.0-24.4	32	96	60	168.5	TPD240B-244B-H
	245-32-4-H	24.5-24.9	32	98	60	171.0	TPD245B-249B-H
	250-32-4-H	25.0-25.4	32	100	60	173.0	TPD250B-254B-H
	255-32-4-H	25.5-25.9	32	102	60	175.5	TPD255B-259B-H
	260-32-4-H	26.0-26.4	32	104	60	177.5	TPD260B-264B-H
	265-32-4-H	26.5-26.9	32	106	60	180.0	TPD265B-269B-H
	270-32-4-H	27.0-27.4	32	108	60	182.0	TPD270B-274B-H
	275-32-4-H	27.5-27.9	32	110	60	184.5	TPD275B-279B-H
	280-32-4-H	28.0-28.4	32	112	60	186.5	TPD280B-284B-H
	285-32-4-H	28.5-28.9	32	114	60	189.0	TPD285B-289B-H
290-32-4-H	29.0-29.4	32	116	60	191.0	TPD290B-294B-H	
295-32-4-H	29.5-29.9	32	118	60	193.5	TPD295B-299B-H	
300-32-4-H	30.0-30.4	32	120	60	195.5	TPD300B-304B-H	

→ Applicable inserts **G47**

TPDB-H (8D) new

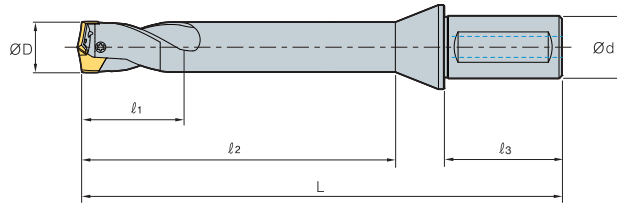

(mm)

Designation	ØD	Ød	l ₁	l ₂	l ₃	L	Insert	
TPDB	140-16-8F-H	14.0-14.4	16	50	112	48	175.0	TPD140B-144B-H
	145-16-8F-H	14.5-14.9	16	50	116	48	179.0	TPD145B-149B-H
	150-20-8F-H	15.0-15.4	20	50	120	50	186.0	TPD150B-154B-H
	155-20-8F-H	15.5-15.9	20	50	124	50	190.0	TPD155B-159B-H
	160-20-8F-H	16.0-16.4	20	50	128	50	195.0	TPD160B-164B-H
	165-20-8F-H	16.5-16.9	20	50	132	50	199.0	TPD165B-169B-H
	170-20-8F-H	17.0-17.4	20	50	136	50	204.0	TPD170B-174B-H
	175-20-8F-H	17.5-17.9	20	50	140	50	208.0	TPD175B-179B-H
	180-20-8F-H	18.0-18.4	20	50	144	50	214.0	TPD180B-184B-H
	185-20-8F-H	18.5-18.9	20	50	148	50	218.0	TPD185B-189B-H
	190-20-8F-H	19.0-19.4	20	50	152	50	222.0	TPD190B-194B-H
	195-20-8F-H	19.5-19.9	20	50	156	50	226.0	TPD195B-199B-H
	200-25-8F-H	20.0-20.4	25	50	160	56	236.0	TPD200B-204B-H
	205-25-8F-H	20.5-20.9	25	50	164	56	240.0	TPD205B-209B-H
	210-25-8F-H	21.0-21.4	25	50	168	56	244.0	TPD210B-214B-H
	215-25-8F-H	21.5-21.9	25	50	172	56	248.0	TPD215B-219B-H
	220-25-8F-H	22.0-22.4	25	50	176	56	252.0	TPD220B-224B-H
	225-25-8F-H	22.5-22.9	25	50	180	56	261.0	TPD225B-229B-H
	230-25-8F-H	23.0-23.4	25	50	184	56	265.0	TPD230B-234B-H
	235-25-8F-H	23.5-23.9	25	50	188	56	269.0	TPD235B-239B-H
	240-32-8F-H	24.0-24.4	32	50	192	60	277.0	TPD240B-244B-H
	245-32-8F-H	24.5-24.9	32	50	196	60	281.0	TPD245B-249B-H
	250-32-8F-H	25.0-25.4	32	50	200	60	285.0	TPD250B-254B-H
	255-32-8F-H	25.5-25.9	32	50	204	60	289.0	TPD255B-259B-H
	260-32-8F-H	26.0-26.4	32	50	208	60	293.0	TPD260B-264B-H
	265-32-8F-H	26.5-26.9	32	50	212	60	297.0	TPD265B-269B-H
	270-32-8F-H	27.0-27.4	32	50	216	60	301.0	TPD270B-274B-H
	275-32-8F-H	27.5-27.9	32	50	220	60	305.0	TPD275B-279B-H
	280-32-8F-H	28.0-28.4	32	50	224	60	311.0	TPD280B-284B-H
	285-32-8F-H	28.5-28.9	32	50	228	60	315.0	TPD285B-289B-H
290-32-8F-H	29.0-29.4	32	50	232	60	320.0	TPD290B-294B-H	
295-32-8F-H	29.5-29.9	32	50	236	60	324.0	TPD295B-299B-H	
300-32-8F-H	30.0-30.4	32	50	240	60	328.0	TPD300B-304B-H	

↻ Applicable inserts **G47**

• The max. length of flute could be l₂



Convenient and quickly adjustable drill height

WPDC

Indexable Drill Clamped with Center Drill

Code system for drill

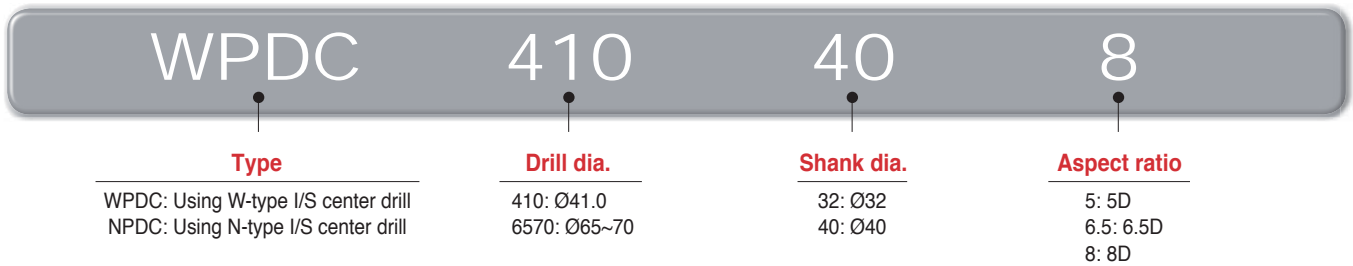

Code system for cartridge



Code system for center drill

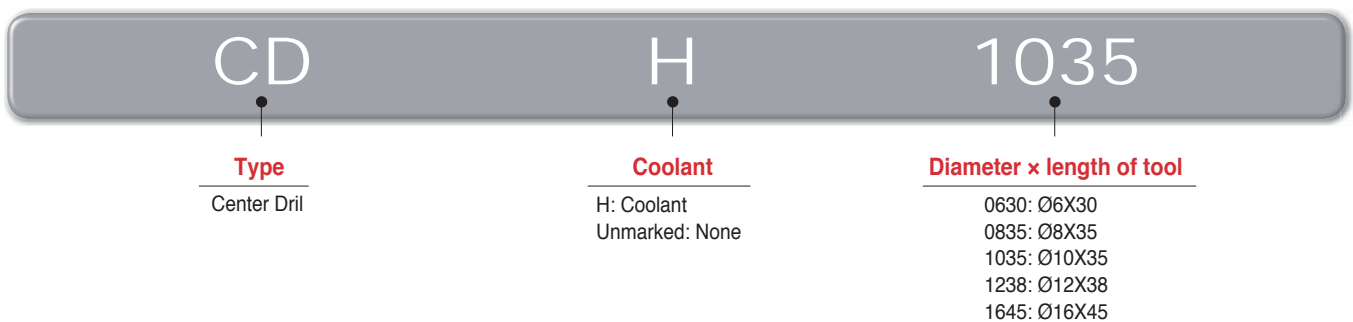

Grade of center drill

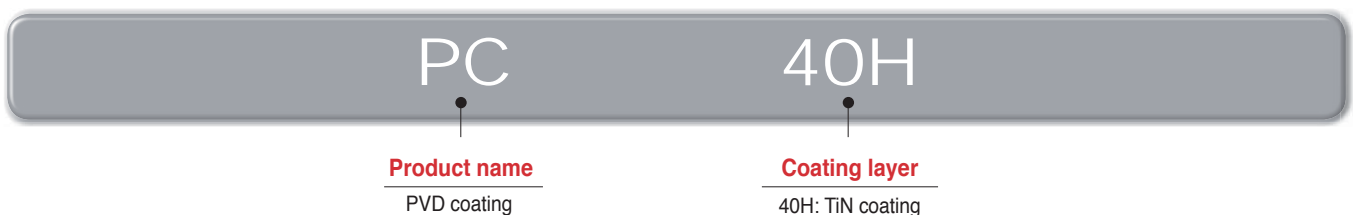

How to clamp the drills

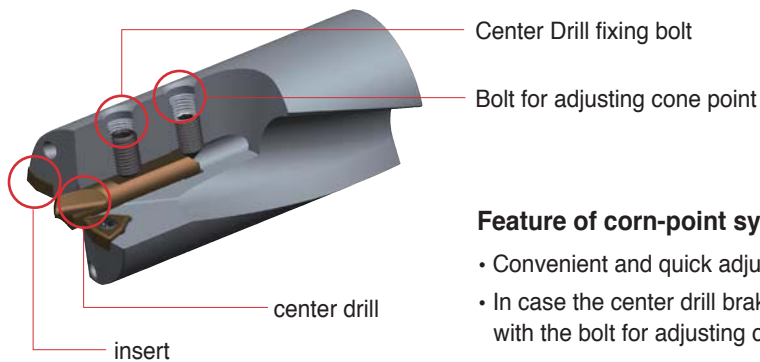

Feature of corn-point system

- Convenient and quick adjustable heights when inserting the center drill
- In case the center drill brakes while in usage, it can be replaced with the bolt for adjusting cone point
- The bolt for adjusting cone point prevents chattering on the center drill

Clamping

1	2	3	4	5
Place a center drill	Clamp insert and cartridge	Adjust the center drill with the bolt for adjusting cone point	Clamp the center drill firmly with fixing bolt	Reassure the clamp with bolt for adjusting cone point

- ※ Use safety covers for your safety when clamping the center drill and insert
- ※ When machining, be careful of the drill disk

Length of the 'a' part of center drill

The length of 'a' being too short can cause bad surface finish or high cutting load
 On the other hand, the length of 'a' being too long can make tool failure and chattering while drilling

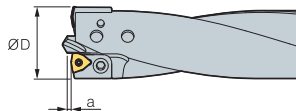

Diameter (ØD)	Length of the 'a' part of center drill		
	Steel	Alloy steel	Non-ferrous metal
25~30	1.2	1.0	1.5
31~40	1.5	1.3	1.8
41~50	1.8	1.5	2.2
51~59	2.2	1.8	2.5
60~75	2.5	2.0	2.8
76~80	3.0	2.5	3.5

Adjusting diameter of cartridge type drill

- Disassemble a cartridge from the holder by loosening the bolt fixed for outer cartridge
- Machine after calculating the hole size on the side of the outer cartridge
- Trim the sharp part after machining
- Clamp the bolt for fixing cartridge without any gap in between the holder and the machined outer cartridge

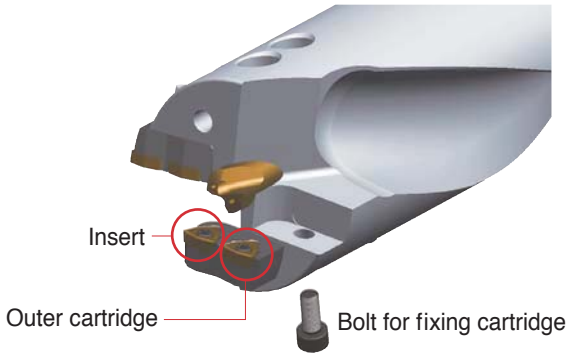

- **Range of adjustable drill diameter**
 1. Single cartridge type (Drill diameter $\varnothing 41\sim\varnothing 59$) \rightsquigarrow -1.0 mm
 2. Dual cartridge type (Drill diameter $\varnothing 60\sim\varnothing 80$) \rightsquigarrow -5.0 mm
- **Diameter of the standard drills is provided with maximum size of standards**
 Ex) WPDC6570-40-6.5 \rightsquigarrow Drill diameter 70.0 mm

Ex) How to adjust drill diameter to $\varnothing 66.0$ machining with WPDC6570-40-8

\rightsquigarrow To make the drill diameter of outer cartridge to $\varnothing 66.0$, machine 2.0 mm. ($\varnothing 70.0 - \varnothing 66.0 = 4 \rightsquigarrow 4 \div 2 = 2$ (radius))

Recommended cutting condition

Workpiece			Chip breaker	Grade	vc (m/min)	Aspect ratio (L/D) = 5D, 6.5D, 8D						
						Feed rate (mm/rev) per drill dia. (mm)						
ISO	Workpiece	HB				$\sim\varnothing 30$	$\varnothing 31\sim\varnothing 40$	$\varnothing 41\sim\varnothing 50$	$\varnothing 51\sim\varnothing 59$	$\varnothing 60\sim\varnothing 75$	$\varnothing 76\sim\varnothing 80$	
P	Carbon steel	Low carbon steel ($\sim 0.25\%$)	80~180	C21N	PC5335	190 (160~220)	0.07~0.11	0.08~0.12	0.10~0.14	0.12~0.16	0.12~0.16	0.12~0.16
		High carbon steel (0.25%~)	180~280	C21N	PC5335	140 (110~170)	0.07~0.11	0.08~0.12	0.10~0.14	0.12~0.16	0.12~0.16	0.12~0.16
	Alloy steel	Low alloy steel	140~260	C21N	PC5335	130 (100~160)	0.08~0.12	0.08~0.12	0.10~0.14	0.12~0.18	0.12~0.18	0.12~0.18
		High alloy steel	50~260	C21N	PC5335	100 (70~130)	0.06~0.10	0.08~0.12	0.08~0.12	0.10~0.16	0.10~0.16	0.10~0.16
M	Stainless steel	Stainless steel	135~275	C21N	PC5335	100 (70~130)	0.06~0.10	0.08~0.12	0.10~0.12	0.12~0.14	0.12~0.14	
K	Cast iron	Gray cast iron	150~220	C21N	PC5335	160 (130~190)	0.09~0.15	0.10~0.16	0.12~0.2	0.14~0.22	0.14~0.22	0.14~0.22
		Ductile cast iron	200~300	C21N	PC5335	140 (170~110)	0.09~0.15	0.10~0.16	0.12~0.2	0.14~0.22	0.14~0.22	0.14~0.22
		Malleable cast iron	130~230	C21N	PC5335	150 (180~120)	0.09~0.15	0.10~0.16	0.12~0.2	0.14~0.22	0.14~0.22	0.14~0.22
N	Aluminum	Aluminum	30~150	C21N	PC5335	300 (250~350)	0.08~0.12	0.10~0.14	0.12~0.16	0.14~0.18	0.14~0.18	0.14~0.18
	Alloyed copper	Alloyed copper	150~160	C21N	PC5335	250 (200~300)	0.08~0.12	0.10~0.14	0.12~0.16	0.14~0.18	0.14~0.18	0.14~0.18
S	Heat resistant alloy	Heat resistant alloy	130~400	C21N	PC5335	50 (70~30)	0.05~0.08	0.05~0.08	0.06~0.10	0.06~0.10	0.06~0.10	0.06~0.10

Parts of WPDC type indexable drills

Designation	ØD	Insert			Center drill			Cartridge						
		Insert	Screw	Wrench	Center drill	fixed bolt	cone point bolt	Inner	Outer	Fixed bolt				
WPDC250-32-□	25	WC□T030204-C21N	FTKA02206	TW06S	CD0630	KHA0508	KHC0510	CWP4145C	CWP430P	BHA0510				
WPDC260~280-32-□	26~28	WC□T040204-C21N	FTNA02555	TW07S		KHA0510								
WPDC290~300-32-□	29~30					WC□T050308-C21N	FTKA0307				TW09S	KHA0610		
WPDC310~350-32-□	31~35	KHA0612	KHC0610	CDH1035	KHA0812				KHC0812	CWP4650C		CWP480P	BHA0512	
WPDC360~400-32-□	36~40					WC□T06T308-C21N	FTKA03508				TW15S			KHA0815
WPDC410-40-□	41	WC□T080408-C21N	FTKA0411K		TW15S				KHA1015					
WPDC420-40-□	42					WC□T050308-C21N	FTKA0307			TW09S	KHA1020	KHA1020	CWP6065C	CWP6065P
WPDC430-40-□	43	WC□T06T308-C21N	FTKA03508		TW15S				CDH1238					
WPDC440-40-□	44					WC□T06T308-C21N	FTKA03508			TW15S	CDH1238	KHA1020	KHA1020	CWP7075C
WPDC450-40-□	45	WC□T06T308-C21N	FTKA03508		TW15S				CDH1238					
WPDC460-40-□	46					WC□T06T308-C21N	FTKA03508	TW15S		CDH1238	KHA1020	KHA1020	CWP7580C	CWP7580T
WPDC470-40-□	47	WC□T06T308-C21N	FTKA03508		TW15S				CDH1238					
WPDC480-40-□	48					WC□T06T308-C21N	FTKA03508	TW15S		CDH1238	KHA1020	KHA1020	CWP7580C	CWP7580T
WPDC490-40-□	49	WC□T06T308-C21N	FTKA03508	TW15S	CDH1238				KHA1020					
WPDC500-40-□	50					WC□T06T308-C21N	FTKA03508	TW15S		CDH1238	KHA1020	KHA1020	CWP7580C	CWP7580T
WPDC510-40-□	51	WC□T06T308-C21N	FTKA03508	TW15S	CDH1238				KHA1020					
WPDC520-40-□	52					WC□T06T308-C21N	FTKA03508	TW15S		CDH1238	KHA1020	KHA1020	CWP7580C	CWP7580T
WPDC530-40-□	53	WC□T06T308-C21N	FTKA03508	TW15S	CDH1238				KHA1020					
WPDC540-40-□	54					WC□T06T308-C21N	FTKA03508	TW15S		CDH1238	KHA1020	KHA1020	CWP7580C	CWP7580T
WPDC550-40-□	55	WC□T06T308-C21N	FTKA03508	TW15S	CDH1238				KHA1020					
WPDC560-40-□	56					WC□T06T308-C21N	FTKA03508	TW15S		CDH1238	KHA1020	KHA1020	CWP7580C	CWP7580T
WPDC570-40-□	57	WC□T06T308-C21N	FTKA03508	TW15S	CDH1238				KHA1020					
WPDC580-40-□	58					WC□T06T308-C21N	FTKA03508	TW15S		CDH1238	KHA1020	KHA1020	CWP7580C	CWP7580T
WPDC590-40-□	59	WC□T06T308-C21N	FTKA03508	TW15S	CDH1238				KHA1020					
WPDC6065-40-□	60~65					WC□T050308-C21N	FTKA0307	TW09S		CDH1645	KHA1020	KHA1020	CWP7580C	CWP7580T
WPDC6570-40-□	65~70	WC□T050308-C21N	FTKA0307	TW09S	CDH1645				KHA1020					
WPDC7075-40-□	70~75					WC□T06T308-C21N	FTKA03508	TW15S		CDH1645	KHA1020	KHA1020	CWP7580C	CWP7580T
WPDC7580-40-□	75~80	WC□T06T308-C21N	FTKA03508	TW15S	CDH1645				KHA1020					

↻ Applicable inserts G04~05

Center Drill

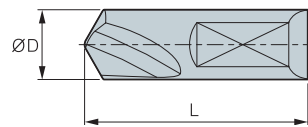

(mm)

Designation	Grade	ØD	L	Oil-hole
CD0630	PC40H	6	30	×
CD0835	PC40H	8	35	×
CDH1035	PC40H	10	35	○
CDH1238	PC40H	12	38	○
CDH1645	PC40H	16	45	○

• This is HSS with Tin coating



WPDC (5D/6.5D/8D)

Standard type

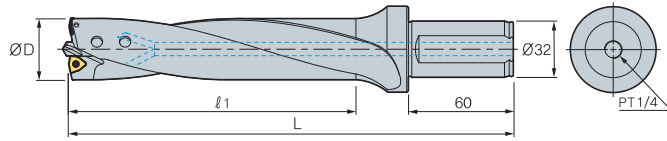

(mm)

Designation	ØD	5D		6.5D		8D		Insert	Center drill
		ℓ ₁	L	ℓ ₁	L	ℓ ₁	L		
WPDC 250-32- □	25	150	240	185	275	220	310	WC□T030204-C21N	CD0630
260-32- □	26	150	240	185	275	220	310		
270-32- □	27	150	240	185	275	220	310		
280-32- □	28	150	240	185	275	220	310		
290-32- □	29	150	240	185	275	220	310		
300-32- □	30	150	240	185	275	220	310		
310-32- □	31	175	265	218	308	260	350	WC□T050308-C21N	CD0835
320-32- □	32	175	265	218	308	260	350		
330-32- □	33	175	265	218	308	260	350		
340-32- □	34	175	265	218	308	260	350		
350-32- □	35	175	265	218	308	260	350		
360-32- □	36	200	290	250	340	300	390		
370-32- □	37	200	290	250	340	300	390		
380-32- □	38	200	290	250	340	300	390		
390-32- □	39	200	290	250	340	300	390		
400-32- □	40	200	290	250	340	300	390		

Applicable inserts **G04-05**

* We can provide if you order exact diameter
Ex) machining hole 32.5 mm + 6.5D → WPDC325-32-6.5

WPDC (5D/6.5D/8D)

Single insert cartridge type

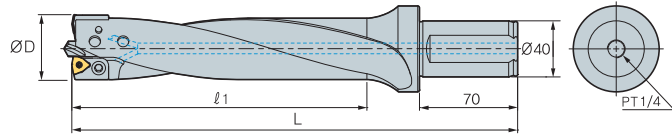

(mm)

Designation	ØD	5D		6.5D		8D		Insert	Center drill	Cartridge	
		l ₁	L	l ₁	L	l ₁	L			Inner	Outer
WPDC	410-40-□	41	225 330	283 388	340 445	WC□T06T308-C21N	CDH1035	CWP4145C	CWP410P		
	420-40-□	42	225 330	283 388	340 445				CWP420P		
	430-40-□	43	225 330	283 388	340 445				CWP430P		
	440-40-□	44	225 330	283 388	340 445				CWP440P		
	450-40-□	45	225 330	283 388	340 445				CWP450P		
	460-40-□	46	250 355	315 420	380 485			CWP4650C	CWP460P		
	470-40-□	47	250 355	315 420	380 485				CWP470P		
	480-40-□	48	250 355	315 420	380 485				CWP480P		
	490-40-□	49	250 355	315 420	380 485				CWP490P		
	500-40-□	50	250 355	315 420	380 485				CWP500P		
	510-40-□	51	275 380	348 453	420 525			WC□T080408-C21N	CDH1238	CWP5155C	CWP510P
	520-40-□	52	275 380	348 453	420 525						CWP520P
	530-40-□	53	275 380	348 453	420 525						CWP530P
	540-40-□	54	275 380	348 453	420 525						CWP540P
	550-40-□	55	275 380	348 453	420 525						CWP550P
	560-40-□	56	300 405	380 485	460 565			WC□T080408-C21N	CDH1238	CWP5659C	CWP560P
	570-40-□	57	300 405	380 485	460 565						CWP570P
	580-40-□	58	300 405	380 485	460 565						CWP580P
	590-40-□	59	300 405	380 485	460 565						CWP590P

↻ Applicable inserts G04~05

* We can provide if you order exact diameter
Ex) machining hole 47.5 mm * 5D -> WPDC475-40-5

WPDC (5D/6.5D/8D)

Dual insert cartridge type

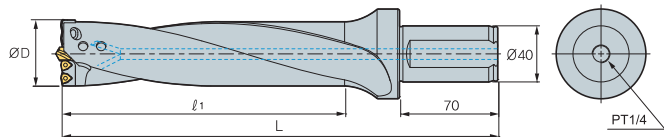

(mm)

Designation	ØD	5D		6.5D		8D		Insert	Center drill	Cartridge	
		l ₁	L	l ₁	L	l ₁	L			Inner	Outer
WPDC	6065-40-□	60~65	325 430	423 528	520 625	WC□T050308-C21N	CDH1238	CWP6065C	CWP6065P		
	6570-40-□	65~70	350 455	455 560	560 665			CWP6570C	CWP6570P		
	7075-40-□	70~75	375 480	488 593	600 705			CWP7075C	CWP7075P		
	7580-40-□	75~80	400 505	520 625	640 745			WC□T06T308-C21N	CDH1645	CWP7580C	CWP7580P

↻ Applicable inserts G04~05

* We can provide if you order exact diameter
Ex) machining hole 70.5 mm * 6.5D -> WPDC705-40-6.5



Highly efficient hole making for various workpieces including components

MSD Plus **new**

Mach Solid Drill Plus

Code system

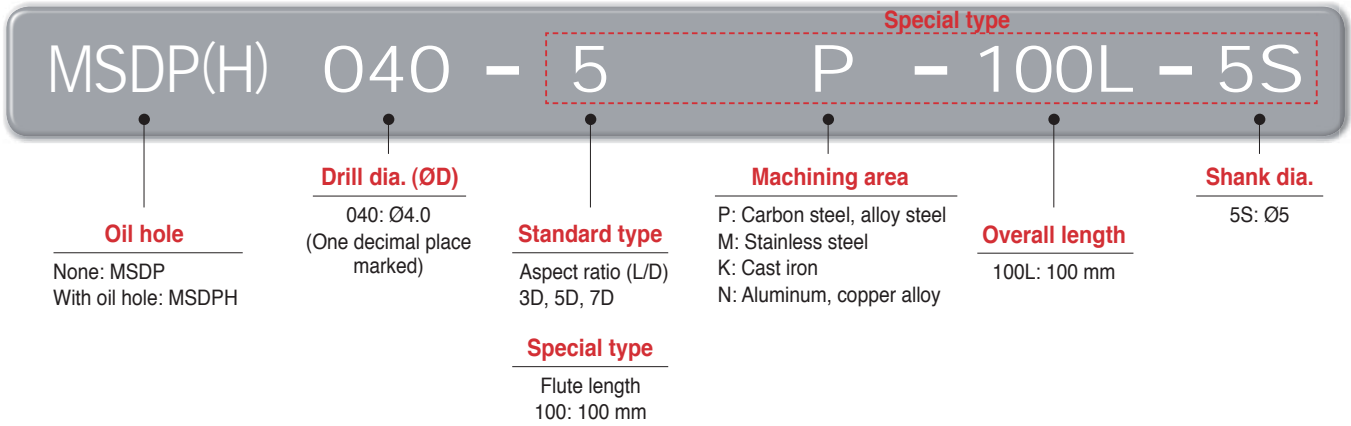

Features

New grade (PC325U)

- Lubricative coating layer improves welding resistance at middle to high speed.
- Increase wear resistance in machining carbon steel

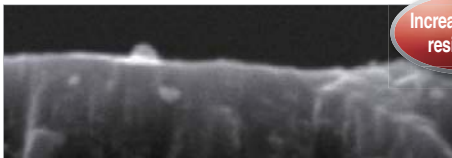

PC325U

Increased wear resistance

Surface of coating layer

- Increased welding resistance and lower cutting load
- Reduced frictional resistance at cutting edges and on the flute



PC325U

Improved lubrication

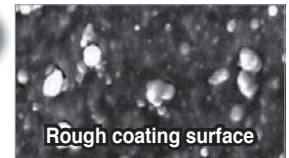

Competitor

Chip control

- Workpiece** SCM440
- Cutting conditions** vc (m/min) = 90, fn (mm/rev) = 0.2, ap (mm) = 30, wet
- Tools** MSDPH060-5P (PC325U)



MSD Plus

Chip in good shape



Competitor

Flute shape

- Improved chip evacuation thanks to wider chip pocket



Application area

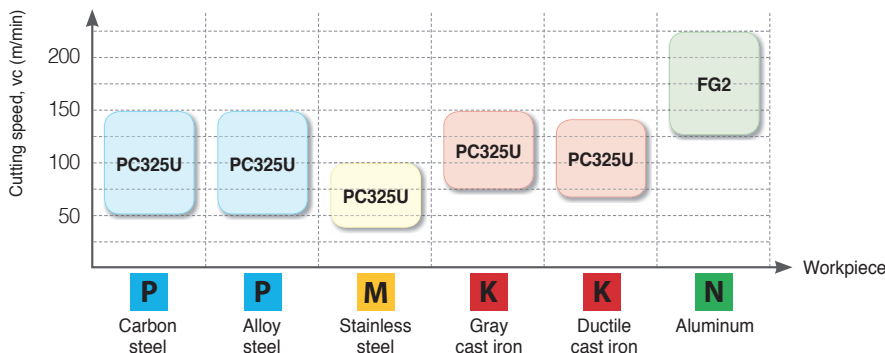

Application examples

- **Use** Part of Automobile
- **Workpiece** SM45C
- **Cutting conditions** vc (m/min) = 124, fn (mm/rev) = 0.15
ap (mm) = 30, Through coolant
- **Tools** MSDP120-5P (PC325U)

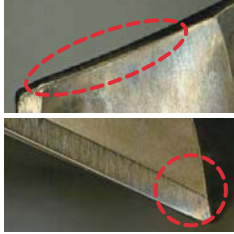

MSD Plus

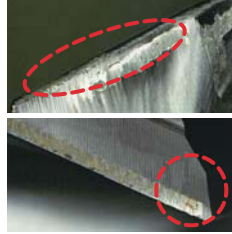

Competitor

Test result

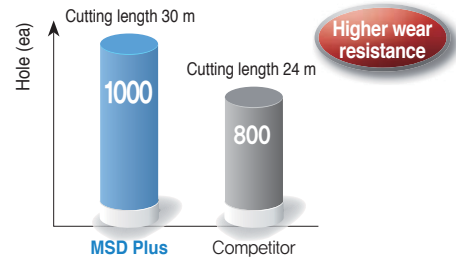

Lubricative coating layer of the new grade PC325U maximizes wear resistance.

- **Use** Part of Automobile
- **Workpiece** SM53C
- **Cutting conditions** vc (m/min) = 60, fn (mm/rev) = 0.25
ap (mm) = 30, External coolant
- **Tools** MSDP120-5P (PC325U)



Test result

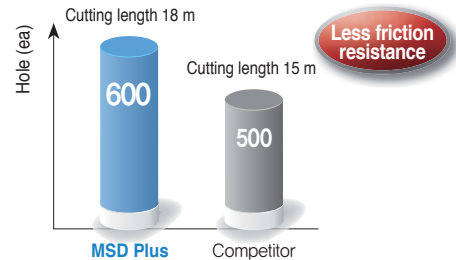

Special treatment on coating surface minimized frictional resistance.

Recommended cutting conditions

Workpiece			Grade	vc (m/min)	Feed					
ISO	Workpiece	HB			Feed rate (mm/rev) per drill dia. (mm)					
					Ø1.0~Ø4.0	Ø4.1~Ø8.0	Ø8.1~Ø12.0	Ø12.1~Ø16.0	Ø16.1~Ø20.0	
P	Carbon steel	Low carbon steel	80~120	PC325U	90 (80~150)	0.10~0.15	0.16~0.24	0.20~0.30	0.25~0.36	0.30~0.40
		High carbon steel	Over 250	PC325U	50 (40~80)	0.08~0.20	0.08~0.20	0.10~0.25	0.15~0.25	0.15~0.30
	Alloy steel	Low alloy steel	140~260	PC325U	90 (80~150)	0.10~0.15	0.16~0.24	0.20~0.30	0.25~0.36	0.30~0.40
		Hardened low alloy steel	200~400	PC325U	60 (50~100)	0.10~0.15	0.16~0.24	0.20~0.30	0.25~0.36	0.30~0.40
		High alloy steel	50~260	PC325U	50 (40~80)	0.08~0.20	0.08~0.20	0.10~0.25	0.15~0.25	0.15~0.30
		Hardened high alloy steel	Over 250	PC325U	50 (40~80)	0.08~0.20	0.08~0.20	0.10~0.25	0.15~0.25	0.15~0.30
M	Stainless steel	Austenite series	135~275	PC325U	45 (25~80)	0.05~0.20	0.05~0.20	0.10~0.25	0.10~0.25	0.15~0.30
		Ferrite series Martensite series	135~275	PC325U	50 (30~80)	0.05~0.20	0.05~0.20	0.10~0.25	0.10~0.25	0.15~0.30
K	Cast iron	Gray cast iron	150~230	PC325U	100 (80~150)	0.10~0.15	0.16~0.24	0.20~0.30	0.25~0.36	0.30~0.40
		Ductile cast iron	160~260	PC325U	90 (70~140)	0.10~0.15	0.16~0.24	0.20~0.30	0.25~0.36	0.30~0.40
N	Aluminum	Aluminum alloy	30~150	FG2	150 (125~220)	0.24~0.38	0.38~0.53	0.53~0.75	0.61~0.85	0.68~0.98
	Copper alloy	Copper alloy	150~160	FG2	150 (125~220)	0.10~0.15	0.16~0.24	0.20~0.30	0.25~0.36	0.30~0.40

- Cutting conditions above are for the case of less than 5D depth of cut and through coolant system applied
- In case of external coolant system, reduce the above feed values by 20%



MSDP-□(P/M/K/N)

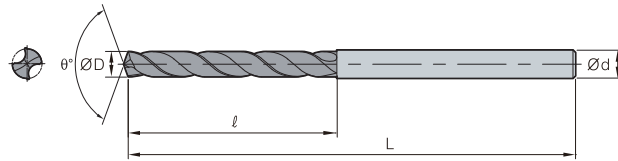

Terminology	P	M	K	N
Grade	PC325U	FG2		
Tolerance (drill Dia.)	h7			
Tolerance (shank Dia.)	h6			
Point angle	140°	135°		
Twist angle	30°			
Thinning	X type			
Coolant	External			

■ Steel
 ■ Stainless steel
 ■ Cast iron
 ■ Non-ferrous metal

(mm)

Designation	ØD	Ød	3P,M,K,N		5P,M,K,N	
			ℓ	L	ℓ	L
MSDP 010 - □ P,M,K,N	1.0	3.0	6	45	12	66
011 - □ P,M,K,N	1.1	3.0	7	45	12	66
012 - □ P,M,K,N	1.2	3.0	8	45	12	66
013 - □ P,M,K,N	1.3	3.0	8	45	12	66
014 - □ P,M,K,N	1.4	3.0	9	45	12	66
015 - □ P,M,K,N	1.5	3.0	9	45	12	66
016 - □ P,M,K,N	1.6	3.0	10	45	15	66
017 - □ P,M,K,N	1.7	3.0	10	45	15	66
018 - □ P,M,K,N	1.8	3.0	11	45	15	66
019 - □ P,M,K,N	1.9	3.0	11	45	15	66
020 - □ P,M,K,N	2.0	3.0	14	53	20	66
021 - □ P,M,K,N	2.1	3.0	14	53	20	66
022 - □ P,M,K,N	2.2	3.0	14	53	20	66
023 - □ P,M,K,N	2.3	3.0	14	53	20	66
024 - □ P,M,K,N	2.4	3.0	14	53	20	66

MSDP(H)- □(P/M/K/N)

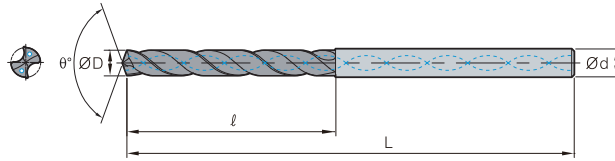

Terminology	P	M	K	N
Grade	PC325U			FG2
Tolerance (drill Dia.)	h7			
Tolerance (shank Dia.)	h6			
Point angle	140°		135°	
Twist angle	30°			
Thinning	X type			
Coolant	Through/External			

■ Steel
 ■ Stainless steel
 ■ Cast iron
 ■ Non-ferrous metal

(mm)

Designation	ØD	Ød	3P,M,K,N		5P,M,K,N		7P,M,K,N	
			ℓ	L	ℓ	L	ℓ	L
MSDP(H) 025 - □ P,M,K,N	2.5	3.0	14	53	20	66	30	70
026 - □ P,M,K,N	2.6	3.0	17	53	20	66	30	70
027 - □ P,M,K,N	2.7	3.0	17	53	20	66	30	70
028 - □ P,M,K,N	2.8	3.0	17	53	20	66	30	70
029 - □ P,M,K,N	2.9	3.0	17	53	20	66	30	70
030 - □ P,M,K,N	3.0	3.0	17	53	20	66	30	70
031 - □ P,M,K,N	3.1	4.0	20	58	28	74	30	70
032 - □ P,M,K,N	3.2	4.0	20	58	28	74	30	70
033 - □ P,M,K,N	3.3	4.0	20	58	28	74	30	70
034 - □ P,M,K,N	3.4	4.0	20	58	28	74	37.5	75
035 - □ P,M,K,N	3.5	4.0	20	58	28	74	37.5	75
036 - □ P,M,K,N	3.6	4.0	22	58	32	74	37.5	75
037 - □ P,M,K,N	3.7	4.0	22	58	32	74	37.5	75
038 - □ P,M,K,N	3.8	4.0	22	58	32	74	37.5	75
039 - □ P,M,K,N	3.9	4.0	22	58	32	74	37.5	75
040 - □ P,M,K,N	4.0	4.0	22	58	32	74	37.5	75
041 - □ P,M,K,N	4.1	5.0	24	62	36	82	37.5	75
042 - □ P,M,K,N	4.2	5.0	24	62	36	82	37.5	75
043 - □ P,M,K,N	4.3	5.0	24	62	36	82	45	85
044 - □ P,M,K,N	4.4	5.0	24	62	36	82	45	85
045 - □ P,M,K,N	4.5	5.0	24	62	36	82	45	85
046 - □ P,M,K,N	4.6	5.0	26	62	38	82	45	85
047 - □ P,M,K,N	4.7	5.0	26	62	38	82	45	85
048 - □ P,M,K,N	4.8	5.0	26	62	38	82	50	90
049 - □ P,M,K,N	4.9	5.0	26	62	38	82	50	90
050 - □ P,M,K,N	5.0	5.0	26	62	38	82	50	90
051 - □ P,M,K,N	5.1	6.0	28	66	44	82	50	90
052 - □ P,M,K,N	5.2	6.0	28	66	44	82	50	90
053 - □ P,M,K,N	5.3	6.0	28	66	44	82	50	90
054 - □ P,M,K,N	5.4	6.0	28	66	44	82	50	90
055 - □ P,M,K,N	5.5	6.0	28	66	44	82	57	97
056 - □ P,M,K,N	5.6	6.0	28	66	44	82	57	97
057 - □ P,M,K,N	5.7	6.0	28	66	44	82	57	97
058 - □ P,M,K,N	5.8	6.0	28	66	44	82	57	97
059 - □ P,M,K,N	5.9	6.0	28	66	44	82	57	97
060 - □ P,M,K,N	6.0	6.0	28	66	44	82	57	97
061 - □ P,M,K,N	6.1	7.0	34	74	50	91	66	106
062 - □ P,M,K,N	6.2	7.0	34	74	50	91	66	106
063 - □ P,M,K,N	6.3	7.0	34	74	50	91	66	106
064 - □ P,M,K,N	6.4	7.0	34	74	50	91	66	106
065 - □ P,M,K,N	6.5	7.0	34	74	50	91	66	106
066 - □ P,M,K,N	6.6	7.0	34	74	50	91	66	106
067 - □ P,M,K,N	6.7	7.0	34	74	50	91	66	106
068 - □ P,M,K,N	6.8	7.0	34	74	50	91	66	106
069 - □ P,M,K,N	6.9	7.0	34	74	50	91	76	116
070 - □ P,M,K,N	7.0	7.0	34	74	50	91	76	116
071 - □ P,M,K,N	7.1	8.0	41	79	53	91	76	116
072 - □ P,M,K,N	7.2	8.0	41	79	53	91	76	116



MSDP(H)-□(P/M/K/N)

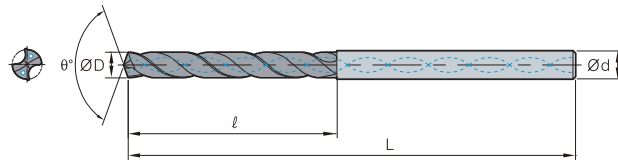

Terminology	P	M	K	N
Grade	PC325U			FG2
Tolerance (drill Dia.)	h7			
Tolerance (shank Dia.)	h6			
Point angle	140°		135°	
Twist angle	30°			
Thinning	X type			
Coolant	Through/External			

Steel M Stainless steel K Cast iron N Non-ferrous metal

Designation	ØD	Ød	3P,M,K,N		5P,M,K,N		7P,M,K,N	
			ℓ	L	ℓ	L	ℓ	L
MSDP(H) 073 - □ P,M,K,N	7.3	8.0	41	79	53	91	76	116
074 - □ P,M,K,N	7.4	8.0	41	79	53	91	76	116
075 - □ P,M,K,N	7.5	8.0	41	79	53	91	76	116
076 - □ P,M,K,N	7.6	8.0	41	79	53	91	76	116
077 - □ P,M,K,N	7.7	8.0	41	79	53	91	76	116
078 - □ P,M,K,N	7.8	8.0	41	79	53	91	76	116
079 - □ P,M,K,N	7.9	8.0	41	79	53	91	76	116
080 - □ P,M,K,N	8.0	8.0	43	84	58	98	87	131
081 - □ P,M,K,N	8.1	9.0	43	84	58	98	87	131
082 - □ P,M,K,N	8.2	9.0	43	84	58	98	87	131
083 - □ P,M,K,N	8.3	9.0	43	84	58	98	87	131
084 - □ P,M,K,N	8.4	9.0	43	84	58	98	87	131
085 - □ P,M,K,N	8.5	9.0	43	84	58	98	87	131
086 - □ P,M,K,N	8.6	9.0	43	84	58	98	87	131
087 - □ P,M,K,N	8.7	9.0	43	84	58	98	87	131
088 - □ P,M,K,N	8.8	9.0	43	84	58	98	87	131
089 - □ P,M,K,N	8.9	9.0	43	84	58	98	87	131
090 - □ P,M,K,N	9.0	9.0	43	84	58	98	87	131
091 - □ P,M,K,N	9.1	10.0	47	89	61	105	95	139
092 - □ P,M,K,N	9.2	10.0	47	89	61	105	95	139
093 - □ P,M,K,N	9.3	10.0	47	89	61	105	95	139
094 - □ P,M,K,N	9.4	10.0	47	89	61	105	95	139
095 - □ P,M,K,N	9.5	10.0	47	89	61	105	95	139
096 - □ P,M,K,N	9.6	10.0	47	89	61	105	95	139
097 - □ P,M,K,N	9.7	10.0	47	89	61	105	95	139
098 - □ P,M,K,N	9.8	10.0	47	89	61	105	95	139
099 - □ P,M,K,N	9.9	10.0	47	89	61	105	95	139
100 - □ P,M,K,N	10.0	10.0	47	89	61	105	95	139
101 - □ P,M,K,N	10.1	11.0	55	95	68	114	106	155
102 - □ P,M,K,N	10.2	11.0	55	95	68	114	106	155
103 - □ P,M,K,N	10.3	11.0	55	95	68	114	106	155
104 - □ P,M,K,N	10.4	11.0	55	95	68	114	106	155
105 - □ P,M,K,N	10.5	11.0	55	95	68	114	106	155
106 - □ P,M,K,N	10.6	11.0	55	95	68	114	106	155
107 - □ P,M,K,N	10.7	11.0	55	95	68	114	106	155
108 - □ P,M,K,N	10.8	11.0	55	95	68	114	106	155
109 - □ P,M,K,N	10.9	11.0	55	95	68	114	106	155
110 - □ P,M,K,N	11.0	11.0	55	95	68	114	106	155
111 - □ P,M,K,N	11.1	12.0	55	102	71	120	114	163
112 - □ P,M,K,N	11.2	12.0	55	102	71	120	114	163
113 - □ P,M,K,N	11.3	12.0	55	102	71	120	114	163
114 - □ P,M,K,N	11.4	12.0	55	102	71	120	114	163
115 - □ P,M,K,N	11.5	12.0	55	102	71	120	114	163
116 - □ P,M,K,N	11.6	12.0	55	102	71	120	114	163
117 - □ P,M,K,N	11.7	12.0	55	102	71	120	114	163
118 - □ P,M,K,N	11.8	12.0	55	102	71	120	114	163
119 - □ P,M,K,N	11.9	12.0	55	102	71	120	114	163
120 - □ P,M,K,N	12.0	12.0	55	102	71	120	114	163

MSDP(H)-□(P/M/K/N)

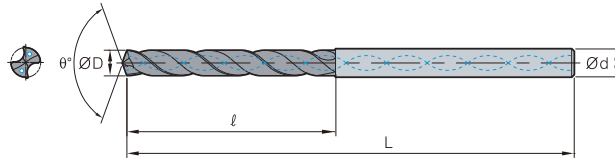

Terminology	P	M	K	N
Grade	PC325U			FG2
Tolerance (drill Dia.)	h7			
Tolerance (shank Dia.)	h6			
Point angle	140°		135°	
Twist angle	30°			
Thinning	X type			
Coolant	Through/External			

■ Steel
 ■ Stainless steel
 ■ Cast iron
 ■ Non-ferrous metal

(mm)

Designation	ØD	Ød	3P,M,K,N		5P,M,K,N		7P,M,K,N	
			ℓ	L	ℓ	L	ℓ	L
MSDP(H) 121 - □ P,M,K,N	12.1	13.0	60	107	77	124	133	182
122 - □ P,M,K,N	12.2	13.0	60	107	77	124	133	182
123 - □ P,M,K,N	12.3	13.0	60	107	77	124	133	182
124 - □ P,M,K,N	12.4	13.0	60	107	77	124	133	182
125 - □ P,M,K,N	12.5	13.0	60	107	77	124	133	182
126 - □ P,M,K,N	12.6	13.0	60	107	77	124	133	182
127 - □ P,M,K,N	12.7	13.0	60	107	77	124	133	182
128 - □ P,M,K,N	12.8	13.0	60	107	77	124	133	182
129 - □ P,M,K,N	12.9	13.0	60	107	77	124	133	182
130 - □ P,M,K,N	13.0	13.0	60	107	77	124	133	182
131 - □ P,M,K,N	13.1	14.0	62	107	80	133	133	182
132 - □ P,M,K,N	13.2	14.0	62	107	80	133	133	182
133 - □ P,M,K,N	13.3	14.0	62	107	80	133	133	182
134 - □ P,M,K,N	13.4	14.0	62	107	80	133	133	182
135 - □ P,M,K,N	13.5	14.0	62	107	80	133	133	182
136 - □ P,M,K,N	13.6	14.0	62	107	80	133	133	182
137 - □ P,M,K,N	13.7	14.0	62	107	80	133	133	182
138 - □ P,M,K,N	13.8	14.0	62	107	80	133	133	182
139 - □ P,M,K,N	13.9	14.0	62	107	80	133	133	182
140 - □ P,M,K,N	14.0	14.0	62	107	80	133	133	182
141 - □ P,M,K,N	14.1	15.0	65	115	85	143	152	204
142 - □ P,M,K,N	14.2	15.0	65	115	85	143	152	204
143 - □ P,M,K,N	14.3	15.0	65	115	85	143	152	204
144 - □ P,M,K,N	14.4	15.0	65	115	85	143	152	204
145 - □ P,M,K,N	14.5	15.0	65	115	85	143	152	204
146 - □ P,M,K,N	14.6	15.0	65	115	85	143	152	204
147 - □ P,M,K,N	14.7	15.0	65	115	85	143	152	204
148 - □ P,M,K,N	14.8	15.0	65	115	85	143	152	204
149 - □ P,M,K,N	14.9	15.0	65	115	85	143	152	204
150 - □ P,M,K,N	15.0	15.0	65	115	85	143	152	204
151 - □ P,M,K,N	15.1	16.0	68	115	88	143	152	204
152 - □ P,M,K,N	15.2	16.0	68	115	88	143	152	204
153 - □ P,M,K,N	15.3	16.0	68	115	88	143	152	204
154 - □ P,M,K,N	15.4	16.0	68	115	88	143	152	204
155 - □ P,M,K,N	15.5	16.0	68	115	88	143	152	204
156 - □ P,M,K,N	15.6	16.0	68	115	88	143	152	204
157 - □ P,M,K,N	15.7	16.0	68	115	88	143	152	204
158 - □ P,M,K,N	15.8	16.0	68	115	88	143	152	204
159 - □ P,M,K,N	15.9	16.0	68	115	88	143	152	204
160 - □ P,M,K,N	16.0	16.0	68	115	88	143	152	204
161 - □ P,M,K,N	16.1	17.0	73	123	93	153	171	223
162 - □ P,M,K,N	16.2	17.0	73	123	93	153	171	223
163 - □ P,M,K,N	16.3	17.0	73	123	93	153	171	223
164 - □ P,M,K,N	16.4	17.0	73	123	93	153	171	223
165 - □ P,M,K,N	16.5	17.0	73	123	93	153	171	223
166 - □ P,M,K,N	16.6	17.0	73	123	93	153	171	223
167 - □ P,M,K,N	16.7	17.0	73	123	93	153	171	223
168 - □ P,M,K,N	16.8	17.0	73	123	93	153	171	223



MSDP(H)- □(P/M/K/N)

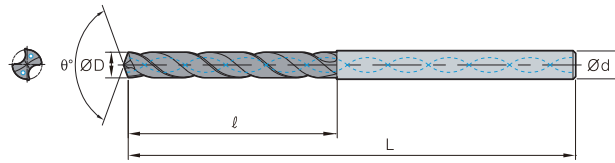

Terminology	P	M	K	N
Grade	PC325U			FG2
Tolerance (drill Dia.)	h7			
Tolerance (shank Dia.)	h6			
Point angle	140°		135°	
Twist angle	30°			
Thinning	X type			
Coolant	Through/External			

Steel M Stainless steel Cast iron Non-ferrous metal

(mm)

Designation	ØD	Ød	3P,M,K,N		5P,M,K,N		7P,M,K,N	
			ℓ	L	ℓ	L	ℓ	L
MSDP(H) 169 - □ P,M,K,N	16.9	17.0	73	123	93	153	171	223
170 - □ P,M,K,N	17.0	17.0	73	123	93	153	171	223
171 - □ P,M,K,N	17.1	18.0	73	123	98	153	171	223
172 - □ P,M,K,N	17.2	18.0	73	123	98	153	171	223
173 - □ P,M,K,N	17.3	18.0	73	123	98	153	171	223
174 - □ P,M,K,N	17.4	18.0	73	123	98	153	171	223
175 - □ P,M,K,N	17.5	18.0	73	123	98	153	171	223
176 - □ P,M,K,N	17.6	18.0	73	123	98	153	171	223
177 - □ P,M,K,N	17.7	18.0	73	123	98	153	171	223
178 - □ P,M,K,N	17.8	18.0	73	123	98	153	171	223
179 - □ P,M,K,N	17.9	18.0	73	123	98	153	171	223
180 - □ P,M,K,N	18.0	18.0	73	123	98	153	171	223
181 - □ P,M,K,N	18.1	19.0	79	131	103	153	190	244
182 - □ P,M,K,N	18.2	19.0	79	131	103	153	190	244
183 - □ P,M,K,N	18.3	19.0	79	131	103	153	190	244
184 - □ P,M,K,N	18.4	19.0	79	131	103	153	190	244
185 - □ P,M,K,N	18.5	19.0	79	131	103	153	190	244
186 - □ P,M,K,N	18.6	19.0	79	131	103	153	190	244
187 - □ P,M,K,N	18.7	19.0	79	131	103	153	190	244
188 - □ P,M,K,N	18.8	19.0	79	131	103	153	190	244
189 - □ P,M,K,N	18.9	19.0	79	131	103	153	190	244
190 - □ P,M,K,N	19.0	19.0	79	131	103	153	190	244
191 - □ P,M,K,N	19.1	20.0	79	131	107	153	190	244
192 - □ P,M,K,N	19.2	20.0	79	131	107	153	190	244
193 - □ P,M,K,N	19.3	20.0	79	131	107	153	190	244
194 - □ P,M,K,N	19.4	20.0	79	131	107	153	190	244
195 - □ P,M,K,N	19.5	20.0	79	131	107	153	190	244
196 - □ P,M,K,N	19.6	20.0	79	131	107	153	190	244
197 - □ P,M,K,N	19.7	20.0	79	131	107	153	190	244
198 - □ P,M,K,N	19.8	20.0	79	131	107	153	190	244
199 - □ P,M,K,N	19.9	20.0	79	131	107	153	190	244
200 - □ P,M,K,N	20.0	20.0	79	131	107	153	190	244

G Technical Information for Mach Solid Drill Plus-S

Specialized for heat-resistant alloys used in the aerospace, energy, power generation and automotive industries

MSD Plus-S new

Mach Solid Drill Plus-S

- Improved Productivity and Excellent Machinability
 - Ensuring machinability with optimized blade design and chip pockets
- Stronger wear resistance
 - Provides extended tool life due to its excellent coating with improved high temperature and chipping resistance

Code system

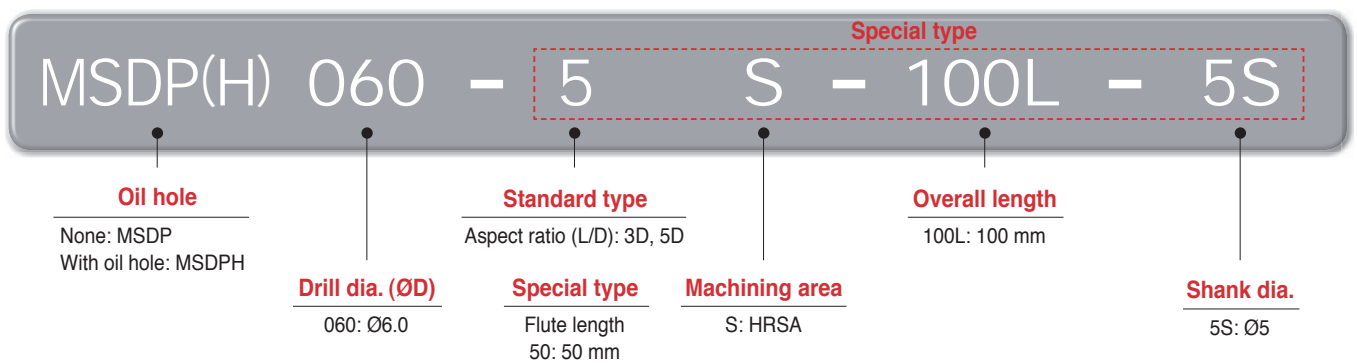

Features

- Notch-controlled blade design and specially treated cutting edges prevent chipping and breakage
- Optimized margin and back-tapered design

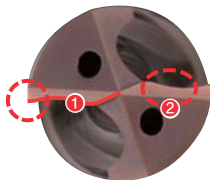

- ① Cutting edges designed for low cutting resistance
- ② Tip relief angle and shape optimized for heat evacuation

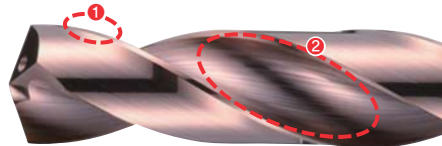

- ① Reduced friction resistance and cutting temperature
- ② Wider chip pockets improve chip evacuation

- Improved resistance to heat and oxidation thanks to the newly applied grade, PC325T
- Reduced friction resistance and improved chip evacuation due to excellent surface finish
- Exceptional wear resistance when machining heat-resistant alloys at high temperatures

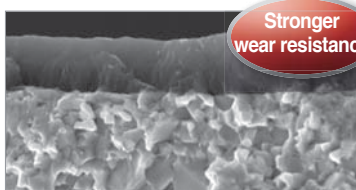

PC325T

Stronger wear resistance

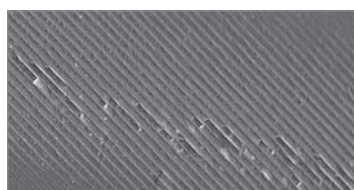

Smooth coating surface



Performance evaluation

- **Workpiece** Inconel718 (HRC40~45)
- **Cutting conditions** Drill dia.(mm) = Ø10, vc (m/min) = 20, fn (mm/rev) = 0.09, ap (mm) = 30, wet
- **Tools** MSDPH100-5S (PC325T)



- **Workpiece** Ti-6Al-4V (HRC42~47)
- **Cutting conditions** Drill dia.(mm) = Ø10, vc (m/min) = 40, fn (mm/rev) = 0.09, ap (mm) = 30, wet
- **Tools** MSDPH100-5S (PC325T)



Application examples

- **Use** Aircraft parts (turbine disks, turbine shafts, etc.) and components used in the power generation industry
- **Workpiece** Inconel718 (HRC40~45)
- **Cutting conditions** Drill dia.(mm) = Ø6.0, vc (m/min) = 20, fn (mm/rev) = 0.09, ap (mm) = 30, wet
- **Tools** MSDPH060-5S

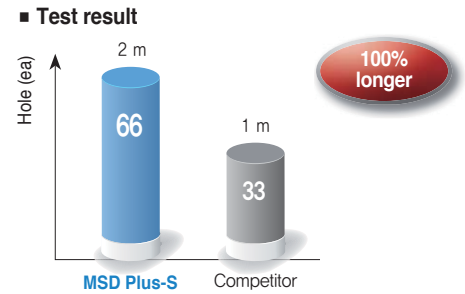
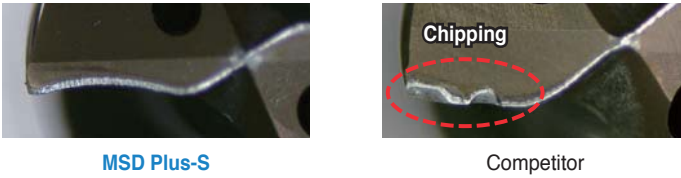

- **Use** Aircraft parts (engines, engine housings and turbine disks) and components used in the power generation industry
- **Workpiece** Ti-6Al-4V (HRC42~47)
- **Cutting conditions** Drill dia.(mm) = Ø6.0, vc (m/min) = 40, fn (mm/rev) = 0.09, ap (mm) = 30, wet
- **Tools** MSDPH060-5S

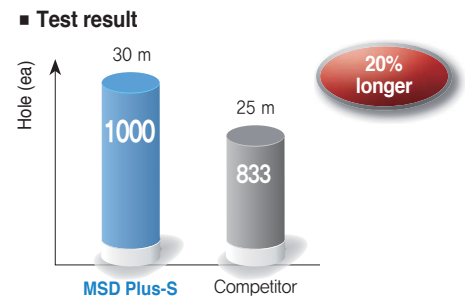

Recommended cutting conditions

Workpiece				Grade	vc (m/min)	Aspect ratio (L/D) = 3D~5D			
ISO	Workpiece	HB	Feed rate (mm/rev) per drill dia. (mm)						
			Ø2.5~Ø5.0			Ø5.1~Ø8.0	Ø8.1~Ø12.0	Ø12.1~Ø16.0	
S	HRSA (Inconel 718 and etc.)	Fe-base	25~35	PC325T	25~30	0.055~0.07	0.07~0.10	0.08~0.13	0.10~0.15
		Ni or Co base	35~45	PC325T	20~25	0.045~0.06	0.06~0.09	0.07~0.12	0.09~0.14
	Titanium alloy (Ti-6Al-4V and etc.)	Pure titanium	10~15	PC325T	40~50	0.07~0.11	0.09~0.14	0.12~0.18	0.16~0.23
		α and β alloys	35~45	PC325T	30~40	0.05~0.09	0.07~0.12	0.10~0.16	0.14~0.21

※ Cutting conditions above are for the case of less than 5D depth of cut and through coolant system applied.

MSDPH-S

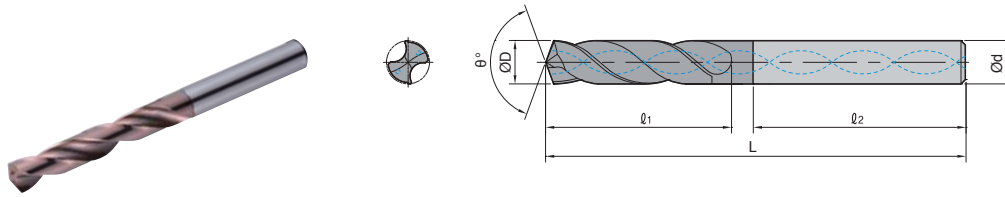

Specification	S
Grade	PC325T
Tolerance (Drill dia.)	h7
Tolerance (Shank dia.)	h6
Point angle (θ°)	140°
Twist angle	30°
Thinning	X type
International standard	DIN 6537
Shank type	DIN 6535 HA
Coolant	Internal

S HRSA

(mm)

Designation	ØD	Ød	3S		5S		ℓ2
			ℓ1	L	ℓ1	L	
MSDPH 030-□S	3.0	6	20	62	28	66	36
031-□S	3.1	6	20	62	28	66	36
0318-□S	3.18	6	20	62	28	66	36
032-□S	3.2	6	20	62	28	66	36
033-□S	3.3	6	20	62	28	66	36
034-□S	3.4	6	20	62	28	66	36
035-□S	3.5	6	20	62	28	66	36
0357-□S	3.57	6	20	62	28	66	36
036-□S	3.6	6	20	62	28	66	36
037-□S	3.7	6	20	62	28	66	36
038-□S	3.8	6	24	66	36	74	36
039-□S	3.9	6	24	66	36	74	36
0397-□S	3.97	6	24	66	36	74	36
040-□S	4.0	6	24	66	36	74	36
041-□S	4.1	6	24	66	36	74	36
042-□S	4.2	6	24	66	36	74	36
043-□S	4.3	6	24	66	36	74	36
0437-□S	4.37	6	24	66	36	74	36
044-□S	4.4	6	24	66	36	74	36
045-□S	4.5	6	24	66	36	74	36
046-□S	4.6	6	24	66	36	74	36
047-□S	4.7	6	24	66	36	74	36
0476-□S	4.76	6	28	66	44	82	36
048-□S	4.8	6	28	66	44	82	36
049-□S	4.9	6	28	66	44	82	36
050-□S	5.0	6	28	66	44	82	36
051-□S	5.1	6	28	66	44	82	36
0516-□S	5.16	6	28	66	44	82	36
052-□S	5.2	6	28	66	44	82	36
053-□S	5.3	6	28	66	44	82	36
054-□S	5.4	6	28	66	44	82	36
055-□S	5.5	6	28	66	44	82	36
0556-□S	5.56	6	28	66	44	82	36
056-□S	5.6	6	28	66	44	82	36
057-□S	5.7	6	28	66	44	82	36
058-□S	5.8	6	28	66	44	82	36
059-□S	5.9	6	28	66	44	82	36
0595-□S	5.95	6	28	66	44	82	36
060-□S	6.0	6	28	66	44	82	36
061-□S	6.1	8	34	79	53	91	36
062-□S	6.2	8	34	79	53	91	36
063-□S	6.3	8	34	79	53	91	36
0635-□S	6.35	8	34	79	53	91	36
064-□S	6.4	8	34	79	53	91	36
065-□S	6.5	8	34	79	53	91	36



MSDPH-S

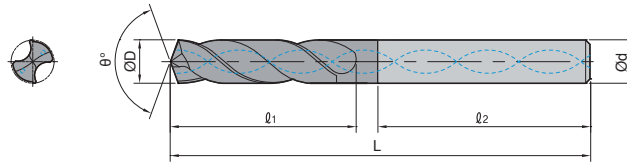
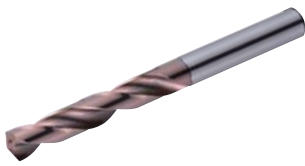

Specification	S
Grade	PC325T
Tolerance (Drill dia.)	h7
Tolerance (Shank dia.)	h6
Point angle (Ø°)	140°
Twist angle	30°
Thinning	X type
International standard	DIN 6537
Shank type	DIN 6535 HA
Coolant	Internal

S HRSA

Designation	ØD	Ød	3S		5S		L ₂
			L ₁	L	L ₁	L	
MSDPH 066-□S	6.6	8	34	79	53	91	36
067-□S	6.7	8	34	79	53	91	36
0675-□S	6.75	8	34	79	53	91	36
068-□S	6.8	8	34	79	53	91	36
069-□S	6.9	8	34	79	53	91	36
070-□S	7.0	8	34	79	53	91	36
071-□S	7.1	8	41	79	53	91	36
0714-□S	7.14	8	41	79	53	91	36
072-□S	7.2	8	41	79	53	91	36
073-□S	7.3	8	41	79	53	91	36
074-□S	7.4	8	41	79	53	91	36
075-□S	7.5	8	41	79	53	91	36
0754-□S	7.54	8	41	79	53	91	36
076-□S	7.6	8	41	79	53	91	36
077-□S	7.7	8	41	79	53	91	36
078-□S	7.8	8	41	79	53	91	36
079-□S	7.9	8	41	79	53	91	36
0794-□S	7.94	8	41	79	53	91	36
080-□S	8.0	8	41	79	53	91	36
081-□S	8.1	10	47	89	61	103	40
082-□S	8.2	10	47	89	61	103	40
083-□S	8.3	10	47	89	61	103	40
0833-□S	8.33	10	47	89	61	103	40
084-□S	8.4	10	47	89	61	103	40
085-□S	8.5	10	47	89	61	103	40
086-□S	8.6	10	47	89	61	103	40
087-□S	8.7	10	47	89	61	103	40
0873-□S	8.73	10	47	89	61	103	40
088-□S	8.8	10	47	89	61	103	40
089-□S	8.9	10	47	89	61	103	40
090-□S	9.0	10	47	89	61	103	40
091-□S	9.1	10	47	89	61	103	40
0913-□S	9.13	10	47	89	61	103	40
092-□S	9.2	10	47	89	61	103	40
093-□S	9.3	10	47	89	61	103	40
094-□S	9.4	10	47	89	61	103	40
095-□S	9.5	10	47	89	61	103	40
0953-□S	9.53	10	47	89	61	103	40
096-□S	9.6	10	47	89	61	103	40
097-□S	9.7	10	47	89	61	103	40
098-□S	9.8	10	47	89	61	103	40
099-□S	9.9	10	47	89	61	103	40
0992-□S	9.92	10	47	89	61	103	40
100-□S	10.0	10	47	89	61	103	40

(mm)

MSDPH-S

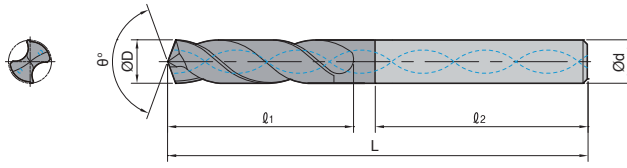
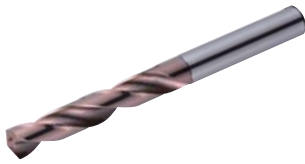

Specification	S
Grade	PC325T
Tolerance (Drill dia.)	h7
Tolerance (Shank dia.)	h6
Point angle (θ°)	140°
Twist angle	30°
Thinning	X type
International standard	DIN 6537
Shank type	DIN 6535 HA
Coolant	Internal

S HRSA

(mm)

Designation	ØD	Ød	3S		5S		L ₂
			l ₁	L	l ₁	L	
MSDPH 101-□S	10.1	12	55	102	71	118	45
102-□S	10.2	12	55	102	71	118	45
103-□S	10.3	12	55	102	71	118	45
1032-□S	10.32	12	55	102	71	118	45
104-□S	10.4	12	55	102	71	118	45
105-□S	10.5	12	55	102	71	118	45
106-□S	10.6	12	55	102	71	118	45
107-□S	10.7	12	55	102	71	118	45
1072-□S	10.72	12	55	102	71	118	45
108-□S	10.8	12	55	102	71	118	45
109-□S	10.9	12	55	102	71	118	45
110-□S	11.0	12	55	102	71	118	45
111-□S	11.1	12	55	102	71	118	45
1111-□S	11.11	12	55	102	71	118	45
112-□S	11.2	12	55	102	71	118	45
113-□S	11.3	12	55	102	71	118	45
114-□S	11.4	12	55	102	71	118	45
115-□S	11.5	12	55	102	71	118	45
1151-□S	11.51	12	55	102	71	118	45
116-□S	11.6	12	55	102	71	118	45
117-□S	11.7	12	55	102	71	118	45
118-□S	11.8	12	55	102	71	118	45
119-□S	11.9	12	55	102	71	118	45
1191-□S	11.91	12	55	102	71	118	45
120-□S	12.0	12	55	102	71	118	45
121-□S	12.1	14	60	107	77	124	45
122-□S	12.2	14	60	107	77	124	45
123-□S	12.3	14	60	107	77	124	45
124-□S	12.4	14	60	107	77	124	45
125-□S	12.5	14	60	107	77	124	45
126-□S	12.6	14	60	107	77	124	45
127-□S	12.7	14	60	107	77	124	45
128-□S	12.8	14	60	107	77	124	45
129-□S	12.9	14	60	107	77	124	45
130-□S	13.0	14	60	107	77	124	45
131-□S	13.1	14	60	107	77	124	45
132-□S	13.2	14	60	107	77	124	45
133-□S	13.3	14	60	107	77	124	45
134-□S	13.4	14	60	107	77	124	45
1349-□S	13.49	14	60	107	77	124	45
135-□S	13.5	14	60	107	77	124	45



MSDPH-S

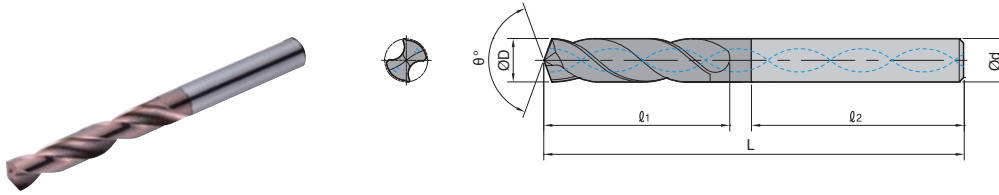

Specification	S
Grade	PC325T
Tolerance (Drill dia.)	h7
Tolerance (Shank dia.)	h6
Point angle (θ°)	140°
Twist angle	30°
Thinning	X type
International standard	DIN 6537
Shank type	DIN 6535 HA
Coolant	Internal

S HRSA

Designation	ØD	Ød	3S		5S		ℓ2
			ℓ1	L	ℓ1	L	
MSDPH 136-□S	13.6	14	60	107	77	124	45
137-□S	13.7	14	60	107	77	124	45
138-□S	13.8	14	60	107	77	124	45
139-□S	13.9	14	60	107	77	124	45
140-□S	14.0	14	60	107	77	124	45
141-□S	14.1	16	65	115	83	133	48
142-□S	14.2	16	65	115	83	133	48
1429-□S	14.29	16	65	115	83	133	48
143-□S	14.3	16	65	115	83	133	48
144-□S	14.4	16	65	115	83	133	48
145-□S	14.5	16	65	115	83	133	48
146-□S	14.6	16	65	115	83	133	48
147-□S	14.7	16	65	115	83	133	48
148-□S	14.8	16	65	115	83	133	48
149-□S	14.9	16	65	115	83	133	48
150-□S	15.0	16	65	115	83	133	48
151-□S	15.1	16	65	115	83	133	48
152-□S	15.2	16	65	115	83	133	48
153-□S	15.3	16	65	115	83	133	48
154-□S	15.4	16	65	115	83	133	48
155-□S	15.5	16	65	115	83	133	48
156-□S	15.6	16	65	115	83	133	48
157-□S	15.7	16	65	115	83	133	48
158-□S	15.8	16	65	115	83	133	48
1587-□S	15.87	16	65	115	83	133	48
159-□S	15.9	16	65	115	83	133	48
160-□S	16.0	16	65	115	83	133	48

G Technical Information for Mach Solid Drill Plus CFRP

Optimized tool for hole making of CFRP

MSD Plus CFRP new

Mach Solid Drill Plus CFRP

- KORLOY's new diamond coated grade ND2110 offers excellent wear resistance
- The optimal cutting edge reduces burrs.

Code system

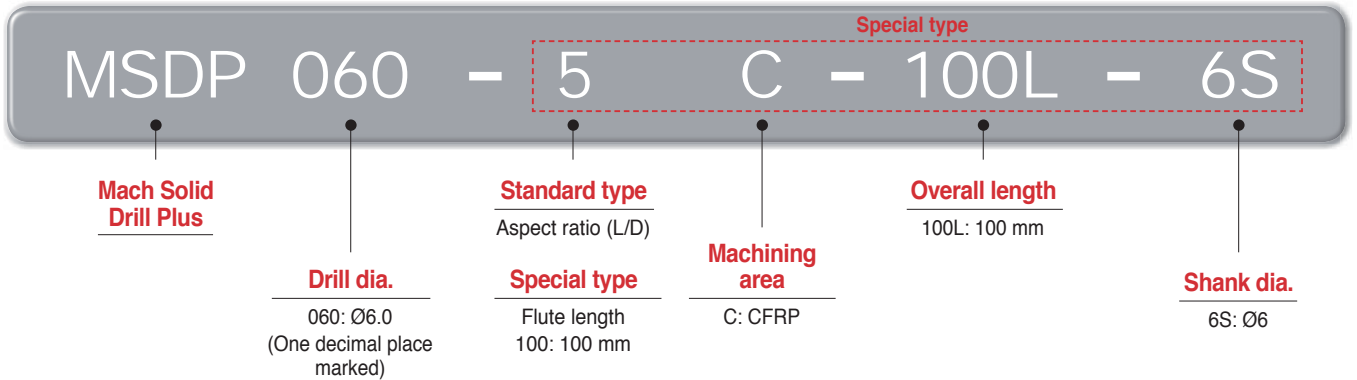

Features

- The cutting edge with a 2 step shape reduces the cutting load
- The optimal point angle of cutting edge reduces burrs
- Higher hardness of cutting edge increases wear resistance



ND2110

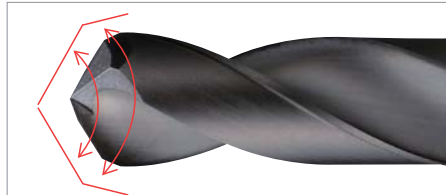

- Diamond coating specialized in CFRP machining
- Diamond-coated substrate optimized for CFRP cutting



High hardness diamond coating maintains well-cut shapes

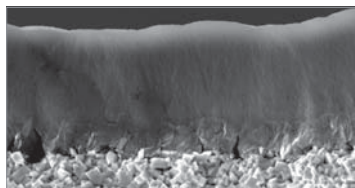

Diamond coating's strong grip to the substrate

- Inhibited burr creation by keeping cutting edges in good shape



Inhibited flaking

Less wear and flaking on the rake surface



Fewer burrs on workpieces



Performance evaluation

- **Workpiece** CFRP
- **Cutting conditions** vc (m/min) = 100, fn (mm/rev) = 0.05, ap (mm) = 10, Air
- **Cutting length** 7.2 m (720 holes)
- **Tools** MSDP060-5C (ND2110)

Improved performance quality

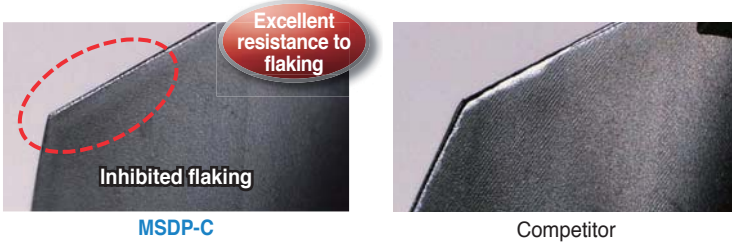

- **Workpiece** CFRP
- **Cutting conditions** vc (m/min) = 100, fn (mm/rev) = 0.05, ap (mm) = 10, Air
- **Cutting length** 7.2 m (720 holes)
- **Tools** MSDP060-5C (ND2110)

Machinability in high quality hole making

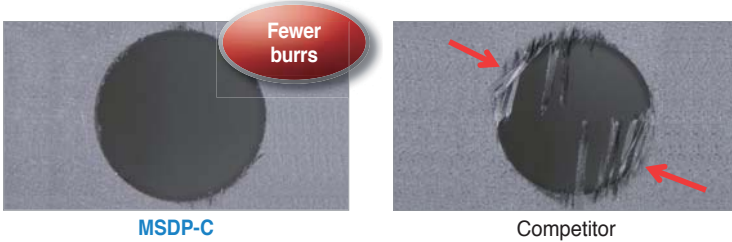

Application examples

- **Use** Wing Tail
- **Workpiece** CFRP
- **Cutting conditions** vc (m/min) = 100, fn (mm/rev) = 0.05, ap (mm) = 10, Air
- **Tools** MSDP060-5C (ND2110)



Test result

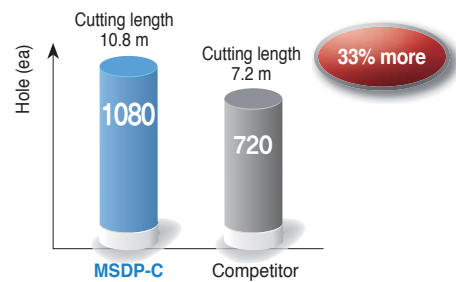

Recommended cutting conditions

Workpiece	Grade	vc (m/min)	Aspect ratio (L/D) = 5D		
			Feed rate (mm/rev) per drill dia. (mm)		
			Ø2.5~Ø4.0	Ø4.1~Ø8.0	Ø8.1~Ø12.0
CFRP	ND2110	100 (100~150)	0.03~0.07	0.03~0.07	0.03~0.07

MSDP (5C)

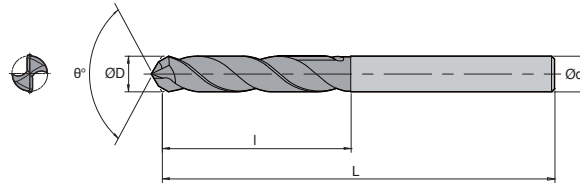

Specification	C
Grade	ND2110
Tolerance (drill Dia.)	m7
Tolerance (shank Dia.)	h6
Point angle	118°
Twist angle	30°
Thinning	X type
Coolant	External
☑ CFRP	

(mm)

Designation	ØD		Ød	5C	
	mm	inch		l	L
MSDP 030-5C	3	-	6	28	66
040-5C	4	-	6	36	74
0476-5C	4.76	3/16	6	44	82
050-5C	5	-	6	44	82
060-5C	6	-	6	44	82
0635-5C	6.35	1/4	8	53	91
070-5C	7	-	8	53	91
0794-5C	7.94	5/16	8	53	91
080-5C	8	-	8	53	91
090-5C	9	-	10	61	103
0952-5C	9.52	3/8	10	61	103
100-5C	10	-	10	61	103
110-5C	11	-	12	71	118
1111-5C	11.11	7/16	12	71	118
120-5C	12	-	12	71	118
127-5C	12.7	1/2	14	71	124



The best tool for ramped, curved or flat workpieces

MSFD **new**

Mach Solid Flat Drill

- High quality hole making capability with 180°-point angle
- Improved anti chipping and welding resistance by edge honing and chamfering
Minimized creation of burrs compared to general drills

Code system

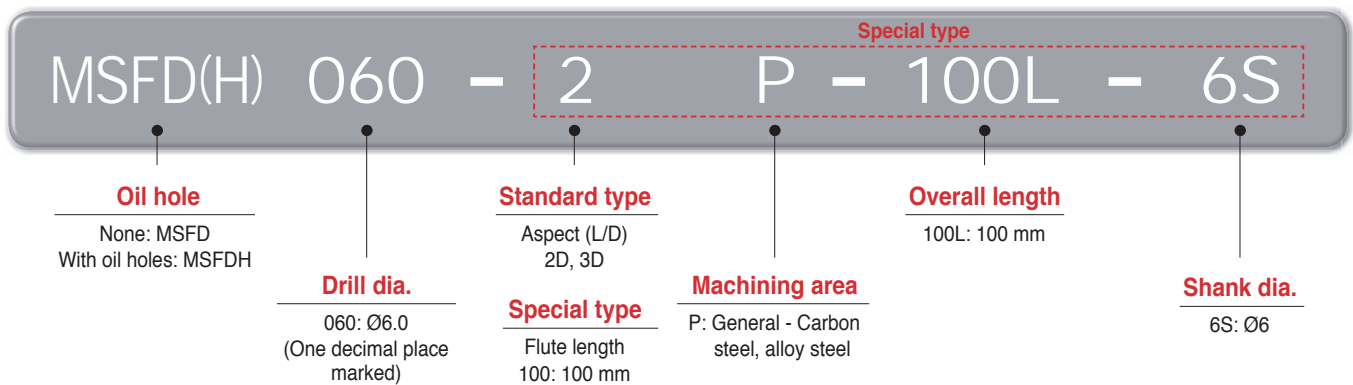

Features

- Excellent straightness with its 180°-point angle when drilling on ramped surface
- Stronger resistance to chipping through corner chamfering
- Widened chip pockets by the use of 'R' shape on the thinning part

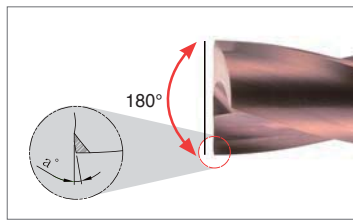
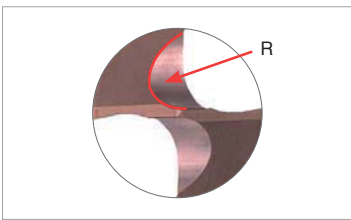

- Multi-functional capability - end milling and drilling using a single MSFD

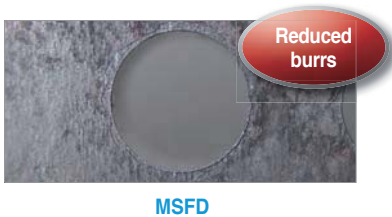
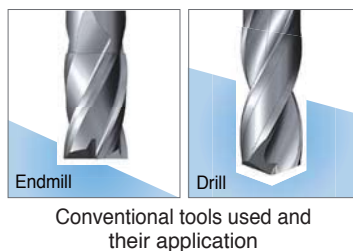

G Technical Information for Mach Solid Flat Drill

Wide applications

- A wide range of applications and improved cutting performance

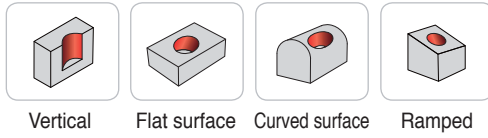

Performance evaluation

- **Workpiece** SM48C
- **Cutting conditions** vc (m/min) = 80, fn (mm/min) = 0.10, ap (mm) = 15, wet
- **Cutting length** 7.2 m (600 holes)
- **Tools** MSFD060-2P (PC325U)

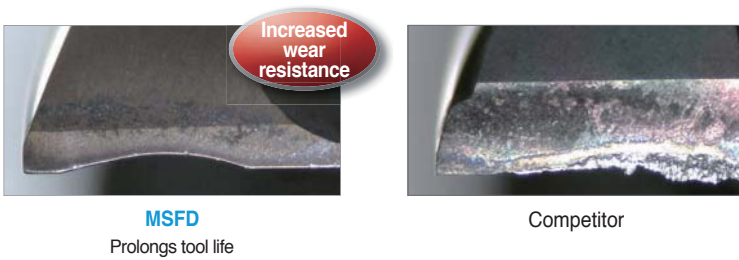

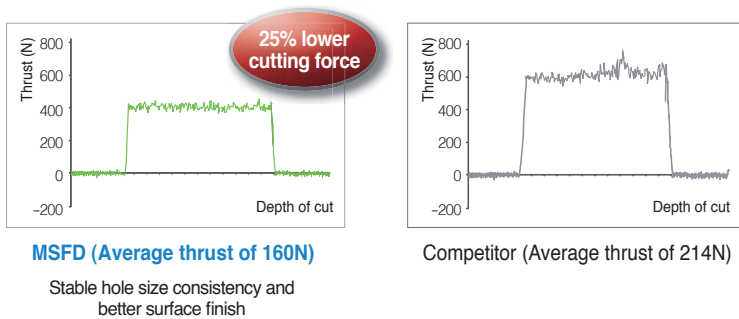

- **Workpiece** SM45C
- **Cutting conditions** vc (m/min) = 70, fn (mm/min) = 0.10, ap (mm) = 15, wet
- **Tools** MSFDH060-3P (PC325U)

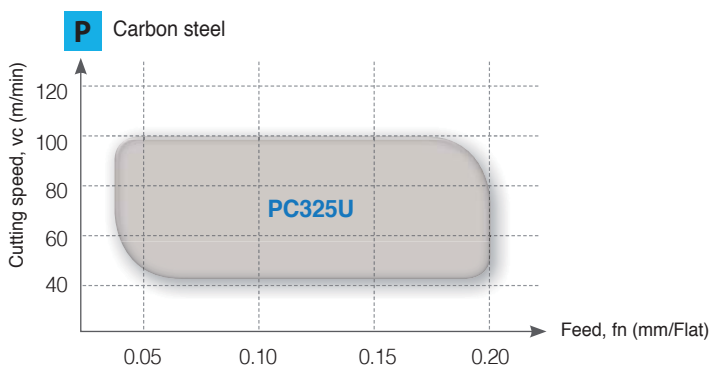

Application range

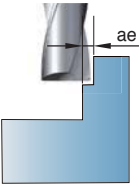

Application methods

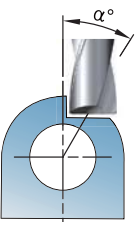
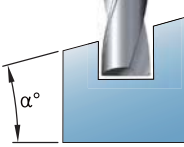
Application type	Recommended machining conditions	Application type	Recommended machining conditions																										
	<ul style="list-style-type: none"> Radial depth of cuts should be less than half the drill radius In case of increasing depth of cuts, divide the machining process into two passes 		<ul style="list-style-type: none"> Reduce the feed rate by half the recommended condition when the tool enters the workpiece Reduce the feed rate by half the recommended condition when the tool penetrates the workpiece to the end part Recommended depth of cut is under 2D 																										
	<ul style="list-style-type: none"> Use the tool within 30° from the center of the curve Reduce the feed rate when the tool penetrates the workpiece to the end part <table border="1"> <thead> <tr> <th>Workpiece (Ø)</th> <th>Slope angle (α°)</th> <th>Performance</th> <th>Applied (fn)</th> </tr> </thead> <tbody> <tr> <td rowspan="3">≤ Ø100</td> <td>≤ 20°</td> <td>◎</td> <td>100%</td> </tr> <tr> <td>20° < ~40°</td> <td>○</td> <td>80%</td> </tr> <tr> <td>≥ 40°</td> <td>△</td> <td>60%</td> </tr> </tbody> </table>	Workpiece (Ø)	Slope angle (α°)	Performance	Applied (fn)	≤ Ø100	≤ 20°	◎	100%	20° < ~40°	○	80%	≥ 40°	△	60%		<ul style="list-style-type: none"> Recommended slope angle range is under 30° In case of machining at slope angle over 30°, reduce the feed rate when the tool enters the workpiece <table border="1"> <thead> <tr> <th>Slope angle (α°)</th> <th>Performance</th> <th>Applied (fn)</th> </tr> </thead> <tbody> <tr> <td>≤ 20°</td> <td>◎</td> <td>100%</td> </tr> <tr> <td>20° < ~40°</td> <td>○</td> <td>80%</td> </tr> <tr> <td>≥ 40°</td> <td>△</td> <td>60%</td> </tr> </tbody> </table>	Slope angle (α°)	Performance	Applied (fn)	≤ 20°	◎	100%	20° < ~40°	○	80%	≥ 40°	△	60%
Workpiece (Ø)	Slope angle (α°)	Performance	Applied (fn)																										
≤ Ø100	≤ 20°	◎	100%																										
	20° < ~40°	○	80%																										
	≥ 40°	△	60%																										
Slope angle (α°)	Performance	Applied (fn)																											
≤ 20°	◎	100%																											
20° < ~40°	○	80%																											
≥ 40°	△	60%																											

Recommended cutting conditions

Workpiece			Grade	vc (m/min)	Aspect ratio (L/D) = 2D~3D			
ISO	Workpiece	HB			Feed rate (mm/rev) per drill dia. (mm)			
					Ø2.5~Ø4.0	Ø4.1~Ø8.0	Ø8.1~Ø12.0	
P	Carbon steel	Low carbon steel	80~120	PC325U	75 (60~90)	0.03~0.10	0.05~0.15	0.10~0.20
		High carbon steel	180~280	PC325U	75 (60~80)	0.03~0.10	0.05~0.15	0.10~0.20
	Alloy steel	Low alloy steel	140~260	PC325U	65 (50~80)	0.03~0.10	0.05~0.15	0.10~0.20
		High alloy steel	50~260	PC325U	65 (50~80)	0.03~0.10	0.05~0.15	0.10~0.20

Application examples

- **Workpiece** Carbon steel (SM45C)
- **Cutting conditions**
 - vc (m/min) = 80
 - fn (mm/min) = 0.1
 - ap (mm) = 12, wet
- **Tools** MSFD060-2P (PC325U)



Test result

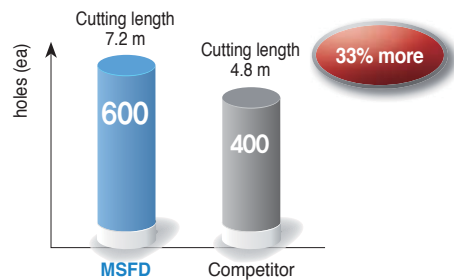

- **Workpiece** Alloy steel (SCM440)
- **Cutting conditions**
 - vc (m/min) = 100
 - fn (mm/min) = 0.1
 - ap (mm) = 14, wet
- **Tools** MSFDH060-3P (PC325U)



Test result

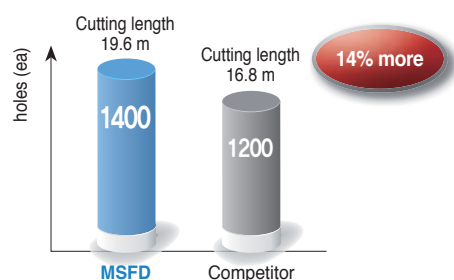

MSFD (2P)

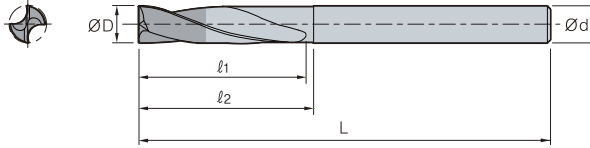

Terminology	P
Grade	PC325U
Tolerance (drill Dia.)	H7
Tolerance (shank Dia.)	h6
Point angle	180°
Twist angle	20°
Thinning	R type
Coolant	External

Steel

(mm)

Designation	ØD	Ød	2P		
			ℓ1	ℓ2	L
MSFD 025-2P	2.5	4.0	10.5	11.5	50
026-2P	2.6	4.0	10.9	11.9	50
027-2P	2.7	4.0	11.3	12.3	50
028-2P	2.8	4.0	11.8	12.8	50
029-2P	2.9	4.0	12.2	13.2	50
030-2P	3.0	6.0	12.6	13.6	50
031-2P	3.1	6.0	13.0	14.0	50
032-2P	3.2	6.0	13.4	14.4	50
033-2P	3.3	6.0	13.9	14.9	50
034-2P	3.4	6.0	14.3	15.3	50
035-2P	3.5	6.0	14.7	15.7	50
036-2P	3.6	6.0	15.1	16.1	50
037-2P	3.7	6.0	15.5	16.5	50
038-2P	3.8	6.0	16.0	17.0	50
039-2P	3.9	6.0	16.4	17.4	50
040-2P	4.0	6.0	16.8	17.8	50
041-2P	4.1	6.0	17.2	18.2	60
042-2P	4.2	6.0	17.6	18.6	60
043-2P	4.3	6.0	18.1	19.1	60
044-2P	4.4	6.0	18.5	19.5	60
045-2P	4.5	6.0	18.9	19.9	60
046-2P	4.6	6.0	19.3	20.3	60
047-2P	4.7	6.0	19.7	20.7	60
048-2P	4.8	6.0	20.2	21.2	60
049-2P	4.9	6.0	20.6	21.6	60
050-2P	5.0	6.0	21.0	22.0	60
051-2P	5.1	6.0	21.4	22.4	60
052-2P	5.2	6.0	21.8	22.8	60
053-2P	5.3	6.0	22.3	23.3	60
054-2P	5.4	6.0	22.7	23.7	60
055-2P	5.5	6.0	23.1	24.1	60
056-2P	5.6	6.0	23.5	24.5	60
057-2P	5.7	6.0	23.9	24.9	60
058-2P	5.8	6.0	24.4	25.4	60
059-2P	5.9	6.0	24.8	25.8	60
060-2P	6.0	6.0	25.2	26.2	60
061-2P	6.1	8.0	25.6	26.6	70
062-2P	6.2	8.0	26.0	27.0	70
063-2P	6.3	8.0	26.5	27.5	70
064-2P	6.4	8.0	26.9	27.9	70
065-2P	6.5	8.0	27.3	28.3	70
066-2P	6.6	8.0	27.7	28.7	70
067-2P	6.7	8.0	28.1	29.1	70
068-2P	6.8	8.0	28.6	29.6	70
069-2P	6.9	8.0	29.0	30.0	70
070-2P	7.0	8.0	29.4	30.4	70



MSFD (2P)

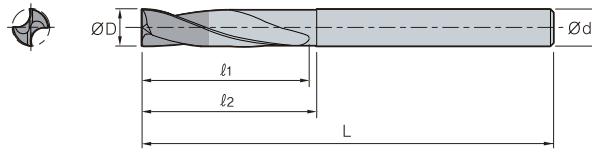

Terminology	P
Grade	PC325U
Tolerance (drill Dia.)	H7
Tolerance (shank Dia.)	h6
Point angle	180°
Twist angle	20°
Thinning	R type
Coolant	External

■ Steel

Designation	ØD	Ød	2P		
			l ₁	l ₂	L
MSFD 071-2P	7.1	8.0	29.8	30.8	70
072-2P	7.2	8.0	30.2	31.2	70
073-2P	7.3	8.0	30.7	31.7	70
074-2P	7.4	8.0	31.1	32.1	70
075-2P	7.5	8.0	31.5	32.5	70
076-2P	7.6	8.0	31.9	32.9	70
077-2P	7.7	8.0	32.3	33.3	70
078-2P	7.8	8.0	32.8	33.8	70
079-2P	7.9	8.0	33.2	34.2	70
080-2P	8.0	8.0	33.6	34.6	70
081-2P	8.1	10.0	34.0	35.0	80
082-2P	8.2	10.0	34.4	35.4	80
083-2P	8.3	10.0	34.9	35.9	80
084-2P	8.4	10.0	35.3	36.3	80
085-2P	8.5	10.0	35.7	36.7	80
086-2P	8.6	10.0	36.1	37.1	80
087-2P	8.7	10.0	36.5	37.5	80
088-2P	8.8	10.0	37.0	38.0	80
089-2P	8.9	10.0	37.4	38.4	80
090-2P	9.0	10.0	37.8	38.8	80
091-2P	9.1	10.0	38.2	39.2	80
092-2P	9.2	10.0	38.6	39.6	80
093-2P	9.3	10.0	39.1	40.1	80
094-2P	9.4	10.0	39.5	40.5	80
095-2P	9.5	10.0	39.9	40.9	80
096-2P	9.6	10.0	40.3	41.3	80
097-2P	9.7	10.0	40.7	41.7	80
098-2P	9.8	10.0	41.2	42.2	80
099-2P	9.9	10.0	41.6	42.6	80
100-2P	10.0	10.0	42.0	43	80
101-2P	10.1	12.0	42.4	43.4	90
102-2P	10.2	12.0	42.8	43.8	90
103-2P	10.3	12.0	43.3	44.3	90
104-2P	10.4	12.0	43.7	44.7	90
105-2P	10.5	12.0	44.1	45.1	90
106-2P	10.6	12.0	44.5	45.5	90
107-2P	10.7	12.0	44.9	45.9	90
108-2P	10.8	12.0	45.4	46.4	90
109-2P	10.9	12.0	45.8	46.8	90
110-2P	11.0	12.0	46.2	47.2	90
111-2P	11.1	12.0	46.6	47.6	90
112-2P	11.2	12.0	47.0	48.0	90
113-2P	11.3	12.0	47.5	48.5	90
114-2P	11.4	12.0	47.9	48.9	90
115-2P	11.5	12.0	48.3	49.3	90
116-2P	11.6	12.0	48.7	49.7	90
117-2P	11.7	12.0	49.1	50.1	90
118-2P	11.8	12.0	49.6	50.6	90
119-2P	11.9	12.0	50.0	51.0	90
120-2P	12.0	12.0	50.4	51.4	90

(mm)

MSFD (2P)

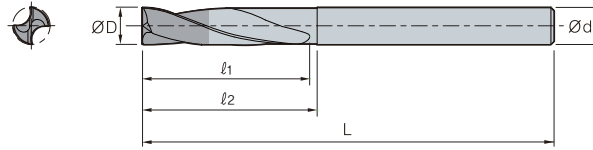

Terminology	P
Grade	PC325U
Tolerance (drill Dia.)	H7
Tolerance (shank Dia.)	h6
Point angle	180°
Twist angle	30°
Thinning	R type
Coolant	Through

Steel

(mm)

Designation	ØD	Ød	2P		
			l ₁	l ₂	L
MSFD 121-2P	12.1	14.0	50.8	51.8	100
122-2P	12.2	14.0	51.2	52.2	100
123-2P	12.3	14.0	51.7	52.7	100
124-2P	12.4	14.0	52.1	53.1	100
125-2P	12.5	14.0	52.5	53.5	100
126-2P	12.6	14.0	52.9	53.9	100
127-2P	12.7	14.0	53.3	54.3	100
128-2P	12.8	14.0	53.8	54.8	100
129-2P	12.9	14.0	54.2	55.2	100
130-2P	13.0	14.0	54.6	55.6	100
131-2P	13.1	14.0	55.0	56.0	100
132-2P	13.2	14.0	55.4	56.4	100
133-2P	13.3	14.0	55.9	56.9	100
134-2P	13.4	14.0	56.3	57.3	100
135-2P	13.5	14.0	56.7	57.7	110
136-2P	13.6	14.0	57.1	58.1	110
137-2P	13.7	14.0	57.5	58.5	110
138-2P	13.8	14.0	58.0	59.0	110
139-2P	13.9	14.0	58.4	59.4	110
140-2P	14.0	14.0	58.8	59.8	110
141-2P	14.1	16.0	59.2	60.2	110
142-2P	14.2	16.0	59.6	60.6	110
143-2P	14.3	16.0	60.1	61.1	110
144-2P	14.4	16.0	60.5	61.5	110
145-2P	14.5	16.0	60.9	61.9	110
146-2P	14.6	16.0	61.3	62.3	110
147-2P	14.7	16.0	61.7	62.7	110
148-2P	14.8	16.0	62.2	63.2	110
149-2P	14.9	16.0	62.6	63.6	110
150-2P	15.0	16.0	63.0	64.0	110
151-2P	15.1	16.0	65.0	66.0	115
152-2P	15.2	16.0	65.0	66.0	115
153-2P	15.3	16.0	65.1	66.1	115
154-2P	15.4	16.0	65.1	66.1	115
155-2P	15.5	16.0	65.1	66.1	115
156-2P	15.6	16.0	67.1	68.1	115
157-2P	15.7	16.0	67.1	68.1	115
158-2P	15.8	16.0	67.2	68.2	115
159-2P	15.9	16.0	67.2	68.2	115
160-2P	16.0	16.0	67.2	68.2	115



MSFDH (3P)

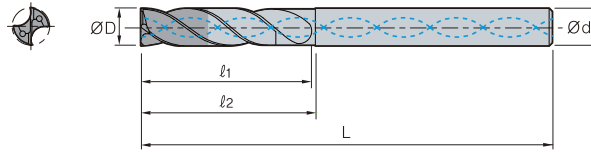

Terminology	P
Grade	PC325U
Tolerance (drill Dia.)	H7
Tolerance (shank Dia.)	h6
Point angle	180°
Twist angle	30°
Thinning	R type
Coolant	Through

■ Steel

Designation	ØD	Ød	3P		
			l ₁	l ₂	L
MSFDH 025-3P	2.5	3.0	17	18	58
026-3P	2.6	3.0	17	18	58
027-3P	2.7	3.0	17	18	58
028-3P	2.8	3.0	17	18	58
029-3P	2.9	3.0	17	18	58
030-3P	3.0	6.0	20	21	62
031-3P	3.1	6.0	20	21	62
032-3P	3.2	6.0	20	21	62
033-3P	3.3	6.0	20	21	62
034-3P	3.4	6.0	20	21	62
035-3P	3.5	6.0	20	21	62
036-3P	3.6	6.0	20	21	62
037-3P	3.7	6.0	20	21	62
038-3P	3.8	6.0	24	25	66
039-3P	3.9	6.0	24	25	66
040-3P	4.0	6.0	24	25	66
041-3P	4.1	6.0	24	25	66
042-3P	4.2	6.0	24	25	66
043-3P	4.3	6.0	24	25	66
044-3P	4.4	6.0	24	25	66
045-3P	4.5	6.0	24	25	66
046-3P	4.6	6.0	24	25	66
047-3P	4.7	6.0	24	25	66
048-3P	4.8	6.0	28	29	66
049-3P	4.9	6.0	28	29	66
050-3P	5.0	6.0	28	29	66
051-3P	5.1	6.0	28	29	66
052-3P	5.2	6.0	28	29	66
053-3P	5.3	6.0	28	29	66
054-3P	5.4	6.0	28	29	66
055-3P	5.5	6.0	28	29	66
056-3P	5.6	6.0	28	29	66
057-3P	5.7	6.0	28	29	66
058-3P	5.8	6.0	28	29	66
059-3P	5.9	6.0	28	29	66
060-3P	6.0	6.0	28	29	66
061-3P	6.1	8.0	34	35	79
062-3P	6.2	8.0	34	35	79
063-3P	6.3	8.0	34	35	79
064-3P	6.4	8.0	34	35	79
065-3P	6.5	8.0	34	35	79
066-3P	6.6	8.0	34	35	79
067-3P	6.7	8.0	34	35	79
068-3P	6.8	8.0	34	35	79
069-3P	6.9	8.0	34	35	79
070-3P	7.0	8.0	34	35	79

(mm)

MSFDH (3P)

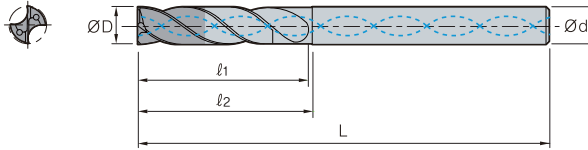

Terminology	P
Grade	PC325U
Tolerance (drill Dia.)	H7
Tolerance (shank Dia.)	h6
Point angle	180°
Twist angle	30°
Thinning	R type
Coolant	Through

Steel

(mm)

Designation	ØD	Ød	3P		
			ℓ1	ℓ2	L
MSFDH 071-3P	7.1	8.0	41	42	79
072-3P	7.2	8.0	41	42	79
073-3P	7.3	8.0	41	42	79
074-3P	7.4	8.0	41	42	79
075-3P	7.5	8.0	41	42	79
076-3P	7.6	8.0	41	42	79
077-3P	7.7	8.0	41	42	79
078-3P	7.8	8.0	41	42	79
079-3P	7.9	8.0	41	42	79
080-3P	8.0	8.0	41	42	79
081-3P	8.1	10.0	47	48	89
082-3P	8.2	10.0	47	48	89
083-3P	8.3	10.0	47	48	89
084-3P	8.4	10.0	47	48	89
085-3P	8.5	10.0	47	48	89
086-3P	8.6	10.0	47	48	89
087-3P	8.7	10.0	47	48	89
088-3P	8.8	10.0	47	48	89
089-3P	8.9	10.0	47	48	89
090-3P	9.0	10.0	47	48	89
091-3P	9.1	10.0	47	48	89
092-3P	9.2	10.0	47	48	89
093-3P	9.3	10.0	47	48	89
094-3P	9.4	10.0	47	48	89
095-3P	9.5	10.0	47	48	89
096-3P	9.6	10.0	47	48	89
097-3P	9.7	10.0	47	48	89
098-3P	9.8	10.0	47	48	89
099-3P	9.9	10.0	47	48	89
100-3P	10.0	10.0	47	48	89
101-3P	10.1	12.0	55	56	102
102-3P	10.2	12.0	55	56	102
103-3P	10.3	12.0	55	56	102
104-3P	10.4	12.0	55	56	102
105-3P	10.5	12.0	55	56	102
106-3P	10.6	12.0	55	56	102
107-3P	10.7	12.0	55	56	102
108-3P	10.8	12.0	55	56	102
109-3P	10.9	12.0	55	56	102
110-3P	11.0	12.0	55	56	102
111-3P	11.1	12.0	55	56	102
112-3P	11.2	12.0	55	56	102
113-3P	11.3	12.0	55	56	102
114-3P	11.4	12.0	55	56	102
115-3P	11.5	12.0	55	56	102
116-3P	11.6	12.0	55	56	102
117-3P	11.7	12.0	55	56	102
118-3P	11.8	12.0	55	56	102
119-3P	11.9	12.0	55	56	102
120-3P	12.0	12.0	55	56	102



MSFDH (3P)

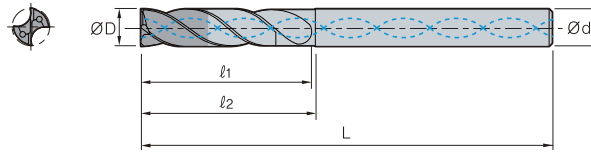

Terminology	P
Grade	PC325U
Tolerance (drill Dia.)	H7
Tolerance (shank Dia.)	h6
Point angle	180°
Twist angle	30°
Thinning	R type
Coolant	Through

■ Steel

Designation	ØD	Ød	3P		
			l ₁	l ₂	L
MSFDH 121-3P	12.1	14.0	60	61	107
122-3P	12.2	14.0	60	61	107
123-3P	12.3	14.0	60	61	107
124-3P	12.4	14.0	60	61	107
125-3P	12.5	14.0	60	61	107
126-3P	12.6	14.0	60	61	107
127-3P	12.7	14.0	60	61	107
128-3P	12.8	14.0	60	61	107
129-3P	12.9	14.0	60	61	107
130-3P	13.0	14.0	60	61	107
131-3P	13.1	14.0	60	61	107
132-3P	13.2	14.0	60	61	107
133-3P	13.3	14.0	60	61	107
134-3P	13.4	14.0	60	61	107
135-3P	13.5	14.0	60	61	107
136-3P	13.6	14.0	60	61	107
137-3P	13.7	14.0	60	61	107
138-3P	13.8	14.0	60	61	107
139-3P	13.9	14.0	60	61	107
140-3P	14.0	14.0	60	61	107
141-3P	14.1	16.0	65	66	115
142-3P	14.2	16.0	65	66	115
143-3P	14.3	16.0	65	66	115
144-3P	14.4	16.0	65	66	115
145-3P	14.5	16.0	65	66	115
146-3P	14.6	16.0	65	66	115
147-3P	14.7	16.0	65	66	115
148-3P	14.8	16.0	65	66	115
149-3P	14.9	16.0	65	66	115
150-3P	15.0	16.0	65	66	115
151-3P	15.1	16.0	65	66	115
152-3P	15.2	16.0	65	66	115
153-3P	15.3	16.0	65	66	115
154-3P	15.4	16.0	65	66	115
155-3P	15.5	16.0	65	66	115
156-3P	15.6	16.0	65	66	115
157-3P	15.7	16.0	65	66	115
158-3P	15.8	16.0	65	66	115
159-3P	15.9	16.0	65	66	115
160-3P	16.0	16.0	65	66	115

G Technical Information for Mach Long Solid Drill Plus

The most optimized tool for high precision and quality on hole making process

MLD Plus new

Mach Long Solid Drill Plus

Code system

Special type MLD 0600N - 10 P - 100L - 10S					
Mach Long Solid Drill Plus (MLD Plus)	Drill dia. (ØD) 0600: Ø6.00 (Two decimal place marked)	Standard type Aspect ratio (L/D) 10D, 15D, 20D, 25D	Machining area P: Carbon steel, alloy steel K: Cast iron N: Aluminum, copper alloy	Overall length 100L: 100 mm	Shank dia. 10S: Ø10
		Special type Flute length 100: 100 mm			

Features

Cutting edge and flute shape

- Straight cutting edge provides better rigidity
- Excellent chip evacuation due to wider chip pocket and improved flute surface roughness
- Double margin secures machining stability



Cutting edge shape

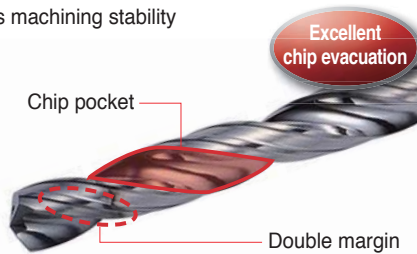

New grade (PC315G)

- Ultra-fine substrate and new coating applied
- Lubricative coating layer improves chip evacuation with lower frictional resistance
- Longer tool life due to higher wear resistance

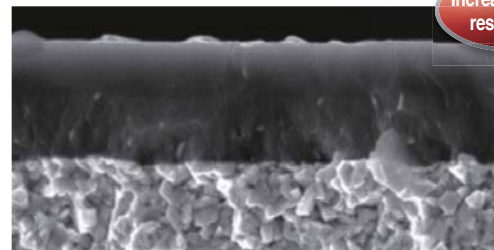

PC315G

Machining accuracy

- Improved machining precision
 - Bent holes reduced, Inside hole surface roughness improved
 - Hole size uniformity increased
- Improved point shape
 - Precise location secured

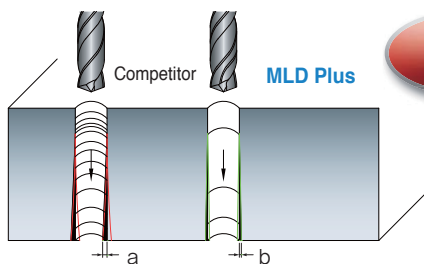

Reduced bent holes compared to competitors (a > b)

Cutting load

- **Workpiece** SM45C
- **Cutting conditions** Drill Dia.(m) = Ø6.0, vc (m/min) = 70
fn (mm/rev) = 0.12, ap (mm) = 60, wet
- **Tools** MLD0600N-20P

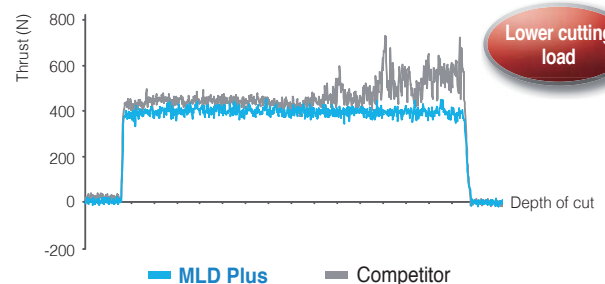

Application area

- **PC215G** – Excellent performance when machining cast iron and alloy steel at high speed
- **PC315G** – Universal grade excellent when machining carbon steel, cast iron, etc. at middle to low cutting speed

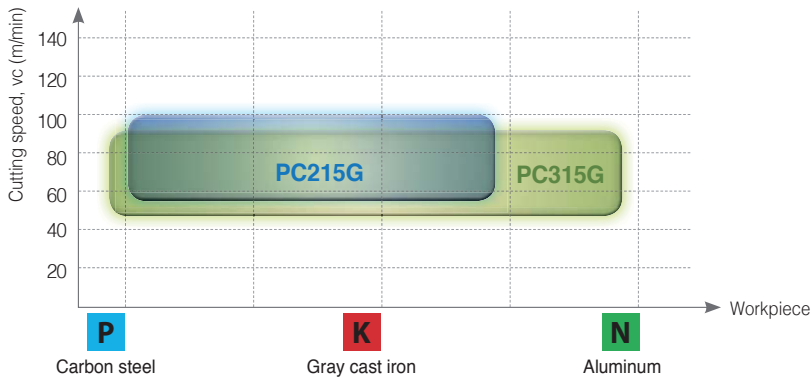

Application examples

- **Use** Part of Automobile
- **Workpiece** SM45C
- **Cutting conditions** vc (m/min) = 70, fn (mm/rev) = 0.12, ap (mm) = 60, Through coolant
- **Tools** MLD0400N-20P (PC315G)

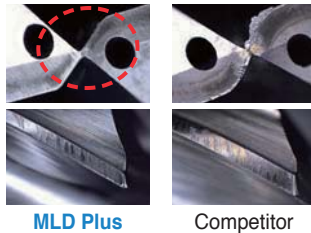

Test result

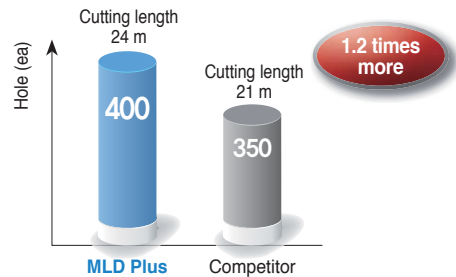

New grade PC315G's coating layer has been applied to improve wear resistance when machining carbon steel materials

- **Use** Part of Automobile
- **Workpiece** SCM440H
- **Cutting conditions** vc (m/min) = 70, fn (mm/rev) = 0.12, ap (mm) = 55, Through coolant
- **Tools** MLD0507N-15P (PC315G)



Test result

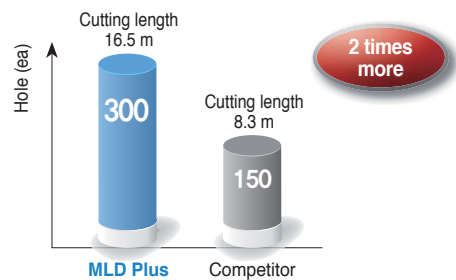

Double margin has been applied to improve stability and machining precision

Recommended cutting condition

Workpiece		Grade	vc (m/min)	Aspect ratio (L/D) = 10D~25D				
				Feed rate (mm/rev) per drill dia. (mm)				
ISO	Workpiece	HB	Recommended	Ø3.0~Ø5.0	Ø5.1~Ø8.0	Ø8.1~Ø10.0		
P	Carbon steel	Low carbon steel	80~120	PC315G	80 (60~90)	0.10~0.15	0.15~0.20	0.20~0.25
		High carbon steel	180~280	PC315G	70 (60~80)	0.10~0.15	0.15~0.20	0.20~0.25
	Alloy steel	Low alloy steel	140~260	PC215G	80 (60~90)	0.10~0.15	0.12~0.17	0.15~0.20
		Low carbon steel	50~260	PC215G	70 (60~80)	0.08~0.15	0.10~0.15	0.15~0.20
K	Cast iron	Gray cast iron	150~230	PC215G	80 (60~100)	0.10~0.20	0.15~0.20	0.15~0.20
		Ductile cast iron	160~260	PC215G	70 (60~80)	0.10~0.20	0.15~0.20	0.15~0.20
N	Aluminum	Aluminum alloy	30~150	FG2	120 (100~150)	0.12~0.17	0.15~0.20	0.20~0.25
	Copper alloy	Copper alloy	150~160	FG2	120 (100~150)	0.12~0.17	0.15~0.20	0.20~0.25

MLD-□□(P/K/N)

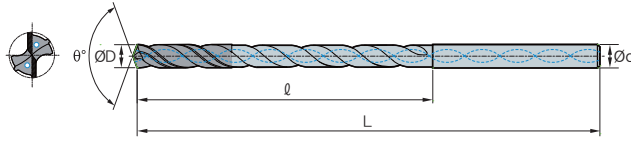

Terminology	P	K	N
Grade	PC215G PC315G		FG2
Tolerance (drill Dia.)	h7		
Tolerance (shank Dia.)	h6		
Point angle	135°		
Twist angle	30°		
Thinning	X type		
Coolant	Through		
	Steel	Cast iron	Non-ferrous metal

(mm)

Designation	ØD	Ød	10P,K,N		15P,K,N		20P,K,N		25P,K,N	
			ℓ	L	ℓ	L	ℓ	L	ℓ	L
MLD 0300N-□□P,K,N	3.0	3.0	40	90	55	105	70	120	-	-
0310N-□□P,K,N	3.1	4.0	45	100	60	125	80	140	-	-
0320N-□□P,K,N	3.2	4.0	45	100	60	125	80	140	-	-
0330N-□□P,K,N	3.3	4.0	45	100	60	125	80	140	-	-
0340N-□□P,K,N	3.4	4.0	50	100	65	125	85	140	-	-
0350N-□□P,K,N	3.5	4.0	50	100	65	125	85	140	-	-
0360N-□□P,K,N	3.6	4.0	50	100	65	125	85	140	-	-
0370N-□□P,K,N	3.7	4.0	50	100	65	125	85	140	-	-
0380N-□□P,K,N	3.8	4.0	50	100	75	125	90	140	-	-
0390N-□□P,K,N	3.9	4.0	50	100	75	125	90	140	-	-
0400N-□□P,K,N	4.0	4.0	50	100	75	125	90	140	115	165
0410N-□□P,K,N	4.1	5.0	55	115	75	140	100	165	120	190
0420N-□□P,K,N	4.2	5.0	55	115	75	140	100	165	120	190
0430N-□□P,K,N	4.3	5.0	60	115	85	140	110	165	135	190
0440N-□□P,K,N	4.4	5.0	60	115	85	140	110	165	135	190
0450N-□□P,K,N	4.5	5.0	60	115	85	140	110	165	135	190
0460N-□□P,K,N	4.6	5.0	60	115	85	140	110	165	135	190
0470N-□□P,K,N	4.7	5.0	60	115	85	140	110	165	135	190
0480N-□□P,K,N	4.8	5.0	65	115	90	140	115	165	140	190
0490N-□□P,K,N	4.9	5.0	65	115	90	140	115	165	140	190



MLD-□□(P/K/N)

Terminology	P	K	N
Grade	PC215G		FG2
Tolerance (drill Dia.)	h7		
Tolerance (shank Dia.)	h6		
Point angle	135°		
Twist angle	30°		
Thinning	X type		
Coolant	Through		
	Steel	Cast iron	Non-ferrous metal

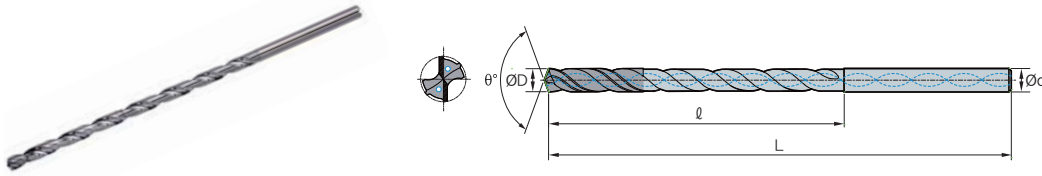

Designation		ØD	Ød	10P,K,N		15P,K,N		20P,K,N		25P,K,N	
				ℓ	L	ℓ	L	ℓ	L	ℓ	L
MLD	0500N-□□P,K,N	5.0	5.0	65	115	90	140	115	165	140	190
	0510N-□□P,K,N	5.1	6.0	70	128	95	160	120	190	150	220
	0520N-□□P,K,N	5.2	6.0	70	128	95	160	120	190	150	220
	0530N-□□P,K,N	5.3	6.0	70	128	95	160	120	190	150	220
	0540N-□□P,K,N	5.4	6.0	78	128	110	160	140	190	170	220
	0550N-□□P,K,N	5.5	6.0	78	128	110	160	140	190	170	220
	0560N-□□P,K,N	5.6	6.0	78	128	110	160	140	190	170	220
	0570N-□□P,K,N	5.7	6.0	78	128	110	160	140	190	170	220
	0580N-□□P,K,N	5.8	6.0	78	128	110	160	140	190	170	220
	0590N-□□P,K,N	5.9	6.0	78	128	110	160	140	190	170	220
	0600N-□□P,K,N	6.0	6.0	78	128	110	160	140	190	170	220
	0610N-□□P,K,N	6.1	7.0	87	140	120	175	155	210	190	250
	0620N-□□P,K,N	6.2	7.0	87	140	120	175	155	210	190	250
	0630N-□□P,K,N	6.3	7.0	87	140	120	175	155	210	190	250
	0640N-□□P,K,N	6.4	7.0	87	140	120	175	155	210	190	250
	0650N-□□P,K,N	6.5	7.0	87	140	120	175	155	210	190	250
	0660N-□□P,K,N	6.6	7.0	87	140	120	175	155	210	190	250
	0670N-□□P,K,N	6.7	7.0	87	140	120	175	155	210	190	250
	0680N-□□P,K,N	6.8	7.0	90	140	125	175	160	210	200	250
	0690N-□□P,K,N	6.9	7.0	90	140	125	175	160	210	200	250

MLD-□□(P/K/N)

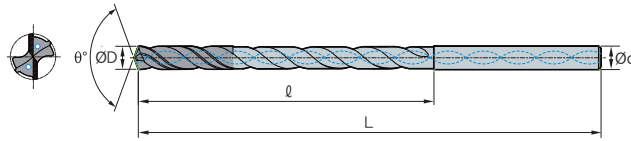

Terminology	P	K	N
Grade	PC215G	PC315G	FG2
Tolerance (drill Dia.)	h7		
Tolerance (shank Dia.)	h6		
Point angle	135°		
Twist angle	30°		
Thinning	X type		
Coolant	Through		
	Steel	Cast iron	Non-ferrous metal

(mm)

Designation	ØD	Ød	10P,K,N		15P,K,N		20P,K,N		25P,K,N	
			ℓ	L	ℓ	L	ℓ	L	ℓ	L
MLD 0700N-□□P,K,N	7.0	7.0	90	140	125	175	160	210	200	250
0710N-□□P,K,N	7.1	8.0	100	155	135	195	170	230	-	-
0720N-□□P,K,N	7.2	8.0	100	155	135	195	170	230	-	-
0730N-□□P,K,N	7.3	8.0	100	155	135	195	170	230	-	-
0740N-□□P,K,N	7.4	8.0	100	155	135	195	170	230	-	-
0750N-□□P,K,N	7.5	8.0	100	155	135	195	170	230	-	-
0760N-□□P,K,N	7.6	8.0	105	155	145	195	180	230	-	-
0770N-□□P,K,N	7.7	8.0	105	155	145	195	180	230	-	-
0780N-□□P,K,N	7.8	8.0	105	155	145	195	180	230	-	-
0790N-□□P,K,N	7.9	8.0	105	155	145	195	180	230	-	-
0800N-□□P,K,N	8.0	8.0	105	155	145	195	180	230	-	-
0810N-□□P,K,N	8.1	9.0	110	165	155	210	195	260	-	-
0820N-□□P,K,N	8.2	9.0	110	165	155	210	195	260	-	-
0830N-□□P,K,N	8.3	9.0	110	165	155	210	195	260	-	-
0840N-□□P,K,N	8.4	9.0	110	165	155	210	195	260	-	-
0850N-□□P,K,N	8.5	9.0	110	165	155	210	195	260	-	-
0860N-□□P,K,N	8.6	9.0	115	165	160	210	210	260	-	-
0870N-□□P,K,N	8.7	9.0	115	165	160	210	210	260	-	-
0880N-□□P,K,N	8.8	9.0	115	165	160	210	210	260	-	-
0890N-□□P,K,N	8.9	9.0	115	165	160	210	210	260	-	-
0900N-□□P,K,N	9.0	9.0	115	165	160	210	210	260	-	-
0910N-□□P,K,N	9.1	10.0	125	190	170	240	-	-	-	-
0920N-□□P,K,N	9.2	10.0	125	190	170	240	-	-	-	-
0930N-□□P,K,N	9.3	10.0	125	190	170	240	-	-	-	-
0940N-□□P,K,N	9.4	10.0	125	190	170	240	-	-	-	-
0950N-□□P,K,N	9.5	10.0	125	190	170	240	-	-	-	-
0960N-□□P,K,N	9.6	10.0	130	190	180	240	-	-	-	-
0970N-□□P,K,N	9.7	10.0	130	190	180	240	-	-	-	-
0980N-□□P,K,N	9.8	10.0	130	190	180	240	-	-	-	-
0990N-□□P,K,N	9.9	10.0	130	190	180	240	-	-	-	-
1000N-□□P,K,N	10.0	10.0	130	190	180	240	-	-	-	-



Code system for mach step drill

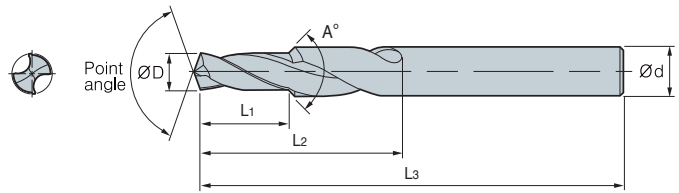
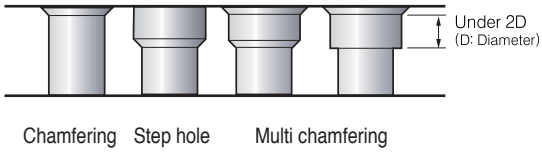
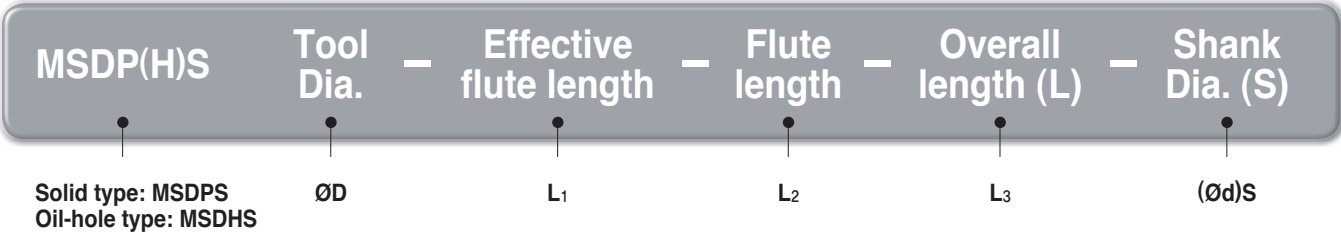

Multi chamfering
(Coolant: Through system External system

Multi chamfering
(Coolant: Through system External system

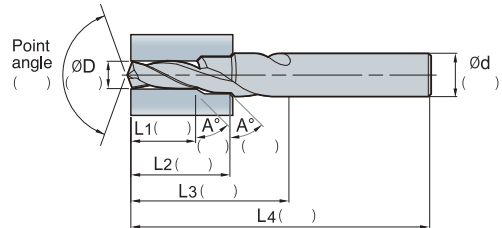
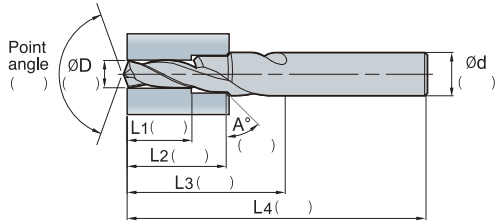

Step hole
(Coolant: Through system External system

Chamfering
(Coolant: Through system External system

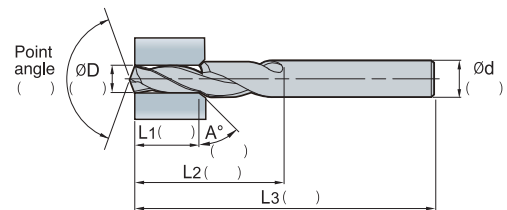
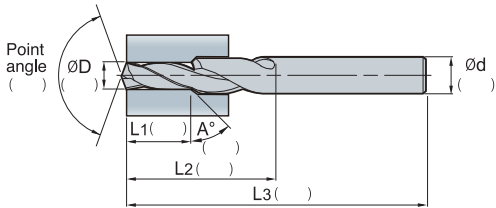

Drilling
(Coolant: Through system External system

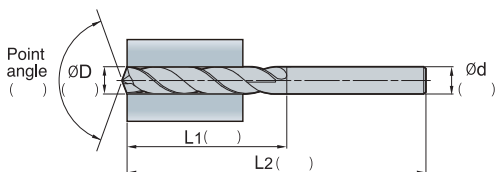

High feed and precision machining with our specially designed point edge

Vulcan Drill

- High feed and precision machining due to specially designed point edge
- Vulcan drills ensure longer tool life under high speed condition because of increased thermal & wear resistance. It also uses a PVD coating with an exclusive substrate to help maintain reduced frictional resistance
- Low cutting resistance by the best design of clearance angle is possible to increase feed
- Smoother chip control due to improved chip breakage
- Rmax: 6~25s, Hole tolerance: IT8 ~ 10
- Strong shock resistance ensures long tool life under the heavy interrupted machining

Code system

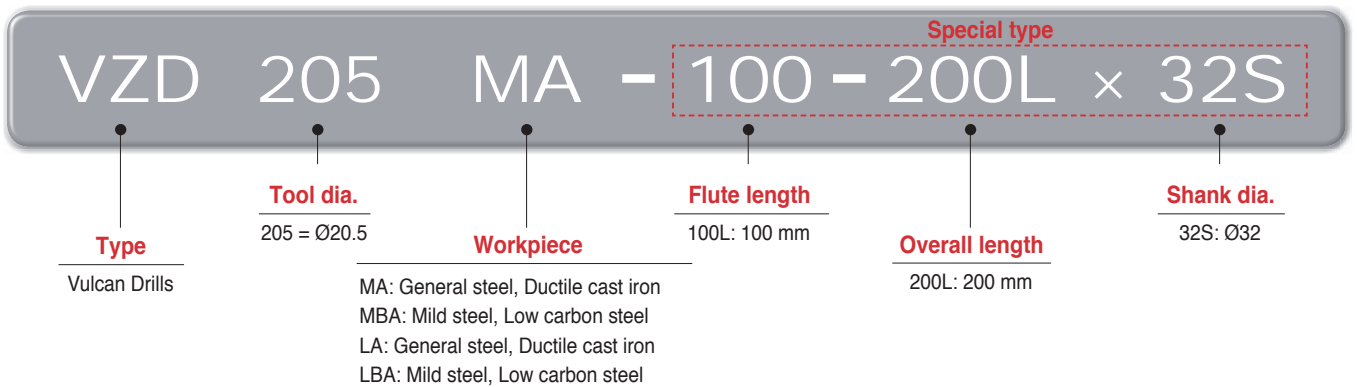

Application for vulcan drill

- General steel, Alloy steel, Mild steel, Dice steel, Stainless steel, Cast iron, Ductile cast iron, Non-ferrous metal, etc

Notice

- **Unsuitable drilling**
 - Avoid the inclination or unevenness of entering and piercing section of hole as possible
 - Reduce the feed 0.1~0.15 mm/rev when drilling at inclined and unevenness
- **Clamping of workpiece**
 - In case of wide flat panel or rotation by horizontal component, please clamp to be prevented bending of central part of workpiece for high efficiency

Recommended cutting condition

Form	Workpiece	Hardness	~Ø15		~Ø20		~Ø40	
			vc (m/min)	fn (mm/rev)	vc (m/min)	fn (mm/rev)	vc (m/min)	fn (mm/rev)
MA LA	Mild steel, General steel, Alloy steel	Under HB250	40~90 (65)	0.15~0.30 (0.20)	40~90 (65)	0.20~0.40 (0.30)	40~90 (70)	0.20~0.45 (0.35)
	General steel, Alloy steel	Under HB320	40~90 (60)	0.10~0.25 (0.20)	40~90 (60)	0.15~0.35 (0.25)	40~90 (65)	0.20~0.40 (0.30)
	Mold steel	HB250	40~70 (50)	0.10~0.25 (0.20)	40~70 (50)	0.15~0.30 (0.25)	40~70 (50)	0.20~0.35 (0.30)
	Stainless steel	HB250	30~50 (45)	0.10~0.20 (0.15)	30~50 (45)	0.15~0.25 (0.20)	30~50 (45)	0.20~0.30 (0.25)
	Ductile cast iron	-	50~100 (70)	0.20~0.35 (0.30)	50~100 (70)	0.20~0.40 (0.35)	50~100 (70)	0.25~0.50 (0.40)
MBA LBA	Mild steel, General steel, Alloy steel	Under HB250	40~90 (75)	0.20~0.40 (0.30)	40~90 (75)	0.20~0.40 (0.30)	40~90 (80)	0.20~0.45 (0.35)
	General steel, Alloy steel	Under HB320	35~80 (55)	0.15~0.30 (0.25)	35~80 (55)	0.15~0.30 (0.25)	40~80 (60)	0.15~0.40 (0.30)



Vulcan Drill (VZD-MA, MBA)

Type	MA	MBA
Grade	PC230F	
Tolerance (drill Dia.)	h7	
Tolerance (shank Dia.)	h7	
Point angle	140°	150°
Twist angle	25°	20°
Thinning	X type	
Coolant	Through	

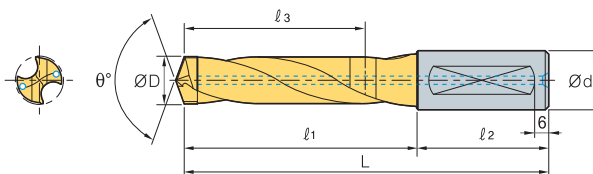

		(mm)					
Designation	ØD	Ød	L	l ₁	l ₂	l ₃	
VZD	126~135MA, MBA	12.6~13.5	16	110	62	48	44
	136~145MA, MBA	13.6~14.5	16	115	67	48	48
	146~155MA, MBA	14.6~15.5	20	125	75	50	55
	156~165MA, MBA	15.6~16.5	20	130	80	50	59
	166~175MA, MBA	16.6~17.5	20	135	85	50	63
	176~185MA, MBA	17.6~18.5	20	140	90	50	66
	186~195MA, MBA	18.6~19.5	25	155	99	56	74
	196~205MA, MBA	19.6~20.5	25	155	99	56	73
	206~215MA, MBA	20.6~21.5	25	155	99	56	72
	216~225MA, MBA	21.6~22.5	25	160	104	56	76
	226~235MA, MBA	22.6~23.5	25	160	104	56	74
	236~245MA, MBA	23.6~24.5	32	170	110	60	79
	246~255MA, MBA	24.6~25.5	32	170	110	60	78
	256~265MA, MBA	25.6~26.5	32	175	115	60	82
	266~275MA, MBA	26.6~27.5	32	175	115	60	80
	276~285MA, MBA	27.6~28.5	32	180	120	60	84
	286~295MA, MBA	28.6~29.5	32	185	125	60	88
	296~305MA, MBA	29.6~30.5	32	185	125	60	87
	306~315MA, MBA	30.6~31.5	40	205	135	70	95
	316~325MA, MBA	31.6~32.5	40	210	140	70	98
326~335MA, MBA	32.6~33.5	40	215	145	70	101	
336~345MA, MBA	33.6~34.5	40	220	150	70	104	
346~355MA, MBA	34.6~35.5	40	225	155	70	107	
356~365MA, MBA	35.6~36.5	40	225	155	70	110	
366~375MA, MBA	36.6~37.5	40	230	160	70	113	
376~385MA, MBA	37.6~38.5	40	235	165	70	116	
386~395MA, MBA	38.6~39.5	40	240	170	70	119	
396~405MA, MBA	39.6~40.5	40	245	175	70	122	

※ VZD□□□MA: For General steel, Ductile cast iron
 MBA: For Mild steel, Low carbon steel

※ Order made items: VZD□□□M□-Flute length-Total length L

Ex.1) MA Type, Machined diameter: Ø18.6 mm, Flute length: 110 mm, Total length: 200 mm
 --- VZD186MA x 110-200L

Ex.2) MA Type, Machined diameter: Ø18.63, Flute length: 110 mm, Total length: 200 mm
 --- VZD1863MA x 110-200L

Ex.3) MA Type, Machined diameter: Ø18.6, Standard
 --- VZD186MA

Vulcan Drill (VZD-LA, LBA)

Type	LA	LBA
Grade	PC230F	
Tolerance (drill Dia.)	h7	
Tolerance (shank Dia.)	h7	
Point angle	140°	150°
Twist angle	25°	20°
Thinning	X type	
Coolant	Through	

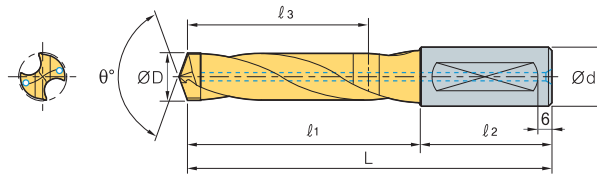

(mm)

Designation	ØD	Ød	L	l ₁	l ₂	l ₃
VZD 126~135LA, LBA	12.6~13.5	16	140	92	48	74
136~145LA, LBA	13.6~14.5	16	145	97	48	78
146~155LA, LBA	14.6~15.5	20	155	105	50	85
156~165LA, LBA	15.6~16.5	20	165	115	50	94
166~175LA, LBA	16.6~17.5	20	170	120	50	98
176~185LA, LBA	17.6~18.5	20	175	125	50	101
186~195LA, LBA	18.6~19.5	25	190	134	56	109
196~205LA, LBA	19.6~20.5	25	195	139	56	113
206~215LA, LBA	20.6~21.5	25	195	139	56	112
216~225LA, LBA	21.6~22.5	25	200	144	56	116
226~235LA, LBA	22.6~23.5	25	210	154	56	124
236~245LA, LBA	23.6~24.5	32	220	160	60	129
246~255LA, LBA	24.6~25.5	32	225	165	60	133
256~265LA, LBA	25.6~26.5	32	230	170	60	137
266~275LA, LBA	26.6~27.5	32	235	175	60	141
276~285LA, LBA	27.6~28.5	32	240	180	60	144
286~295LA, LBA	28.6~29.5	32	245	185	60	148
296~305LA, LBA	29.6~30.5	32	255	195	60	157
306~315LA, LBA	30.6~31.5	40	275	205	70	166
316~325LA, LBA	31.6~32.5	40	280	210	70	172
326~335LA, LBA	32.6~33.5	40	280	215	70	173
336~345LA, LBA	33.6~34.5	40	290	220	70	177
346~355LA, LBA	34.6~35.5	40	295	225	70	181
356~365LA, LBA	35.6~36.5	40	300	230	70	183
366~375LA, LBA	36.6~37.5	40	305	235	70	188
376~385LA, LBA	37.6~38.5	40	315	245	70	193
386~395LA, LBA	38.6~39.5	40	320	250	70	198
396~405LA, LBA	39.6~40.5	40	325	255	70	203

※ VZD□□□LA: For General steel, Ductile cast iron
 LBA: For Mild steel, Low carbon steel

※ Order made items: VZD□□□L□-Flute length-Total length L

Ex.1) LA Type, Machined diameter: Ø18.6 mm, Flute length: 110 mm, Total length: 200 mm
 --- VZD186LA x 110-200L

Ex.2) LA Type, Machined diameter: Ø18.63, Flute length: 110 mm, Total length: 200 mm
 --- VZD1863LA x 110-200L

Ex.3) LA Type, Machined diameter: Ø18.6, Standard
 --- VZD186LA



Economical Solid Drill

ESD Plus **new**

Eco Solid Drill Plus

- Great Value for Budget - Excellent performance and cost efficiency
- Increased Wear Resistance - Strong wear resistance due to our new PC325U grade

Code system

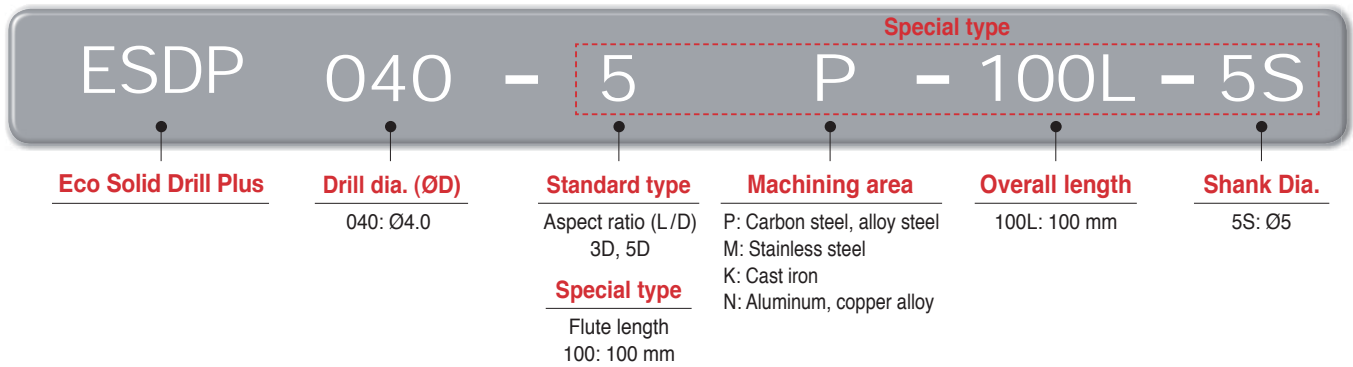

Features

New grade (PC325U)

- Lubricative coating layer improves welding resistance at middle to high speed
- Increase wear resistance in machining carbon steel

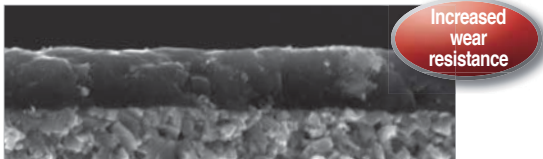

PC325U

Surface of coating layer

- Excellent welding resistance and lower cutting load
- Reduced frictional resistance at cutting edges and on the flute



Smooth coating surface
PC325U

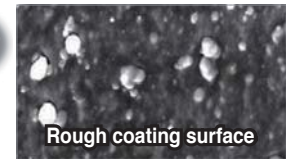

Rough coating surface
Competitor

Chip control

- **Workpiece** SCM440
- **Cutting conditions** vc (m/min) = 40
fn (mm/rev) = 0.1, ap (mm) = 30, wet
- **Tools** ESDP060-5P

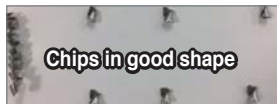

Chips in good shape
ESD Plus



Competitor

Flute shape

- Improved chip evacuation due to wider chip pocket



Application area

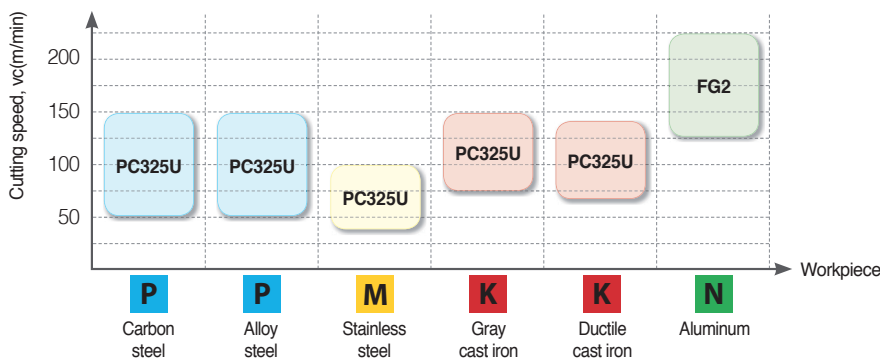

Performance evaluation

- **Workpiece** Alloy steel (SCM440)
- **Cutting conditions** vc (m/min) = 95
fn (mm/rev) = 0.12, ap (mm) = 20, External coolant
- **Tools** ESDP060-5P



ESD Plus

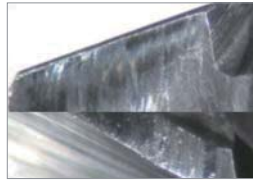

Competitor

Test result

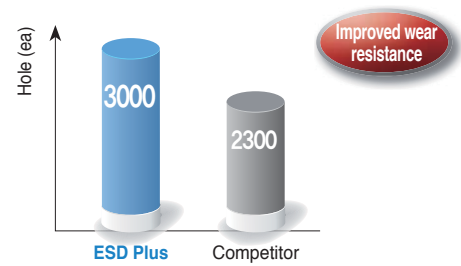

Lubricative coating layer of the new grade PC325U maximizes wear resistance

Application examples

- **Workpiece** Carbon steel (SM45C)
- **Cutting conditions** vc (m/min) = 50
fn (mm/rev) = 0.08, ap (mm) = 23.5, External coolant
- **Tools** ESDP090-5P



Test result

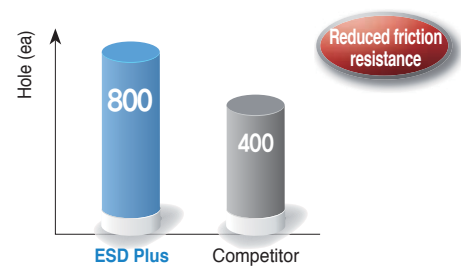

Special treatment on coating surface minimizes frictional resistance

Recommended cutting condition

Workpiece			Grade	vc (m/min)	Feed					
ISO	Workpiece	HB			Feed rate (mm/rev) per drill dia. (mm)					
					Ø2.5~Ø4.0	Ø4.1~Ø8.0	Ø8.1~Ø12.0	Ø12.1~Ø16.0	Ø16.1~Ø20.0	
P	Carbon steel	Low carbon steel	80~120	PC325U	72(64~120)	0.08~0.12	0.13~0.19	0.16~0.24	0.20~0.29	0.24~0.32
		High carbon steel	Over 250	PC325U	40(32~64)	0.06~0.16	0.06~0.16	0.08~0.20	0.12~0.20	0.12~0.24
	Alloy steel	Low alloy steel	140~260	PC325U	72(64~120)	0.08~0.12	0.13~0.19	0.16~0.24	0.20~0.29	0.24~0.32
		Hardened low alloy steel	200~400	PC325U	48(40~80)	0.08~0.12	0.13~0.19	0.16~0.24	0.20~0.29	0.24~0.32
		High alloy steel	50~260	PC325U	40(32~64)	0.06~0.16	0.06~0.16	0.08~0.20	0.12~0.20	0.12~0.24
		Hardened high alloy steel	Over 250	PC325U	40(32~64)	0.06~0.16	0.06~0.16	0.08~0.20	0.12~0.20	0.12~0.24
M	Stainless steel	Austenite series	135~275	PC325U	36(20~64)	0.04~0.16	0.04~0.16	0.08~0.20	0.08~0.20	0.12~0.24
		Ferrite series Martensite series	135~275	PC325U	40(24~64)	0.04~0.16	0.04~0.16	0.08~0.20	0.08~0.20	0.12~0.24
K	Cast iron	Gray cast iron	150~230	PC325U	80(64~120)	0.08~0.12	0.13~0.19	0.16~0.24	0.20~0.29	0.24~0.32
		Ductile cast iron	160~260	PC325U	72(56~112)	0.08~0.12	0.13~0.19	0.16~0.24	0.20~0.29	0.24~0.32
N	Aluminum	Aluminum alloy	30~150	FG2	120(100~176)	0.19~0.30	0.30~0.42	0.42~0.60	0.49~0.68	0.54~0.78
	Copper alloy	Copper alloy	150~160	FG2	120(100~176)	0.08~0.12	0.13~0.19	0.16~0.24	0.20~0.29	0.24~0.32

* Cutting conditions above are for the case of less than 5D depth of cut and external coolant system applied



ESDP-□P

Specification	P	M	K	N
Grade	PC325U			FG2
Tolerance(drill Dia.)	h7			
Tolerance(shank Dia.)	h6			
Point angle	140°		135°	
Twist angle	30°			
Thinning	X type			
Coolant	External system			

■ Steel
 ■ Stainless steel
 ■ Cast iron
 ■ Non-ferrous metal

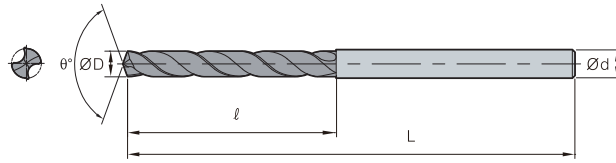

Designation	ØD	Ød	3P		5P		7P	
			ℓ	L	ℓ	L	ℓ	L
ESDP 010 - □ P	1.0	3	5	45	8	45	12	60
011 - □ P	1.1	3	6	45	9	45	12	60
012 - □ P	1.2	3	6	45	10	45	12	60
013 - □ P	1.3	3	7	45	10	45	15	60
014 - □ P	1.4	3	7	45	11	45	15	60
015 - □ P	1.5	3	7	45	11	45	15	60
016 - □ P	1.6	3	8	45	12	45	20	60
017 - □ P	1.7	3	8	45	12	45	20	60
018 - □ P	1.8	3	9	45	13	45	20	60
019 - □ P	1.9	3	9	45	14	45	20	60
020 - □ P	2.0	3	10	50	18	50	25	66
021 - □ P	2.1	3	10	50	18	50	25	66
022 - □ P	2.2	3	12	50	18	50	25	66
023 - □ P	2.3	3	12	50	18	50	25	66
024 - □ P	2.4	3	12	50	18	50	30	66
025 - □ P	2.5	3	12	50	18	50	30	66
026 - □ P	2.6	3	12	50	18	50	30	66
027 - □ P	2.7	3	15	50	18	50	30	66
028 - □ P	2.8	3	15	50	18	50	30	66
029 - □ P	2.9	3	15	50	18	50	30	66
030 - □ P	3.0	3	16	55	20	55	45	80
031 - □ P	3.1	4	16	55	20	55	45	80
032 - □ P	3.2	4	16	55	20	55	45	80
033 - □ P	3.3	4	16	55	20	55	45	80
034 - □ P	3.4	4	16	55	20	55	45	80
035 - □ P	3.5	4	16	55	20	55	45	80
036 - □ P	3.6	4	18	55	25	55	45	80
037 - □ P	3.7	4	18	55	25	55	45	80
038 - □ P	3.8	4	20	55	25	55	45	80
039 - □ P	3.9	4	20	55	25	55	45	80
040 - □ P	4.0	4	20	55	25	55	45	80
041 - □ P	4.1	5	20	55	25	55	45	80
042 - □ P	4.2	5	20	63	33	63	45	80
043 - □ P	4.3	5	23	63	33	63	45	80
044 - □ P	4.4	5	23	63	33	63	45	80
045 - □ P	4.5	5	23	63	33	63	45	80
046 - □ P	4.6	5	23	63	33	63	45	80
047 - □ P	4.7	5	23	63	33	63	45	80
048 - □ P	4.8	5	25	63	33	63	45	80
049 - □ P	4.9	5	25	63	33	63	45	80
050 - □ P	5.0	5	25	63	33	63	45	80

※ Pre-orders can be made in advance for non-stock items

ESDP-□P

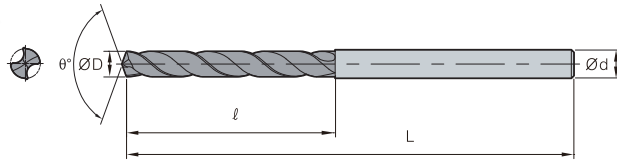

Specification	P	M	K	N
Grade	PC325U			FG2
Tolerance(drill Dia.)	h7			
Tolerance(shank Dia.)	h6			
Point angle	140°	135°		
Twist angle	30°			
Thinning	X type			
Coolant	External system			

■ Steel
 ■ Stainless steel
 ■ Cast iron
 ■ Non-ferrous metal

(mm)

Designation	ØD	Ød	3P		5P		7P	
			ℓ	L	ℓ	L	ℓ	L
ESDP 051 - □ P	5.1	6	25	63	33	63	45	80
052 - □ P	5.2	6	28	66	36	66	50	83
053 - □ P	5.3	6	28	66	36	66	50	83
054 - □ P	5.4	6	28	66	36	66	50	83
055 - □ P	5.5	6	28	66	36	66	50	83
056 - □ P	5.6	6	28	66	36	66	50	83
057 - □ P	5.7	6	28	66	36	66	50	83
058 - □ P	5.8	6	28	66	36	66	50	83
059 - □ P	5.9	6	28	66	36	66	50	83
060 - □ P	6.0	6	30	66	36	66	50	83
061 - □ P	6.1	7	30	66	36	66	50	83
062 - □ P	6.2	7	32	75	42	75	53	85
063 - □ P	6.3	7	32	75	42	75	53	85
064 - □ P	6.4	7	32	75	42	75	53	85
065 - □ P	6.5	7	32	75	42	75	53	85
066 - □ P	6.6	7	32	75	42	75	53	85
067 - □ P	6.7	7	32	75	42	75	53	85
068 - □ P	6.8	7	32	75	42	75	53	85
069 - □ P	6.9	7	32	75	42	75	53	85
070 - □ P	7.0	7	32	75	42	75	53	85
071 - □ P	7.1	8	32	75	42	75	53	85
072 - □ P	7.2	8	36	80	46	80	58	90
073 - □ P	7.3	8	36	80	46	80	58	90
074 - □ P	7.4	8	36	80	46	80	58	90
075 - □ P	7.5	8	36	80	46	80	58	90
076 - □ P	7.6	8	36	80	46	80	58	90
077 - □ P	7.7	8	36	80	46	80	58	90
078 - □ P	7.8	8	36	80	46	80	58	90
079 - □ P	7.9	8	36	80	46	80	58	90
080 - □ P	8.0	8	36	80	46	80	58	90
081 - □ P	8.1	9	36	80	46	80	58	90
082 - □ P	8.2	9	38	85	50	85	64	98
083 - □ P	8.3	9	38	85	50	85	64	98
084 - □ P	8.4	9	38	85	50	85	64	98
085 - □ P	8.5	9	38	85	50	85	64	98
086 - □ P	8.6	9	40	85	50	85	64	98
087 - □ P	8.7	9	40	85	50	85	64	98
088 - □ P	8.8	9	40	85	50	85	64	98
089 - □ P	8.9	9	40	85	50	85	64	98
090 - □ P	9.0	9	40	85	50	85	64	98



ESDP-□P

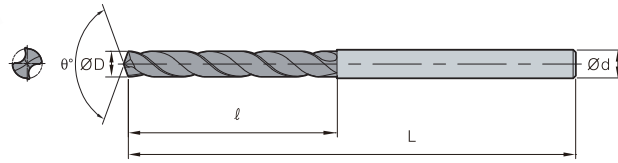

Specification	P	M	K	N
Grade	PC325U		FG2	
Tolerance(drill Dia.)	h7			
Tolerance(shank Dia.)	h6			
Point angle	140°		135°	
Twist angle	30°			
Thinning	X type			
Coolant	External system			

Steel M Stainless steel Cast iron Non-ferrous metal

(mm)

Designation	ØD	Ød	3P		5P		7P	
			ℓ	L	ℓ	L	ℓ	L
ESDP 091 - □ P	9.1	10	42	85	50	85	64	98
092 - □ P	9.2	10	42	90	55	90	68	105
093 - □ P	9.3	10	42	90	55	90	68	105
094 - □ P	9.4	10	42	90	55	90	68	105
095 - □ P	9.5	10	42	90	55	90	68	105
096 - □ P	9.6	10	45	90	55	90	68	105
097 - □ P	9.7	10	45	90	55	90	68	105
098 - □ P	9.8	10	45	90	55	90	68	105
099 - □ P	9.9	10	45	90	55	90	68	105
100 - □ P	10.0	10	45	90	55	90	68	105
101 - □ P	10.1	11	-	-	55	90	68	105
102 - □ P	10.2	11	-	-	57	95	73	110
103 - □ P	10.3	11	-	-	57	95	73	110
104 - □ P	10.4	11	-	-	57	95	73	110
105 - □ P	10.5	11	-	-	57	95	73	110
106 - □ P	10.6	11	-	-	57	95	73	110
107 - □ P	10.7	11	-	-	57	95	73	110
108 - □ P	10.8	11	-	-	57	95	73	110
109 - □ P	10.9	11	-	-	57	95	73	110
110 - □ P	11.0	11	-	-	57	95	73	110
111 - □ P	11.1	12	-	-	57	95	73	110
112 - □ P	11.2	12	-	-	63	102	80	120
113 - □ P	11.3	12	-	-	63	102	80	120
114 - □ P	11.4	12	-	-	63	102	80	120
115 - □ P	11.5	12	-	-	63	102	80	120
116 - □ P	11.6	12	-	-	63	102	80	120
117 - □ P	11.7	12	-	-	63	102	80	120
118 - □ P	11.8	12	-	-	63	102	80	120
119 - □ P	11.9	12	-	-	63	102	80	120
120 - □ P	12.0	12	-	-	63	102	80	120
121 - □ P	12.1	13	-	-	63	102	80	120
122 - □ P	12.2	13	-	-	63	102	90	137
123 - □ P	12.3	13	-	-	63	102	90	137
124 - □ P	12.4	13	-	-	63	102	90	137
125 - □ P	12.5	13	-	-	63	102	90	137
126 - □ P	12.6	13	-	-	63	102	90	137
127 - □ P	12.7	13	-	-	63	102	90	137
128 - □ P	12.8	13	-	-	63	102	90	137
129 - □ P	12.9	13	-	-	63	102	90	137
130 - □ P	13.0	13	-	-	63	102	90	137

ESDP-□P

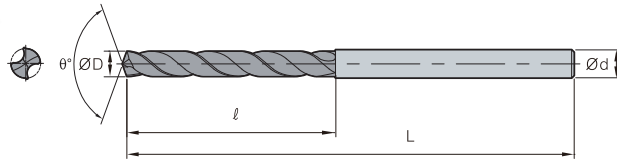

Specification	P	M	K	N
Grade	PC325U			FG2
Tolerance(drill Dia.)	h7			
Tolerance(shank Dia.)	h6			
Point angle	140°	135°		
Twist angle	30°			
Thinning	X type			
Coolant	External system			

■ Steel
 ■ Stainless steel
 ■ Cast iron
 ■ Non-ferrous metal

(mm)

Designation	ØD	Ød	5P		7P	
			ℓ	L	ℓ	L
ESDP 131 - □ P	13.1	14	63	102	90	137
132 - □ P	13.2	14	65	107	96	147
133 - □ P	13.3	14	65	107	96	147
134 - □ P	13.4	14	65	107	96	147
135 - □ P	13.5	14	65	107	96	147
136 - □ P	13.6	14	65	107	96	147
137 - □ P	13.7	14	65	107	96	147
138 - □ P	13.8	14	65	107	96	147
139 - □ P	13.9	14	65	107	96	147
140 - □ P	14.0	14	65	107	96	147
141 - □ P	14.1	15	65	107	96	147
142 - □ P	14.2	15	68	115	100	153
143 - □ P	14.3	15	68	115	100	153
144 - □ P	14.4	15	68	115	100	153
145 - □ P	14.5	15	68	115	100	153
146 - □ P	14.6	15	68	115	100	153
147 - □ P	14.7	15	68	115	100	153
148 - □ P	14.8	15	68	115	100	153
149 - □ P	14.9	15	68	115	100	153
150 - □ P	15.0	15	68	115	100	153
151 - □ P	15.1	16	68	115	100	153
152 - □ P	15.2	16	70	120	112	160
153 - □ P	15.3	16	70	120	112	160
154 - □ P	15.4	16	70	120	112	160
155 - □ P	15.5	16	70	120	112	160
156 - □ P	15.6	16	70	120	112	160
157 - □ P	15.7	16	70	120	112	160
158 - □ P	15.8	16	70	120	112	160
159 - □ P	15.9	16	70	120	112	160
160 - □ P	16.0	16	70	120	112	160
161 - □ P	16.1	17	70	120	112	160
162 - □ P	16.2	17	70	120	112	160
163 - □ P	16.3	17	70	120	112	160
164 - □ P	16.4	17	70	120	112	160
165 - □ P	16.5	17	72	125	112	160
166 - □ P	16.6	17	72	125	112	160
167 - □ P	16.7	17	72	125	112	160
168 - □ P	16.8	17	72	125	112	160
169 - □ P	16.9	17	72	125	112	160
170 - □ P	17.0	17	72	125	112	160



ESDP-□P

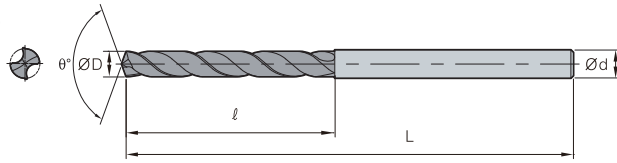

Specification	P	M	K	N
Grade	PC325U		FG2	
Tolerance(drill Dia.)	h7			
Tolerance(shank Dia.)	h6			
Point angle	140°		135°	
Twist angle	30°			
Thinning	X type			
Coolant	External system			

■ Steel
 ■ Stainless steel
 ■ Cast iron
 ■ Non-ferrous metal

(mm)

Designation	ØD	Ød	5P		7P	
			ℓ	L	ℓ	L
ESDP 171 - □ P	17.1	18	72	125	112	160
172 - □ P	17.2	18	72	125	112	160
173 - □ P	17.3	18	72	125	112	160
174 - □ P	17.4	18	72	125	112	160
175 - □ P	17.5	18	75	130	112	160
176 - □ P	17.6	18	75	130	112	160
177 - □ P	17.7	18	75	130	112	160
178 - □ P	17.8	18	75	130	112	160
179 - □ P	17.9	18	75	130	112	160
180 - □ P	18.0	18	75	130	112	160
181 - □ P	18.1	19	75	130	112	160
182 - □ P	18.2	19	75	130	112	160
183 - □ P	18.3	19	75	130	112	160
184 - □ P	18.4	19	75	130	112	160
185 - □ P	18.5	19	78	130	112	160
186 - □ P	18.6	19	78	130	112	160
187 - □ P	18.7	19	78	130	112	160
188 - □ P	18.8	19	78	130	112	160
189 - □ P	18.9	19	78	130	112	160
190 - □ P	19.0	19	78	130	112	160
191 - □ P	19.1	20	78	130	112	160
192 - □ P	19.2	20	78	130	112	160
193 - □ P	19.3	20	78	130	112	160
194 - □ P	19.4	20	78	130	112	160
195 - □ P	19.5	20	82	135	112	160
196 - □ P	19.6	20	82	135	112	160
197 - □ P	19.7	20	82	135	112	160
198 - □ P	19.8	20	82	135	112	160
199 - □ P	19.9	20	82	135	112	160
200 - □ P	20.0	20	82	135	112	160

G Technical Information for Carbide Drill (SSDP)

High quality solid drill for high performance

SSD Plus new

- Improved chip control thanks to the new flute design
- Higher quality machining achieved from improved surface finish and forming
- Increased productivity thanks to stable tool life
- A variety of workpiece materials available including mild steel and non-ferrous

Code system

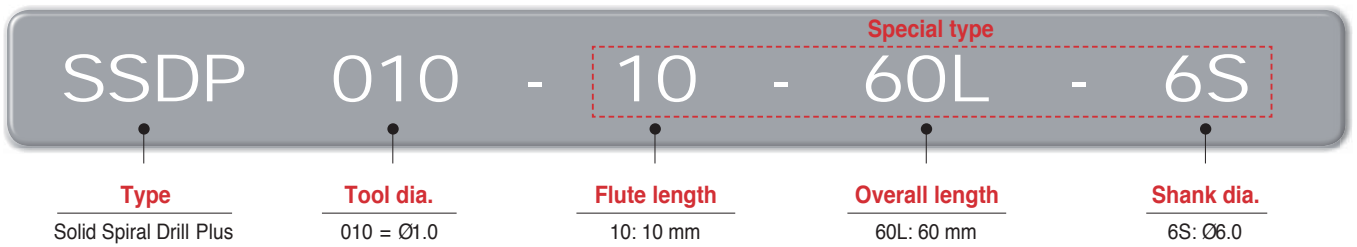

Features

Division	Shape	Application area
SSD Plus (SSDP)		P, N
existing SSD		N

Application area

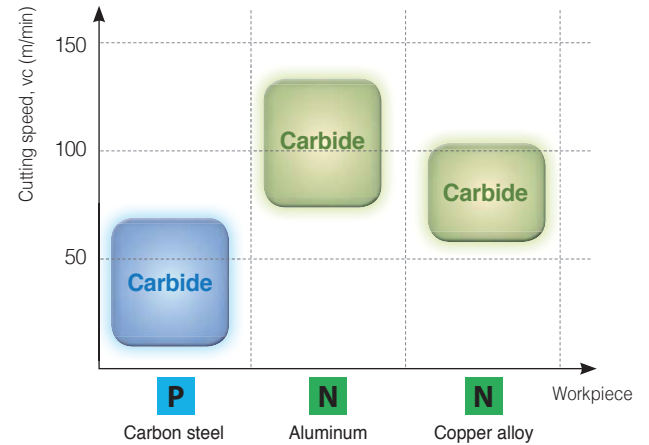

Recommended cutting condition

Workpiece				Grade	Cutting speed vc (m/min)	Feed rate (mm/rev) per drill dia. (mm)			
ISO	Workpiece	HB	Ø2.5~Ø4.0			Ø4.1~Ø8.0	Ø8.1~Ø12.0	Ø12.1~Ø15.0	
P	Carbon steel	Low carbon steel	80~120	Carbide	35 (20~65)	0.02~0.06	0.04~0.08	0.06~0.12	0.10~0.16
N	Aluminum	Aluminum alloy	30~150		100 (94~120)	0.03~0.06	0.05~0.08	0.08~0.12	0.12~0.18
	Copper alloy	Copper alloy	150~160		80 (65~95)	0.03~0.06	0.05~0.08	0.08~0.12	0.12~0.18



SSDP

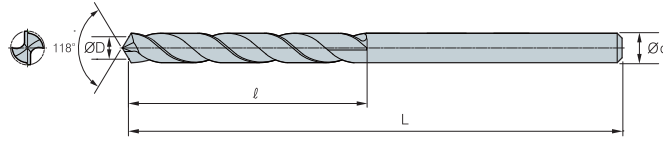

Coating	x
Tolerance (drill Dia.)	h7
Tolerance (shank Dia.)	h7
Point angle	118°
Twist angle	30°
Thinning	X type
Coolant	External

				(mm)					
Designation		ØD = Ød	l	L	Designation		ØD = Ød	l	L
SSDP	010	1.0	10	32	SSDP	048	4.8	38	65
	011	1.1	10	32		049	4.9	38	65
	012	1.2	10	32		050	5.0	38	65
	013	1.3	10	32		051	5.1	38	65
	014	1.4	10	32		052	5.2	38	65
	015	1.5	13	35		053	5.3	38	65
	016	1.6	13	35		054	5.4	38	65
	017	1.7	13	35		055	5.5	38	65
	018	1.8	13	35		056	5.6	40	75
	019	1.9	13	35		057	5.7	40	75
	020	2.0	18	40		058	5.8	40	75
	021	2.1	18	40		059	5.9	40	75
	022	2.2	18	40		060	6.0	40	75
	023	2.3	18	40		061	6.1	40	75
	024	2.4	18	40		062	6.2	40	75
	025	2.5	22	45		063	6.3	40	75
	026	2.6	22	45		064	6.4	40	75
	027	2.7	22	45		065	6.5	40	75
	028	2.8	22	45		066	6.6	46	80
	029	2.9	22	45		067	6.7	46	80
	030	3.0	25	50		068	6.8	46	80
	031	3.1	25	50		069	6.9	46	80
	032	3.2	25	50		070	7.0	46	80
	033	3.3	28	50		071	7.1	46	80
	034	3.4	28	50		072	7.2	46	80
	035	3.5	28	50		073	7.3	46	80
	036	3.6	30	55		074	7.4	46	80
	037	3.7	30	55		075	7.5	46	80
	038	3.8	30	55		076	7.6	50	85
	039	3.9	30	55		077	7.7	50	85
040	4.0	30	55	078	7.8	50	85		
041	4.1	34	60	079	7.9	50	85		
042	4.2	34	60	080	8.0	50	85		
043	4.3	34	60	081	8.1	50	85		
044	4.4	34	60	082	8.2	50	85		
045	4.5	34	60	083	8.3	50	85		
046	4.6	38	65	084	8.4	50	85		
047	4.7	38	65	085	8.5	50	85		

SSDP

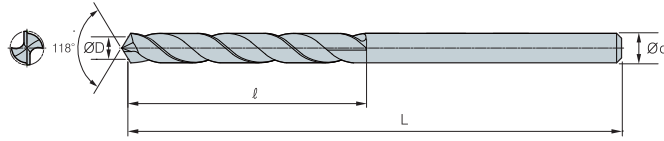

Coating	x
Tolerance (drill Dia.)	h7
Tolerance (shank Dia.)	h6
Point angle	118°
Twist angle	30°
Thinning	X type
Coolant	External

(mm)

Designation	ØD = Ød	ℓ	L	Designation	ØD = Ød	ℓ	L
SSDP 086	8.6	50	95	SSDP 097	9.7	50	100
087	8.7	50	95	098	9.8	50	100
088	8.8	50	95	099	9.9	50	100
089	8.9	50	95	100	10.0	50	100
090	9.0	50	95	105	10.5	60	115
091	9.1	50	95	110	11.0	60	115
092	9.2	50	95	115	11.5	65	120
093	9.3	50	95	120	12.0	65	120
094	9.4	50	95	125	12.5	65	125
095	9.5	50	95	130	13.0	65	125
096	9.6	50	100	150	15.0	70	130



Burnishing Drill

Recommended cutting condition

Workpiece	Cutting speed vc (m/min)	Feed rate (mm/rev) per drill dia. (mm)				
		Ø2.0~Ø3.0	Ø3.5~Ø5.0	Ø5.5~Ø8.0	Ø8.5~Ø12	Ø12.5~Ø18
Aluminum alloy, Copper alloy	30~60	0.02~0.05	0.03~0.10	0.04~0.15	0.05~0.20	0.05~0.30
Aluminum alloy for die castings	50~80	0.02~0.05	0.03~0.10	0.04~0.15	0.05~0.20	0.05~0.30
Cast iron (GC) Ductile cast	25~60	0.01~0.04	0.02~0.08	0.05~0.12	0.05~0.20	0.05~0.30
Iron (GCD)	20~50	0.01~0.03	0.02~0.05	0.03~0.08	0.04~0.12	0.05~0.15

Burnishing Drill-BDS

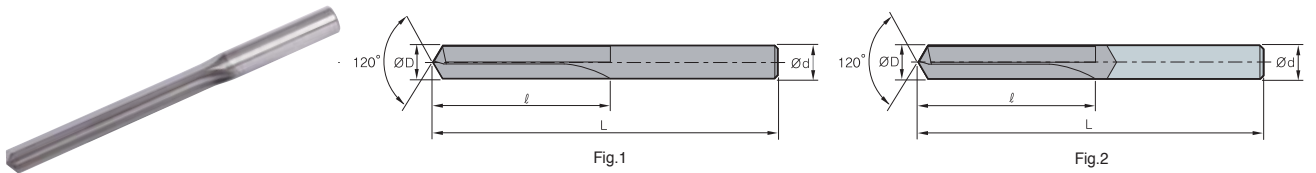

Designation	ØD	Ød	ℓ	L	Fig.
BDS	040S	4.0	35	80	1
	050S	5.0	40	85	1
	060S	6.0	50	95	1
	070S	7.0	55	100	1
	080S	8.0	65	110	1
	090S	9.0	70	120	1
	100S	10.0	80	130	1
	110S	11.0	90	140	1
	120B	12.0	95	150	2
	130B	13.0	105	160	2
	140B	14.0	110	170	2
	150B	15.0	120	185	2
	160B	16.0	125	190	2

Step Burnishing Drill-BDT

For tapping a foundation hole

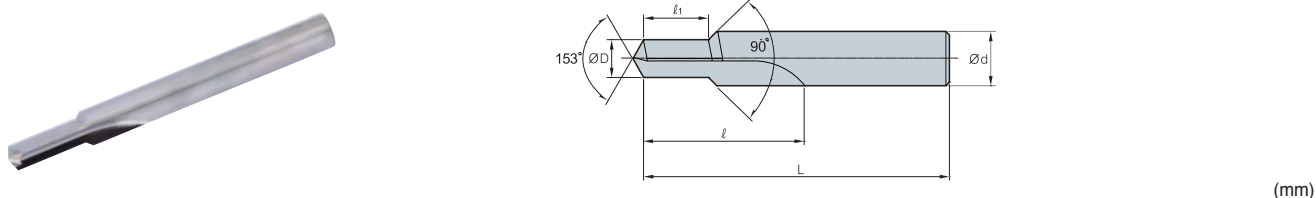

Designation	ØD	Ød	ℓ	ℓ₁	L	Tap
BDT	M05080-ℓ 1	4.2	35	9~15	90	M5XP0.8
	M06100-ℓ 1	5.0	40	11~18	95	M6XP1.0
	M08125-ℓ 1	6.8	50	15~24	105	M8XP1.25
	M10125-ℓ 1	8.8	55	17~30	110	M10XP1.25
	M10150-ℓ 1	8.5	55	17~30	110	M10XP1.5
	M12125-ℓ 1	10.8	60	19~36	120	M12XP1.25
	M12150-ℓ 1	10.5	60	19~36	120	M12XP1.5
	M12175-ℓ 1	10.3	60	19~36	120	M12XP1.75

Top Solid Drill

Recommended cutting condition

Diameter	Cutting condition	Ductile cast iron	Gray cast iron	Soft steel
Ø8~Ø10	vc (m/min)	30 (20~35)	40 (20~60)	100 (50~150)
	fn (mm/rev)	0.30 (0.20~0.40)	0.30 (0.20~0.40)	0.15 (0.10~0.20)
Ø10.1~Ø15	vc (m/min)	50 (30~70)	60 (30~80)	130 (70~200)
	fn (mm/rev)	0.35 (0.30~0.40)	0.35 (0.30~0.40)	0.15 (0.10~0.20)
Ø15.1~Ø25	vc (m/min)	60 (50~60)	75 (50~100)	150 (100~250)
	fn (mm/rev)	0.35 (0.30~0.45)	0.40 (0.30~0.50)	0.15 (0.10~0.20)

Top Solid Drill-TSDM

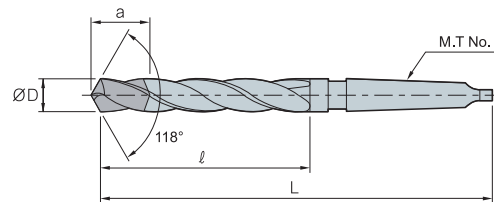

Designation		ØD	L	ℓ	a	M.T No
TSDM	080~085	8.0~8.5	168	85	25	1
	086~090	8.6~9.0	172	88	25	1
	091~095	9.1~9.5	175	92	26	1
	096~100	9.6~10.0	178	95	26	1
	101~105	10.1~10.5	182	98	26	1
	106~110	10.6~11.0	185	102	26	1
	111~115	11.1~11.5	188	105	26	1
	116~120	11.6~12.0	192	108	26	1
	121~125	12.1~12.5	195	112	26	1
	126~130	12.6~13.0	198	115	26	2
	131~135	13.1~13.5	202	118	27	2
	136~140	13.6~14.0	205	122	27	2
	141~145	14.1~14.5	222	122	27	2
	146~150	14.6~15.0	225	125	27	2
	151~155	15.1~15.5	228	125	27	2
	156~160	15.6~16.0	230	130	27	2
	161~165	16.1~16.5	232	132	27	2
	166~170	16.6~17.0	234	135	27	2
	171~180	17.1~18.0	240	140	27	2
	181~190	18.1~19.0	245	145	27	2
191~200	19.1~20.0	250	150	30	2	
201~210	20.1~21.0	255	155	30	2	
211~220	21.1~22.0	260	160	30	2	
221~230	22.1~23.0	265	165	30	2	
231~250	23.1~25.0	285	165	34	3	

※ Order form : TSDM125



High accuracy hole machining for aluminum alloy

PCD Drill

- High accuracy hole machining for aluminum alloy
- Drilling tolerance: IT7~8 class
- Recommendation with high accuracy and high spindle machine

Code system



Recommended cutting condition

Workpiece	vc (m/min)	fn (mm/rev)
Aluminum alloy	50~250	0.05~0.20 0.10~0.40

PDD

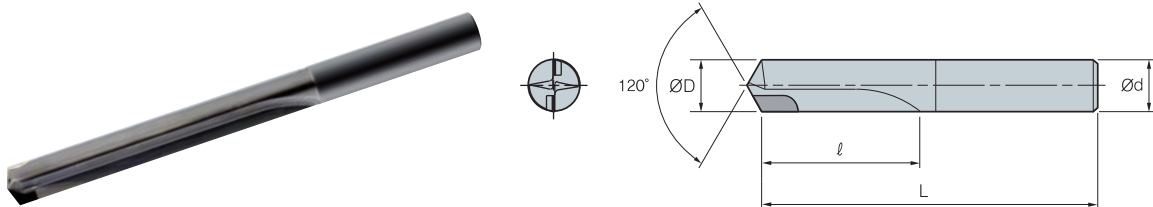

Designation		ØD	Ød	ℓ	L
PDD	0500	5.0	5.0	30	80
	0550	5.5	5.5	30	80
	0600	6.0	6.0	30	80
	0650	6.5	6.5	40	95
	0700	7.0	7.0	40	95
	0750	7.5	7.5	45	100
	0800	8.0	8.0	45	100
	0850	8.5	8.5	50	110
	0900	9.0	9.0	50	110
	0950	9.5	9.5	55	115
	1000	10.0	10.0	55	115
	1050	10.5	10.5	60	120
	1100	11.0	11.0	60	120
	1150	11.5	11.5	65	125
	1200	12.0	12.0	65	125

G Technical Information for Gun Drill

Stable performance and hole quality with our unique cutting edge and guide pad available regrinding

Gun Drill

- High efficiency in deep hole machining
- High accuracy (Hole tolerance: IT9, surface finish: Ra0.1~3.0S)
- Stable Quality due to unique cutting edge and guide pad available regrinding
- Used drill can recycle as change part of carbide
- Depending on request, the drills can change geometry of cutting edge and drive specification
- For ordering, please check length of drill

Code system

KGD	S	12.05	-	1500	/	D30
<u>KORLOY Gun Drill</u>	<u>Lib type</u>	<u>Drill dia.</u>		<u>Length of drill</u>		<u>Drive no.</u>
	S: Single T: Twin	Ø12.05		1500 mm		D30

Features

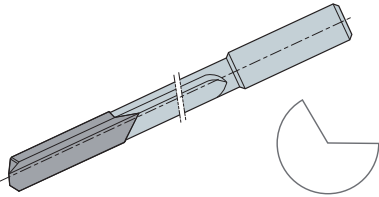
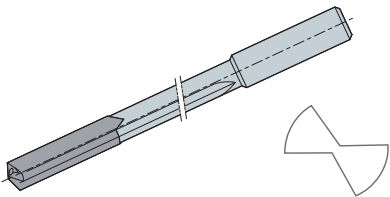
	Single lip type	Twin lip type
Shape		
Drill Dia.	Ø2.0~Ø33.0	Ø8.0~Ø24.0
Depth of drilling	≥ 2,000 mm	≥ 1,000 mm
Tolerance	IT9	IT10
Surface finish	Ra 0.1~3.0 µm	Ra 1.0~4.0 µm
Application	For all kinds of workpiece machining	<ul style="list-style-type: none"> • Workpieces with good chip evacuation • Machining of at higher feed than single lip type's

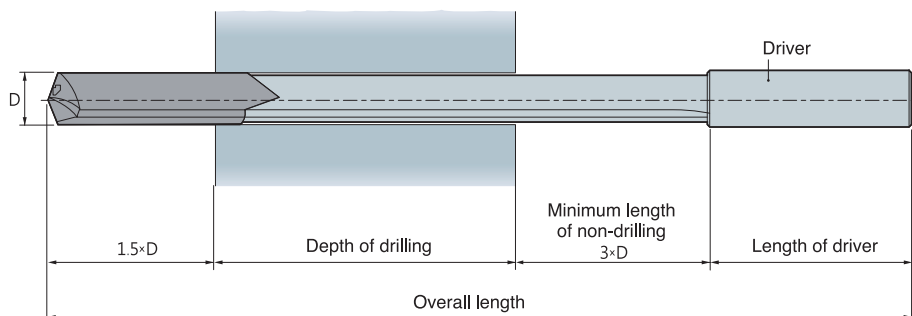

- Refer to the code system and the above drawing when ordering
- Refer to the page 112 for the size of a driver
- The overall length can be chosen by order



Application of Gun Drill on exclusive machine

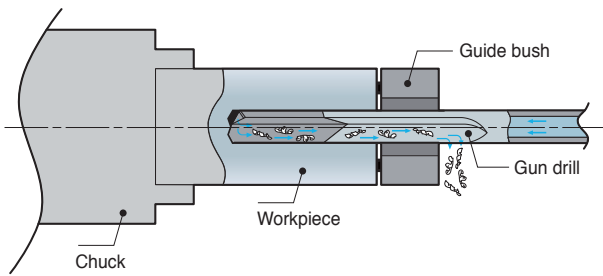

- The guide bush is necessary for centering before gun-drilling

Application of Gun Drill on machining center

1 Machining of a pilot hole

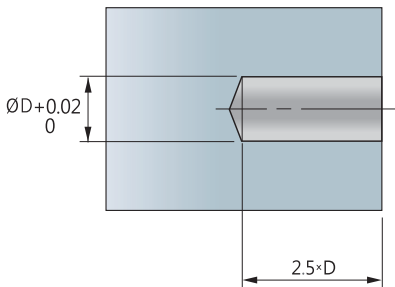

1. A pilot hole is necessary in machining on a machining center instead of a guide bush
2. The diameter of the pilot hole should be 0.01~0.02 (H7) larger bigger than one of the Gun Drill diameter and the depth of drilling should be about $2.5 \times D$
3. Use Mach Drill (MSD) for machining of a pilot hole



MSD

2 Moving the Gun Drill to the pilot hole

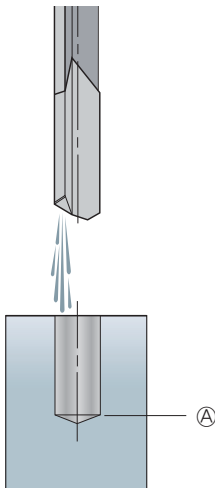

1. The Gun Drill should not drill before entering the pilot hole
2. Coolant is necessary for gun drilling

3 Start Gun Drilling

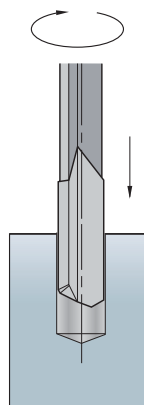

1. Rotate the spindle
2. Machine with drilling to vertical axis

4 After Gun Drilling

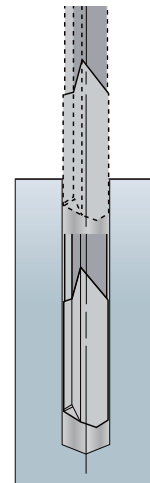

1. Return the drill
2. Stop drilling and supplying coolant
3. Remove the Gun Drill

Recommended cutting condition

Workpiece	Hardness (HB)	Cutting speed vc (m/min)	Feed rate (mm/rev) per drill dia. (mm)					
			~Ø4	~Ø6	~Ø10	~Ø14	~Ø24	Ø25~
Carbon steel Alloy steel	~150	100~150	0.005~0.015	0.010~0.025	0.015~0.035	0.020~0.050	0.030~0.070	0.040~0.080
	150~250	80~120	0.005~0.010	0.010~0.020	0.015~0.030	0.020~0.040	0.030~0.060	0.030~0.060
	250~350	50~100	0.005~0.010	0.005~0.010	0.010~0.020	0.015~0.030	0.020~0.040	0.020~0.040
	350~	~30	-	0.005~0.010	0.005~0.010	0.010~0.020	0.020~0.035	0.020~0.035
Stainless steel	~250	50~80	0.005~0.015	0.010~0.020	0.010~0.020	0.010~0.030	0.020~0.035	0.020~0.040
	250~350	40~50	-	0.005~0.015	0.010~0.015	0.010~0.020	0.010~0.020	0.010~0.020
Cast iron	~220	80~100	0.010~0.0120	0.020~0.040	0.030~0.050	0.040~0.080	0.080~0.120	0.100~0.150
	220~	40~80	0.005~0.010	0.005~0.015	0.010~0.020	0.015~0.030	0.020~0.050	0.025~0.070
Aluminum alloy	-	180~250	0.010~0.020	0.020~0.040	0.030~0.060	0.040~0.080	0.100~0.180	0.150~0.200
Light alloy	-	120~200	0.005~0.010	0.010~0.020	0.020~0.025	0.020~0.030	0.030~0.040	0.040~0.060

Technical information

The factors below determine the straightness of hole

- Drill diameter and depth of drilling
- Cutting condition and kind of application
- Kind of workpiece and machine
- Drill bush

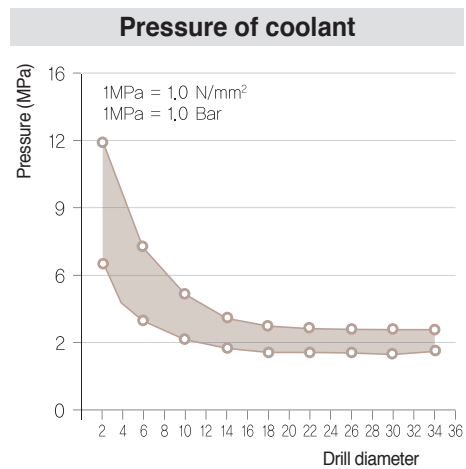
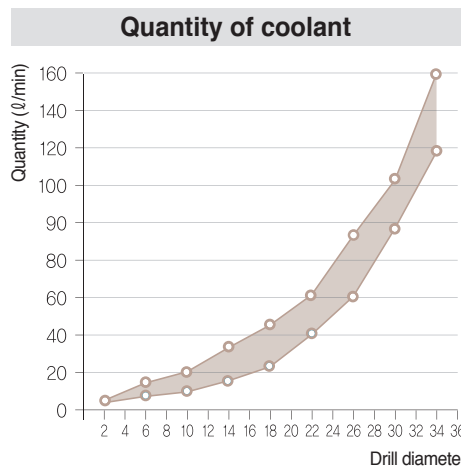
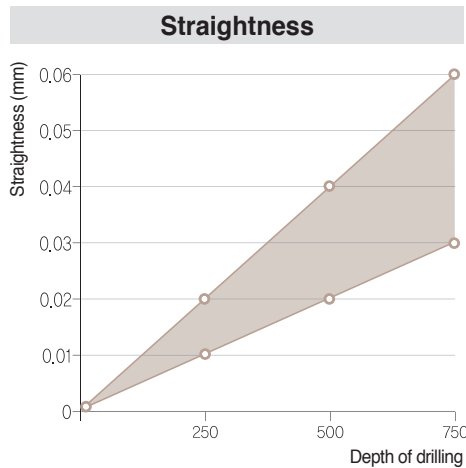
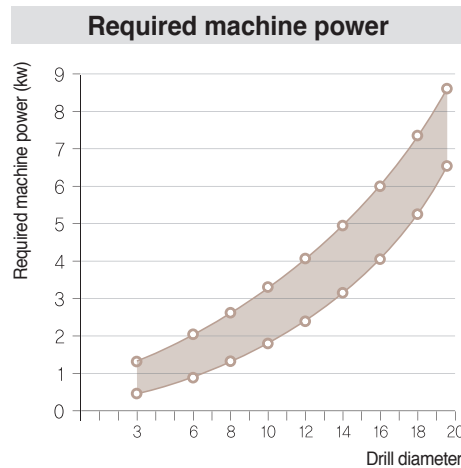

The above graph shows general information and it is changeable depending on kind of tool, workpieces, and cutting conditions etc

- **Pressure and quantity of coolant** - High pressure of coolant ensures excellent chip evacuation and cooling the cutting edge
- **Use a filter for removing impurities** - The diameter of a filter should be less than 20 μ m. Impurities could make bad flow of coolant, wear on a tool, and high load on the cooling pump
- **Temperature of coolant** - Proper temperature of coolant: 20°C~22°C / Do not use coolant at 50°C above

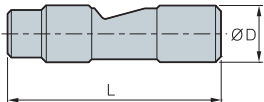
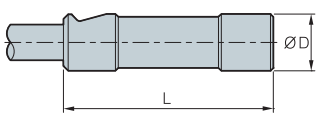
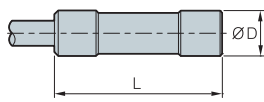
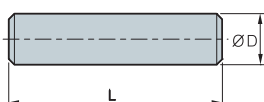
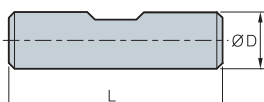
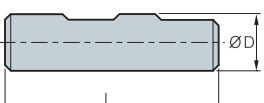
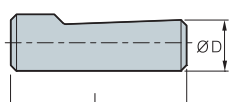
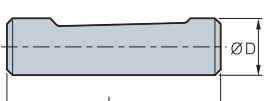

Driver standard

Type	Shape	No.	ØD×L		Carbide type	
			ØD×L	Thread	Tipped	Solid
Central clamping surface 15°		D01	10x40		●	●
		D02	16x45		●	
		D03	19.05x69.8		●	
		D04	25x70		●	
		D05	25.4x69.8		●	
Frontal clamping surface 15°		D06	16x50		●	
Central clamping tapered		D07	12.7x38.1		●	●
		D08	16x70			
		D09	19.05x69.8		●	
		D10	20x70			
Cylindrical DIN1835A DIN6535HA		D11	4x28		●	●
		D12	6x36		●	●
		D13	10x40		●	●
		D14	16x48		●	●
		D15	20x50		●	
		D16	25x56		●	
Weldon DIN1835B		D17	10x40		●	●
		D18	12x45		●	●
		D19	16x48		●	●
		D20	20x50		●	●
Weldon DIN6535HB		D21	25x56		●	
		D22	32x60		●	
		D23	40x70			
Whistle Notch DIN1835E		D24	10x40		●	●
		D25	12x45		●	●
		D26	16x48		●	●
		D27	20x50		●	●
		D28	25x56		●	
		D29	32x60		●	
Whistle notch DIN6535HE		D30	10x40		●	●
		D31	12x45		●	●
		D32	16x48		●	●
		D33	20x50		●	●

* Special types are available for quotation with shape and size information

Gun Drill-KGDS

Single Lip type

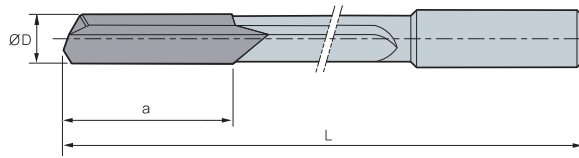

Designation description	
○.○○	Diameter
□□□□	Length
D□□	Driver code no.

(mm)

Designation	ØD	a
KGDS ○.○○-□□□□ / D□□	2.00~2.49	18
○.○○-□□□□ / D□□	2.50~2.99	18
○.○○-□□□□ / D□□	3.00~3.49	19
○.○○-□□□□ / D□□	3.50~3.99	19
○.○○-□□□□ / D□□	4.00~4.49	23
○.○○-□□□□ / D□□	4.50~4.99	23
○.○○-□□□□ / D□□	5.00~5.49	24
○.○○-□□□□ / D□□	5.50~5.99	26
○.○○-□□□□ / D□□	6.00~6.49	27
○.○○-□□□□ / D□□	6.50~6.99	28
○.○○-□□□□ / D□□	7.00~7.49	29
○.○○-□□□□ / D□□	7.50~7.99	30
○.○○-□□□□ / D□□	8.00~8.49	31
○.○○-□□□□ / D□□	8.50~8.99	31
○.○○-□□□□ / D□□	9.00~8.49	31
○.○○-□□□□ / D□□	9.50~9.99	31
○.○○-□□□□ / D□□	10.00~10.49	31
○.○○-□□□□ / D□□	10.50~10.99	32
○.○○-□□□□ / D□□	11.00~11.49	35
○.○○-□□□□ / D□□	11.50~11.99	35
○.○○-□□□□ / D□□	12.00~12.49	38
○.○○-□□□□ / D□□	12.50~12.99	38
○.○○-□□□□ / D□□	13.00~13.99	38
○.○○-□□□□ / D□□	14.00~14.99	38
○.○○-□□□□ / D□□	15.00~15.99	39
○.○○-□□□□ / D□□	16.00~16.99	39
○.○○-□□□□ / D□□	17.00~17.99	40
○.○○-□□□□ / D□□	18.00~18.99	41
○.○○-□□□□ / D□□	19.00~19.99	41
○.○○-□□□□ / D□□	20.00~20.99	44
○.○○-□□□□ / D□□	21.00~21.99	46
○.○○-□□□□ / D□□	22.00~22.99	49
○.○○-□□□□ / D□□	23.00~23.99	51
○.○○-□□□□ / D□□	24.00~24.99	52
○.○○-□□□□ / D□□	25.00~25.99	54
○.○○-□□□□ / D□□	26.00~26.99	54
○.○○-□□□□ / D□□	27.00~27.99	54
○.○○-□□□□ / D□□	28.00~28.99	54
○.○○-□□□□ / D□□	29.00~29.99	56
○.○○-□□□□ / D□□	30.00~30.99	59
○.○○-□□□□ / D□□	31.00~31.99	61
○.○○-□□□□ / D□□	32.00~32.99	61

※ When ordering, please mark the overall length and driver number (or drawing)

Available overall length

Designation	Drill Dia.	Overall length				
		250 mm	500 mm	1000 mm	1500 mm	2000 mm
KGDS	2.00~2.99	○	○			
	3.00~3.49	○	○	○		
	3.50~32.99	○	○	○	○	○



Gun Drill-KGDT

Twin Lip type

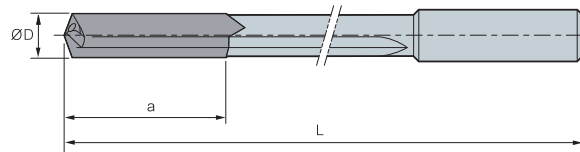

Designation description	
○.○○	Diameter
□□□□	Length
D□□	Driver code no.



Designation	ØD	a
○.○○-□□□□ / D□□	8.00~8.49	38
○.○○-□□□□ / D□□	8.50~8.99	38
○.○○-□□□□ / D□□	9.00~8.49	40
○.○○-□□□□ / D□□	9.50~9.99	40
○.○○-□□□□ / D□□	10.00~10.49	40
○.○○-□□□□ / D□□	10.50~10.99	40
○.○○-□□□□ / D□□	11.00~11.49	45
○.○○-□□□□ / D□□	11.50~11.99	45
○.○○-□□□□ / D□□	12.00~12.49	45
○.○○-□□□□ / D□□	12.50~12.99	48
○.○○-□□□□ / D□□	13.00~13.99	48
○.○○-□□□□ / D□□	14.00~14.99	48
○.○○-□□□□ / D□□	15.00~15.99	48
○.○○-□□□□ / D□□	16.00~16.99	50
○.○○-□□□□ / D□□	17.00~17.99	50
○.○○-□□□□ / D□□	18.00~18.99	50
○.○○-□□□□ / D□□	19.00~19.99	50
○.○○-□□□□ / D□□	20.00~20.99	55
○.○○-□□□□ / D□□	21.00~21.99	55
○.○○-□□□□ / D□□	22.00~22.99	55
○.○○-□□□□ / D□□	23.00~23.99	60

※ When ordering, please mark the overall length and driver number (or drawing)

Available overall length

Designation	Drill Dia.	Overall length				
		250 mm	500 mm	1000 mm	1500 mm	2000 mm
KGDT	8.00~24.00	○	○	○		



Mass production and High performance

Indexable Reamer

- Suitable for mass production and high performance
- Using PCD or coated insert for high speed machining
- Excellent high accuracy and adjustable machining hole
- Using accuracy chucking system (Hydraulic, rotating type arbor)
- Using inner coolant type machine to evacuate chips
- Using suitable holder and insert
- As insert setting, using setting fixture (KIRSD-210)

Code system

IR T 12.000 - 16 135 - 16					
Type	Application	Reamer dia.	Shank Dia.	length	Insert size
Indexable Reamer	T: Throughout hole machining B: Blind hole machining	12.000: Ø12.0	16: Ø16	135: 135	15: 15.0×3.0 16: 16.0×3.5 17: 17.0×4.5 22: 22.0×6.5

Insert code system

RI 16 - B 06			
Type	Insert size	Insert reed type	Angle of C/B
Reamer Insert	15: 15.0×3.0 16: 16.0×3.5 17: 17.0×4.5 22: 22.0×6.5	A: Excellent surface finish, low cutting condition B: General surface finish, high cutting condition C: Aluminum and copper alloy D: Blind hole, low feed	00: 0°, Cast iron 06: 6°, General steel 12: 12°, Stainless, Al

Application

Throughout hole machining (IRT type)

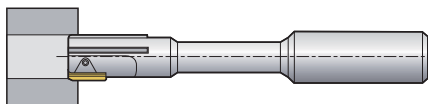

Stuffed hole machining (IRB type)

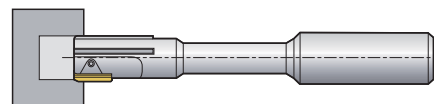

How to set an insert

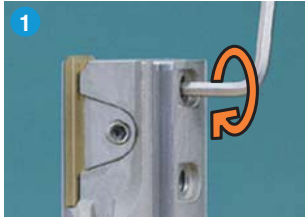

1. Screw the wedge screw counter clockwise with the exclusive wrench

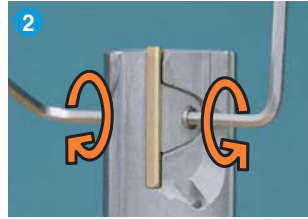

2. Screw the clamp screw
 ① Top side: counter clockwise
 ② Lower side: clockwise

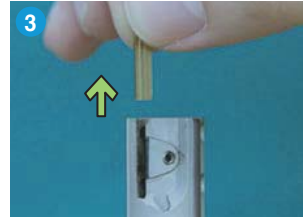

3. Remove the insert and clean the pocket

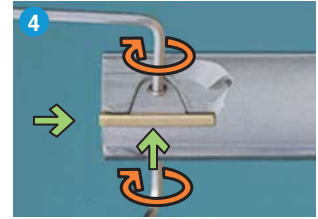

4. Put the insert up to the edge stopper and clamp the insert
 ① Top side: clockwise
 ② Lower side: counterclockwise

Exclusive fixture

- Designation: KIRSD-210
- Maximum diameter of reamer: $\varnothing 60 \times 210$ mm
- The fixture is also available for setting special reamer and mono tool
- Special reamers (out of maximum setting range) are available quotation



How to set an insert with fixture



1. Adjust the gauge to '0'



2. Rotate the reamer for the insert to touch the gauge



3. Set the back taper and adjust the insert height with screw the wedge screw
 ① Top side of insert: $+0.015 \sim +0.020$ mm
 ② Bottom side of insert: $+0.005 \sim +0.010$ mm
 ③ Back taper: $0.010 \sim 0.015$ mm

Back taper

- Ensures low cutting load and excellent surface finish with good chip evacuation
- Inaccurate back taper could cause unstable machining with wear of insert
- The size of back taper of insert down side should be less to $0.010 \sim 0.015$ mm than one of insert upper side

Insert setting with a micrometer



- Lathe with both centers or bench center are also available

Notice: The setting with a micrometer is not recommended due to chipping on the cutting edge

Recommended cutting condition

Workpiece	Insert type		Feed rate (mm/rev) per drill dia. (mm)	Cutting speed v_c (m/min)		
	Rake angle	Lead type		Coated	Uncoated	Cermet
Carbon steel General steel	6	A	0.1~0.4	60~80	40~60	110~160
		B	0.1~0.3	80~120	60~80	
		D	0.05~0.2			
Mild steel Alloy steel	6	A	0.1~0.4	40~60	20~40	110~160
		B	0.1~0.3	80~120	60~80	
		D	0.05~0.2			
High alloy steel Tool steel	6	A	0.1~0.4	20~60	20~40	20~60
		B	0.1~0.3	40~80	40~60	40~80
		D	0.05~0.2			
Stainless steel	12	A	0.1~0.3	40~60	20~40	40~60
		B	0.1~0.2	60~80	40~60	60~80
		D	0.05~0.2			
Cast iron	0.6	A	0.1~0.3	60~100	40~60	
		B	0.1~0.25	80~120	60~80	
		D	0.05~0.2			
Alloyed aluminum	12	B	0.1~0.3		160~200	
		C	0.15~0.3		150~250	
		D	0.05~0.2		110~200	
Alloyed copper	0	B	0.1~0.2		80~100	
		D	0.05~0.2			
Non-ferrous alloy	0	B	0.1~0.3		10~70	

Parts

Reamer size	Clamp	Wedge	Clamp Screw	Wedge Screw	Clamp Wrench	Wedge Wrench
10.0~11.9	CV 15	AW2430	DHA0308	HSO306	HW15L	HW15L
12.0~17.9	CV 16	AW2435				
18.0~27.9	CV 17	AW3240	DHA0409	HSO406	HW20L	HW20L
28.0~31.9	CV 22	AW3260				



Indexable Reamer Insert

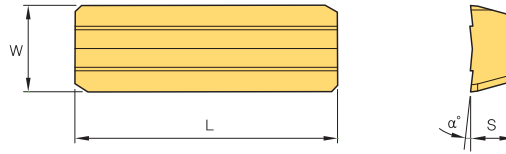

Designation	Grade			Dimensions			Reed type	Rake angle (α°)			
	K10 (Uncoated)	BPK110 (TiAlN)	BPK210 (TiN)	L	W	S					
RI	15-A06		○	15	3.0	1.5	A	6°			
	15-A12	○		15	3.0	1.5	A	12°			
	15-B06		○	15	3.0	1.5	B	6°			
	15-B12		○	15	3.0	1.5	B	12°			
	16-A06			○	16	3.5	1.5	A	6°		
	16-A12	○			16	3.5	1.5	A	12°		
	16-B06		○	○	16	3.5	1.5	B	6°		
	16-B12		○		16	3.5	1.5	B	12°		
	17-A06				○	17	4.5	2.0	A	6°	
	17-A12	○				17	4.5	2.0	A	12°	
	17-B06		○	○	17	4.5	2.0	B	6°		
	17-B12		○		17	4.5	2.0	B	12°		
	22-A06					○	22	6.5	3.0	A	6°
	22-A12	○					22	6.5	3.0	A	12°
	22-B06		○	○	22	6.5	3.0	B	6°		
	22-B12		○		22	6.5	3.0	B	12°		

※ ○ This is recommended grade as for insert type

Angle of chip breaker

Division	00	06	12
Shape			
Application	For cast iron machining	For general machining	For stainless and aluminum machining

Insert lead type

Type	Shape	Working condition	Type	Shape	Working condition
A		For excellent surface, low cutting condition	C		For aluminum and copper alloy machining
B		For general application, high cutting condition	D		For blind hole machining, low feed

Indexable Reamer-IRT

Throughout hole

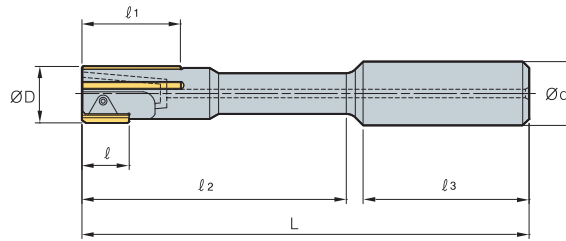

(mm)

	Designation	ØD	l	l ₁	l ₂	l ₃	L	Ød	Insert
IRT	10.000-16125-15	10	15	30	75	45	125	16	RI 15
	11.000-16125-15	11	15	30	75	45	125	16	RI 15
	12.000-16135-16	12	16	30	85	45	135	16	RI 16
	13.000-16135-16	13	16	30	85	45	135	16	RI 16
	14.000-16135-16	14	16	30	85	45	135	16	RI 16
	15.000-16135-16	15	16	30	85	45	135	16	RI 16
	16.000-20155-16	16	16	30	100	50	155	20	RI 16
	17.000-20155-16	17	16	30	100	50	155	20	RI 16
	18.000-20155-17	18	17	30	100	50	155	20	RI 17
	19.000-20155-17	19	17	30	100	50	155	20	RI 17
	20.000-25165-17	20	17	30	110	56	165	25	RI 17
	21.000-25165-17	21	17	30	110	56	165	25	RI 17
	22.000-25165-17	22	17	30	110	56	165	25	RI 17
	23.000-25165-17	23	17	30	110	56	165	25	RI 17
	24.000-25165-17	24	17	30	110	56	165	25	RI 17
	25.000-25165-17	25	17	30	110	56	165	25	RI 17
	26.000-25165-17	26	17	30	110	56	165	25	RI 17
	27.000-25165-17	27	17	30	110	56	165	25	RI 17
	28.000-32165-22	28	22	30	110	56	165	32	RI 22
	29.000-32165-22	29	22	30	110	56	165	32	RI 22
30.000-32165-22	30	22	30	110	56	165	32	RI 22	
31.000-32165-22	31	22	30	110	56	165	32	RI 22	

➔ Applicable inserts G113



Indexable Reamer-IRB

Stuffed hole

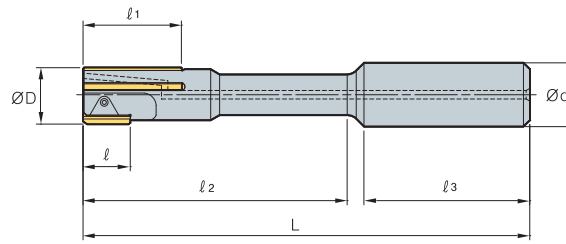

(mm)

	Designation	ØD	ℓ	ℓ ₁	ℓ ₂	ℓ ₃	L	Ød	Insert
IRB	10.000-16125-15	10	15	30	75	45	125	16	RI 15
	11.000-16125-15	11	15	30	75	45	125	16	RI 15
	12.000-16135-16	12	16	30	85	45	135	16	RI 16
	13.000-16135-16	13	16	30	85	45	135	16	RI 16
	14.000-16135-16	14	16	30	85	45	135	16	RI 16
	15.000-16135-16	15	16	30	85	45	135	16	RI 16
	16.000-20155-16	16	16	30	100	50	155	20	RI 16
	17.000-20155-16	17	16	30	100	50	155	20	RI 16
	18.000-20155-17	18	17	30	100	50	155	20	RI 17
	19.000-20155-17	19	17	30	100	50	155	20	RI 17
	20.000-25165-17	20	17	30	110	56	165	25	RI 17
	21.000-25165-17	21	17	30	110	56	165	25	RI 17
	22.000-25165-17	22	17	30	110	56	165	25	RI 17
	23.000-25165-17	23	17	30	110	56	165	25	RI 17
	24.000-25165-17	24	17	30	110	56	165	25	RI 17
	25.000-25165-17	25	17	30	110	56	165	25	RI 17
	26.000-25165-17	26	17	30	110	56	165	25	RI 17
	27.000-25165-17	27	17	30	110	56	165	25	RI 17
	28.000-32165-22	28	22	30	110	56	165	32	RI 22
	29.000-32165-22	29	22	30	110	56	165	32	RI 22
	30.000-32165-22	30	22	30	110	56	165	32	RI 22
31.000-32165-22	31	22	30	110	56	165	32	RI 22	

↻ Applicable inserts **G113**

Chucking/Machine Reamer

Recommended cutting condition

Workpiece	Hardness (HB)	Cutting condition	Diameter		
			~Ø9	Ø10~25	Ø26~60
Steel	~100kg/mm ²	vc (m/min)	8~12	8~12	8~12
		fn (mm/rev)	0.15~0.25	0.20~0.40	0.30~0.50
	100~140kg/mm ²	vc (m/min)	5~10	5~10	5~10
		fn (mm/rev)	0.10~0.20	0.15~0.25	0.20~0.40
Cast iron	HB~220	vc (m/min)	6~12	6~12	8~15
		fn (mm/rev)	0.15~0.30	0.30~0.50	0.40~0.80
	HB 220~	vc (m/min)	5~10	5~10	8~12
		fn (mm/rev)	0.10~0.20	0.20~0.35	0.30~0.50
Brass	HB 50~120	vc (m/min)	8~12	10~15	10~15
		fn (mm/rev)	0.10~0.15	0.15~0.25	0.25~0.40
Bronze	HB 60~100	vc (m/min)	8~12	10~15	10~15
		fn (mm/rev)	0.10~0.15	0.15~0.25	0.25~0.40
Alloyed aluminum	HB 90~120	vc (m/min)	15~25	15~25	20~30
		fn (mm/rev)	0.15~0.25	0.25~0.40	0.40~0.70
Synthetic resins	-	vc (m/min)	15~30	20~35	30~40
		fn (mm/rev)	0.15~0.25	0.25~0.40	0.40~0.50



Chucking Reamer-SCRS

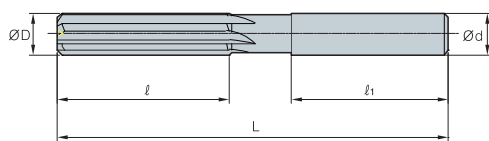

Fig.1

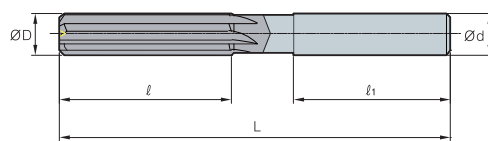

Fig.2

(mm)

Designation	No. of flute	ØD	Ød	ℓ	ℓ ₁	L	Fig.	
SCRS	050S	4	5.0	6.0	20	40	100	1
	060S	4	6.0	6.0	20	40	115	1
	070S	4	7.0	8.0	20	40	125	1
	080S	4	8.0	8.0	20	40	135	1
	090S	4	9.0	10.0	20	45	140	1
	100B	4	10.0	10.0	25	50	145	2
	110B	4	11.0	12.0	25	50	150	2
	120B	4	12.0	12.0	25	50	160	2
	130B	4	13.0	16.0	25	50	165	2
	140B	6	14.0	16.0	25	50	170	2
	150B	6	15.0	16.0	30	50	180	2
	160B	6	16.0	16.0	30	50	190	2
	180B	6	18.0	20.0	30	55	210	2
	200B	6	20.0	20.0	40	60	230	2

Chucking Reamer-SCRH

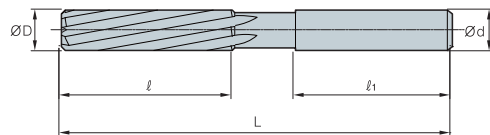

Fig.1

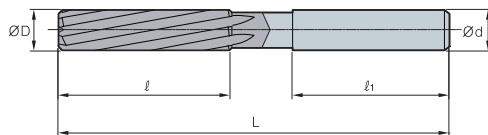
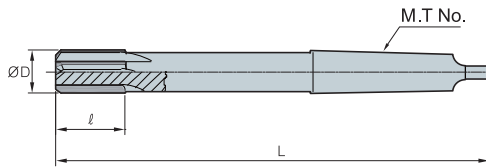

Fig.2

(mm)

Designation	No. of flute	ØD	Ød	ℓ	ℓ ₁	L	Fig.	
SCRH	050S	4	5.0	6.0	20	40	100	1
	060S	4	6.0	6.0	20	40	115	1
	070S	4	7.0	8.0	20	40	125	1
	080S	4	8.0	8.0	20	40	135	1
	090S	4	9.0	10.0	20	45	140	1
	100B	4	10.0	10.0	25	50	145	2
	110B	4	11.0	12.0	25	50	150	2
	120B	4	12.0	12.0	25	50	160	2
	130B	4	13.0	16.0	25	50	165	2
	140B	6	14.0	16.0	25	50	170	2
	150B	6	15.0	16.0	30	50	180	2
	160B	6	16.0	16.0	30	50	190	2
	180B	6	18.0	20.0	30	55	210	2
	200B	6	20.0	20.0	40	60	230	2

Chucking Reamer-TCRS



(mm)

Designation	No. of flute	ØD	ℓ	L	M.T No.
TCRS 070	4	7.0	20	150	1
080	4	8.0	20	150	1
090	4	9.0	20	160	1
100	4	10.0	25	160	1
110	4	11.0	25	170	1
120	4	12.0	25	170	1
130	4	13.0	25	180	1
140	6	14.0	25	190	1
150	6	15.0	30	200	2
160	6	16.0	30	200	2
180	6	18.0	30	220	2
200	6	20.0	40	230	2
250	6	25.0	40	260	3
280	8	28.0	40	270	3
300	8	30.0	50	290	3

Chucking Reamer-TMRS

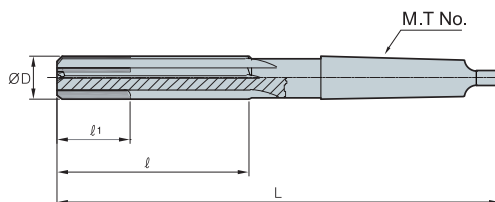

(mm)

Designation	No. of flute	ØD	ℓ	ℓ₁	L	M.T No.
TMRS 070	4	7.0	60	60	150	1
080	4	8.0	70	70	150	1
090	4	9.0	70	70	160	1
100	4	10.0	75	75	170	1
110	4	11.0	75	75	170	1
120	4	12.0	80	40	180	1
130	4	13.0	85	40	190	1
140	6	14.0	90	45	210	1
150	6	15.0	90	45	215	2
160	6	16.0	100	50	220	2
180	6	18.0	105	50	225	2
200	6	20.0	120	50	240	2
250	6	25.0	130	50	270	3
280	8	28.0	140	50	280	3
300	8	30.0	150	50	290	3



PCD Reamer

Code system

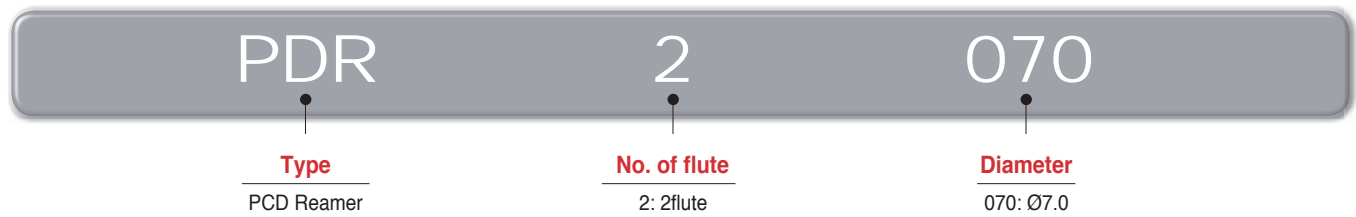

Recommended cutting condition (For high speed and high precision machining)

Workpiece	vc (m/min)	fn (mm/rev)
Aluminum alloy	50~250	0.05~0.20

PCD Reamer-PDR

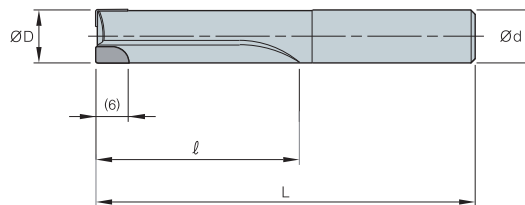

Designation		No. of flute	$\varnothing D$	$\varnothing d$	l	L
PDR	2050	2	5.0	6.0	30	65
	2060	2	6.0	6.0	40	75
	2070	2	7.0	8.0	40	75
	2080	2	8.0	8.0	40	75
	2090	2	9.0	10.0	40	85
	2100	2	10.0	10.0	40	85
	2120	2	12.0	12.0	50	95
	2140	2	14.0	16.0	50	95
	2150	2	15.0	16.0	50	100
	4160	4	16.0	16.0	50	100
	4180	4	18.0	20.0	60	110
	4200	4	20.0	20.0	60	110

Cermet Reamer

- Cermet reamer realizes high performance in high hardness steel machining (lower performance in casting machining)
- High machinability and wear resistance extend the tool life
- Over 30% higher productivity, surface roughness, and tool life than carbide reamer

Code system

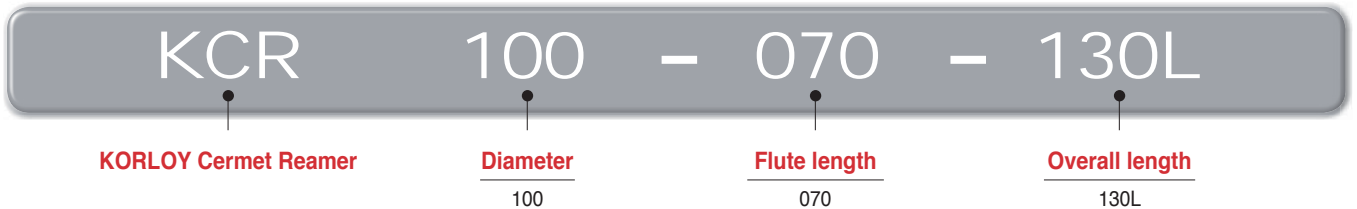

Recommended cutting condition

Workpiece	Hardness	fn (mm/rev)	vc (m/min)
Carbon steel	Under 30HRC	0.1~0.4	50~80
High carbon steel, Alloy steel	30~40HRC	0.1~0.4	80~120
	40~50HRC	0.1~0.4	50~80
Alloy steel	More than 50HRC	0.05~0.2	30~60

Application examples



- **Cutting condition**
- Workpiece: S55CR
- Hardness: 23~30HRC
- fn (mm/rev): 0.4
- vc (m/min): 20

Cermet Reamer-KCR

Standard type

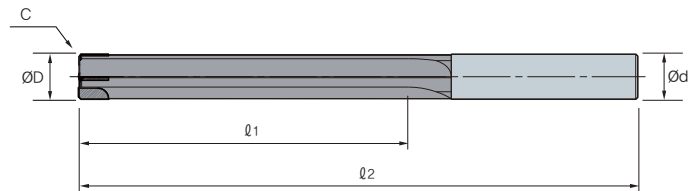

(mm)

Designation	No. of flute	ØD	Ød	l ₁	L
KCR 060~079-25-70L	2	6.0~7.9	8	25	70
080~099-035-90L	2	8.0~9.9	10	35	90
100~119-050-100L	4	10.0~11.9	12	50	100
120~159-060-110L	4	12.0~15.9	12	60	110
160~199-060-110L	4	16.0~19.9	16	60	110
200~259-060-110L	4	20.0~25.9	20	60	110
260~300-070-130L	4	26.0~30	25	70	130

• The length of flute and overhang length of reamer are available for quotation • The maximum overhang length is 150 mm

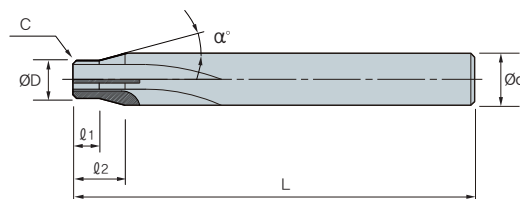

Special type

(mm)

Designation	No. of flute	ØD	Ød	l ₁	l ₂	L	α°
KCR □□□~□□□-□□□L	2~4	8.0~25.9	12~30	7~18	2~15	70	10°~60°



Broach Reamer

- Optimal for thru hole machining with high precision with long tool life
- High helix angle (45 degree) improves machinability
- Superior surface roughness and high precision
- Strong cutting edge and excellent chip evacuation
- Dia. Ø3.0~Ø25.0

Broach Reamer-HBRE

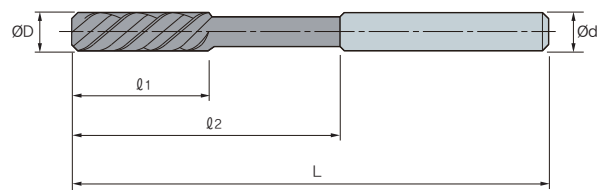

								(mm)
Designation	No. of flute	ØD	Ød	l ₁	l ₂	L	Type	
HBRE	030	3	3.0	3.0	20	40	70	Solid
	040	3	4.0	4.0	25	40	70	Solid
	060	4	6.0	6.0	30	50	80	Solid
	080	4	8.0	8.0	30	60	100	Solid
	100	4	10.0	10.0	30	60	100	Solid
	120	4	12.0	12.0	40	70	120	Top Solid
	160	6	16.0	16.0	40	80	130	Top Solid
	200	6	20.0	20.0	50	90	150	Top Solid
	250	6	25.0	25.0	50	90	150	Top Solid

H

BRAZED TOOLS



Technical Information for Braze Tools

H02 KORLOY Ultra-Fine Grades: F-Series

H03 Corrosion & Magnetism Proof Grade: IN-Series

General Cutting Tools

H04 Cemented Carbide, Cermet Blank

H05 Square Blank

H07 Round bar Blank

H07 Ring Blank

H08 Helix Blank

H09 Square Bits

H10 Auto Tool Bits

H11 Chuck Jaw

Mining & Construction Tools

H12 Cemented Carbide Blank for Taper Bits

H13 Cemented Carbide Blank for Cross Bits

H13 Taper Bits

H13 Boring Crown Blank

H13 Bits for Construction

Rotating Brazing Tools

H14 Rotating Brazing Tool

H15 Special Rotating Brazing Tools Order Form

KORLOY ultra-fine grades "F-Series"

Features

In general, when we compare cemented carbide to high speed steel, cemented carbide has higher hardness but is more brittle than high speed steel. To neutralize the difference, KORLOY has developed an ultra fine cemented carbide grade "F-Series"± (WC size under 0.5 μ m). It provides improved toughness and plastic deformation resistance against cemented carbide having coarse grain sizes. The main coverage for ultra fine cemented carbide is endmilling of difficult-to-cut materials like high temp alloys

Micro structure of "F-Series"

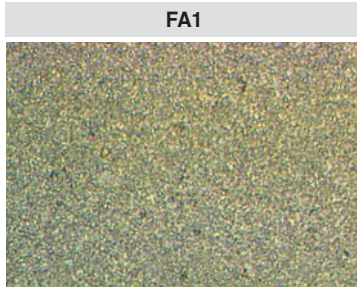

Since it is a grade focused on toughness, it is possible to make endmill, side cutter, gun drill, reamer etc. It has superior quality on toughness and anti built-up edge properties

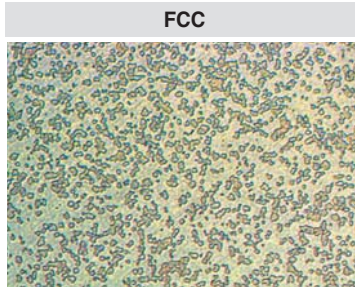

It has been modified from FA1 to increase thermal shock resistance, thus FCC has proper properties to machine stainless steel and hard to machine materials at medium to high speed milling

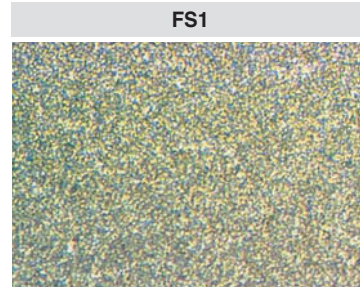

As an ultra fine grade having high hardness and superior toughness at the same time, it is the 1st recommended grade of KORLOY to make sharp cutting edge to cut difficult-to-cut material

Cutting performance

Special features

Grade	Characteristics			ISO classification	Wear resistance	Toughness
	Specific Gravity	Hardness (H _v A)	TRS (kgf/mm ²)			
FS1	14.4	92.4	250	Z10	⊙	○
FCC	12.6	91.5	250	Z10	⊙	○
FA1	14.1	91.2	300	Z20	○	⊙
FG2	14.3	92.7	350	Z10	⊙	○

Chipping resistance

Grade	Chipping resistance (m)	Chipping (grooves)
Ultra fine grade	24.5	(65.5 grooves)
Carbide	G10	0.96 m (2.5 grooves) chipping
	H01	1.54 m (4 grooves) chipping
High speed steel	2.55 m (6.7 grooves) chipping	

· Workpiece: 4140 (AISI) · Tool: Solid carbide endmill (Ø8 mm, 2Flutes)
· vc = 26.5 m/min, fz = 0.0285 mm/t, vf = 60 mm/min, with coolant

Wear resistance

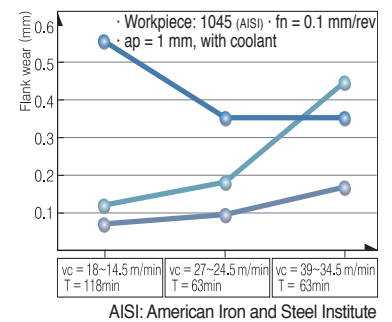

Guide of grade selection

Workpiece	Non-ferrous metal Steel, Cast iron
1 st Recommended grade	FS1, FG2, FCC, FA1
Application tool	Drill, Endmill

- Workpiece: SM55C (HrC20)
- Helix angle: 30°
- Tool: Ø10 mm, 2 Flutes (SSE2100)
- RPM = 1,100 min⁻¹
- Cutting speed = 35 m/min
- Axial depth = 12 mm
- Feed = 0.1 mm/t
- Radial depth = 1 mm
- Downward cutting, Without coolant

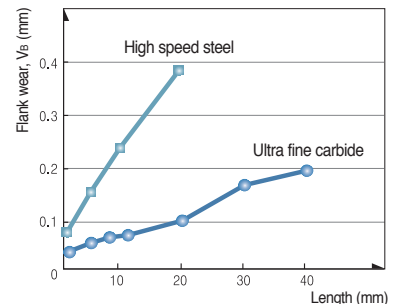

KORLOY corrosion & magnetism proof grades, “IN-Series”

Features

- Outstanding corrosion resistance: several hundred times better performance than general carbide grade (Test have been performed at 30% NHO3, comparing KORLOY G5 and IN-Series)
- Excellent hardness & toughness: Over (HrA) 85 hardness, Over (TRS) 200 toughness
- Several grades: 3 different kind of grades for specific application, respectively

Grade	Specific gravity (g/cm ³)	Hardness (HrA)	TRS (kgf/mm ²)	Magnetic saturation (Gauss · cm ³ /g)	Use
IN10	14.4	91.5	230	0	Mechanical Seal, Sliter Knife Anti-corrosive alloy, Magnetism proof alloy
IN20	14.5	91.0	230	90	Mechanical Seal, Sliter Knife Anti-corrosive alloy
IN40	13.5	85.5	230	0	Mold for magnetic powder Anticorrosive-Magnetism proof alloy

Micro structure of “IN-Series”

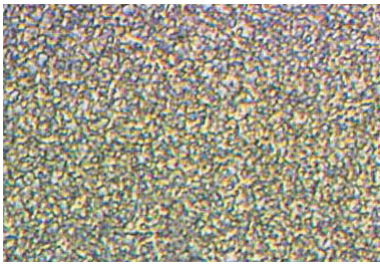

Use

For anti-corrosive	For magnetism proof
<ul style="list-style-type: none"> • Parts for plant of corrosion-high pressure • Parts for sea water pump • Die/punch in high temperature • Mechanical seal 	<ul style="list-style-type: none"> • Tape sliter • Mold for magnetic powder • Parts for VTR

H Cemented Carbide, Cermet Blank

Inserts	Designation	A	B	C	R	Uncoated						Cermet	Available blank	
						ST10	ST20	GR35	U20	H01	H05	G10		CN2000
	01-0	10	6	3	4									
	1	13	9	3	5									
	2	16	11	4	5		●						31 Type	
	3	19	13	5	5		●						32 Type	
	4	22	15	6	8								45 Type	
	5	25	17	7	8								46 Type	
	6	30	20	8	8									
	02-0	10	6	3	-		●		●	●				
	1	13	9	3	-		●		●	●				
	2	16	11	4	-		●		●	●				
	3	19	13	5	-	●	●		●	●			41 Type	
	4	22	15	6	-		●		●	●			42 Type	
	5	25	17	7	-		●		●	●				
	6	30	20	8	-		●		●	●				
	03-0	10	-	3	-									
	1	12	-	3	-									
	2	15	-	4	-									
	3	18	-	5	-									
	4	24	-	6	-									
	5	24	-	7	-									
	6	28	-	8	-									
	04-0	10	6	3	4									
	1	13	9	3	5		●							
	2	16	11	4	5									
	3	19	13	5	5		●							
	4	22	15	6	8									
	5	25	17	7	8									
	6	30	20	8	8									
	05-1	5	8	3	-		●		●					
	2	6	10	4	-		●		●					
	3	7	12	5	-		●		●					
	4	9	16	6	-		●							
	5	10	18	7	-									
	6	11	20	8	-									
	06-0	10	10	3	2		●		●	●				
	1	13	13	3	2.5		●	●	●	●		●		
	2	16	16	4	3			●	●	●		●		
	3	19	19	5	4		●	●	●	●		●		
	4	22	22	6	4		●	●	●	●		●		
	5	25	25	7	5			●	●	●		●		
	6	30	30	8	6			●	●	●		●		
	07-0	10	10	3	-									
	1	13	13	3	-									
	2	16	16	4	-									
	3	19	19	5	-									
	4	25	20	6	-									
	5	25	22	7	-									
	6	30	25	8	-									
	08-1	3	8	3	-		●		●					
	3	4	13	4	-	●	●		●	●		●		
	4	5	15	5	-	●	●		●	●		●		
	5	6	17	6	-	●	●		●	●		●		
	6	8	20	8	-		●		●	●		●		



RB



■ Bending tolerance

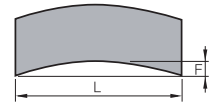

Standard	L		F-max
	Tolerance		
~30	+1.0	-0	0.15
31~50	+1.5	-0	0.25
51~100	+3.0	-0	0.30

※ Code system **RB** **15** **04** □
 Length Width Thickness

Designation	L	W	T = □							Grades			
			3	4	5	6	7	8	9		10		
			(mm)										
RB	303□	3	3										
	304□	3	4										
	305□	3	5										
	306□	3	6										
	307□	3	7										
	308□	3	8										
	309□	3	9										
	310□	3	10										
	RB	403□	4	3									
		404□	4	4									
405□		4	5										
406□		4	6										
407□		4	7										
408□		4	8										
409□		4	9										
410□		4	10										
RB		503□	5	3									
		504□	5	4									
	505□	5	5										
	506□	5	6										
	507□	5	7										
	508□	5	8										
	509□	5	9										
	510□	5	10										
	RB	603□	6	3									
		604□	6	4									
605□		6	5										
606□		6	6										
607□		6	7										
608□		6	8										
609□		6	9										
610□		6	10										
RB		703□	7	3									
		704□	7	4									
	705□	7	5										

Designation	L	W	T = □							Grades			
			3	4	5	6	7	8	9		10		
			(mm)										
RB	706□	7	6										
	707□	7	7										
	708□	7	8										
	709□	7	9										
	710□	7	10										
	RB	803□	8	3									
804□		8	4										
805□		8	5										
806□		8	6										
807□		8	7										
808□		8	8										
809□		8	9										
810□		8	10										
RB		903□	9	3									
		904□	9	4									
	905□	9	5										
	906□	9	6										
	907□	9	7										
	908□	9	8										
	909□	9	9										
	910□	9	10										
	RB	1003□	10	3									
		1004□	10	4									
1005□		10	5										
1006□		10	6										
1007□		10	7										
1008□		10	8										
1009□		10	9										
1010□		10	10										
RB		1504□	15	4									
		1505□	15	5									
	RB	2003□	20	3									
2004□		20	4										
2005□		20	5										
2006□		20	6										

RB



■ Bending tolerance

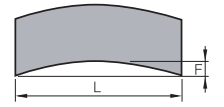

Standard	L		F-max
	Tolerance		
~30	+1.0 - 0		0.15
31~50	+1.5 - 0		0.25
51~100	+3.0 - 0		0.30

※ Code system **RB** **15** **04** □
 Length Width Thickness

Designation	L	W	T = □										Grades
			3	4	5	6	7	8	9	10	G10		
RB 2007□	20	7											
RB 2008□	20	8											
RB 2009□	20	9											
RB 2010□	20	10											
RB 3003□	30	3											
RB 3004□	30	4											
RB 3005□	30	5											
RB 3006□	30	6											
RB 3007□	30	7											
RB 3008□	30	8											
RB 3009□	30	9											
RB 3010□	30	10											
RB 4003□	40	3											
RB 4004□	40	4											
RB 4005□	40	5											
RB 4006□	40	6											
RB 4007□	40	7											
RB 4008□	40	8											
RB 4009□	40	9											
RB 4010□	40	10											
RB 5003□	50	3											
RB 5004□	50	4											
RB 5005□	50	5											
RB 5006□	50	6											
RB 5007□	50	7											
RB 5008□	50	8											
RB 5009□	50	9											
RB 5010□	50	10											
RB 6003□	60	3											
RB 6004□	60	4											
RB 6005□	60	5											
RB 6006□	60	6											
RB 6007□	60	7											
RB 6008□	60	8											
RB 6009□	60	9											

Designation	L	W	T = □										Grades
			3	4	5	6	7	8	9	10	G10		
RB 6010□	60	10											
RB 7003□	70	3											
RB 7004□	70	4											
RB 7005□	70	5											
RB 7006□	70	6											
RB 7007□	70	7											
RB 7008□	70	8											
RB 7009□	70	9											
RB 7010□	70	10											
RB 8003□	80	3											
RB 8004□	80	4											
RB 8005□	80	5											
RB 8006□	80	6											
RB 8007□	80	7											
RB 8008□	80	8											
RB 8009□	80	9											
RB 8010□	80	10											
RB 9003□	90	3											
RB 9004□	90	4											
RB 9005□	90	5											
RB 9006□	90	6											
RB 9007□	90	7											
RB 9008□	90	8											
RB 9009□	90	9											
RB 9010□	90	10											
RB 10003□	100	3											
RB 10004□	100	4											
RB 10005□	100	5											
RB 10006□	100	6											
RB 10007□	100	7											
RB 10008□	100	8											
RB 10009□	100	9											
RB 10010□	100	10											



SR Round bars blank

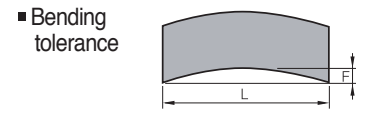
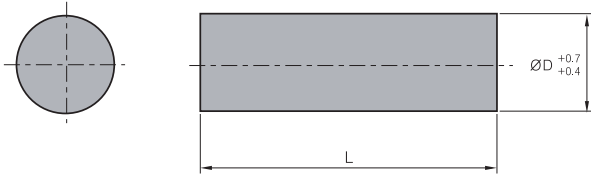

Standard	L		F-max
	Tolerance		
~30	+1.5 - 0		0.10
31~40	+1.5 - 0		0.15
41~50	+1.5 - 0		0.20
51~100	+2.5 - 0		0.25

※ Code system **SR** **03** □
 Diameter Length

Designation	ØD	T = □								Grades		
		30	40	50	60	70	80	90	100	ST20	G10	
SR	03□	3										
	04□	4										
	05□	5										
	06□	6										
	07□	7										
	08□	8										
	09□	9										
	10□	10										
	11□	11										
	12□	12										

RT Ring blank

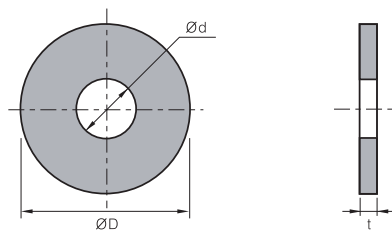

Designation	ØD	Ød	t
ØD×Ød×t	Ø7.2~Ø200	Ø2.7~Ø150	0.8~10

ST Helix blank

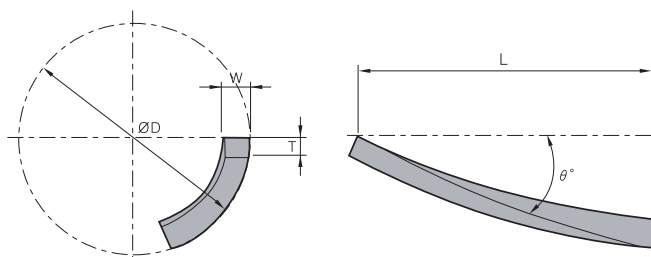

(mm)

Designation	Available endmill (ØD)	L	T	W	θ°	
ST	14	Ø13, 14	30	2.3	4.0	23° 44'
	15	Ø15	30	2.3	4.0	25° 13'
	18	Ø18	32	2.3	4.5	25° 13'
	20	Ø20	32	2.8	5.5	24° 09'
	24	Ø23, 24	37	2.8	5.5	25° 13'
	26	Ø26, 27	37	3.3	6.5	24° 24'
	30	Ø29, 30, 31	42	3.8	7.0	25° 13'
	32	Ø32, 33	47	3.8	7.0	26° 41'
	35	Ø34, 35, 36	52	3.8	7.0	24° 36'
	38	Ø37, 38	57	3.8	7.0	23° 51'
	40	Ø39, 40, 41, 42	62	4.3	7.5	24° 57'
	45	Ø43, 44, 45, 46, 47	67	4.3	7.5	25° 13'
	50	Ø48, 49, 50	67	4.3	7.5	24° 09'

Feed direction	Figure	Designation	A	B	C	(R)	W	H	L	E	F	Available blank	
33 type (Right hand)/34 type (Left hand)													
		33, 34 - 0	10	6	3	0.3	10	10	80	0		04-0	
		1	13	9	3	0.5	13	13	100	4			04-1
		2	16	11	4	0.5	16	16	120	4			04-2
		3	19	13	5	0.5	19	19	140	5			04-3
		4	22	15	6	1	25	25	160	5			04-4
		5	25	17	7	1	25	30	180	5			04-5
		6	30	20	8	1	35	35	200	6			04-6
35 type													
		35 - 0	10	10	3	0.3	10	10	80			07-0	
		1	13	13	3	0.5	13	13	100				07-1
		2	16	16	4	0.5	16	16	120				07-2
		3	18	19	5	0.5	19	19	140				07-3
		4	25	20	6	1	25	25	160				07-4
		5	25	22	7	1	25	30	180				07-5
		6	30	25	8	1	30	35	200				07-6
36 type													
		36 - 0	10	10	3	2	10	10	80			06-0	
		1	13	13	3	2.5	13	13	100				06-1
		2	16	16	4	3	16	16	120				06-2
		3	18	18	5	4	19	19	140				06-3
		4	22	22	6	4	25	25	160				06-4
		5	25	25	7	5	25	30	180				06-5
		6	30	30	8	6	30	35	200				06-6
39 type (Right hand)/40 type (Left hand)													
		39, 40 - 0	10	10	3	2	10	10	80	5		06-0	
		1	13	13	3	2.5	13	13	100	7			06-1
		2	16	16	4	3	16	16	120	10			06-2
		3	19	19	5	4	19	19	140	12			06-3
		4	22	22	6	4	25	25	160	13			06-4
		5	25	25	7	5	25	30	180	15			06-5
		6	30	30	8	6	30	35	200	16			06-6
43 type													
		43 - 1	3	8	3		10	16	100		13	08-1	
		2	3	8	3		13	19	120		16		08-1
		3	4	13	4		16	22	140		20		08-3
		4	5	15	5		18	25	160		25		08-4
		5	6	17	6		22	32	180		30		08-5
		6	8	20	8		25	38	200		40		08-6
		49 type (Right hand)/50 type (Left hand)											
		49, 50 - 1	5	8	3		13	13	100			05-1	
		2	6	10	4		16	16	120				05-2
		3	7	12	5		19	19	140				05-3
		4	9	16	6		25	25	160				05-4

PBX100

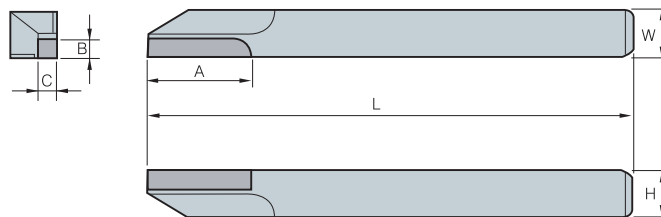

(mm)

Designation		A	B	C	W	H	L
PBX -	105	20	2.0	2.0	5	5	125
	106	20	2.5	2.5	6	6	140
	107	20	3.0	3.0	7	7	150
	108	20	3.0	3.0	8	8	150
	109	20	3.5	3.5	9	9	150
	110	20	4.0	4.0	10	10	150
	112	20	4.0	4.0	12	12	150
	116	20	4.0	4.0	16	16	150











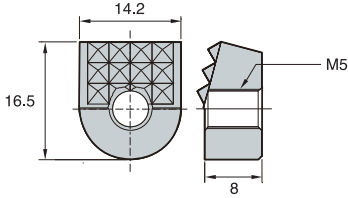

Chuck Jaw **new**

Features

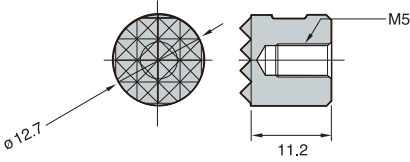
- Chuck Jaw strongly clamps rough workpiece in turning and milling (including MCT)
- Can chuck any types of workpiece

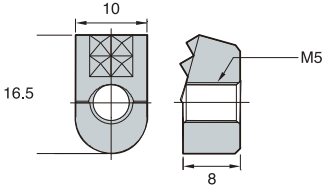
Stock information

Designation	Geometry	Dimension
CJ 04		
CJ 12		
CJ 21		
CJ 22		
CJ 23		
CJ 31		
CJ 32		
CJ 41		
CJ 42		

For taper bits 1000 type

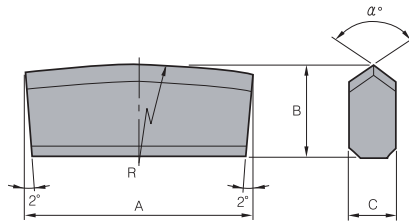

(mm)

Designation	A	B	C	α°	R
1000 - 124	24	10	6	100	80
126	26	10	6	100	80
128	28	10	6	100	80
130	30	10	6	100	80
132	32	10	6	100	80
232	32	10	6	100	80
234	34	12	8	110	120
236	36	12	8	110	120
238	38	12	8	110	120
240	40	12	8	110	120
242	42	12	8	110	120
332	32	14	8	110	120
334	34	14	8	110	120
336	36	14	8	110	120
338	38	14	8	110	120
340	40	14	8	110	120
342	42	14	8	110	120
434	34	15	10	110	120
436	36	15	10	110	120
438	38	15	10	110	120
440	40	15	10	110	120
442	42	15	10	110	120
444	44	15	10	110	120
446	46	15	10	110	120
534	34	18	10	110	120
536	36	18	10	110	120
538	38	18	10	110	120
540	40	18	10	110	120
542	42	18	10	110	120
544	44	18	10	110	120
546	46	18	10	110	120



For cross bits 2000 type

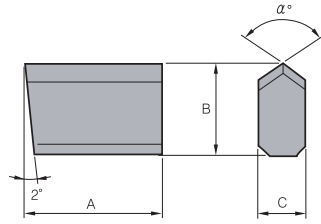

Designation		A	B	C	α°	R
2000 -	110	10	10	6	100	
	111	11	10	6	100	
	112	12	10	6	100	
	113	13	10	6	100	
	114	14	10	6	100	
	115	15	12	6	100	
	210	10	12	6	100	
	211	11	12	6	100	
	212	12	12	6	100	
	213	13	12	6	100	
	214	14	12	6	100	
	215	15	14	8	100	
	312	12	14	8	100	
	313	13	14	8	100	
	314	14	14	8	100	
	315	15	14	8	100	
	316	16	14	8	100	
	317	17	14	8	100	
318	18	14	8	100		

When ordering special items, Please point out the designation, grades, quantity. Available for tailor made

TB For taper bits

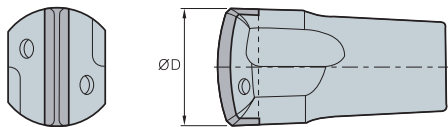

Designation	$\varnothing D$
TB 20	20
32	32
34	34
36	36
38	38
39	39
40	40

TB Boring crown blank

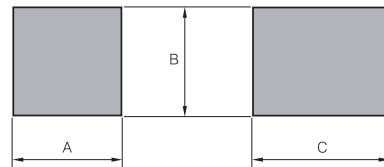

Designation	A	B	C
BT 1	5	5	8
2	6	6	9
3	8	8	10
4	7	10	15

Bits for construction

Configuration	Dimensions	Configuration	Dimensions	Configuration	Dimensions
Earth auger bits		Casing bits		Rod bits	



H Rotating Brazing Tools

Features

- For various applications
- Precise accuracy. Easy to order for special types
- Suitable for small tools. Short delivery time
- Reasonable tool cost. Reusable after sharpening

Cutting process type

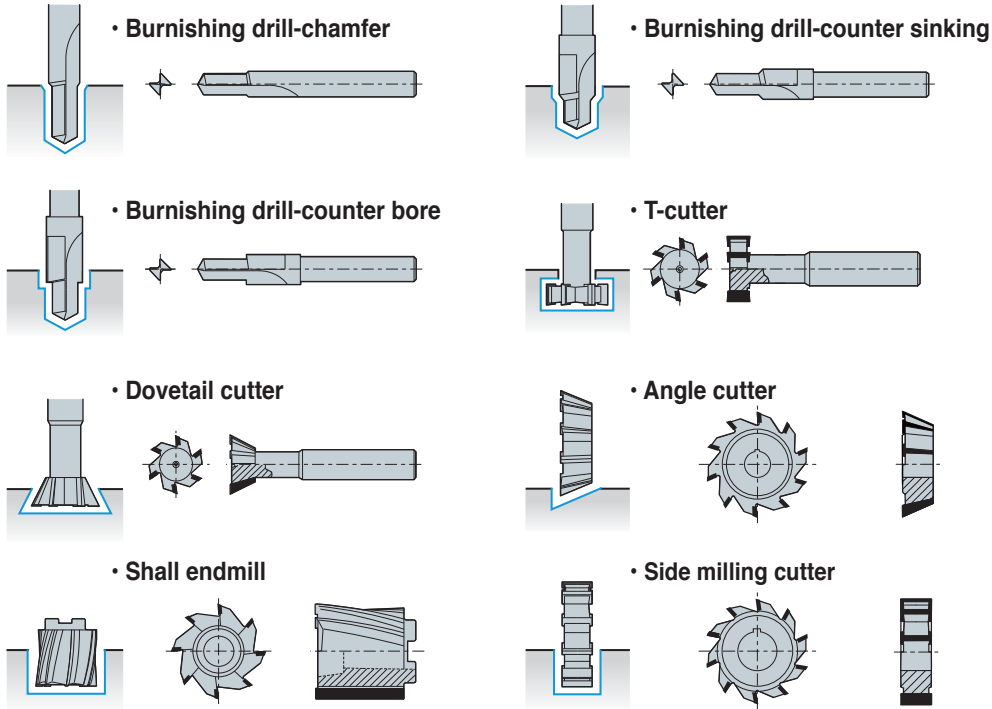

Cutting processes and type

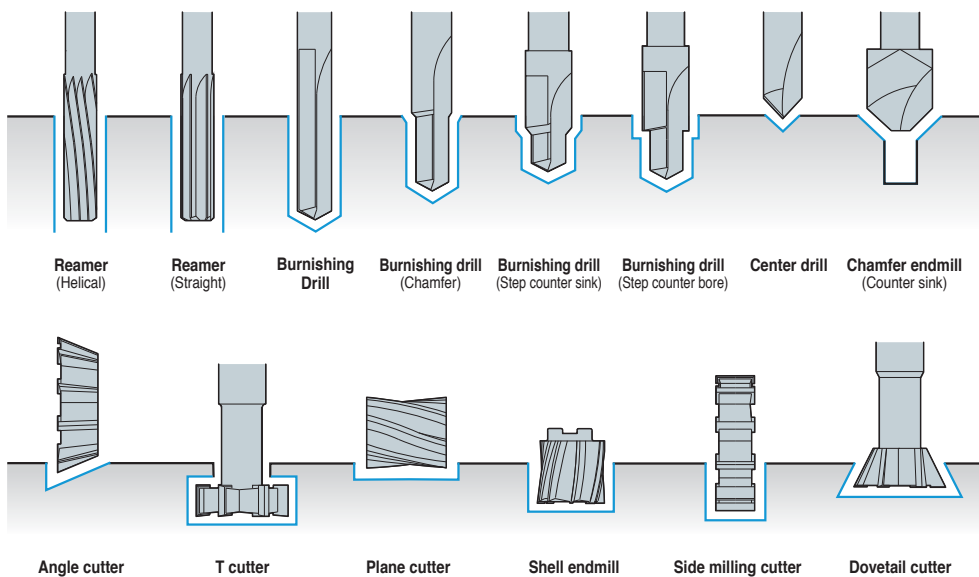

Burnishing Drill-Chamfer

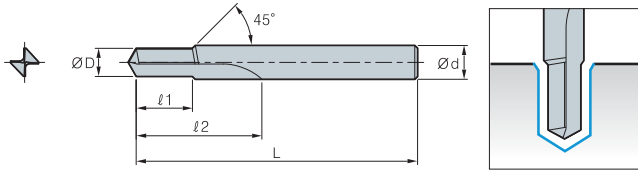

(mm)

Designation	ØD	ℓ ₁	ℓ ₂	L	Ød
BDC					

Dovetail Cutter

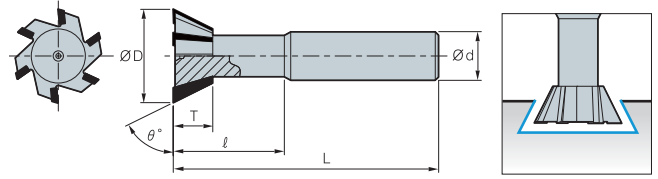

(mm)

Designation	ØD	ℓ	θ°	ℓ ₁	L	Ød	No. of Flute
DC							

Burnishing Drill-Step

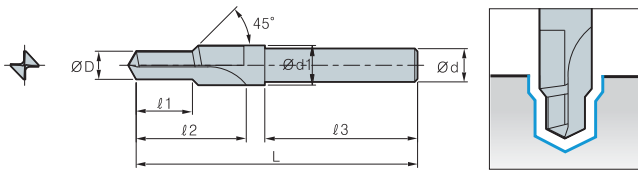

(mm)

Designation	ØD	Ød ₁	ℓ ₁	ℓ ₂	ℓ ₃	L	Ød
BDS							

Angle Cutter

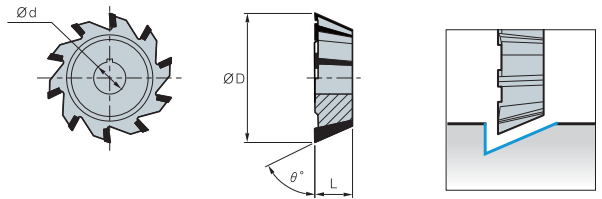

(mm)

Designation	ØD	θ°	Ød	L	No. of Flute
AC					

Burnishing Drill-Counter Bore

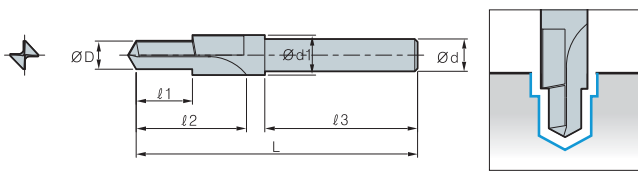

(mm)

Designation	ØD	Ød ₂	ℓ ₁	ℓ ₂	ℓ ₃	L	Ød
BDCB							

Shall Endmill

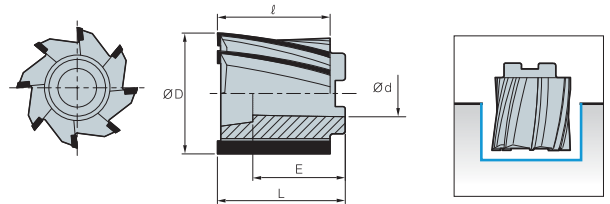

(mm)

Designation	ØD	Ød	ℓ	E	L	No. of Flute
SEM						

T-Cutter

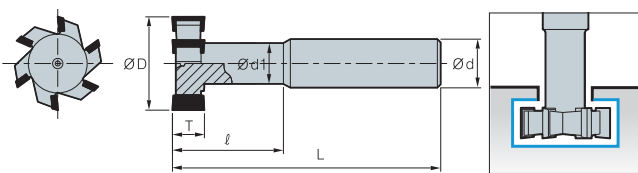

(mm)

Designation	ØD	Ød ₁	T	ℓ	L	Ød	No. of Flute
TC							

Side Milling Cutter

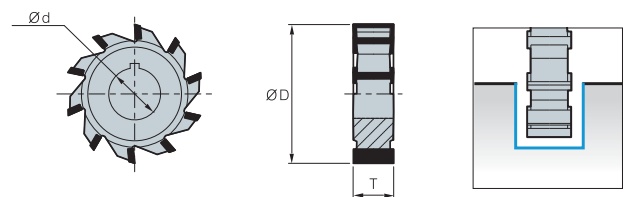

(mm)

Designation	ØD	Ød	T	No. of Flute
SMC				



TOOLING SYSTEM



Tooling System

- I 02 DBT Series
- I 03 HSK Tooling System
- I 04 Balancing System
- I 05 Tooling System Index
- I 06 DHE Series
- I 10 DSC Series
- I 17 CPM Series
- I 19 NPM Series
- I 21 DCS/DC/TC
- I 22 Collet Chuck Series
- I 24 SDC Series
- I 29 GSK Series
- I 31 DSK Series
- I 34 GERC
- I 37 DST Series
- I 39 NPU
- I 40 DTN Series
- I 42 TCA Tap Adaptor
- I 43 TER Tap Collet
- I 44 Side Lock Arbor Series
- I 46 Face Mill Arbor Series
- I 49 Angular Head Series
- I 57 FBH/B Series
- I 61 TBC/FBC Series
- I 64 FBB
- I 65 DBC
- I 66 KMB
- I 67 SMB
- I 68 SMH
- I 69 Modular System
- I 70 Modular Arbor
- I 72 EXT Bar
- I 73 RDC Bar
- I 74 DAMPING PRO
- I 81 Others



DBT Series

For high speed machining

DBT Series

2 face constrained system of taper and shank face for excellent surface roughness and high quality finish in heavy cutting at high speed



Features of 2 face constrained system

- Stable machining can be possible at high speed
- Improvement of tool-life for machine spindle and cutting tool
- Prevention for corrosion of taper portion of both machine spindle and tool holder by heavy duty machining vibration
- Guarantee for the most suitable machining and high accuracy

BT type

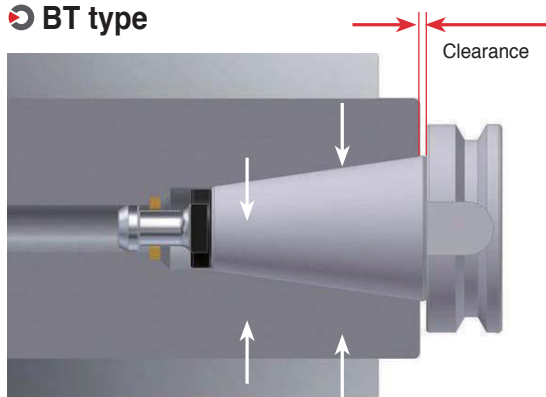

The clearance between spindle and face of shank

DBT type

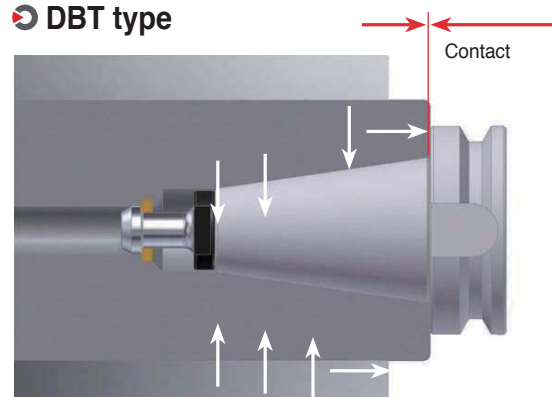

Perfect contact of both faces Better precision/less vibration

Higher stability and precision

Stability and precision increase due to the close contact between taper face and wide external diameter of flange at DBT shank than at BT shank

Shank	Taper	Flange
BT30	Ø31.7	Ø46
BT40	Ø44.4	Ø63
BT50	Ø69.8	Ø100

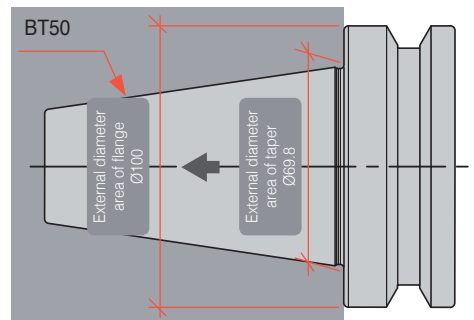

Difference between taper face contact and flange contact at its external diameter

Various models

Tapping	Milling	Face milling	Angular head
 BT-DST	 BT-NPM	 BT-DHE	 BT-FMA
			 BT-KAG



HSK Tooling System

Features of HSK 2 face constrained toolholder

The 7/24 taper shank for multi-purpose has been pointed out that its performance is inappropriate in terms of repeatability, joint stiffness and high speed machining. Drawbacks of 7/24 taper shank had been eliminated by using new two face contact

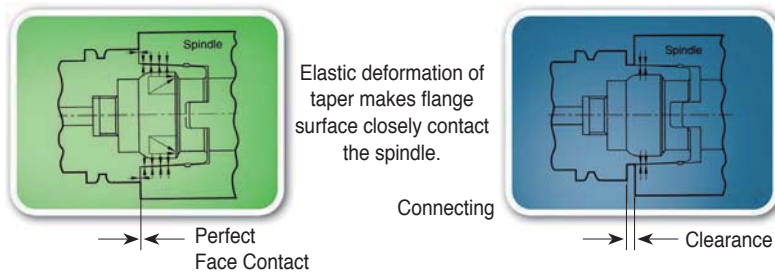

HSK shank -Perfect 2-surface constrained system

Excellent repeatability-run out accuracy

As taper of holder will deform elastically following the profile of the spindle shape, there is no eccentricity between the spindle and the other. Also, due to perfect face contact between flange surface of the holder and spindle face, bending strength of the holder is very high, which makes radial and axial and accuracy very high

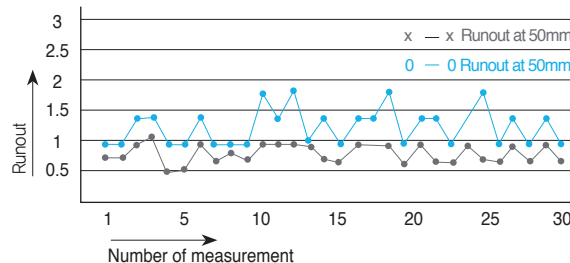
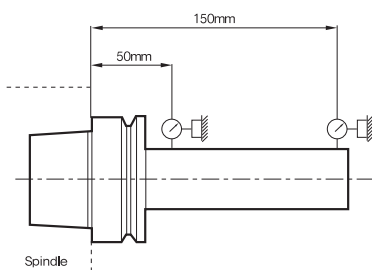

High rigidity against bending load

HSK 63	BT 40

Balancing System

Imbalance

• Cause of imbalance

Imbalance occurs due to the asymmetry of tool geometries and spindle run-out

• Difficulties of imbalance

Shorter tool life, inferior surface roughness and noise are caused by vibration during rotation and damage on spindle bearing

• Need for balancing

Balancing is needed to prevent unbalance for better surface roughness, precision and tool life

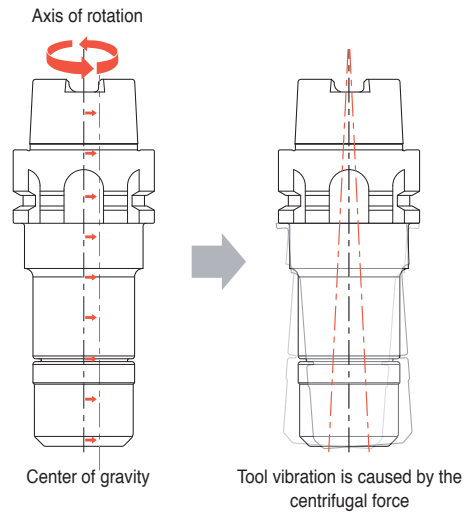

※ A case that the tool's center of gravity deviates from the rotation axis

The most optimal accuracy at high speed

- Without bending from rotation of an unbalanced load, High accuracy and rigidity are maintained
- Excellent Balance ($\leq G1.0$ or $0.5 \text{ g}\cdot\text{mm}/\text{kg}$)
- Tool life, surface finish, dimension of accuracy and productivity can be realized at high speed

Balancing grade standard

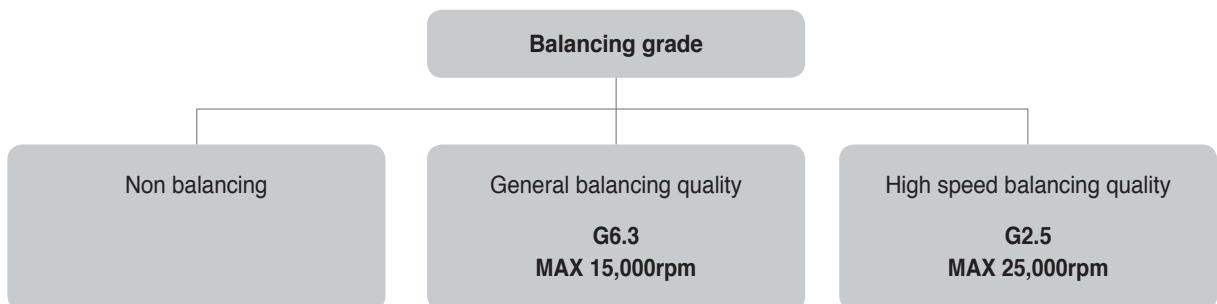

Various balancing quality available



Hydraulic Expansion Chuck  DHE I 17	Shrinking Chuck  DSC I 11	Champion Milling Chuck  CPM I 18	Milling Chuck  NPM I 20
Collet Chuck  SDC I 24	Collet Chuck  SDC/S I 28	High Speed Synchro Slim Chuck  GSK I 29	Collet Chuck  DSK I 32
High Speed Synchro Tapping Chuck  DST I 38	Drill Chuck  NPU I 39	Tap Chuck  DTN I 41	Side Lock Arbor  SLA I 44
Face Mill Arbor  FMA, FMC I 46	Angular Head Series  MAH I 51	Angular Head Series  HRAG I 52	Angular Head Series  KHU I 53
Angular Head Series  KAG I 54	Angular Head Series  KAH I 55	Angular Head Series  KAC I 56	Boring Tool  FBH/B I 58
Boring Tool  TBC, FBC I 63	Boring Tool  DBC I 65	Boring Tool  KMB I 66	Boring Tool  SMB I 67
Boring Tool  SMH I 68	Modular System Arbors  MD I 70	Modular System Extension Bar  EXT I 72	Modular System Reducer Bar  RDC I 73
DAMPING PRO  FMA/FMC I 76			



Technical Information for DHE

Hydraulic expansion chuck

DHE Series

- Ideal for mold making and machining automobile components & precise parts due to high precision machining
- Improved surface roughness due to vibration proof by hydraulic chamber
- Reduced replacement time and tiredness of worker with the use of T wrench for removal
- Applicable shank diameter: Ø3-32



Code system



Features

High accuracy provides long tool life due to reduced wear and hydraulic room enhances a surface roughness by lessening vibrations

- RUN OUT: under 5 μm
- L = 3 x ØD
- Shank: Tolerance of ØD : h6

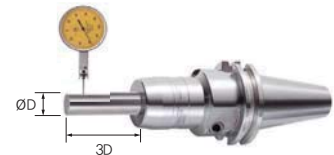

Internal sealing structure (Durability)

- Internal sealing system protects the chuck against dust, cutting oil, lubricant and chips getting into it
- Maintaining clamping force and accuracy for a long time

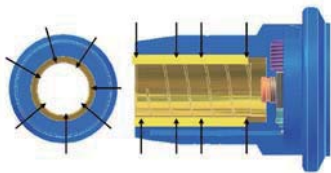

With simple t-wrench, very easy to change a tool

- Clamping structure for easy operation (Convenience)
- Decrease of worker's fatigue
- Improving machine capacity



Shank	Grade	Max.rpm
BT50, SK50, HSK100A	G6.3	10,000
BT40, SK40, HSK63A		15,000
BT30, HSK50A, SK30		20,000
HSK40A	-	25,000

Stable clamping

The clearance between holder and tool is fixed by hydraulic pressure



BT-DHE

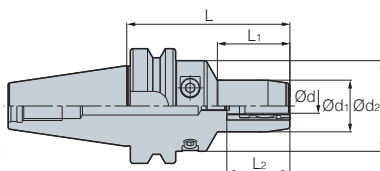

Fig. 1

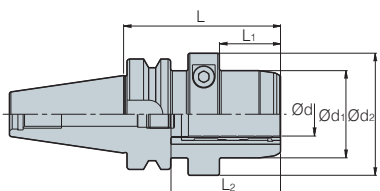

Fig. 2

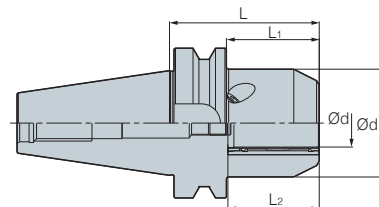
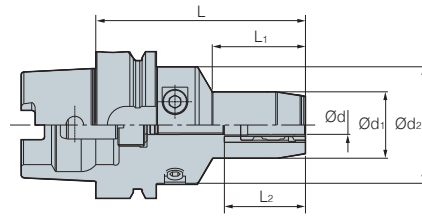

Fig. 3

Designation		Ød	L	Ød ₁	Ød ₂	L ₁	L ₂	Adjust screw	Fig.	kg	
BT30 -	DHE 6 - 65	6	65	29	45	33	30~39.8	M5	1	0.7	
	DHE 8 - 65	8	65	31	45	33	30~39.8	M5	1	0.7	
	DHE 10 - 65	10	65	32	45	34	35~44.8	M5	1	0.7	
	DHE 12 - 65	12	65	35	45	34	41~50.8	M5	1	0.7	
	DHE 14 - 90	14	90	36	45	40	43~52.8	M5	1	0.9	
	DHE 16 - 90	16	90	40	45	45	46~55.8	M5	1	1.0	
	DHE 18 - 90	18	90	42	45	40	49~58.8	M5	1	1.0	
	DHE 20 - 90	20	90	44	45	45	49~58.8	M5	1	1.1	
BT40 -	DHE 6 - 90	6	90	29	50	40	30~39.8	M5	1	1.4	
	140	6	140	29	50	40	30~39.8	M5	1	2.2	
	DHE 8 - 90	8	90	31	50	40	30~39.8	M5	1	1.4	
	140	8	140	31	50	40	30~39.8	M5	1	2.2	
	DHE 10 - 90	10	90	33	50	40	35~44.8	M5	1	1.5	
	140	10	140	33	50	40	35~44.8	M5	1	2.2	
	DHE 12 - 90	12	90	35	50	40	41~50.8	M10	1	1.5	
	140	12	140	35	50	40	41~50.8	M10	1	2.3	
	DHE 14 - 90	14	90	36	50	40	43~52.8	M10	1	1.5	
	140	14	140	36	50	40	43~52.8	M10	1	2.3	
	DHE 16 - 90	16	90	40	50	45	46~55.8	M10	1	1.5	
	140	16	140	40	50	45	46~55.8	M10	1	2.3	
	DHE 18 - 90	18	90	42	50	45	49~58.8	M10	1	1.5	
	140	18	140	42	50	45	49~58.8	M10	1	2.3	
	DHE 20 - 90	20	90	44	50	47	49~58.8	M10	1	1.5	
	140	20	140	44	50	47	49~58.8	M10	1	2.3	
	DHE 25 - 90	25	90	50	70	35	58~67.8	M16	2	1.9	
	DHE 32 - 90	32	90	63	80	35	58~67.8	M16	2	2.0	
	BT50 -	DHE 6 - 90	6	90	29	50	34	30~39.8	M5	1	3.9
		140	6	140	29	50	40	30~39.8	M5	1	4.5
DHE 8 - 90		8	90	31	50	34	30~39.8	M5	1	3.9	
140		8	140	31	50	40	30~39.8	M5	1	4.5	
DHE 10 - 90		10	90	33	50	34	35~44.8	M5	1	3.9	
140		10	140	33	50	34	35~44.8	M5	1	4.5	
DHE 12 - 90		12	90	35	50	34	41~50.8	M10	1	4.0	
140		12	140	35	50	34	41~50.8	M10	1	4.6	
DHE 14 - 90		14	90	36	50	34	43~52.8	M10	1	4.0	
140		14	140	36	50	34	43~52.8	M10	1	4.6	
DHE 16 - 90		16	90	40	50	34	46~55.8	M10	1	4.1	
140		16	140	40	50	34	46~55.8	M10	1	4.7	
DHE 18 - 90		18	90	42	50	40	49~58.8	M10	1	4.1	
140		18	140	42	50	45	19~58.8	M10	1	4.7	
DHE 20 - 90		20	90	44	50	34	49~58.8	M10	1	4.2	
140		20	140	44	50	47	49~58.8	M10	1	4.7	
DHE 25 - 90		25	90	66	-	52	58~67.8	M16	3	4.7	
DHE 32 - 90		32	90	72	-	52	58~67.8	M16	3	4.8	



HSK-DHE



(mm)

Designation	Ød	L	Ød ₁	Ød ₂	L ₁	L ₂	Adjust Screw		
HSK63A -	DHE 6 - 75	6	75	29	50	34	30~39.8	M5	1.0
	DHE 8 - 75	8	75	31	50	34	30~39.8	M5	1.0
	DHE 10 - 85	10	85	33	50	40	35~44.8	M5	1.2
	DHE 12 - 90	12	90	35	50	40	41~50.8	M5	1.2
	DHE 16 - 95	16	95	40	50	45	46~55.8	M10	1.3
	DHE 20 - 100	20	100	44	50	50	49~58.8	M10	1.4
	150	20	150	44	50	50	49~58.8	M10	2.0
HSK100A -	DHE 20 - 105	20	105	44	50	50	49~58.8	M10	2.8
	DHE 25 - 115	25	115	50	63	62	58~67.8	M16	3.3
	DHE 32 - 115	32	115	63	75	62	58~67.8	M16	3.8

• L₂ : Insertion depth of tool (Min.-max.) • Through coolant system is optional

DHC Collet (General type)

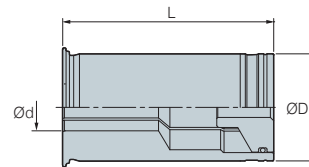

(mm)

Designation	ØD	Ød	L
DHC12 - 3, 4, 5, 6, 8	12	3, 4, 5, 6, 8	47
DHC20 - 3, 4, 5, 6, 8, 10, 12, 14, 16	20	3, 4, 5, 6, 8, 10, 12, 14, 16	52
DHC32 - 6, 8, 10, 12, 14, 16, 18, 20, 25	32	6, 8, 10, 12, 14, 16, 18, 20, 25	63



DHC Collet (Accuracy type)

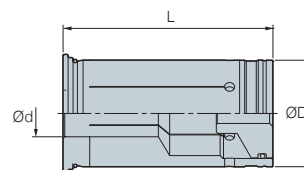

(mm)

Designation	ØD	Ød	L
DHC12 - 3(P), 4(P), 5(P), 6(P), 8(P)	12	3, 4, 5, 6, 8	47
DHC20 - 3(P), 4(P), 5(P), 6(P), 8(P), 10(P), 12(P), 14(P), 16(P)	20	3, 4, 5, 6, 8, 10, 12, 14, 16	52
DHC32 - 6(P), 8(P), 10(P), 12(P), 14(P), 16(P), 18(P), 20(P), 25(P)	32	6, 8, 10, 12, 14, 16, 18, 20, 25	63

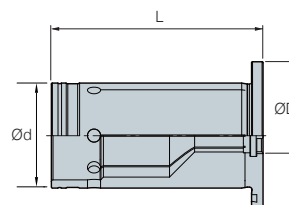

DHJ Collet (Jet coolant)



(mm)

Designation	ØD	Ød	L
DHJ20 - 6, 8, 10, 12, 14, 16	20	6, 8, 10, 12, 14, 16	50

Parts

Spare Parts					
Chuck		Clamp screw	Wrench	Chuck	Adjust screw
Type				Type	
BT30/SK30/HSK50	DHE 6, 8, 10, 12	DHE-M8 (C)	DHETW-4	DHE 6, 8, 10	DHE-M5 (ADJ)
	DHE 14, 16, 18, 20	DHE-M10 (C)	DHETW-5		
BT40/BT50/SK40/SK50 HSK63A/HSK100A	DHE 6, 8, 10, 12, 14, 16, 18, 20	DHE-M10 (C)	DHETW-5	DHE 12, 14, 16, 18, 20	DHE-M10 (ADJ)
	DHE 25, 32	DHE-M12 (C)	DHETW-6	DHE 25, 32	DHE-M16 (ADJ)



Technical Information for DSC

Shrinking chuck

DSC

- Use of specially heat-treated steel
- High precision machining and clamping
- Increased precision and longer tool life due to minimized overhang when machining deep grooves
- Applicable shank diameter: $\varnothing 3-32$



Code System

BT50 - DSC		6	- S -	165	- S
Shank type	Holder type	Tool Dia.	Type	Length	Special
BT, HSK, SK, ST, CS, CM	DSC: Shrinking chuck SLK: 2piece holder Collet		S: Slim M: Middle NON: General		S: Curve type NON: General

Mono curve type

- Integral DSC with excellent precision and balancing
- Long but stable holder design



Symmetric design

- High clamping force



High clamping force

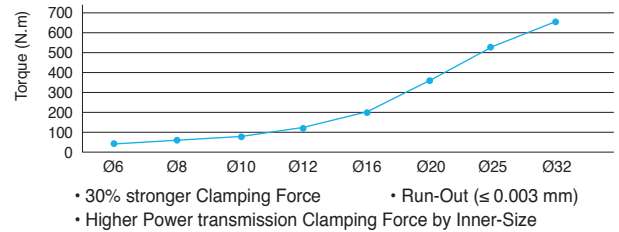

Shrinking chuck

Fix the clearance between holder and tool by heat shrinking

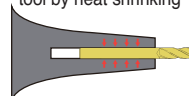

Thermal expansion \rightarrow Thermal shrinking
Highly strong clamping

Collet chuck

Fix the tool by elasticity of collet

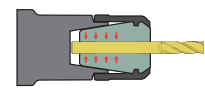

Elastic deformation
Strong clamping

Mono type

Figure	Accuracy
<p>3° taper Thickness t</p>	<p>Run-out 3 μm</p>
<p>Slim type \rightarrow 1.5t</p> <p>Middle type \rightarrow 2~4.5t</p>	

2-pieces type

Figure	Accuracy
<p>Holder Collet Bolt 3° taper Thickness t</p>	<p>Run-out 5 μm</p>
<p>Slim type \rightarrow 1.5t</p> <p>Middle type \rightarrow 2~3.5t</p>	



BT-DSC

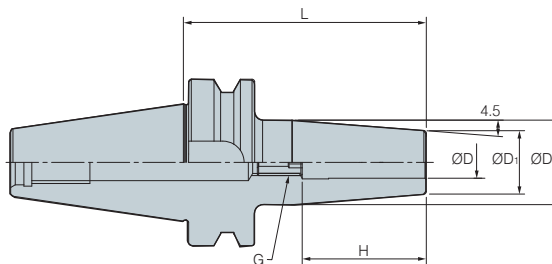

(mm)

Designation	ØD	L	ØD ₁	ØD ₂	H	G	kg	MAX RPM	
BT30 -	DSC3 - 60	3	60	11	18.5	82	-	0.6	25,000
	DSC4 - 60	4	60	13	20.5	82	-	0.6	25,000
BT40 -	DSC6 - 90	6	90	21	27	36	M5	1.2	20,000
	120	6	120	21	27	36	M5	1.2	20,000
	160	6	160	21	27	36	M5	1.4	20,000
	DSC8 - 90	8	90	21	27	36	M5	1.2	20,000
	120	8	120	21	27	36	M5	1.2	20,000
	160	8	160	21	27	36	M5	1.4	20,000
	DSC10 - 90	10	90	24	32	42	M8	1.2	20,000
	120	10	120	24	32	42	M8	1.2	20,000
	160	10	160	24	32	42	M8	1.6	20,000
	DSC12 - 90	12	90	24	32	47	M8	1.2	20,000
	120	12	120	24	32	47	M8	1.2	20,000
	160	12	160	24	32	47	M8	1.6	20,000
	DSC16 - 90	16	90	27	34	50	M12	1.3	20,000
	120	16	120	27	34	50	M12	1.3	20,000
	160	16	160	27	34	50	M12	1.7	20,000
	DSC20 - 90	20	90	33	42	52	M12	1.3	20,000
	120	20	120	33	42	52	M12	1.5	20,000
	160	20	160	33	42	52	M12	2.1	20,000

Adjust screw I16

• Through coolant system available

BT-DSC/M

Mono Curve type

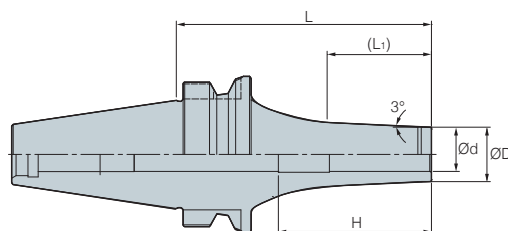

(mm)

Designation	ØD	L	L ₁	ØD ₁	ØC ₁	H	G	kg	MAX RPM	
BT30 -	DSC3M - 75S	3	75	29.8	8	25	97	-	0.6	25,000
	DSC4M - 75S	4	75	31.8	10	25	97	-	0.6	25,000
	DSC6M - 75S	6	75	28.9	12	30	97	-	0.6	25,000
	DSC8M - 75S	8	75	28.9	14	32	97	-	0.6	25,000
	DSC10M - 75S	10	75	30.66	16	32	45	-	0.6	25,000

• Not able to use the adjust screw • Through coolant system available



BT-DSC/M

Mono type

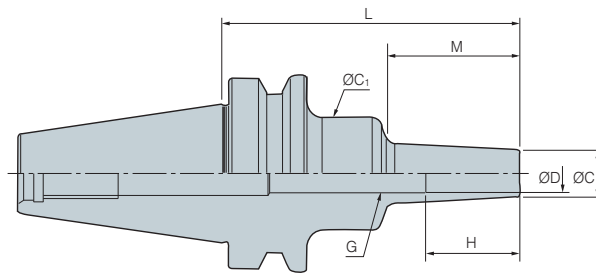

(mm)

Designation	ØD	L	ØD ₁	ØC ₁	M	H		
BT40 -	DSC6M - 95	6	95	10	26	42	18	1.2
	120	6	120	10	26	67	18	1.2
	160	6	160	10	36	97	18	1.5
	DSC8M - 95	8	95	13	36	42	24	1.2
	120	8	120	13	36	67	24	1.2
	160	8	160	13	36	97	24	1.5
	DSC10M - 95	10	95	16	36	42	30	1.2
	120	10	120	16	36	67	30	1.2
	160	10	160	16	36	97	30	1.5
	DSC12M - 95	12	95	19	36	42	30	1.2
	120	12	120	19	36	67	30	1.2
	160	12	160	19	36	97	30	1.5
	DSC16M - 95	16	95	24	50	42	32	1.2
	120	16	120	24	50	67	32	1.2
	160	16	160	24	50	97	32	1.5
DSC20M - 95	20	95	29	50	42	40	1.2	
120	20	120	29	50	67	40	1.2	
160	20	160	29	50	97	40	1.5	
BT50 -	DSC6M - 110	6	110	10	26	42	18	3.5
	160	6	160	10	36	97	18	4
	DSC8M - 110	8	110	13	36	42	24	3.5
	160	8	160	13	36	97	24	4
	DSC10M - 110	10	110	16	36	42	30	3.5
	160	10	160	16	36	97	30	4
	DSC12M - 110	12	110	19	36	42	30	3.5
	160	12	160	19	50	97	30	4
	DSC16M - 110	16	110	24	50	42	32	3.5
	160	16	160	24	50	97	32	4
	DSC20M - 110	20	110	29	50	42	40	3.5
	160	20	160	29	50	97	40	4

 Adjust screw I 16

• Through coolant system available



BT-DSC/S

Mono Slim type

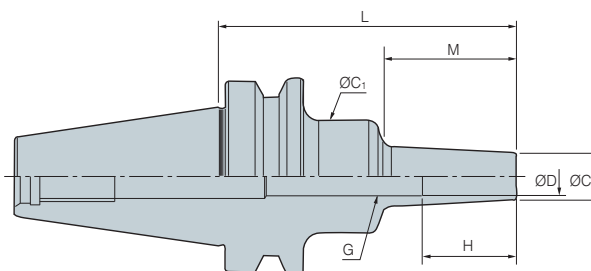

(mm)

Designation		ØD	L	ØD ₁	ØC ₁	M	H
BT30 -	DSC6S - 60	6	60	9	20	22	18
	80	6	80	9	20	42	18
	120	6	120	9	25	67	18
BT40 -	DSC6S - 95	6	95	9	26	42	18
	120	6	120	9	26	67	18
	160	6	160	9	36	97	18
	DSC8S - 95	8	95	11	36	42	24
	120	8	120	11	36	67	24
	160	8	160	11	36	97	24
	DSC10S - 95	10	95	13	36	42	30
	120	10	120	13	36	67	30
	160	10	160	13	36	97	30
	DSC12S - 95	12	95	15	36	42	30
	120	12	120	15	36	67	30
	160	12	160	15	36	97	30
BT50 -	DSC6S - 110	6	110	9	26	42	18
	160	6	160	9	36	97	18
	DSC8S - 110	8	110	11	36	42	24
	160	8	160	11	36	97	24
	DSC10S - 110	10	110	13	36	42	30
	160	10	160	13	36	97	30
	DSC12S - 110	12	110	15	36	42	30
	160	12	160	15	36	97	30

• Not able to use the adjust screw • Through coolant system available



BT-SLK

2-pieces type

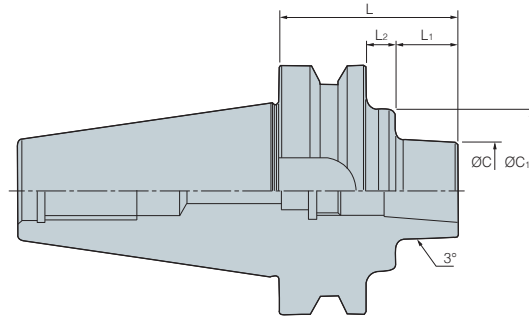

(mm)

Designation			L	ØC	L ₁	L ₂	ØC ₁
BT30 -	SLK12 -	35	35	38	13	-	-
BT40 -	SLK12 -	45	45	38	18	-	-
	45F	45	41	18	-	-	
	75	75	38	48	-	-	
	75F	75	41	48	-	-	
	135F	135	41	108	-	-	
BT50 -	SLK12 -	75	75	38	25	12	65
	75F	75	41	25	12	65	
	105F	105	41	55	12	65	
	135F	135	41	85	12	65	
	225	225	38	150	37	65	
	315	315	38	150	127	90	

Adjust screw I 16

• Through coolant system available • PULL STUD BOLT is needed for BT30-SLK12-35



CS/CM

2-pieces type

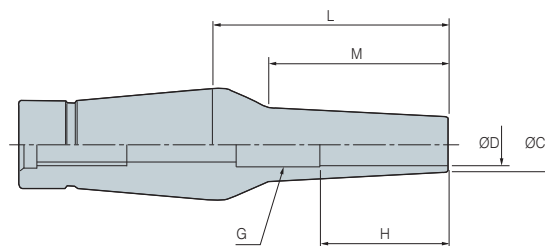

(mm)

Designation			ØD	ØC	L	M	H
CS12 -	6 -	36	6	9	35	22	18
		55	6	9	55	42	18
		80	6	9	80	67	18
		110	6	9	110	97	18
	8 -	35	8	11	35	22	24
		55	8	11	55	42	24
		80	8	11	80	67	24
		110	8	11	110	97	24
	10 -	35	10	13	35	22	30
		55	10	13	55	42	30
		80	10	13	80	67	30
		110	10	13	110	97	30
12 -	35	12	15	35	22	30	
	55	12	15	55	42	30	
	80	12	15	80	67	30	
	110	12	15	110	97	30	

• Not able to use the adjust screw • Through coolant system available

(mm)

Designation			ØD	ØC	L	M	H
CM12 -	6 -	35	6	12	35	22	18
		55	6	12	55	42	18
		80	6	12	80	67	18
	8 -	35	8	14	35	22	24
		55	8	14	55	42	24
		80	8	14	80	67	24
	10 -	35	10	16	35	22	30
		55	10	16	55	42	30
		80	10	16	80	67	30
	12 -	35	12	20	35	22	30
		55	12	20	55	42	30
		80	12	20	80	67	30

↻ Adjust screw I 16

• Through coolant system available



HSK-DSC/M

Mono type

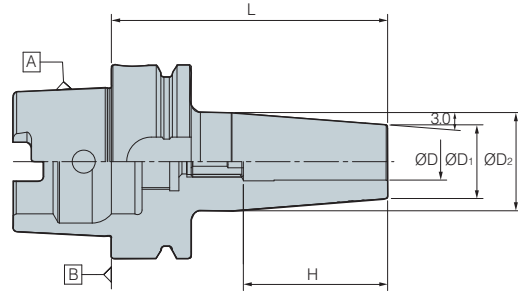

(mm)

Designation	ØD	L	ØD ₁	ØC ₁	M	H	
HSK63A -	DSC6M - 95	6	95	10	26	42	18
	DSC8M - 95	8	95	13	36	42	24
	DSC10M - 120	10	120	16	36	67	30
	DSC12M - 120	12	120	19	36	67	30
	DSC16M - 120	16	120	24	50	67	32

• Not able to use the adjust screw • Through coolant system is optional

Parts

Spare parts										
Type	DSC6	DSC8	DSC10	DSC12	DSC14	DSC16	DSC18	DSC20	DSC25	DSC32
Adjust screw 	M520C		M820C					M1230C		



Champion milling chuck

CPM

- Improved tool life by blocking dust and lubricant leaking with perfect sealing structure on O-ring and Nut
- Available through coolant system with CTC set
- Length regulator is inserted in CPM, user can adjust length conveniently



Code system

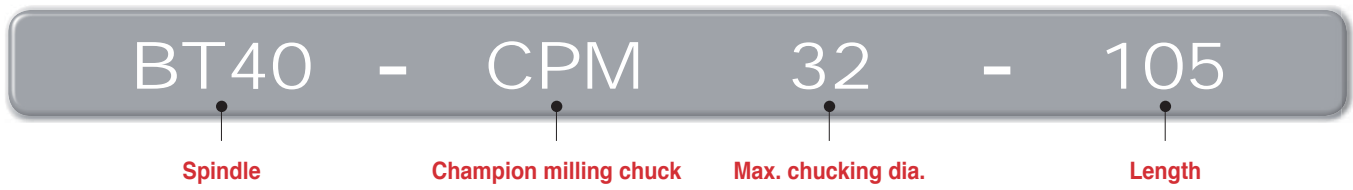

Prevention of grease leak and dust proof

CPM has O-Ring on nuts to absorb cutting vibration for stable operation and prevents inflow of debris

Face contact for stable machining and dust proof

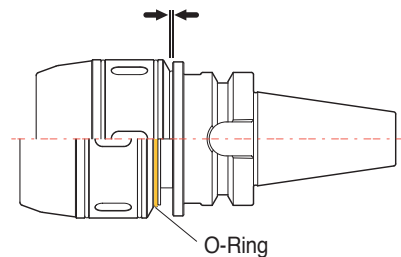

Correlation of oil leaking and tool life

Obvious increase of tool life after applying dust proof system

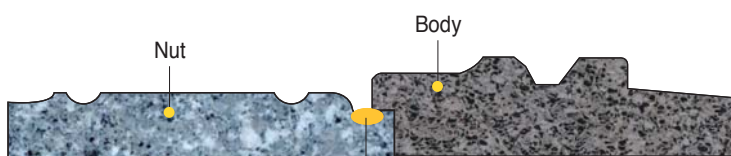

O-Ring: Blocking lubricant leakage and dust entry → Enhanced tool life

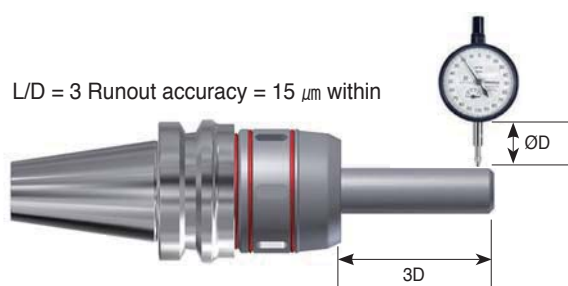
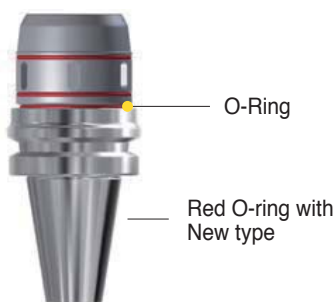
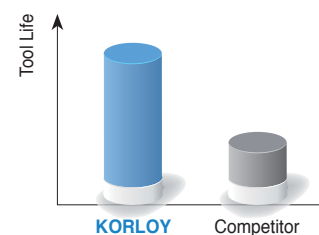

BT-CPM

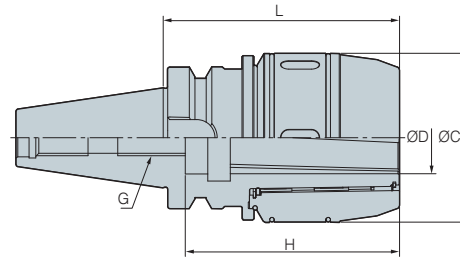

(mm)

Designation		ØD	L	ØC	H	G	Collet	
BT30 -	CPM20 - 80	20	80	54	80	M16	DC20, DSC20	1.1
BT40 -	CPM20 - 90	20	90	54	80	M16	DC20, DSC20	2.3
	CPM32 - 90	32	90	75	85	M16	DC32, DCS32	2.8
	105	32	105	75	95	M16	DC32, DCS32	2.9
BT50 -	CPM32 - 105	32	105	75	95	M24	DC32, DCS32	5.0
	135	32	135	75	95	M24	DC32, DCS32	5.8
	165	32	165	75	95	M24	DC32, DCS32	6.8

• Order-made sets available • Through coolant system is optional



New power milling chuck

NPM

- Strong clamping over 500kgf·m (on NPM42 basis)
- DUST BLOCK functions for blocking foreign substance
- Jet coolant available
- High precision within 15 μ m at L/D = 3
- Applicable shank diameter: D6-42



Code system



Improvement of durability by preventing minute dust, chips and coolant

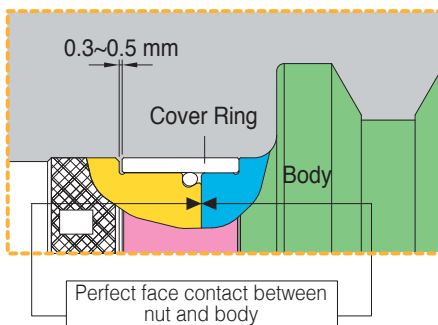

- Adopted Stop Ring on Head parts
- Preventing minute dust by Shim&O-Ring

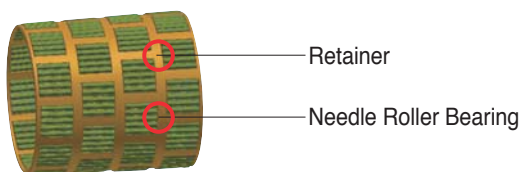

- Specially designed Steel Bearing for prevention of damage
- Strong Clamping by spreading the force



Stable machining from heavy to fine

Perfect face contact and Powerful clamping force strengthen both Cutting force and Absorbtion of vibration.

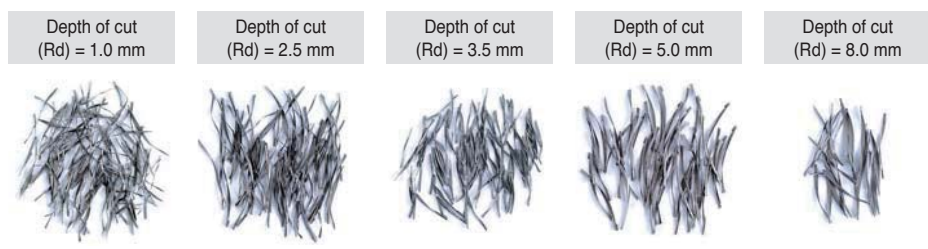

Possible machining from heavy milling to fine finishing



BT-NPM

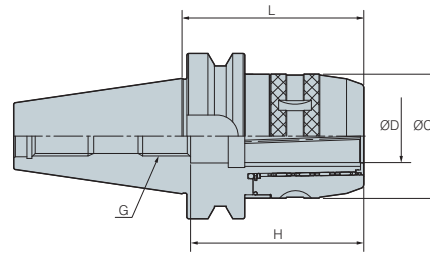

(mm)

Designation	ØD	L	ØC	H	G	Collet	
BT30 - NPM20 - 85	20	85	54	85	M16	DC20, DSC20	1.1
BT40 - 85	20	85	54	85	M16	DC20, DSC20	2.3
100	20	100	54	85	M16	DC20, DSC20	2.3
NPM25 - 85	25	85	61	85	M16	DC25, DSC25	2.5
NPM32 - 90	32	90	75	87	M16	DC32, DCS32	2.8
110	32	110	75	95	M16	DC32, DCS32	2.9
135	32	135	75	95	M16	DC32, DCS32	3.5
BT50 - NPM20 - 95	20	95	54	85	M24	DC20, DSC20	4.3
125	20	125	54	85	M24	DC20, DSC20	4.8
165	20	165	54	85	M24	DC20, DSC20	5.3
NPM32 - 110	32	110	75	105	M24	DC32, DCS32	5.0
135	32	135	75	105	M24	DC32, DCS32	5.8
165	32	165	75	105	M24	DC32, DCS32	6.8
NPM42 - 110	42	110	90	125	M24	DC42, DCS42	5.4
135	42	135	90	125	M24	DC42, DCS42	6.6
165	42	165	90	125	M24	DC42, DCS42	8.0

 Applicable collet I21

• Through coolant system available is optional

• In case of $L \leq 90$, chucks with over 90mm are recommended for medium cutting by short cap

HSK-NPM

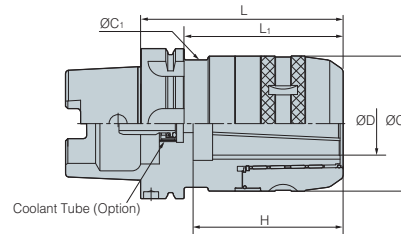



(mm)

Designation	ØD	L	L ₁	ØC	Collet	
HSK63A - NPM20 - 100	20	95	54	75	DC20, DSC20	1.1
NPM32 - 120	42	135	90	90	DC42, DCS42	6.6
HSK100A - NPM32 - 130	42	165	90	90	DC42, DCS42	8.0

 Applicable collet I21

• Through coolant system is optional

Parts

Division	Spare parts		
	Option		
	Collet	Spanner	Through coolant system
Type			
NPM20	DC20, DCS20	57-60	CTC20-20
NPM32	DC32, DCS32	75-79	CTC32-32
NPM42	DC42, DCS42	92-96	CTC42-42



DCS Straight Collet

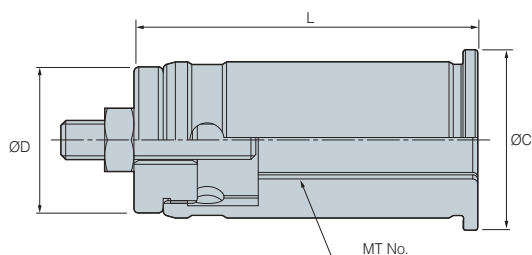

Designation	ØD	Ød	ØC	L	kg
DCS20 - 6, 8, 10, 12, 16	20	6, 8, 10, 12, 16	26	55	0.2
DCS25 - 6, 8, 10, 12, 16, 20	25	6, 8, 10, 12, 16, 20	29	66.5	0.3
DCS32 - 6, 8, 10, 12, 14, 16, 19, 20, 25	32	6, 8, 10, 12, 14, 16, 19, 20, 25	38	70	0.4
DCS42 - 6, 8, 10, 12, 16, 20, 25, 32	42	6, 8, 10, 12, 16, 20, 25, 32	48	75	0.7

DC Straight Collet

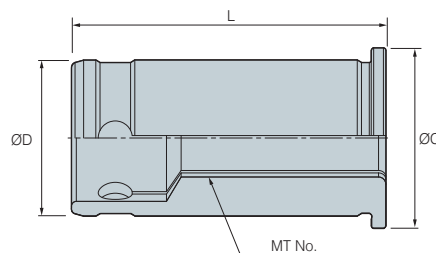

Designation	ØD	Ød	ØC	L	kg
DC20 - 6, 8, 10, 12, 14, 16	20	6, 8, 10, 12, 14, 16	26	55	0.2
DC25 - 6, 8, 10, 12, 16, 20	25	6, 8, 10, 12, 16, 20	29	61.5	0.3
DC32 - 6, 8, 10, 12, 14, 16, 19, 20, 25	32	6, 8, 10, 12, 14, 16, 19, 20, 25	38	70	0.4
DC42 - 6, 8, 10, 12, 16, 20, 25, 32	42	6, 8, 10, 12, 16, 20, 25, 32	48	75	0.7

TC Taper Collet

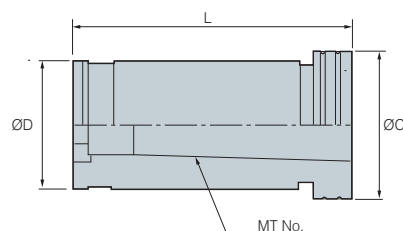

Designation	MT No.	ØD	ØC	L
TC20 - 1	MT1	20	26	60
TC20 - 2	MT2	20	26	72
TC25 - 1	MT1	25	32	60
TC25 - 2	MT2	25	32	72
TC32 - 1	MT1	32	38	60
TC32 - 2	MT2	32	38	72

Designation	MT No.	ØD	ØC	L
TC32 - 3	MT3	32	38	90
TC42 - 1	MT1	42	48	60
TC42 - 2	MT2	42	48	72
TC42 - 3	MT3	42	48	90
TC42 - 4	MT4	42	48	112.5





Collet Chuck Series

- High Accuracy and Powerful clamping force
- Convenient tool change
- Various models
- Chucking Diameter $\varnothing 1.0\sim\varnothing 26.0\text{mm}$



Collet Chuck Series

Collet chuck	High speed collet chuck	High speed slim collet chuck
		
<p>SDC/P</p> <ul style="list-style-type: none"> - Max. Chucking dia.: $\varnothing 26.0\text{ mm}$ - For use of drilling, Reaming, Endmilling and tapping etc 	<p>DSK</p> <ul style="list-style-type: none"> - Max. Chucking dia.: $\varnothing 25.0\text{ mm}$ - Balanced G6.3 - Max. Revolution: 15,000 rpm 	<p>GSK</p> <ul style="list-style-type: none"> - Max. Chucking dia.: $\varnothing 25.0\text{ mm}$ - Balanced G2.5 - Max. Revolution: 25,000 rpm

High Precision Collet

- Accuracy type: $5\ \mu\text{m}$ (GER-B)
- High accuracy type: $2\ \mu\text{m}$ (GER-HP)
- Through Coolant type



- Accuracy type
- High accuracy type



- Through Coolant type



Collet chuck

SDC/P

- ER collet chuck, standard type for general machining
- Applicable shank diameter: $\varnothing 1.0\sim 26.0$

➤ **First-class nut (SWISS Made )**



Easy clamping of collets



Special hardening treatment



For SDC/P
(General machining)



High speed collet chuck

DSK

- Available for machining at max.15,000RPM and balancing of G6.3
- Minimized tool vibration during operation by using collet 8°
- Swiss made high precision nut enhances stability
- Applicable shank diameter: $\varnothing 1.8\sim 25$



Standard type & Precision type	Designation	Arbor	Max chucking	Run-out
	HC6- $\varnothing d$	10.5	6.0	Standard type 5 μm
	HC10- $\varnothing d$	15.5	10.0	
	HC13- $\varnothing d$	20.1	13.0	
	HC16- $\varnothing d$	24.6	16.0	Precision type 3 μm
	HC20- $\varnothing d$	29.1	20.0	
	HC25- $\varnothing d$	35.6	25.0	

8° HC collet



Minimized tool vibration during operation

Great speed slim collet chuck

GSK

- Available for machining at max.25,000RPM and balancing of G6.3
- Increased productivity due to high speed machining
- Minimized tool vibration during operation by using collet 8°
- Swiss made high precision nut enhances stability by pressing collet uniformly
- Applicable shank diameter: $\varnothing 1.8\sim 25$



➤ **Original design**

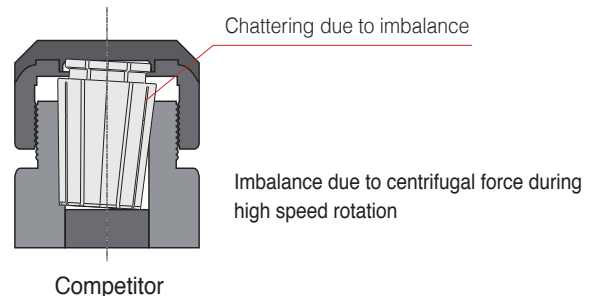
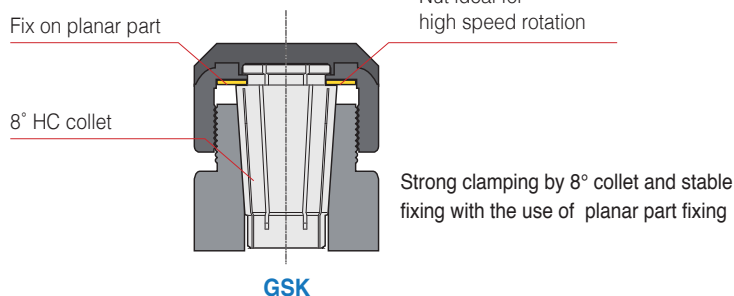

BT-SDC/P

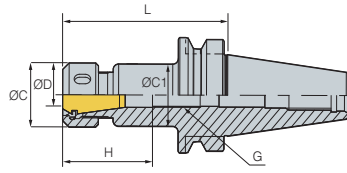

Fig. 1

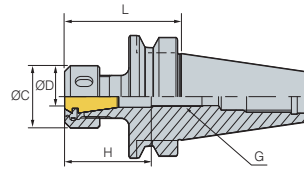

Fig. 2

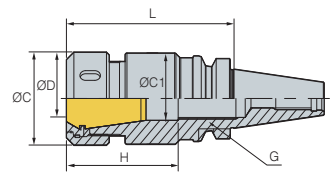

Fig. 3

(mm)

Designation	ØD	L	H	Collet/Step	G	ØC	ØC ₁	Fig.	
BT30 -	SDC7P - 70	1.0~7.0	70	33	GERC11/0.5	M7	18	17	1
		100	100	33	GERC11/0.5	M7	18	17	1
	SDC10P - 50	1.0~10.0	50	44.5	GERC16/1.0	M10	32	-	2
		70	70	44.5	GERC16/1.0	M10	32	31	1
		100	100	44.5	GERC16/1.0	M10	32	31	1
	SDC13P - 50	1.0~13.0	50	49	GERC20/1.0	M7	35	-	2
		70	70	49	GERC20/1.0	M13	35	34	1
		100	100	49	GERC20/1.0	M13	35	34	1
	SDC16P - 50	1.0~16.0	50	50	GERC25/1.0	M7	42	-	2
		70	70	50	GERC25/1.0	M18	42	41	1
		100	100	50	GERC25/1.0	M18	42	41	1
	SDC20P - 60	1.0~20.0	60	60	GERC32/1.0	M7	50	-	2
90		90	60	GERC32/1.0	M22	50	49	3	
120		120	60	GERC32/1.0	M22	50	49	3	
BT40 -	SDC7P - 70	1.0~7.0	70	33	GERC11/0.5	M7	18	17	1
		90	90	33	GERC11/0.5	M7	18	17	1
		130	130	33	GERC11/0.5	M7	18	17	1
	SDC10P - 70	1.0~10.0	70	44.5	GERC16/1.0	M10	32	31	1
		90	90	44.5	GERC16/1.0	M10	32	31	1
		130	130	44.5	GERC16/1.0	M10	32	31	1
	SDC13P - 70	1.0~13.0	70	49	GERC20/1.0	M13	35	34	1
		90	90	49	GERC20/1.0	M13	35	34	1
		130	130	49	GERC20/1.0	M13	35	34	1
		150	150	49	GERC20/1.0	M13	35	34	1
	SDC16P - 70	1.0~16.0	70	50	GERC25/1.0	M18	42	41	1
		90	90	50	GERC25/1.0	M18	42	41	1
		130	130	50	GERC25/1.0	M18	42	41	1
	SDC20P - 70	1.0~20.0	70	60	GERC32/1.0	M22	50	-	2
		90	90	60	GERC32/1.0	M22	50	49	1
		130	130	60	GERC32/1.0	M22	50	49	1
		150	150	60	GERC32/1.0	M22	50	49	1
	SDC26P - 90	3.0~26.0	90	71	GERC40/1.0	M28	63	62	1

☞ Spare Part 126

• Through coolant system is optional

• Collets in the right size are recommended for oil hole type



BT-SDC/P

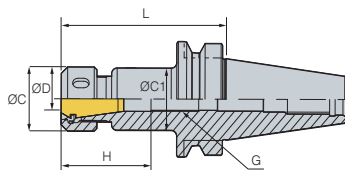

Fig. 1

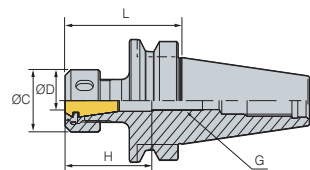

Fig. 2

Designation		ØD	L	H	Collet/Step	G	ØC	ØC ₁	Fig.
BT50 -	SDC10P - 100	1.0~10.0	100	44.5	GERC16/1.0	M10	32	31	1
	120	1.0~10.0	120	44.5	GERC16/1.0	M10	32	31	1
	160	1.0~10.0	160	44.5	GERC16/1.0	M10	32	31	1
	SDC13P - 100	1.0~13.0	100	49	GERC20/1.0	M13	35	34	1
	130	1.0~13.0	130	49	GERC20/1.0	M13	35	34	1
	160	1.0~13.0	160	49	GERC20/1.0	M13	35	34	1
	180	1.0~13.0	180	49	GERC20/1.0	M13	35	34	1
	SDC16P - 100	1.0~16.0	100	50	GERC25/1.0	M18	42	41	1
	160	1.0~16.0	160	50	GERC25/1.0	M18	42	41	1
	SDC20P - 70	1.0~20.0	70	60	GERC32/1.0	M22	50	-	2
	100	1.0~20.0	100	60	GERC32/1.0	M22	50	49	1
	130	1.0~20.0	130	60	GERC32/1.0	M22	50	49	1
	160	1.0~20.0	160	60	GERC32/1.0	M22	50	49	1
	180	1.0~20.0	180	60	GERC32/1.0	M22	50	49	1
	SDC26P - 160	3.0~26.0	160	71	GERC40/1.0	M28	63	62	1

(mm)

➔ Spare Part 126

• Through coolant system is optional • Collets in the right size are recommended for oil hole type



HSK-SDC/P

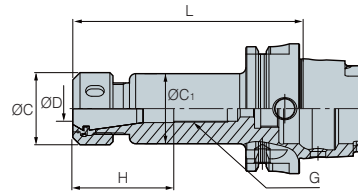





(mm)

Designation	ØD	L	H	Collet/Step	G	ØC	ØC ₁	
HSK63A -	SDC10P - 100	1.0~10.0	100	44.5	GER16/1.0	M10	32	31
	SDC13P - 100	1.0~13.0	100	49	GER20/1.0	M7	35	34
	SDC16P - 100	1.0~16.0	100	50	GER25/1.0	M7	42	41
	SDC20P - 110	1.0~20.0	110	60	GER32/1.0	M7	50	49
HSK100A -	SDC16P - 110	1.0~16.0	110	50	GER25/1.0	M13	42	41
	SDC20P - 120	2.0~20.0	120	60	GER32/1.0	M10	50	49

➔ Spare Part I26

• Through coolant system is optional • Collets in the right size are recommended for oil hole type

Parts

Division	Spare parts			
	Basic		Option	
	Sleeve bearing nut	Adjust screw	Spanner	Collet
Type				
SDC7	RN11	BN0716F	20-22	GER/ER 11-ØD
SDC10	RN16	BN1025F	32-35	GER/ER 16-ØD
SDC13	RN20	BN1325F	35-38	GER/ER 20-ØD
SDC16	RN25	BN1830F	42-46	GER/ER 25-ØD
SDC20	RN32	BN2230F	48-52	GER/ER 32-ØD
SDC26	RN40	BN2838F	62-65	GER/ER 40-ØD

• NOTES : In case of the RU20 nut, order a 35-38 spanner. In case of the R20 nut, a S-30 spanner



S-SDC

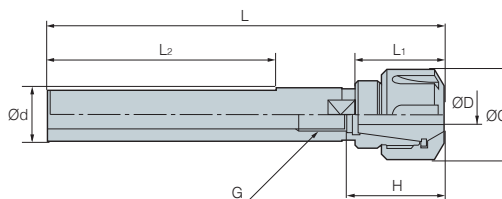

Designation		ØD	Ød	ØC	L	L ₁	L ₂	H	Collet/Step	G	(mm)	
S16 -	SDC7 - 120M	1.0~7.0	16	19	120	-	-	33	GER11/0.5	M7	0.2	0.2
	120T	1.0~7.0	16	19	120	-	73	33	GER11/0.5	M7	0.2	0.2
	SDC10 - 150T	1.0~10.0	16	28	150	46.5	83	34.5	GER16/1.0	M10	0.2	0.2
S20 -	SDC10 - 150M	1.0~10.0	20	28	150	26.5	-	34.5	GER16/1.0	M10	0.3	0.3
	150T	1.0~10.0	20	28	150	26.5	83	34.5	GER16/1.0	M10	0.3	0.3
	SDC13 - 150M	1.0~13.0	20	35	150	50	-	49	GER20/1.0	M13	0.3	0.3
	150T	1.0~13.0	20	35	150	50	83	49	GER20/1.0	M13	0.3	0.3
S25 -	SDC10 - 150M	1.0~10.0	25	28	150	-	-	34.5	GER16/1.0	M10	0.5	0.5
	150T	1.0~10.0	25	28	150	-	83	34.5	GER16/1.0	M10	0.5	0.5
	SDC13 - 150M	1.0~13.0	25	35	150	-	-	49	GER20/1.0	M13	0.5	0.5
	150T	1.0~13.0	25	35	150	-	83	49	GER20/1.0	M13	0.5	0.5
S32 -	SDC13 - 150M	1.0~13.0	32	35	150	-	-	49	GER20/1.0	M13	0.7	0.7
	150T	1.0~13.0	32	35	150	-	83	49	GER20/1.0	M13	0.7	0.7
	SDC20 - 165M	2.0~20.0	32	50	165	-	-	60	GER32/1.0	M22	0.7	0.7
	165T	2.0~20.0	32	50	165	-	83	60	GER32/1.0	M22	0.7	0.7

Spare Part 128

• Through coolant system is optional



S-SDC/S

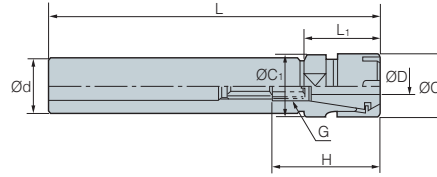

Fig. 1

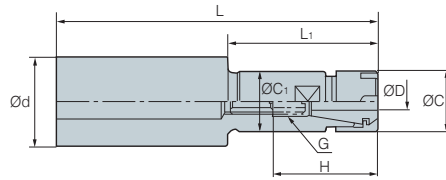







Fig. 2

(mm)

Designation	ØD	Ød	ØC	L	L ₁	H	Collet/Step	G		
S16 -	SDC7S - 100M	1.0~7.0	16	16	100	-	33	GER11/0.5	M7	0.2
		150M	1.0~7.0	16	16	150	-	33	GER11/0.5	M7
	SDC10S - 100M	1.0~10.0	16	22	100	50	44.5	GER16/1.0	M10	0.3
		150M	1.0~10.0	16	22	150	50	44.5	GER16/1.0	M10
S20 -	SDC7S - 100M	1.0~7.0	20	16	100	30	35	GER11/0.5	M7	0.3
		150M	1.0~7.0	20	16	150	80	35	GER11/0.5	M7
	SDC10S - 100M	1.0~10.0	20	22	100	50	44.5	GER16/1.0	M10	0.3
		150M	1.0~10.0	20	22	150	50	44.5	GER16/1.0	M10
	SDC13S - 100M	1.0~13.0	20	28	100	50	49	GER20/1.0	M13	0.3
		150M	1.0~13.0	20	28	150	50	49	GER20/1.0	M13
S25 -	SDC7S - 100M	1.0~7.0	25	16	100	30	33	GER11/0.5	M7	0.4
		150M	1.0~7.0	25	16	150	80	33	GER11/0.5	M7
	SDC10S - 100M	1.0~10.0	25	22	100	30	44.5	GER16/1.0	M10	0.4
		150M	1.0~10.0	25	22	150	80	44.5	GER16/1.0	M10
	SDC13S - 100M	1.0~13.0	25	28	100	-	49	GER20/1.0	M13	0.5
		150M	1.0~13.0	25	28	150	-	49	GER20/1.0	M13
	SDC16S - 100M	1.0~16.0	25	35	100	50	50	GER25/1.0	M18	0.5
		150M	1.0~16.0	25	35	150	50	50	GER25/1.0	M18
S32 -	SDC16S - 120M	1.0~16.0	32	35	120	-	50	GER25/1.0	M18	1
		150M	1.0~16.0	32	35	150	-	50	GER25/1.0	M18

• Through coolant system is optional

Parts

Division	Spare parts			
	Basic		Option	
	Nut	Adjust screw	Spanner	(G)ER collet
Type				
SDC7S	R11M	BN0716F	M11M	(G)ER 11-ØD
SDC10S	R16M	BN1025F	M16M	(G)ER 16-ØD
SDC13S	R20M	BN1325F	M20M	(G)ER 20-ØD
SDC16S	R25M	BN1830F	M25M	(G)ER 25-ØD



BT-GSK

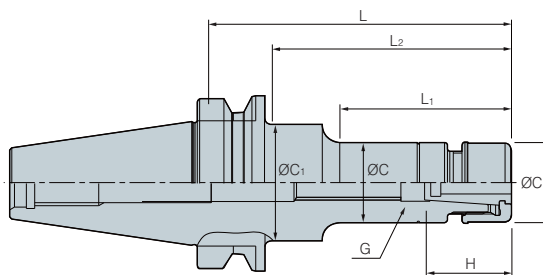

Designation		ØD	L	L ₁	L ₂	H	Collet/ Step	G	ØC	ØC ₁		MAX RPM
BT30 -	GSK6 - 60	1.0~6.0	60	33	33	35	HC6/0.5	M8	19.5	19.5	0.7	25,000
	90	1.0~6.0	90	56	65	35	HC6/0.5	M8	19.5	32	0.8	25,000
	GSK10 - 60	2.0~10.0	60	35	35	50	HC10/0.5	M12	27	27	0.9	25,000
	90	2.0~10.0	90	65	65	50	HC10/0.5	M12	27	27	1.0	25,000
	GSK13 - 60	3.0~13.0	60	36	36	43	HC13/1.0	M12	35	35	0.6	25,000
	GSK16 - 60	3.0~16.0	60	37	37	60	HC16/0.5	M12	40	40	1.1	25,000
	90	3.0~16.0	90	67	67	60	HC16/0.5	M18	40	40	1.2	25,000
GSK25 - 90	16.0~25.0	90	67.5	67.5	63.5	HC25/0.5	M12	55	55	1.1	25,000	
BT40 -	GSK6 - 90	1.0~6.0	90	51	61	35	HC6/0.5	M8	19.5	32	1.1	20,000
	120	1.0~6.0	120	60	90	35	HC6/0.5	M8	19.5	32	1.4	20,000
	150	1.0~6.0	150	60	120	35	HC6/0.5	M8	19.5	25	1.5	20,000
	GSK10 - 90	2.0~6.0	90	48	60	50	HC10/0.5	M12	27	40	1.2	20,000
	120	2.0~6.0	120	73	90	50	HC10/0.5	M12	27	40	1.4	20,000
	150	2.0~6.0	150	73	118	50	HC10/0.5	M12	27	34.5	1.6	20,000
	GSK13 - 90	3.0~13.0	90	59	59	43	HC13/1.0	M15	35	35	1.4	20,000
	GSK16 - 90	3.0~16.0	90	58	58	60	HC16/0.5	M18	40	40	1.5	20,000
	120	3.0~16.0	120	88	88	60	HC16/0.5	M18	40	40	1.7	20,000
	150	3.0~16.0	150	118	118	60	HC16/0.5	M18	40	40	1.9	20,000
	GSK20 - 90	4.0~20.0	90	60	60	70	HC20/0.5	M22	48	48	1.6	20,000
	120	4.0~20.0	120	90	90	70	HC20/0.5	M22	48	48	2.0	20,000
	GSK25- 90	16.0~25.0	90	61	61	75	HC25/0.5	M28	55	55	1.8	20,000
	120	16.0~25.0	120	91	91	85	HC25/0.5	M28	55	55	2.0	20,000
BT50 -	GSK6 - 105	1.0~6.0	105	55	64	35	HC6/0.5	M8	19.5	32	3.8	15,000
	135	1.0~6.0	135	60	92	35	HC6/0.5	M8	19.5	32	3.9	15,000
	165	1.0~6.0	165	60	114	35	HC6/0.5	M8	19.5	32	4.0	15,000
	GSK10 - 105	2.0~10.0	105	57	57	50	HC10/0.5	M12	27	27	3.8	15,000
	135	2.0~10.0	135	70	92	50	HC10/0.5	M12	27	32	4.0	15,000
	165	2.0~10.0	165	75	114	50	HC10/0.5	M12	27	36	4.2	15,000
	GSK13 - 135	3.0~13.0	135	92	92	43	HC13/1.0	M15	35	35	4.2	15,000
	GSK16 - 105	3.0~16.0	105	62	62	60	HC16/0.5	M18	40	40	4.1	15,000
	135	3.0~16.0	135	92	92	60	HC16/0.5	M18	40	40	4.3	15,000
	165	3.0~16.0	165	40	122	60	HC16/0.5	M18	40	50	4.5	15,000
	GSK20 - 105	4.0~20.0	105	62	62	70	HC20/0.5	M22	48	-	4.3	15,000
	135	4.0~20.0	135	92	92	70	HC20/0.5	M22	48	-	4.6	15,000
	165	4.0~20.0	165	122	122	70	HC20/0.5	M22	48	-	5.0	15,000
	GSK25 - 105	16.0~25.0	105	62	62	85	HC25/0.5	M28	55	55	4.8	15,000
	135	16.0~25.0	135	92	92	85	HC25/0.5	M28	55	55	5.2	15,000
165	16.0~25.0	165	122	122	85	HC25/0.5	M28	55	55	5.6	15,000	

 Spare Part 130



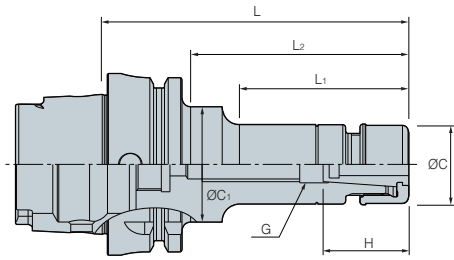

HSK-GSK



(mm)

Designation	ØD	L ₁	L ₂	H	Collet/Step	G	ØC	ØC ₁	MAX RPM	
HSK63A -	GSK6 - 100	1.0~6.0	51	61	35	HC6/0.5	M8	19.5	32	20,000
	GSK10 - 105	2.0~6.0	73	118	50	HC10/0.5	M12	27	34.5	20,000
	GSK16 - 120	3.0~16.0	58	58	60	HC16/0.5	M18	40	40	20,000
	GSK20 - 120	4.0~20.0	60	60	70	HC20/0.5	M22	48	48	20,000
HSK100A -	GSK6 - 120	1.0~6.0	55	64	35	HC6/0.5	M8	19.5	32	15,000
	GSK10 - 120	2.0~10.0	57	57	50	HC10/0.5	M12	27	27	15,000
	GSK16 - 140	3.0~16.0	62	62	60	HC16/0.5	M18	40	40	15,000
	GSK25 - 155	16.0~25.0	62	62	85	HC25/0.5	M28	55	55	15,000

Parts

Division	Spare parts		
	Basic		
	Nut	Adjust screw	Extractor
Type			
GSK6	GN6	M820C	GSK-6CE
GSK10	GN10	M1230C	GSK-10CE
GSK13	GN13	BN1530F	GSK-13CE
GSK16	GN16	BN1830F	GSK-16CE
GSK20	GN20	BN2230F	GSK-20CE
GSK25	GN25	BN2838F	GSK-25CE

Spanner (Option)



Designation
GSK6
GSK10
GSK13
GSK16
GSK20
GSK25



Slim type collet chuck

DSK

- Balancing G6.3 available for machining at max.15,000RPM
- Minimized tool vibration during operation by using collet 8°
- Swiss made high precision nut enhances stability
- Applicable shank diameter: Ø1.8~25



Code system



First-class nut (SWISS made)



Easy clamping of collet

Special hardening treatment

Multifunctional applications

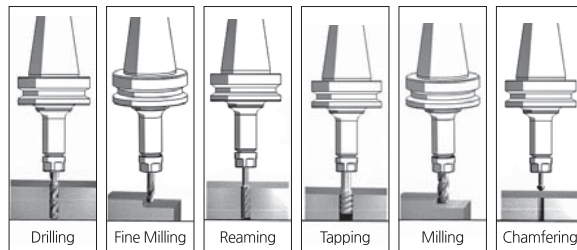

Collet

Standard type & Precision type	Designation	Diameter	Max chucking	Run-out
	HC6-Ød	10.5	6.0	Standard type 5µm Precision type 3µm
	HC10-Ød	15.5	10.0	
	HC13-Ød	20.1	13.0	
	HC16-Ød	24.6	16.0	
	HC20-Ød	29.1	20.0	
	HC25-Ød	35.6	25.0	

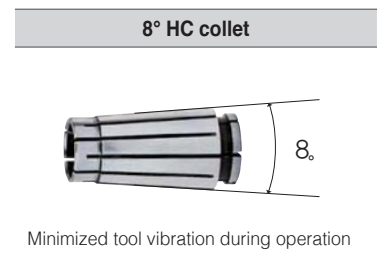

Spanner (Option)

<p>Spanner</p>	Designation	Chuck
	DSS-6	DSK-6
	DSS-10	DSK-10
	DSS-16	DSK-16
	DSS-20	DSK-20
	DSS-25	DSK-25

<p>Collet Extractor</p>	Designation	Chuck
	DSS-6	DSK-6
	DSS-10	DSK-10
	DSS-16	DSK-16
	DSS-20	DSK-20
	DSS-25	DSK-25



BT-DSK

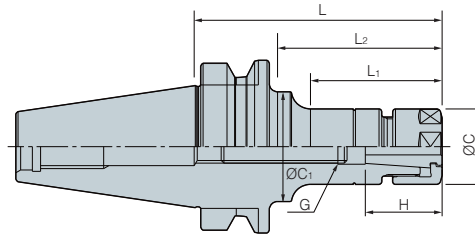

Designation		ØD	L	L ₁	L ₂	H	Collet/Step	G	ØC	ØC ₁		MAX RPM
BT30 -	DSK6 - 60	1.0~6.0	60	33	33	35	HC6/0.5	M8	19.5	19.5	0.7	15,000
	90	1.0~6.0	90	56	65	35	HC6/0.5	M8	19.5	32	0.8	15,000
	DSK10- 60	2.0~10.0	60	35	35	50	HC10/0.5	M12	27.5	27.5	0.9	15,000
	90	2.0~10.0	90	65	65	50	HC10/0.5	M12	27.5	27.5	1.0	15,000
	DSK13 - 60	3.0~13.0	60	36	36	43	HC13/0.5	M12	33	33	0.6	15,000
	DSK16 - 60	3.0~16.0	60	37	37	60	HC16/0.5	M12	40	40	1.1	15,000
	90	3.0~16.0	90	67	67	60	HC16/0.5	M18	40	40	1.2	15,000
DSK25 - 90	16.0~25.0	90	67.5	67.5	63.5	HC25/0.5	M12	55	55	1.1	15,000	
BT40 -	DSK6 - 90	1.0~6.0	90	51	61	35	HC6/0.5	M8	19.5	32	1.1	10,000
	120	1.0~6.0	120	60	90	35	HC6/0.5	M8	19.5	32	1.4	10,000
	150	1.0~6.0	150	60	120	35	HC6/0.5	M8	19.5	25	1.5	10,000
	DSK10 - 90	2.0~6.0	90	48	60	50	HC10/0.5	M12	27.5	40	1.2	10,000
	120	2.0~6.0	120	73	90	50	HC10/0.5	M12	27.5	40	1.4	10,000
	150	2.0~6.0	150	73	118	50	HC10/0.5	M12	27.5	34.5	1.6	10,000
	DSK13 - 90	3.0~13.0	90	59	59	43	HC13/1.0	M15	33	33	1.4	10,000
	DSK16 - 90	3.0~16.0	90	58	58	60	HC16/0.5	M18	40	40	1.5	10,000
	120	3.0~16.0	120	88	88	60	HC16/0.5	M18	40	40	1.7	10,000
	150	3.0~16.0	150	118	118	60	HC16/0.5	M18	40	40	1.9	10,000
	DSK20 - 90	4.0~20.0	90	60	60	70	HC20/0.5	M22	46.5	48.5	1.6	10,000
	120	4.0~20.0	120	90	90	70	HC20/0.5	M22	46.5	48.5	2.0	10,000
	DSK25 - 90	16.0~25.0	90	61	61	75	HC25/0.5	M28	55	55	1.8	10,000
120	16.0~25.0	120	91	91	85	HC25/0.5	M28	55	55	2.0	10,000	

 Spare Part I33

• Through coolant system is optional • Coolant collets are recommended when using the coolant system



BT-DSK

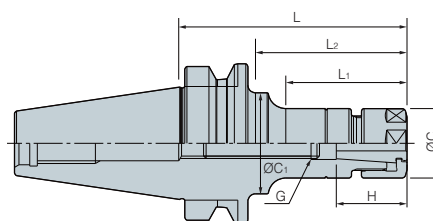

Designation		ØD	L	L ₁	L ₂	H	Collet/Step	G	ØC	ØC ₁	kg	MAX RPM	
BT50 -	DSK6 -	105	1.0~6.0	105	55	64	35	HC6/0.5	M8	19.5	32	3.8	8,000
		135	1.0~6.0	135	60	92	35	HC6/0.5	M8	19.5	32	3.9	8,000
		165	1.0~6.0	165	60	114	35	HC6/0.5	M8	19.5	32	4.0	8,000
	DSK10 -	105	2.0~10.0	105	57	57	50	HC10/0.5	M12	27.5	27.5	3.8	8,000
		135	2.0~10.0	135	70	92	50	HC10/0.5	M12	27.5	32	4.0	8,000
		165	2.0~10.0	165	75	114	50	HC10/0.5	M12	27.5	36	4.2	8,000
	DSK13 -	135	3.0~13.0	135	92	92	43	HC13/1.0	M15	33	33	4.2	8,000
	DSK16 -	105	3.0~16.0	105	62	62	60	HC16/0.5	M18	40	40	4.1	8,000
		135	3.0~16.0	135	92	92	60	HC16/0.5	M18	40	40	4.3	8,000
		165	3.0~16.0	165	40	122	60	HC16/0.5	M18	40	50	4.5	8,000
	DSK20 -	105	4.0~20.0	105	62	62	70	HC20/0.5	M22	48.5	-	4.3	8,000
		135	4.0~20.0	135	92	92	70	HC20/0.5	M22	48.5	-	4.6	8,000
		165	4.0~20.0	165	122	122	70	HC20/0.5	M22	48.5	-	5.0	8,000
	DSK25 -	105	16.0~25.0	105	62	62	85	HC25/0.5	M28	55	55	4.8	8,000
		135	16.0~25.0	135	92	92	85	HC25/0.5	M28	55	55	5.2	8,000
165		16.0~25.0	165	122	122	85	HC25/0.5	M28	55	55	5.6	8,000	

• Through coolant system is optional • Coolant collets are recommended when using the coolant system

Parts

Division	Spare parts		
	Option		
	Nut	Adjust screw	Spanner
Type			
DSK6	DN6	BN0825F	DSS-6
DSK10	DN10	BN1225F	DSS10
DSK16	DN16	BN1830F	DSS16
DSK20	DN20	BN2230F	DSS20
DSK25	DN25	BN2838F	DSS25



Technical Information for GERC

GER Collet_GER

GERC *new*

- Corrosion resistant collet to micro unit
- High tech coating for long lasting precision
- Longer tool life and higher productivity



Code system



Special coating technology

Unlike GERC collets, Conventional non-coated collets have the following features:
 Non-coated collets are affected by corrosion due to high humidity, cutting fluid, cleaner, salt, gas and many other factors, which in result deteriorates whole quality of machining



When a collet gets rusty, the tool life is shortened and precision considerably decreases. To prevent this problem, surface treatment by micro unit was applied to GERC collets for effective protection and long lasting precision



GERC



Competitor

Two samples of collets after 4 months of use:
 Left: GERC collet, Right: Non-coated

GERC-HP

A precision type collet chuck is expensive than standard one, but still it has more advantages in long term cost and efficiency. Using GERC-HP can minimize pricy reworking due to smaller tolerance with maximum precision

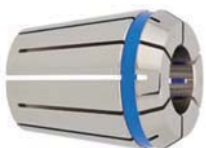

Precision type collet 2 μ m

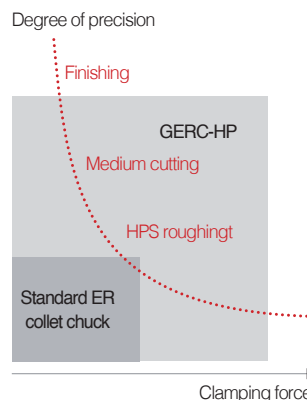

Precision (L/D = 3)

Standard type = 5 μ m
 Precision type = 2 μ m

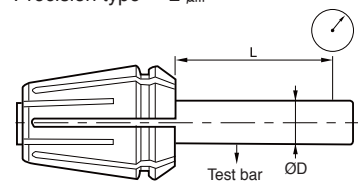

GERC Collet

Accuracy type/High Accuracy type

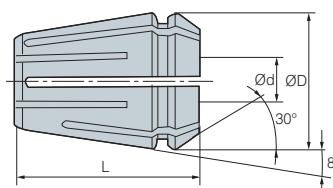

(mm)

Designation	ER size	ØD	L	Ød (Max.)	Distance (mm)	Tolerance	
						Standard type	Precision type (HP)
GER11 - Ød(HP)	11	11.5	18.0	7.0	0.5	5 µm	2 µm
GER16 - Ød(HP)	16	17.0	27.5	10.0	1.0		
GER20 - Ød(HP)	20	21.0	31.5	13.0	1.0		
GER25 - Ød(HP)	25	26.0	34.0	16.0	1.0		
GER32 - Ød(HP)	32	33.0	40.0	20.0	1.0		
GER40 - Ød(HP)	40	41.0	46.0	26.0	1.0		

ER Collet

Trough coolant type

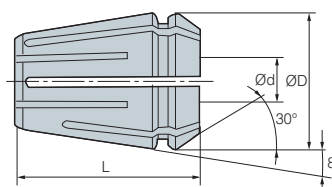

(mm)

Designation	ER size	ØD	L	Ød (Max.)	Min. pi of water proof type	Distance (mm)	Tolerance
ER16 - Ød(C)	16	17.0	27.5	10.0	4.0	1.0	
ER20 - Ød(C)	20	21.0	31.5	13.0	6.0	1.0	
ER25 - Ød(C)	25	26.0	34.0	16.0	6.0	1.0	
ER32 - Ød(C)	32	33.0	40.0	20.0	8.0	1.0	
ER40 - Ød(C)	40	41.0	46.0	26.0	10.0	1.0	

HC Slim Collet

General & Accuracy type

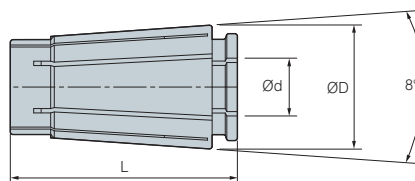

(mm)

Designation	ØD	L	Ød (Max.)	Distance (mm)	Tolerance	
					Standard type	Precision type (HP)
HC6 - Ød(P)	10.5	25.0	6.0	1.0	5 µm	3 µm
HC10 - Ød(P)	15.6	30.5	10.0	1.0		
HC13 - Ød(P)	20.1	39.0	13.0	1.0		
HC16 - Ød(P)	24.6	45.0	16.0	1.0		
HC20 - Ød(P)	29.2	54.3	20.0	1.0		
HC25 - Ød(P)	35.7	57.0	25.0	1.0		



GERC Collet

Accuracy type



(mm)

Designation	Ød	Distance	Collet amount	Tolerance
GERC11 1.0-7.0mm/0.5mm	1.0-7.0	0.5	13pcs	5 µm
GERC16 1.0-10.0mm/1.0mm	1.0-10.0	1.0	10pcs	5 µm
GERC20 2.0-13.0mm/1.0mm	2.0-13.0	1.0	12pcs	5 µm
GERC25 2.0-16.0mm/1.0mm	2.0-16.0	1.0	15pcs	5 µm
GERC32 3.0-20.0mm/1.0mm	3.0-20.0	1.0	18pcs	5 µm
GERC40 4.0-26.0mm/1.0mm	4.0-26.0	1.0	23pcs	5 µm

ER Collet

General type



(mm)

Designation	Ød	Distance	Collet amount	Tolerance
ER11(SET)	1.5-7.0	0.5	12pcs	10 µm
ER16(SET)	2.0-10.0	1.0	10pcs	10 µm
ER20(SET)	2.0-13.0	1.0	12pcs	10 µm
ER25(SET)	2.0-16.0	1.0	15pcs	10 µm
ER32(SET)	3.0-20.0	1.0	18pcs	10 µm
ER40(SET)	6.0-26.0	1.0	21pcs	15 µm



High speed synchro tapping chuck

DST **new**

- Tapping chuck for high speed machining
- Specially designed structure for absorbing thrust load and preventing damage on the tap
- Through coolant system available
- Applicable range: M1-M22



Code system



Excellent performance, precise machining

Expanded machining area



DST22
(vc = 100 m/min)

Excellent cutting face

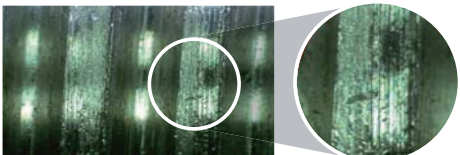

Conventional one

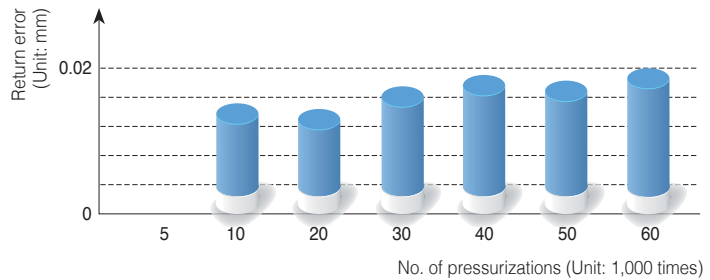

Exclusive collet for tapping

- At tapping work use of TER collet
- DST3: Use of ER11 collet

Comparison of thread figures

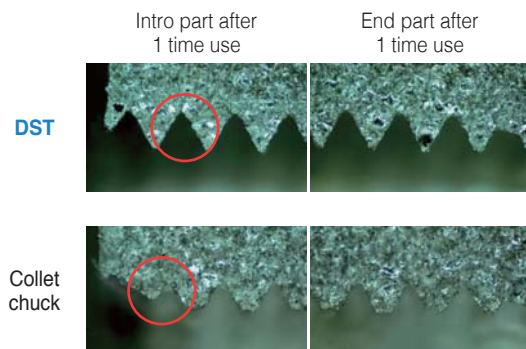

Synchro tap chuck(DST7)

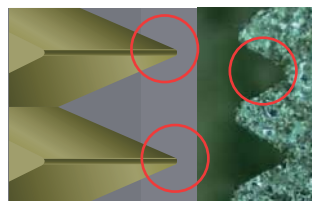

The threads have a good figure, and didn't get out of its shape

General collet chuck



The thread is out of its shape due to synchronization error



BT-DST

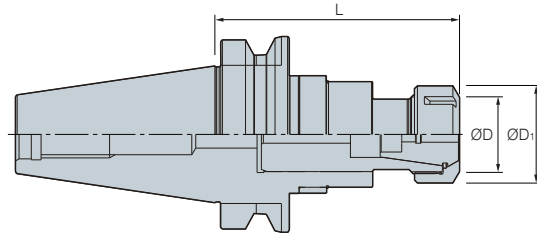

Designation			ØD	ØD ₁	L	Collet	Tapping range	F-	F+
BT30 -	DST3 -	70	26	19	70	ER11	M1~M3	0.5	0.5
	DST10 -	95	40.4	28	95	TER16	M3~M10	0.5	0.5
BT40 -	DST10 -	100	40.4	28	100	TER16	M3~M10	0.5	0.5
	DST22 -	110	60	49.5	110	TER32	M6~M22	0.7	0.7
BT50 -	DST10 -	110	60	49.5	110	TER16	M3~M10	0.5	0.5
	DST22 -	130	60	49.5	125	TER32	M6~M22	0.7	0.7

(mm)

↻ Applicable collet 135, 143

• Through coolant system is optional

HSK-DST

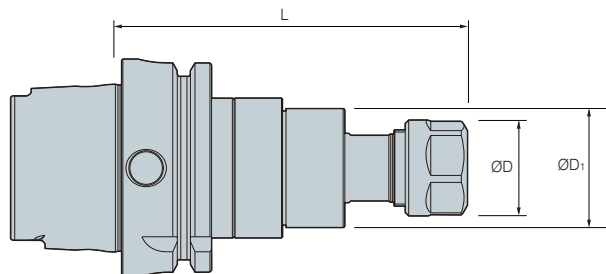

Designation			ØD	ØD ₁	L	Collet	Tapping range	F-	F+
HSK63A -	DST10 -	100	40.4	28	100	TER16	M3~M10	0.5	0.5
	DST22 -	130	60	49.5	130	TER32	M6~M22	0.7	0.7

(mm)

↻ Applicable collet 143

• Through coolant system is optional



BT-NPU

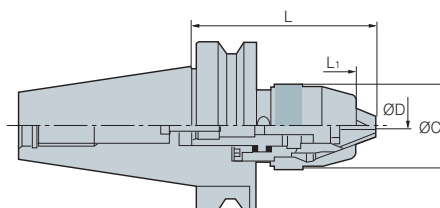



Designation		ØD (Clamping range)	ØC	L	L ₁	
BT30 -	NPU8 - 97	0~8	38	97	8.5	0.8
	NPU13 - 125	1~13	50	125	12.5	1.5
BT40 -	NPU8 - 87	0~8	38	87	8.5	1.3
	NPU13 - 105	1~13	50	105	12.5	1.7
	NPU1a3 - 130	1~13	50	130	12.5	2.0
BT50 -	NPU13 - 115	1~13	50	115	12.5	4.4
	NPU13 - 130	1~13	50	130	12.5	4.6
	NPU13 - 190	1~13	50	190	12.5	5.4

(mm)

• Through coolant system not available

Parts

Division	Spare parts		
	Basic		Option
	Chuck	Bolt	Spanner
Type			
NPU08	NPU08	BX0820	NPU0836
NPU13	NPU13	BX0825	NPU1348



Technical Information for DTN

Tapping holder

DTN

- Compact design and slim type
- Improvement of tapping force
- Tapping range M3 ~ M38



Code system



Easy exchange of TCA (Tap adaptor)

Convenient one-touch exchange type for high precision and longer tool life
 Contraction of length is possible by axial floating way

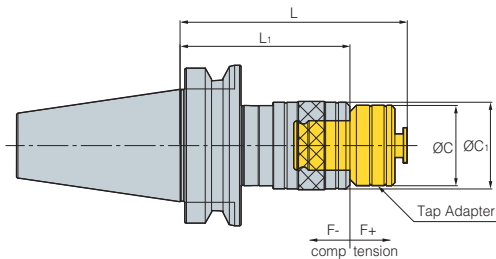

Improved cutting result





How to clamp TCA and a tap holder

Before installation	After installation	Disassembly
<ol style="list-style-type: none"> 1. Insert TCA pushing the cover of tap holder 2. Clamp the TCA in the Key groove and firmly 	<ol style="list-style-type: none"> 1. The cover of tap holder is placed correctly 	<ol style="list-style-type: none"> 1. Separate the TCA pushing the cover of tap holder

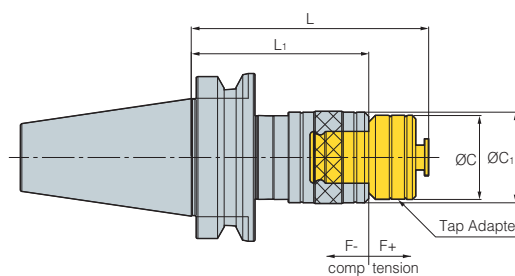

BT-DTN



Designation		Tapping range	L	L ₁	ØC	ØC ₁	Adaptor	F-	F+	
BT30 -	DTN12 - 85	M3~M12	85	60	32	39	TCA1-M	4	10	0.7
	DTN12 - 90	M3~M12	90	65	32	39	TCA1-M	4	10	1.2
BT40 -	120	M3~M12	120	95	32	39	TCA1-M	4	10	1.4
	DTN22 - 130	M8~M22	130	96	50	56	TCA2-M	12.5	12.5	1.7
BT50 -	160	M8~M22	160	126	50	56	TCA2-M	12.5	12.5	2.1
	DTN12 - 100	M3~M12	100	75	32	39	TCA1-M	4	10	3.7
BT50 -	130	M3~M12	130	105	32	39	TCA1-M	4	10	3.9
	DTN22 - 140	M8~M22	140	104	50	56	TCA2-M	12.5	12.5	4.2
BT50 -	170	M8~M22	170	134	50	56	TCA2-M	12.5	12.5	4.7
	DTN38 - 185	M16~M38	185	140	72	81	TCA3-M	20	20	5.7
BT50 -	215	M16~M38	215	170	72	81	TCA3-M	20	20	6.6

 Tap Adapter (TCA) I 42

• Through coolant system not available • Tap adaptor is optional

S-DTN

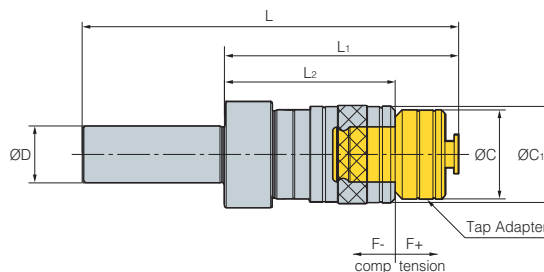

Designation		Tapping range	ØD	L	L ₁	L ₂	ØD	ØD	F-	F+	Adaptor
S32 -	DTN12 - 90	M3-M12	32	170	90	65	32	39	4	10	TCA1
S32 -	DTN22 - 130	M8-M24	32	210	130	96	50	56	12.5	12.5	TCA2

 Tap Adapter (TCA) I 42

• Through coolant system not available • Tap adaptor is optional



TCA Tap Adaptor

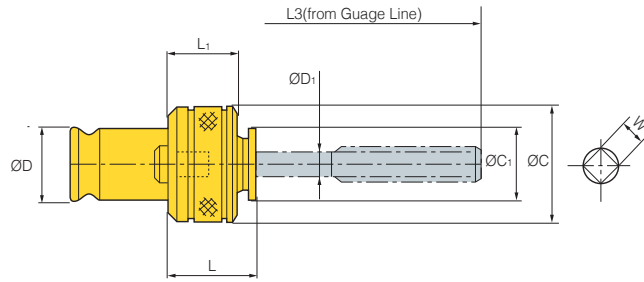

(mm)

Designation	ØD	ØC	L	L ₁		
TCA1 -	M3	4	3.2	24	22	0.2
	M4	5	4	24	22	0.2
	M5	5.5	4.5	24	22	0.2
	M6, 1/4U	6	4.5	24	22	0.2
	M8	6.2	5	25	22	0.2
	M10, 3/8U	7	5.5	25	22	0.2
	M11	8	6	39	22	0.2
	M12	8.5	6.5	26	22	0.2
TCA2 -	M8	6.2	5	38	28	0.6
TCS2 -	M10	7	5.5	38	28	0.6
TCA2 -	M12	8.5	6.5	39	28	0.6
	M14, 3/4U	10.5	8	41	28	0.6
	P1/4	11	9	31	28	0.6
TCS2 -	M16	12.5	10	43	28	0.6
TCA2 -	M18, P3/8	14	11	44	28	0.6
	M20	15	12	45	28	0.6
	M22	17	13	46	28	0.6
	P1/2	18	14	36	28	0.6
	M24	19	15	46	28	1.8
TCA3 -	M16	12.5	10	35	37	1.8
	M18	14	11	37	37	1.8
	M20	15	12	37	37	1.8
	M22	17	13	38	37	1.8
	M24	19	15	44	37	1.8
	M27, 1U	20	15	62	37	1.8
	M30, P3/4	23	17	62	37	1.8
	M33	25	19	66	37	1.8
M36, M38	28	21	68	37	1.8	

• DIN standard products can be ordered • Through coolant system not available



TER Tap Collet

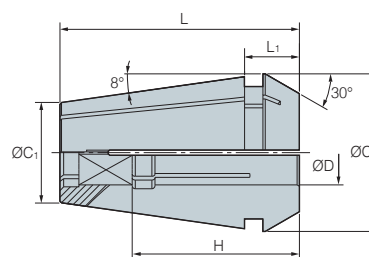
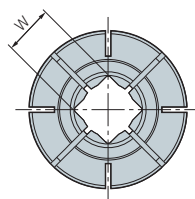
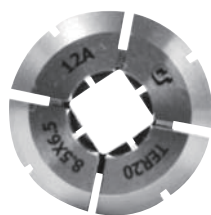

Designation		Tapping Range	ØD	W	ØC	ØC ₁	L	L ₁	H
TER16 -	4x3.2	M3	4	3.2	16.74	10.1	27.5	6.3	18
	5x4	M4	5	4	16.74	10.1	27.5	6.3	18
	5.5x4.5	M5	5.5	4.5	16.74	10.1	27.5	6.3	18
	6x4.5	M6, U1/4	6	4.5	16.74	10.1	27.5	6.3	18
	6.2x5	M7, M8	6.2	5	16.74	10.1	27.5	6.3	18
	7x5.5	M9, M10, U3/8	7	5.5	16.74	10.1	27.5	6.3	18
TER20 -	5x4	M4	5	4	20.74	13.2	31.5	7.2	18
	5.5x4.5	M5	5.5	4.5	20.74	13.2	31.5	7.2	18
	6x4.5	M6, U1/4	6	4.5	20.74	13.2	31.5	7.2	18
	6.2x5	M7, M8	6.2	5	20.74	13.2	31.5	7.2	18
	7x5.5	M9, M10, U3/8	7	5.5	20.74	13.2	31.5	7.2	18
	8x6	M11, U7/16, P1/8	8	6	20.74	-	-	-	-
TER25 -	5x4	M4	5	4	25.74	17.6	34	7.5	18
	5.5x4.5	M5	5.5	4.5	25.74	17.6	34	7.5	18
	6x4.5	M6	6	4.5	25.74	17.6	34	7.5	18
	6.2x5	M7, M8	6.2	5	25.74	17.6	34	7.5	18
	7x5.5	M9, M10, U3/8	7	5.5	25.74	17.6	34	7.5	18
	8.5x6.5	M12	8.5	6.5	25.74	17.6	34	7.5	22
TER32 -	6x4.5	M6, U1/4	6	4.5	32.74	23.1	40	8.2	18
	6.2x5	M7, M8	6.2	5	32.74	23.1	40	8.2	18
	7x5.5	M9, M10, U3/8	7	5.5	32.74	23.1	40	8.2	18
	8X6	M11, U7/16, P1/8	8	6	32.74	23.1	40	8.2	22
	8.5x6.5	M12	8.5	6.5	32.74	23.1	40	8.2	22
	10.5x8	M14, U9/16	10.5	8	32.74	23.1	40	8.2	25
	12.5x10	M16	12.5	10	32.74	23.1	40	8.2	25
	14x11	M18, P3/8	14	11	32.74	23.1	40	8.2	25
	15x12	M20	15	12	32.74	23.1	40	8.2	25
	17x13	M22, U7/8	17	13	32.74	23.1	40	8.2	25
	11x9	P1/4	11	9	32.74	23.1	40	8.2	25
	12x9	U5/8	12	9	32.74	23.1	40	8.2	25
	9x7	U1/2	9	7	32.74	23.1	40	8.2	22

• Water proof tapping is possible with the use of RTJW and nuts (limited to the right sizes)



BT-SLA

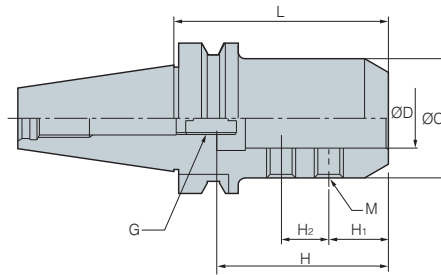

(mm)

Designation		ØD	L	ØC	H	H ₁	H ₂	M	G	
BT30 -	SLA16 - 90	16	90	40	70	25	20	M10	M12	1.1
	SLA20 - 90	20	90	50	70	25	20	M12	M12	1.2
	SLA25 - 90	25	90	50	70	25	20	M12	M12	1.2
BT40 -	SLA16 - 90	16	90	40	70	25	20	M10	M12	1.5
	SLA20 - 90	20	90	50	70	25	20	M12	M12	1.8
	SLA25 - 90	25	90	50	70	25	20	M12	M12	2.0
	SLA32 - 90	32	90	60	80	25	25	M14	M12	2.2
	105	32	105	60	80	25	25	M14	M12	2.4
	SLA40 - 105	40	105	80	80	25	25	M16	M12	2.4
BT50 -	SLA16 - 90	16	90	40	70	25	20	M10	M12	4.2
	SLA20 - 105	20	105	50	70	25	20	M12	M12	4.4
	SLA25 - 105	25	105	50	70	25	20	M12	M12	4.4
	135	25	135	50	70	25	20	M12	M12	4.7
	SLA32 - 105	32	105	60	80	25	25	M14	M12	4.8
	135	32	135	60	80	25	25	M14	M12	5.4
	165	32	165	60	80	25	25	M14	M12	6.2
	SLA40 - 105	40	105	90	80	25	25	M16	M12	5.2
	150	40	150	90	80	25	25	M16	M12	5.8
SLA42 - 105	42	105	90	80	25	25	M16	M12	5.8	

 Spare Part 145

• Through coolant system is optional



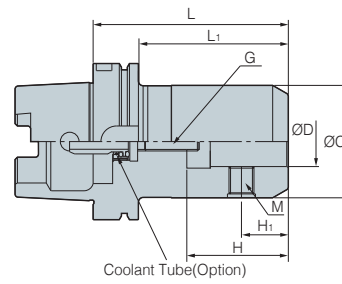

HSK-SLA



Designation		ØD	L	ØC	H	H ₁	M	G	
HSK63A -	SLA20 - 100	20	100	52	51	25	M16	M12	2.0
	SLA25 - 105	25	105	65	59	25	M18	M12	2.7
	SLA32 - 105	32	105	72	63	30	M20	M12	2.9
HSK100A -	SLA20 - 105	20	105	52	51	25	M16	M12	3.9
	SLA25 - 110	25	110	65	59	25	M18	M12	4.0
	SLA32 - 125	32	125	72	63	30	M20	M12	4.3

• Through coolant system is optional

Parts

Division	Spare parts				
	Basic		Option		
	Set screw		Wrench		
Type					
	DBT/BT type	HSK/SK type	DBT/BT type	HSK/SK type	
SLA16	BTF1010	BTF1414-1.5	M1230C	LW-5	
SLA19	BTF1212-1.5	BTF1616-1.5		LW-6	
SLA20		BTF1818-1.5		LW-8	
SLA25	BTF1414-1.5	BTF2020-1.5		LW-6	LW-10
SLA40	BTF1624-1.5			LW-8	
SLA42					



BT-FMA

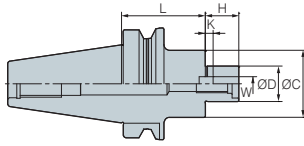

Fig. 1

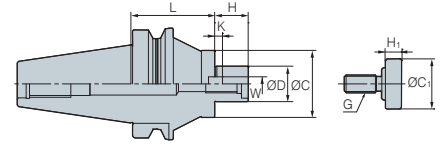

Fig. 2

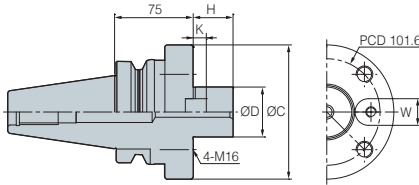

Fig. 3

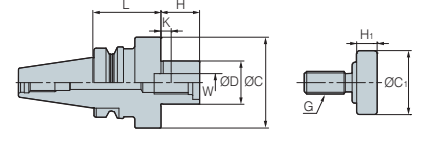







Fig. 4

(mm)

Designation	Cutter dia.	ØD	L	ØC	H	W	K	G		Fig.	
BT30 - FMA25.4 - 45	45	80	25.4	45	50	22	9.5	5	M12	1.2	4
BT40 -	FMA25.4 - 45	80	25.4	45	50	22	9.5	5	M12	1.4	1
	FMA25.4 - 90	80	25.4	90	50	22	9.5	5	M12	3.1	1
	FMA31.75 - 45	100	31.75	45	60	30	12.7	7	M16	1.6	1
	FMA31.75 - 90	100	31.75	90	60	30	12.7	7	M16	3.0	1
	FMA38.1 - 60	125	38.1	60	80	34	15.87	9	M20	2.9	4
BT50 -	FMA25.4 - 45	80	25.4	45	50	22	9.5	5	M12	3.8	1
	FMA25.4 - 90	80	25.4	90	50	22	9.5	5	M12	4.5	1
	FMA25.4 - 150	80	25.4	150	50	22	9.5	5	M12	5.5	2
	FMA31.75 - 45	100	31.75	45	60	30	12.7	7	M16	4.6	1
	FMA31.75 - 75	100	31.75	75	60	30	12.7	7	M16	5.2	1
	FMA31.75 - 105	100	31.75	105	60	30	12.7	7	M16	6.0	2
	FMA38.1 - 45	125	38.1	45	80	34	15.87	9	M20	4.3	1
	FMA38.1 - 75	125	38.1	75	80	34	15.87	9	M20	5.5	1
	FMA50.8 - 45	160	50.8	45	100	36	19.05	10	M24	4.8	1
	FMA50.8 - 75	160	50.8	75	100	36	19.05	10	M24	6.8	1
FMA47.625 - 75	200	47.625	75	128	38	25.4	12.5	-	7.5	3	

• Through coolant system is optional • The weight above exclude the face cutter

Parts

Division	Spare parts				
	Basic				Option
	Key	Clamp bolt	Key bolt	Wrench bolt	Wrench
Type					
FMA22	K8.0	MBA-M10	BX0310	-	LW-8
FMA22.225	K8.0	MBA-M10	BX0310	-	LW-8
FMA25.4	K9.5	MBA-M12	BX0412	BX1230	LW-10
FMA31.75	K12.7	MBA-M16	BX0516	-	LW-14
FMA38.1	K15.87	MBA-M20	BX0616	-	LW-17
FMA50.8	K19.05	MBA-M24	BX0820	-	LW-19
FMA47.625	K25.4	-	BX1020	BX1645	-
S-FMA25.4	-	-	-	-	LW-10
S-FMA31.75	-	-	-	-	LW-14



BT-FMC

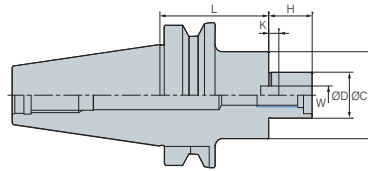

Fig. 1

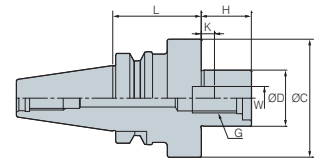

Fig. 2

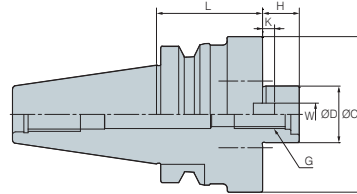
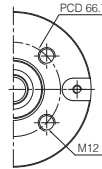

Fig. 3



											(mm)
Designation	Cutter dia.	ØD	L	ØC	H	W	K	G		Fig.	
BT30 -	FMC16 - 45	40	16	45	38	17	8	5.0	M8	0.7	1
	FMC22 - 45	50/63	22	45	48	19	10	5.6	M10	0.8	2
	FMC27 - 50	80	27	50	60	21	12	6.3	M12	1.2	2
BT40 -	FMC16 - 60	40	16	60	38	17	8	5.0	M8	1.2	1
	FMC22 - 45	50/63	22	45	48	19	10	5.6	M10	1.2	1
	FMC22 - 90	50/63	22	90	48	19	10	5.6	M10	1.2	1
	FMC27 - 60	80	27	60	60	21	12	6.3	M12	1.8	2
	FMC27 - 90	80	27	90	60	21	12	6.3	M12	3.2	2
	FMC32 - 60	100	32	60	78	24	14	7.0	M16	2.3	2
	FMC40 - 50	125/160	40	50	89	27	15.87	8.0	M20	3.3	3
BT50 -	FMC16 - 60	40	16	60	38	17	8	5.0	M8	3.9	1
	FMC22 - 60	50/63	22	60	48	19	10	5.6	M10	4.1	1
	FMC27 - 40	80	27	40	60	21	12	6.3	M12	4.1	1
	FMC27 - 90	80	27	90	60	21	12	6.3	M12	5.5	1
	FMC27 - 150	80	27	150	60	21	12	6.3	M12	6.1	1
	FMC32 - 45	100	32	45	78	24	14	7.0	M16	4.2	1
	FMC32 - 75	100	32	75	78	24	14	7.0	M16	4.2	1
	FMC32 - 105	100	32	105	78	24	14	7.0	M16	4.2	1
FMC40 - 50	125/160	40	50	89	27	15.87	8.0	M20	4.6	3	

• Through coolant system is optional • The weight above exclude the face cutter

Parts

Division	Spare parts				
	Basic				Option
	Key	Clamp bolt	Key bolt	Wrench bolt	Wrench
Type					
FMC 16	K8.0	-	BX0310	BX0830	LW-6
FMC 22	K10.0	-	BX0412	BX1030	LW-8
FMC 25.4	K9.5	-	BX0516	BX1230	LW-10
FMC 27	K12.0	MBA-M12	BX0616	-	LW-10
FMC 32	K14.0	MBA-M16	BX0616	-	LW-14
FMC38.1	K15.87	MBA-M16	BX0616	-	LW-14
FMC40	K15.87	MBA-M20	BX0616	-	LW-17



HSK-FMC

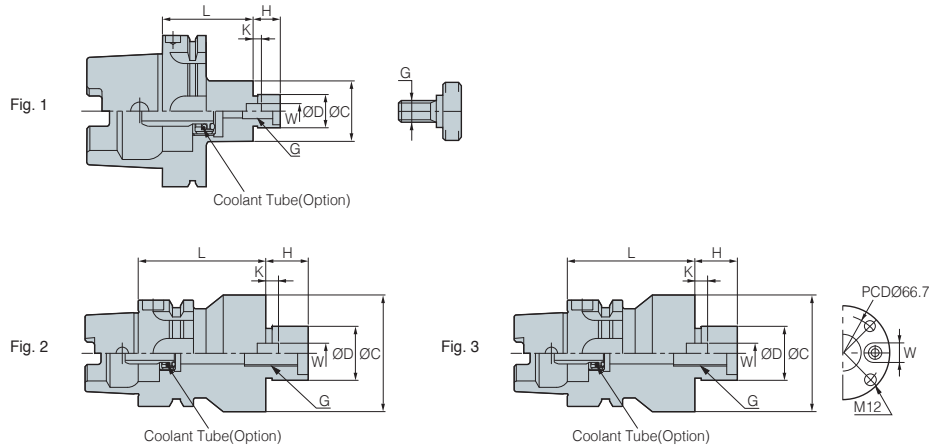





(mm)

Designation		Cuttter dia.	ØD	L	ØC	H	W	K	G		Fig.
HSK50A -	FMC16 - 40	40	16	40	38	17	8	5	M8	0.8	1
	FMC22 - 50	50/63	22	50	48	19	10	5.6	M10	0.9	1
HSK63A -	FMC16 - 50	40	16	50	38	17	8	5.0	M8	1.1	1
	FMC22 - 50	50/63	22	50	48	19	10	5.6	M10	1.2	1
	FMC27 - 60	80	27	60	60	21	12	6.3	M12	1.4	1
	FMC32 - 60	100	32	60	78	24	14	7.0	M16	1.8	2
	FMC40 - 60	125/160	40	60	89	27	15.87	8.0	M20	2	3

• Through coolant system is optional • The weight above exclude the face cutter

Parts

Division	Spare parts				
	Basic				Option
	Key	Clamp bolt	Key bolt	Wrench bolt	Wrench
Type					
FMC 16	K8.0	-	BX0310	BX0830	LW-6
FMC 22	K10.0	-	BX0412	BX1030	LW-8
FMC 25.4	K9.5	-	BX0516	BX1230	LW-10
FMC 27	K12.0	MBA-M12	BX0616	-	LW-10
FMC 32	K14.0	MBA-M16	BX0616	-	LW-14
FMC38.1	K15.87	MBA-M16	BX0616	-	LW-14
FMC40	K15.87	MBA-M20	BX0616	-	LW-17



Available for various angles

ANGULAR HEAD



Features

- Doubled effect by one equipment/Available for various angles
- Lighter aluminum body

Code system



Name of angular head parts

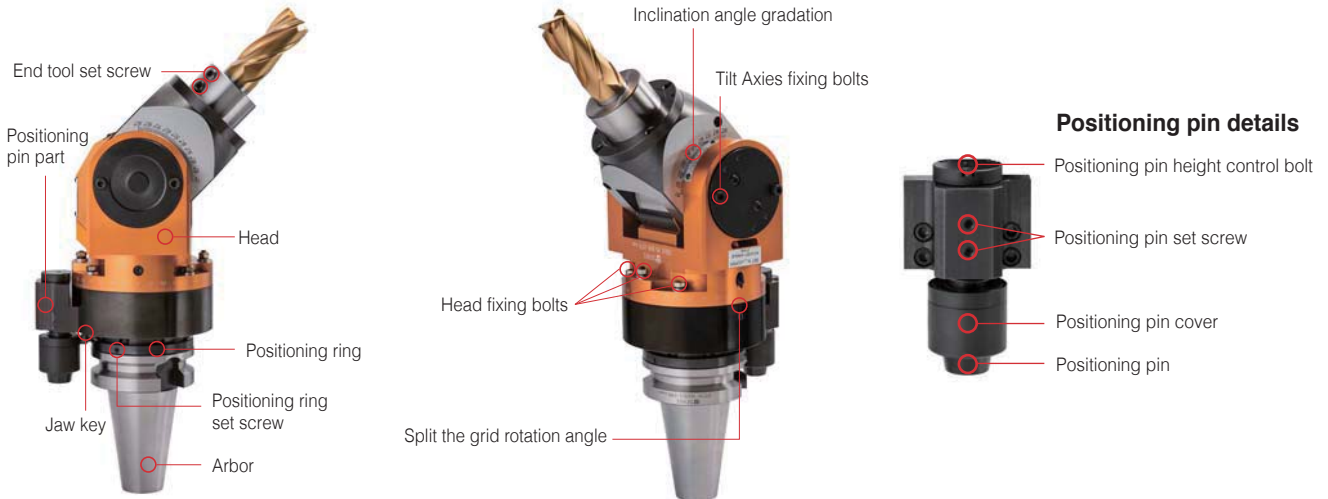

Various applications

0~90-degree rotating (MAH, KHU)	Fixed 90-degree type (KAH)	Fixed 45-degree type (KAC)	Attachment type (HRAG, KAG)

Components

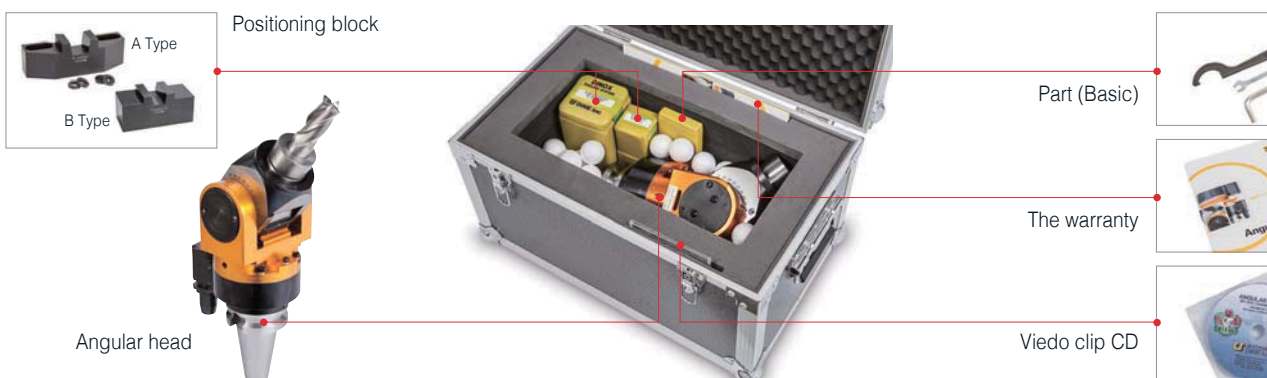

Technical Information for Angular Head

MAH

Universal type MAH (Reinforced series)

- Reinforced type Better performance by improving existing universal Angular head
 - Stability on large mold machining
 - Use 32mm Ball Endmill
 - Reinforced from KHU type



HRAG

Attachment type HRAG (Reinforced type)

- HRAG: The reinforced bracket enhanced durability upto 200%
 - Stability on face milling machining
 - Reinforced stiffness from KAG type



KHU

Universal type KHU

- Free angle adjusting up to 90°
 - HSK and SK type are order made

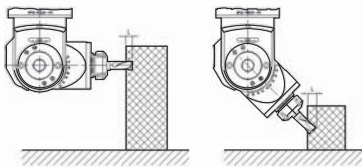

BT50-KHU20-195

KAG

Attachment type KAG

- Free 360° angle adjusting from side to side
 - Possible to use various tools of BT40 and BT30
 - HSK and SK type are order made

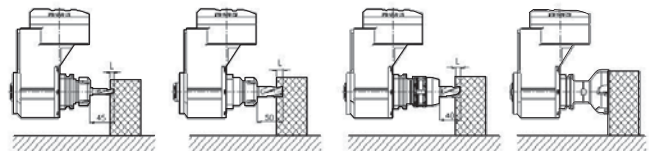

BT40-SDC20-60
(Ø12 E/M)

NT40-SDC20-60
(Ø20 E/M)

BT40-NPM20-85
(Ø20 E/M)

BT40-FMA25.4-45
(Ø80 Shoulder Mill)

KAH

Modular type KHU (90° type)

- Fixed 90° type angular head
 - In case of using a tap collet, please contact us in advance
 - HSK and SK type are order made

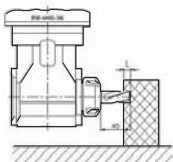

BT50-KAH20-200

KAC

Modular type KAC (45° type)

- Fixed 45° type angular head
 - HSK and SK type are order made



MHA for mold (0°~90°)_Reinforced type

BT-MAH

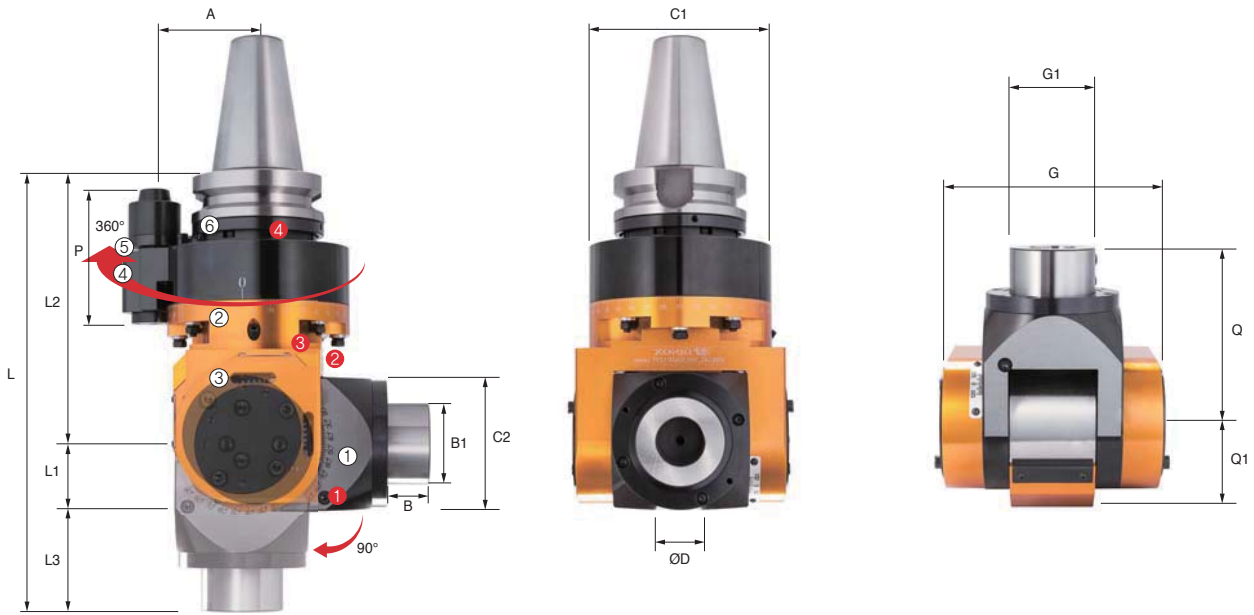

Positioning pin

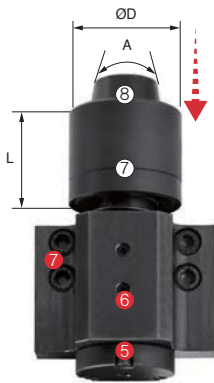

Shank size	L	A	ØD
BT50	56.5	30°	Ø40

NO	Name
①	Inclination angle gradation (Axial positioning in 0°~90°)
②	Rotating angle gradation (Free radius position in 360°)
③	Head
④	Positioning pin part
⑤	Jaw key
⑥	Positioning ring
⑦	Positioning pin cover
⑧	Positioning pin

NO	Part name	Designation
①	Inclination angle gradation screw	BT1216
②	Head fixed bolts	BT0645
③	Rotating angle gradation screw	BT0640
④	Positioning ring set screw	MSST5-12
⑤	Positioning pin height control bolt	BT0516
⑥	Positioning pin set screw	BT0512
⑦	Body position block set screw	BX0516

Designation	ØD	L	L1	L2	L3	C	C1	G	C2	Q	Q1	B	B1	P	A	MAX RPM	Install tool	kg
BT50-MAH32-200	32	200	47	78	325	136	95	154	95	125	63	31	60	95	80	3,000	SIDE LOCK	19



Angular Head Series

HRAG (90° fixed)_Reinforced type

BT-HRAG



Positioning pin

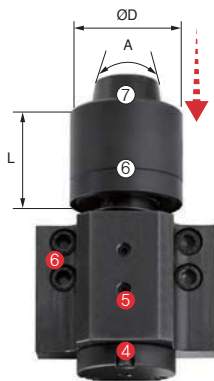

Shank size	L	A	ØD
BT50	56.5	30°	Ø40

NO	Name
①	Rotating angle graduation (Free radius position in 360°)
②	Head
③	Positioning pin part
④	Jaw key
⑤	Positioning ring
⑥	Positioning pin cover
⑦	Positioning pin

NO	Part name	Designation
①	Head fixed bolts	BX0660
②	Positioning ring set screw	MSST5-12
③	Rotating angle graduation screw	BT0648
④	Positioning pin height control bolt	BT0516
⑤	Positioning pin set screw	BT0512
⑥	Body position block set screw	BX0516
⑦	BT/NT Bolt	

Designation	L	L1	L2	L3	L4	Q	Q1	A	G	G1	MAX RPM	Tool shank	
BT50-HRAG40-230	230	56.5	145	46.5	276.5	89	101	80	93	136	3000	BT/NT40	15.75



KHU (0°~90°)_Collet type

BT-KHU

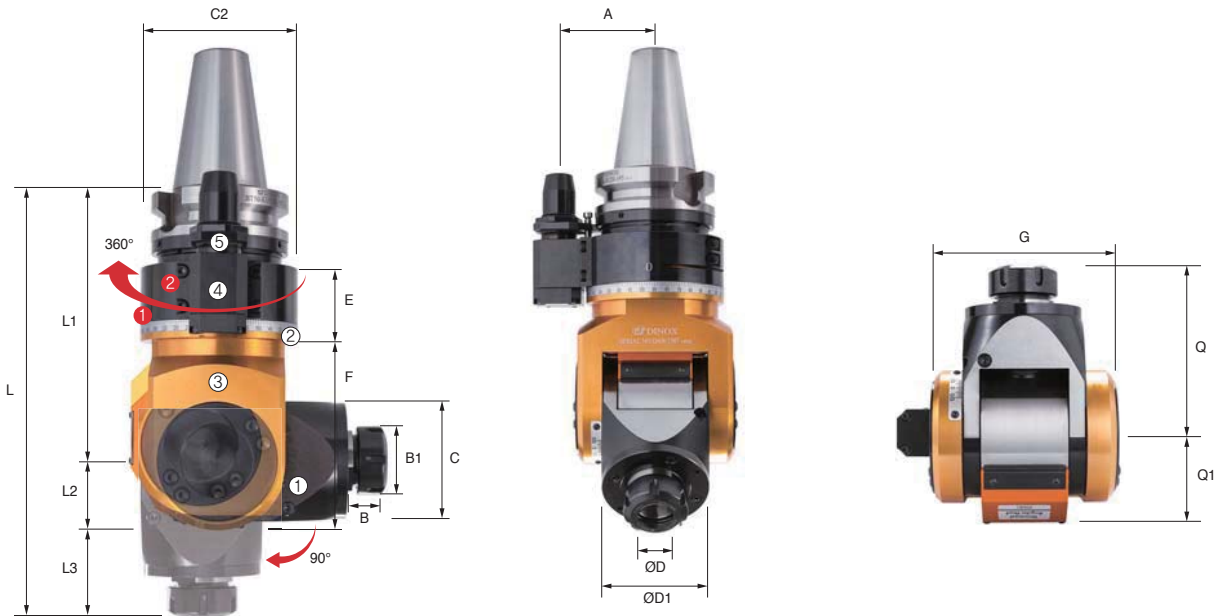

Positioning pin

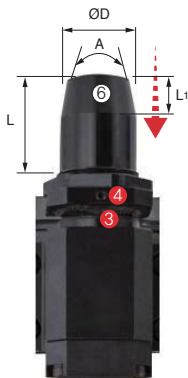

Shank size	L	L1	A	ØD
BT40	Max: 32 Min: 26	10	20°	Ø19.6
BT50	Max: 35 Min: 29	15		Ø28

NO	Name
①	Inclination angle gradation (Axial positioning in 0°~90°)
②	Rotating angle gradation (Free radius position in 360°)
③	Head
④	Positioning pin part
⑤	Jaw key
⑥	Height control wrench hole

NO	Part name	Designation
①	Bracket angle fixing bolt	BX0630
②	Position block fixing bolt	BX0512
③	Set screw	BT0404
④	Fixing bolts	BXS0630

Designation	ØD	ØD1	L	L1	L2	L3	B	B1	E	F	C	A	G	Q	Q1	Torque rate (IN: OUT)	Direction of rotation (IN: OUT)	MAX RPM	Collet	kg
BT40-KHU10-160	1.0~10.0	58	160	33	54	247	22	28	51	98	96	65	90	87	40	1: 2	CW: CW	6,000	GER16	6.4
BT50-KHU10-180	1.0~10.0	58	180	33	54	267	22	28	53	103	114	80	90	87	40	1: 2	CW: CW	6,000	GER16	10.5
BT50-KHU20-195	2.0~20.0	84	195	47	73	315	29	50	53	132	114	80	124	120	63	1: 1	CW: CW	3,000	GER32	15.8



Angular Head Series

KAG (90° fixed type)

BT-KAG



Positioning pin

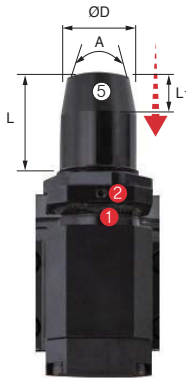

Shank size	L	L1	A	ØD
BT40	Max: 32 Min: 26	10	20°	Ø19.6
BT50	Max: 35 Min: 29	15		Ø28

NO	Name
①	Rotating angle graduation (Free radius position in 360°)
②	Head
③	Positioning pin part
④	Jaw key
⑤	Height control wrench hole

NO	Part name	Designation
①	Set screw	BT0404
②	Fixing bolts	BXS0630
③	BT / NT Bolt	

Designation	L1	L2	L3	L4	L5	L6	Q	Q1	A	C	G	Torque rate (IN: OUT)	Direction of rotation (IN: OUT)	MAX RPM	Holder shank	
BT40-KAG30-195	44	86	65	37.5	195	232.5	66	70	65	96	75	1: 1	CW: CW	4,000	BT30/NT30	6.4
BT50-KAG40-230	57	88	85	46.5	230	276.5	89	94	80	114	93	1: 1	CW: CW	3,000	BT40/NT40	15.8



HRAG (90° fixed)_Collet type

BT-KAH



Positioning pin

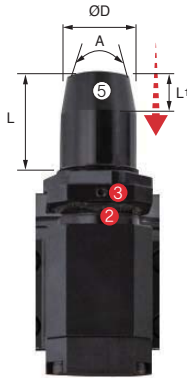

Shank size	L	L1	A	ØD
BT40	Max: 32 Min: 26	10	20°	Ø19.6
BT50	Max: 35 Min: 29	15		Ø28

NO	Name
①	Head
②	Rotating angle graduation (Free radius position in 360°)
③	Positioning pin part
④	Jaw key
⑤	Height control wrench hole

NO	Part name	Designation
①	Head fixing bolts	BX0618
②	Set screw	BT0404
③	Fixing bolts	BXS0630

Designation	ØD	L	L1	L2	L3	L4	B	A	P	Q	G	G1	Torque rate (IN: OUT)	MAX RPM	Collet	
BT40-KAH7-170	1.0~7.0	170	20	44	71	55	19	65	37	24.5	40	96	1: 1	5,000	GER11	4.6
BT40-KAH10-195	1.0~10.0	195	25	44	71	80	28	65	46	32	58	96	1: 1	5,000	GER16	5.8
BT40-KAH13-165	1.0~13.0	165	28	44	71	50	35	65	53	35	60	96	1: 1	5,000	GER20	5.7
BT40-KAH20-180	2.0~20.0	180	38	44	71	65	50	65	71	49	76	96	1: 1	3,500	GER32	6.7
BT50-KAH07-220	1.0~7.0	220	20	57	54	109	19	80	37	24.5	40	96	1: 1	5,000	GER11	9.8
BT50-KAH10-215	1.0~10.0	215	25	57	54	104	28	80	46	32	58	96	1: 1	5,000	GER16	10.7
BT50-KAH10-260	1.0~10.0	260	25	57	54	149	28	80	46	32	58	96	1: 1	5,000	GER16	11.0
BT50-KAH13-260	1.0~13.0	260	28	57	54	149	35	80	53	35	60	96	1: 1	5,000	GER20	11.2
BT50-KAH20-200	2.0~20.0	200	38	57	54	89	50	80	71	49	76	96	1: 1	3,500	GER32	11.6
BT50-KAH20-240	2.0~20.0	240	38	57	54	129	50	80	71	49	76	96	1: 1	3,500	GER32	12.4



Angular Head Series

KAC (45° fixed)_Collet type

BT-KAC

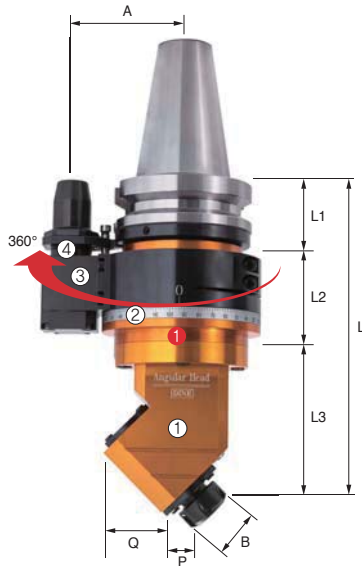

Positioning pin

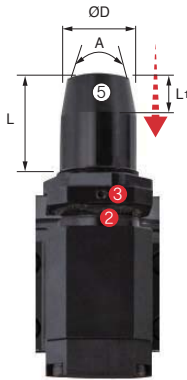

NO	Name
①	Head
②	Rotating angle graduation (Free radius position in 360°)
③	Positioning pin part
④	Jaw key
⑤	Height control wrench hole

NO	Part name	Designation
①	Head fixing bolts	BX0618
②	Set screw	BT0404
③	Fixing bolts	BXS0630

Shank size	L	L1	A	ØD
BT40	Max: 32 Min: 26	10	20°	Ø19.6
BT50	Max: 35 Min: 29	15		

Designation	ØD	L	L1	L2	L3	B	G	G1	P	Q	A	MAX RPM	Collet	kg
BT40-KAC10-220	1.0~10.0	220	44	71	105	28	60	96	25	54	65	5,000	GER16	5.3
BT40-KAC13-220	1.0~13.0	220	44	71	105	28	60	96	25	54	65	5,000	GER20	5.5
BT40-KAC20-230	2.0~20.0	230	44	71	115	50	72	96	30	60	65	3,500	GER32	6.8
BT50-KAC10-240	1.0~10.0	240	57	54	129	28	60	96	25	54	80	5,000	GER16	10.2
BT50-KAC13-240	1.0~13.0	240	57	54	129	28	60	96	25	54	80	5,000	GER20	10.4
BT50-KAC20-250	2.0~20.0	250	57	54	139	50	72	96	30	60	80	3,500	GER32	11.7



FBH back boring & balanced type

FBH/B

- High speed boring and back boring capability
- High precision balancing: G2.5, Head: G6.3
- Min. adjustment range: 2 μm



Code system



Working permission speed

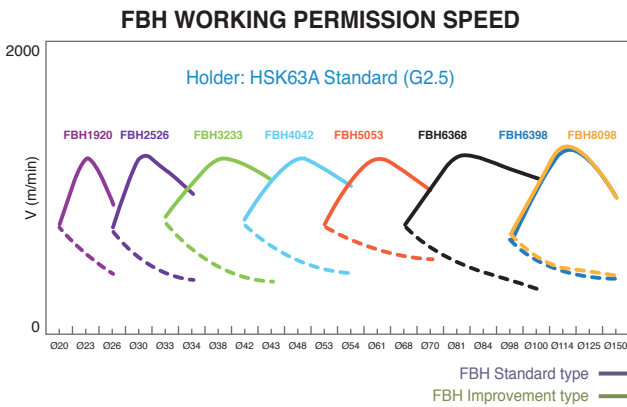

Boring range adjustment method

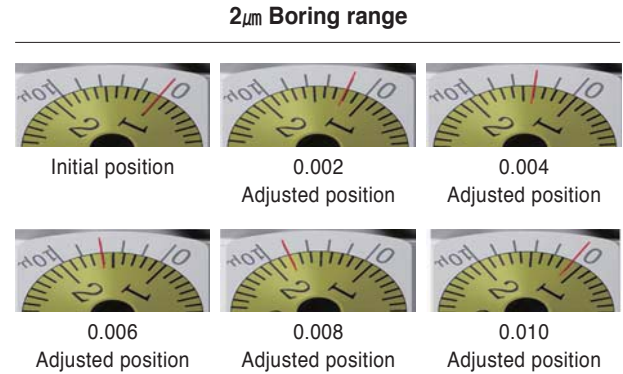

Back boring

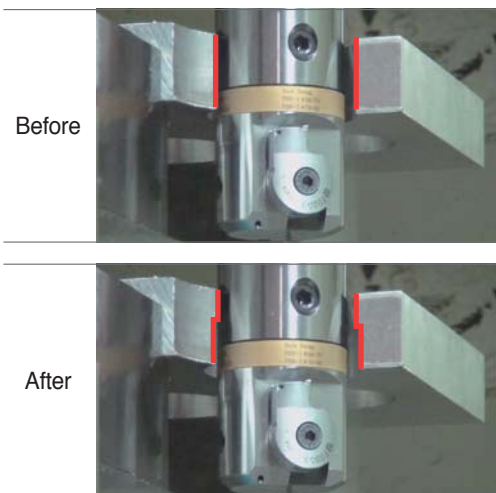

Adjusting machining direction available



Easy change of machining direction only by adjusting the bite



BT-FBH/B

Micro Boring Balance type

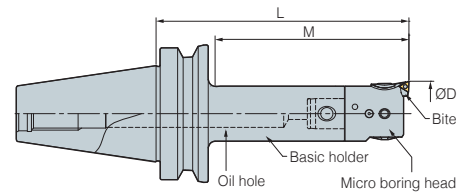

(mm)

Designation			Boring range ØD		L	Max. Boring depth		
Head	Bite	Body (Basic holder)	Min	Max				
FBH1920B	FBB20N-□-□□	BT30 - MD19F - 70R	20 (24)	26 (30)	103	60	0.5	
FBH2526B	FBB26N-□-□□		MD25F - 90R	26 (32)	34 (40)	127	80	0.7
FBH3233B	FBB33N-□-□□		MD32F - 80R	33 (40)	43 (50)	121	80	0.8
FBH4042B	FBB42N-□-□□		MD40F - 80R	42 (50)	54 (62)	127	96	1.1
FBH5053B	FBB53N-□-□□		MD50F - 70	53 (65)	70 (82)	127	97	1.7
FBH1920B	FBB20N-□-□□	BT40 - MD19F - 70R	20 (24)	26 (30)	103	45	1.9	
FBH2526B	FBB26N-□-□□		MD25F - 95R	26 (32)	34 (40)	133	59	2
FBH3233B	FBB33N-□-□□		MD32F - 100R	33 (40)	43 (50)	141	77	2.5
FBH4042B	FBB42N-□-□□		MD40F - 115R	42 (50)	54 (62)	162	107	3.1
FBH5053B	FBB53N-□-□□		MD50F - 105	53 (65)	70 (82)	162	135	3.5
FBH6368B	FBB68N-□-□□	MD63F - 110	68 (90)	100 (122)	181	154	6.3	
FBH6398B	FBB68N-□-□□		MD63F - 135	98 (120)	150 (172)	206	179	7.1
FBH8098B	FBB68N-□-□□	MD80F - 100	98 (120)	150 (172)	171	144	8.3	
FBH1920B	FBB20N-□-□□	BT50 - MD19F - 85	20 (24)	26 (30)	118	80	5.2	
FBH2526B	FBB26N-□-□□		MD25F - 105R	26 (32)	34 (40)	142	59	5.8
FBH3233B	FBB33N-□-□□		MD32F - 110R	33 (40)	43 (50)	151	77	6
FBH4042B	FBB42N-□-□□		MD40F - 195R	42 (50)	54 (62)	242	130	6.3
FBH5053B	FBB53N-□-□□		MD50F - 225R	53 (65)	70 (82)	282	182	6.6
FBH6368B	FBB68N-□-□□		MD63F - 230R	68 (90)	100 (122)	301	220	7.2
FBH6398B	FBB68N-□-□□		MD63F - 195R	98 (120)	150 (172)	266	191	8.5
FBH8098B	FBB68N-□-□□		MD80F - 175	98 (120)	150 (172)	246	208	12.8

☞ Spare Part 160

• Through coolant system available

• FBB bites are divided into two sorts Normal type: FBB□□N, Scalable type: FBB□□N-1

There are also the other options for your insert type: FBB□□N-□-C09 or T11

FBB□□N, FBB□□N-1: TPGT, TPGW0802□□L

FBB□□N-□-C: CCMT,CCGT0602□□L

FBB□□N-□-C09: CCMT,CCGT09T3□□L

FBB□□N-□-T11: TPGT1103□□L

FBH

FBH1920B

New Type

Micro Boring Head

(mm)

Designation	Boring range ØD		L	Scale ring 1rev. adjustable range	MD No.	
	Min	Max				
FBH - 1920B	20	26 (30)	33	Ø0.4 mm	MD1911	0.06
2526B	26	34 (40)	37	Ø0.4 mm	MD2514	0.12
3233B	33	43 (50)	41	Ø0.5 mm	MD3218	0.24
4042B	42	54 (62)	47	Ø0.5 mm	MD4022	0.41
5053B	53	70 (82)	57	Ø0.6 mm	MD5028	0.8
6368B	68	100 (122)	71	Ø0.8 mm	MD6336	1.7
6398B	98	150 (172)	71	Ø0.8 mm	MD6336	2.35

• Stock of basic holders, heads and bites are separately managed

• (): Max. boring diameter of extension type



S-FBH/B

Small Micro Boring

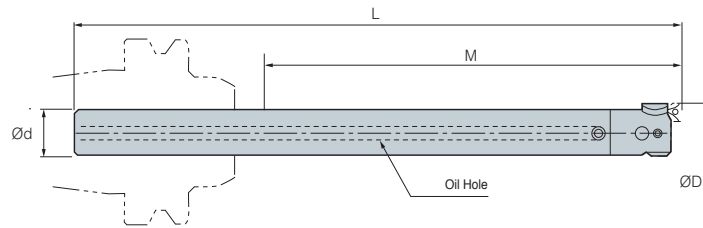

Designation	Shank dia $\varnothing d$	Boring range $\varnothing D$		L	M	Designation			kg		
		Min	Max			Basic shank	Boring head	Bite			
S19W -	FBH20B -	120	19	20	26	190	120	S19W-MD19F-157	FBH1920B	FBB20N	0.6
		140	19	20	26	210	140	S19W-MD19F-177	FBH1920B	FBB20N	0.7
		160	19	20	26	230	160	S19W-MD19F-197	FBH1920B	FBB20N	0.8
S25W -	FBH26B -	150	25	26	34	235	150	S25W-MD25F-197.5	FBH2526B	FBB26N	1.4
		175	25	26	34	260	175	S25W-MD25F-222.5	FBH2526B	FBB26N	1.6
		200	25	26	34	285	200	S25W-MD25F-247.5	FBH2526B	FBB26N	2
S32W -	FBH33B -	180	32	33	43	280	180	S32W-MD32F-239	FBH3233B	FBB33N	2.8
		240	32	33	43	340	240	S32W-MD32F-299	FBH3233B	FBB33N	3.5
S19 -	FBH20B -	40	19	20	26	110	40	S19-MD19F-77	FBH1920B	FBB20N	0.1
		80	19	20	26	150	80	S19-MD19F-117	FBH1920B	FBB20N	0.2
S25 -	FBH26B -	50	25	26	34	135	50	S25-MD25F-97.5	FBH2526B	FBB26N	0.4
		100	25	26	34	185	100	S25-MD25F-147.5	FBH2526B	FBB26N	0.6
S32 -	FBH33B -	90	32	33	43	190	90	S32-MD32F-149	FBH3233B	FBB33N	1.1
		120	32	33	43	220	120	S32-MD32F-179	FBH3233B	FBB33N	1.2

• Through coolant system available

S-FBH

Mini Small Micro Boring

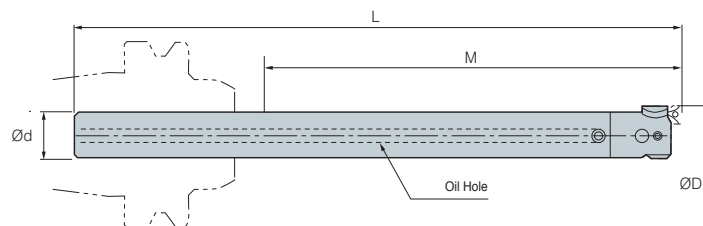

Designation	Shank dia $\varnothing d$	Boring range $\varnothing D$		L	M	Designation			kg		
		Min	Max			Basic shank	Boring head	Bite			
S14W	FBH15	85	14	15	18	155	85	S14W-M6-123	FBH15	FBB15-C	0.2
		110	14	15	18	180	110	S14W-M6-148	FBH15	FBB15-C	0.3
S16W	FBH18	95	16	18	22	165	95	S16W-M8-128	FBH18	FBB15-C	0.3
		125	16	18	22	195	120	S16W-M8-158	FBH18	FBB15-C	0.4
S14	FBH15	40	14	15	18	110	40	S14-M6-78	FBH15	FBB15-C	0.1
S16	FBH18	45	16	18	22	115	45	S16-M8-78	FBH18	FBB15-C	0.1

• Through coolant system available



Parts

Spare parts		
Type (FBH)	Lock screw	Clamp screw
FBH1920B	BTF0404	BXC0304
FBH2526B	BTF0505	BXC0405
FBH3233B	BTF0606	BXC0506
FBH4042B	BTF0808	BXC0610
FBH5053B	BTF0812	BXC0610
FBH6368B	BTF1016	BXC0810
FBH6398B	BTF1012	BXC0810
FBH8098B	BTF1014	BXC0810

FBB Bite (New type)

Designation	Boring range	Insert	Insert screw	Clamp bolt
FBB15C	Ø15~Ø18 mm	CCET0301-□□L	FTNA01633	BFTX02506N
	Ø18~Ø22 mm			
FBB20N	Ø20~Ø26 mm	TPGT0802□□L/TPGW0802□□	BFTX0204A	BXC0304
FBB20N-C		CCET0401□□L	BFTX0204N	
FBB20N-1	Ø24~Ø30 mm	TPGT0802□□L/TPGW0802□□	BFTX0204A	
FBB20N-1-C		CCET0401□□L	BFTX0204N	
FBB26N	Ø26~Ø34 mm	TPGT0802□□L/TPGW0802□□	BFTX0204A	BXC0405
FBB26N-C		CCET0401□□L	BFTX0204N	
FBB26N-1	Ø32~Ø40 mm	TPGT0802□□L/TPGW0802□□	BFTX0204A	
FBB26N-1-C		CCET0401□□L	BFTX0204N	
FBB33N	Ø33~Ø43 mm	TPGT0802□□L/TPGW0802□□	BFTX0204A	BXC0506
FBB33N-C		CCMT0602□□/CCGT0602□□	BFTX02506N	
FBB33N-1	Ø41~Ø50 mm	TPGT0802□□L/TPGW0802□□	BFTX0204A	
FBB33N-1-C		CCMT0602□□/CCGT0602□□L	BFTX02506N	
FBB42N	Ø42~Ø54 mm	TPGT0802□□L/TPGW0802□□	BFTX0204A	BXC0610
FBB42N-		CCMT0602□□/CCGT0602□□L	BFTX02506N	
FBB42N-11	Ø50~Ø62 mm	TPGT1103□□L	BFTX0307A	
FBB42N-1		TPGT0802□□L/TPGW0802□□	BFTX0204A	
FBB42N-1-C	Ø53~Ø70 mm	CCMT0602□□/CCGT0602□□L	BFTX02506N	
FBB42N-1-T11		TPGT1103□□L	BFTX0307A	
FBB53N	Ø53~Ø70 mm	TPGT0802□□L/TPGW0802□□	BFTX0204A	BXC0810
FBB53N-C		CCMT0602□□/CCGT0602□□L	BFTX02506N	
FBB53N-11	Ø65~Ø82 mm	TPGT1103□□L	BFTX0307A	
FBB53N-1		TPGT0802□□L/TPGW0802□□	BFTX0204A	
FBB53N-1-C	Ø68~Ø100 mm	CCMT0602□□/CCGT0602□□L	BFTX02506N	
FBB53N-1-C09		CCMT09T3□□/CCGT09T3□□L	BFTX0409N	
FBB53N-1-T11	Ø98~Ø150 mm	TPGT1103□□L	BFTX0307A	
FBB68N	Ø90~Ø122 mm	TPGT0802□□L/TPGW0802□□	BFTX0204A	BXC0810
FBB68N-C		CCMT09T3□□/CCGT09T3□□L	BFTX0409N	
FBB68N-11	Ø120~Ø172 mm	TPGT1103□□L	BFTX0307A	
FBB68N-1		TPGT0802□□L/TPGW0802□□	BFTX0204A	
FBB68N-1-C09		CCMT09T3□□/CCGT09T3□□L	BFTX0409N	
FBB68N-1-T11		TPGT1103□□L	BFTX0307A	



Balance cut tool for Rough boring

TBC

- Wide boring range for big diameters: Ø130~Ø540 mm
- Stable structure against for cutting load - Assembly by dove-tail structure
- Interconvert with FBC
 - Common boring head and rail adopted, different cartridge
- Light-weight (5%~20% reduced)
- Various cartridge approach angle: 15°, 45°



Code system



TBC boring tool structure & features

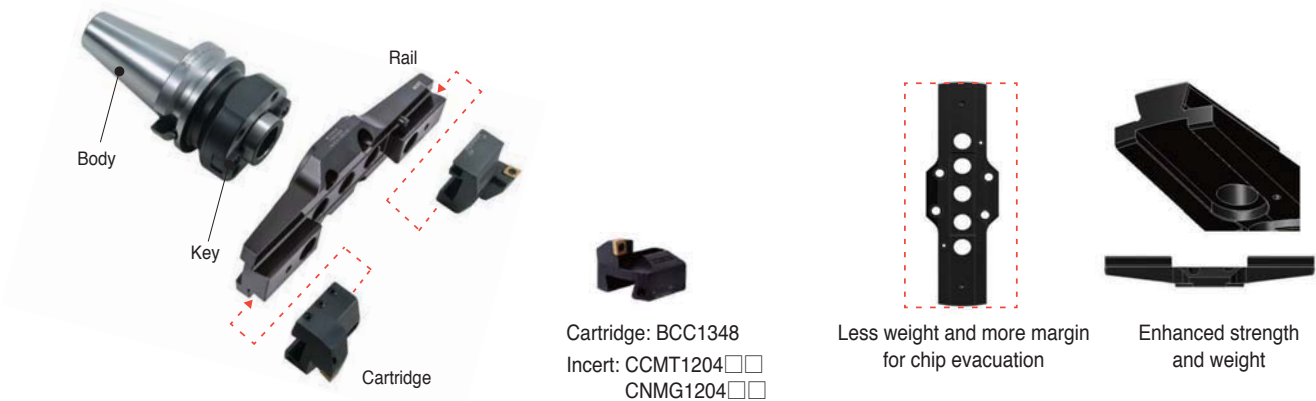

TBC boring tool cutting condition

Workpiece	Grade (HRC)	Cutting condition		
		Tip (Grade)	Cutting speed (m/min)	Feed per revolution f (mm/rev)
ALL	ADC12	"N"Material	"N"Material	0.1
Mild steel	SS41 (HB160)	P Material	P Material	0.1
Steel	S45C (H250)	P Material	P Material	0.1
Stainless steel	SUS304	M Material	M Material	0.1
Cast-iron	FC25 (HB250)	K Material	K Material	0.1

Boring range

Grade	Dia (Ø)		Body	Head set	Insert
	min	max			
TBC130	130	180	FMD50	TBC130S	CCMT1204□□
TBC175	175	225	FMD50	TBC175S	CCMT1204□□
TBC220	220	270	FMD50	TBC220S	CCMT1204□□
TBC265	265	315	FMD50	TBC265S	CCMT1204□□
TBC310	310	390	FMD50	TBC310S	CCMT1204□□
TBC385	385	465	FMD50	TBC385S	CCMT1204□□
TBC460	460	540	FMD50	TBC460S	CCMT1204□□



Technical Information for FBC

Balance cut tool for Fine boring

FBC

- Wide boring range for big diameters: $\varnothing 130 \sim \varnothing 540$ mm
- Interconvert with TBC
 - Common boring head and rail adopted, different cartridge [micro cartridge+balancing block]
- Various Insert according to bite
 - Applicable insert: CCMT09T3/1204, TPMT1103 (Cermet, cBN, PCD)



Code system

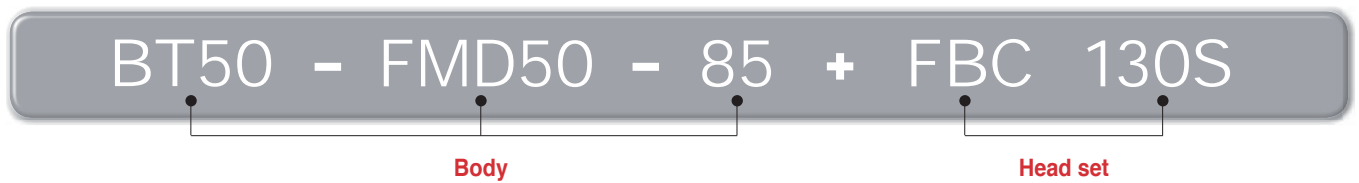

FBC boring tool structure & features

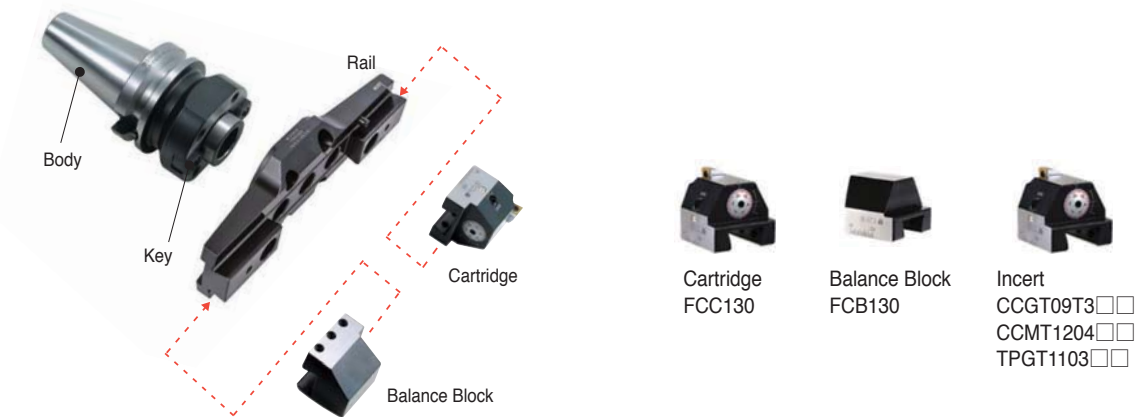

FBC boring tool cutting condition

Grade	Dia (Ø)		Head set	Insert
	min	max		
FBC130	130	180	FBC130S (TBR130+FCC130+FCB130)	FBB130-C09 (CCMT09T3□□, CCGT09T3□□) FBB130-C12 (CCMT1204□□) FBB130-T11 (TPMT1103□□,TPGT1103□□L)
FBC175	175	225	FBC175S (TBR175+FCC130+FCB130)	
FBC220	220	270	FBC220S (TBR220+FCC130+FCB130)	
FBC265	265	315	FBC265S (TBR265+FCC130+FCB130)	
FBC310	310	390	FBC310S (TBR310+FCC310+FCB310)	
FBC385	385	465	FBC385S (TBR385+FCC310+FCB310)	
FBC460	460	540	FBC460S (TBR460+FCC310+FCB310)	



TBC, FBC

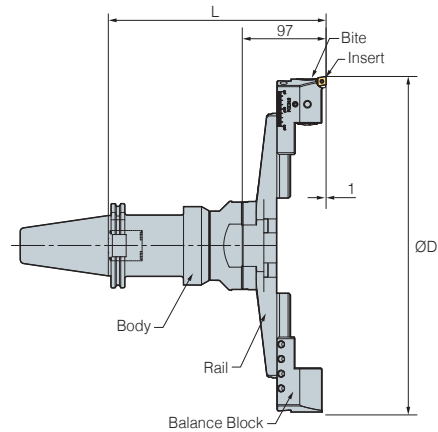

		Designation								Boring range	
Body	kg	Rough boring (TBC)				Finish boring (FBC)				Min	Max
		TBC HEAD SET (Rail+Cartridge)	L	kg	FBC HEAD SET (Rail+Cartridge+Balance block)	L	kg				
BT50 - FMD50 -	85	5.9	TBC130S (TBR130+BCC1348)	175	3.5	FBC130S (TBR130+FCC130+FCB130)	182	3.8	130	180	
	155	7.9	TBC130S (TBR130+BCC1348)	245	3.5	FBC130S (TBR130+FCC130+FCB130)	252	3.8	130	180	
	205	9.7	TBC130S (TBR130+BCC1348)	295	3.5	FBC130S (TBR130+FCC130+FCB130)	302	3.8	130	180	
	255	10.4	TBC130S (TBR130+BCC1348)	345	3.5	FBC130S (TBR130+FCC130+FCB130)	352	3.8	130	180	
	85	5.9	TBC175S (TBR175+BCC1348)	175	3.9	FBC175S (TBR175+FCC130+FCB130)	182	4.1	175	225	
	155	7.9	TBC175S (TBR175+BCC1348)	245	3.9	FBC175S (TBR175+FCC130+FCB130)	252	4.1	175	225	
	205	9.7	TBC175S (TBR175+BCC1348)	295	3.9	FBC175S (TBR175+FCC130+FCB130)	302	4.1	175	225	
	255	10.4	TBC175S (TBR175+BCC1348)	345	3.9	FBC175S (TBR175+FCC130+FCB130)	352	4.1	175	225	
	85	5.9	TBC220S (TBR220+BCC1348)	175	4.3	FBC220S (TBR220+FCC130+FCB130)	182	4.5	220	270	
	155	7.9	TBC220S (TBR220+BCC1348)	245	4.3	FBC220S (TBR220+FCC130+FCB130)	252	4.5	220	270	
	205	9.7	TBC220S (TBR220+BCC1348)	295	4.3	FBC220S (TBR220+FCC130+FCB130)	302	4.5	220	270	
	255	10.4	TBC220S (TBR220+BCC1348)	345	4.3	FBC220S (TBR220+FCC130+FCB130)	352	4.5	220	270	
	85	5.9	TBC265S (TBR265+BCC1348)	175	4.5	FBC265S (TBR265+FCC130+FCB130)	182	4.6	265	315	
	155	7.9	TBC265S (TBR265+BCC1348)	245	4.5	FBC265S (TBR265+FCC130+FCB130)	252	4.6	265	315	
	205	9.7	TBC265S (TBR265+BCC1348)	295	4.5	FBC265S (TBR265+FCC130+FCB130)	302	4.6	265	315	
	255	10.4	TBC265S (TBR265+BCC1348)	345	4.5	FBC265S (TBR265+FCC310+FCB310)	352	4.6	265	315	
	85	5.9	TBC310S (TBR310+BCC1354)	175	5.5	FBC310S (TBR310+FCC310+FCB310)	182	5.5	310	390	
	155	7.9	TBC310S (TBR310+BCC1354)	245	5.5	FBC310S (TBR310+FCC310+FCB310)	252	5.5	310	390	
	205	9.7	TBC310S (TBR310+BCC1354)	295	5.5	FBC310S (TBR310+FCC310+FCB310)	302	5.5	310	390	
	255	10.4	TBC310S (TBR310+BCC1354)	345	5.5	FBC310S (TBR310+FCC310+FCB310)	352	5.5	310	390	
85	5.9	TBC385S (TBR385+BCC1354)	175	5.8	FBC385S (TBR385+FCC310+FCB310)	182	5.8	385	465		
155	7.9	TBC385S (TBR385+BCC1354)	245	5.8	FBC385S (TBR385+FCC310+FCB310)	252	5.8	385	465		
205	9.7	TBC385S (TBR385+BCC1354)	295	5.8	FBC385S (TBR385+FCC310+FCB310)	302	5.8	385	465		
255	10.4	TBC385S (TBR385+BCC1354)	345	5.8	FBC385S (TBR385+FCC310+FCB310)	352	5.8	385	465		
85	5.9	TBC460S (TBR460+BCC1354)	175	12.8	FBC460S (TBR460+FCC310+FCB310)	182	12.8	460	540		
155	7.9	TBC460S (TBR460+BCC1354)	245	12.8	FBC460S (TBR460+FCC310+FCB310)	252	12.8	460	540		
205	9.7	TBC460S (TBR460+BCC1354)	295	12.8	FBC460S (TBR460+FCC310+FCB310)	302	12.8	460	540		
255	10.4	TBC460S (TBR460+BCC1354)	345	12.8	FBC460S (TBR460+FCC310+FCB310)	352	12.8	460	540		

*Bites for FBC are sold separately



FBB Bite (For FBC)



(mm)

Designation	Insert
FBB130 - C09	CCMT09T3□□, CCGT09T3□□
C12	CCMT1204□□
T11	TPMT1103□□, TPGT1103□□

• TBC and DBC cartridges with tip angle of 15°/45° can be purchased by order (45° basis)

Parts



Division	Spare parts								
	Basic								
	Rail	Cartridge	Cartridge	Clamp bolt	Clamp bolt	Balance block	Wrench	Clamp screw	Torx wrench
Type									
TBC130S	TBR130	BCC1348	-	BX0820	BT0645	-	LW-3	BFTX0511N	TW20
TBC175S	TBR175								
TBC220S	TBR220								
TBC265S	TBR265								
TBC310S	TBR310	BCC1354 (BCN1354)	-	BX0820	BT0660	-	LW-3	-	-
TBC385S	TBR385								
TBC460S	TBR460	-	FCC130	BX0820	BT0645	FCB130	LW-3	-	-
FBC130S	TBR130								
FBC175S	TBR175								
FBC220S	TBR220								
FBC265S	TBR265								
FBC310S	TBR310								
FBC385S	TBR385								
FBC460S	TBR460								
			FCC310		BT0660	FCB310			



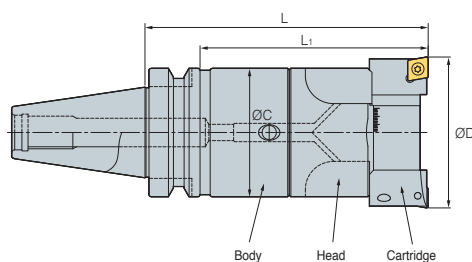







BT-DBC



(mm)

Designation				Boring range ØD		L	Max. Boring depth
Micro boring head	 kg	Body (Basic holder)	 kg	Min	Max		
DBC2528S	0.3	BT30-MD25F-90R	0.4	28	35	140	93
DBC3235S	0.4	BT30-MD32F-80R	0.4	35	46	145	114
DBC4046S	0.6	BT30-MD40F-80R	0.5	46	58	150	119
DBC5058S	1.1	BT30-MD50F-70	0.8	58	74	150	128
DBC2528S	0.3	BT40-MD25F-105R	1.9	28	35	165	100
DBC3235S	0.4	BT40-MD32F-115R	2.4	35	46	180	110
DBC4046S	0.6	BT40-MD40F-110R	2.7	46	58	180	130
DBC5058S	1.1	BT40-MD50F-100R	2.7	58	74	180	130
DBC6374S	2.0	BT40-MD63F-90	3.6	74	94	180	150
DBC8094S	3.5	BT40-MD80F-100	4.8	94	120	200	173
DBC2528S	0.3	BT50-MD25F-120R	4.7	28	35	180	100
DBC3235S	0.4	BT50-MD32F-235R	5.3	35	46	300	180
DBC4046S	0.6	BT50-MD40F-230R	5.6	46	58	300	250
DBC5058S	1.1	BT50-MD50F-250R	6.5	58	74	330	280
DBC6374S	2.0	BT50-MD63F-240R	8.4	74	94	330	280
DBC8094S	3.5	BT50-MD80F-175	9.5	94	120	275	225
DBC120S	5.3	BT50-MD80F-175	9.5	120	175	275	235

Parts

Division	Spare parts								
	Basic								
	Head	Spring pin	Wrench bolt	Wrench	Cartridge	Set screw	Wrench	Clamp screw	Torx wrench
Type									
DBC2528S	DBC2528	SP0308	BX0415	LW-3	BCC28	BT0306	LW-1.5	FTKA02565	TRX7
DBC3235S	DBC3235	SP0410	BX0515	LW-4	BCC35	BT0308			
DBC4046S	DBC4046	SP0516	BX0620	LW-5	BCC46	BT0410	LW-2	FTNA0408	TRX15
DBC5058S	DBC5058	SP0616			BCC58	BT0412			
DBC6374S	DBC6374	SP1018	BX0830	LW-6	BCC74	BT0516	LW-2.5	BFTX0511N	TRX20
DBC8094S	DBC8094	SP1020	BX1035	LW-8	BCC94	BT0620	LW-3		
DBC120S	DBC120N	SP1020	BX0830	LW-6.0	BCC120	BT0830	LW-4.0	BFTX0511N	TRX20



BT-KMB

Micro Boring

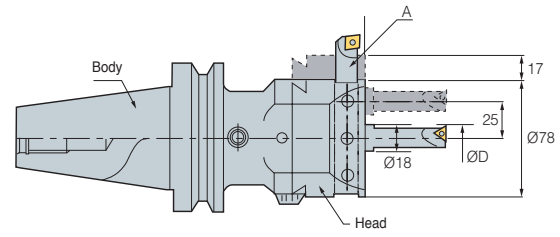

1DIV = Ø0.02mm

(mm)

Designation	Head (Modular)	Boring bite	L	L ₁	
BT40 - MD63F - 64	KMB6336	BB18-□(S)	141	64	5.5
BT50 - MD63F - 75	KMB6336	BB18-□(S)	152	75	7.0

Boring head	Bite	MD NO.	L	
KMB6336	BB18-□(S)	BT□□-MD63F	77	2.2

• Through coolant system is optional



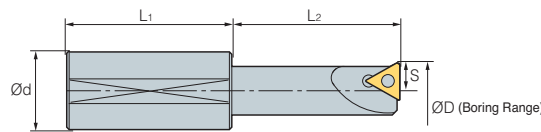

⦿ Boring bite: BBtype (For KMB)



(mm)

Designation	Boring range (Center)		Boring range (Side)		S	L ₁	L ₂	Insert	Insert Screw	
	Min	Max	Min	Max						
BB	18-7(S)	7	40	43	91	3.5	30	30	TBGT0601□□L	BFTX0204A
	18-9(S)	9	42	45	93	4.5	30	40	TPGT0802□□L	BFTX0204A
	18-11(S)	11	44	47	95	5.5	30	45	TPGT1103□□L	BFTX0307A
	18-13(S)	13	46	49	97	6.5	40	45	TPGT1103□□L	BFTX0307A
	18-15(S)	15	48	51	99	7.5	40	50	TPGT1103□□L	BFTX0307A
	18-17(S)	17	50	53	101	8.5	40	50	TPGT1103□□L	BFTX0307A

⦿ Parts

Division	Spare parts				
	Basic			Option	
	Boring head	Taper screw	Wrench	Boring bite	Basic holder
Type					
KMB	KMB6336	BTT1620F	LW-8	BB18	MD63F



BT-SMB

Small Micro Boring Bar

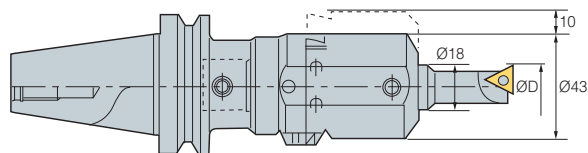

1DIV = Ø0.02mm

(mm)

Designation			Head (Modular)	Boring bite	L	L ₁	
BT40 -	MD40F -	60	SMB4022	BB18-O(S)	122.5	60	2.8
BT50 -	MD40F -	60	SMB4022	BB18-O(S)	122.5	60	5.4

Boring head	Bite	MD NO.	L	
SMB4022	BB18-O(S)	BTOO-MD40T	62.5	0.6



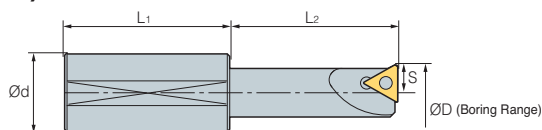

• Through coolant system not available

 Boring bite: BBtype (For SMB)

(mm)

Designation	Boring range		S	L ₁	L ₂	Insert	Insert screw	
	Min	Max						
BB	18-7(S)	7	27	3.5	30	30	TBGT0601□□L	BFTX0204A
	18-9(S)	9	29	4.5	30	40	TPGT0802□□L	BFTX0204A
	18-11(S)	11	31	5.5	30	45	TPGT1103□□L	BFTX0307A
	18-13(S)	13	33	6.5	40	45	TPGT1103□□L	BFTX0307A
	18-15(S)	15	35	7.5	40	50	TPGT1103□□L	BFTX0307A
	18-17(S)	17	37	8.5	40	50	TPGT1103□□L	BFTX0307A

 Parts

Division	Spare parts				
	Basic			Option	
	Boring head	Taper screw	Wrench	Boring bite	Basic holder
Type					
SMB	SMB4022	BTT1013F	LW-5	BB18	MD40F



BT-SMH

Small Micro Boring Bar (For High Precision)

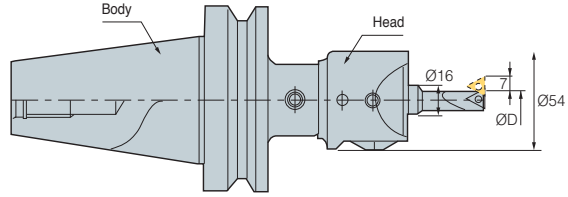

(mm)

Designation	Head (Modular)	Boring bite	L	L ₁	
BT40 - MD40F - 60	SMH4022	BB16-O(S)	109	60	3.0
BT50 - MD40F - 60	SMH4022	BB16-O(S)	109	60	6.0

Boring head	Bite	MD NO.	L	
SMH4022	BB18-O(S)	BTOO-MD40F	49	2.7

• Through coolant system not available

➤ Boring bite: BBtype (For SMH)

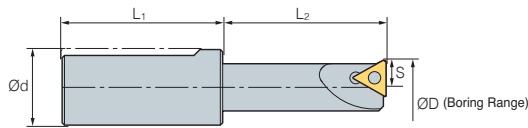

(mm)

Designation	Boring range ØD		S	L ₁	L ₂	Insert	Insert screw	Wrench	
	Min	Max							
BB	16-5(S)	5.5	19	2.75	34	20	WBG0601□□L	BFTX0203A	TRX06
	16-7(S)	7	21	3.5	34	30	TBGT0601□□L	BFTX0204A	TRX06
	16-9(S)	9	23	4.5	34	40	TPGT0802□□L	BFTX0204A	TRX06
	16-11(S)	11	25	5.5	34	45	TPGT1103□□L	BFTX0307A	TRX10
	16-15(S)	15	29	7.5	34	50	TPGT1604□□L	BFTX0307A	TRX10
	16-19(S)	19	33	9.5	34	60	TPGT1103□□L	BFTX0410A	TRX15

➤ Parts

Division	Spare parts				
	Basic			Option	
	Boring head	Taper screw	Wrench	Boring bite	Basic holder
Type					
SMH	SMH4022	BTT1013F	LW-5	BB16	MD40F



Versatile tooling system that can flexibly react to FMS

Modular System Series

- Versatile tooling system conforming to FMS specification
- Flexible combination of tool units according to conditions of subject
- Joining with a specially designed screw provides high accuracy (error less than $5\mu\text{m}$) and ease of detach for one step setting
- Cutting edge of boring system aligned with the groove of drive key
- Corresponding accuracy and stiffness compared to uni-body type

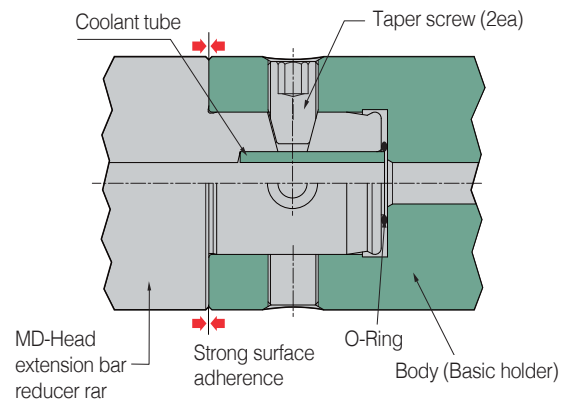
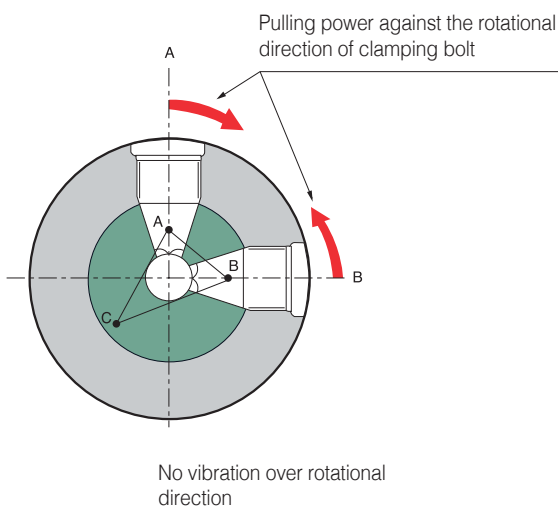

BT-MD

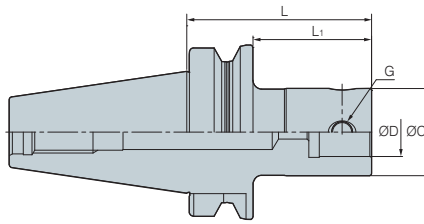

Fig. 1

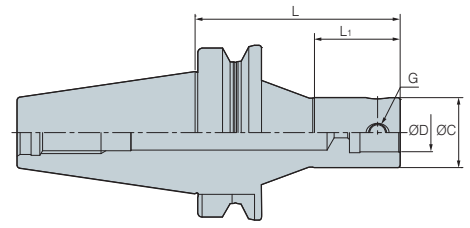



Fig. 2

(mm)

Designation	ØC	ØD	L	L ₁	G	 kg	Fig.	
BT30 -	MD19F - 70	19	11	70	45	M5	0.4	1
	MD25F - 90	25	14	90	63	M6	0.3	1
	MD32F - 80	32	18	80	55	M8	0.4	1
	MD40F - 45	40	22	45	22	M8	0.4	1
	MD40F - 60	40	22	60	36	M10	0.5	1
	MD40F - 80	40	22	80	56	M10	0.5	1
	MD50F- 70	50	28	70	48	M12	0.8	3
BT40 -	MD19F- 70	19	11	70	40	M5	1.8	1
	MD25F- 95	25	14	95	63	M6	1.9	1
	MD25F- 105R	25	14	105	40	M6	1.9	2
	MD32F- 100	32	18	100	70	M8	2.3	1
	MD32F- 115R	32	18	115	45	M8	2.4	2
	MD40F- 60	40	22	60	31	M10	2.7	1
	MD40F- 110R	40	22	110	60	M10	2.7	2
	MD40F- 115	40	22	115	83	M10	2.7	1
	MD50F- 105	50	28	105	73	M12	2.7	1
	MD63F- 64	63	36	64	37	M16	3.3	1
	MD63F- 110	63	36	110	83	M16	3.6	1
	MD63F- 135	63	36	135	108	M16	4.6	1
	MD80F- 100	80	45	100	73	M16	4.8	3
BT50 -	MD19F- 85	19	11	85	44	M5	4.3	1
	MD25F- 105	25	14	105	62	M6	4.5	1
	MD25F- 120R	25	14	120	40	M6	4.7	2
	MD32F- 110	32	18	110	67	M8	5.1	1
	MD32F- 115R	32	18	115	45	M8	5.1	2
	MD32F- 235R	32	18	235	115	M8	5.3	2
	MD40F- 60	40	22	60	22	M10	5.0	1
	MD40F- 195	40	22	195	152	M10	5.4	1
	MD40F- 230R	40	22	230	180	M10	5.6	2
	MD50F- 125	50	28	125	82	M12	6.0	1
	MD50F- 225	50	28	225	182	M12	6.4	1
	MD50F- 250R	50	28	250	81	M12	6.5	2
	MD63F- 75	63	36	75	35	M16	6.0	1
	MD63F- 130	63	36	130	87	M16	6.8	1
	MD63F- 195	63	36	195	152	M16	8.0	1
	MD63F- 230	63	36	230	187	M16	8.4	1
	MD80F- 75	80	45	75	36	M16	9.1	1
	MD80F- 110	80	45	110	69	M16	9.4	1
	MD80F- 175	80	45	175	134	M16	9.5	1
	MD90F- 75	90	45	75	34	M16	9.3	1
	MD90F- 145	90	45	145	104	M16	9.9	1
MD90F- 195	90	45	195	154	M16	10.2	1	

 Spare Part 171

• Through coolant system available • Order made body available



HSK-MD

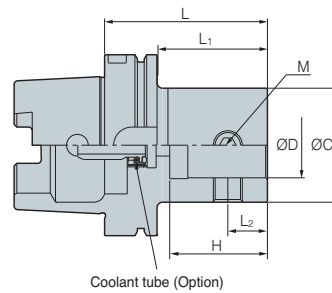



(mm)

Designation	ØC	ØD	L	L ₁	L ₂	H	M	
HSK 63A -	MD19F - 60	19	11	60	34	6.5	15.5	M5
	MD25F - 60	25	14	60	31	8	18.5	M6
	MD32F - 65	32	18	65	31	11	23.5	M8
	MD40F - 70	40	22	70	41	13	29	M10
	MD50F - 85	50	28	85	58	17	36	M12
	MD63F - 95	63	36	95	69	22	54	M16

• Through coolant system available

Parts

Division	Spare parts	
	Basic	Option
	Taper screw	Wrench
Type		
MD19F	BTT0506F	LW-2.5
MD25F	BTT0608F	LW-3
MD32F	BTT0810F	LW-4
MD40F	BTT1013F	LW-5
MD50F	BTT1215F	LW-6
MD63F	BTT1620F	LW-8
MD80F	BTT1626F	LW-8
MD90F	BTT1631F	LW-8



EXT

Extension Bar

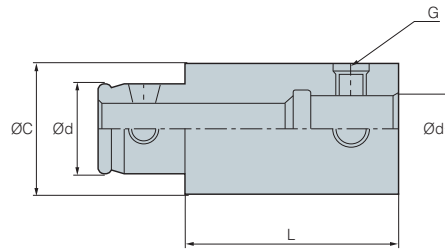

(mm)

Designation	ØC	Ød	L	Ød ₁	G
EXT - 1930F	19	11	30	11	M5
1950F	19	11	50	11	M5
2530F	25	14	30	14	M6
2550F	25	14	50	14	M6
3235F	32	18	35	18	M8
3260F	32	18	60	18	M8
4040F	40	22	40	22	M10
4090F	40	22	90	22	M12
5050F	50	28	50	28	M12
50100F	50	28	100	28	M12
6360F	63	36	60	36	M16
63120F	63	36	120	36	M16
8070F	80	45	70	45	M16
80120F	80	45	120	45	M16
9080F	90	45	80	45	M16
90130F	90	45	130	45	M16

• Through coolant system available



RDC

Reducer Bar

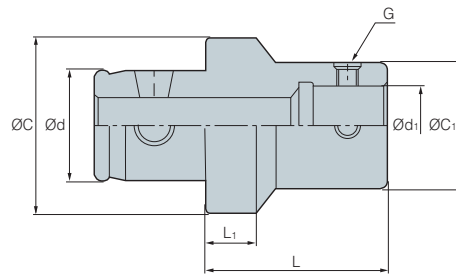



(mm)

Designation	Ød	ØC1	Ød1	ØC	L	L ₁	G
RDC - 3225F	18	25	14	32	30	9	M6
4025F	22	25	14	40	30	9	M6
4032F	22	32	18	40	30	9	M8
5025F	28	25	14	50	30	9	M6
5032F	28	32	18	50	30	9	M8
5040F	28	40	22	50	40	10	M10
6325F	36	25	14	63	30	9	M6
6332F	36	32	18	63	30	9	M8
6340F	36	40	22	63	40	10	M10
6350F	36	50	28	63	45	10	M12
8032F	45	32	18	80	30	9	M6
8040F	45	40	22	80	40	10	M10
8050F	45	50	28	80	45	10	M12
8063F	45	63	36	80	50	13	M16

• Through coolant system available

Parts

Division	Spare parts		
	Basic		Option
	Taper screw	Spring pin	Wrench
Type			
MD19F	BTT0506F	-	LW-2.5
MD25F	BTT0608F	SP0308	LW-3
MD32F	BTT0810F	SP0410	LW-4
MD40F	BTT1013F	SP0516	LW-5
MD50F	BTT1215F	SP0616	LW-6
MD63F	BTT1620F	SP0818	LW-8
MD80F	BTT1626F	SP1020	LW-8
MD90F	BTT1631F	SP1020	LW-8





KORLOY Anti-Vibration tool

KORLOY DAMPING PRO

- The application of a special design provides an excellent Anti-Vibration effect and is optimized for Overhang work
- Capable to elevate Feed comparing to standard arbor with stable machining
- Longer tool life and noise decrease
- Provides a solution for Mold, Deep Cavity machining, and Heavy-duty work

Code system

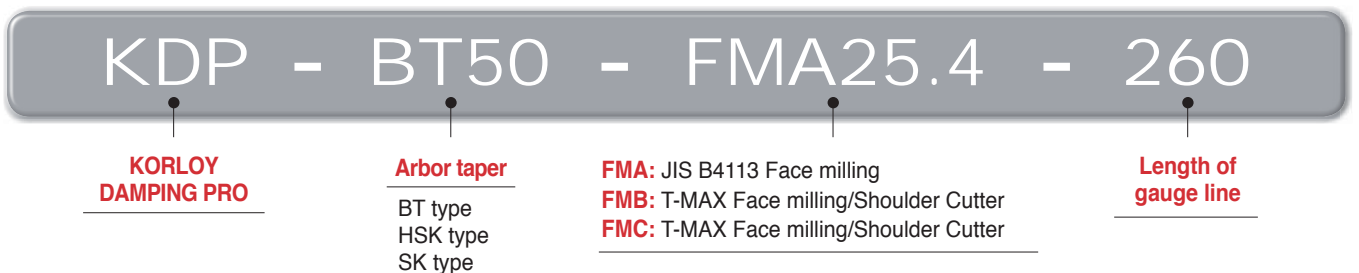

Features



- Anti-Vibration: Exclusively designed Anti-Vibration structure
- Material: Special alloy steel
- Anti-Vibration body: Application of high density damper
- Overhang: Capable for 2D~5D
- Coolant: Inner coolant is capable



BT type



HSK type



SK type

Various types and sizes are applicable

Comparison of vibration damping time

Standard arbor

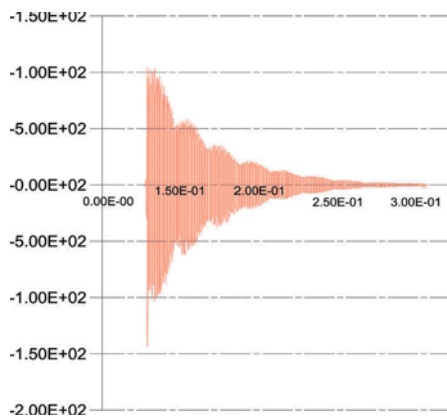
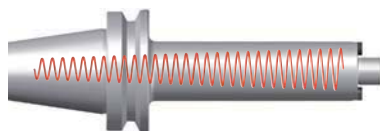

Longer Vibration damping time/
Chattering is caused while Overhang work

KORLOY DAMPING PRO

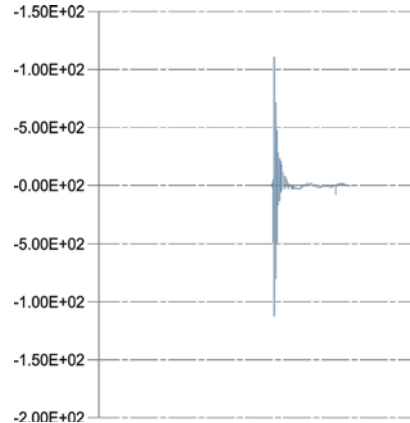
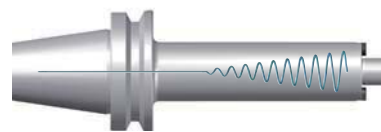

Short Vibration damping time/
Performance is 2~3 times better than standard arbor



Performance evaluation

- **Cutting condition:** fz (mm/t) = 0.1
vc (m/min) = 100
- **Cutter:** AMC4063HS 6flute
- **Arbor:** BT50-FMC22-210 General arbor
KDP-BT50-FMC22-210 Damping pro

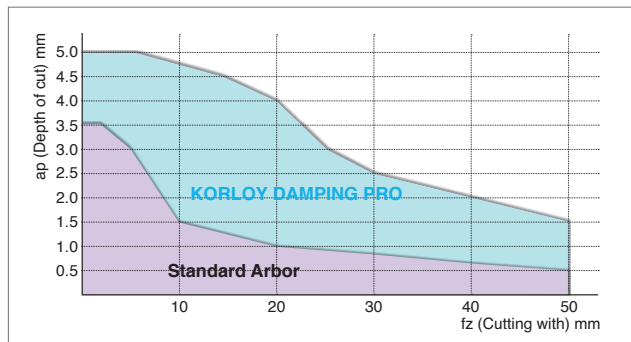

- **Cutting condition:** fz (mm/t) = 0.1
vc (m/min) = 100
- **Cutter:** FMRC3063HRD-H 6flute
- **Arbor:** BT50-FMC22-210 General arbor
KDP-BT50-FMC22-210 Damping pro

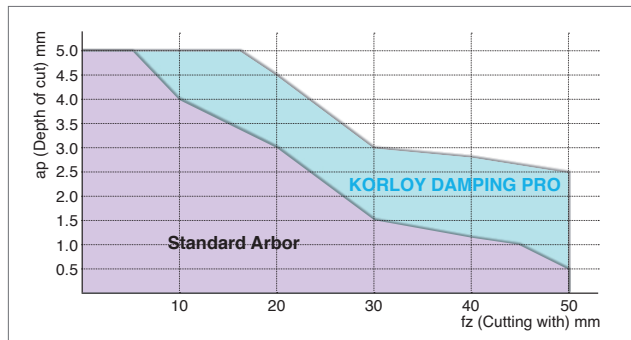

Application examples

Mold machining	Side milling cutter machining	Facing for long depth	Deep-hole Boring machining
Better productivity than general arbor	Excellent performance in the deep grooving	Better productivity and surface roughness than general arbor	Better surface roughness and machinability than general arbor

Side milling cutter machining example

- Faulty occurrence on size and surface roughness by the vibration, when use the general arbor
- **Using DAMPING PRO, good size and surface roughness**



- **General arbor**
Cutting condition:
vc (m/min) = 50
fz (mm/t) = 0.1
ae (mm) = 20
- **DAMPING PRO**
Cutting condition:
vc (m/min) = 100
fz (mm/t) = 0.1
ae (mm) = 20

Big size Crankshaft machining example

- General arbor: ap = 2 mm
- KORLOY DAMPING PRO: ap = 4mm available
- **2 times better productivity**



- **General arbor**
Cutting condition:
vc (m/min) = 100
fz (mm/t) = 0.15
ap (mm) = 2
- **DAMPING PRO**
Cutting condition:
vc (m/min) = 100
fz (mm/t) = 0.15
ap (mm) = 4

BT-FMA

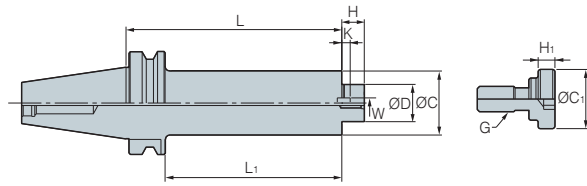

Fig. 1

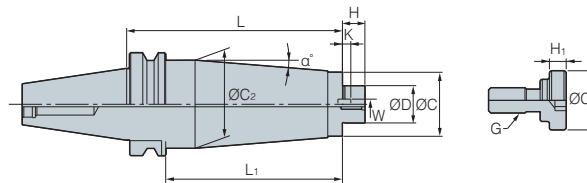

Fig. 2

(mm)

Designation	Cutter dia.	ØD	L	L ₁	ØC	ØC ₂	H	W	K	G	ØC ₁	H ₁	kg	Fig.	α°	
KDP-BT40 -	FMA25.4 - 210	80	25.4	210	183	50	60	22	9.5	5	M12	33	10	5.42	2	1
	FMA25.4 - 260	80	25.4	260	233	50	60	22	9.5	5	M12	33	10	6.5	2	1.1
	FMA31.75 - 210	100	31.75	210	183	60	-	30	12.7	7	M16	40	10	5.94	1	-
	FMA31.75 - 260	100	31.75	260	233	60	-	30	12.7	7	M16	40	10	7.25	1	-
KDP-BT50 -	FMA25.4 - 210	80	25.4	210	172	50	78	22	9.5	5	M12	33	10	9.63	2	4
	FMA25.4 - 260	80	25.4	260	222	50	78	22	9.5	5	M12	33	10	11.8	2	3
	FMA31.75 - 210	100	31.75	210	172	60	85	30	12.7	7	M16	40	10	11.8	2	3
	FMA31.75 - 260	100	31.75	260	222	60	85	30	12.7	7	M16	40	10	13.6	2	2.5

- The A type is for JIS B4113 Face milling
- The B type and C type are arbors for T-MAX Face Milling and shoulder cutter
- The weight (kg) shown in the chart does not include the weight of face cutter
 - Key and screw are clamped
 - Wrench is separately sold

Parts

Division	Spare parts				
	Basic				Option
	Key	Clamp bolt	Wrench bolt	Wrench bolt	Wrench
Type					
FMA25.4	K9.5(B)	MBA-M12	BX0412	BX1225	LW-10
FMA31.75	K12.7(D)	MBA-M16	BX0515	-	LW-14



BT-FMC

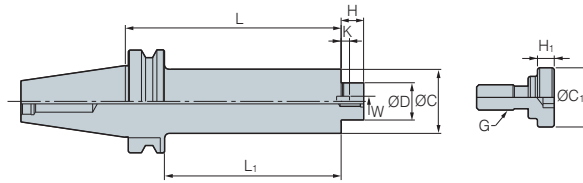

Fig. 1

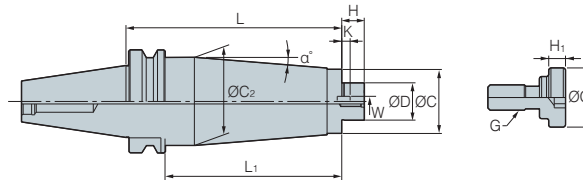

Fig. 2

														(mm)
Designation	Cutter dia.	ØD	L	L ₁	ØC	ØC ₂	H	W	K	G	kg	Fig.	α°	
KDP-BT40 -	FMC16 - 160	40	16	160	133	38	-	17	8	5	M8	2.45	1	-
	FMC22 - 210	50/63	22	210	183	48	4.95	19	10	5.6	M10	4.37	2	0.1
	FMC22 - 260	50/63	22	260	233	48	60	19	10	5.6	M10	6.3	2	1.5
	FMC27 - 210	80	27	210	183	60	-	21	12	6.3	M12	6	1	-
	FMC27 - 260	80	27	260	233	60	-	21	12	6.3	M12	7.25	1	-
KDP-BT50 -	FMC16 - 171	40	16	171	133	38	-	17	8	5	M8	5.1	1	-
	FMC22 - 210	50/63	22	210	172	48	49.5	19	10	5.6	M10	7.3	2	0.1
	FMC22 - 260	50/63	22	260	222	48	62	19	10	5.6	M10	10	2	1
	FMC27 - 210	80	27	210	172	60	78	21	12	6.3	M12	10.6	2	2.5
	FMC27 - 260	80	27	260	222	60	78	21	12	6.3	M12	12.6	2	2
	FMC27 - 320	80	27	320	282	60	78	21	12	6.3	M12	14.8	2	1
	FMC32 - 210	100	32	210	172	78	-	24	14	7	M16	11.7	1	-
	FMC32 - 260	100	32	260	222	78	-	24	14	7	M16	14.2	1	-
	FMC32 - 330	100	32	330	292	78	-	24	14	7	M16	16.6	1	-

- The A type is for JIS B4113 Face milling
- The B type and C type are arbors for T-MAX Face Milling and shoulder cutter
- The weight (kg) shown in the chart does not include the weight of face cutter
 - Key and screw are clamped
 - Wrench is separately sold

Parts

Division	Spare parts				
	Basic				Option
	Key	Clamp bolt	Wrench bolt	Wrench bolt	Wrench
Type					
FMC16	K8.0(A)	-	BX0310	BX0820	LW-6
FMC22	K10.0(C)	-	BX0412	BX1030	LW-8
FMC27	K12.0	MBA-M12	BX0616	-	LW-10
FMC32	K14.0	MBA-M16	BX0820	-	LW-14



HSK-FMA

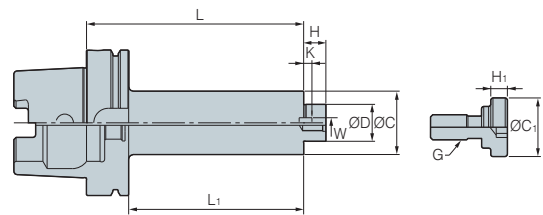

Fig. 1

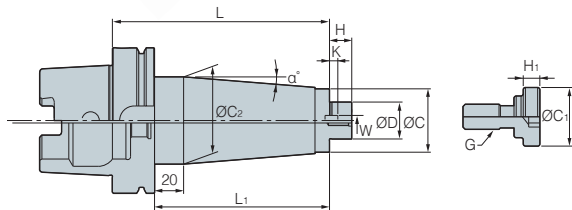

Fig. 2

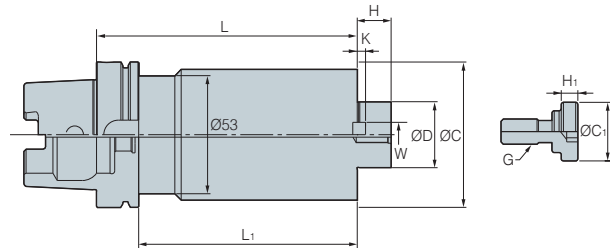

Fig. 3

(mm)

Designation	Cutter dia.	ØD	L	L ₁	ØC	ØC ₂	H	W	K	G	ØC ₁	H ₁	kg	Fig.	α°	
KDP-HSK63 -	FMA25.4 - 210	80	25.4	210	184	50	53	22	9.5	5	M12	33	10	4.55	3	0.1
	FMA25.4 - 260	80	25.4	260	234	50	53	22	9.5	5	M12	33	10	5.6	3	0.1
	FMA31.75 - 210	100	31.75	210	184	60	-	30	12.7	7	M16	40	10	5.52	2	-
	FMA31.75 - 260	100	31.75	260	234	60	-	30	12.7	7	M16	40	10	6.9	2	-
KDP-HSK100 -	FMA25.4 - 210	80	25.4	210	181	50	78	22	9.5	5	M12	33	10	8.32	3	4
	FMA25.4 - 260	80	25.4	260	231	50	78	22	9.5	5	M12	33	10	10.5	3	3
	FMA31.75 - 210	100	31.75	210	181	60	85	30	12.7	7	M16	40	10	10.9	3	3
	FMA31.75 - 260	100	31.75	260	231	60	85	30	12.7	7	M16	40	10	12.8	3	2.5

- The A type is for JIS B4113 Face milling
- The B type and C type are arbors for T-MAX Face Milling and shoulder cutter
- The weight (kg) shown in the chart does not include the weight of face cutter
 - Key and screw are clamped
 - Wrench is separately sold

Parts

Division	Spare parts				
	Basic				Option
	Key	Clamp bolt	Wrench bolt	Wrench bolt	Wrench
Type					
FMA25.4	K9.5(B)	MBA-M12	BX0412	BX1230	LW-10
FMA31.75	K12.7(D)	MBA-M16	BX0515	-	LW-14



HSK-FMC

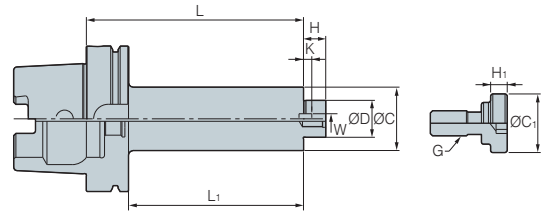

Fig. 1

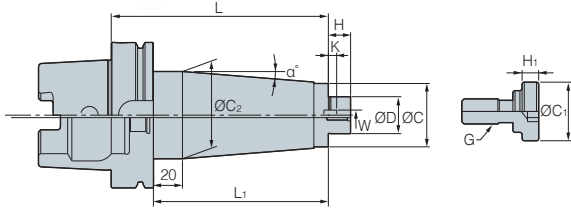

Fig. 2

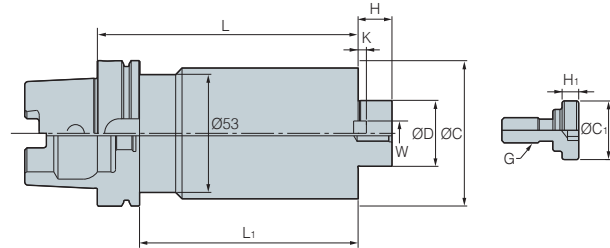

Fig. 3

Designation		Cutter dia.	ØD	L	L ₁	ØC	ØC ₂	H	W	K	G	kg	Fig.	α°
KDP-HSK63 -	FMC16 - 160	40	16	160	134	38	-	17	8	5	M8	2.10	1	-
	FMC22 - 210	50/63	22	210	184	48	4.95	19	10	5.6	M10	3.82	1	0.1
	FMC22 - 260	50/63	22	260	234	48	62	19	10	5.6	M10	6.14	3	1.6
	FMC27 - 210	80	27	210	184	60	-	21	12	6.3	M12	5.53	2	-
	FMC27 - 260	80	27	260	234	60	-	21	12	6.3	M12	6.83	2	-
KDP-HSK100 -	FMC16 - 160	40	16	160	131	38	-	17	8	5	M8	3.45	1	-
	FMC22 - 210	50/63	22	210	181	48	49.5	19	10	5.6	M10	4.60	3	0.1
	FMC22 - 260	50/63	22	260	231	48	62	19	10	5.6	M10	8.10	3	1
	FMC27 - 210	80	27	210	181	60	78	21	12	6.3	M12	8.44	3	2.5
	FMC27 - 260	80	27	260	231	60	78	21	12	6.3	M12	10.40	3	2
	FMC27 - 320	80	27	320	291	60	78	21	12	6.3	M12	13.60	3	1
	FMC32 - 210	100	32	210	181	78	-	24	14	7	M16	10.20	1	-
	FMC32 - 260	100	32	260	231	78	-	24	14	7	M16	13.00	1	-
FMC32 - 330	100	32	330	301	78	-	24	14	7	M16	15.43	1	-	

- The A type is for JIS B4113 Face milling
- The B type and C type are arbors for T-MAX Face Milling and shoulder cutter
- The weight (kg) shown in the chart does not include the weight of face cutter
 - Key and screw are clamped
 - Wrench is separately sold

Parts

Division	Spare parts				
	Basic				Option
	Key	Clamp bolt	Wrench bolt	Wrench bolt	Wrench
Type					
FMC16	K8.0(A)	-	BX0310	BX0820	LW-6
FMC22	K10.0(C)	-	BX0412	BX1030	LW-8
FMC27	K12.0	MBA-M12	BX0616	-	LW-10
FMC32	K14.0	MBA-M16	BX0820	-	LW-14



SK-FMC

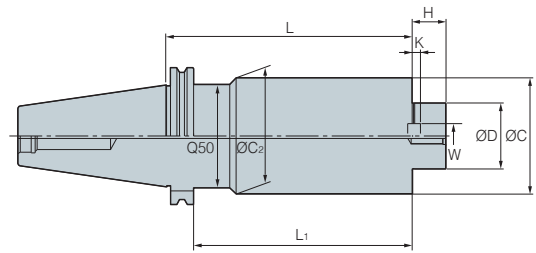

Fig. 1

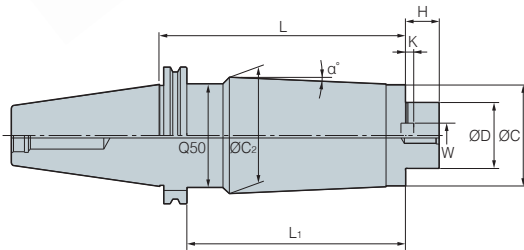

Fig. 2

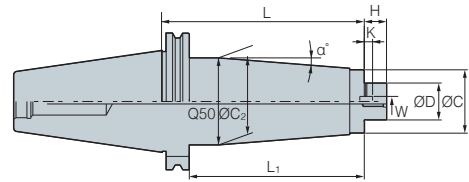







Fig. 3

(mm)

Designation	Cutter dia.	ØD	L	L ₁	ØC	ØC ₂	H	W	K	G	 kg	Fig.	α°	
KDP-SK40 - FMC22 - 210	FMC22 - 210	50/63	22	210	183.0	48	49.5	19	10	4.4	M10	4.4	3	0.1
	FMC22 - 260	50/63	22	260	233.0	48	60	19	10	5.6	M10	6.2	2	1.4
	FMC27 - 210	80	27	210	183.0	60	60	21	12	6.3	M12	5.9	1	-
	FMC27 - 260	80	27	260	233.0	60	60	21	12	6.3	M12	7.2	1	-
KDP-SK50 - FMC22 - 210	FMC22 - 210	50/63	22	210	190.9	48	49.5	19	10	5.6	M10	6.4	3	0.1
	FMC22 - 260	50/63	22	260	240.9	48	62	19	10	5.6	M10	9.1	3	1
	FMC27 - 210	80	27	210	190.9	60	78	21	12	6.3	M12	9.8	3	2.5
	FMC27 - 260	80	27	260	240.9	60	78	21	12	6.3	M12	12.4	3	1.8
	FMC27 - 320	80	27	320	300.9	60	78	21	12	6.3	M12	14.5	3	1.2
	FMC32 - 210	100	32	210	190.9	78	-	24	14	7	M16	11.5	1	-
	FMC32 - 260	100	32	260	240.9	78	-	24	14	7	M16	14	1	-
FMC32 - 330	100	32	330	310.9	78	-	24	14	7	M16	16.4	1	-	

- The A type is for JIS B4113 Face milling
- The B type and C type are arbors for T-MAX Face Milling and shoulder cutter
- The weight (kg) shown in the chart does not include the weight of face cutter
 - Key and screw are clamped
 - Wrench is separately sold

Parts

Division	Spare parts				
	Basic				Option
	Key	Clamp bolt	Wrench bolt	Wrench bolt	Wrench
Type					
FMC16	K8.0(A)	-	BX0310	BX0820	LW-6
FMC22	K10.0(C)	-	BX0412	BX1030	LW-8
FMC27	K12.0	MBA-M12	BX0616	-	LW-10
FMC32	K14.0	MBA-M16	BX0820	-	LW-14



BLK

Blank Tool

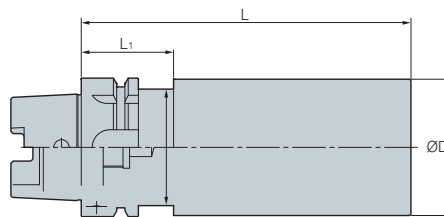

(mm)

Designation	Ød	ØC	L	L ₁
HSK40A - BLK42 - 180	42	34	180	35
HSK50A - BLK52 - 200	52	42	200	42
HSK63A -	BLK63 - 150	63	150	42
	BLK63 - 250	63	250	42
	BLK82 - 200	82	200	42
HSK100A -	BLK102 - 150	102	150	45
	BLK102 - 250	102	250	45
	BLK126 - 200	126	200	45
BT30 - BLK48 - 180	48	44	180	30
BT40 -	BLK63 - 150	63	150	35
	BLK63 - 250	63	250	35
	BLK82 - 200	82	200	35
BT50 -	BLK102 - 150	102	150	48
	BLK102 - 250	102	250	48
	BLK126 - 200	126	200	48

HT

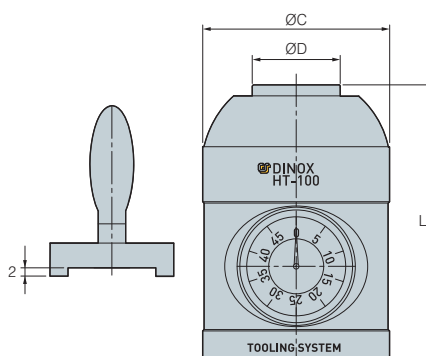

(mm)

Designation	ØD	ØC	L
HT-100	32	68	100

- Good for setting the Tool length at CNC machine
- No inturference between height Touch setter and Tool makes safe work
- Location Accuracy: ±0.003 mm



SC Spindle Cleaner



(mm)

Designation	Taper	N.W.	G.W.
SC - BT30	BT30	0.06kg	0.08kg
BT40	BT40	0.07kg	0.1kg
BT50	BT50	0.16kg	0.2kg
HSK50	HSK50	0.08kg	0.12kg
HSK63	HSK63	0.1kg	0.13kg
HSK100	HSK100	0.5kg	0.7kg

Features

- Cleaning ships of taper wipe is made of lambskin
It can clean inside slide of spindles to prevention of static electricity and to extend spindles and tapers durable life

KCP

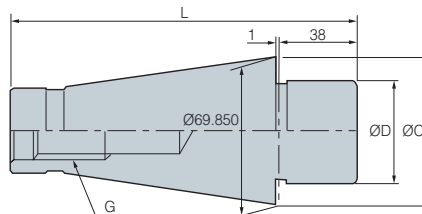

(mm)

Designation	Taper	Cutter dia.	ØD	ØC	L	G
NTN 50 - KCP47.625	NT50	200(8")	47.625	69.55	164.00	U1"-8(M24)
KCP60	NT50	200(8")	60	69.55	164.00	M24



Pull Stud Bolt

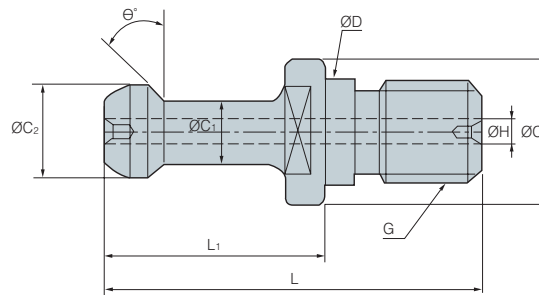

(mm)

Designation	ØD	ØC	ØC ₁	ØC ₂	L ₁	L	θ	G	ØH
P20T-1	8.5	12	6	8.5	17.5	31.5	15°	M8	
P30T-1	12.5	16.5	7	11	23	43	45°	M12	
P30T-1(Ø2.5)	12.5	16.5	7	11	23	43	45°	M12	Ø2.5
P30T-2	12.5	16.5	7	11	23	43	30°	M12	
P30T-2(Ø2.5)	12.5	16.5	7	11	23	43	30°	M12	Ø2.5
P40T-1	17	23	10	15	35	60	45°	M16	
P40T-1(3)	17	23	10	15	35	60	45°	M16	Ø3
P40T-2	17	23	10	15	35	60	30°	M16	
PS40-3F	17	23	10	15	35	60	0°	M16	
PS-G51	17	22	12.45	18.8	19.11	44.11	45°	M16	Ø7
DIN69872-A40	17	23	14	19	26	54	15°	M16	Ø7
DIN69872-B40	17	23	14	19	26	54	15°	M16	
JISB6339-A40(PS-806)	17	23	14	19	29	54	15°	M16	Ø7
JISB6339-B40(PS-805)	17	23	14	19	29	54	15°	M16	
P50T-1	25	38	17	23	45	85	45°	M24	
P50T-1(7)	25	38	17	23	45	85	45°	M24	Ø7
P50T-2	25	38	17	23	45	85	30°	M24	
PS50-1F	25	38	17	23	45	85	0°	M24	
PS50-1FH	25	38	17	23	45	85	0°	M24	Ø8
PS-G41	25	37	20.83	28.96	25.2	65.2	45°	M24	Ø10
DIN69872-A50	25	36	21	28	34	74	15°	M24	Ø11.5
P50T-1HS	25	38	17	23	45	85	45°	M24	Ø5.7



J

TOOLING EXAMPLES

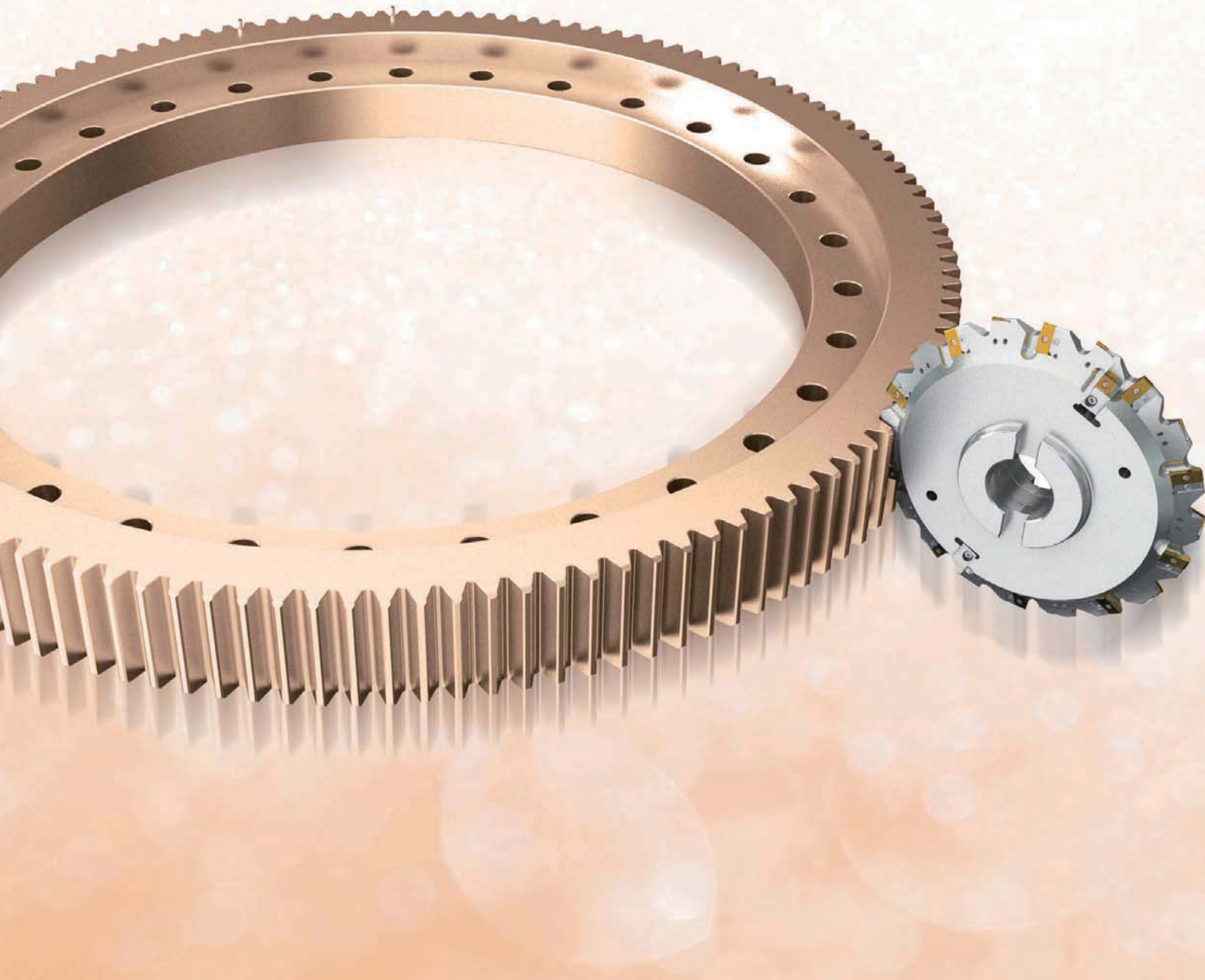

Industrial Tooling Example

- J02 Gear Machining Solution
- J04 Ship Building Industrial Solution
- J07 Role Machining Solution
- J08 Railway Industrial Solution
- J10 Pipe Industrial Solution
- J12 Bearing working Solution
- J13 Development Industrial Solution
- J14 Aviation Industrial Solution
- J18 Slitter Knife

Automobile Tooling Examples

- J19 Crankshaft
- J20 Knuckle
- J22 Brake
- J24 Connecting Rod
- J26 Block
- J28 Head



Gear machining (External Gear)

Cutter for roughing



- Cutter diameter: Ø300
- The Number of Edges: 60
- Available for high speed working through onrolled V-style edges to reduce cutting force



Cutter for medium



- Cutter diameter: Ø280
- The Number of Edges: 48
- Available for high efficiency and long life and high productivity through Korloy's own insert shape
- Made R part of gear by proper designed 'R'-shape of insert

Cutter for finishing: M20



- Cutter diameter: Ø400
- The Number of Edges: 20
- Gear cutter for medium is realized on the 4 grade of precision. (KS, JS)
- Chamfering system available for machining efficiency



Hob cutter



- Cutter diameter: Ø350
- The Number of Edges: 100
- Indexable hob for roughing worked by generating cutting action
- Available for customized producing by user

King Drill



Optimal indexable drill design

- Drill shape and chip breaker are optimized at the central and peripheral insert locations for better chip control and surface finish
- Grades, optimized for the central and peripheral insert locations in order to maximize cutting tool life.
- Grade: PC3500, PC5300

VT chip breaker



- Excellent rigidity on the high feed and depth
- Excellent impact resistance and long life based on stable structure and outstanding rigidity
- Type of SNMM/CNMM

TPDB



High precision and high efficiency indexable drill

- Highly efficient drilling in high speed and high feed machining
- Excellent surface roughness

VH chip breaker

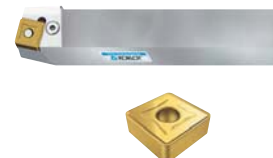

- Innovative improved chip breaking on the medium working
- Provided good performance on the flange and continuous working
- Type of SNMM/CNMM

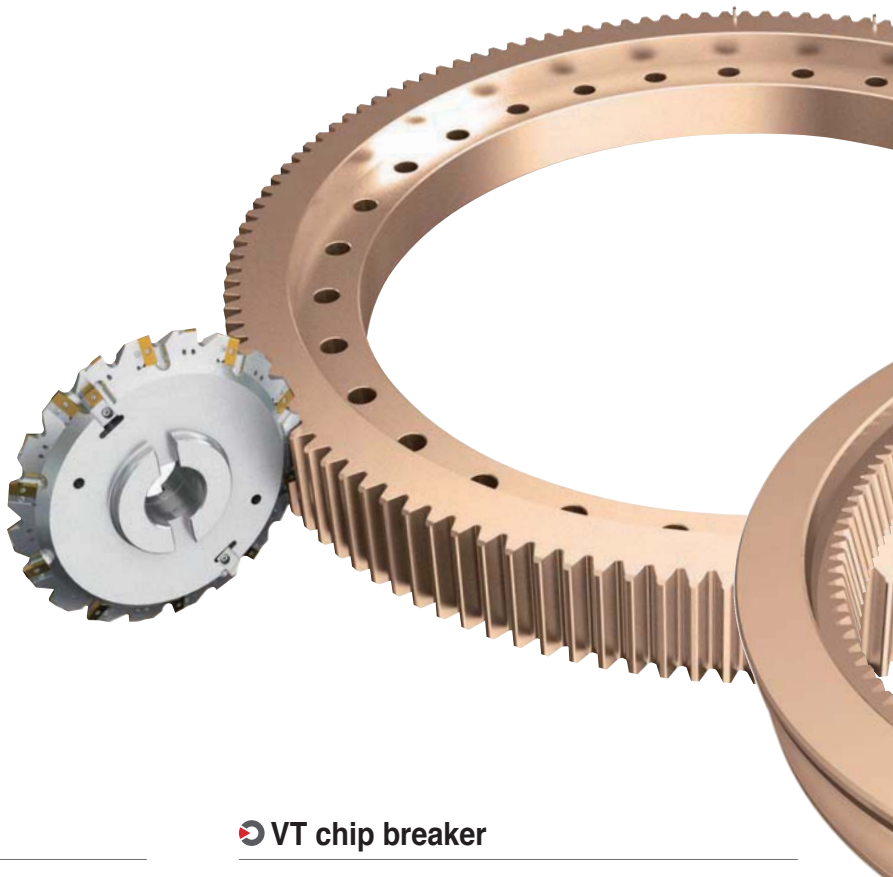

Gear machining (Internal Gear)

➤ Cutter for roughing



- Cutter diameter: Ø560
- The Number of Edges: 140
- Available for all module gear working is caused by edges designed stair shape



➤ Cutter for medium



- Cutter diameter: Ø400
- The Number of Edges: 48
- Available for making involute curve shape of internal gear



➤ Cutter for finishing



- Cutter diameter: Ø400
- The Number of Edges: 20
- Cutter for finishing available for 4 grades accuracy of internal gear
- Available for chamfering on the same time and unnecessary of extra working

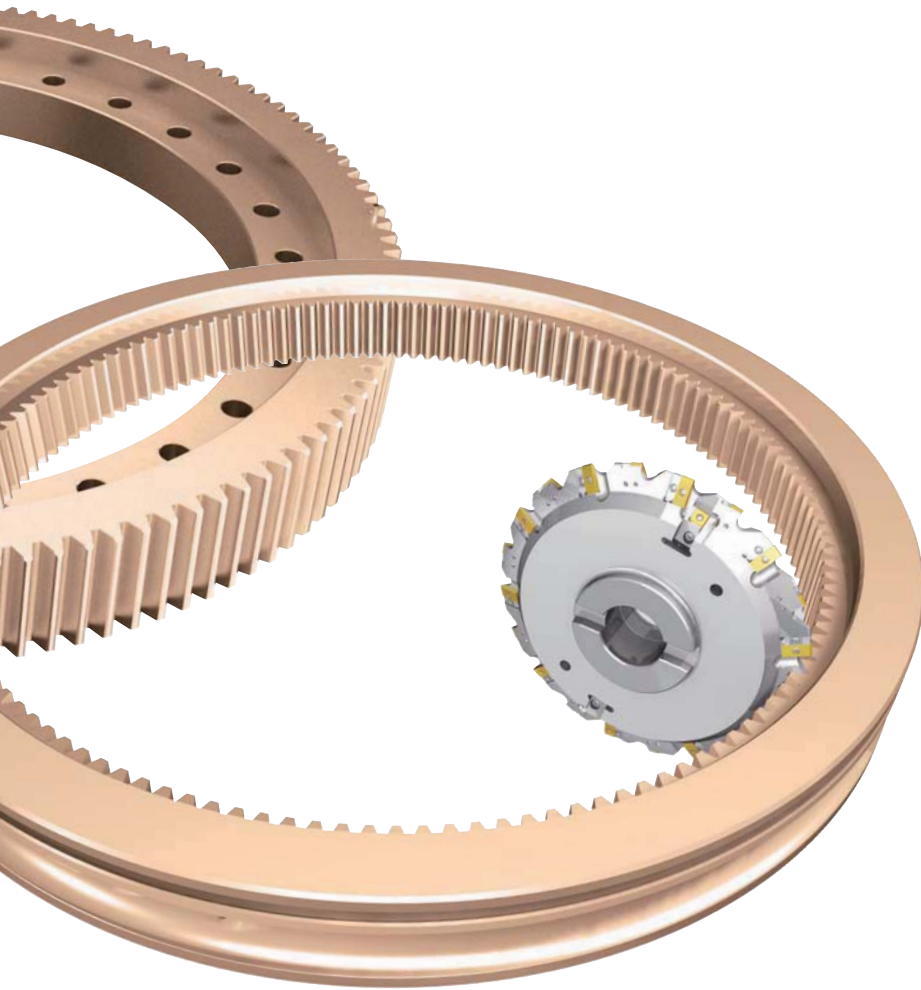

➤ King Drill



Optimal indexable drill design

- Drill shape and chip breaker are optimized at the central and peripheral insert locations for better chip control and surface finish
- Grades, optimized for the central and peripheral insert locations in order to maximize cutting tool life
- Grade: PC3500, PC5300

➤ TPDB



High precision and high efficiency indexable drill

- Highly efficient drilling in high speed and high feed machining
- Excellent surface roughness

Ship building (Engine block)

➤ Roughing cutter for cylinder block



- Cutter diameter: $\varnothing 200$
- Applicable insert: SNCF1507ANN-MF
- Economical concepts: 8 edge available insert, high feed available tool
- KORLOY exclusive latch clamping system provides quick change of insert

➤ TPDB



High precision and high efficiency indexable drill

- Highly efficient drilling in high speed and high feed machining
- Excellent surface roughness

➤ King Drill



Optimal indexable drill design

- Drill shape and chip breaker are optimized at the central and peripheral insert locations for better chip control and surface finish
- Grades, optimized for the central and peripheral insert locations in order to maximize cutting tool life
- Grade: PC3500, PC5300

➤ Cylinder block cam shaft boring cutter (Aluminum body cutter)



- Cutter diameter: $\varnothing 270$
- Applicable insert: LNE434/SDKX1506
- Right-hand rotational aluminum cutter body, easy to handle, makes high precision boring

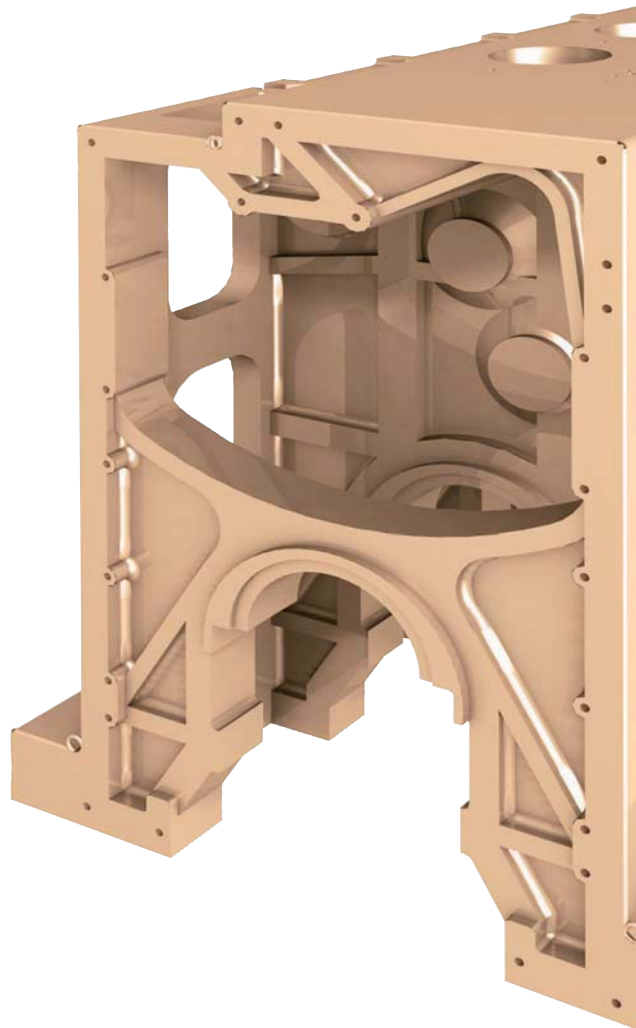

➤ Cylinder block roughing and medium (Both)



- Cutter diameter: Ø200
- Applicable insert: LNE434 / LNCS1907-R3.0-WC
- Designs available for roughing and medium applications
- Available high efficiency working to chose LNE 434 insert for roughing and high reliability grade
- Good surface working through LNCS1907-R3.0-WC Wiper shape for medium

➤ High rake-angle applied cylinder block roughing cutter



- Cutter diameter: Ø250
- Applicable insert: SECN2606AFN
- High rake angle cutter suitable for the machining applications that have the tendency to create chatter

➤ Adjustable medium machining cutter

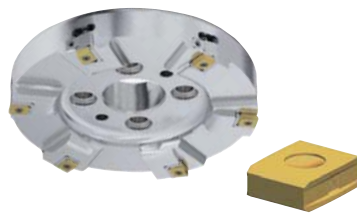

- Cutter diameter: Ø250
- Applicable insert: LNCS1907-C1.5-WC
- Cutting edge height adjustable device provides excellent surface finish

➤ Cylinder block bearing cap seat machining cutter



- Cutter diameter: Ø250
- Applicable insert: RDKT2006M0
- Several sizes of inserts are prepared to meet the radius requirement of work-piece
- Rigid inserts for high efficiency machining



Ship building (Crank shaft/Propeller)

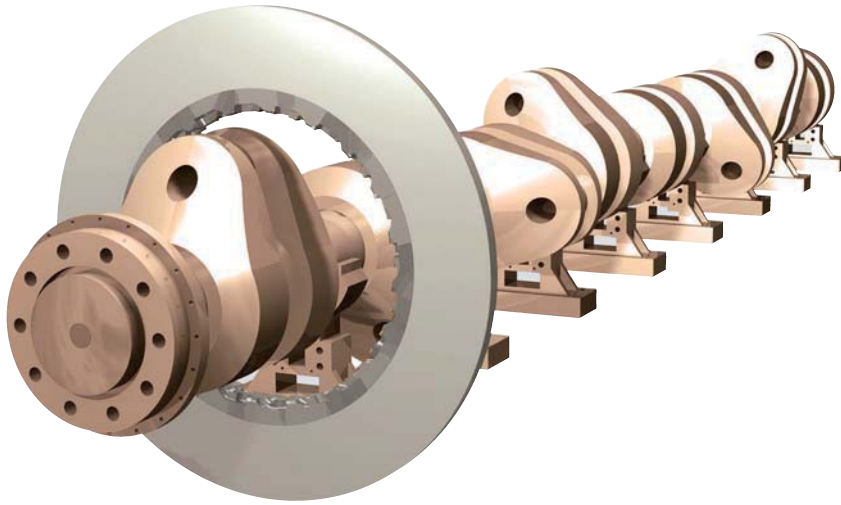

➤ KORLOY exclusive screw-on type internal pin miller



- Cutter diameter: Over $\text{Ø}2000$
- Weight: 1.5 tons
- Pin miller for crank shaft of medium size ship engine
- Special segment assembly system developed by KORLOY makes it easy to handle and provides excellent cutting performance with good chip forming

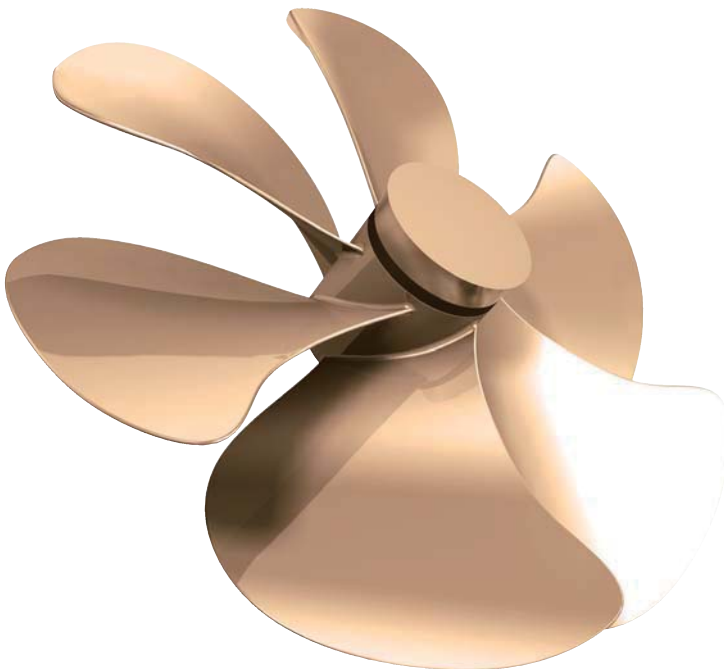

➤ Periphery side of propeller machining tool



- Cutter diameter: $\text{Ø}150$
- Applicable insert: CDEW170708R
- Positive relief angle applied to get smooth cutting without chatter

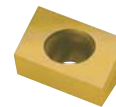

➤ Top face of propeller machining tool

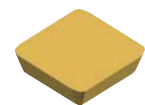

- Cutter diameter: $\text{Ø}250$
- Applicable insert: SECN1904EER
- Double layer insert array provides big depth of cut

Role machining (Body/Shape/Parting-off)

➤ Role machining (Body/shape/parting-off)



Competitor



NC6315

- Good chip evacuation even in deep grooving
- High hardness coating grade that has excellent wear resistance prevents damage from cutting load (Photo shows edge damage after machining same time under same conditions)

➤ Application case



Competitor



NC6315

- Equipped with wide chip breaker enough to prevent crater wear
- Better chip control from the beginning of the machining, together with high hardness coating grade provides 3 times longer tool life than conventional tool (especially at finishing)

The combination of high hardness coating grade (NC6315) and chip breaker shows better performance

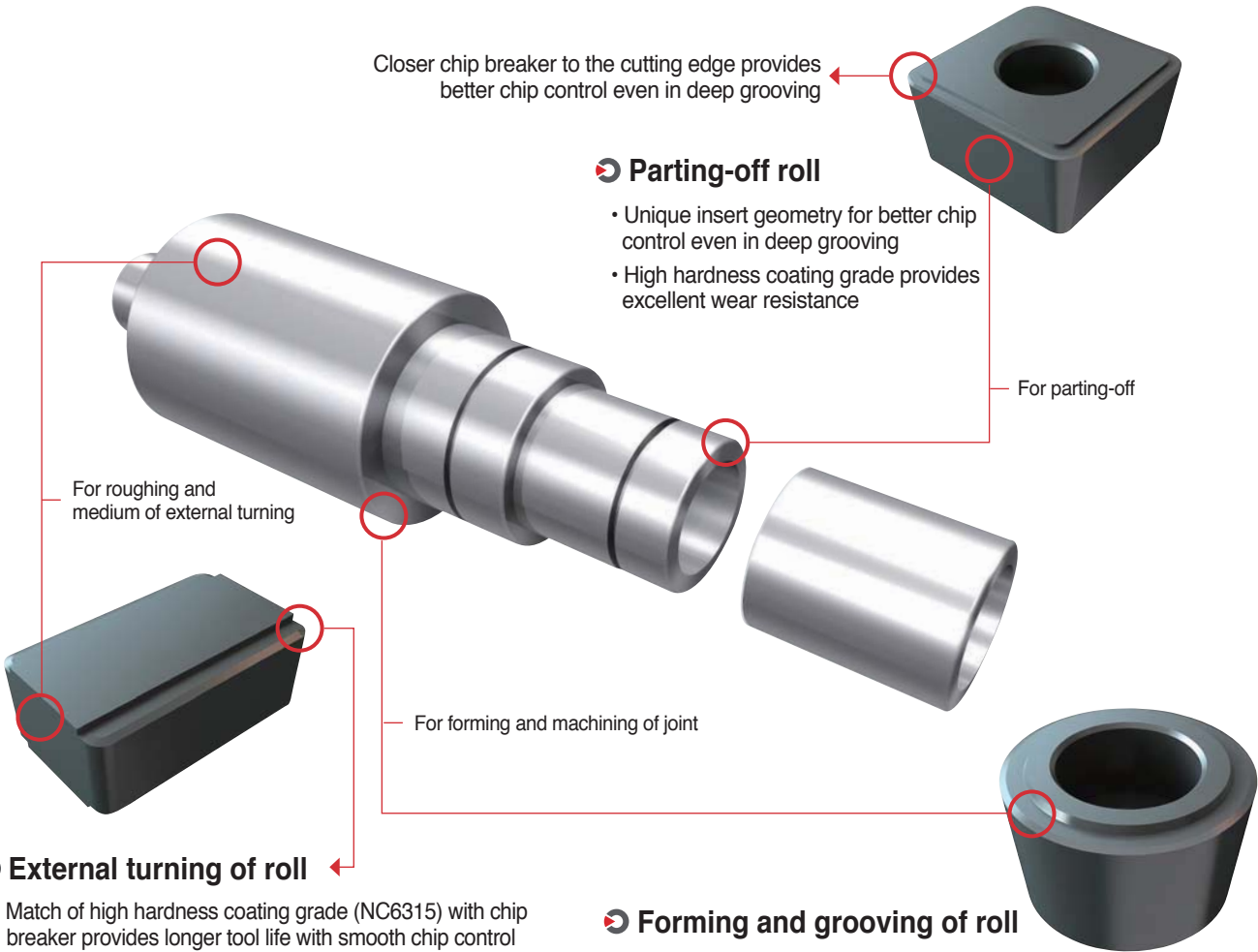

Railway Industry (Rail)

➤ **Cutter for turnout's joint plates**



- Cutter diameter: Ø160
- The Number of Edges: 54
- Special customizing is available upon customer's requests

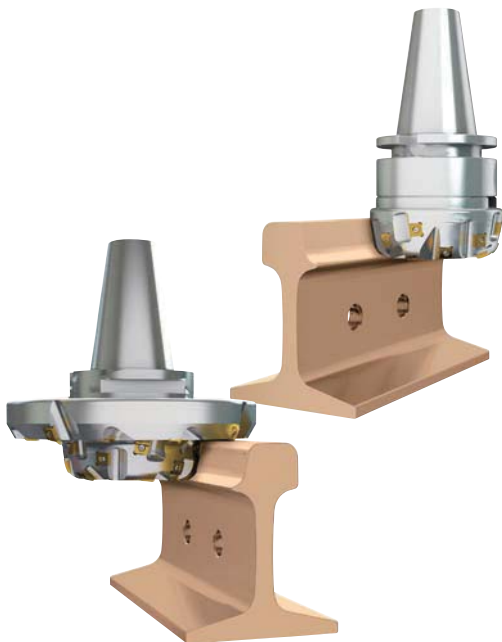
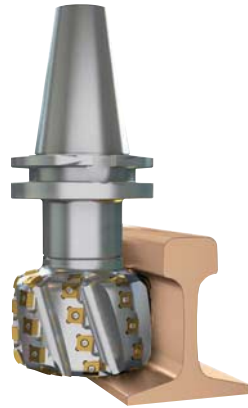

➤ **Cutter for upper parts of rails**



- Cutter diameter: Ø160
- The Number of Edges: 16
- Precise forming of rail way is possible

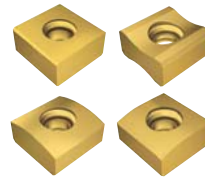
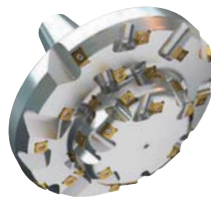

- Cutter diameter: Ø300
- The Number of Edges: 33
- One body design of cutter and arbor provides high rigidity

➤ **Cutter for upper tapers of rails**



- Cutter diameter: Ø200
- The Number of Edges: 24
- Economical 8 edge available insert
- Special customizing is available insert
- Special customer's requests upon customer's requests



➤ **Cutter for rail repair**



- Cutter diameter: Ø600
- The Number of Edges: 198
- Milling applicable on the rail of part requested repairing

➤ **Cutter for upper flanks of rails**



- Cutter diameter: Ø240
- The Number of Edges: 25

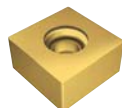



Rail Industry (Wheel)

➤ The type of LNUX for the working of wheel (Repair)

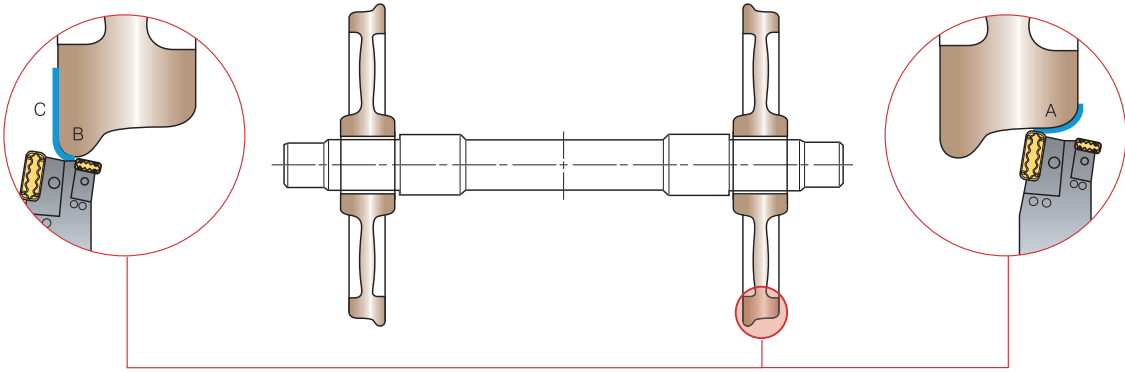
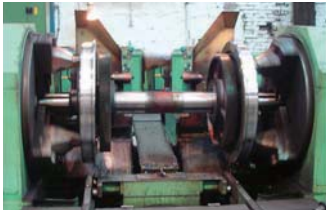
- Material: SSW2. Ø920~1000
- Cutting conditions: $vc = 78 \text{ m/min}$ (13~18min-1), $fn = 1.0 \text{ mm/rev}$, $ap = 3\sim4 \text{ mm}$
- Insert: LNUX301940-TM Grade: NC3215
- Result: good chip evacuation, stable structure and long life tool life







LNUX301940-TF	LNUX301940-TM
 <ul style="list-style-type: none"> • For light cutting, it generates a low load with good chips 	 <ul style="list-style-type: none"> • Comprehensive design for general use, strong cutting edge with good chip forming (First recommendation)

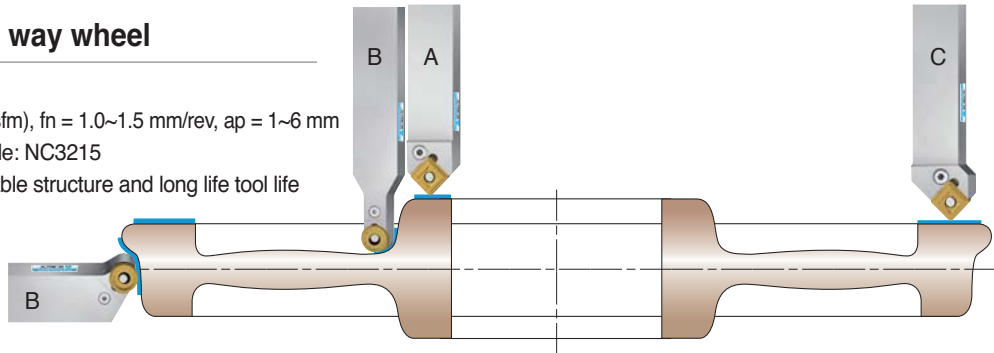

Working procedure	A	B	C
Insert	LNUX301940-TF/TM	LNUX191940-25/22	
Grade	NC3215	NC3215	
Cutting condition	Decrease the speed on deep part of A	Increase the speed to get good chip evacuation	

➤ RCMX insert for rail way wheel

- Material: SSW2. Ø840
- Cutting conditions: $vc = 55\sim100 \text{ (sfm)}$, $fn = 1.0\sim1.5 \text{ mm/rev}$, $ap = 1\sim6 \text{ mm}$
- Insert: RCMX3209M0-SL Grade: NC3215
- Result: good chip evacuation, stable structure and long life tool life

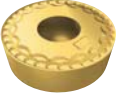

VT chip breaker		B chip breaker	
 <ul style="list-style-type: none"> • Strong cutting edge for high feed and deep cutting depth • Tough design of chip breaker provides excellent impact resistance • SNMM type 	 <ul style="list-style-type: none"> • Comprehensive roughing design having strong edge strength with long tool life 		
SL chip breaker		TM chip breaker	
 <ul style="list-style-type: none"> • Comprehensive chip breaker covers wide application range • Proper chip control with long tool life 	 <ul style="list-style-type: none"> • Medium-finishing chip breaker, proper surface finish, superior wear resistance 		
 <ul style="list-style-type: none"> • Better chip control at low depth of cut machining 			

Working procedure	A	B	C
Applicable insert			
Holder	PSDNN5050-U25	PRDCN5050-U32 PRGCN5050-U32	PSSNR5050-S25
Insert	SNMM250724-GH	RCMX3209M0-SL	SNMM250724-VT
Grade	NC3215	NC3215	NC3215

Pipe Industry (Edge milling)

➤ “X” shape machining



- A cutter to make the “X” shape on the both side-end of steel plate, to do bevel-end welding
- Locator wedge type clamping system applied for the cutter provides long durability of cutter as well as strong clamping power
- Grade: NC5340

➤ “I” shape machining

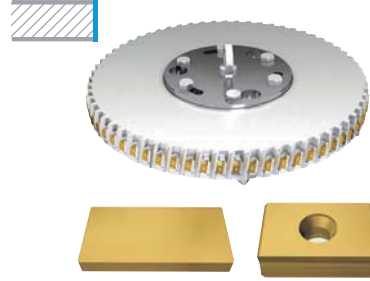

- A machining to make “I” shape on the both side-end of steel plate, to do bevel-end or plane-end welding
- Variety of inserts (with chip breaker or without chip breaker) are available according to your cutting conditions
- Grade: NC5340

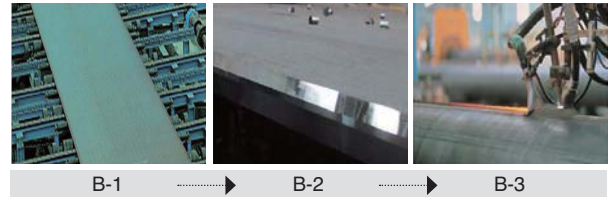
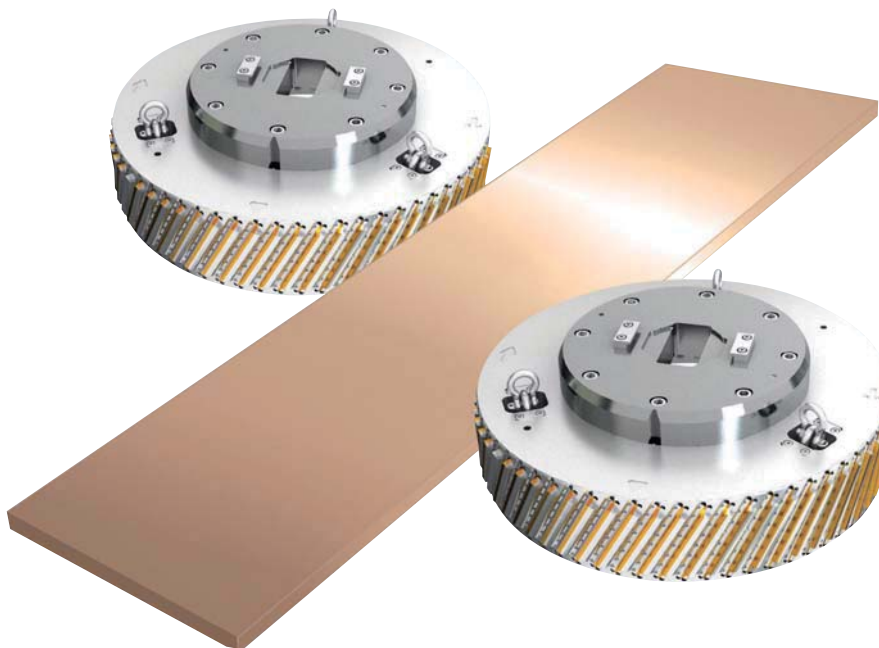

➤ “Y” shape machining

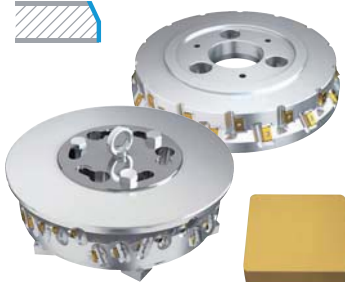

- A machining to make “Y” shape on the both side-end of steel plate, to do bevel-end welding
- Wide chip pocket on cutter provides long durability of it by reducing contact of chip with cutter body

➤ Special machining

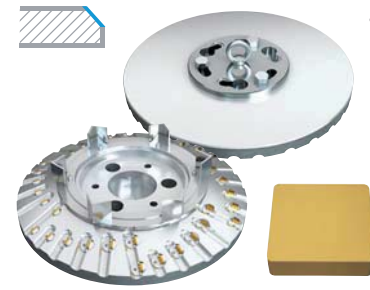

- Special design of cutter as per side-end shape of steel plant upon customer's request is available

Pipe Industry (Bead removal/Parting-off/Chamfering)

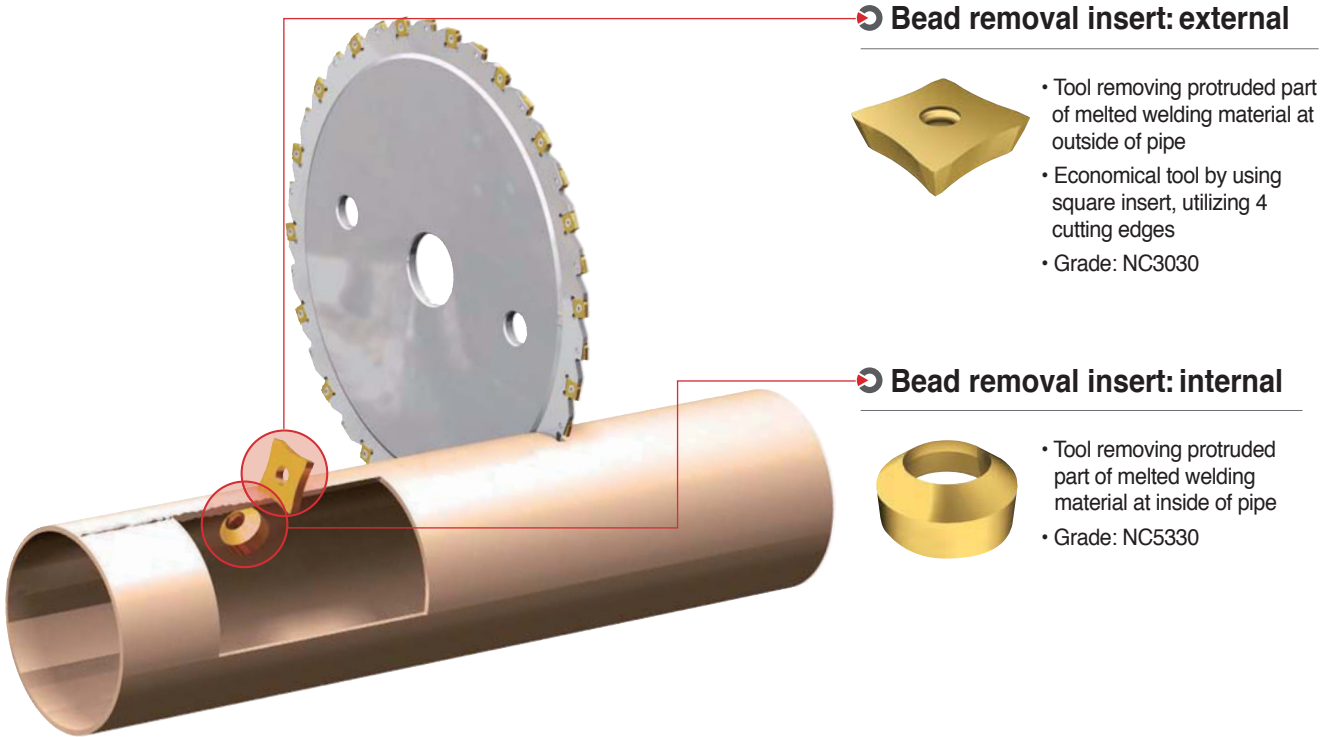

Working method	Application range	Applicable inserts	Cutter
	For external bead removal	SDMX80-R□□/SEGW54-R□□ SNMG150708-R□□/SNMN1207(SNU452)-□□R SNMN1507(SNU552)-□□R/SOET1906-254 SEGX2509-R□□	Customizing
	For internal bead removal	AR□□(AC)/SF□□R-□□	

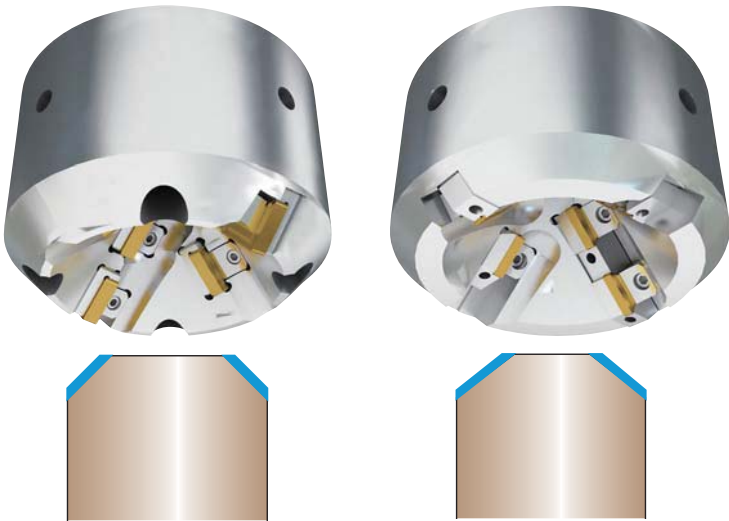

Chamfer tool

- Chamfering tool machining cut-off face of pipe
- Special chamfering angle design is possible upon customer's request
- Cost effective concept: Triangle and Square double sided insert provides 6~8 effective cutting edges
- Grade: NCM325, PC3500

Bearing

➤ **For external and facing working**

For facing

Insert type: SRGP...R/L F type

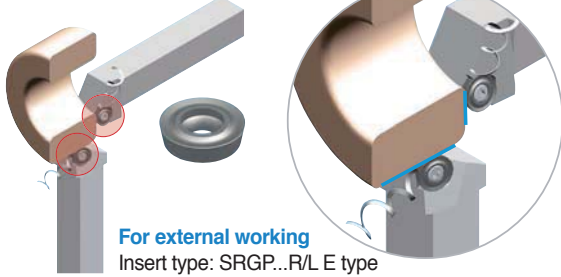

For external working

Insert type: SRGP...R/L E type

- Applicable on the internal, external and facing working

➤ **For internal and external r-chamfering**

For R-chamfering

CMSN...R/L F type

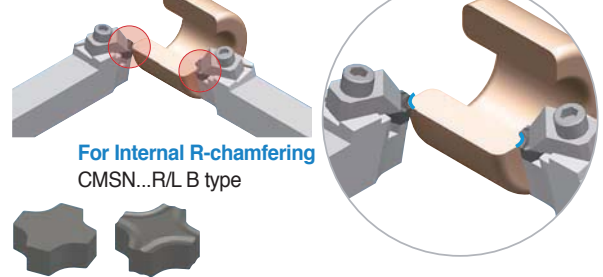

For Internal R-chamfering

CMSN...R/L B type

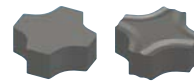

- Applicable 8 corner of insert
- R-shape is realized to internal and external part of corner

➤ **For internal working**

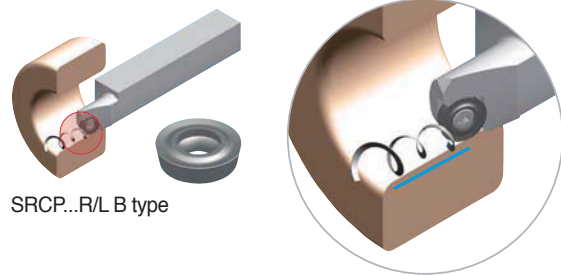

SRCP...R/L B type

- Applicable over Ø12

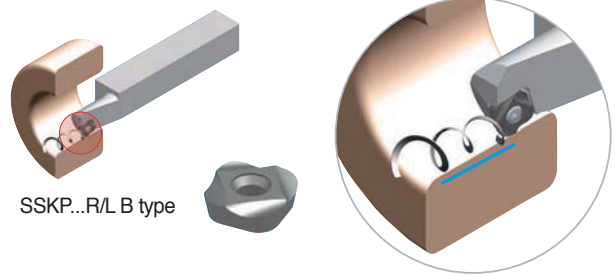

SSKP...R/L B type

- Applicable over Ø11.5 with 4-corner insert for internal and low working

➤ **For ray-way**

- For Ray-way on internal and external bearing
- Applicable 3 corner insert
- Able to customize

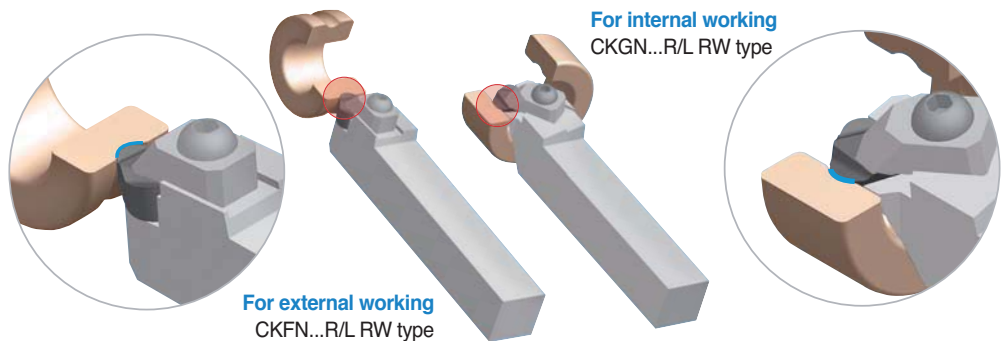

For external working
CKFN...R/L RW type

For internal working
CKGN...R/L RW type

➤ **For shield way**

- For shield working on internal and external bearing
- Applicable 4 corner insert
- Able to customize

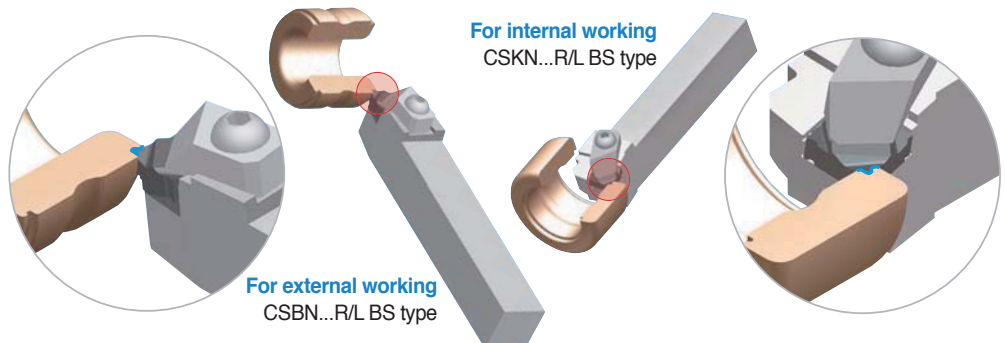
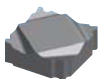

For external working
CSBN...R/L BS type

For internal working
CSKN...R/L BS type

Power Generation (Wind Power Generation Shaft/Tower Flange)

VH chip breaker



- Good chip control in heavy machining
- Excellent performance for flange machining
- Suitable for continuous cutting conditions
- SNMM/CNMM type

VT chip breaker



- Strong cutting edge for high feed and deep cutting depth
- Tough design of chip breaker provides excellent impact resistance
- SNMM/CNMM type

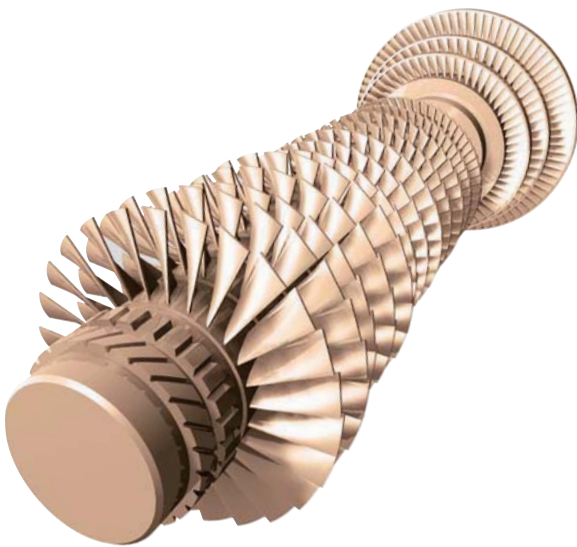

TM (Thread milling)



- Thread milling indexable tools
- Various type of holder (standard, long, taper) and inserts
- Screw diameter: $\varnothing 9\sim\varnothing 46$ mm

H Endmill



Endmill for high hardened steel machining at high speeds

- New grade (PC303S, PC310U) - Ultra fine substrate and AlTiSiN coating guarantee excellent wear resistance
- Special edge treatment - Special cutting edge design was applied for less chipping and longer tool life

RCMX type



- High quality machining
- Rigid insert ensures good surface finish and long tool life
- RCMX type

Vulcan Drills (VZD)



- Rigid body for high feed and precision machining
- Better chip evacuation from improved chip breaker
- Applicable for the drilling under poor cutting conditions

King Drill



Optimal indexable drill design

- Drill shape and chip breaker are optimized at the central and peripheral insert locations for better chip control and surface finish
- Grades, optimized for the central and peripheral insert locations in order to maximize cutting tool life
- Grade: PC3500, PC5300

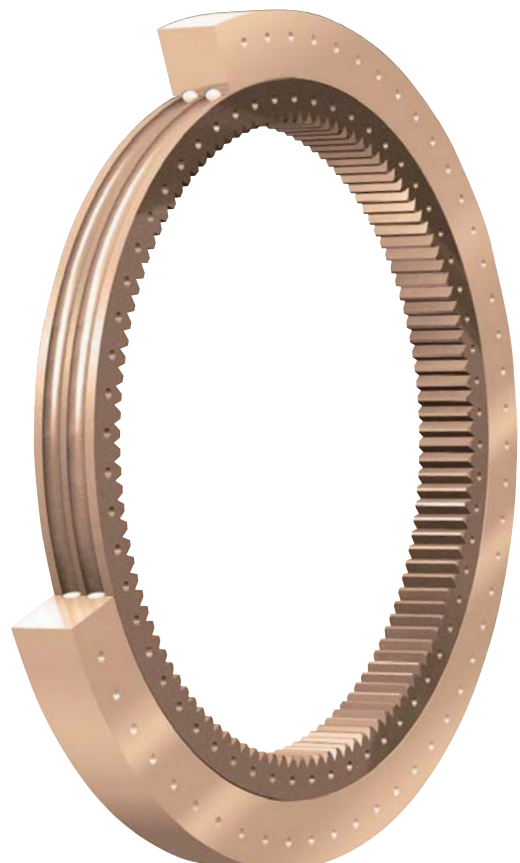

Aviation Industry (Engine/Turbine)

TPDB



High precision and high efficiency indexable drill

- Highly efficient drilling in high speed and high feed machining
- Excellent surface roughness

ISO turning

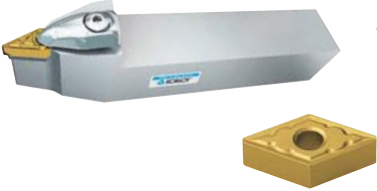

- Available to customize whole and special items for complicated and various shape

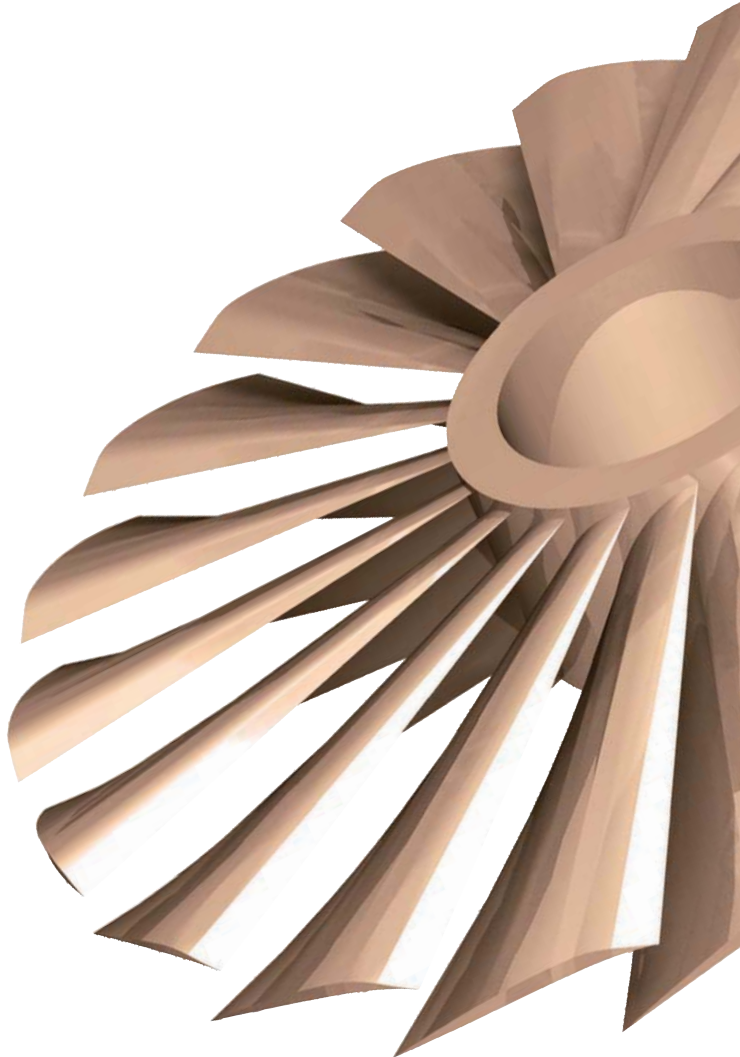

Boring Bar



Internal turning

- ISO standard boring bar for internal machining



Rich Mill



- Increased number of edges and excellent tool life due to 8 corner edges
- Smooth cutting with low cutting load due to the unique geometry & high rake angle of cutting edge, this combination provides excellent tool life

MSD



Long tool life with protecting material

- Good chip control with proper chip-pocket
- Decrease the chipping and increase the cutting ability due to applicable streamlined shape insert
- Increase impact resistance and lubrication due to apply PVD K Black coating on the sub-micron material

Laser Mill



Multi-functional indexable end-mill

- Extremely hard grade provides long tool life
- Easy and simple clamping of insert by using single screw
- Excellent quality for fine finishing due to its precise tolerance

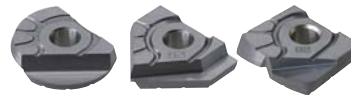

H Endmill



Endmill for high hardened steel machining at high speeds

- New grade (PC303S, PC310U) - Ultra fine substrate and AlTiSiN coating guarantee excellent wear resistance
- Special edge treatment - Special cutting edge design was applied for less chipping and longer tool life

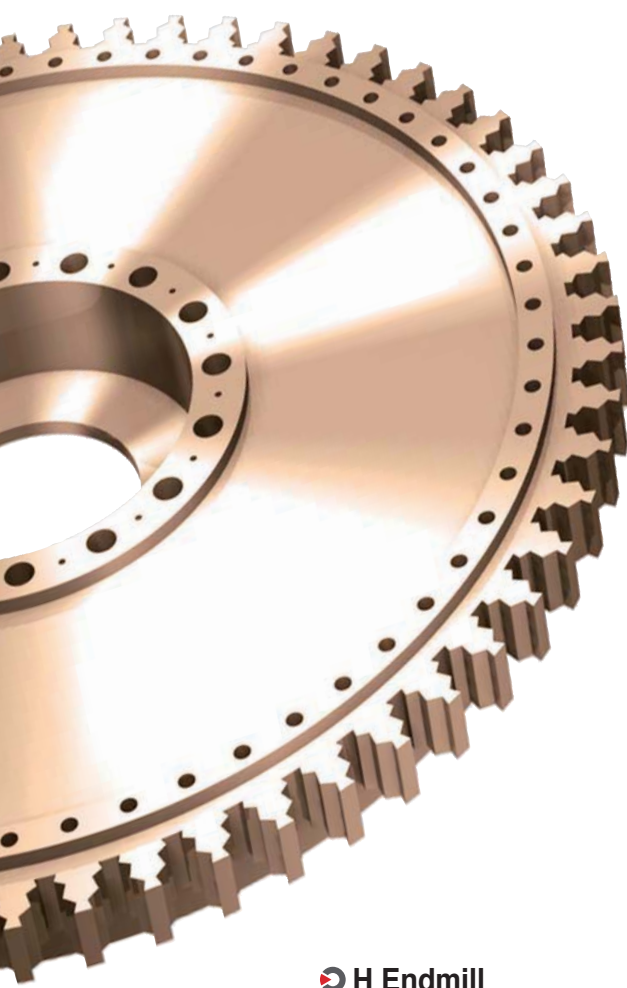

Aviation Industry (Landing Gear/Accessory)

HRMDouble



High efficient and cost effective tool utilizing a double sided insert

- Cost effective tool by using double sided insert with a total of 6 cutting edges
- Smooth cutting utilizing a high rake angle sharp cutting edge insert



MGT



For grooving, turning, profiling, cut-off

- Multi functional grooving tool can over variety of machining with multifunctional grooving tool and the chip breaker with excellent cutting performance and the ability to expand grooves

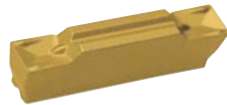

Pro-X Mill



High-speed aluminum milling tool

- Unique mounting system of insert provides tight clamping of insert
- Mirror surface and high rake angle of insert provides excellent machined surface by reduced cutting load and edge build-up
- Grade: H01



SSEA



Solid carbide end-mill for aluminum machining

- Advanced geometry of end-mill refrains build-up-edge
- Superior surface machined
- DLC coated end-mills available

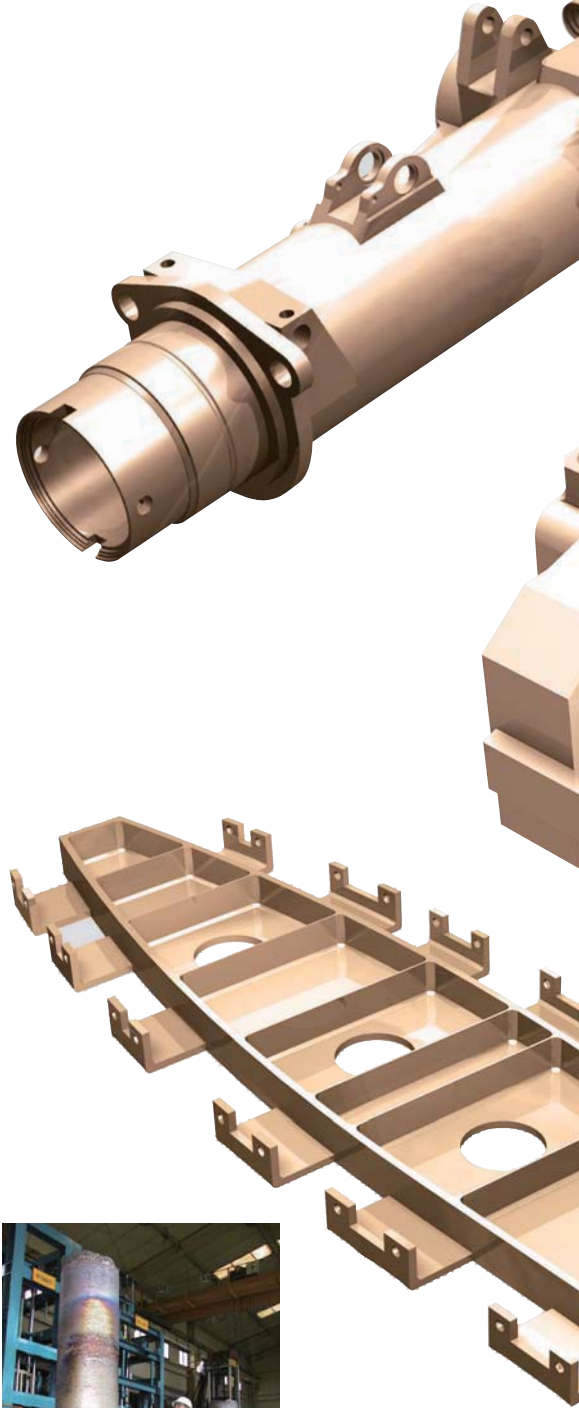

Titanium
Picture provided: KPC Inc

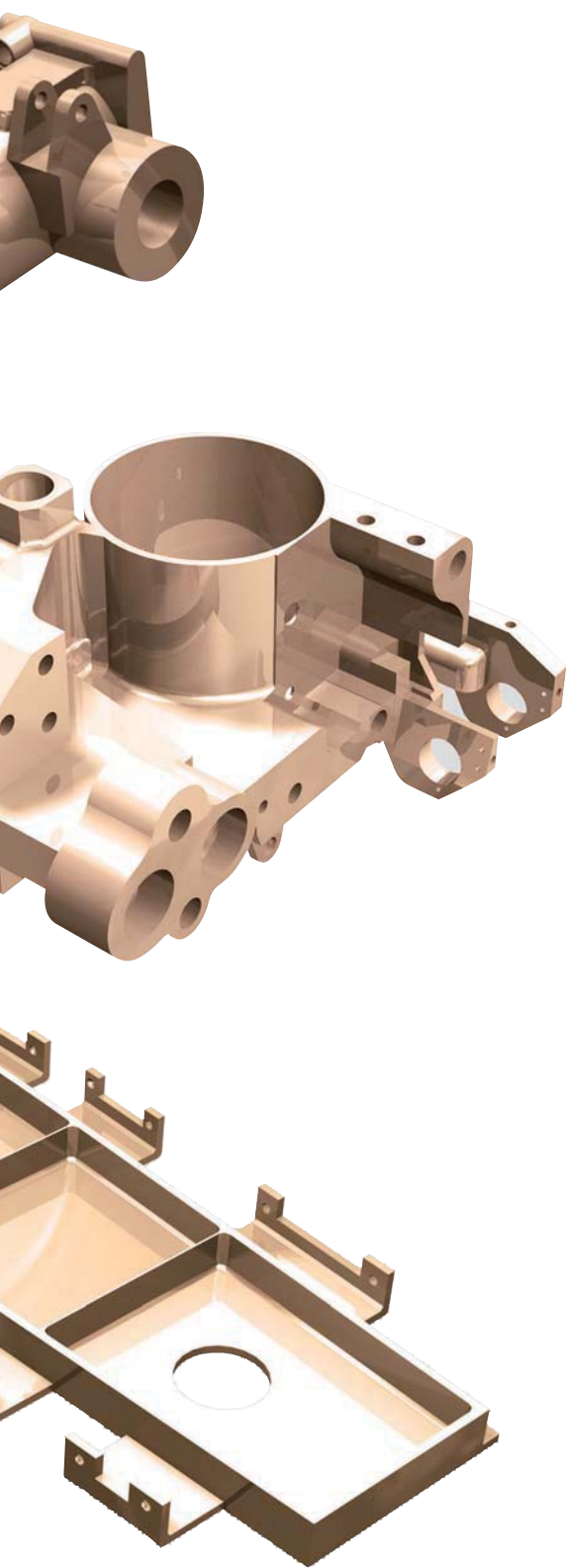

King Drill



Optimal indexable drill design

- Drill shape and chip breaker are optimized at the central and peripheral insert locations for better chip control and surface finish
- Grades, optimized for the central and peripheral insert locations in order to maximize cutting tool life
- Grade: PC3500, PC5300

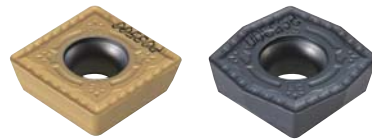

MLD (Mach Long Drill)

- Direct drilling without separate operation (step drilling) over 20xD
- Wider flute space along with drill provides effective chip control
- Special design for rigid body provides smooth drilling without bending of drill

Alpha Mill

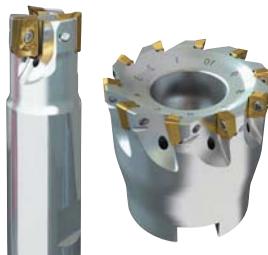

Multi functional milling tool

- Vast coverage of milling operation due to its variety of cutters and inserts
- 3 dimensional chip breaker design provides smooth cutting



Brazed Endmill



- Apply High Spiral Angle (over 40 degrees) able to get good sharpness
- Available high speed milling due to reduce the working temperature
- Expected long tool life by applying hardened carbide material.
- Economical welded tool due to available 2 or 3 times re-grinding

Slitter Knife

Application

- For video tape/For audio tape
- For magnetic tape/For brass plate, mobile battery

Tool selection

- Top slitter knife: Thickness: $\pm 0.01 \sim 0.02$ mm
- Bottom slitter knife: Thickness: ± 0.001 mm / Flatness: under 0.0005 mm
Polishing surface roughness: under 0.05 S



Machining example

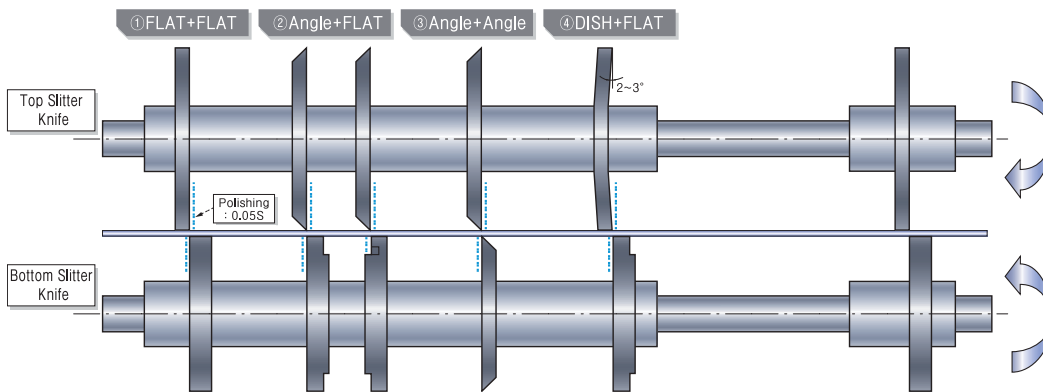

Broach cutter

Application

- Broach cutters apply to inner machining of metal bearing which is used for automobile crank shaft

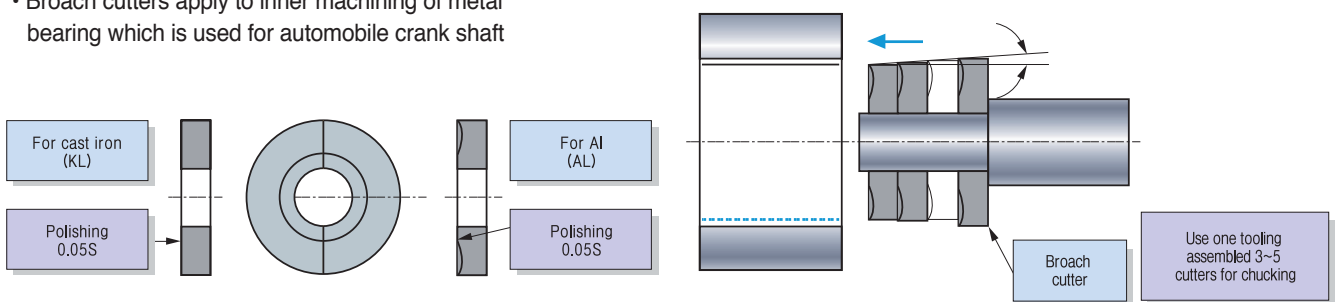

Order

- Designation for cast iron: KL $\varnothing d \times \varnothing D \times T$
- Designation for Aluminium: AL $\varnothing d \times \varnothing D \times T$
: AL $\varnothing d \times \varnothing D \times T \times \alpha^\circ$
(If there is no mentioned any angle, $\alpha = 30^\circ$)

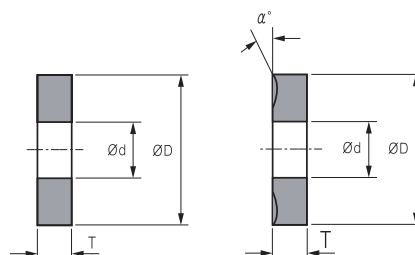

Automobile engine tooling example (Crank Shaft)

Oil Bore - Mach Long Drill (MLD)

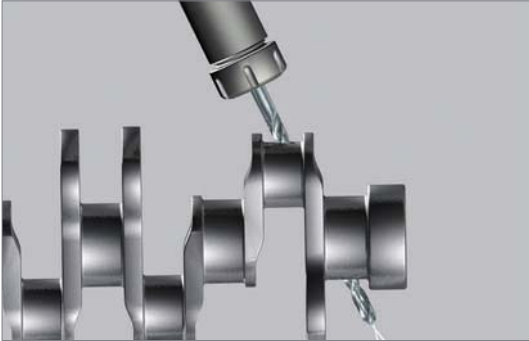

Taper Spline Structure
(Rigidity has been enhanced due to increased contact area)

Oil Bore - Mach Long Drill (MLD)

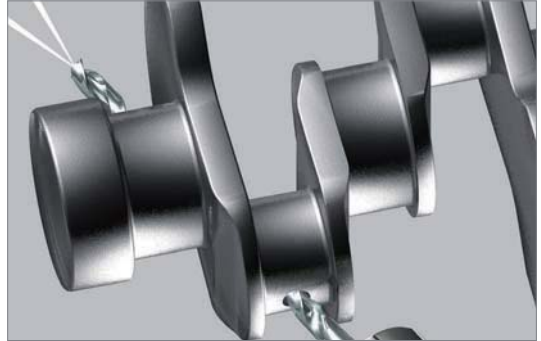

- Machining without step feed operation for deep hole drilling like 20D
- Optimal performance with MQL System

Pin & Journal - Crankshaft Cutter (Internal/External)

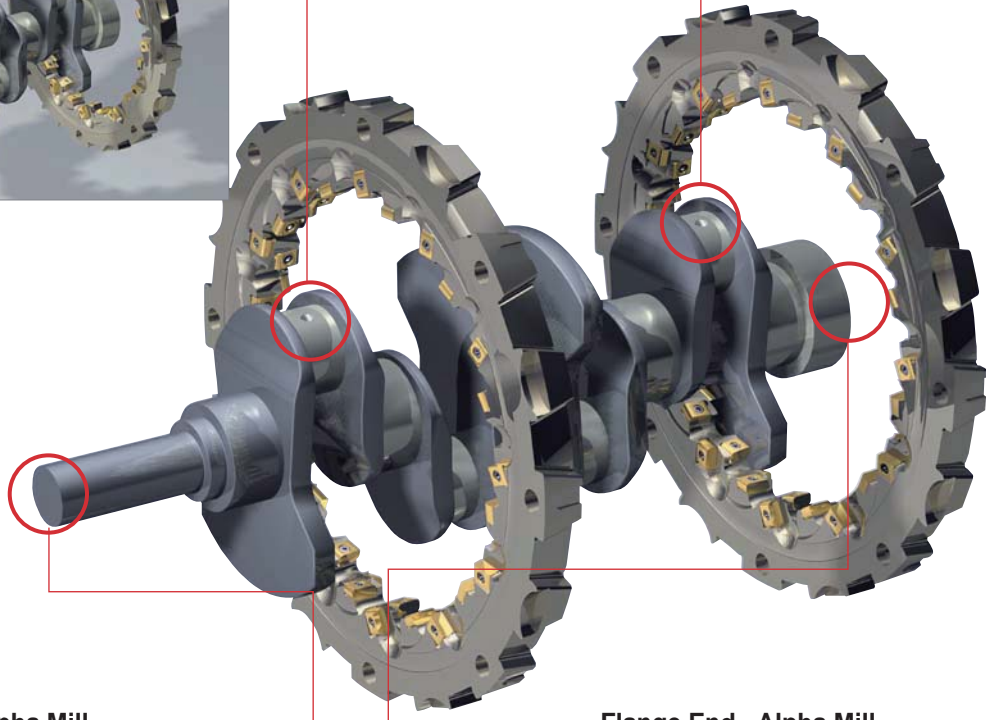

Post End - Alpha Mill

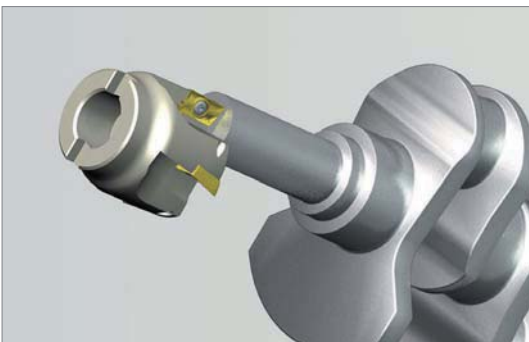

Flange End - Alpha Mill

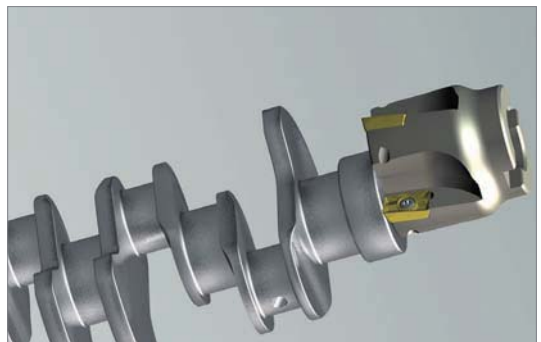

Automobile tooling example (Knuckle)

Micro Boring bar



Mach Drill



Micro Boring bar



Indexable Side Cutter (SPB)



Future Mill (FMP)



Indexable Side Cutter (Tangential type)



Indexable Side Cutter (Radial type)



Future Mill (FMP)



Step Drill



Drill (King Drill)



Automobile break tooling example (Carrier)

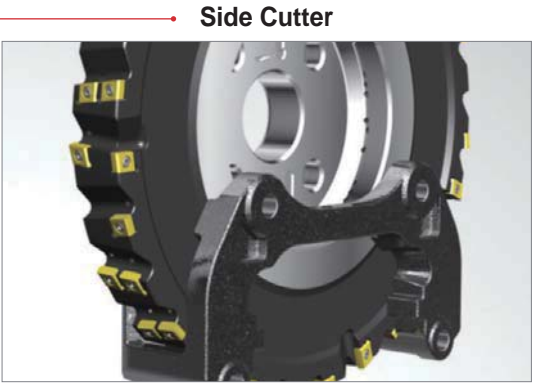

Automobile break tooling example (Housing)

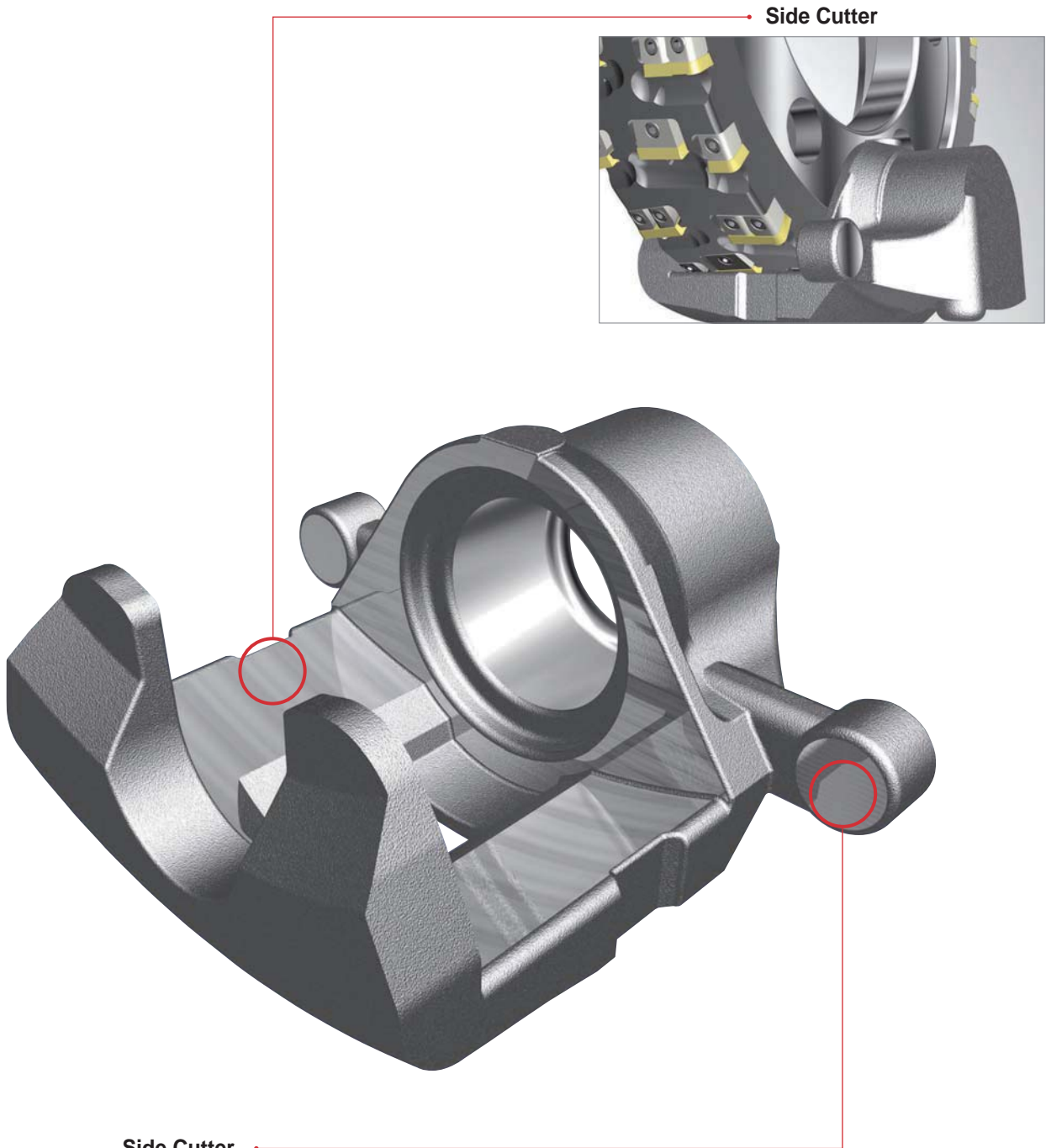

Automobile tooling example (Connecting Rod)

Drill



Rich Mill (RM4)

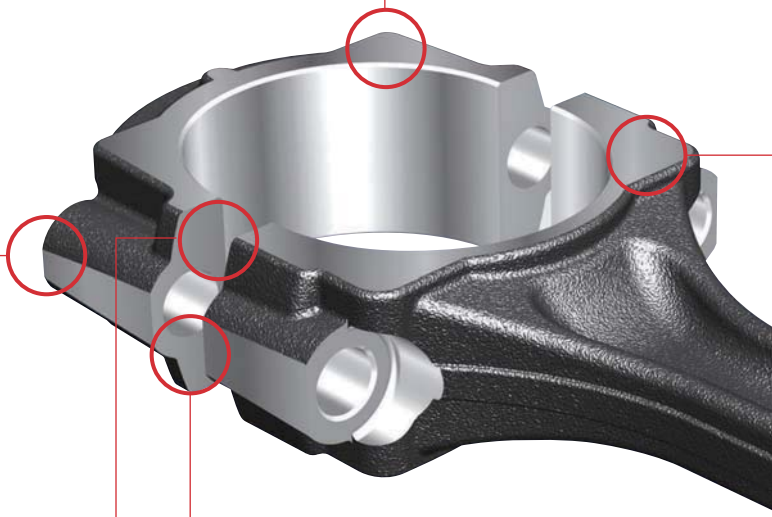

Side Cutter



Side Cutter



Rich Mill (RM4)



Rich Mill (RM8)



Drill (King Drill)



Step Drill



Drill



Automobile engine tooling example (Block)

Top Face (Roughing)

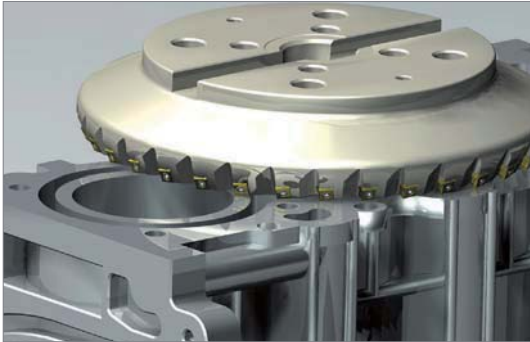

• Applied 8 corner edges of insert

Top Face (Finishing) - High feed Cutter

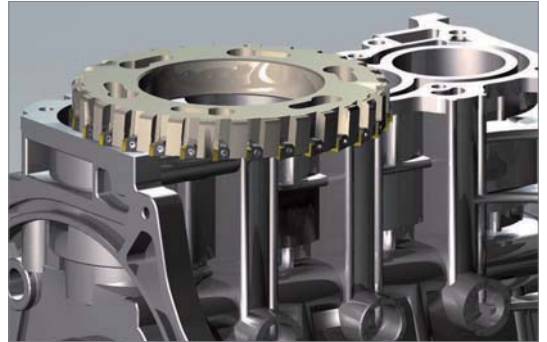

Bosses - Alpha Mill

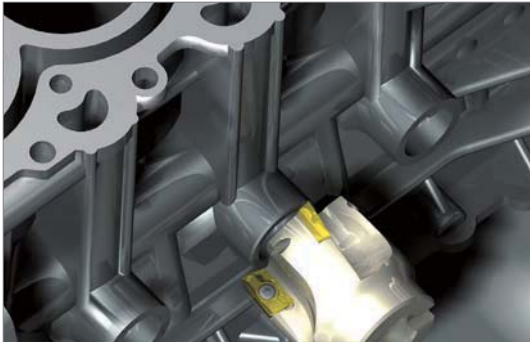

Line Boring Bar Reamer



Bearing Cap Seat - Form Cutter

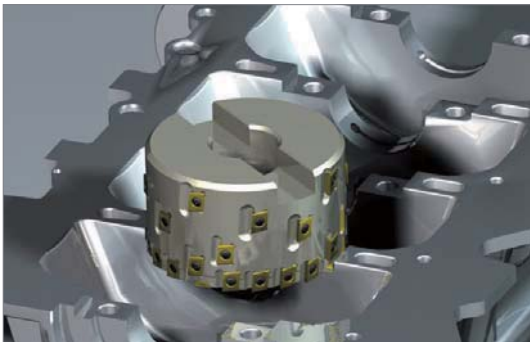

Crank Bore (Crankshaft Bearing Bore) - Form Cutter

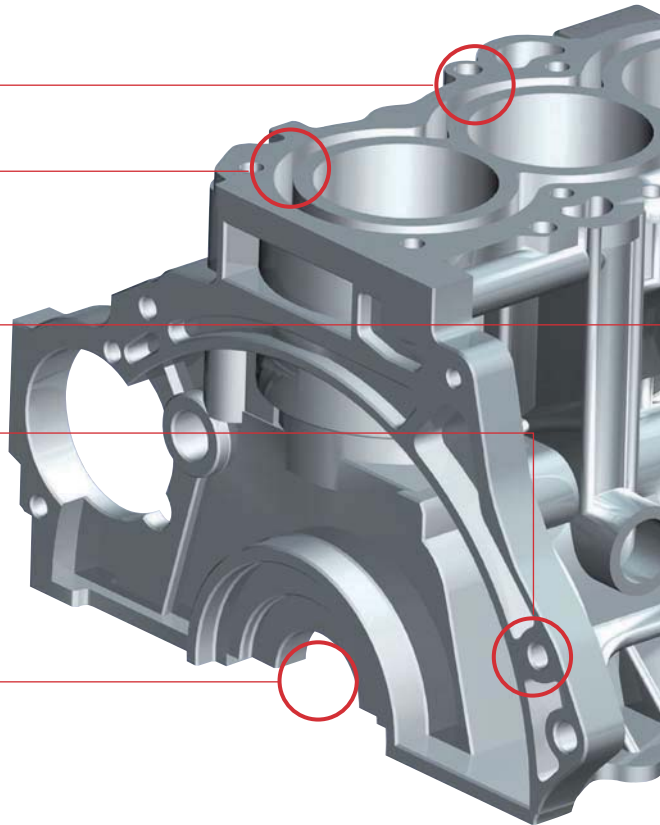

Cylinder Bore (Roughing) - Boring Cutter

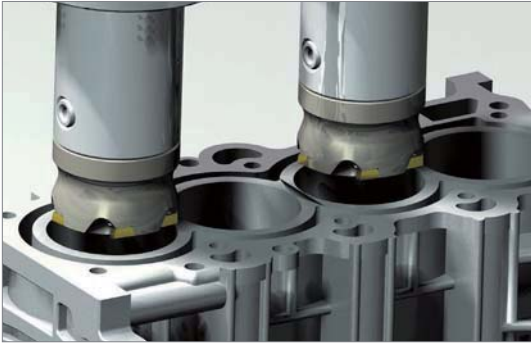

Front & Rear Face - Cube Couple Mill

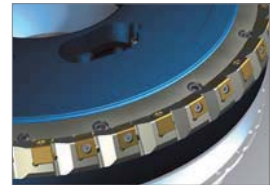
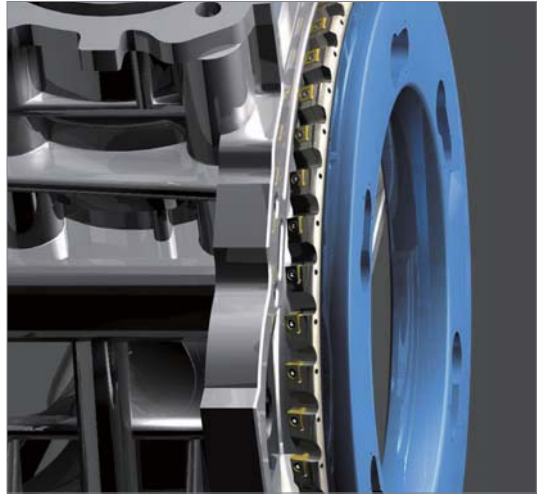

- High feed cutter made of aluminum
- Due to light weight, it's easy to handle & effective to prevent accident

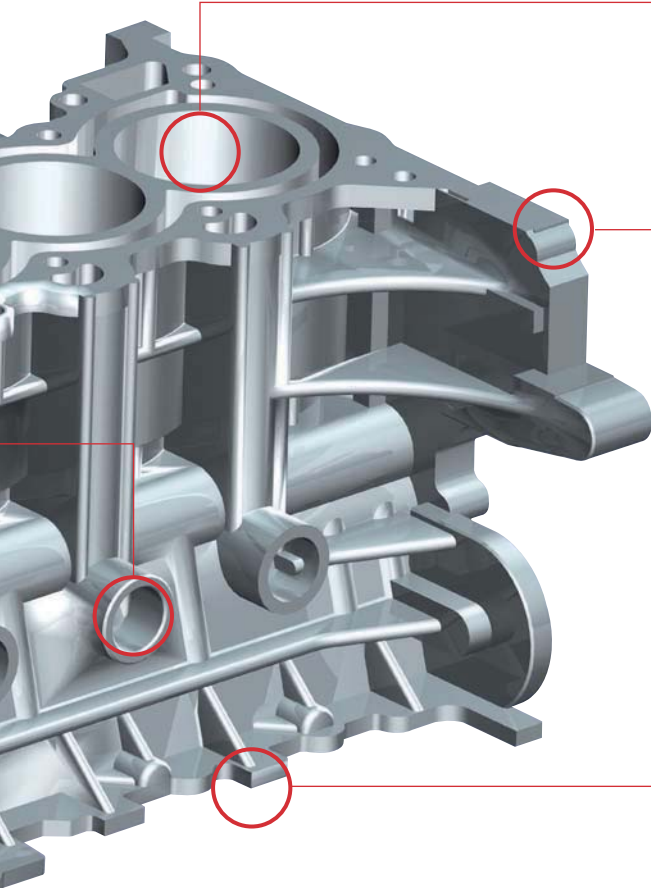

Cheek Faces - Gang Cutter

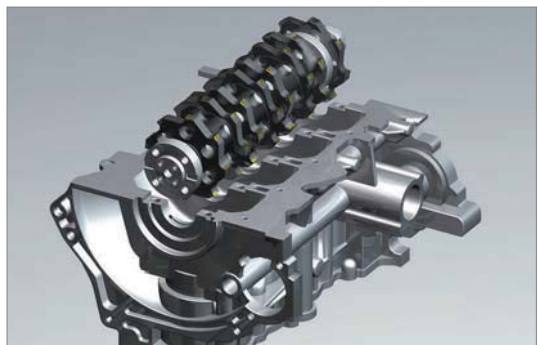

Cheek Faces - Gang Cutter



Automobile engine tooling example (Head)

Top Face (Roughing & Finishing) - High Feed Cutter

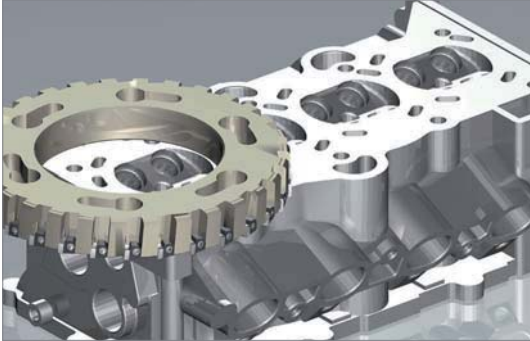

• Carbide insert, PCD insert

Top Face (Roughing & Finishing) - Aero Mill

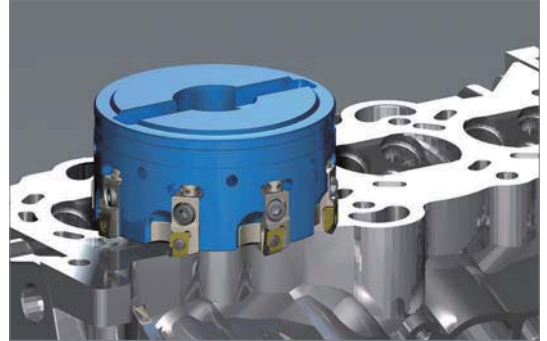

• Due to the light weight of aluminum body that about 50% of steel body, excellent cutting performance with high speed machining can be achieved

Step Burnishing Reamer



Straight Reamer

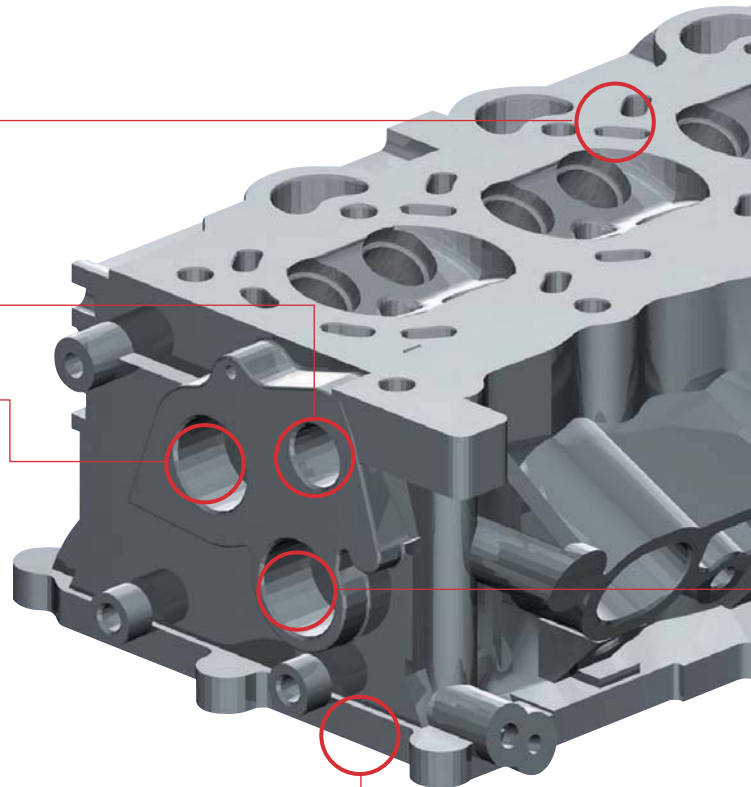

Bottom Face (Roughing & Finishing) - High feed Cutter



• Carbide insert, PCD insert

Counter Bore Tool



Valve Seat - Apolo Cutter (Special Boring Holder)

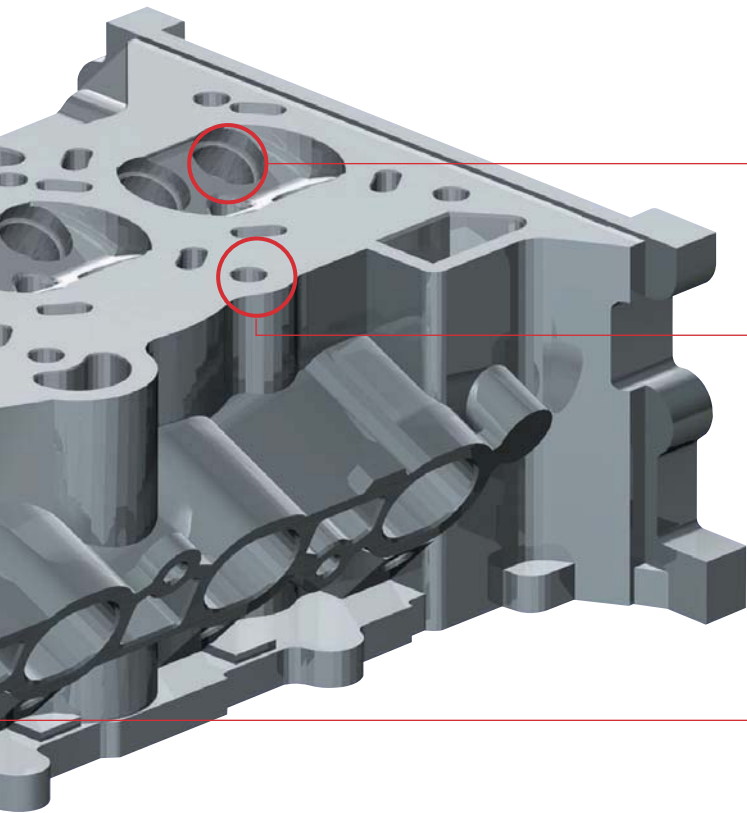
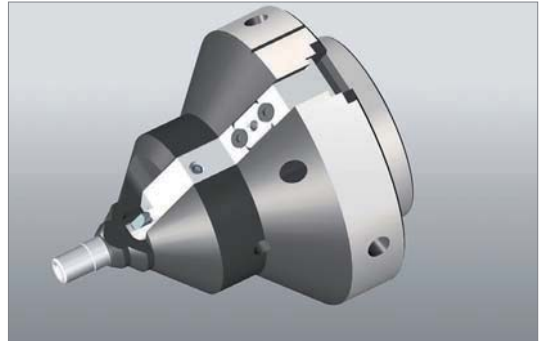

Top Face (Drilling) - Mach Drill

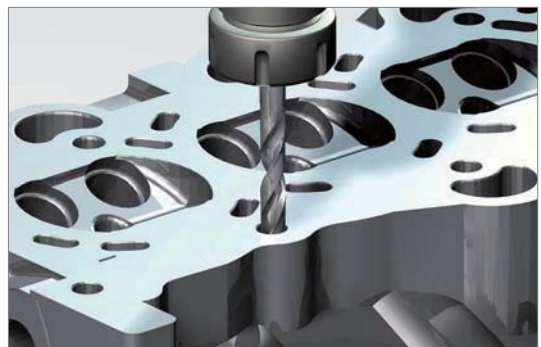

Cam Shaft Bearing Seat - Line Boring Bar

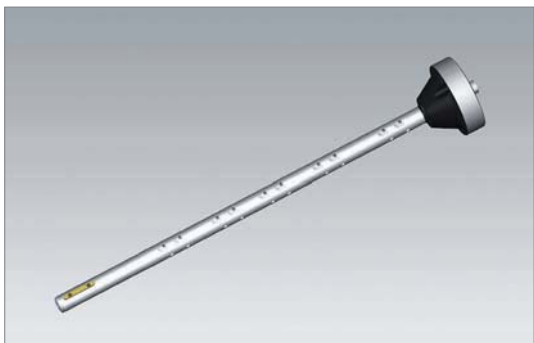

Cam Journal Bore - High Speed Reamer



- Stable machining at high speed without chattering

- Available for high speed machining
- Excellent surface finish & roundness



Parts

K02 Shim
K03 Cartridge
K03 Chip Breaker
K03 Chip Cover
K03 Clamp
K04 Coolant Bolt
K04 Wrench Bolt
K04 Lever

Parts

K05 Locator
K05 Nut
K05 Pin
K05 Screw
K06 Shim Pin
K07 Spring
K07 Wrench
K07 Stop Ring
K07 Washer
K07 Stopper
K07 Nozzle

PARTS

K

Geometry	Designation	Dimensions				
		a	b	c	d	angle
	SC32	8.5	3.18		4.9	
	SC32N	8.5	3.18		4.88	
	SC42	12.5	3.18		6.9	
	SC42N	11.6	3.18		6.5	
	SC53	15.7	4.76		7.9	
	SC53N	14.6	4.76		8.11	
	SC63	18.85	4.76		10	
	SC63N	17.8	4.76		9.6	
	SC83	24.4	4.76		12.8	
	SC84N	24.2	6.35		13	
	SC42B	12.5	3.18		6.9	
	SC42CC	12.5	3.18		3.5	
	SC32D	9.27	3.18		6.48	
	SC43D	12.45	4.76		7.34	
	SC53D	15.62	4.76		9.65	
	SC63D	18.8	4.76		11.25	
	SC84D	25.08	6.35		14.85	
	SC42S	11.5	3.18		6.4	
	SC32S	8.3	3.18		5.4	
	SC63V	18.35	4.76		5.5	
	SC83V	25.3	4.76		6.55	
	SC84V	25.3	6.35		6.35	
SC32V	9.12	3.18		3.4		
SC42V	12.6	3.18		4.5		
SC44V	12.6	6.35		4.5		
SC54V	15.75	6.35		5.5		
SS32V	9.12	3.18		3.4		
SS42V	12.6	3.18		4.5		
SS54V	15.75	6.35		5.5		
SS64V	18.9	6.35		5.5		
	SD317	9.35	2.7		5.2	
	SD32N	8.5	3.18		4.88	
	SD42	12.5	3.18		6.9	
	SD42N	11.6	3.18		6.5	
	SD43N	11.6	4.75		6.5	
	SD32D	9.2	3.18		5.8	
	SD43D	12.45	4.76		7.34	
	SD32S	8.5	3.18		5.4	
	SD42S	11.5	3.18		6.4	
	SD32V	9.12	3.18		3.4	
	SD43V	12.6	4.76		4.5	
	SD44V	12.6	6.35		4.5	

Geometry	Designation	Dimensions				
		a	b	c	d	angle
	SES33C	9.1	12	4.76	3.5	
	SK33C	9.33	14.7	4.8	3.5	
	SK33CL	9.33	14.7	4.8	3.5	
	SR10	8.4	3.18		4.7	
	SR12	10	3.18		4.7	
	SR16	13.55	4.76		6.9	
	SR20	17.1	4.85		7.9	
	SR25	22	6.35		9.6	
	SR32	27.8	6.35		13	
	SR42CC	12.575	3.18		3.5	
	SR10S	8.8	3.18		5.4	
	SR12S	10.55	3.18		5.4	
	SS32	8.5	3.18		4.9	
	SS32N	8.5	3.18		4.88	
	SS42	12.5	3.18		6.9	
	SS42B	12.5	3.18		6.9	
	SS42N	11.6	3.18		6.5	
	SS53	15.7	4.76		7.9	
	SS53N	14.6	4.76		8.11	
	SS63	18.85	4.76		10	
	SS63N	17.8	4.76		9.6	
	SS84	24.4	6.35		12.8	
	SS84N	24.2	6.35		13	
	SS42CC	12.5	3.18		3.5	
	SS32CC	9.3	3.18		3.5	
	SS32D	9.27	3.18		5.77	
	SS43D	12.45	4.76		7.34	
SS53D	15.62	4.76		9.65		
SS63D	18.8	4.76		11.25		
SS84D	25.15	6.35		14.43		
	SS32S	8.3	3.18		5.4	
	SS42S	11.5	3.18		6.4	
	SS42SAF	11.2	3		5.5	
	ST317	9.35	2.7		5	
	ST317B	9.35	2.7		5	
	ST317N	8.5	2.7		4.88	
	ST42	12.5	3.18		6.9	
	ST42N	11.6	3.18		6.5	
	ST53	15.7	4.76		7.9	



Shim

Geometry	Designation	Dimensions				
		a	b	c	d	angle
	ST32CC	9.35	3.18		3.5	
	ST32C1	9.13	3.18		4.95	
	ST42C1	12.3	3.18		4.95	
	ST32D	9.35	3.18		5.77	
	ST43D	12.52	4.76		7.34	
	ST53D	15.7	4.76		9.65	
	ST63D	18.87	4.76		11.25	
	ST32M	8.7	3.18		4.7	
	ST43M	12.5	4.76		6.3	
	ST32S	8.5	3.18		5.4	
	ST32V	9.12	3.18		3.4	
	ST44V	12.6	6.35		4.5	
	SV32D	9.2	3.18		5.8	
	SV43D	12.29	4.76		7.34	
	SV32D2	9.2	3.18		5.8	
	SV32S	8.4	3.18		5.4	
	SW317	9.35	2.7		5	
	SW317N	8.5	2.7		4.88	
	SW42	12.5	3.18		6.9	
	SW42N	11.6	3.18		6.5	
	SW32D	9.25	3.18		5.8	
	SW43D	12.45	4.76		7.34	
	SW53D	15.62	4.76		9.65	
	SW63D	18.8	4.76		11.25	
	SW84D	24.89	6.35		14.43	
	SW43M	12.5	4.76		6.2	
	SW32M	8.52	3.18		5.2	
	SW32V	9.12	3.18		3.4	
	SW44V	12.6	6.35		4.5	
	SW54V	15.75	4.76		5.5	

Cartridge

Geometry	Designation	Dimensions				
		a	b	c	d	angle
	LAPDR-AJ	M4x0.7	30	15	10	

Chip breaker

Geometry	Designation	Dimensions				
		a	b	c	d	angle
	CB20	8.5	3.4	20		

Chip cover

Geometry	Designation	Dimensions				
		a	b	c	d	angle
	CFMP3R14R1-A	10.5	20	1	(Ø4.3)	
	CFMP3R-A	8	18	1	(Ø4.3)	
	CFMP4R-A	8	22	1	(Ø4.3)	

Clamp

Geometry	Designation	Dimensions				
		a	b	c	d	angle
	CA05R	8.9	5.5	17.6	3.3	
	CA06R	12	7.2	20.6	5.3	
	CH5R3	7.85	7.2	14.8	3.1	
	CH6R4	12.02	9	23.97	3.75	
	CBH4.5R1	8	5.74	17.7	4	
	CBH4.5R2	9.5	6.4	18	4	
	CBH5R1	10	7.8	21.3	5	
	CBH6R1	12	9.3	26	6	
	CDH6N	9.5	10	18.6	6.1	
	CDH7N	7.9	11.4	14.7	4.7	
	CDH8N	10.9	16.9	22.4	6.1	
	CDH8N1	10.9	16.9	19.1	6.1	
	CDH8N2	10.9	16.9	25.4	6.1	
	CDH8N3	12.5	19.8	25.4	9.2	
	CDS8N	10.8	17	22.2	5	
	CGH5R1	19.5	9.5	28.8	2.5	
	CGH5R2	20.5	9.5	28.8	3.5	
	CGH5R3	22.5	9.5	28.8	5.5	

Clamp

Geometry	Designation	Dimensions				
		a	b	c	d	angle
	CGH6R1	22.3	11.9	23.2	2.5	
	CGH6R2	23.2	11.9	23.2	3.4	
	CGH6R3	24.0	11.9	23.2	4.2	
	CHH3.5R1	7.5	6.7	13	2.45	
	CHH4.5R1	7.9	7.85	14.1	2.54	
	CHH5.5R1	9.8	10	16.4	4	
	CH4R1	7.4	5	14.1	3.1	
	CH5R1	10.0	6.6	20.2	4.5	
	CH5R2	6.85	7	13.8	2	
	CH6R2	8.85	8.7	16.5	2	
	CH6R3	11.8	10	23	4.2	
	CMH5R1	18.5	7.9	16	6.26	
	CMH6R2	20.0	11	17.5	13.8	
	CMH6R6	18.5	7.9	16	6.26	
	CMH6R1	24	8.5	16.5	8.28	
	CMH6R3	20.0	11	17.51		
	CMH6L3	20.0	11	17.51		
	CS5R1	6.8	7	14.5	2	
	CS6R1	8.8	8.5	18.1	2.7	
	CS8R1	11.8	10	23	4.2	
	CTH6L1	23.5	12	25.4	14.35	
	CTH6R1	23.5	12	25.4	14.35	
	CTH6R2	21.78	12.9	31.22	17.33	
	CVH3	21	11	5.8	7.7	
	CVH3V	29	14	7	8	
	CVH4	25.5	14.5	6	7	
	CVH5	30	17	7.5	9.5	
	CVH6	33.5	18.5	8	10	
	CXH8N	10.1	10.0	17.5	-	

Coolant bolt

Geometry	Designation	Dimensions					
		a	b	c	d	B(T)	a'
	CBA063-3IN/MM	M10	Ø25	Ø16	37	8	(27)
	CBA063-4IN/MM	M10	Ø25	Ø16	42.5	8	(27)
	CBA080-IN/MM	M12	Ø28	Ø18	45.5	10	(32)
	CBP063-IN/MM	M10	Ø22	Ø16	38.6	8	(27)
	CBP080-IN/MM	M12	Ø25	Ø18	48.6	10	(32)

Coolant bolt

Geometry	Designation	Dimensions						
		a	b	c	d	B(T)	a'	
	CBA100-IN/MM	M16	Ø54	Ø43	47	14	(32)	
	CBA100-IN-25.4	M12	Ø44	Ø36	41.5	10	(25)	
	CBA125-IN	M20	Ø65	Ø54	56	17	(38)	
	CBA125-IN-25.4	M12	Ø44	Ø36	43.5	10	(25)	
	CBA125-MM	M20	Ø65	Ø54	57	17	(35)	
	CBA160-IN	M24	Ø83	Ø73	56	19	(38)	
	CBA160-MM	M20	Ø83	Ø73	53	17	(34)	
	CBP100-IN	M16	Ø50	Ø43	48.6	14	(32)	
	CBP100-IN-25.4	M12	Ø44	Ø36	46.5	10	(25)	
	CBP100-MM-1	M16	Ø50	Ø43	48.6	14	(36)	
	CBP125-IN	M20	Ø65	Ø54	56	17	(38)	
	CBP125-IN-25.4	M12	Ø44	Ø36	55	10	(25)	
	CBP125-MM	M20	Ø65	Ø54	57	17	(35)	
	CBP125-MM-1	M20	Ø61	Ø54	65.6	14	(33)	
	CBP160-IN	M24	Ø83	Ø73	56	19	(38)	
	CBP160-MM	M20	Ø83	Ø73	53	17	(34)	

Wrench bolt

Geometry	Designation	Dimensions				
		A	C	K	L	M
	SB0825	13	6	8	25	M08 x 1.25
	SB1025	16	8	10	25	M10 x 1.50
	SB1035	16	8	10	35	M10 x 1.50
	SB1230	18	10	12	30	M12 x 1.75
	SB1630	24	14	16	30	M16 x 2.0
	SB1645	24	14	16	45	M6 x 2.0
	SB2040	30	17	20	40	M20 x 2.5
	CB1025	13	6	8	25	M08x1,25
	CB1025	16	8	10	25	M10x1,50
	CB1035	16	8	10	35	M10x1,50
	CB1230	18	10	12	30	M12x1,75
	CB1245	18	10	12	45	M12x1,75
	CB1630	24	14	16	30	M16x2,0
	CB1645	24	14	16	45	M16x2,0
	CB2040	30	17	20	40	M20x2,5

Lever

Geometry	Designation	Dimensions				
		a	b	c	d	
	LR10	3.4	10.8	11.7	3	
	LR12	3.7	13.5	13.4	3.5	
	LR16	4.75	18.7	18.3	4.3	
	LR20	5.9	20.5	18.7	5.55	
	LR25	7.35	24.25	23.7	6.2	
	LR32	8.45	29.7	26.95	7.9	
		LV2	2.6	7.75	6	2.1
		LV3B	3.1	10	9.5	3.7
		LV4B	4.7	14.55	15.6	4.7
		LV4BN	4.7	16	14.9	4.68
LV3		3.7	10	12	3.6	
LV3N		3.75	10	12	3.55	
LV3AN		3.75	12.1	11.4	4.64	
LV3C		3.1	10	7.85	3.6	
	LV3CN	3.2	10	7.8	3.6	
	LV3DN	3.2	11.65	9.5	3.55	
	LV4	4.7	14.55	14	4.7	
	LV4N	4.7	13.45	13.2	4.68	
	LV5	6	17.1	17	6	
	LV5N	6	16.4	17.08	5.95	
	LV5AN	6	18.82	17.3	5.95	
	LV6N	7.5	20.5	21	7.6	
LV8N	8.6	25.5	25.4	8.6		

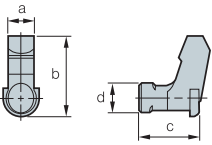

Lever

Geometry	Designation	Dimensions			
		a	b	c	d
	LV4A	4.6	13.24	9.95	4.7
	LV4AN	4.7	13.3	10	4.68

Locator

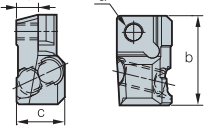
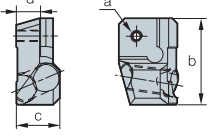
Geometry	Designation	Dimensions			
		a	b	c	d
	LFMP3R-A	M3.5	18.7	10.1	4.6
	LFMP4R1-A	M4.5	24.3	13.8	6.2
	LFMP4R-A	M4.5	26.3	13.8	6.2
	LFMA3R-A	M3	18.5	9.5	4.8
	LFMA4R-A	M3.5	26	13.1	7.3

Nut

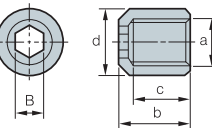
Geometry	Designation	Dimensions					
		a	b	c	d	B(T)	a'
	N0407	M4 X 0.7	7.5	6	7	3	
	N0508	M5 X 0.8	8.3	6.6	7	3	

Pin

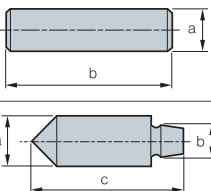
Geometry	Designation	Dimensions		
		a	b	c
	PN0308	3.0	8	
	PN0310	3.0	10	
	PN0312	3.0	12	
	PN0314	3.0	14	
	PN0515	4.8	3.3	14.5

Screw

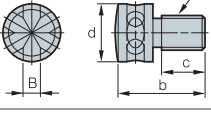
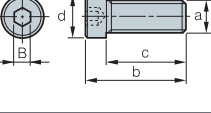
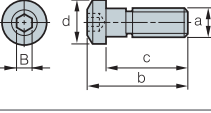
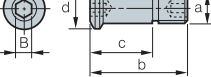
Geometry	Designation	Dimensions					
		a	b	c	d	B(T)	a'
	AZ0508F	M5 X 0.5	13	8	9	Ø2	
	AZ0514	M5 X 0.8	14	7	9	Ø2.5	
	BHA0510	M5 X 0.8	15	10	8.5	4.0	
	BHA0512	M5 X 0.8	17	12	8.5	4.0	
	BHA0612	M6 X 1.0	18	12	10	5.0	
	BHA0614	M6 X 1.0	20	14	10	5.0	
	BHA0616	M6 X 1.0	22	16	10	5	
	BHA0619-NYLOK	M6 X 1.0	25	19	10	5	
	CHX0407	M4 X 0.7	9.5	7.36	5.7	2.5	
	CHX0415	M4 X 0.7	17.5	15	5.4	2.5	
	CHX0510	M5 X 0.8	13.1	10.1	7.7	3	
	CHX0518	M5 X 0.8	21.5	18	8	3	
	CHX0622	M6 X 1.0	26.5	22	10	4	
	CHX0513	M5 X 0.8	13	8	6.4	2.5	
	CHX0616	M6 X 1.0	16.2	10.1	8.5	3	
	CHX0617L	M6 x 1.0 (Left)	17.2	10.1	8.5	3	
	CHX0621	M6 X 1.0	21	10.1	8.5	3	

Screw

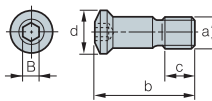
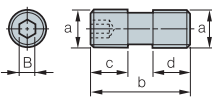
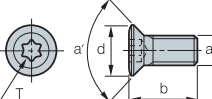
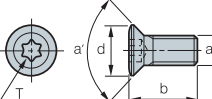
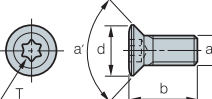
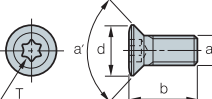
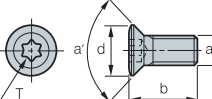
Geometry	Designation	Dimensions					
		a	b	c	d	B(T)	a'
	CHX0625	1/4-20UNC	24.8	11	10	4	
	CTX03510	M3.5 X 0.6	10	4.7	5.3	15	
	CTX04513	M4.5 X 0.75	13.1	6.9	6.8	20	
	CTX04513H	M4.5 X 0.75	13.1	7.2	6.8	20	
	CTX0515	M5 X 0.8	15	8	7	20	
	CTX0517	M5 X 0.8	17.5	10	7	20	
	CTX0621	M6 X 1.0	21.2	12.4	9	25	
	DHA0514	M5 X 0.8	14.0	5.0	7.0	2.5	
	DHA0617	M6 x 1.0	17.0	7.0	7.5	3.0	
	DHA0620	M6 x 1.0	20.0	8.0	8.0	3.0	
	DHA0624	M6 x 1.0	24.0	12.0	8.5	3.0	
	DHA0815	M8 X 1.25	15.5	6.25	6.25	4.0	
	DHA0818F	M8 X 1.0	18	8.5	5.5	4.0	
	DHA0820	M8 X 1.25	20.0	8.0	9.0	4.0	
	DHA0821F	M8 X 1.0	21.0	8.5	8.5	4.0	
	DHA0825	M8 X 1.25	25.0	10.0	9.0	4.0	
	DHA0830	M8 X 1.25	30.0	11.5	11.5	4.0	
	ETGA0520CBM	M5 X 0.8	20		6.5	20	43°
	ETGD0825	M8 X 1.25	25.2		11.1	40	40°
	ETKA0523	M5 X 0.8	23		7.6	20	43°
	ETKA0625	M6 X 1.0	25.5		8.8	20	43°
	ETKD0516	M5 X 0.8	16.4		6.8	20	40°
	ETKD0620	M6 X 1.0	20		8.3	25	40°
	ETNA02506	M2.5 X 0.45	5.7		3.4	7	43°
	ETNA0408	M4 X 0.7	8.0		5.1	15	43°
	ETNA0412	M4 X 0.7	12		5.1	15	43°
	ETNA0511	M5 X 0.8	11.0		6.4	20	43°
	ETND02506F	M2.5 X 0.35	6.25		3.1	7	40°
	ETND0307F	M3 X 0.35	7.8		3.7	8	40°
	ETND03509	M3.5 X 0.6	9.6		4.7	10	40°
	FTGA03507	M3.5 X 0.6	7.0		5.3	15	60°
	FTGA03508	M3.5 X 0.6	8.0		5.3	15	60°
	FTGA03510	M3.5 X 0.6	10.0		5.3	15	60°
	FTGA03512	M3.5 X 0.6	12.0		5.0	15	60°
	FTGA0411F	M4 X 0.5	11.0		7.0	15	60°
	FTGA0417CBM	M4 X 0.7	17.0		5.5	15	62°
	FTGA0510-P	M5 X 0.8	10.0		7.0	20	63°
	FTGA0512-P	M5 X 0.8	12.0		7.0	20	63°
	FTGA0513	M5 X 0.8	13.2		7.0	20	61°
	FTGA0513-P	M5 X 0.8	13.0		7.0	20	63°
	FTGA0517	M5 X 0.8	17.0		7.5	20	61°
	FTGA0621	M6 X 1.0	21.5		9.0	20	61°
	FTGA0826	M8 X 1.25	26.0		11.6	25	61°
		FTKA02206	M2.2 X 0.45	5.5		3.0	6
FTKA02206S		M2.2 X 0.45	5.6		3.05	7	60°
FTKA02555		M2.5 X 0.45	5.5		3.5	7	60°
FTKA02565		M2.5 X 0.45	6.5		3.5	7	60°
FTKA02565S		M2.5 X 0.45	6.5		3.8	8	60°
FTKA0307		M3 X 0.5	7.2		4.2	9	60°
FTKA03508		M3.5 X 0.6	8.4		5.5	15	60°
FTKA03510		M3.5 X 0.6	10.4		5.5	15	60°
FTKA03511A		M3.5 X 0.6	11.0		5.2	15	60°
FTKA0408		M4 X 0.7	8.4		5.5	15	60°
FTKA0410		M4 X 0.7	10.0		5.5	15	60°
	FTKA0411K	M4 X 0.7	11.0		6.8	15	60°
	FTKA0412B	M4 X 0.7	12.5		5.5	15	60°
	FTKA0413	M4 X 0.7	13.0		5.5	15	60°
	FTNA01633	M1.6 X 0.35	3.3		2.6	6	60°
	FTNA0203	M2 X 0.4	3.0		2.7	6	60°
	FTNA02033	M2 X 0.4	3.3		2.7	6	60°
	FTNA0204	M2 X 0.4	4.3		2.7	6	60°
	FTNA02205	M2.2 X 0.45	4.5		3.0	6	60°
	FTNA0238	M2 X 0.4	3.8		3.0	6	60°
	FTNA0305	M3 X 0.5	5.2		4.2	9	60°
	FTNA0306	M3 X 0.5	6.2		4.2	9	60°
	FTNA0307	M3 X 0.5	7.2		4.2	9	60°
	FTNA0408	M4 X 0.7	8.5		5.5	15	60°
	FTNA0411	M4 X 0.7	11.0		5.5	15	60°
	FTNA0511	M5 X 0.8	11		7.0	20	63°
	FTNA0513	M5 X 0.8	13.0		7.0	20	60°
FTNA0516	M5 X 0.8	16.0		7.0	20	60°	

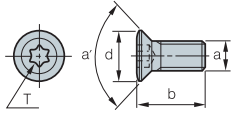
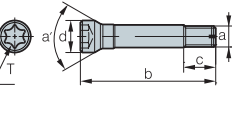
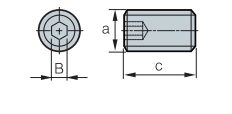
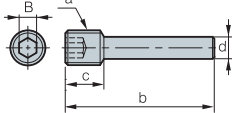
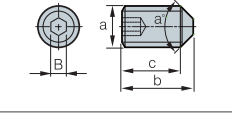
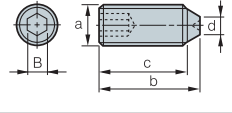
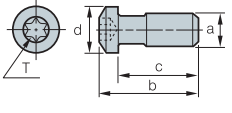
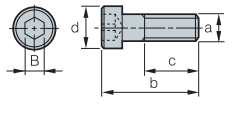
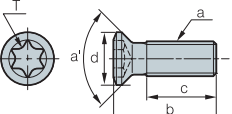

Screw

Geometry	Designation	Dimensions						
		a	b	c	d	B(T)	á	
	FTNB0411	M4 X 0.7	10.8	5.7	15	60°		
	FTNC04509	M4.5 X 0.75	9.5	6.8	20	55°		
	FTNC04511	M4.5 X 0.75	11.5	6.8	20	55°		
	FTNB0209	2 X 0.4	9	2.5	2.7	60°		
	FTNB0209-P	2 X 0.4	9	2.5	2.7	60°		
	FTNB02512	2.5 X 0.45	12	3.5	3.5	60°		
	FTNB02512-P	2.5 X 0.45	12	3.5	3.5	60°		
	FTNB02514	2.5 X 0.45	14	3.5	3.5	60°		
	FTNB02514-P	2.5 X 0.45	14	3.5	3.5	60°		
	FTNB0316	3 X 0.5	16	4.5	4.2	60°		
	FTNB0316-P	3 X 0.5	16	4.5	4.2	60°		
	FTNB0319	3 X 0.5	19	5	4.5	60°		
	FTNB03522	3.5 X 0.6	22	5.6	5.5	60°		
	FTNB03524	3.5 X 0.6	24	5.6	5.5	60°		
	FTNB0426	4 X 0.7	26	6.7	5.5	60°		
	FTNB0528	5 X 0.8	28	6.5	7	60°		
	KHA0508	M5 X 0.8	8		2.5			
	KHA0510	M5 X 0.8	10		2.5			
	KHA0610	M6 X 1.0	10		3			
	KHA0612	M6 X 1.0	12		3.0			
	KHA0812	M8 X 1.25	12		4.0			
	KHA0815	M8 X 1.25	15		4.0			
	KHA1015	M10 X 1.5	15		5.0			
	KHA1020	M10 X 1.5	20		5.0			
		KHB0417	M4 X 0.7	17.2	4.5	2.5	2	
		KHB0406	M4 X 0.7	6	4.2	3	2	
	KHC0510	M5 X 0.8	10	8.1	2.5	90°		
	KHC0610	M6 X 1.0	10	7.8	3.0	90°		
	KHC0812	M8 X 1.25	12	9	4.0	90°		
	KHC1016	M10 X 1.5	16	12.3	5.0	90°		
	KHC1020	M10 X 1.5	20	16.3	5.0	90°		
	KHD0510	M5 X 0.8	10	9	3	2.5		
	KHD0610	M6 X 1.0	10	10	4	3		
	KHD0810	M8 X 1.25	10	10	7.5	4		
	LTX0512	M5 X 0.8	15.1	12	7.3	20		
	LTX0514	M5 X 0.8	17.1	14	7.3	20		
	MHA0512	M5 X 0.8	17.0	10.8	8.0	4.0		
	MHB0310	M3 X 0.5	13.4	8.0	5.5	2.5		
	MHB0410	M4 X 0.7	14.0	8.0	7.0	3.0		
	MHB1055	M10 X 1.5	65	50	16	8		
	MHB1260	M12 X 1.75	72	55	18	10		
	MHB1680	M16 X 2.0	96	75	24	14		
	MHX0523	M5 X 0.8	23.5	9.7	10	2.5		
	MHX0626	M6 X 1.0	25.8	10	11	3		
MHX0630	M6 X 1.0	30	12.5	10.5	4			
	PTKA02508	M2.5 X 0.45	8	5	3.8	8	92°	
	PTKA03510	M3.5 X 0.6	10	5	5	15	92°	
	PTKA0407	M4 X 0.7	7	4.6	5.5	15	86°	
	PTKA0407F	M4 X 0.5	7.3	3.8	6.5	15	91°	
	PTKA0408	M4 X 0.7	8	5.6	5.5	15	86°	
	PTKA0408F	M4 X 0.5	8.3	5.7	6.5	15	91°	
	PTKA0409F	M4 X 0.5	9.3	6.7	6.5	15	91°	
	PTKA0410F	M4 X 0.5	10.3	7.7	6.5	15	91°	
	PTKA0411F	M4 X 0.5	11.3	8.7	6.5	15	91°	
	PTKA0412	M4 X 0.7	12	7.5	5.9	15	92°	
	PTKA0412F	M4 X 0.5	12.3	9.7	6.5	15	91°	
	PTKA0413F	M4 X 0.5	13.3	10.7	6.5	15	91°	
	PTKA0512	M5 X 0.8	12	7	6.9	20	92°	
	PTMA03508	M3.5 X 0.6	8	5.3	6	9	90°	
	PTMA0403F	M4 X 0.5	3.3	1.7	6.5	15	91°	
	PTMA0404F	M4 X 0.5	4.3	2.7	6.5	15	91°	
	PTMA0405F	M4 X 0.5	5.3	3.7	6.5	15	91°	
PTMA0406F	M4 X 0.5	6.3	4.7	6.5	15	91°		
PTMA0411	M4 X 0.7	11	8.5	6.6	15	90°		

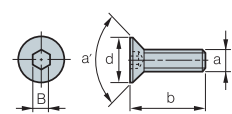
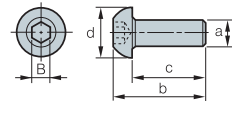
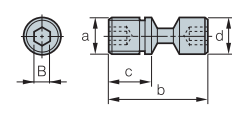
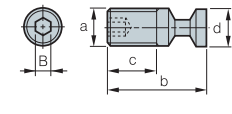
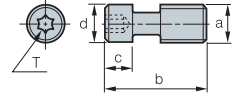
Geometry	Designation	Dimensions					
		a	b	c	d	B(T)	á
	FHGA0618	M6 X 1.0	18	8.5	4.0	61°	
	PXMA0306	M3 X 0.5	5.9	5.7	2	90°	
	SHX0310	M3 X 0.5	10	5.9	2	91°	
	RHA0510	M5 X 0.8	10	4.0			
	RHA0613	M6 X 1.0	16.3	13	10.5	4.0	
	RHA0620	M6 X 1.0	24	20	10.5	4.0	
	VHX0509B	M5 X 0.8	9	4.15	5	2	
	VHX0512B	M5 X 0.8	12	6.5	5	2	
	VHX0512BN	M5 X 0.8	12	6.56	5	2	
	VHX0514	M5 X 0.8	14.5	8.25	5	2	
	VHX0613N	M6 X 1.0	13.4	7.5	5.93	2.5	
	VHX0617	M6 X 1.0	17	10	6	2.5	
	VHX0617N	M6 X 1.0	16.75	8.34	5.9	2.5	
	VHX0621	M6 X 1.0	21	14	6	2.5	
	VHX0817N	M8 X 1.0	17.05	7.98	7.9	3	
	VHX0820N	M8 X 1.0	20.7	7.98	7.9	3	
	VHX0820AN	M8 X 1.0	20.5	10.36	7.9	3	
	VHX0821N	M8 X 1.0	21	10	8	3	
	VHX0821N	M8 X 1.0	21.2	9.68	7.9	3	
	VHX0823N	M8 X 1.0	23.5	10.36	7.9	3	
	VHX0825	M8 X 1.0	25	12	8	3	
	VHX1027N	M10 X 1.0	27.2	14.4	9.8	5	
	VHX1236N	M12 X 1.0	36	18.3	11.8	5	
VHX0613A	M6 X 1.0	13.4	9.1	6.0	2.5		
	SHXN0509F	M5 X 0.5	M3.5 X 0.6	8.65	6.3	3.5	
	SHXN0609F	M6 X 0.75	M4 X 0.7	9	7.8	4	
	SHXN0610F	M6 X 0.75	M4 X 0.5	10	7.8	4	
	SHXN0712F	M7 X 0.75	M5 X 0.8	12	8.5	5	
	WTX0813	M8 X 1.25	17.2	4.9	8.5	25	
	WTX0817	M8 X 1.25	22	4.9	8.5	25	

Shim pin

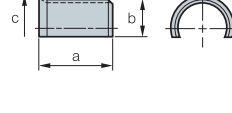
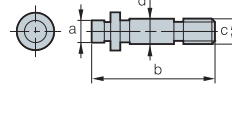
Geometry	Designation	Dimensions			
		a	b	c	d
	SP3	5.5	3.5	5.9	
	SP3N	6.85	3.3	5.55	
	SP4	7.0	4.0	7.6	
	SP4N	5.8	4.35	7.4	
	SP5	8.5	4.5	8.8	
	SP5N	8.5	5.68	9	
	SP6N	11.1	6.0	11.0	
	SP8N	12.0	10.0	15.35	
	SP2M	5	14	M5 X 0.8	6
	SP3M	3.5	19.5	M4 X 0.7	4
	SP3M-1	3.5	16.5	M4 X 0.7	4
	SP4M	5	19	M5 X 0.8	6

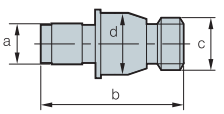

Shim pin

Geometry	Designation	Dimensions			
		a	b	c	d
	SP3D	3.7	13.1	UNF10-32	5.6
	SP3D2	3.6	12	UNF10-32	5.5
	SP3DS	3.7	11.54	UNF10-32	5.6
	SP4D	4.97	17.19	UNF1/4 28	7.12
	SP4DL	5	17.1	UNF1/4 28	7
	SP4DS	4.97	13.26	UNF1/4 28	
	SP5D	6.21	21.9	UNF5/16-24	9.44
	SP6D	7.75	21.9	UNF3/8-24	11.02
	SP8D	9.02	29.63	UNF7/16-20	14.21
	LSPS3	60	8.2	5.55	
LSPS4	65	10	7		
LSPS5	69	11.4	8.85		
LSPS6	69	13	11		
LSPS8	73	16.5	15.2		

Spring

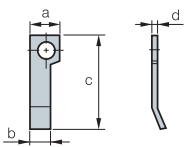
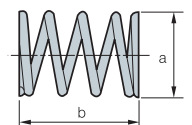
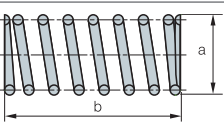
Geometry	Designation	Dimensions			
		a	b	c	d
	SR2	4.0	2.8	12.6	0.4
	SPR0315	3.0	15		
	SPR0415	4.0	15		
	SR3	9.2	12.5		
	SR4	4.0	11.0		
	SPR0714	7	14		
	SPR0510	5	10		
	SPR0714	7	14		
	SPR0811	8	11		

Wrench

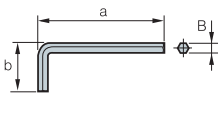
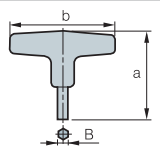
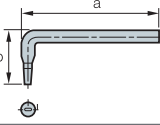
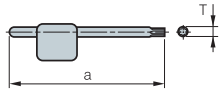
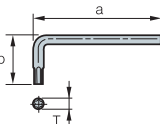
Geometry	Designation	Dimensions		
		a	b	B (T)
	HW20L	52	18	2
	HW25L	58.5	20.5	2.5
	HW30L	66	23	3
	HW35L	72	25	3.5
	HW40L	74	29	4
	HW50L	85	33	5
	HW40	82	80	4
	HW50	96	90	5
	SW50L	70	27.5	
	TW06P	63	6	
	TW07P	63	7	
	TW08P	71	8	
	TW09P	75	9	
	TW10P	78	10	
	TW15P	82	15	
	TW20P	86	20	
	TW15L	60	21	15
	TW20L	60	21	20

Wrench

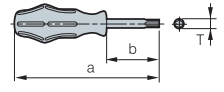
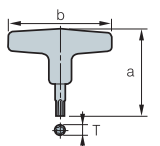
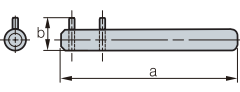
Geometry	Designation	Dimensions		
		a	b	B (T)
	TW07S	140	60	7
	TW08S	150	76	8
	TW09S	165	70	9
	TW15S	190	90	15
	TW20S	195	91	20
	TW20	75	80	20
	TW25	74	80	25
	SW15S	150	13	

Stop ring

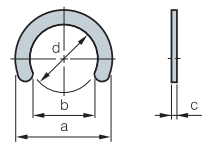
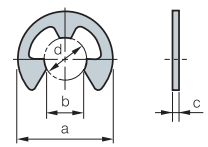
Geometry	Designation	Dimensions			
		a	b	c	d
	CR03	4.8	2.6	0.4	3.0
	CR04	6.6	3.6	0.4	4.0
	CR05	7.6	4.6	0.4	5.0
	ER03	7.0	2.6	0.6	3.0
	ER04	9.0	3.5	0.6	4.0
	ER05	11	4.3	0.6	5.0

Washer

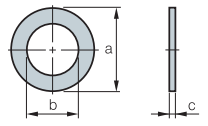
Geometry	Designation	Dimensions		
		a	b	c
	WA3	11.0	6.8	0.5~1.0
	WA4	10.0	5.3	0.5~1.0

Stopper

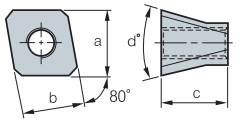
Geometry	Designation	Dimensions			
		a	b	c	d°
	STP5	11	10.2	11	30°

Nozzle

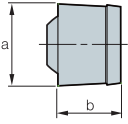
Geometry	Designation	Dimensions	
		a	b
	CN0605	6	4.6

L

TECHNICAL INFORMATION

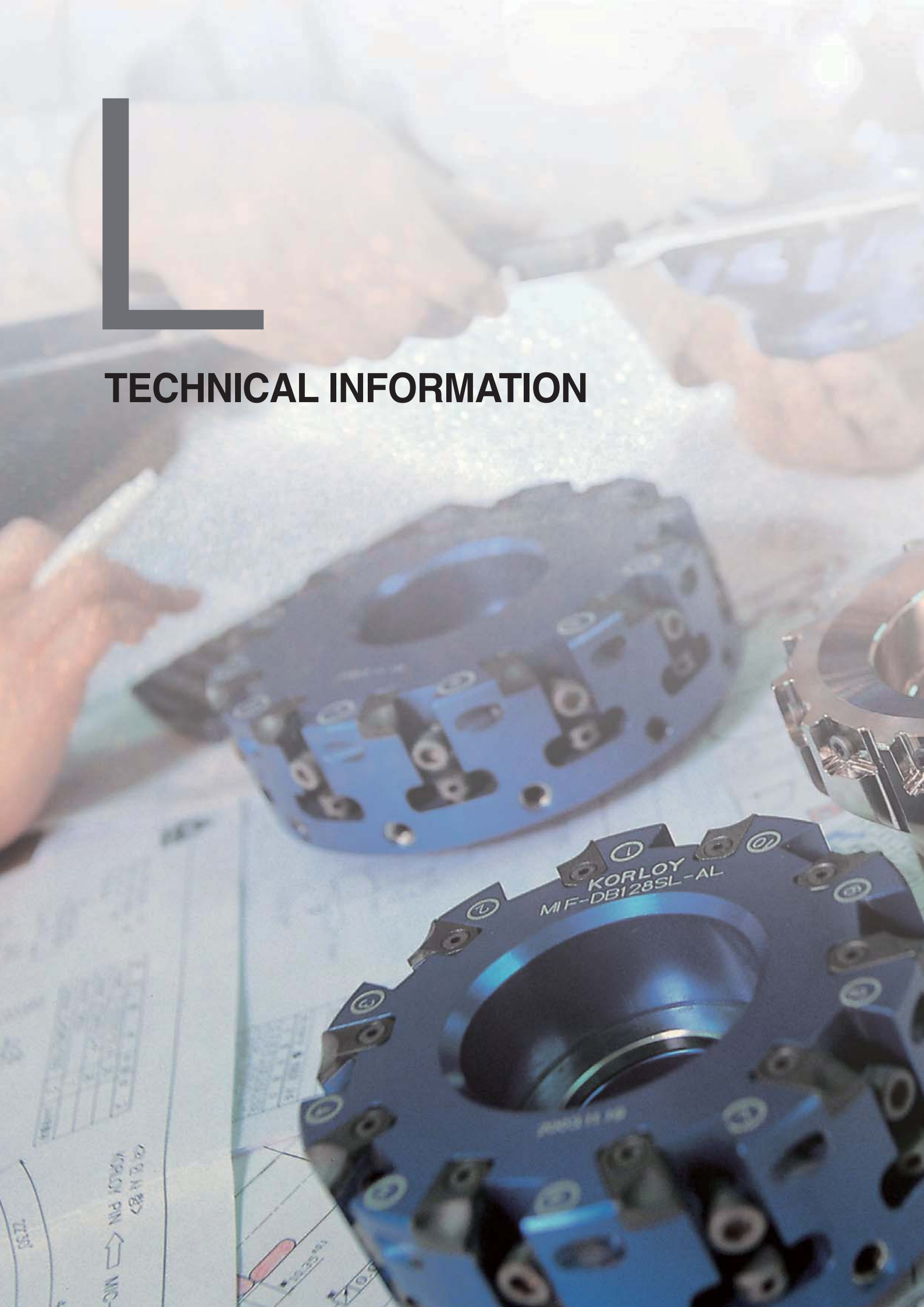

KORLOY
MIF-DB128SL-AL

02.12.11.877
VPSH P.M. ← M.C.

TS3

General Information I

- L02 Workpiece Material Grades
- L06 Steel, Non-ferrous Metal Symbol List
- L07 SI unit Conversion Table
- L08 Hardness Calculating Table
- L09 Properties of Korloy Grades

Technical Information

- L10 Technical Information for Turning
- L20 Technical Information for Milling
- L24 Technical Information for Tapers
- L27 Technical Information for Endmills
- L30 Technical Information for Drills

General Information II

- L36 The Comparison of Chip Breakers
- L37 KORLOY Grades
- L40 The Comparison of Grade for Turning
- L41 The Comparison of Grade for Milling



Carbon steel and alloy steel for structural use

Type	Korea	ISO	Japan	U.S.A	Great Britain	Germany	France	Russia	
	KS	ISO	JIS	AISI SAE	BS BS/EN	DIN DIN/EN	NF NF/EN	GOCT	
Carbon steel	SM10C	C10	S10C	1010	040A10 045A10 045M10	C10E C10R	XC10	-	
	SM15C	C15E4 C15M2	S15C	1015	055M15	C15E C15R	-	-	
	SM20C	-	S20C	1020	070M20 C22, C22E C22R	C22 C22E C22R	C22 C22E C22R	-	
	SM25C	C25 C25E4 C25M2	S25C	1025	C25 C25E C25R	C25 C25E C25R	C25 C25E C25R	-	
	SM30C	C30 C30E4 C30M2	S30C	1030	080A30 080M30 CC30 C30E C30R	C30 C30E C30R	C30 C30E C30R	30 Г	
	SM35C	C35 C35E4 C35M2	S35C	1035	C35 C35E C35R	C35 C35E C35R	C35 C35E C35R	35 Г	
	SM40C	C40 C40E4 C40M2	S40C	1039 1040	080M40 C40 C40E C40R	C40 C40E C40R	C40 C40E C40R	40 Г	
	SM43C	-	S43C	1042 1043	080A42	-	-	40 Г	
	SM45C	C45 C45E4 C45M2	S45C	1045 1046	C45 C45E C45R	C45 C45E C45R	C45 C45E C45R	45 Г	
	SM48C	-	S48C	-	080A47	-	-	45 Г	
	SM50C	C50 C50E4 C50M2	S50C	1049	080M50 C50 C50E C50R	C50 C50E C50R	C50 C50E C50R	50 Г	
	SM53C	-	S53C	1050 1053	-	-	-	50 Г	
	SM55C	C55 C55E4 C55M2	S55C	1055	070M55 C55 C55E C55R	C55 C55E C55R	C55 C55E C55R	-	
	SM58C	C60 C60E4 C60M2	S58C	1059 1060	C60 C60E C60R	C60 C60E C60R	C60 C60E C60R	60 Г	
Alloy steel	Nickel chromium steel	SNC236	-	SNC236	-	-	-	40XH	
		SNC415(H)	-	SNC415(H)	-	-	-	-	
		SNC631(H)	-	SNC631(H)	-	-	-	30XH3A	
		SNC815(H)	15NiCr13	SNC815(H)	-	655M13(655H13)	15NiCr13	-	
		SNC836	-	SNC836	-	-	-	-	
	Nickel chromium molybdenum steel	SNCM220	20NiCrMo2 20NiCrMoS2	SNCM220	8615 8617(H) 8620(H) 8622(H)	805A20 805M20 805A22 805M22	20NiCrMo2 20NiCrMoS2	20NCD2	-
		SNCM240	41CrNiMo2 41CrNiMoS2	SNCM240	8637 8640	-	-	-	
		SNCM415	-	SNCM415	-	-	-	-	
		SNCM420(H)	-	SNCM420(H)	4320(H)	-	-	-	20XH2M(20XHM)
		SNCM431	-	SNCM431	-	-	-	-	
		SNCM439	-	SNCM439	4340	-	-	-	
		SNCM447	-	SNCM447	-	-	-	-	
		SNCM616	-	SNCM616	-	-	-	-	
		SNCM625	-	SNCM625	-	-	-	-	
		SNCM630	-	SNCM630	-	-	-	-	
	SNCM815	-	SNCM815	-	-	-	-		
Chromium steel	SCr415(H)	-	SCr415(H)	-	-	17Cr3 17CrS3	-	15X 15XA	
	SCr420(H)	20Cr4(H) 20CrS4	SCr420(H)	5120(H)	-	-	-	20X	
	SCr430(H)	34Cr4 34CrS4	SCr430(H)	5130(H) 5132(H)	34Cr4 34CrS4	34Cr4 34CrS4	34Cr4 34CrS4	30X	
	SCr435(H)	34Cr4 34CrS4 37Cr4 37CrS4	SCr435(H)	5135(H)	37Cr4 37CrS4	37Cr4 37CrS4	37Cr4 37CrS4	35X	
	SCr440(H)	37Cr4 37CrS4 41Cr4 41CrS4	SCr440(H)	5140(H)	530M40 41Cr4 41CrS4	41Cr4 41CrS4	41Cr4 41CrS4	40X	
	SCr445(H)	-	SCr445(H)	-	-	-	-	45X	

• The above Alloy steel can supplied by domestic manufacturing





Type		Korea	ISO	Japan	U.S.A	Great Britain	Germany	France	Russia	
		KS	ISO	JIS	AISI SAE	BS BS/EN	DIN DIN/EN	NF NF/EN	GOCT	
Alloy steel	Chromium molybdenum steel	SCM415(H)	-	SCM415(H)	-	-	-	-	-	
		SCM418(H)	18CrMo4 18CrMoS4	SCM418(H)	-	-	18CrMo4 18CrMoS4	-	20XM	
		SCM420(H)	-	SCM420(H)	-	708M20(708H20)	-	-	20XM	
		SCM430	-	SCM430	4130	-	-	-	30XM 30XMA	
		SCM432	-	SCM432	-	-	-	-	-	
		SCM435(H)	34CrMo4 34CrMoS4	SCM435(H)	(4135H) 4137(H)	34CrMo4 34CrMoS4	34CrMo4 34CrMoS4	34CrMo4 34CrMoS4	35XM	
		SCM440(H)	42CrMo4 42CrMoS4	SCM440(H)	4140(H) 4142(H)	708M70 709M40 42CrMo4 42CrMoS4	42CrMo4 42CrMoS4	42CrMo4 42CrMoS4	-	
		SCM445(H)	-	SCM445(H)	4145(H) 4147(H)	-	-	-	-	
	Manganese steel and Manganese chromium steel	SMn420(H) SMn433(H)	22Mn6(H) -	SMn420(H) SMn433(H)	1522(H) 1534	150M19 150M36	- -	- -	- 30 Г 2 35 Г 2 35 Г 2 40 Г 2 40 Г 2 45 Г 2	
		SMn438(H)	36Mn6(H)	SMn438(H)	1541(H)	150M36	-	-	-	
		SMn443(H)	42Mn6(H)	SMn443(H)	1541(H)	-	-	-	-	
		SMnC420(H) SMnC443(H)	- -	SMnC420(H) SMnC443(H)	- -	- -	- -	- -	- -	
		Aluminum chromium molybdenum steel	SACM645	41CrAlMo74	SACM645	-	-	-	-	-

• The above Alloy steel can supplied by domestic manufacturing

Tool steel

Type		Korea	ISO	Japan	U.S.A	Great Britain	Germany	France	Russia	
		KS	ISO	JIS	AISI SAE	BS BS/EN	DIN DIN/EN	NF NF/EN	GOCT	
High speed steel	SKH2	HS18-0-1	SKH2	T1	BM 2	S6/5/2	Z 85 WDCV			
	SKH3	-	SKH3	T4						
	SKH4	-	SKH4	T5						
	SKH10	-	SKH10	T15						
	SKH51	HS6-5-2	SKH51	M2						
	SKH52	HS6-6-2	SKH52	M3-1	BM 35	S6/5/2/5	6-5-2-5			
	SKH53	HS6-5-3	SKH53	M3-2						
	SKH54	HS6-5-4	SKH54	M4						
	SKH55	HS6-5-2-5	SKH55	M 35						
	SKH56	-	SKH56	M36						
	SKH57	HS10-4-3-3-10	SKH57	-					S2/9/2	
	SKH58	HS2-9-2	SKH58	M7						
	SKH59	HS2-9-1-8	SKH59	M42						
Alloy tool steel	STS11	-	SKS11	F2						
	STS2	-	SKS2	-						
	STS21	-	SKS21	-						
	STS5	-	SKS5	-						
	STS51	-	SKS51	L6						
	STS7	-	SKS7	-						
	STS8	-	SKS8	-						
	STS4	-	SKS4	-						
	STS41	-	SKS41	-						
	STS43	105V	SKS43	W2-9 1/ W2-8 1-2						
	STS44	-	SKS44	-						
	STS3	-	SKS3	-					105WCr6	105WC13
	STS31	105WCr1	SKS31	-						
	STS93	-	SKS93	-	BD3	X210Cr12	Z200C12			
	STS94	-	SKS94	-						
	STS95	-	SKS95	-						
	STD1	210Cr12	SKD1	D3						
	STD11	-	SKD11	D2				BA2	X100CrMoV5 1	Z100CDV5
	STD12	100CrMoV5	SKD12	A2						
	STD4	-	SKD4	-				BH21	X30WCrV9 3	Z30WCv9
	STD5	X30WCrV9-3	SKD5	H21						
	STD6	X37CrMoV5-1	SKD6	H11				BH13	X40CrMoV5 1	Z40CDV5
	STD61	X40CrMoV5-1	SKD61	H13						
	STD62	X35CrWMoV5	SKD62	H12						
	STD7	32CrMoV12-28	SKD7	H10						
	STD8	-	SKD8	H19	55NiCrMoV6	55NCDV7				
STF3	-	SKT3	-							
STF4	55NiCrMoV7	SKT4	L6							

• The above Alloy steel can supplied by domestic manufacturing



General Information I

Type	Korea	ISO	Japan	U.S.A	Great Britain	Germany	France	Russia
	KS	ISO	JIS	AISI SAE	BS BS/EN	DIN DIN/EN	NF NF/EN	GOCT
Free cutting carbon steel	SUM11	-	SUM11	1110				
	SUM12	-	SUM12	1109				
	SUM21	9S20	SUM21	1212				
	SUM22	11SMn28	SUM22	1213	230M07	9SMn28	S250	
	SUM22L	11SMnPb28	SUM22L	12L13		9SMnPb28	S250Pb	
	SUM23	-	SUM23	1215	240M07	9SMn36	S 300	
	SUM23L	-	SUM23L	-				
	SUM24L	11SMnPb28	SUM24L	12L14		9SMnPb36	S300Pb	
	SUM25	12SMn35	SUM25	-				
	SUM31	-	SUM31	1117				
	SUM31L	-	SUM31L	-				
	SUM32	-	SUM32	-				
	SUM41	-	SUM41	1137				
	SUM42	-	SUM42	1141				
	SUM43	44SMn28	SUM43	1144				
	High carbon chromiom	STB1	-	SUJ1	-			
STB2		B1	SUJ2	52100	534A99	100Cr6	100Cr6	
STB3		B2	SUJ3	ASTM A 485 Grade 1				
STB4		-	SUJ4	-				
STB5		-	SUJ5	-				

• The above Alloy steel can supplied by domestic manufacturing

Stainless steel

Type		Korea	ISO	Japan	U.S.A		Great Britain	Germany	France	Russia	
		KS	ISO	JIS	UNS	AISI SAE	BS BS/EN	DIN DIN/EN	NF NF/EN	GOCT	
Stainless steel	Austenitic	STS201	X12CrMnNiN17-7-5	SUS201	S20100	201	284S16	X12CrNi17-7	Z12CMN17-07Az	12X17-9AH4	
		STS202	X12CrMnNiN18-9-5	SUS202	S20200	202	301S21	X2CrNiN18-7		07X16H6	
		STS301	X10CrNi18-8	SUS301	S30100	301		X12CrNi17-7	Z11CN17-08		
		STS301L	X2CrNiN18-7	SUS301L							
		STS301J1		SUS301J1			302S25			12X18H9	
		STS302		SUS302	S30200	302			X10CrNiS18-9	Z12CN18-09	
		STS302B	X12CrNiSi18-9-3	SUS302B	S30215	302B	303S21				
		STS303	X10CrNiS18-9	SUS303	S30300	303	303S41			Z8CNF18-09	12X18H10E
		STS303Se		SUS303Se	S30323	303Se			X5CrNi18-10		08X18H10
		STS303Cu		SUS303Cu			304S31		X2CrNi19-11	Z7CN18-09	
		STS304	X5CrNi18-9	SUS304	S30400	304					03X18H11
			X2CrNi18-9				304S11				
		STS304L	X2CrNi19-11	SUS304L	S30403	304L			X2CrNiN18-10	Z3CN19-11	
		STS304N1	X5CrNiN18-8	SUS304N1	S30451	304N				Z6CN19-09Az	
		STS304LN	X2CrNiN18-8	SUS304LN	S30453	304LN			X5CrNi18-12	Z3CN18-10Az	
		STS304J1		SUS304J1			305S19				06X18H11
		STS305	X6CrNi18-12	SUS305	S30500	305				Z8CN18-12	
		STS309S		SUS309S	S30908	309S	310S31		X5CrNiMo27-12-2	Z10CN24-13	10X23H18
	STS310S	X6CrNi25-20	SUS310S	S31008	310S	316S31		X5CrNiMo27-13-3	Z8CN25-20		
	STS316	X5CrNiMo17-12-2	SUS316	S31600	316			X2CrNiMo17-13-2	Z7CND17-12-02		
		X3CrNiMo17-12-3						X2CrNiMo17-14-3	Z6CND18-12-03	03X17H14M3	
	STS316L	X2CrNiMo17-12-2	SUS316L	S31603	316L				Z3CND17-12-02		
		X2CrNiMo17-12-3							Z3CND17-12-03		
		X2CrNiMo18-14-3									
	STS316N		SUS316N	S31651	316N	317S16		X6CrNiTi18-10			
	STS317		SUS317	S31700	317	321S31		X6CrNiNb18-10		08X18H10T	
	STS321	X6CrNiTi18-10	SUS321	S32100	321	347S31			Z6CNT18-10	08X18H12	
	STS347	X6CrNiNb18-10	SUS347	S34700	347			X6CrAl13	Z6CNNb18-10		
	STS384	X3NiCr18-16	SUS384	S38400	384	405S17			Z6CN18-16		
	STS405	X6CrAl13	SUS405	S40500	405				Z8CA12		
	STS410L		SUS410L					X6Cr17	Z3C14		
	STS429		SUS429	S42900	429	430S17		X7CrS18		12X17	
	STS430	X6Cr17	SUS430	S43000	430			X6CrMo17-1	Z8C17		
	STS430F	X7CrS17	SUS430F	S43020	430F	434S17			Z8CF17		
	STS434	X6CrMo17-1	SUS434	S43400	434				Z8CD17-01		
	STS444	X2CrMoTi18-2	SUS444	S44400	444				Z3CDT18-02		
STX2M27		SUSXM27	S44627				X10Cr13	Z1CD26-01			
STS403		SUS403	S40300	403							
STS410	X12Cr13	SUS410	S41000	410	410S21		X20Cr13	Z13C13			
STS416	X12CrS13	SUS416	S41600	416	416S21		X20CrNi17-2	Z11CF13	20X13		
STS420J1	X20Cr13	SUS420J1	S42000	420	420S29			Z20C13	20X17H2		
STS431	X19CrNi16-2	SUS431	S43100	431	431S29			Z15CN16-02			
STS440A	X70CrMo15	SUS440A	S44002	440A			X7CrNiAl17-7	Z70C15			
STS630	X5CrNiCuNb16-4	SUS630	S17400	S17400				Z6CNU17-04	09X17H7IO		
STS631	X7CrNiAl17-7	SUS631	S17700	S17700				Z9CNA17-07			
STS631J1		SUS631J1									

• The above Alloy steel can supplied by domestic manufacturing



➤ Casting or forging steel

Type		Korea	ISO	Japan	U.S.A	Great Britain	Germany	France	Russia
		KS	ISO	JIS	AISI SAE	BS BS/EN	DIN DIN/EN	NF NF/EN	GOCT
Casting Iron	Grey iron casting	GC100	100,150, 200, 250, 300, 350	FC100	No 20 B	Grade 150 Grade 220 Grade 260 Grade 300 Grade 350 Grade 400	GG 10	Ft 10 D	-
		GC150		FC150	No 25 B		GG 15	Ft 15 D	
		GC200		FC200	No 30 B		GG 20	Ft 20 D	
		GC250		FC250	No 35 B		GG 25	Ft 25 D	
		GC300		FC300	No 45 B		GG 30	Ft 30 D	
		GC350		FC350	No 50 B		GG 35	Ft 35 D	
	Spheroidal graphite iron casting	GCD400	700-2, 600-3, 500-7, 450-10, 400-15, 400-18, 350-22	FCD400	60-40-18	SNG 420/12 SNG 370/17 SNG 500/7 SNG 600/3 SNG 700/2	GGG 40 GGG 40.3 GGG 50 GGG 60 GGG 70	FCS 400-12 FGS 370-17 FGS 500-7 FGS 600-3 FGS 700-2	B
		GCD500		FCD500	80-55-06				
		GCD600		FCD600	100-70-03				
		GCD700		FCD700					
	Austempered Spheroidal graphite iron casting	FCAD	-	FCAD	-	EN-GJS-	EN-GJS-	EN-GJS-	-
	Austenitic iron casting	FCA-FCDA-	L-, S-	FCA-FCDA-	Type 1, 2, Type D-2, D-3A Class 1, 2	F1, F2, S2W, S5S	GGL-, GGG-	L-, S-	-

➤ Non-ferrous alloy

Type		Korea	ISO	Japan	U.S.A	Great Britain	Germany	France	Russia
		KS	ISO	JIS	AISI SAE	BS BS/EN	DIN DIN/EN	NF NF/EN	GOCT
Aluminum alloy	Aluminum alloy ingots for casting	AC1B	Al-Cu4MgTi	AC1B	204.0	-	-	A-U5GT	
		AC2A	-	AC2A	-	-	-	-	
		AC2B	-	AC2B	319.0	-	-	-	
		AC3A	-	AC3A	-	LM-6	-	-	
		AC4A	-	AC4A	-	-	G(GK)-AlSi9Cu3	-	
		AC4B	-	AC4B	-	-	-	-	
		AC4C	Al-Si7Mg(Fe)	AC4C	356.0	LM-25	G(GK)-AlSi7MG	A-S7G	
		AC4CH	Al-Si7Mg	AC4CH	A356.0	-	-	-	
		AC4D	Al-Si5Cu1Mg	AC4D	355.0	LM-16	-	-	
		AC5A	Al-Cu4Ni2Mg2	AC5A	242.0	-	G(GK)-AlMg5	A-U4NT	
		AC7A	-	AC7A	514.0	LM-5	-	-	
		AC8A	-	AC8A	-	LM-13	-	-	
		AC8B	-	AC8B	-	LM-13	-	A-S12UNG	
		AC8C	-	AC8C	-	LM-26	-	A-S10UG	
		AC9A	-	AC9A	-	-	-	A-S10UG	
	AC9B	-	AC9B	-	LM-29	-	-		
	Aluminum alloy die casting	ALDC1	Al-Si12CuFe	ADC1	A413.0	LM20	GD-AlSi10Mg	A-S13	
		ALDC2	-	ADC3	A360.0	-	GD-AlMg9	A-S9G	
		ALDC3	-	ADC5	518.0	-	-	A-G6	
		ALDC4	-	ADC6	-	-	GD-AlSi9Cu3	A-G3T	
		ALDC7	Al-Si8Cu3Fe	ADC10	A380.0	-	GD-AlSi9Cu3	-	
		ALDC7Z	Al-Si8Cu3Fe	ADC10Z	A380.0	LM24	-	-	
		ALDC8	-	ADC12	383.0	LM2	-	-	
		ALDC8Z	-	ADC12Z	383.0	LM2	-	-	
		ALDC9	-	ADC14	B390.0	LM30	EN AW-5052	-	
	Aluminum alloy extruded shapes	A5052S	-	A5052S	5052	EN AW-5052	EN AW-5454	EN AW-5052	
		A5454S	-	A5454S	5454	EN AW-5454	EN AW-5083	EN AW-5454	
		A5083S	AlMg4.5Mn0.7	A5083S	5083	EN AW-5083	EN AW-5086	EN AW-5083	
		A5086S	-	A5086S	5086	EN AW-5086	EN AW-6061	EN AW-5086	
		A6061S	AlMg1SiCu	A6061S	6061	EN AW-6061	EN AW-6063	EN AW-6061	
		A6063S	AlMg0.7Si	A6063S	6063	EN AW-6063	EN AW-7003	EN AW-6063	
		A7003S	-	A7003S	-	EN AW-7003	-	EN AW-7003	
		A7N01S	-	A7N01S	-	-	EN AW-7075	-	
A7075S		AlZn5.5MgCu	A7075S	7075	EN AW-7075	-	EN AW-7075		

➤ Heat resistant steel

Type		Korea	ISO	Japan	U.S.A		Great Britain	Germany	France	Russia
		KS	ISO	JIS	UNS	AISI SAE	BS BS/EN	DIN DIN/EN	NF NF/EN	GOCT
Heat resistant steel	Austenitic	STR31		SUH31			331S42	X53CrMnNi21-9	Z35CNWS14-14 Z52CMN21-09-Az Z55CMN21-09-Az	
		STR35		SUH35			349S52			
		STR36		SUH36			349S54			
		STR37		SUH37			381S34			
		STR38		SUH38						
		STR309		SUH309			309S24			
		STR310		SUH310			310S24			
		STR330		SUH330			S31000			
		STR660		SUH660			N08330			
		STR661		SUH661			S66286			
		STR661		SUH661			S66286			
		STR21		SUH21			R30155			
	STR409	SUH409								
	STR409L	SUH409L	S40900							
	STR446	SUH446								
	Martensitic	STR1	SUH1	S44600	446	401S45		X45CrSi9-3	Z45CS9 Z40CSD10 Z80CSN20-02	
		STR3	SUH3	S65007		443S65				
		STR4	SUH4							
STR11		SUH11								
STR600		SUH600								
STR616		SUH616	S42200							

• The above Heat resistant steel can supplied by domestic manufacturing

Steel, Non-ferrous metal symbol list

Comparison of workpiece material standards

Group	Standard term	Code	Group	Standard term	Code	
Structural Steel	Rolled Steel for Welded Structure	SWS	Forged steel	Carbon Steel Forging	SF	
	Rerolled Steel	SBR		Chromium Molybdenum Steel Forging	SFCM	
	Rolled Steel for General Structure	SB		Nickel Chromium Molybdenum Steel Forging	SFNCM	
	Light Gauge Steel for General Structure	SBC	Cast iron	Gray Cast iron	GC	
	Hot-rolled Steel Plate, Sheet/ Strip for Automobile Structural Use	SAPH		Spheroidal Graphite Cast iron	GCD	
Steel Plate	Cold-rolled Steel Sheet/Strip	SBC		Blackheart Malleable Cast iron	BMC	
	Hot-rolled Soft Steel Sheet/Strip	SHP		Whiteheat Malleable Cast iron	WMC	
Steel Pipe	Carbon Steel Pipe for Ordinary Piping	SPP	Pearlitic Malleable Cast iron	PMC		
	Carbon Steel Pipe for Boiler and Heat Exchanger	STH	Cast steel	Carbon Cast Steel	SC	
	Seamless Steel Pipe for High Pressure Gas Cylinder	STHG		High Tensile Strength Carbon Cast Steel & Low Alloy Cast Steel	HSC	
	Carbon Steel Pipe for General Structural Use	SPS		Stainless Cast Steel	SSC	
	Carbon Steel Pipe for Machine Structural Use	STST		Heat Resisting Cast Steel	HRSC	
	Alloy Steel Pipe for Structural Use	STA		High Manganese Cast Steel	HMnSC	
	Stainless Steel Pipe for Machine and Structural Use	STS-TK		Cast Steel for High Temperature and High Pressure Service	SCPH	
	Carbon Steel Square Pipe for General Structural Use	SPSR		Casting	Brass Casting	BsC
	Alloy Steel Pipe	SPA			High Strength Brass Casting	HBsC
	Carbon Steel Pipe for Pressure Service	SPPS	Bronze Casting		BrC	
	Carbon Steel Pipe for High Temperature Service	SPSR	Phosphoric Bronze Casting		PCB	
	Carbon Steel Pipe for High Pressure Service	SPPH	Aluminum Bronze Casting		AIBC	
	Stainless Steel Pipe	STSxT	Aluminum Alloy Casting		ACxA	
	Iron and Steel	Carbon Steel for Machine Structural Use	SMxxC, SMxxCK		Magnesium Alloy Casting	MgC
Aluminum Chromium Molybdenum Steel		SACM	Zinc Alloy Die Casting		ZnDC	
Chromium Molybdenum Steel		SCM	Aluminum Alloy Die Casting		Al DC	
Chromium Steel		SCr	Magnesium Alloy Die Casting		MgDC	
Nickel Chromium Steel		SNC	White Metal	WM		
Nickel Chromium Molybdenum Steel		SNCM	Aluminum Alloy Casting for Bearing	AM		
Manganese Steel and manganese Chromium Steel for Machine Structural Use		SMn, SMnC	Brass Alloy Casting for Bearing	KM		
Special steel	Tool steel	Carbon Tool Steel	STC			
		Hollow Drill Steel	SKC			
		Alloy Tool Steel	STS, STD, STF			
		High Speed Tool Steel	SKH			
	Stainless steel	Stainless Steel Bar	STS			
		Heat resisting steel	Heat Resisting Steel	STR		
			Heat Resisting Steel Bar	STR		
	Heat Resisting Steel Sheet		STR			
	Free cutting carbon steel	SUM				
	Special steel	STB				
Spring steel	SPS					



SI unit conversion table

Major SI unit conversion table

Force

N	kgf	dyn
1	1.01972×10^{-1}	1×10^{-5}
9.80665	1	9.80665×10^5
1×10^{-5}	1.01972×10^{-6}	1

Stress

Pa or N/m ²	MPa or N/mm ²	kgf/mm ²	kgf/cm ²	kgf/m ²
1	1×10^{-6}	1.01972×10^{-7}	1.01972×10^{-5}	1.01972×10^{-1}
1×10^6	1	1.01972×10^{-1}	1.01972×10	1.01972×10^5
9.80665×10^6	9.80665	1	1×10^2	1×10^6
9.80665×10^4	9.80665×10^{-2}	1×10^{-2}	1	1×10^4
9.80665	9.80665×10^{-6}	1×10^{-6}	1×10^{-4}	1

Pressure

Pa	kPa	MPa	bar	kgf/cm ²
1	1×10^{-3}	1×10^{-6}	1×10^{-5}	1.01972×10^{-5}
1×10^3	1	1×10^{-3}	1×10^{-2}	1.01972×10^{-2}
1×10^6	1×10^3	1	1×10	1.01972×10
1×10^5	1×10^2	1×10^{-1}	1	1.01972
9.80665×10^4	9.80665×10	9.80665×10^{-2}	9.80665×10^{-1}	1

Work, Energy, Calorie

J	kW·h	kgf·m	kcal
1	2.77778×10^{-7}	1.01972×10^{-1}	2.38889×10^{-4}
3.60000×10^6	1	3.67098×10^5	8.60000×10^2
9.80665	2.72407×10^{-6}	1	2.34270×10^{-3}
4.18605×10^3	1.16279×10^{-3}	4.26858×10^2	1

Power

W	kW	kgf·m/s	PS	kcal/h
1	1×10^{-3}	1.01972×10^{-1}	1.35962×10^{-3}	0.860
1×10^3	1	1.01972×10^2	1.359 62	8.60000×10^2
9.81 65	9.80665×10^{-3}	1	1.33333×10^{-2}	8.433 71
7.355×10^2	7.355×10^{-1}	7.5×10	1	6.32529×10^2
1.16279	1.16279×10^{-3}	1.18572×10^{-1}	1.58095×10^{-3}	1

Specific heat

J/(kg·K)	kcal/(kg·°C) cal/(g·°C)
1	2.38889×10^{-4}
4.18605×10^3	1

Thermal conductivity

W/(m·K)	kcal/(h·m·°C)
1	8.6000×10^{-1}
1.16279	1

Revolution per minute

min ⁻¹	s ⁻¹	r.p.m.
1	0.0167	1
60	1	60

Hardness calculating table

Work piece hardness calculating table

Vickers 50kgf HV	Brinell 3000kgf HB		Rockwell				Shore HS	Tensile strength (approximate value) MPa (t)
	Standard ball 10mm	Cemented carbide ball 10mm	A scale 60kgf Diamond particle HRA	B scale 100kgf 1/16in ball HRB	C scale 150kgf Diamond particle HRC	D scale 100kgf Diamond particle HRD		
940	-	-	85.6	-	68.0	76.9	97	
920	-	-	85.3	-	67.5	76.5	96	
900	-	-	85.0	-	67.0	76.1	95	
880	-	(767)	84.7	-	66.4	75.7	93	
860	-	(757)	84.4	-	65.9	75.3	92	
840	-	(745)	84.1	-	65.3	74.8	91	
820	-	(733)	83.8	-	64.7	74.3	90	
800	-	(722)	83.4	-	64.0	74.8	88	
780	-	(710)	83.0	-	63.3	73.3	87	
760	-	(698)	82.6	-	62.5	72.6	86	
740	-	(684)	82.2	-	61.8	72.1	84	
720	-	(670)	81.8	-	61.0	71.5	83	
700	-	(656)	81.3	-	60.1	70.8	81	
690	-	(647)	81.1	-	59.7	70.5	-	
680	-	(638)	80.8	-	59.2	70.1	80	
670	-	630	80.6	-	58.8	69.8	-	
660	-	620	80.3	-	58.3	69.4	79	
650	-	611	80.0	-	57.8	69.0	-	
640	-	601	79.8	-	57.3	68.7	77	
630	-	591	79.5	-	56.8	68.3	-	
620	-	582	79.2	-	56.3	67.9	75	
610	-	573	78.9	-	55.7	67.5	-	
600	-	564	78.6	-	55.2	67.0	74	
590	-	554	78.4	-	54.7	66.7	-	2055
580	-	545	78.0	-	54.1	66.2	72	2020
570	-	535	77.8	-	53.6	65.8	-	1985
560	-	525	77.4	-	53.0	65.4	71	1950
550	(505)	517	77.0	-	52.3	64.8	-	1905
540	(496)	507	76.7	-	51.7	64.4	69	1860
530	(488)	497	76.4	-	51.1	63.9	-	1825
520	(480)	488	76.1	-	50.5	63.5	67	1795
510	(473)	479	75.7	-	49.8	62.9	-	1750
500	(465)	471	75.3	-	49.1	62.2	66	1705
490	(456)	460	74.9	-	48.4	61.6	-	1660
480	488	452	74.5	-	47.7	61.3	64	1620
470	441	442	74.1	-	46.9	60.7	-	1570
460	433	433	73.6	-	46.1	60.1	62	1530
450	425	425	73.3	-	45.3	59.4	-	1495
440	415	415	72.8	-	44.5	58.8	59	1460
430	405	405	72.3	-	43.6	58.2	-	1410
420	397	397	71.8	-	42.7	57.5	57	1370
410	388	388	71.4	-	41.8	56.8	-	1330
100	379	379	70.8	-	40.8	56.0	55	1290
390	369	369	70.3	-	39.8	55.2	-	1240
380	360	360	69.8	(100.0)	38.8	54.4	52	1205
370	350	350	69.2	-	39.9	53.6	-	1170
360	341	341	68.7	(109.0)	36.6	52.8	50	1130
350	331	331	68.1	-	35.5	51.9	-	1095
340	322	322	67.6	(108.0)	34.4	51.1	47	1070
330	313	313	67.0	-	33.3	50.2	-	1035

Vickers 50kgf HV	Brinell 3000kgf HB		Rockwell				Shore HS	Tensile strength (approximate value) MPa (t)
	Standard ball 10mm	Cemented carbide ball 10mm	A scale 60kgf Diamond particle HRA	B scale 100kgf 1/16in ball HRB	C scale 150kgf Diamond particle HRC	D scale 100kgf Diamond particle HRD		
320	303	303	66.4	(107.0)	32.2	49.4	45	1005
310	294	294	65.8	-	31.0	48.4	-	980
300	284	284	65.2	(105.5)	29.8	47.5	42	950
295	280	280	64.8	-	29.2	47.1	-	935
290	275	275	64.5	(104.5)	28.5	46.5	41	915
285	270	270	64.2	-	27.8	46.0	-	905
280	265	265	63.8	(103.5)	27.1	45.3	40	890
275	261	261	63.5	-	26.4	44.9	-	875
270	256	256	63.1	(102.0)	25.6	44.3	38	855
265	252	252	62.7	-	24.8	43.7	-	840
260	247	247	62.4	(101.0)	24.0	43.1	37	825
255	243	243	62.0	-	23.1	42.2	-	805
250	238	238	61.6	99.5	22.2	41.7	36	795
245	233	233	61.2	-	21.3	41.1	-	780
240	228	228	60.7	98.1	20.3	40.3	34	765
230	219	219	-	96.7	(18.0)	-	33	730
220	209	209	-	95.0	(15.7)	-	32	695
210	200	200	-	93.4	(13.4)	-	30	670
200	190	190	-	91.5	(11.0)	-	29	635
190	181	181	-	89.5	(8.5)	-	28	605
180	171	171	-	87.1	(6.0)	-	26	580
170	162	162	-	85.0	(3.0)	-	25	545
160	152	152	-	81.7	(0.0)	-	24	515
150	143	143	-	78.7	-	-	22	490
140	133	133	-	75.0	-	-	21	455
130	124	124	-	71.2	-	-	20	425
120	114	114	-	66.7	-	-	-	390
110	105	105	-	62.3	-	-	-	-
100	95	95	-	56.2	-	-	-	-
95	90	90	-	52.0	-	-	-	-
90	86	86	-	48.0	-	-	-	-
85	81	81	-	41.0	-	-	-	-

Note) 1. 1MPa = 1N/mm²

2. The number in the blank is not generally used ranges



Properties of KORLOY grades

Physical properties of KORLOY grades

Application	ISO Classification symbol	KORLOY grades	Specific gravity (g/cm ³)	Hardness (HRA)	TRS (kgf/mm ²)	Compressive strength (kg/mm ²)	Young's modulus (10 ³ kgf/mm ²)	Thermal expansion coefficient (10 ⁻⁶ /°C)	Thermal conductivity (cal/cmsec°C)	
Grades for cutting tools	P	P01	ST05	10.6	92.7	140	440	-	-	-
		P10	ST10	10.0	92.1	175	460	48	6.2	25
		P20	ST20	11.8	91.9	200	480	56	5.2	42
		P30	ST30A	12.2	91.3	230	500	53	5.2	-
	M	M10	U10	12.9	92.4	170	500	47	-	-
		M20	U20	13.1	91.1	210	500	-	-	88
		M30	ST30A	12.2	91.3	230	500	53	5.2	-
		M40	U40	13.3	89.2	270	440	-	-	-
	K	K01	H02	14.8	93.2	185	-	61	4.4	105
		K10	H01	13.0	92.9	210	570	66	4.7	109
K20		G10	14.7	90.9	250	500	63	-	105	
Ultra fine grain alloy	Z	Z10	FA1	14.1	91.4	290	-	58	5.7	-
		Z20	FCC	12.5	91.3	235	-	-	-	-
Grade for tungsten carbide wear parts	V	V1	D1	15.0	92.3	205	520	-	-	-
		V2	D2	14.8	90.9	250	150	-	-	-
		V3	D3	14.6	89.7	310	410	-	-	-
		V4	G5	14.3	89.0	320	380	-	-	-
		V5	G6	14.0	87.7	350	330	-	-	-
Grade for mining and civil engineering tools	E	E1	GR10	14.8	90.9	220	-	-	-	-
		E2	GR20	14.8	90.3	240	-	-	-	-
		E3	GR30	14.8	89.0	270	-	-	-	-
		E4	GR35	14.8	88.2	270	-	-	-	-
		E5	GR50	14.5	87.0	300	-	-	-	-

The physical properties of element

Element	Specific gravity (g/cm ³)	Hardness (HB)	Young's modulus (x10 ³ kgf/mm ²)	Thermal conductivity (cal/cmsec°C)	Thermal expansion coefficient (x10 ⁻⁶ /°C)	Melting point (°C)
WC	15.6	2,150	70	0.3	5.1	2,900
TiC	4.94	3,200	45	0.04	7.6	3,200
TaC	14.5	1,800	29	0.05	6.6	3,800
NbC	8.2	2,050	35	0.04	6.8	3,500
TiN	5.43	2,000	26	0.07	9.2	2,950
Al ₂ O ₃	3.98	3,000	42	0.07	8.5	2,050
cBN	3.48	4,500	71	3.1	4.7	-
Diamond	3.52	9,000	99	5.0	3.1	-
Co	8.9	-	10~18	0.165	12.3	1,495
Ni	8.9	-	20	0.22	13.3	1,455

L Turning

➤ Insert shape and terminology

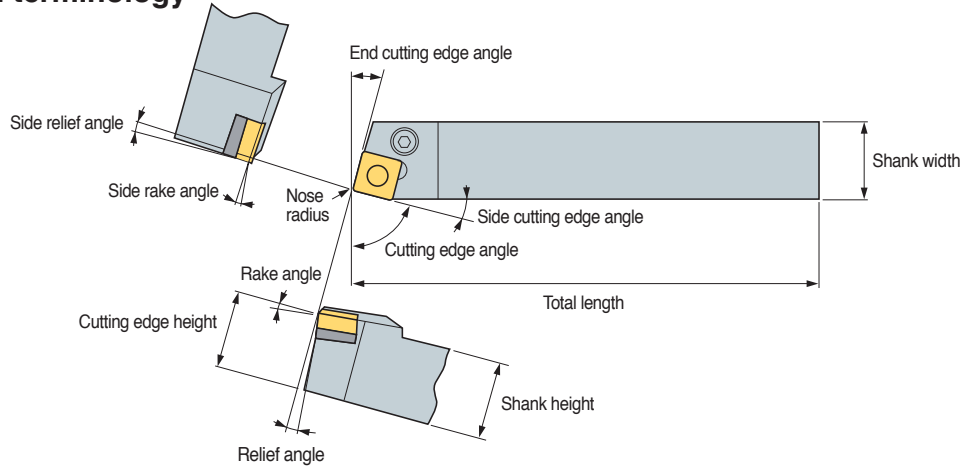

● Relating angles between tool and workpiece

Cutting edge inclination	Terminology	Function	Effect
Rake angle	Side rake angle Rake angle	• Cutting force, Cutting heat, The effects of chip control on tool life	<ul style="list-style-type: none"> • (+): Excellent machine-ability(reducing cutting force, weakening cutting edge strength) • (+): When machining excellent machine-ability or thin workpiece • (-): When strong cutting edge is needed at interrupted condition or mill scale
Relief angle	Relief angle Side relief angle	• Only cutting edge contact with cutting face	• (-): Cutting edge is strong but has short tool life to make bad influence on flank wear
Cutting edge angle	Cutting edge angle	• Affects chip control and cutting force direction	• (+): Improved chip control because chip thickness is big
	Side cutting edge angle	• Affects chip control and cutting force direction	<ul style="list-style-type: none"> • (+): Strong cutting edge due to distributed cutting force but chip control is bad by thin chip thickness • (-): Improved chip performance
	End cutting edge angle	• Prevent friction between cutting edge and cutting face	• (-): Cutting edge is strong but has short tool life to make bad influence on flank wear

➤ Calculation formulas for machining

● Cutting speed

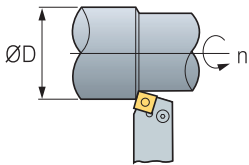

$$vc = \frac{\pi \times D \times n}{1000} \text{ (m/min)}$$

- vc: Cutting speed (m/min)
- D: Diameter (mm)
- n: Revolution per minute (min⁻¹)
- π: Circular constant (3.14)

● Feed

$$fn = \frac{vf}{n} \text{ (mm/rev)}$$

- fn: Feed per revolution (mm/rev)
- vf: Table feed (mm/min)
- n: Revolution per minute (min⁻¹)

● Surface finish

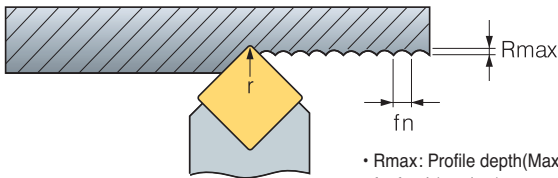

- Rmax: Profile depth(Maximum height roughness) (μ)
- fn: feed (mm/rev)
- r: nose radius

• Theoretical surface roughness

$$R_{max} = \frac{fn^2}{8r} 1000 (\mu\text{m})$$

• Practical surface roughness

- Steel: $R_{max} \times (1.5\sim3)$
- Cast iron: $R_{max} \times (3\sim5)$

● Power requirement

$$P_{kw} = \frac{Q \times kc}{60 \times 102 \times \eta}$$

$$P_{HP} = \frac{P_{kw}}{0.75}$$

$$Q = \frac{vc \times fn \times ap}{1000}$$

- P_{kw}: Power requirement [kW]
- P_{HP}: Power requirement (horse power) [HP]
- vc: Cutting speed [m/min]
- ap: Depth of cut [mm]
- fn: Feed per revolution [mm/rev]
- kc: Specific cutting resistance [kg/mm²]
- η: Machine efficiency rate (0.7~0.8)

Rough Kc

Mild steel	190
Medium carbon steel	210
High carbon steel	240
Low alloy steel	190
High alloy steel	245
Cast iron	93
Malleable cast iron	120
Bronze, Brass	70

● Material removal rate

$$Q \text{ (cm}^3\text{/min)} = vc \times ap \times fn$$

- Q: Material removal rate [cm³/min]
- ap: Depth of cut [mm]
- vc: Cutting speed [m/min]
- fn: Feed per revolution [mm/rev]



● Machining time

External face machining 1

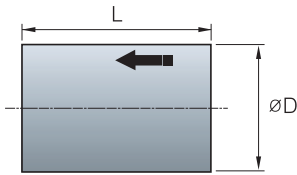

Constant revolution per minute

$$T = \frac{60 \times L}{fn \times n}$$

Constant cutting speed

$$T = \frac{60 \times \pi \times L \times D}{1000 \times fn \times vc}$$

T: Machining time [sec]
L: Cutting length [mm]
fn: Feed per revolution [mm/rev]
n: Revolution per minute [min⁻¹]
D: Diameter of workpiece [mm]
vc: Cutting speed [m/min]

External face machining 2

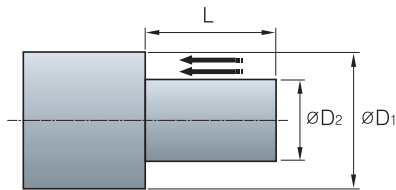

Constant revolution per minute

$$T = \frac{60 \times L}{fn \times n} \times N$$

Constant cutting speed

$$T = \frac{60 \times \pi \times L \times (D_1 + D_2)}{2 \times 1000 \times fn \times vc} \times N$$

T: Machining time [sec]
L: Cutting length [mm]
fn: Feed per revolution [mm/rev]
n: Revolution per minute [min⁻¹]
D1: Maximum diameter of workpiece [mm]
D2: Minimum diameter of workpiece [mm]
vc: Cutting speed [m/min]
N: The number of pass = (D1-D2)/d/2

Facing

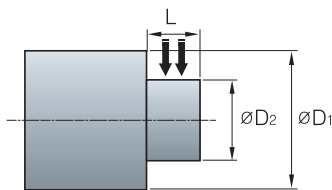

Constant revolution per minute

$$T = \frac{60 \times (D_1 - D_2)}{2 \times fn \times n} \times N$$

Constant cutting speed

$$T_1 = \frac{60 \times \pi \times (D_1 + D_2) \times (D_1 - D_2)}{4000 \times fn \times vc} \times N$$

T: Machining time [sec]
T1: Machining time before the maximum rpm[sec]
L: Width of machining [mm]
fn: Feed per revolution [mm/rev]
n: Revolution per minute [min⁻¹]
D1: Maximum diameter of workpiece [mm]
D2: Minimum diameter of workpiece [mm]
vc: Cutting speed [m/min]
N: The number of pass = (D1-D2)/d/2

Grooving

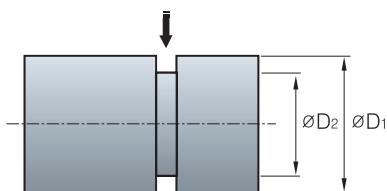

Constant revolution per minute

$$T = \frac{60 \times (D_1 - D_2)}{2 \times fn \times n}$$

Constant cutting speed

$$T_1 = \frac{60 \times \pi \times (D_1 + D_2) \times (D_1 - D_2)}{4000 \times fn \times vc}$$

T: Machining time [sec]
T1: Machining time before the maximum rpm[sec]
L: Width of machining [mm]
fn: Feed per revolution [mm/rev]
n: Revolution per minute [min⁻¹]
D1: Maximum diameter of workpiece [mm]
D2: Minimum diameter of workpiece [mm]
vc: Cutting speed [m/min]

Parting

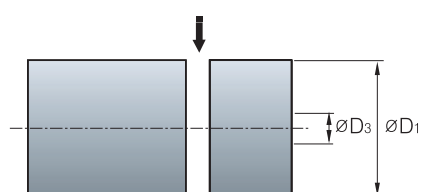

Constant revolution per minute

$$T = \frac{60 \times D_1}{2 \times fn \times n}$$

Constant cutting speed

$$T_1 = \frac{60 \times \pi \times (D_1 + D_3) \times (D_1 - D_3)}{4000 \times fn \times vc}$$

$$T_3 = T_1 + \frac{60 \times D_3}{2 \times fn \times n_{max}}$$

T: Machining time [sec]
T1: Machining time before the maximum rpm[sec]
T3: Machining time till maximum RPM[sec]
fn: Feed per revolution [mm/rev]
n: Revolution per minute [min⁻¹]
nmax: Maximum revolution per minute [min⁻¹]
D1: Maximum diameter of workpiece [mm]
D3: Maximum diameter at maximum RPM [mm]
vc: Cutting speed [m/min]

L Turning

➤ The affects of cutting condition

- The most desirable machining means short machining time, long tool life and good precision
This is the reason that proper cutting condition for each tools should be selected according to material's properties, hardness, shapes, the efficiency of machine

➤ Cutting speed

- **Workpiece:** S45C (180HB)
- **Tool life criterion:** VB = 0.2 mm
- **Depth of cut:** 1.5 mm
- **Feed:** 0.3 mm/rev
- **Holder:** PCLNR2525-M12
- **Insert:** CNMG120408, Dry cutting

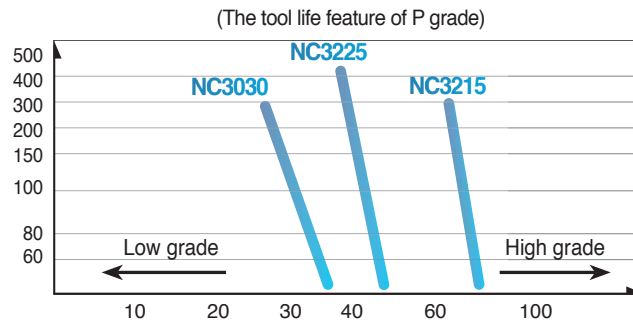

- **Workpiece:** STS304 (200HB)
- **Tool life criterion:** VB = 0.2 mm
- **Depth of cut:** 1.5 mm
- **Feed:** 0.3 mm/rev
- **Holder:** PCLNR2525-M12
- **Insert:** CNMG120408, Dry cutting

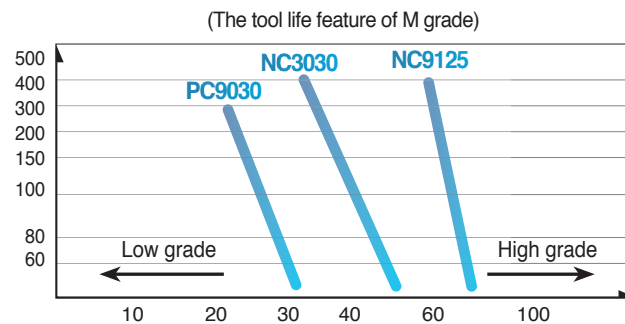

- **Workpiece:** GC300 (180HB)
- **Tool life criterion:** VB = 0.2 mm
- **Depth of cut:** 1.5 mm
- **Feed:** 0.3 mm/rev
- **Holder:** PCLNR2525-M12
- **Insert:** CNMG120408, Dry cutting

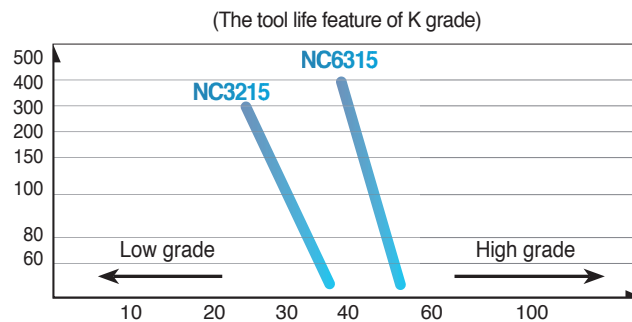

➤ Cutting Speed's effects

- When the cutting speed increases up to 20% in an application, the tool life respectively decreases down 50%
Although inversely, if the cutting speed increases up to 50% the tool life decreases 20%. On the other hand if cutting speed is too low (20-40m/min) Tool life shortens due to vibration



➤ Feed

- The feed rate in turning means the progressed interval of a distance in a work piece within 1 revolution
The feed rate in a milling application means the table feed divided by number of teeth of cutter (feed rate per tooth)

➤ The effects of feed

- When the feed rate decreases the flank wear is increased. When the feed rate is too low, the tool life shortens radically
- When the feed rate increases, the flank wear increases due to high temperatures, however the feed rates effects tool life less than the cutting speed. And higher feed rates improve machining efficiency

(Relationship between feed and flank wear in steel turning)

- **Workpiece:** SNCN431
- **Grade:** ST20
- **Cutting speed:** 200 m/min
- **Depth of cut:** 1.0 mm
- **Cutting time:** 10 min

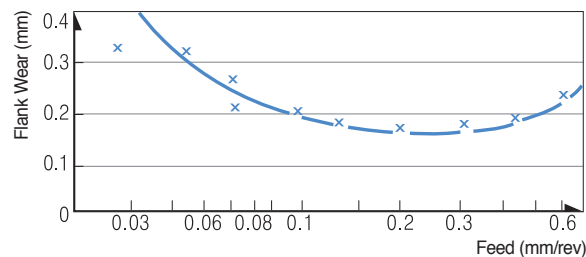

➤ Depth of cut

- Determined by the required allowances in machining a material and the capacity the machine can tolerate
There are cutting limits according to the different shapes and sizes of the insert

(Relationship between depth of cut and flank wear in steel turning)

- **Workpiece:** SNCN431
- **Grade:** ST20
- **Cutting speed:** 200 m/min
- **Feed:** 0.2 mm/rev
- **Cutting time:** 10 min

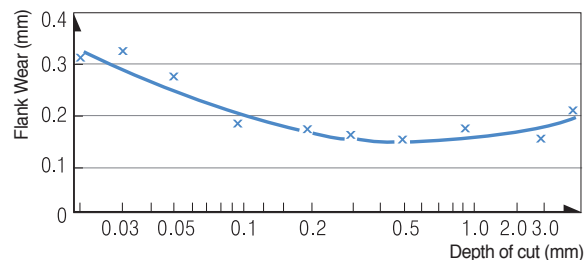

➤ The effect of a depth of cut

- The depth of cut does not have a big influence on tool life
- When the depth of cut is small the work piece is not cut but rather rubbed. In these cases, machine off the work hardened parts that decrease tool life
- When machining a cast skin or milling scale smaller depth of cuts usually cause chipping and abnormal wear because of hard impurities in the surface of the work piece

(Surface parts including mill scale Roughing)

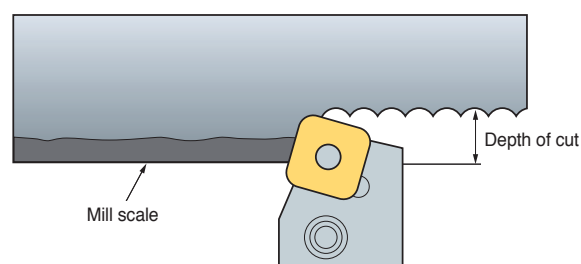

Turning

Relief angle

- Relief angle avoids the friction between workpiece and relief face and makes cutting edge move along workpiece easily

Relationship between various relief angle and flank wear

Affects

- If relief angle is big Flank wear decreases
- If relief angle is big Cutting edge strength weakens
- If relief angle is small Chattering occurs

Selection system

- Hard workpiece/When strong cutting edge is needed
 - Low relief angle
- Soft workpiece/Workpiece turning to work hardening easily
 - High relief angle

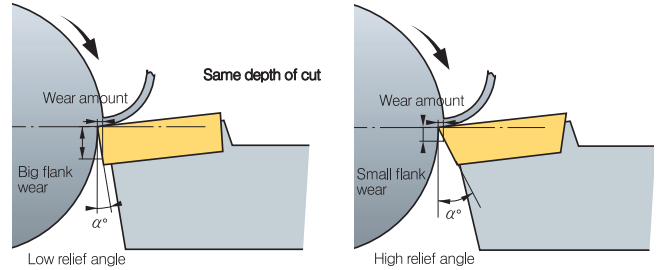

- Workpiece: SNCM431 (HB)
- Grade: P20
- Depth of cut: 1 mm
- Feed: 0.32 mm/rev
- Cutting time: 20 min

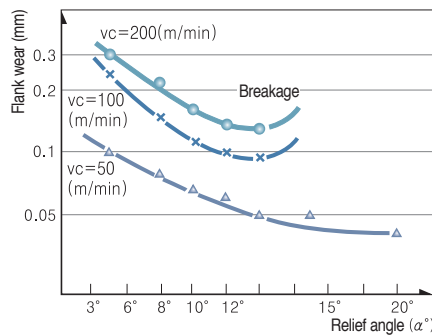

Side cutting edge angle

- Side cutting edge angle has big influence on chip flow and cutting force therefore proper Side cutting edge angle is very important

Side cutting edge angle and chip thickness

- As side cutting edge angle is getting bigger chips are getting thinner and wider (refer to left picture)
- At the same feed and depth of cut with approach angle 0° Chip thickness is the same as feed ($t = f_n$) and chip width is equal to depth of cut ($W = a_p$)

$$t_1 = 0.97t, W_1 = 1.04W$$

$$t_2 = 0.87t, W_2 = 1.15W$$

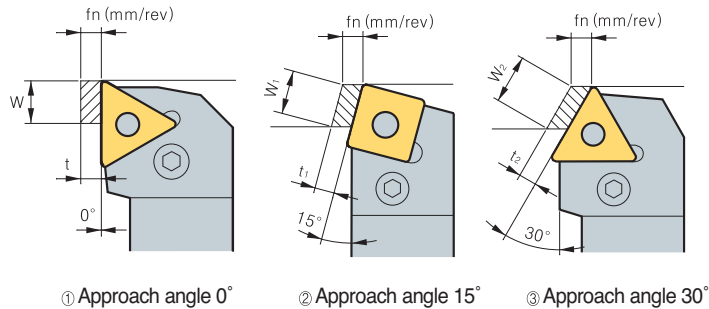

Side cutting edge angle and 3 cutting forces

Affects

- Big side cutting edge angle with the same feed makes chip attaching length longer and chip thickness thinner. So that cutting forces scatter to long cutting edge therefore tool life gets longer
- Big side cutting edge angle for machining long bars can cause bending

Selection system

- Deep depth of cut finishing/Long thin workpiece/Low machine rigidity
 - Side cutting edge angle
- Hard and high calorific power workpiece/Roughing big workpiece/High machine rigidity - Side cutting edge angle

- Workpiece : SCM440 (HB250)
- Grade: TNGA220412
- vc: 100 m/min
- ap: 4 mm
- fn: 0.45 mm/rev

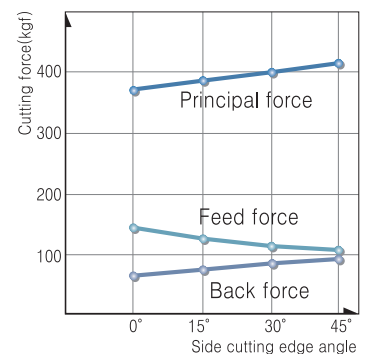

• Side cutting edge angle and cutting load

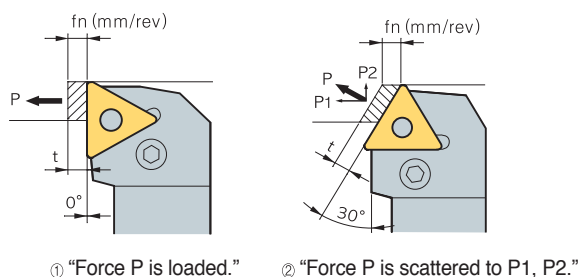

As approach angle gets bigger Back force gets bigger and feed force gets smaller

• Side cutting edge angle and tool life

- Workpiece: SCM440
- Grade: P20
- Depth of cut: 3 mm
- Feed: 0.2 mm/rev

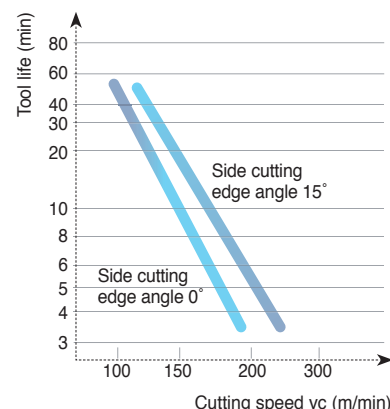

• Side cutting edge angle and cutting performance

Specification	Low	← Approach angle →	High
Wear rate	High		Low
Workpiece	Easy to cut material		Difficult to cut material
Machining power	Small		Big
Chatter	Hard to occur		Easy to occur
How to machine	Finishing		Roughing
Workpiece rigidity	Long thin workpiece		Thick workpiece
Machine rigidity	In case of low rigidity		In case of high rigidity

➤ End cutting edge angle

- It affects machined surface to prevent interference between surface of workpiece and insert

Affects

1. If end cutting edge angle reduces cutting edge get stronger but cutting heat generated by machining increases
2. Small end cutting edge angle can cause chattering due to the increases cutting force

➤ Nose-R

- Nose-R affects not only surface roughness but strength of cutting edge
- In general, It's desirable that Nose-R is 2~3 times bigger than feed

• Nose R and surface finish

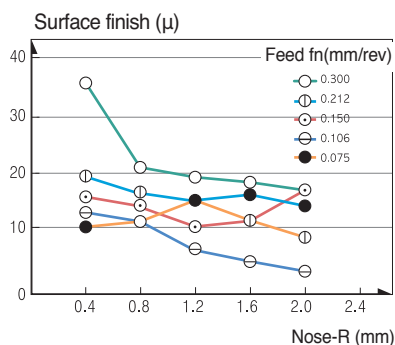

- Workpiece: SNCM439, HB200
- Grade: P20
- v_c : 120 m/min
- ap : 0.5 mm

• Nose R and tool life

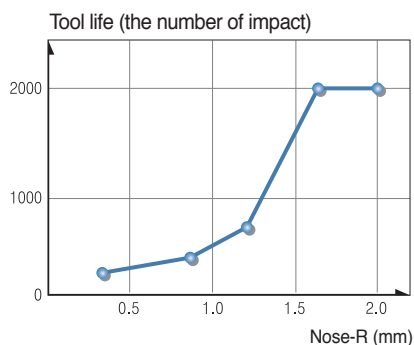

- Workpiece: SCM440, HB280
- Grade: P10
- v_c : 100 m/min, ap : 0.5 mm
- fn : 0.3 mm/rev

• Nose R and wear of tool

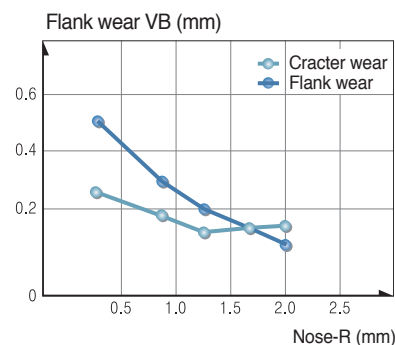

- Workpiece: SNCM439, HB200
- Grade: P10
- v_c : 140 m/min, ap : 2 mm
- fn : 0.2 mm/rev, T : 10 min

Nose-R

Affects

1. Big Nose-R improves surface finish
2. Big Nose-R improves cutting edge strength
3. Big Nose-R reduces flank wear and crater wear
4. Too big Nose-R causes chattering due to increased cutting force

Selection system

1. For finishing with small depth of cut/long and thin workpiece/
When machine power is low - Small Nose-R
2. For applications that need strong cutting edge such as intermittent
and machining mill scale/For roughing of big workpiece/When
the machine power is strong enough - Big Nose-R

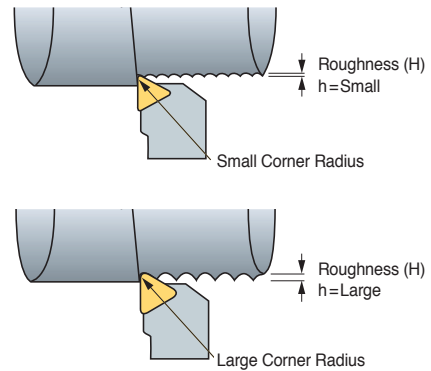

Relationship between nose radius, feed and various surface roughness

Nose R \ Feed (mm/rev)	0.4	0.8	1.2
0.15			
0.26			
0.46			

Cutting edge shape and the affects

Rake angle (α)

Rake angle has big influence on cutting force, chip flow and tool life

Affects

1. High rake angle results in good surface finish
2. As the rake angle increases by 1° Machining power decreases by 1%.
3. High rake angle weakens cutting edge

Selection system

1. For hard workpiece/For applications that need strong cutting edge such as interrupted and machining mill scale - Low rake angle
2. For soft workpiece/Easy to cut material/When the rigidity of machine power and workpiece is low - High rake angle

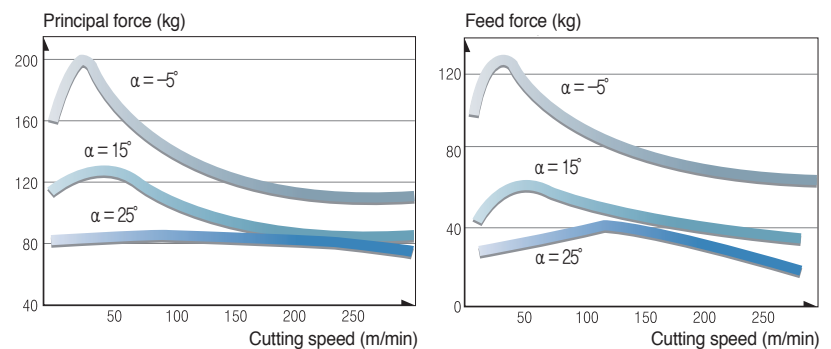

● Rake angle and the direction of chip flow

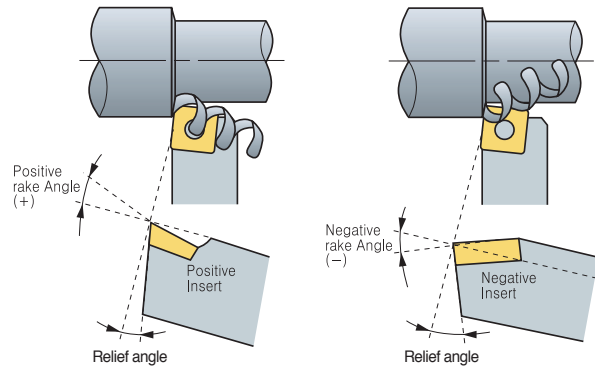
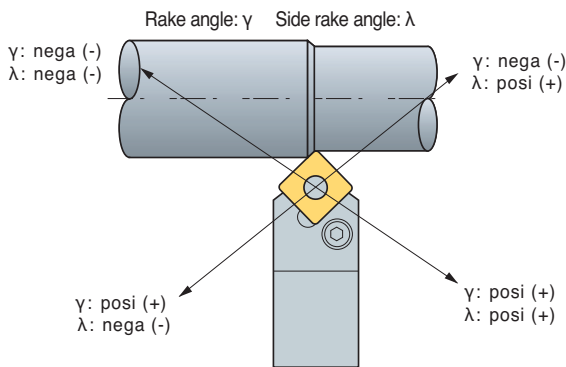

In order to prevent machined surface from damages Avoid nega, posi combination.
 γ : nega (-) λ : posi (+)

➤ Selecting proper tools

- Nowadays, It's very difficult to select the best tools in complicating tooling system and various cutting conditions
- However, It can be simplified by classifying basic factors below

● Selection of inserts and tool holder

Listed below is the basic factors and choose B according to A











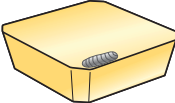

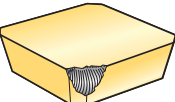
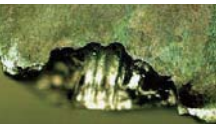

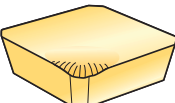
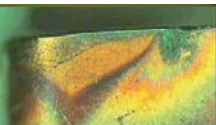
A : Basic factors

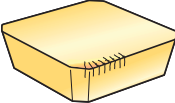
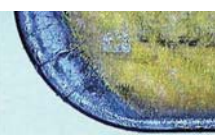
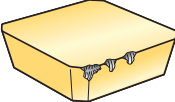
- Workpiece material
- Workpiece shape
- Workpiece size
- Hardness of workpiece
- Surface roughness of workpiece (before machining)
- Surface finish required
- Type of lathe machine
- Condition of lathe machine (rigidity, power etc)
- Horse power of machine
- Clamping method of workpiece

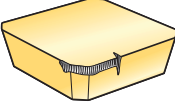
B : Selection system

- ① Select as big approach angle as possible
- ② Select as big shank as possible
- ③ Select as strong cutting edge of insert as possible
- ④ Select as big nose radius as possible
- ⑤ In finishing, Select the insert using many corners
- ⑥ Select as small insert as possible
- ⑦ Cutting speed should be determined carefully according to cutting conditions
- ⑧ Select as deep depth of cut as possible
- ⑨ Select as fast feed as possible
- ⑩ Cutting condition should be determined within chip breaker application ranges

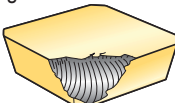
🔧 Trouble shooting

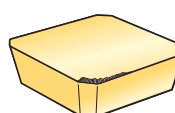
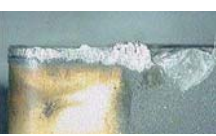
Tool failure			Cause	Solution
Crater wear   			<ul style="list-style-type: none"> • Improper grade • Excessive cutting condition 	<ul style="list-style-type: none"> • Choose harder grade • Decrease cutting condition
Fracture   			<ul style="list-style-type: none"> • Improper grade • Excessive feed • Shorten cutting edge strength • Insufficient rigidity of holder 	<ul style="list-style-type: none"> • Choose tougher grade • Decrease feed • Apply to large honed or chamfered edge • Choose bigger size holder
Plastic deformation   			<ul style="list-style-type: none"> • Improper grade • Excessive cutting condition • High cutting temperature 	<ul style="list-style-type: none"> • Choose harder grade • Decrease cutting condition • Choose grade with heat conductivity are big
Wear on nose radius (Flank wear)  			<ul style="list-style-type: none"> • When the hardness of workpiece is too high compare with tool • When machining surface hardened workpiece • Improper grade • Excessive cutting speed • Too small relief angle • Too low feed 	<ul style="list-style-type: none"> • Choose harder grade • Decrease cutting speed • Choose larger relief angle • Increase feed
Thermal crack  			<ul style="list-style-type: none"> • Expansion and shrinking by cutting temperature • Improper grade (*Specially milling operation) 	<ul style="list-style-type: none"> • Apply to dry cutting (In case of wet cutting, use enough coolant) • Choose tougher grade
Chipping  			<ul style="list-style-type: none"> • Improper grade • Excessive feed • Shorten cutting edge strength • Insufficient rigidity of holder 	<ul style="list-style-type: none"> • Choose tougher grade • Decrease feed • Apply to large honing or chamfer edge • Choose bigger size holder
Notch wear  			<ul style="list-style-type: none"> • Surface hardened workpiece • Friction due to bad chip geometry (Generate vibration) 	<ul style="list-style-type: none"> • Choose harder grade • Improve chip control form large rake angle
Flaking  			<ul style="list-style-type: none"> • Deposition on cutting edge • Bad chip control 	<ul style="list-style-type: none"> • Improve cutting performance from large rake angle • Apply to chip pocket with big size
Complete breakage  			<ul style="list-style-type: none"> • Unusable condition due to wear off the most parts of cutting edge by progress of wear 	<ul style="list-style-type: none"> • Reduce the feed rate. • Reduce the depth of cut. • Select a tougher grade. • Select a stronger chipbreaker. • Select a thicker insert.
Built-up edge   			<ul style="list-style-type: none"> • Slow cutting speed • Sticky materials 	<ul style="list-style-type: none"> • Increase cutting speed. • Use more positive rake geometry. • Use tougher grade

Types of tool failure and trouble shooting

Troubles	Causes	Solution																
		Cutting conditions				Selecting insert grade				Tool shape				Machine clamping				
		Cutting speed	Feed	Depth of cut	Coolant	Select harder grade	Select tougher grade	Select better heat-impact resistance grade	Select better adhesion resistance grade	Chip breaker valuation	Flake angle	Nose radius	Side cutting edge angle	Cutting edge strength Honing	Improving insert precision M class → G class	Improving holder rigidity	Clamping workpiece	Holder overhang
Poor precision Unstable machining size	Insert precision is variable													●				
	Workpiece, Separation of tool								●	↑	↓				●	●	●	●
Cutting edge back thrust is big It's necessary to adjust because machining precision changes during operation.	Flank wear increase					●					↑							
	Cutting condition is improper	↓	↑			●												
Poor surface roughness for finishing Criterion of tool life.	Weakened cutting force by increasing wear of tool	↓			Wet cutting			●	●	↑	↑		↓	●				
	Cutting edge chipping		↓	↓		●			●		↑		↑			●	●	●
	Adhesion, built-up edge	↑	↑		Wet cutting			●	●	↑			↓	●				
	Improper cutting conditions	↑	↓	↓	Wet cutting													
	Improper tool and shape of cutting edge								●		↑		↓	●				
	Vibration, chattering	↓	↓	↓	Wet cutting	●			●	↑	↓		↓		●	●	●	●
Cutting heat generation Poor machining precision and short tool life by cutting heat	Improper cutting conditions	↓	↓	↓		●												
	Improper tool and shape of cutting edge								●	↑			↓					
Burr, chipping, nap steel, aluminum (burr)	Improper cutting conditions	↓	↑		Wet cutting	●												
	Wear on the tool, improper shape of cutting edge							⊙	●	↑	↓		↓					
Cast iron (Weak chipping)	Improper cutting conditions		↓	↓		●												
	Wear on the tool, improper shape of cutting edge								●	↑	↑		↓		●	●	●	●
Soft steel (nap)	Improper cutting conditions	↑	↑		Wet cutting	●												
	Wear on the tool, improper shape of cutting edge							⊙	●	↑			↓					

↑: Increase ↓: Decrease ●: use ⊙: Correct use

Tool life criterion

● KS B0813

Flank wear width	Value	Application
	0.2 mm	Precision light cutting, Finishing in nonferrous alloy
	0.4 mm	Machining special steel
	0.7 mm	General cutting in cast iron, steel etc
	1~1.25 mm	General cutting in cast iron, steel etc
Depth of crater wear	In general 0.05~0.1 mm	

● ISO (B8688)

Tool life criterion	Application
Complete breakage	Machining special steel
Flank wear width VB = 0.3 mm	Even flank wear of cemented carbides, Ceramic tool
VBmax = 0.5 mm	Uneven flank wear
Crater wear width KT = 0.06+0.3fmm (f:mm/rev)	Cemented carbides tool
Criterion by surface roughness 1, 1.6, 2.5, 4, 6.3, 10 μ Ra	When surface roughness is important



➤ Milling cutter shape and designation

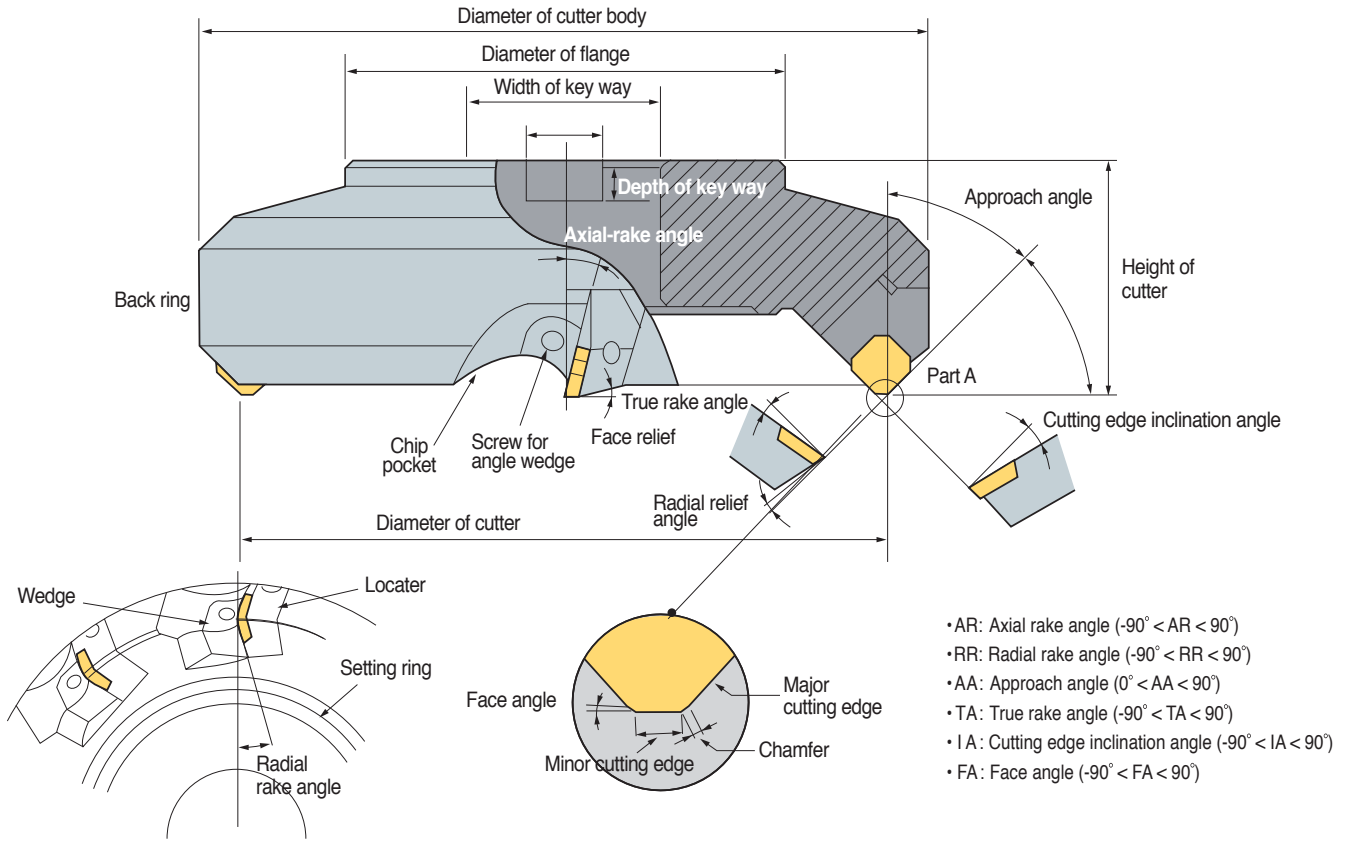

● The terminology and functions of cutting edge angle

No.	Tool failure	Symbol	Function	Effects
1	Axial rake angle	A.R	Chip flow direction, Adhesion	Positive: Excellent cutting, built-up edge prevented
2	Radial rake angle	R.R	Affecting on thrust	Negative: Excellent chip control
3	Approach angle	A.A	Chip thickness, Determines flow direction	(+): Chip thickness become thinner, cutting force could be reduced
4	True rake angle	T.A	Effective rake angle	(+): Better cutting. Preventing adhesion, Weakening cutting edge strength (-): Cutting edge strength increases, easy to adhere
5	Cutting edge inclination angle	I.A	Determines chip flow direction	(+): Good chip flow, cutting force could decrease, Corner edge strength weakens
6	Relief angle	F.A	Controlling cutting edge strength, tool life and chattering	Surface roughness increases as F.A gets close to 0 degree



Features by combination of rake angle

	Double positive angle	Double negative angle	Posi - Negative angle	Nega - Positive angle
Division				
Use	<ul style="list-style-type: none"> • General machining of steel, cast iron, stainless steel • Machining soft steel that brings about built-up edge easily • Machining material having tendency to poor surface roughness 	<ul style="list-style-type: none"> • Under interrupted cutting condition • Roughing of cast iron and steel 	<ul style="list-style-type: none"> • Machining difficult to cut material • Roughing with deep depth of cut and wide width of cut in steel and cast iron 	<ul style="list-style-type: none"> • Chip flows to center of cutter body
Advantages	<ul style="list-style-type: none"> • As for tough workpiece material It prevents built-up edge to improve surface roughness • Low cutting load and better machinability 	<ul style="list-style-type: none"> • Strong cutting edge • Roughing of workpiece that has bad surface condition containing sand, mill scale • Double sided inserts can be applied(Economical) • Good chip control 	<ul style="list-style-type: none"> • Good chip flow and machinability. • Suitable for machining of difficult-to-cut material 	-
Disadvantages	<ul style="list-style-type: none"> • Weak cutting edge strength • Only single sided inserts are available (No economical) • Machine and cutter need enough power and rigidity 	<ul style="list-style-type: none"> • Machine and cutter need enough power and rigidity 	<ul style="list-style-type: none"> • Only single sided inserts are available (No economical) 	<ul style="list-style-type: none"> • Since the chips flows toward the center of cutter. Chips scratch on machined surface • Bad chip flow • No economical

Major cutting formulas

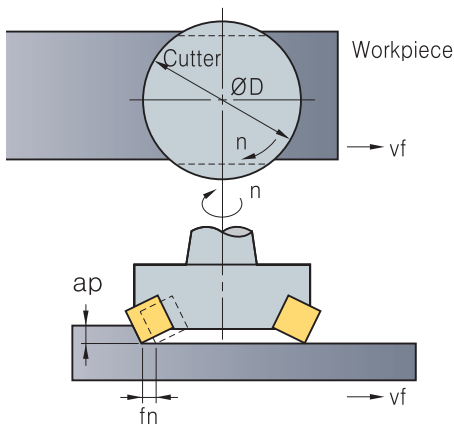

● Cutting speed

$$vc = \frac{\pi \cdot D \cdot n}{1000} \text{ (m/min)}$$

- vc: Cutting speed (m/min)
- D: Diameter of tool (mm)
- n: Revolution per minute (min⁻¹)
- π: Circular constant (3.14)

● Feed

$$fz = \frac{vf}{z \cdot n} \text{ (mm/t)}$$

- fz: Feed per tooth (mm/t)
- vf: Feed per minute (mm/min)
- n: Revolution per minute (min⁻¹)
- z: Number of tooth

● Chip removal amount

$$Q = \frac{L \cdot vf \cdot ap}{1000} \text{ (cm}^3\text{/min)}$$

- Q: Chip removal amount (cm³/min)
- L: Width of cut (mm)
- vf: Table feed (mm/min)
- ap: Depth of cut (mm)

● Power requirement

$$P_{kw} = \frac{Q \cdot kc}{60 \times 102 \cdot \eta} \quad P_{hp} = \frac{P_{kw}}{0.75}$$

- Pc: Power requirement (kW)
- H: Horse power requirement (hp) (mm/min)
- Q: Chip removal amount (cm³/min)
- kc: Specific cutting resistance (kgf/mm²)
- η: Machine efficiency rate (0.7~0.8)

● Machining time

$$T = \frac{60 \times Lt}{vf} \text{ (sec)}$$

- T: Machining time (sec)
- Lt: Total length of table feed (mm) (= Lw+D+2R)
- Lw: The length of workpiece (mm)
- D: The diameter of cutter body (mm)
- vf: Table feed (mm/min)
- R: Relief length (mm)

● True rake angle/Cutting edge inclination angle

True rake angle $\tan(T) = \tan(R) \times \cos(AA) + \tan(A) \times \sin(C)$
 Cutting edge inclination angle $\tan(I) = \tan(A) \times \cos(AA) - \tan(R) \times \sin(C)$



Values of specific cutting resistance

Workpiece	Tensile strength (kg/mm ²) and hardness	Specific cutting resistance according to various feed kc(MPa)				
		0.1 (mm/t)	0.2 (mm/t)	0.3 (mm/t)	0.4 (mm/t)	0.6 (mm/t)
Soft steel	52	220	195	182	170	158
Medium carbon steel	62	198	180	173	160	157
High carbon steel	72	252	220	204	185	174
Tool steel	67	198	180	173	170	160
Tool steel	77	203	180	175	170	158
Chrome manganese steel	77	230	200	188	175	166
Chrome manganese steel	63	275	230	206	180	178
Chrome molybdenum steel	73	254	225	214	200	180
Chrome molybdenum steel	60	218	200	186	180	167
Nickel Chrome molybdenum steel	94	200	180	168	160	150
Nickel Chrome molybdenum steel	HB352	210	190	176	170	153
Cast steel	52	280	250	232	220	204
Hardened cast iron	HnC46	300	270	250	240	220
Meehanite cast iron	36	218	200	175	160	147
Gray cast iron	HB200	175	140	124	105	97
Brass	50	115	95	80	70	63
Light alloy (Al - Mg)	16	58	48	40	35	32
Light alloy (Al - Si)	20	70	60	52	45	39

Chip removal amount (cm³/min) per rated horse power

Workpiece	Rated horse power	Rated horse power					
		5Hp	10Hp	20Hp	30Hp	40Hp	50Hp
Steel	Soft	32	75	163	295	425	570
	Medium	26	55	127	212	310	425
	hard	18	41	93	163	228	310
Cast iron	Soft	52	116	260	455	670	880
	Medium	32	75	163	295	425	570
	hard	26	55	127	212	310	425
Bronze Brass	Soft	77	163	390	670	980	1,280
	Medium	54	118	275	490	700	910
	hard	26	55	127	245	325	425
Aluminum		90	195	440	780	1,110	1,500

Classification of surface roughness

Type	Symbol	How to calculate	Measured value
Maximum height	Rmax	<ul style="list-style-type: none"> The distance between the top of profile peak line and the bottom of profile valley line on this sampled portion is measured in the longitudinal magnification direction of roughness curve (Expressed by unit: μ) Exclude extraordinary values (too small or big) that look like grooves or mountains 	
+10 point mean roughness	Rz	<ul style="list-style-type: none"> Sampled from the roughness curve in the direction of its mean line, the sum of the average value of absolute value of the highest profile peaks and the depths of five deepest profile valleys measured in the vertical magnification is expressed by micro meter (μ) 	
Arithmetic mean roughness	Ra	<ul style="list-style-type: none"> Sampling only the reference length from the roughness curve in the direction of mean line , taking X-axis in the direction of mean line and Y-axis in the direction of longitudinal magnification of this sampled part and is expressed by micro meter (μ) Generally, Read measured value by Ra measurer 	

Finish mark		▽▽▽▽	▽▽▽	▽▽	▽	~
Surface roughness	Rmax	0.8s	6.3s	25s	100s	Unspecified
	Rz	0.8z	6.3z	25z	100z	
	Ra	0.2a	1.6a	6.3a	25a	

Selection of MILL-MAX diameter (D)

Selection by machine rigidity

Machine horse power (PS)	10~15	15~20	Over 20
Proper cutter body specification (mm)	Ø80~Ø100	Ø125~Ø160	Ø160~Ø200

Selection by machine rigidity

Workpiece	E	δ
Steel	+20°~10°	3 : 2
Cast iron	Under +50°	5 : 4
Light alloy	Under +40°	5 : 3

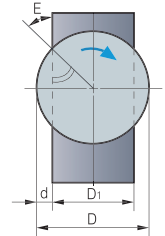

D: External diameter of cutter body
D1: Width of workpiece
d: Projected part of cutter body
E: Engage angle
δ: Ratio of cutter body and width of workpiece (D: D1)

Selection by machining time

The bigger size cutter the longer machining time

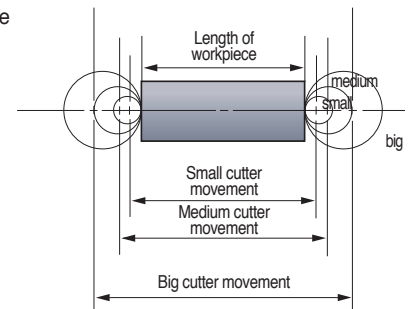

Selection by number of tooth

Workpiece	Steel	Cast iron	Light alloy
Number of tooth	Dx (1~1.5)	Dx (1~4)	Dx1+α

ex) D = ø100 ⇒ 4" x(1~1.5) = 4~6

D is the size of cutter body converted into inch size



🔍 Trouble shooting for milling

Trouble	Causes	Solutions											
		Cutting conditions				Tool shape					Insert grade		
		Cutting speed	Depth of cut	Feed	Coolant	Rake angle	Relief angle	Approach angle	Chattering at cutting edge	Nose radius	Toughness	Hardness	
Flank wear	<ul style="list-style-type: none"> • Improper insert grade • Improper cutting conditions • Chattering 	↓		↑			↑	↓		↑		↑	
Crater wear	<ul style="list-style-type: none"> • Improper cutting conditions • Improper insert grade 	↓	↓	↓	●	↑	↑			↓		↑	
Chipping	<ul style="list-style-type: none"> • Lack of insert toughness • Excessive feed • Excessive cutting load 			↓		↓	↓	↓		↑	↑		
Built-up edge	<ul style="list-style-type: none"> • Improper cutting conditions • Improper cutting edge shape • Improper insert grade 	↑	↓			↑				↓			
Chattering	<ul style="list-style-type: none"> • Improper cutting conditions • Lack of number of cutting teeth • Improper cutting edge shape • Bad chip flow • Unstable workpiece clamping 		↓	↓	●	↑		↑	↓	↓			
Poor surface finish	<ul style="list-style-type: none"> • Built-up edge • Improper cutting conditions • Chattering • Bad chip flow 	↑	↓	↓	●	↑			↓	↑			
Thermal crack	<ul style="list-style-type: none"> • Improper cutting conditions • Improper insert grade 	↓	↓	↓	⊙	↑				↑	↑		
Fracture	<ul style="list-style-type: none"> • Improper insert grade • Excessive cutting load • Bad chip flow • Chattering • Excessive overhang 		↓	↓	●							↑	

↑: Increase ↓: Decrease ●: use ⊙: Correct use

🔍 General formulas for milling

● Machine efficiency rate (η)

Power transmission mode	Efficiency rate (E)	Reference
Principal axis direct connection driving	0.90	
Belt driving	0.85	Double connection: $0.85 \times 0.85 \approx 0.70$
Starting driving	0.75	
Oil pressure driving	0.60~0.90	



L Tapers

(mm)

Morse taper (Tang type)

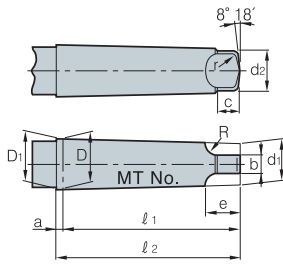

MT No.	Taper	Taper angle (α)	D	a	D ₁	d ₁	ℓ ₁	ℓ ₂	d ₂	b	c	e	R	r
0	$\frac{1}{19.212}$	1°29'27"	9.045	3	9.201	6.104	56.5	59.5	6.0	3.9	6.5	10.5	4	1
1	$\frac{1}{20.047}$	1°25'43"	12.065	3.5	12.240	8.972	62.0	65.5	8.7	5.2	8.5	13.5	5	1.2
2	$\frac{1}{20.020}$	1°25'50"	17.780	5	18.030	14.034	75.0	80.0	13.5	6.3	10	16	6	1.6
3	$\frac{1}{19.922}$	1°26'16"	23.825	5	24.076	19.107	94.0	99.0	18.5	7.9	13	20	7	2
4	$\frac{1}{19.254}$	1°29'15"	31.267	6.5	31.605	25.164	117.5	124.0	24.5	11.9	16	24	8	2.5
5	$\frac{1}{19.002}$	1°30'26"	44.399	6.5	4.741	36.531	149.5	156.0	35.7	15.9	19	29	10	3
6	$\frac{1}{19.180}$	1°29'36"	63.348	8	63.765	52.399	210.0	218.0	51.0	19.0	27	40	13	4
7	$\frac{1}{19.231}$	1°29'22"	83.058	10	83.578	68.186	286.0	296.0	66.8	28.6	35	54	19	5

(mm)

Morse taper (Screw type)

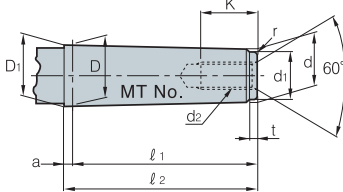

MT No.	Taper	Taper angle (α)	D	a	D ₁	d	ℓ ₁	ℓ ₂	d ₁	d ₂	k	t	r
0	$\frac{1}{19.212}$	1°29'27"	9.045	3	9.201	6.442	50	53	6	-	-	4	0.2
1	$\frac{1}{20.047}$	1°25'43"	12.065	3.5	12.230	9.396	53.5	57	9	M6	16	5	0.2
2	$\frac{1}{20.020}$	1°25'50"	17.780	5	18.030	14.583	64	69	14	M10	24	5	0.2
3	$\frac{1}{19.922}$	1°26'16"	23.825	5	24.076	19.759	81	86	19	M12	28	7	0.6
4	$\frac{1}{19.254}$	1°29'15"	31.267	6.5	31.605	25.943	102.5	109	25	M16	32	9	1
5	$\frac{1}{19.002}$	1°30'26"	44.399	6.5	4.741	37.584	129.5	136	35.7	M20	40	9	2.5
6	$\frac{1}{19.180}$	1°29'36"	63.348	8	63.765	53.859	182	190	51	M24	50	12	4
7	$\frac{1}{19.231}$	1°29'22"	83.058	10	83.578	70.058	250	260	65	M33	80	18.5	5

(mm)

Brown sharp taper (Screw type)

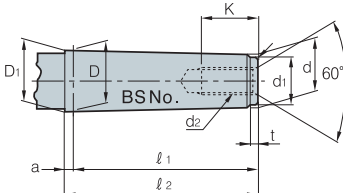

B&S No.	D	a	D ₁	d	d ₁	ℓ ₁	ℓ ₂	t	r	d ₂	K
4	10.221	2.4	10.321	8.890	8.0	31.0	34.2	2	0.2	-	-
5	13.286	2.4	13.386	11.430	10.0	44.4	46.8	3	0.2	-	-
6	15.229	2.4	15.330	12.700	11.0	60.0	62.7	3	0.2	M 8(1/4)	20
7	18.424	2.4	18.524	15.240	14.0	76.2	78.6	4	0.2	M10(3/8)	24
8	22.828	3.2	22.962	19.090	17.0	90.5	93.7	4	0.6	M12(1/2)	28
9	27.104	3.2	27.238	22.863	21.0	101.6	104.8	4	0.6	M12(1/2)	28
10	32.749	3.2	32.887	26.534	24.0	144.5	147.7	5	1.0	M16(5/8)	32
11	38.905	3.2	39.039	31.749	29.0	171.4	174.6	5	1.0	M16(5/8)	32
12	45.641	3.2	45.774	38.103	35.0	181.0	184.2	6	2.5	M20(3/4)	40
13	52.654	3.2	52.787	44.451	41.0	196.8	200.0	6	3.0	M20(3/4)	40
14	59.533	3.2	59.666	50.800	47.0	209.6	212.8	7	4.0	M24(1)	40
15	66.408	3.2	66.541	57.150	53.0	222.2	225.4	7	4.0	M24(1)	50
16	73.292	3.2	73.425	63.500	59.0	35.0	238.2	8	5.0	M30(1 1/8)	60

(mm)

Brown sharp taper (Tang type)

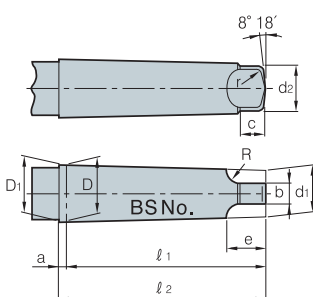

B&S No.	D	a	D ₁	d ₁	d ₂	ℓ ₁	ℓ ₂	b	c	e	R	r
4	10.221	2.4	10.321	8.458	8.1	42.1	44.5	5.5	8.7	14.4	7.9	1.3
5	13.286	2.4	13.386	10.962	10.7	55.6	58.0	6.3	9.5	16.2	7.9	1.5
6	15.229	2.4	15.330	12.167	11.7	73.0	75.4	7.1	11.1	18.0	7.9	1.5
7	18.424	2.4	18.524	14.675	14.2	89.7	92.1	7.9	11.9	20.3	9.5	1.8
8	22.828	3.2	22.962	18.453	18.0	104.8	108.0	8.7	12.7	22.0	9.5	2.0
9	28.104	3.2	27.238	22.200	21.8	117.5	120.7	9.5	14.3	25.4	11.1	2.5
10	32.749	3.2	32.887	25.751	25.7	162.7	165.9	11.1	16.7	28.1	11.1	2.8
11	38.905	3.2	39.039	30.985	30.7	189.7	192.9	11.1	16.7	30.0	12.7	3.3
12	45.641	3.2	45.774	37.246	37.1	201.6	204.8	12.7	19.0	32.5	12.7	3.8
13	52.654	3.2	52.787	43.589	43.4	217.5	220.7	12.7	19.0	35.7	15.9	4.3
14	59.533	3.2	59.666	49.841	49.8	232.6	235.8	14.2	21.4	41.2	19.0	4.8
15	66.408	3.2	66.541	56.186	56.1	245.3	248.5	14.2	21.4	44.4	22.2	5.3
16	73.292	3.2	73.425	62.441	62.2	260.4	263.6	15.8	23.8	50.0	25.4	5.8



(mm)

Standard taper of american milling machine

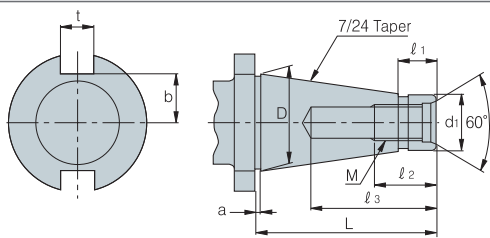

NT No.	Dimensions	D	D ₁	L	l ₁	M	l ₂	l ₃	a	t	b
30	1 ¹ / ₄	31.750	17.40 ^{-0.29} _{-0.36}	70	20	UNC 1/2"	24	50	1.6	15.9	6
40	1 ³ / ₄	44.450	25.32 ^{-0.30} _{-0.384}	95	25	UNC 5/8"	30	60	1.6	15.9	22.5
50	2 ³ / ₄	69.850	39.60 ^{-0.31} _{-0.41}	130	25	UNC 1"	45	90	3.2	25.4	35
60	4 ¹ / ₄	107.950	60.20 ^{-0.34} _{-0.46}	210	45	UNC 1 1/4"	56	110	3.2	25.4	60

Bottle grip taper

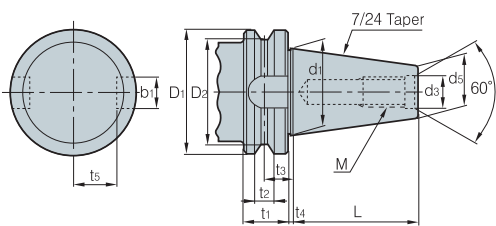

BT No.	D ₁	D ₂	t ₁	t ₂	t ₃	t ₄	d ₁	d ₃	L	M	b ₁	t ₅	d ₅
35	53	43	22	10	14.6	2	38.1	13	56.5	M12×1.75	16.1	19.6	21.62
40	63	52	25	10	16.6	2	44.45	17	65.4	M16×2	16.1	22.6	25.3
45	85	73	30	12	21.2	3	57.15	21	82.8	M20×2.5	19.3	29.1	33.1
50	100	85	35	15	23.2	3	69.85	25	101.8	M24×3	25.7	35.4	40.1
60	155	135	45	20	28.2	3	107.95	31	161.8	M30×3.5	25.7	60.1	60.7

HSK shank (DIN 69893)

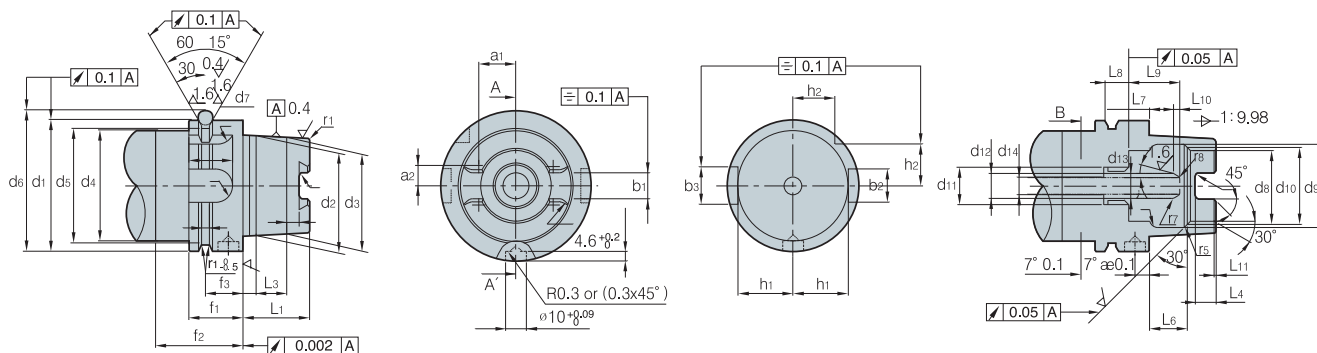

(mm)

HSK No.	b ₁	b ₂	b ₃	d ₁	d ₂	d ₃	d ₄	d ₅	d ₆	d ₇	d ₈	d ₉	d ₁₀	d ₁₁	d ₁₂	d ₁₃	d ₁₄	a ₁	a ₂
50	10.54	12	14	50	38	36.90	42	43	59.3	7	26	32	29	M16X1	10	6.8	6.8	13.997	7.648
63	12.5	16	14	63	48	46.53	53	55	72.3	7	34	40	37	M18X1	12	8	8.4	17.862	9.25
100	20	20	14	100	75	72.80	85	92	109.75	7	53	63	58	M24X1.5	16	12	12	27.329	15.00

(mm)

HSK No.	f ₁	f ₂	f ₃	f ₄	b ₁	b ₂	L ₁	L ₂	L ₃	L ₄	L ₅	L ₆	L ₇	L ₈	L ₉	L ₁₀	L ₁₁	L ₁₂	r ₁	r ₂	r ₃	r ₄	r ₅	r ₆	r ₇	r ₈
50	26	42	18	3.75	2	15.5	25	5	11	7.5	4.5	14.13	10	10	23	3	1	19	1	1.5	2.38	6	0.5	1	2	6
63	26	42	18	3.75	28.5	20	32	6.3	14.7	10	6	18.13	10	12	24.5	3	1	21	1.2	1.5	3	8	0.6	1.5	3	8
100	29	45	20	3.75	44	31.5	50	10	24	15	10	28.56	12.5	16	28	3	1.5	24	2	2	3	12	1	1.5	3	10



L Tapers

(mm)

DIN 69871

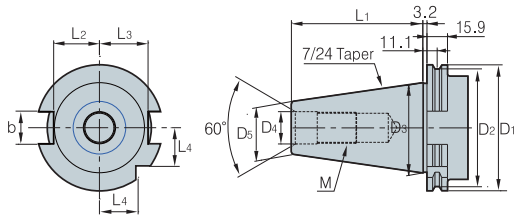

Shank No	D ₁	D ₂	D ₃	D ₄	D ₅	L ₁	L ₂	L ₃	L	b	M
30	50.0	44.3	31.75	13	17.8	47.8	16.4	19.0	33.5	16.0	M12x1.75
40	63.5	56.2	44.45	17	24.5	68.4	22.8	25.0	42.5	16.1	M16x2
45	82.5	57.2	57.15	21	33.0	82.7	29.1	31.3	52.5	19.3	M20x2.5
50	97.5	91.2	68.85	25	40.1	101.7	35.5	37.7	61.5	25.7	M24x3

CAT shank

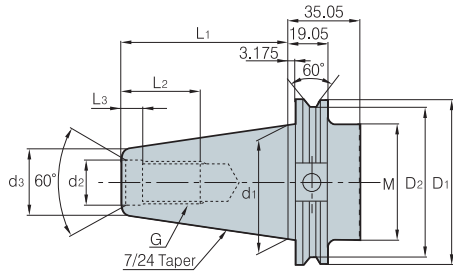

Shank No	D ₁	D ₂	M	d ₁	d ₂	d ₃	L ₁	L ₂	L ₃	G
CAT40	63.5	56.36	M16x2	44.45	16.28	21.84	68.25	28.45	4.78	5/8-11
CAT45	82.55	75.41	M20x2.5	57.15	19.46	27.69	82.55	38.1	4.78	3/4-10
CAT50	98.43	91.29	M24x3	69.85	26.19	35.05	101.6	44.45	6.35	1-8

Standard of milling cutter hole (KSB3203)

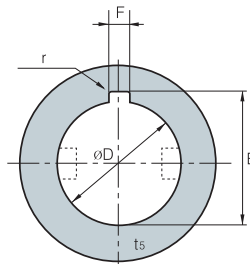

● Type A

Diameter	øDH ₇	E	F	r
8	8 ^{+0.015} ₀	8.9 ^{+0.25} ₀	2 ^{+0.16} _{+0.06}	0.4
10	10 ^{+0.015} ₀	11.5 ^{+0.25} ₀	3 ^{+0.16} _{+0.06}	0.4
13	13 ^{+0.018} ₀	14.6 ^{+0.25} ₀	3 ^{+0.16} _{+0.06}	0.6
16	16 ^{+0.018} ₀	17.7 ^{+0.25} ₀	4 ^{+0.19} _{+0.07}	0.6
19	19 ^{+0.021} ₀	21.1 ^{+0.25} ₀	5 ^{+0.19} _{+0.07}	1
22	22 ^{+0.021} ₀	24.1 ^{+0.25} ₀	6 ^{+0.19} _{+0.07}	1
27	27 ^{+0.021} ₀	29.8 ^{+0.25} ₀	7 ^{+0.23} _{+0.08}	1.2
32	32 ^{+0.025} ₀	34.8 ^{+0.25} ₀	8 ^{+0.23} _{+0.08}	1.2
40	40 ^{+0.025} ₀	43.5 ^{+0.3} ₀	10 ^{+0.23} _{+0.08}	1.2
50	50 ^{+0.025} ₀	53.5 ^{+0.3} ₀	12 ^{+0.23} _{+0.095}	1.6
60	60 ^{+0.030} ₀	64.2 ^{+0.3} ₀	14 ^{+0.275} _{+0.095}	1.6
70	70 ^{+0.030} ₀	75.0 ^{+0.3} ₀	16 ^{+0.275} _{+0.095}	2
80	80 ^{+0.030} ₀	85.5 ^{+0.3} ₀	18 ^{+0.275} _{+0.095}	2
100	100 ^{+0.035} ₀	107.0 ^{+0.3} ₀	24 ^{+0.32} _{+0.11}	2.5

● Type B

Diameter	øDH ₇	E	F	r
1/2	12.70 ^{+0.018} ₀	14.17 ^{+0.25} ₀	2.38 ^{+0.31} _{+0.13}	0.5
5/8	15.875 ^{+0.018} ₀	17.74 ^{+0.25} ₀	3.18 ^{+0.31} _{+0.13}	0.8
3/4	19.050 ^{+0.021} ₀	20.89 ^{+0.25} ₀	3.18 ^{+0.31} _{+0.13}	0.8
7/8	22.225 ^{+0.021} ₀	24.07 ^{+0.25} ₀	3.18 ^{+0.31} _{+0.13}	0.8
1	25.40 ^{+0.021} ₀	28.04 ^{+0.25} ₀	6.35 ^{+0.31} _{+0.13}	1.2
1 1/4	31.750 ^{+0.025} ₀	35.18 ^{+0.25} ₀	7.94 ^{+0.32} _{+0.14}	1.6
1 1/2	38.10 ^{+0.025} ₀	42.32 ^{+0.25} ₀	9.53 ^{+0.89} _{+0.25}	1.6
1 3/4	44.450 ^{+0.025} ₀	49.48 ^{+0.25} ₀	11.11 ^{+0.89} _{+0.25}	1.6
2	50.80 ^{+0.03} ₀	55.83 ^{+0.25} ₀	12.7 ^{+0.89} _{+0.25}	1.6
2 1/2	63.50 ^{+0.03} ₀	69.42 ^{+0.25} ₀	15.81 ^{+0.89} _{+0.25}	1.6
3	76.20 ^{+0.03} ₀	82.93 ^{+0.25} ₀	19.05 ^{+0.89} _{+0.25}	2.4
3 1/2	88.90 ^{+0.035} ₀	98.81 ^{+0.25} ₀	22.23 ^{+0.89} _{+0.25}	2.4
4	101.60 ^{+0.035} ₀	111.51 ^{+0.25} ₀	25.4 ^{+0.89} _{+0.25}	2.4
4 1/2	114.30 ^{+0.035} ₀	125.81 ^{+0.25} ₀	25.58 ^{+0.89} _{+0.25}	3.2
5	127.0 ^{+0.04} ₀	140.08 ^{+0.25} ₀	31.75 ^{+0.89} _{+0.25}	3.2



Endmill's shape and names

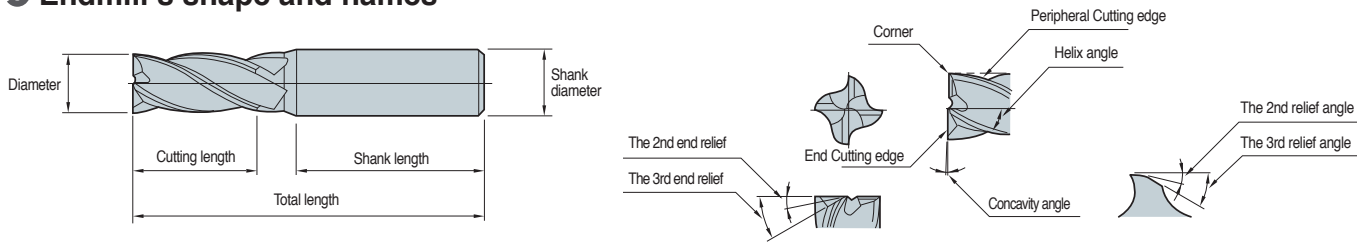

The comparison according to number of flute

Features of number of flute

Ø10mm	2 flutes	3 flutes	4 flutes
Shape			
Cross section	44mm ²	46mm ²	48mm ²
Ratio	56%	58%	61%
Advantages	Good chip flow	Good chip flow	High rigidity
Disadvantages	Weak rigidity	Difficult to measure external diameter	Bad chip flow
Usages	Side facing, Grooving Multi-functional	Side facing, Grooving Medium, finishing	Side cutting Finishing

Affection of number of flute

Specification	Major features	2 flutes	4 flutes
Tool rigidity	Torsional rigidity	○	⊙
	Bending rigidity	○	⊙
Surface finish	Surface roughness	○	⊙
	Machining precision	○	⊙
Chip control	Chip clogging	⊙	○
	Chip evacuation	⊙	○
Grooving	Chip evacuation	⊙	○
	Grooving	⊙	○
Side facing	Surface finish	○	⊙
	Vibration	⊙	○

⊙: Excellent ○: Good

The differences between general endmills and high speed endmills

General endmills		High speed endmills	
Cross section shape	Features	Cross section shape	Features
	- Applied for Low speed, High depth of cut, Low feed - Low hardness workpiece (general steel, cast iron)		- Applied for high speed, low depth of cut, high feed - Useful for hardened workpiece such as die steel

Calculations of cutting condition

Calculations of Cutting speed

$$vc = \frac{\pi \times D \times n}{1000} \quad n = \frac{1000 \times vc}{\pi \times D}$$

Calculations of feed speed

$$vf = n \times fn \quad \text{or} \quad n \times fz \times z$$

$$fn = \frac{vf}{n} \quad fz = \frac{fn}{z} \quad \text{or} \quad \frac{vf}{n \times z}$$

vc: Cutting speed (m/min)
 π: Circular constant (3.141592)
 D: Endmill diameter (mm)
 n: Revolution per minute (min⁻¹)
 vf: Feed speed (m/min)
 fn: Feed per revolution (mm/rev)
 fz: Feed per flute (mm/t)
 z: Number of flute

Ball endmills cutting speed calculation formulas

Revolution per minute	$n = \frac{vc \times 1000}{D \times \pi}$
Cutting speed	$vc = \frac{D \times \pi \times n}{1000}$
Feed per tooth	$fz = \frac{vf}{z \times n}$
Feed per revolution	$fn = fz \times z$
Feed speed	$vf = fz \times z \times n$
Chip removal rate	$Q = ae \times ap \times vf$

Effective diameter of Ball Endmill

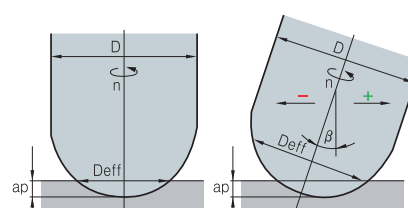

$$D_{eff} = 2 \times \sqrt{D \times ap - ap^2} \quad \text{Calculation Table}$$

$$D_{eff} = D \times \sin \left[\beta \pm \arccos \left(\frac{D - 2ap}{D} \right) \right]$$

🔄 The affection of flute length

● Expression of aspect ratio

- Aspect ratio
- l/d
- Ex) 3D, 15D, 22D

● Deformation rate according to length

- Deformation rate is reaction force against external force
- Proportional to the cube of length
- Set flute length and overall length as short as possible
- The more flute the better rigidity
- When flute width rate is narrower drill's rigidity is higher

$$\delta = \frac{P\ell^3}{3EI}$$

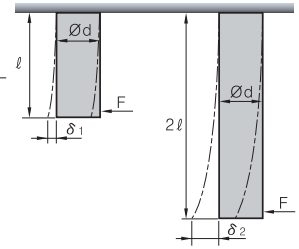

δ = Deformation volume l = Length of cut

P = Cutting force E = Elasticity coefficient

$$I = \text{Inertia moment} \left(I = \frac{\pi d^4}{64} \right)$$

• $l : 2l$

• $\delta_1 : \delta_2 = \delta_1 = \delta_2$

🔄 Spindle revolution conversion table (RPM) - external diameter

vc External	Cutting speed (vc, m/min)															
	20	30	40	50	60	70	80	90	100	120	140	150	180	200	250	300
0.2	31,831	47,746	63,662	79,577	95,493	111,408	127,324	143,239	159,155	190,986	222,817	238,720	286,479	318,310	397,887	477,465
0.3	21,221	31,831	42,441	53,052	63,662	74,272	84,883	95,493	106,103	127,324	148,545	159,155	190,986	212,207	265,258	318,310
0.4	15,915	23,873	31,831	39,789	47,746	55,704	63,662	71,620	79,577	95,493	111,408	119,366	143,239	159,155	198,944	238,732
0.5	12,732	19,099	25,465	31,831	38,197	44,563	50,930	57,296	63,662	76,394	89,127	95,493	114,592	127,324	159,155	190,986
0.6	10,610	15,915	21,221	26,526	31,831	37,136	42,441	47,746	53,052	63,662	74,272	79,577	95,493	106,103	132,629	159,155
0.7	9,095	13,642	18,189	22,736	27,284	31,831	36,378	40,926	45,473	54,567	63,662	68,209	81,851	90,946	113,682	136,419
0.8	7,958	11,937	15,915	19,894	23,873	27,852	31,831	35,810	39,789	47,746	55,704	59,683	71,620	79,577	99,472	119,366
0.9	7,074	10,610	14,147	17,684	21,221	24,757	28,294	31,831	35,368	42,441	49,515	53,052	63,662	70,736	88,419	106,103
1	6,366	9,549	12,732	15,915	19,099	22,282	25,465	28,648	31,831	38,197	44,563	47,746	57,296	63,662	79,577	95,793
1.5	4,244	6,366	8,488	10,610	12,732	14,854	16,977	19,099	21,221	25,465	29,709	31,831	38,197	42,441	53,052	63,662
2	3,183	4,775	6,366	7,958	9,549	11,141	12,732	14,324	15,915	19,099	22,282	23,873	28,648	31,831	39,789	47,746
2.5	2,546	3,820	5,093	6,366	7,639	8,913	10,186	11,459	12,732	15,279	17,825	19,099	22,918	25,465	31,831	38,197
3	2,122	3,183	4,244	5,305	6,366	7,427	8,488	9,549	10,610	12,732	14,854	15,915	19,099	21,221	26,526	31,831
3.5	1,819	2,728	3,638	4,547	5,457	6,366	7,276	8,185	9,095	10,913	12,732	13,642	16,370	18,189	22,736	27,284
4	1,592	2,387	3,183	3,979	4,775	5,570	6,366	7,162	7,958	9,549	11,141	11,937	14,324	15,915	19,894	23,873
4.5	1,415	2,122	2,829	3,537	4,244	4,951	5,659	6,366	7,074	8,488	9,903	10,610	12,732	14,147	17,684	21,221
5	1,273	1,910	2,546	3,183	3,820	4,456	5,093	5,730	6,366	7,639	8,913	9,549	11,459	12,732	15,915	19,099
5.5	1,157	1,736	2,315	2,894	3,472	4,051	4,630	5,209	5,787	6,945	8,102	8,681	10,417	11,575	14,469	17,362
6	1,061	1,592	2,122	2,653	3,183	3,714	4,244	4,775	5,305	6,366	7,427	7,958	9,549	10,610	13,263	15,915
6.5	979	1,469	1,959	2,449	2,938	3,428	3,918	4,407	4,897	5,876	6,856	7,346	8,815	9,794	12,443	14,691
7	909	1,364	1,819	2,274	2,728	3,183	3,638	4,093	4,547	5,457	6,366	6,821	8,185	9,095	11,368	13,642
7.5	849	1,273	1,698	2,122	2,546	2,971	3,395	3,820	4,244	5,093	5,942	6,366	7,639	8,488	10,610	12,732
8	796	1,194	1,592	1,989	2,387	2,785	3,183	3,581	3,979	4,775	5,570	5,968	7,162	7,958	9,947	11,937
8.5	749	1,123	1,498	1,872	2,247	2,621	2,996	3,370	3,745	4,494	5,243	5,617	6,741	7,490	9,362	11,234
9	707	1,061	1,415	1,768	2,122	2,476	2,829	3,183	3,537	4,244	4,951	5,305	6,366	7,074	8,842	10,610
9.5	670	1,005	1,340	1,675	2,010	2,345	2,681	3,016	3,351	4,021	4,691	5,026	6,031	6,701	8,377	10,052
10	637	955	1,273	1,592	1,910	2,228	2,546	2,865	3,183	3,820	4,456	4,775	5,730	6,366	7,958	9,549
11	579	868	1,157	1,447	1,736	2,026	2,315	2,604	2,894	3,472	4,051	4,341	5,209	5,787	7,234	8,681
12	531	796	1,061	1,326	1,592	1,857	2,122	2,387	2,653	3,183	3,714	3,979	4,775	5,305	6,631	7,958
13	490	735	979	1,224	1,469	1,714	1,959	2,204	2,449	2,938	3,428	3,673	4,407	4,897	6,121	7,346
14	455	682	909	1,137	1,364	1,592	1,819	2,046	2,274	2,728	3,183	3,410	4,093	4,547	5,684	6,821
15	424	637	849	1,061	1,273	1,485	1,698	1,910	2,122	2,546	2,971	3,183	3,820	4,244	5,305	6,366
16	398	597	796	995	1,194	1,393	1,592	1,790	1,989	2,387	2,785	2,984	3,581	3,979	4,974	5,968
17	374	562	749	969	1,123	1,311	1,498	1,685	1,872	2,247	2,621	2,809	3,370	3,745	4,681	5,617
18	354	531	707	884	1,061	1,238	1,415	1,592	1,768	2,122	2,476	2,653	3,183	3,537	4,421	5,305
19	335	503	670	838	1,005	1,173	1,340	1,508	1,675	2,010	2,345	2,513	3,016	3,351	4,188	5,026
20	318	477	637	796	955	1,114	1,273	1,432	1,592	1,910	2,228	2,387	2,865	3,183	3,979	4,775
21	303	455	606	758	909	1,061	1,213	1,364	1,516	1,819	2,122	2,274	2,728	3,032	3,789	4,547
22	289	434	579	723	868	1,013	1,157	1,302	1,447	1,736	2,026	2,170	2,604	2,894	3,617	4,341
23	277	415	554	692	830	969	1,107	1,246	1,384	1,661	1,938	2,076	2,491	2,768	3,460	4,152
24	265	398	531	663	796	928	1,061	1,194	1,326	1,592	1,857	1,989	2,387	2,653	3,316	3,979
25	255	382	509	637	764	891	1,019	1,146	1,273	1,528	1,783	1,910	2,292	2,546	3,183	3,820



Tool failure and trouble shooting

Trouble	Causes	Solutions																
		Cutting condition					Tool shape					Grade		etc				
		Cutting speed	Feed	Depth of cut	Coolant	Up cut-down cut	Relief angle	Lead angle	Length of flute	Number of flute	Honing	Chip pocket	Toughness	Hardness	Machine rigidity	Machine vibration	Workpiece fixing	Overhang
Damage at cutting edge	Excessive periphery cutting edge	↓	↑		●												↑	
	Chipping		↓			↓	↓			●		↑				↓	↑	↓
	Fracture during operation		↓	↓				↓			↑			↑		↑		↓
Poor surface finish	Generating built-up edge	↑	↑		●		↑			●								
	Chattering	↓				↓		↓						↑	↓	↑	↓	
	Poor straightness		↓	↓		↑	↑	↓										↓
Poor machining precision (Machined size, perpendicularity)	Improper cutting conditions Improper tool shape	↑	↓			↓		↓	↑					↑	↓		↓	
Bad chip evacuation	Excessive cutting volume Improper chip pocket Improper cutting conditions		↓	↓					↓		↑							

↑ : Increase ↓: Decrease ●: use ○: Correct use



➤ The shape of drills and the names

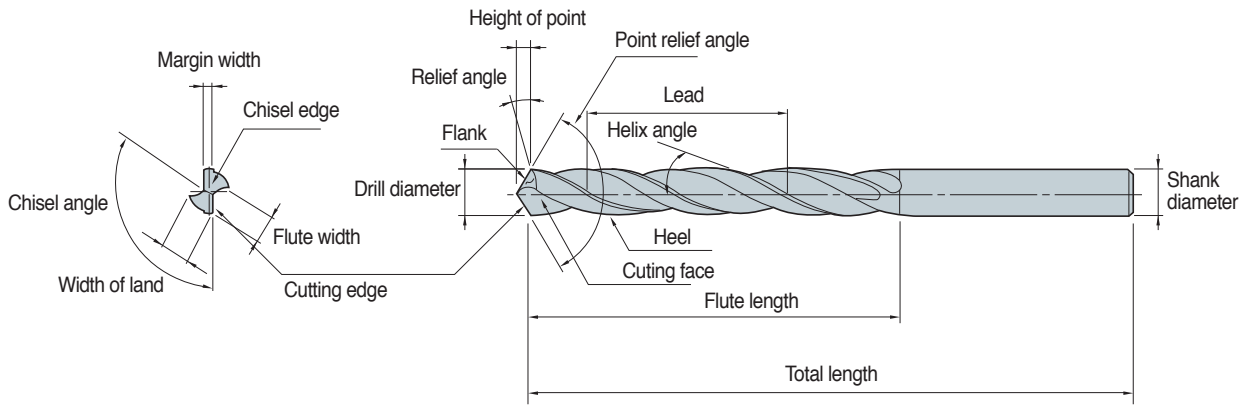

➤ Shape and the feature of cutting

Helix angle	<p>Plays rake angle of cutting edge's role. If helix angle increases Cutting force decreases. On the other hand If helix angle is too big Drill rigidity decreases</p> <p>Poor machinability ◀ low - Helix angle - high ▶ Hard workpiece (hardened steel) ▶ soft material (aluminum etc) ▶</p>												
Length of flute	<p>The path of both chip evacuation and cooling lubricant</p> <p>Too big length of flute weakens drill rigidity and too small length of flute worsens chip evacuation to breakage</p>												
Point angle	<p>Point angle has big influence on cutting performance. It mainly depends on workpiece. In case of standard drills Point angle is generally 118</p> <p>thrust resistance decrease ◀ low - Point angle - high ▶ thrust resistance increase Torque increase, Burr on exit increase ▶ soft material (aluminum etc) ▶ Torque decrease, Burr on exit decrease Soft material (aluminum etc) ▶ Hard workpiece (hardened steel) ▶</p>												
Margin	<p>While machining Margin is the part of contact between workpiece and drill's external. It prevents bending and plays guide's role. It depends on drill size</p> <p>Cutting force decrease ◀ small - Margin - big ▶ Cutting force increase Poor guide ▶ Good guide ▶</p>												
Web thickness	<p>Web is the part of center of drill and drill's rigidity depends on the web. Drill needs cutting edge, chisel edge, at the tip of drill because drill makes a hole at the beginning of drilling. When web thickness is big Thinning is needed to reduce cutting force</p> <p>Cutting force decrease ◀ small - Web thickness - big ▶ Cutting force increase Rigidity decrease ▶ Rigidity increase ▶ Good chip evacuation ◀ small - Web thickness - big ▶ Bad chip evacuation Soft material (aluminum etc) ▶ Hard workpiece (hardened steel) ▶</p>												
Back taper	<p>Drill diameter size is getting smaller from point to shank in order to avoid the friction between drill periphery and workpiece. The decrease of diameter divided by flute length 100mm generally becomes 0.04~0.1mm. As for high performance drills and drills for hole shrinkage workpiece during operation have big back taper</p>												
Thinning	<p>In general drills Thrust effects on chisel over 50%. Chisel edge length depends on web thickness and chisel angle. But if web is thin Drill rigidity weaken. Therefore without web thickness change Thinning makes chisel edge short or gives rake angle. In other words, Thinning makes rake angle at chisel and improves chip evacuation and decrease thrust</p> <table border="1" style="width: 100%; border-collapse: collapse;"> <thead> <tr> <th style="width: 20%;">Types of</th> <th style="width: 20%;">Edge shape</th> <th style="width: 30%;">Feature</th> <th style="width: 30%;">Korloy's drills</th> </tr> </thead> <tbody> <tr> <td style="text-align: center;">X type</td> <td style="text-align: center;"></td> <td> Good centering High central thickness Crank shaft </td> <td> Mach solid drill (MSD) Vulcan drill (VZD) </td> </tr> <tr> <td style="text-align: center;">S type</td> <td style="text-align: center;"></td> <td> For wide use For general Easy regrinding </td> <td> Solid drill (SSD) </td> </tr> </tbody> </table>	Types of	Edge shape	Feature	Korloy's drills	X type		Good centering High central thickness Crank shaft	Mach solid drill (MSD) Vulcan drill (VZD)	S type		For wide use For general Easy regrinding	Solid drill (SSD)
Types of	Edge shape	Feature	Korloy's drills										
X type		Good centering High central thickness Crank shaft	Mach solid drill (MSD) Vulcan drill (VZD)										
S type		For wide use For general Easy regrinding	Solid drill (SSD)										



Major cutting formulas

Cutting speed	Feed	Helix angle	Machining time
$vc = \frac{\pi \cdot D \cdot n}{1000} \text{ (m/min)}$ <ul style="list-style-type: none"> vc: Cutting speed (m/min) D: Drill diameter (mm) n: Revolution per minute (min⁻¹) π: Circular constant (3.14) 	$fn = \frac{vf}{n} \text{ (mm/rev)}$ <ul style="list-style-type: none"> fn: Feed per revolution (mm/rev) vf: Feed per minute (mm/min) n: Revolution per minute (min⁻¹) 	$\delta = \tan^{-1} \left(\frac{\pi D}{L} \right)$ <ul style="list-style-type: none"> δ: Helix angle D: Drill diameter (mm) L: Lead (mm) π: Circular constant (3.14) 	$tc = \frac{ld}{n \cdot fn} \text{ (min)}$ <ul style="list-style-type: none"> tc: Machining time (min) n: Revolution per minute (min⁻¹) ld: Drilling time (mm) fn: Feed (mm/rev)

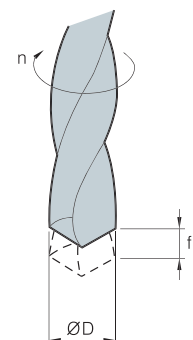

Cutting torque and thrust (calculation formulas)		
$Md = KD^2 \times (0.0631 + 1.686 \times fn) \text{ (kg·cm)}$ $T = 57.95KDfn^{0.88} \text{ (kg)}$	<ul style="list-style-type: none"> Md: Cutting torque (kg·cm) T: Cutting thrust (kg) D: Drill diameter (mm) 	<ul style="list-style-type: none"> fn: Feed per revolution (mm/rev) K: Material coefficient

Workpiece material (SAE/AISI)		Tensile strength (kgf)	Hardness (HB)	Material coefficient K
Cast iron	Cast iron (Gray)	21	177	1.00
	Cast iron	28	198	1.39
	Cast iron (Ductile)	35	224	1.88
General steel	1020(carbon steel C 0.2%)	55	160	2.22
	1112(C 0.12, S 0.2%)	62	183	1.42
	1335(Mn 1.75%)	63	197	1.45
Nickel Chrome steel	3115 (Ni 1.25, Cr 0.6, Mn 0.5)	53	163	1.56
	3120 (Ni 1.25, Cr 0.6, Mn 0.7)	69	174	2.02
	3140	88	241	2.32
Chrome molybdenum steel	4115 (Cr 0.5, Mo 0.11, Mn 0.8)	63	167	1.62
	4130 (Cr 0.95, Mo 0.2, Mn 0.5)	77	229	2.10
	4140 (Cr 0.95, Mo 0.2, Mn 0.85)	94	269	2.41
Nickel molybdenum steel	4615 (Ni 1.8, Mo 0.25, Mn 0.5)	75	212	2.12
	4820 (Ni 3.5, Mo 0.25, Mn 0.6)	140	390	3.44
Chrome steel	5150 (Cr 0.8, Mn 0.8)	95	277	2.46
Chrome vanadium steel	6115 (Cr 0.6, Mn 0.6, V 0.12)	58	174	2.08
	6120 (Cr 0.8, Mn 0.8, V 0.1)	80	255	2.22

Cutting torque and thrust (empirical formula)			
$Md = K_1 \cdot d^2 \cdot fn^m$ $T = K_2 \cdot d \cdot fn^n$	<ul style="list-style-type: none"> Md: Cutting torque (kg·cm) T: Thrust (kg) 	<ul style="list-style-type: none"> fn: Feed (mm/rev) d: Drill diameter (mm) K₁, K₂, m, n: Experimental Data Characteristic value 	

Workpiece	K ₁	m	K ₂	n
Soft steel	5.9	1.00	125.0	0.88
Rolled steel	3.5	1.00	55.0	0.88
7-3 brass	2.5	0.94	44.4	0.87
Aluminum	1.5	0.90	33.3	0.78
Zinc	1.4	0.88	27.0	0.74
Gun metal	2.0	0.94	21.6	0.75
Galvanized iron	0.3	0.57	6.4	0.55



Tool failures and solutions

Trouble	Causes	Solutions																
		Cutting condition					Tool shape					Grade		etc				
		Cutting speed	Feed	Step feed	Initial feed	Coolant	Relief angle	Point angle	Thinning angle	Honing	Flute width rate	Thinning	Toughness	Hardness	Machine rigidity	Machine vibration	Guide bush	Clamping workpiece
Chipping	• Too sharp cutting edge (too big relief angle) (thinning edge is too sharp)						↓		↓	↑			↑					
	• Excessive cutting speed	↓				●												
	• Built-up edge					●	↓		↓	↑			↑					
	• Vibration and chattering	↓												↑	↓		●	
Wear	• Excessive cutting speed (Abnormal wear at margin)	↓				●												
	• Insufficient cutting speed (Abnormal wear at center)	↑				●												
Chip	• Long chip	↑	↑			●				↓								
	• Over lap	↑	↑															
	• Chip burning	↑				●												
Hole precision burr, poor surface finish	• Tool clamping precision				↓			↓		↓				↑	↓		●	
	• Excessive feed, sharp point angle		↓						↑	↓								
	• Excessive cutting speed (Considered tool grade)	↑				●	↓	⊙					↑					
Fracture	Breakage on contact	• Poor surface finish			●	↓											●	
		• Insufficient machine rigidity												↑				●
		• Improper cutting condition	↑	↓														
	Breakage at hole bottom	• Crooked hole	↑							↑			●			↓	●	
		• Chip clogging		↓	●								↑					

↑: Increase ↓: Decrease ●: use ⊙: Correct use



 Hole size for threading

● Metric coarse screw threads

Specification	Hole diameter
M1 X 0.25	0.75
M1.1 X 0.25	0.85
M1.2 X 0.25	0.95
M1.4 X 0.3	1.1
M1.6 X 0.35	1.25
M1.7 X 0.35	1.35
M1.8 X 0.35	1.45
M2 X 0.4	1.6
M2.2 X 0.45	1.75
M2.3 X 0.4	1.9
M2.5 X 0.45	2.1
M2.6 X 0.45	2.2
M3 X 0.6	2.4
M3 X 0.5	2.5
M3.5 X 0.6	2.9
M4 X 0.75	3.25
M4 X 0.7	3.3
M4.5 X 0.75	3.8
M5 X 0.9	4.1
M5 X 0.8	4.2
M5.5 X 0.9	4.6
M6 X 1	5
M7 X 1	6
M8 X 1.25	6.8
M9 X 1.25	7.8
M10 X 1.5	8.5
M11 X 1.5	9.5
M12 X 1.75	10.3
M14 X 2	12
M16 X 2	14
M18 X 2.5	15.5
M20 X 2.5	17.5
M22 X 2.5	19.5
M24 X 3	21
M27 X 3	24
M30 X 3.5	26.5
M33 X 3.5	29.5
M36 X 4	32
M39 X 4	35
M42 X 4.5	37.5
M45 X 4.5	40.5
M48 X 5	43

● Metric coarse screw threads

Specification	Hole diameter
M2.5 X 0.35	2.2
M3 X 0.35	2.7
M3.5 X 0.35	3.2
M4 X 0.5	3.5
M4.5 X 0.5	4
M5 X 0.5	4.5
M5.5 X 0.5	5
M6 X 0.75	5.3
M7 X 0.75	6.3
M8 X 1	7
M8 X 0.75	7.3
M9 X 1	8
M9 X 0.75	8.3
M10 X 1.25	8.8
M10 X 1	9
M10 X 0.75	9.3
M11 X 1	10
M11 X 0.75	10.3
M12 X 1.5	10.5
M12 X 1.25	10.8
M12 X 1	11
M14 X 1.5	12.5
M14 X 1	13
M15 X 1.5	13.5
M15 X 1	14
M16 X 1.5	14.5
M16 X 1	15
M17 X 1.5	15.5
M17 X 1	16
M18 X 2	16
M18 X 1.5	16.5
M18 X 1	17
M20 X 2	18
M20 X 1.5	18.5
M20 X 1	19
M22 X 2	20
M22 X 1.5	20.5
M22 X 1	21
M24 X 2	22
M24 X 1.5	22.5
M24 X 1	23
M25 X 2	23
M25 X 1.5	23.5
M25 X 1	24
M26 X 1.5	24.5
M27 X 2	25

⚠ Cautions

● Selection of drill chuck

- Collect chuck is favorable Because it has strong grip power (General drill-chuck and Keyless chuck don't have enough grip power.)

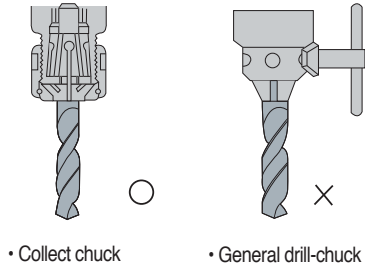

● Coolant supply

- Supply enough coolant around hole entrance
- Standard cutting oil pressure: 3~5 kg/cm², Flux: 2~5 l/min

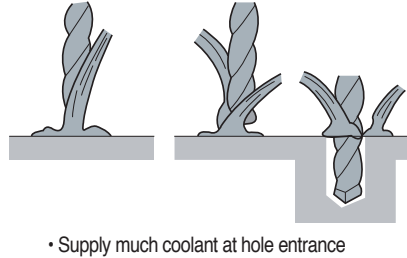

● Mounting drill

- When mounting drill Periphery chattering should be within 0.02 mm
- Flute should not be clamped

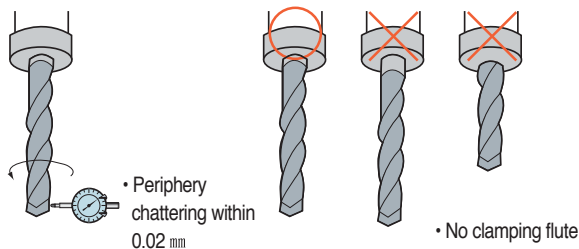

● How to clamp workpiece

- At high performance drilling High thrust, torque and horizontal cutting force work at the same time so that workpiece should be clamped strongly to prevent chattering

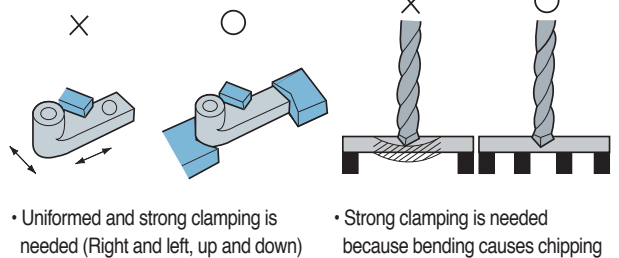

⚠ Notice

- 1) For better drill's life, small damage and wear are favorable to be regrinding
- 2) Damage and wear size should be within 1.5 mm for regrinding
- 3) If drill has crack, regrinding is impossible
- 4) Ordering for regrinding is acceptable or purchase regrinding machine

⚠ Regrinding procedures

● Regrinding method (Mach Drill)

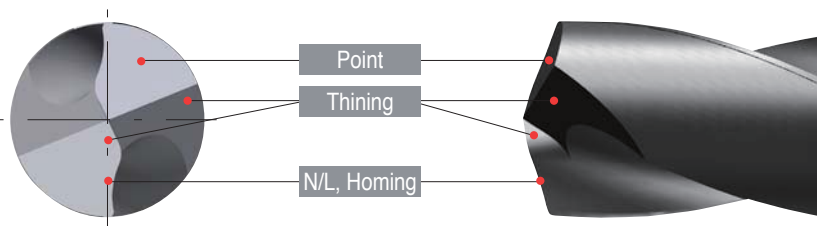

1) Preparation Determination of regrinding areas

- Check the cutting edge for damage and wear If large fracture is found, remove it by rough grinding



2) Grinding operation Drills setting

- Drill is clamped to collet chuck Chattering is kept within 0.02 mm

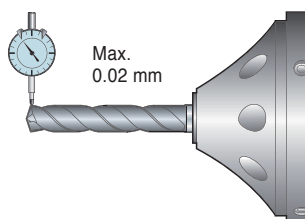

3) Grinding operation-Grinding point

- Check damage and wear at the point and remove it completely
- The difference of the lip height is kept within 0.02 mm

Point angle (a): 140°
Point relief angle (b): 8°~15°

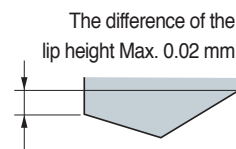
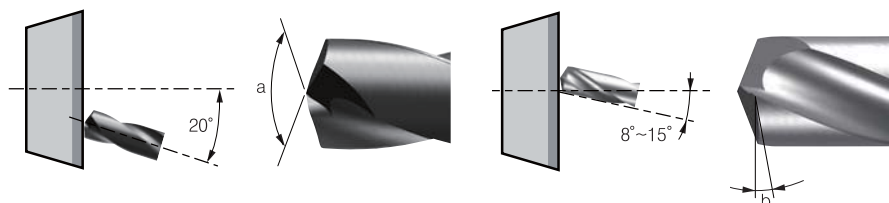
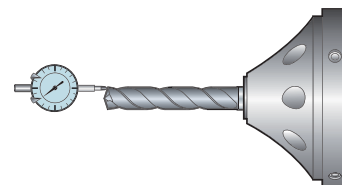

4) Grinding operation-Thinning grinding

- Considering N/L width Cutting edge length from the center of drill axis should be 0.03~0.08mm for balancing
- Set the wheel to tilt drill axis by 34°~40°.

Thinning angle (a): 155°~160° Thinning open angle (b): 100°~105°
Thinning relief angle (c): 34°~40°

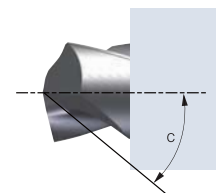
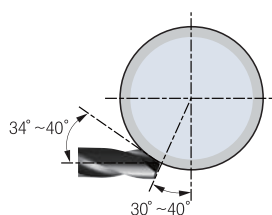
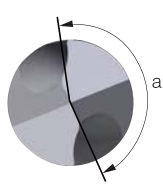
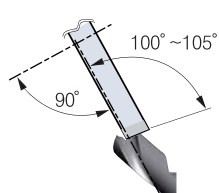

5) Grinding-N/L grinding and honing

- Using diamond chisel Grinds the width flat along point cutting edge
- After negaland operation Finishes with brush or handstone

N/L width (a): 0.05mm~0.16mm/N/L angle (b): 24°~26°

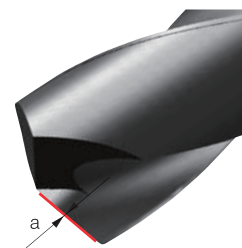
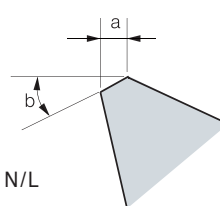

● TIP

- Making point
 - Without center drill, the point width should be below 0.10 mm
- Recommended grinding condition
 - Diamond wheel: 240~400 mesh
 - Diamond chisel: 400~600 mesh
 - Diamond hand stone: 800~1500 mesh

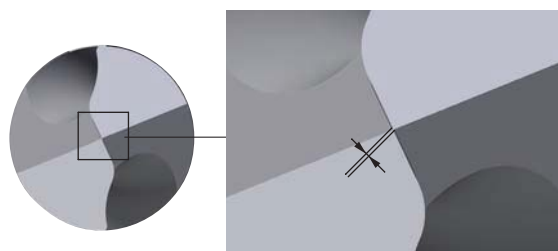

➤ Hexagonal socket bolt (clamping screw) size

● Counter boring and size of bolt hole for hexagonal socket bolt

ISO (d)	M3	M4	M5	M6	M8	M10	M12	M14	M16	M18	M20	M22	M24	M27	M30
Ød _i	3	4	5	6	8	10	12	14	16	18	20	22	24	27	30
Ød'	3.4	4.5	5.5	6.5	8.5	11	14	16	18	20	22	24	26	30	33
ØD	5.5	7	8.5	10	13	16	18	21	24	27	30	33	36	40	45
ØD'	5	8	9.5	11	14	17.5	20	23	26	29	32	35	39	43	48
H	3	4	5	6	8	10	12	14	16	18	20	22	24	27	30
H'	2.7	3.6	4.6	5.5	7.4	9.2	11.0	12.8	14.5	16.5	18.5	20.5	22.5	25	28
H''	3.3	4.4	5.4	6.5	8.6	10.8	13.0	15.2	17.5	19.5	21.5	23.5	25.5	29	32

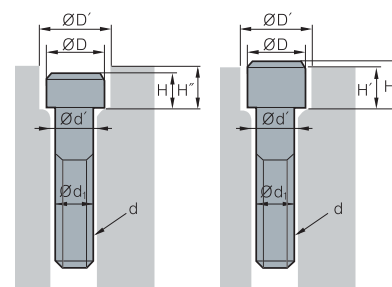

The comparison of chip breakers

APPLICATION		KORLOY	KYOCERA	TAEGUTEC	SUMITOMO	SANDVIK	KENNAMETAL	ISCAR	WLATER	MITSUBISHI	SECO	TUNGALLOY		
NEGATIVE	P	Application	Ultra-Finishing	-	DP (G-class)	-	FA	PMC	FF (G-class)	SF	-	PK (G-class), FY	FF1	TF
			VL	GP	FA	FL, FB	QF	UF	PF	NF3	FH, FS, SY	FF2	NS, ZF	
		Finishing	VF	PP	FG	LU, FE	PF, XF	FN	NF, SM	NF4	FP		NM, NS, SS	
			VB	-	SF	SU	61	K	F3P	FP5	LP, SH, SA	MF2	TS, TSF	
		Medium to finishing	VQ, VC	HQ, CQ	MC	SE	HM	LF, CT	TF	NS6	C (Cermet)		AS	
			LP	PQ, CJ	FC	SX	PMC	-	-	MP3	MV	MF5	ZM, AM	
	Medium machining	VM, HM	HK, GS, HS, PS	MP, MT	GU (UG)	QM, SM	MP, MN	PP, TF	NM4, NP5	MA, MH	M3, M5	TQ, TM		
		MP	PG	PC	GE, UX	PM, XM	-	M3P	MP5	MP	-	DM, None C/B		
	Roughing	B25					-	RP, MR	GN	-	GM, None C/B	M5	TH	
		GR	PT, GT, HT, PH	RT	MU, ME, MX	PR, WR	RN, None C/B	R3P	RP5, NM9	GH, RP	MR5, MR6, MR7	THS		
Heavy duty machining	GH	PX	HB, RH, RX	HG, MP	PR, XMR	RH	NR, HT	RP7, NR4, NRF	HZ	R4, R5	CH			
	VH	-	HZ, EH	HP	QR	RM	HR	NRR, NR8	HX	R6, R7, R8, PR6	THS, TRS			
	VT	-	HT, HY, HD	HU, HW, HF	HR	MM	T3P	-	HV	PR9, R56, R57, R68	65, TUS			
Low carbon steel	Soft steel	VL	XF, XP, XP-T	SF	FL	LC	-	-	FY	-	-			
		-	XQ, XS	-	-	-	-	-	SY	-	-			
High feed	Wiper	VW	WP, WF	WS	LUW, SEW	WF, WL	FW	WF	NF	SW	FF2, MF2	AFW, FW		
		LW	WQ, WE	WT	GUW	WM, WMX	MW	WG	NM	MW	MF5, M3	ASW, SW		
		-	-	-	-	WR	RW	-	-	-	R4, R7	-		
Application	Shaft (long bar)	SH	CJ, ST	FS, VF, FX	HM	K	-	-	-	ES	UX	P, S		
		KNUX-	KNMX-	KNUX-	-	KNUX-71	-	-	-	KNMX-19	-	KNMX		
M	Stainless steel	Finishing	VP2, MP	MQ, GU, SK	EA, SF	SU, EF	MF, XF	FP, FF	SF, VL, F3M	NF4, FM5	SH, LM	FF1, MF1	SS, SF, SA	
		Medium cutting	MM	HU, TK, MS	MP, EM	EX, EG, GU	MM, XM, QM, MMC	MP, UP, MS	PP, TF, M3M	NM4, NR4	MS, GM, MM	MF3, MF4	SM	
		Roughing	RM	MU	ET	MU, HM, EM	MR, XMR, MRR	RP, P	MR, R3M	RM5, NRS	MA, ES	MF5, M5	S, SH	
K	Cast iron	Finishing	MP	None C/B, C, KQ	MT	UZ	KF, PMC, XF	T-20, FN	TF	NM, MK5	LK, MA	M4	CF	
		Medium cutting	B25, MK	ZS, KG	RT, KT	UX, GZ	KM, XM	UN, RP	GN	NM5, RK5	MK, GK, None C/B	M5	CM, None C/B	
		Roughing	-MA, RK	-MA, GC, KH	-MA	-MA	KR, XMR, KRR	MR, S-20, -MA	-MA, NR	-MA, RK7	RK, -MA	MR7	CH	
S	HRSA	Ultra-finishing	VP1	MQ, SK	EA	EF	SF, SGF	FS (G-class) LF (G-class)	SF, PF	NF4	FJ(G-class)	M1	SF	
		Finishing	VP2	TK	ML	UP, EG	23.SR, XF, SMC	UP	PP	NFT	LS	MF1	HMM	
		Medium cutting	VP3	MS	EM	EX	SM, SMR, XM	MS, GP, P, UN	TF	NMS, NMT	MS	MF4, MR3	HRF	
		Roughing	VP4	MU	ET	MU	XMR	RP	MR	NRS, NRT	RS, GJ	MR4	HRM	
N	Aluminium alloy	HA	AH	ML	AX	23	GP, MS	NF, PP	FN2, PF2, MN2, PM2	MJ	MF1	P		
POSITIVE	P M K	Application	Finishing	VL	XP, PP	FA, FX	FC	PF, XF	11	PF	FP4	SMG (G-class), FV	FF1	01
				VF	GP	-	FB, LU (FP, FK)	UF	UF	F3P	FK6	SV, FP	F1	PSF, PF
			Medium cutting	HMP	XQ	FG	LB, NF	PM, XM	LF, FP	14	MP4, FM2, FM4, MK4	LP	MF2	PSS
				MP	HQ, GK	PC, FM	SU, SC	UM, PMC	MP, T-20	SM	FP6, MM4, FM6, RK4	MV	F2, M3	PS
	Roughing	C25	None C/B	MT	MU	PR, UR, XR	MF, GM, -C	19	RP4, RM4, RK6	None C/B, MP	M5	PM		
Wiper	-	WP	-	LUW	WL, WF	FW	WF	PM	SW	-	-			
	-	-	WT	SDW	WM, WMX	MW	WG	-	MW	-	-			
M S	Stainless steel For HRSA	Finishing	VP1	CF, GF, GQ	FG	FC, FM	MF, MM, MMC	11, UF, LF	PF	FM4, NM4	FJ (G-class), FM, LM	F1, MF2	PSF, PSS	
		Medium to finish cutting	VL	MQ, MF	SA	LB, SI	MR, XR, SMC	MF	SM, M3M	RM4	MM, None C/B	M3, M5	PS, PM	
K	Cast iron	Medium cutting	MP	HQ	PC	MU	KF, KM	LF	17	FK6	MK	M3	CM	
		Roughing	C25	GK	MT	None C/B	KR	MF, UF	19	MK4, RK6	None C/B, -MW	M5	None C/B	
N	Aluminium alloy	AK, AR	AH	FL	AW, AG, AY	AL	HP, LF	AS, AF	PM2	AZ, FS	AL	AL		
High precision bar turning (tolerance class G&E)		KF, KM	FSF, USF, J, A3	GF, FF, GW	FY, FX, FZ	K, F, UM	GH	LF, RF, XL	-	F, SR, SS, SM	UX	JS, J10, JRP, JPP		



KORLOY grades

Cat.	Grade	ISO						Turning	Multi functional tools	Threading	Milling	Endmill	Index drill	Solid drill	Brazed tools	Coating layer
		P	M	K	S	N	H									
CVD	NC3215	P10-P15						●								
CVD	NC3225	P20-P25						●	●							
CVD	NC3120	P20-P25						●	●							
CVD	NC3030	P25-P35						●	●							
PVD	PC3030T	P35-P45	M25-M35							●						
CVD	NC6310			K01-K10				●								
CVD	NC6315			K10-K20				●	●							
PVD	PC8105		M05-M15		S01-S10			●								
PVD	PC8110		M10-M20		S05-S15			●	●							
PVD	PC8115		M15-M25		S10-S20			●								
CVD	NC9115		M10-M20					●								
CVD	NC9125		M20-M30		S10-S20			●								
CVD	NC9135		M30-M40		S15-S25			●								
PVD	PC9030		M25-M35					●	●							
PVD	PC9070T		M25-M35							●						
PVD	PC2005						H01-H10				●					
PVD	PC2010						H05-H15				●					
PVD	PC2015						H10-H20				●					
PVD	PC2505						H01-H10				●					
PVD	PC2510						H05-H15				●	●				
PVD	PC210F						H10-H20				●					
CVD	NCM325	P30-P40										●				
CVD	NCM335	P35-P45														
PVD	PC3600	P25-P35														
PVD	PC3700	P25-P40										●				
CVD	NC5330	P30-P35	M25-M35	K15-K25				●	●			●				
CVD	NCM535	P30-P40		K20-K30												
CVD	NCM545	P40-P50		K30-K40												

Coating

KORLOY grades

Cat.	Grade	ISO						Turning	Multi functional tools	Threading	Milling	Endmill	Index drill	Solid drill	Brazed tools	Coating layer
		P	M	K	S	N	H									
Coating	PVD PC5300	P30-P40	M20-M30	K20-K30	S15-S25			●	●	●	●	●				
	PVD PC5335	P30-P40	M20-M30									●				
	PVD PC5400	P35-P45	M30-M40	K25-K35	S25-S35			●		●						
	PVD PC6510			K05-K15						●		●				
	PVD PC9530		M25-M35							●						
	PVD PC9540		M35-M45		S30-S40					●						
Cermet	PVD CC1500 ^{new}	P10-P20		K05-K15				●								
	PVD CC2500 ^{new}	P20-P30		K10-K15				●								
	CN1500	P10-P20		K10-K20				●								
	CN2000	P20-P30						●	●		●					
	CN2500	P15-P30		K15-K25				●								
	CN30	P25-P35								●						
Uncoated	ST10	P10-P15								●				●		
	ST20	P15-P20							●					●		
	ST30A	P25-P35							●		●					
	U20		M25-M30											●		
	H01			K05-K10	S01-S10	N10-N20	H05-H10	●	●		●	●	●	●		
	H05			K10-K15	S05-S15	N15-N25		●			●					
	G10E				K15-K20			●			●				●	
Coating	PVD PC203F						H05-H15					●				
	PVD PC210C					N10-N20						●				
	PVD PC215F	P20-P35										●				
	PVD PC215G	P15-P30		K15-K30								●				
	PVD PC221F	P35-P45		K35-K45							●					
	PVD PC230F	P05-P15	M05-M15	K05-K15									●			
	PVD PC303S	P05-P15		K05-K15			H05-H15					●				
	PVD PC310U	P10-P20		K10-K20			H10-H20					●				
	PVD PC315E	P20-P35		K20-K35							●					
	PVD PC315G	P15-P30		K15-K30									●			



KORLOY grades

Cat.	Grade	ISO						Turning	Multi functional tools	Threading	Milling	Endmill	Index drill	Solid drill	Brazed tools	Coating layer
		P	M	K	S	N	H									
Coating	PVD PC320	P20-P35		K20-K35							●					
	PVD PC320S		M20-M30		S20-S30						●					
	PVD PC320U	P01-P10		K05-K10							●					
	PVD PC325T new				S20-S30								●			
	PVD PC325U	P20-P35	M20-M30	K20-K35										●		
Uncoated	H01					N10-N20					●					
	H05S					N10-N20					●					
	FCC			N15-N35							●					
	FG2	P05-P25				N05-N25							●			
	FA1	P05-P25				N05-N25								●		
cBN	DBN500			K05-K15				●								
	DBN700A			K01-K10				●								
	DB7000	S01-S10						●								
	DB1000					H01-H10		●								
	DB2000					H05-H15		●								
	DBNX20					H15-H25		●								
	DBN250					H15-H25		●								
	DBN400					H15-H25		●								
	PVD DNC100 new					H01-H10		●								
	PVD DNC250					H05-H15		●								
	PVD DNC350					H25-H35		●								
PVD DNC400 new					H15-H25		●									
PCD	DP90					N01-N20				●						
	DP150					N05-N25				●						
	DP200					N10-N30				●						
DIA	CVD ND2100 new					N2.5-N7.5		●		●	●		●			
	CVD ND3000 new					N01-N05		●		●	●					
DLC	PVD PD1005					N05-N10		●		●	●					
	PVD PD1010					N10-N15		●		●	●					



The comparison of grade for milling

CVD coated

ISO	KORLOY	SUMITOMO	KYOCERA	ISCAR	SANDVIK	SECO	KENAMETAL	TOSHIBA	mitsubishi	HITACHI	VALENITE	WALTER	TAEGUTEC	NTK	DIJET
Milling	P	NC5330	ACP100	IC5100 IC5400	GC4210 GC4220 GC4230	MP1500 MS2500 MP2500 MS2500 T350M MM4500	KCPM20		FH7020 F7030			WKP25S WKP35S WKP35G	TT8515 TT7800		
		NCM325 NCM535★													
		NCM335 NCM545★						KCMP30 KC927M	T3130		SM245				
	M	NC5330 NC5340★					MP2500		T3130	F7030					
		NC5350★	ACP400			GC2040	MM4500								
	K	NC5330 NCM535★ NCM545★	ACK200		IC5100		MK1500 MK2000 MS2500 T350M MK3000	KC907M KCK15 KC914M KCPK30 KC917M KC924M	T1115 T1015	MC5020		WAK15 WKK25 WKP25S WKP35S WKP35G	TT7515 TT6800		

PVD coated

ISO	KORLOY	SUMITOMO	KYOCERA	ISCAR	SANDVIK	SECO	KENAMETAL	TOSHIBA	mitsubishi	HITACHI	VALENITE	WALTER	TAEGUTEC	NTK	DIJET		
Milling	P	PC2005★ PC2010★ PC2015★			P20A						ATH80D PCA08M ACS05E PCA12M PC20M						
		PC2505★ PC2510★				GC1010			AP20M GP20M				TT2510		DH102		
		PC3600 PC3700★	ACZ310		IC903 IC908 IC950		MP3000		GH330	MP6120	TB6045	VC935	WKP25			JC5003	
			ACP200	PR730			F25M F30M	KC522M KUC20M		VP15TF				TT7070 TT7080 TT7030		JC5015	
			PC210F	ACZ330	PR830 PR630	IC1008	GC1025 GC1030		KC525M KUC30M	AH120	UP20M	CY250 PTH30E			QM3 ZM3	JC5030 JC5040	
			PC5300	ACP300 ACZ350						MP6130	JP4160		WKP35				
		PC5400★		PR660	IC928	GC1030	F40M T60M	KC935M KC7140 KC720	AH3135	VP30RT	JM4160 PTH40H		WKP45	TT8020			
		M	PC210F PC5300	ACM100 ACP200	PR730	IC903			KC5510 KC7020	AH120		JX1020 CY9020 JX1015 TB6020 CY250				QM3 ZM3	JC5003
			PC9530	ACM300 ACP300 ACZ350	PR1025 PR630 PR660 PR1535	IC900 IC250 IC928	GC1125 GC1025 GC2030 GC1030	F25M F30M	KC522M KC725M KC735M KC7030	AH140	MP7130	JX1045 TB6045	VC928 VC902 VC901	WQM35 WSM35S WSP45 WSM45S	TT9080 TT8020		JC5015 JC5030 JC5040
	PC5400★ PC9540★			PR660	IC328		F40M	KC722	AH3135	MP7140	JX1060 TB6060						
	K	PC6510		PR510 PR905	DT7150 IC900 IC910 IC950 IC350		MK2050	KC510M KC915M		VP10MF VP15TF		VC903 VC928		TT6290		JC5003	
		PC5300						KC520M	AH120	VP20RT		VC902 VC901		TT6030 TT6060		JC5015	
	S	PC5300 PC5400★ PC9540★	AC520U	PR620 PR660 PR1535	IC328 IC408	GC1025 GC1040 S40T	F40M MS2050	KC510M KCU30M		VP15TF VP30RT MP9130	ACS05E		WSM35S WSM45S	TT9030 TT8020 TT8080			

CERMET

ISO	KORLOY	SUMITOMO	KYOCERA	ISCAR	SANDVIK	SECO	KENAMETAL	TOSHIBA	mitsubishi	HITACHI	VALENITE	WALTER	TAEGUTEC	NTK	DIJET
Milling	P	CN2000	T250A	TN100M				NS540 NS740	NX2525	CH550 CH570			CT3000	C50	
		CN30		TC60M	IC30N			KT195M	NX4545					CT7000	
	M		T250A			CT530									
K								NX2525							

★ : PVD Coating cermet ★ : New Grade



M

**OLD-FASHIONED
PRODUCT INFORMATION**

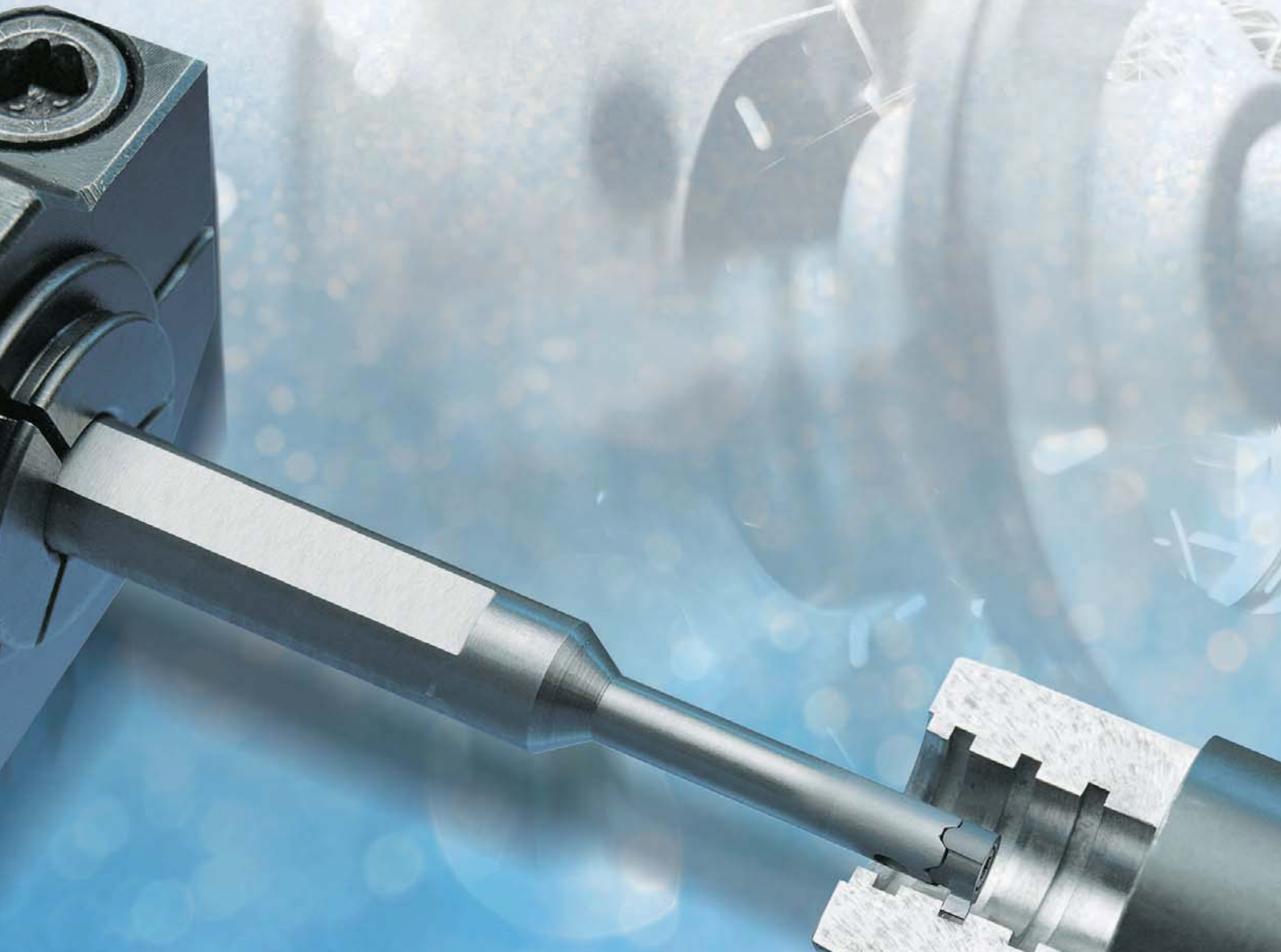



Old-fashioned product information

- M02 Grade
- M02 External Holder
- M03 Fine Tool
- M03 Threading Tool
- M03 Mill-Max
- M04 Cen-Mill
- M04 Jip Drill
- M04 LPD/SPD/NPD

M Old-fashioned product information

Grade

ISO material code		Old grade	New grade
Coating grade	P	NC5340	NCM535
		NCM325	
		NCM335	NCM545
		NC5350	
	M	PC3530, PC3525, PC3535, PC3500	PC3600
	K	NC6110, NC6210, NC6215	NC6315
		NC6205	NC6310
	S	PC8010	PC8110
P, M, K, S	PC8520, PC215K	PC5300	
	PC225F	PC205F	
Cermet		CN1000	CN1500
		CT10, CN200	CN2000

- Korloy always study and develops cutting-edge technology tools and grades which covers higher speed and feed conditions
- Korloy guarantees better performance and wide stock-management range for the new grade

External holder

Designation	Insert	Old parts name						New holder	Page
		Lever	Screw	Shim	Shim pin	Wrench	Shim pin Wrench		
PCBNR□□□□-□19	CN**1906	LV6	VHX1027	SC63	SP6	HW40L	-	PCBNR□□□□-□19N	B153
PCBNR□□□□-□25	CN**2509	LV8	VHX1236	SC83	SP8	HW50L	-	PCBNR□□□□-□25N	
PCLNR□□□□-□19	CN**1906	LV6	VHX1027	SC63	SP6	HW40L	-	PCLNR□□□□-□19N	B154
PCLNR□□□□-□25	CN**2509	LV8	VHX1236	SC83	SP8	HW50L	-	PCLNR□□□□-□25N	
PSBNR□□□□-□19	SN**1906	LV6	VHX1027	SS63	SP6	HW40L	-	PSBNR□□□□-□19N	B157
PSBNR□□□□-□25	SN**2507	LV8	VHX1236	SS83	SP8	HW50L	-	PSBNR□□□□-□25N	
PSDNN□□□□-□19	SN**1906	LV6	VHX1027	SS63	SP6	HW40L	-	PSDNN□□□□-□19N	B157
PSDNN□□□□-□25	SN**2507	LV8	VHX1236	SS83	SP8	HW50L	-	PSDNN□□□□-□25N	
PSKNR□□□□-□19	SN**1906	LV6	VHX1027	SS63	SP6	HW40L	-	PSKNR□□□□-□19N	B158
PSKNR□□□□-□25	SN**2507	LV8	VHX1236	SS83	SP8	HW50L	-	PSKNR□□□□-□25N	
PSSNR□□□□-□19	SN**1906	LV6	VHX1027	SS63	SP6	HW40L	-	PSSNR□□□□-□19N	B158
PSSNR□□□□-□25	SN**2507	LV8	VHX1236	SS83	SP8	HW50L	-	PSSNR□□□□-□25N	

- Old parts are not interchangeable with new type holder part
- Good performance and convenient use of New type holder gives customer best quality of service

Designation	Insert	Old parts name				New holder	Page
		Wedge clamp	Screw	Washer	Others		
WTENN□□□□-□16 (Old Type: MTEEN)	TN**1604	CMH5R1	MHX0523	WA4	Same as before	WTEEN□□□□-□16	B161
WTJNR□□□□-□16 (Old Type: MTJNR)	TN**1604	CMH5R1	MHX0523	WA4	Same as before	WTJNR□□□□-□16	B161
WTXNR□□□□-□16 (Old Type: MTXNR)	TN**1604	CMH5R1	MHX0523	WA4	Same as before	WTXNR□□□□-□16	B161

- Old parts are not interchangeable with new type holder part
- Good performance and convenient use of New type holder gives customer best quality of service



Fine tool

Designation	Insert		Old parts name		New holder	Page
			Screw	Wrench		
FTIH	FTIH08****	FTG08, FTT08, FTF08	PTKA02508	TW08P	NFTIH	C56
	FTIH11****	FTG11, FTT11, FTF11	PTKA03510	TW15P		
	FTIH14****	FTG14, FTT14, FTF14	PTKA0412	TW15P		
	FTIH16****	FTG16, FTT16, FTF16	PTKA0512	TW20P		

- Old inserts and parts are not interchangeable with new fine tool
- Good performance and convenient use of new fine tool gives customer best quality of service

Threading tool

Designation	Insert		Old parts name						New holder	Page
			Clamp	Clamp screw	Shim	Screw	C-ring	Wrench		
ETH	~ETH3**R	ECTR3***	CH5R3	CHX0513	ST32C1	SHX0310	CR04	HW20L,HW25L	ER(L)H**	D31
	~ETH4**R	ECTR4***	CH6R4	CHX0621	ST42C1	SHX0310	CR05	HW20L,HW30L		
ITH	~ITH2**R	ICTR2***	CH5R3	CHX0513	ST32C1	FTKA02565	CR04	TW07P	IR(L)H**	D32
	~ITH3**R	ICTR3***	CH5R3	CHX0513	ST32C1	SHX0310	CR04	TW15P,HW20L,HW25L		
	~ITH4**R	ICTR4***	CH6R4	CHX0621	ST42C1	SHX0310	CR05	HW20L,HW30L		

- Old inserts and parts are not interchangeable with threading holders
- Good performance and convenient use of new fine tool gives customer best quality of service

Mill-Max

Designation	Insert	Old parts name					New holder	Page
		Locator	Wedge	Wedge screw	Locator screw	Wrench		
AD(ADM)4000	SD**1203	LAS4R/L	WASR/L	WTX0817	LTX0512	TW25	ADN(ADNM)4000	E42
AD(ADM)5000	SD**1504	LAS5R/L	WASR/L	WTX0817	LTX0512	TW25	ADN(ADNM)5000+	E43
ADN(ADNM)5000	SD**1504	LADN5R/L	WEPN5R/L	DHA0821F	LTX0514	HW40		E43
EP(EPM)4000	SP**1203	LES4R/L LES4R1/L1 (Ø80 ~ Ø100)	WESR/L	WTX0817 WTX0813 (Ø80 ~ Ø100)	LTX0512	TW25	EPN(EPNM)4000	E48
EP(EPM)5000	SP**1504	LES5R/L LES5R1/L1 (Ø80 ~ Ø100)	WESR/L	WTX0817 WTX0813 (Ø80 ~ Ø100)	LTX0512	TW25	EPN(EPNM)5000+	E49
EPN(EPNM)5000	SP**1504	LEPN5R/L LEPN5R1/L1 (Ø80 ~ Ø100)	WEPN5R/L	DHA0821F DHA0817F (Ø80 ~ Ø100)	LTX0514	HW40		E49
PP(PPM)4000	TP**2204	LPT4R/L LPT4R1/L1 (Ø80 ~ Ø100)	WESR/L	WTX0817 WTX0813 (Ø80 ~ Ø100)	LTX0512	TW25	PPN(PPNM)4000	E51

- Parts are not interchangeable with new mill-max cutters
- Good performance and convenient use of new mill-max gives customer best quality of service

M Old-fashioned product information

Cen-Mill

Designation	Insert		Old parts name		New product	Page
			Screw	Wrench		
HE	Ø25	MCMT080308EN ZCMT080308ER	FTNA0307	TW09P	AMS****M	E164~E166
	Ø32, 40, 50	MCMT09T308EN ZCMT09T308ER	FTNA0408	TW15P		
LE (LEM)	LOCX1205ZZ		FTNB0411	TW15S	AMC****M	E151~E153
SE	Ø25	MPMT090308	FTNA0408	TW15S	AMS****MH	E167~E168
	Ø32, 40	MPMT120408	FTNA0513	TW20S		
TM	MIT100,150,200,300,400 MET100,150,200,300,400		FTNB0411 (TM632R) FTNA0513	TW15L (TM632R) TW20L	TMS(I)	D49
PM	EDCW1604ZDF/TR		FTNA0513	TW20L	RM4Z	E105~E106
CE (Code changed)	SPG(M)N1203**				CE45-****R-S32 (New code)	E315~E317

- Old inserts and parts are not interchangeable with new milling product
- New product : Alpha mill which has unique alpha-curve edge guarantees wide range machining and good performance.
- Good performance and convenient use of new milling tool gives customer best quality of service

Jip Drill

Designation	Insert		Old parts name		New product	Page
			Screw	Wrench		
JD	~JD200	WCMT030208-C20	FTNA02565	TW07P	K□D (KING-DRILL)	G12~G26
	~JD250	WCMT040208-C20				
	~JD300	WCMT050308-C20	FTNA0307	TW09P		
	~JD410	WCMT06T308-C20	FTGA03508			
	~JD580	WCMT080408-C20	FTNA0408	TW15P		

- Old inserts and parts are not interchangeable with new indexable drill
- Good performance and convenient use of new indexable drill gives customer best quality of service

LPD/SPD/NPD

Designation	Insert		Old parts name		New product	Page
			Screw	Wrench		
LPD	~LPD135	LPMT040203-DF	FTNA0204	TW06P	K□D (KING-DRILL)	G12~G26
SPD	~SPD155	SPM(E)T050203-DM, DF, DS, DA	FTNA0204	TW06P		
	~SPD195	SPM(E)T060204-DM, DS, DR, DA	FTKA02206S	TW07S		
	~SPD225	SPM(E)T070204-DM, DS, DR, DA	FTKA02565	TW07S		
NPD	~NPD245	NPM(E)T222408-DM, DS, DR, DA	FTKA02565	TW07S		
	~NPD285	NPM(E)T252808-DM, DS, DR, DA	FTKA0307	TW09S		
	~NPD325	NPM(E)T293208-DM, DS, DR, DA	FTKA0307	TW09S		
	~NPD405	NPM(E)T334008-DM, DS, DR, DA	FTKA03508	TW15S		
	~NPD505	NPM(E)T415008-DM, DS, DR, DA	FTKA0410	TW15S		
	~NPD605	NPM(E)T516012-DM, DS, DR, DA	FTNC04511	TW20S		

- Old inserts and parts are not interchangeable with new indexable drill
- Good performance and convenient use of new indexable drill gives customer best quality of service







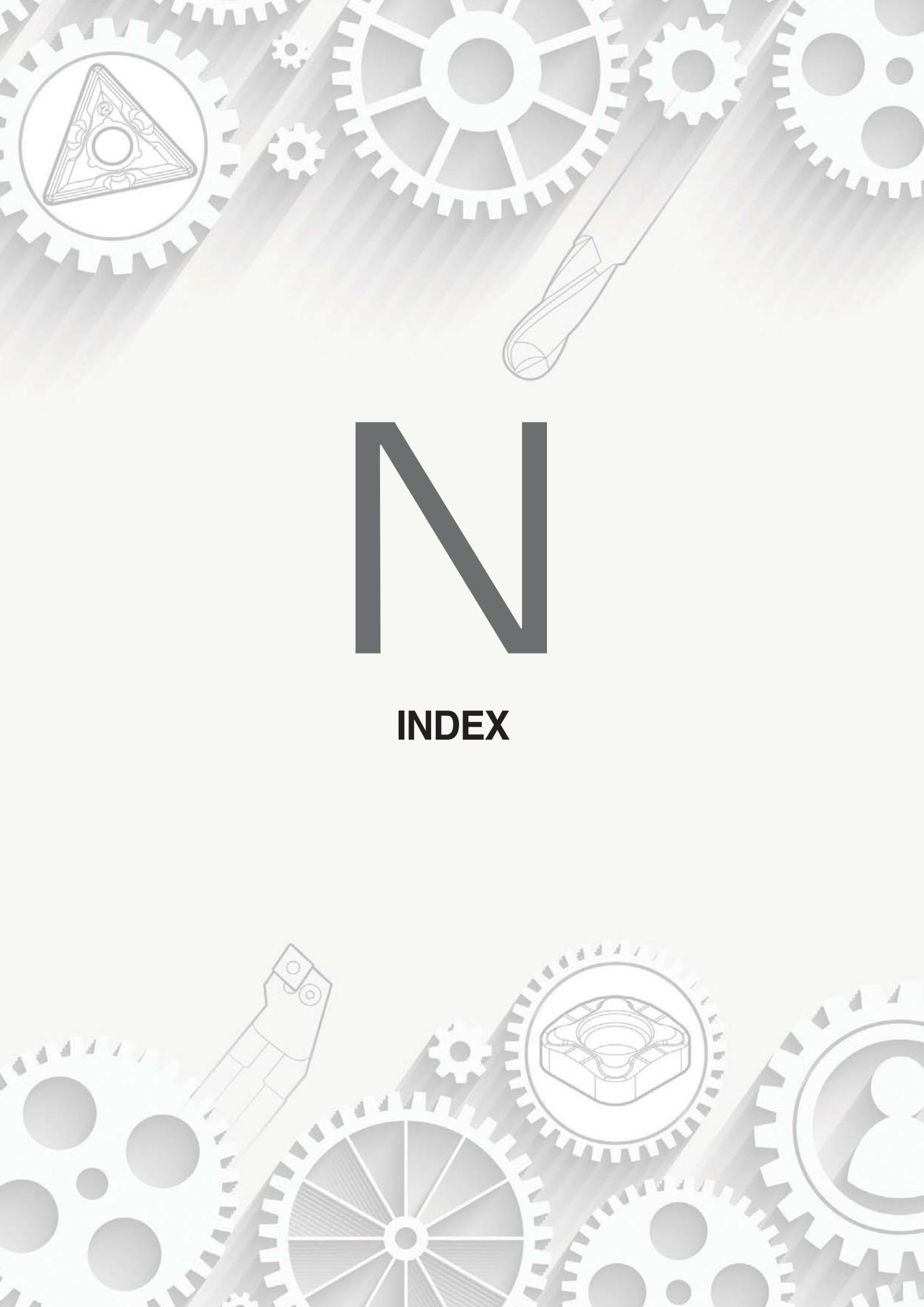

N

INDEX

N Index by items

A

A+ Endmill	Endmills	F105
Actual Designations of Milling Cutter and Arbor	Milling	E400
Aero Mill	Milling	E136
Aero Mill Mini	Milling	E139
Aero Mill Plus	Milling	E137
Alpha Mill	Milling	E154
Alpha Mill-X	Milling	E145
Aluminum Insert (Positive)	Turning	B90
American ACME	Threading	D24
American Buttress (ABUT)	Threading	D28
American UN	Threading	D16
Angular Head Series	Tooling System	I 49
API Buttress Casing (BUT)	Threading	D30
API Round Casing & Tubing (APIRD)	Threading	D30
Application Example	Multi functional Tools	C02
Application range of KORLOY Main Chip Breakers	Turning	B02
Auto Tool Bits	Brazed Tools	H10
Auto Tools (Blade Type)	Turning	B121
Auto Tools (ISO Type)	Turning	B112
Auto Tools (KGT/MGT Type)	Turning	B127
Auto Tools (MSB Tool)	Turning	B130
Auto Tools (Multi Utility Type)	Turning	B124
Available Insert	Drills	G04
Available Insert for Fine Tools	Multi functional Tools	C66
Available Insert for K Notch	Multi functional Tools	C56
Available Insert for KGT	Multi functional Tools	C12
Available Insert for MGT	Multi functional Tools	C27
Available Insert for MGT Aluminum Wheel	Multi functional Tools	C43
Available Insert for TB/TB-M	Multi functional Tools	C50
Aviation Industrial Solution	Tooling System	J14

B

Balancing System	Tooling System	I 04
Bearing Solution	Turning	B141
Bearing working Solution	Tooling System	J12
BFE	Milling	E323
Bits for Construction	Brazed Tools	H13
Block	Tooling System	J26
Boring Bar Code System (ISO)	Turning	B191
Boring Crown Blank	Brazed Tools	H13
Brake	Tooling System	J22
Brazed Endmill	Endmills	F118
BRE	Milling	E327
British Buttress (BBUT)	Threading	D28

B

British Standard Pipe Thread	Threading	D22
Broach Reamer	Drills	G121
BT Tooling System (Modular)	Milling	E205
BT Tooling System (Multi edge)	Milling	E194
BT Tooling System (Single edge)	Milling	E184
Burnishing Drill	Drills	G101

C

Carbide Drill	Drills	G99
Carbide Shank Boring Bar	Turning	B194
Carbide Tap	Threading	D65
Cartridge (Parts)	Parts	K03
Cartridge Code System (ISO)	Turning	B230
cBN inserts grades	Grades & Chip Breakers	A46
cBN Insert	Turning	B98
Cemented Carbide Blank for Cross Bits	Brazed Tools	H13
Cemented Carbide Blank for Taper Bits	Brazed Tools	H12
Cemented Carbide, Cermet Blank	Brazed Tools	H04
Cen-Mill	Old-Fashioned Product Information	M04
Center Drill	Drills	G54
Ceramic Holder	Turning	B185
Cermet grades (Milling)	Grades & Chip Breakers	A38
Cermet grades (Turning)	Grades & Chip Breakers	A20
Cermet Reamer	Drills	G120
Chamfer Tool	Milling	E335
Chip Breaker (Parts)	Parts	K03
Chip breaker for drilling	Grades & Chip Breakers	A61
Chip breaker for milling	Grades & Chip Breakers	A56
Chip breaker for turning	Grades & Chip Breakers	A52
Chip Cover	Parts	K03
Chuck Jaw	Brazed Tools	H11
Chucking/Machine Reamer	Drills	G116
Clamp (Parts)	Parts	K03
Clamp On System (Boring Bar)	Turning	B201
Clamp On System (Cartridge)	Turning	B232
Clamp On System (Holder)	Turning	B169
C-Max	Endmills	F41
Coated cermet grades (Turning)	Grades & Chip Breakers	A23
Collet Chuck Series	Tooling System	I 22
Compact Mini	Turning	B214
Composite Router Endmill	Endmills	F52
Connecting Rod	Tooling System	J24
Coolant Bolt	Parts	K04
Corrosion & Magnetism Proof Grade : IN-Series	Brazed Tools	H03



C

CPM Series	Tooling System	I 17
Crankshaft	Tooling System	J19
CVD coated grades (Milling)	Grades & Chip Breakers	A27
CVD coated grades (Turning)	Grades & Chip Breakers	A05

D

D Endmill	Endmills	F32
DAMPING PRO	Tooling System	I 74
DBC	Tooling System	I 65
DBH	Multi functional Tools	C68
DBT Series	Tooling System	I 02
DCS/DC/TC	Tooling System	I 21
Development Industrial Solution	Tooling System	J13
DHE Series	Tooling System	I 06
Diamond coated grades	Grades & Chip Breakers	A43
DLC coated grades	Grades & Chip Breakers	A44
Double Clamp System (Boring Bar)	Turning	B195
Double Clamp System (Holder)	Turning	B154
Double Mill	Milling	E59
DSC Series	Tooling System	I 10
DSK Series	Tooling System	I 31
DST Series	Tooling System	I 37
DTN Series	Tooling System	I 40

E

EH	Multi functional Tools	C71
Endmill Code System	Endmills	F02
ESD Plus	Drills	G93
EXT Bar	Tooling System	I 72
External Holder	Old-Fashioned Product Information	M02
External Holder	Threading	D31
External Tool Holder Code System (ISO)	Turning	B148
Extreme Line Casing (EL)	Threading	D30

F

F Endmill	Endmills	F26
Face Mill Arbor Series	Tooling System	I 46
FBB	Tooling System	I 64
FBH/B Series	Tooling System	I 57
Feature of Chip Breakers	Turning	B12
Features of Double Clamp/Lever Lock System	Turning	B153
Fine Tool	Old-Fashioned Product Information	M03

F

Fine Tools Holder	Multi functional Tools	C67
FMR P-positive	Milling	E248
Future Mill	Milling	E222

G

GBE	Milling	E324
Gear Cutter	Milling	E405
Gear Cutter Order Form	Milling	E413
Gear Cutter Table	Milling	E404
Gear Machining Solution	Tooling System	J02
GERC	Tooling System	I 34
GFIK	Multi functional Tools	C70
GFIP	Multi functional Tools	C69
GFT	Multi functional Tools	C69
GH	Multi functional Tools	C70
Grade	Old-Fashioned Product Information	M02
Grades system	Grades & Chip Breakers	A02
GSK Series	Tooling System	I 29
Gun Drill	Drills	G108

H

H Endmill	Endmills	F12
Hardness calculating table	Technical Information	L08
HAVE (Single edge/Multi edge)	Milling	E331
Head	Tooling System	J28
Helix Blank	Brazed Tools	H08
HFM	Milling	E273
HFMD	Milling	E264
High feed Cutter	Milling	E395
HRM	Milling	E292
HRMDouble	Milling	E281
HSK Tooling System	Tooling System	I 03
HSK Tooling System	Turning	B220
HSK Tooling System (Modular)	Milling	E206
HSK Tooling System (Multi edge)	Milling	E200
HSK Tooling System (Single edge)	Milling	E189
HSS Tap	Threading	D69

I

I⁺ Endmill	Endmills	F60
IGH	Multi functional Tools	C68
Index for Boring Bar	Turning	B192

J

N Index by items

I J

Index for Cartridge	Turning	B231
Index for External Holder	Turning	B149
Index for HSK Tooling System	Turning	B219
Index for KM Tooling System	Turning	B219
Indexable HOB	Milling	E414
Indexable HOB Order Form	Milling	E415
Indexable Reamer	Drills	G113
Instruction of Boring Bar assembly	Turning	B194
Instruction of External Holder	Turning	B152
Internal Holder	Threading	D32
ISO Metric	Threading	D12
Jip Drill	Old-Fashioned Product Information	M04

K

K Notch Holder	Multi functional Tools	C58
KGT Blade for Parting off	Multi functional Tools	C24
KGT Cartridge	Multi functional Tools	C40
KGT Holder	Multi functional Tools	C14
KGT/MGT Cartridge Holder	Multi functional Tools	C39
KHP	Turning	B117
KHP	Turning	B189
KING DRILL	Drills	G12
KING DRILL (for through coolant system with a lathe)	Drills	G22
KING DRILLI for large diameter drilling	Drills	G26
KM Tooling System	Turning	B226
KMB	Tooling System	I 66
Knuckle	Tooling System	J20
KORLOY Cutters	Milling	E32
KORLOY Endmills	Endmills	F04
KORLOY Grades	Technical Information	L37
KORLOY Modular Adaptors	Milling	E42
KORLOY Shanks	Milling	E38
KORLOY Ultra-Fine Grades : F-Series	Brazed Tools	H02
KRLOY Drills	Drills	G02

L

Laser Mill	Milling	E318
Lever (Parts)	Parts	K04
Lever Lock System (Boring Bar)	Turning	B197
Lever Lock System (Holder)	Turning	B159
Locator	Parts	K05
LPD/SPD/NPD	Old-Fashioned Product Information	M04

M

Mach long Drill plus	Drills	G84
Mach Solid Drill Plus	Drills	G59
Mach Solid Drill Plus CFRP	Drills	G72
Mach Solid Drill Plus-S	Drills	G66
Mach Solid Flat Drill	Drills	G76
Mach step Drills Order Form	Drills	G87
Metric Buttress (SAGE)/API	Threading	D29
MGT Aluminum Wheel	Multi functional Tools	C44
MGT Cartridge	Multi functional Tools	C41
MGT Holder	Multi functional Tools	C30
MGT Holder (Face Grooving)	Multi functional Tools	C35
MGT Special Order Form for MGT	Multi functional Tools	C72
Milling grade selections	Grades & Chip Breakers	A26
Milling Insert Code System (ISO)	Milling	E02
Milling Inserts	Milling	E04
Mill-max	Milling	E44
Mill-Max	Old-Fashioned Product Information	M03
Mill-max Heavy	Milling	E55
Mill-max Plus	Milling	E45, 51
Modular Adaptor	Milling	E371
Modular Arbor	Tooling System	I 70
Modular System	Tooling System	I 69
Multi Lock System (Boring Bar)	Turning	B202
Multi Lock System (Holder)	Turning	B171
Multi Turn	Turning	B139

N O

National Pipe Thread	Threading	D22
National Pipe Thread-Dry seal	Threading	D23
Nozzle	Parts	K07
NPM Series	Tooling System	I 19
NPU	Tooling System	I 39
Nut	Parts	K05
O-Ring Cutter	Milling	E333
Others	Tooling System	I 81

P

Partial Profile 55°	Threading	D11
Partial Profile 60°	Threading	D10
PCD Drill	Drills	G103
PCD Endmill	Endmills	F115
PCD Face Cutter	Milling	E141
PCD incerts grades	Grades & Chip Breakers	A51



P

PCD Insert	Turning	B102
PCD Reamer	Drills	G119
PH	Multi functional Tools	C71
Pin	Parts	K05
Pipe Industrial Solution	Tooling System	J10
Power Buster	Milling	E65
Pro-A Mill	Milling	E354
Pro-L Mill	Milling	E363
Properties of Korloy grades	Technical Information	L09
Pro-V Mill	Milling	E368
Pro-X Mill	Milling	E357
Pro-XL Mill	Milling	E367
PVD coated grades (Milling)	Grades & Chip Breakers	A29
PVD coated grades (Turning)	Grades & Chip Breakers	A15

R

R+ Endmill	Endmills	F97
Railway Industrial Solution	Tooling System	J08
RDC Bar	Tooling System	I 73
Recommended Chip Breakers for workpiece	Turning	B04
Rich Mill	Milling	E89
Ring Blank	Brazed Tools	H07
Role Machining Solution	Tooling System	J07
Rotating Brazing Tool	Brazed Tools	H14
Round bar Blank	Brazed Tools	H07
Round DIN 405	Threading	D23

S

S+ Endmill	Endmills	F91
Save Turn Boring Bar	Turning	B109
Save Turn Holder	Turning	B106
Save Turn Insert	Turning	B105
Saw man	Multi functional Tools	C60
Saw man-X	Multi functional Tools	C64
Screw	Parts	K05
Screw On System (Boring Bar)	Turning	B204
Screw On System (Cartridge)	Turning	B234
Screw On System (Holder)	Turning	B178
SDC Series	Tooling System	I 24
Shave Mill	Milling	E397
Shave Mill Ultra	Milling	E398
Shim	Parts	K02
Shim Pin	Parts	K06

S

Ship Building Industrial Solution	Tooling System	J04
SI unit conversion table	Technical Information	L07
Side Cutter	Milling	E379
Side Lock Arbor Series	Tooling System	I 44
Side Milling Cutter	Milling	E375
Sleeve	Turning	B136
Slitter Knife	Tooling System	J18
SMB	Tooling System	I 67
SMH	Tooling System	I 68
Solid drills grade selections	Grades & Chip Breakers	A41
Solid Endmill for Aluminum	Endmills	F38
Solid endmills grade selections	Grades & Chip Breakers	A39
Solid Threading Endmills	Threading	D51
Special Boring Tool Order Form	Milling	E416
Special Endmill Order Form	Endmills	F123
Special Order Form for Bearing Inserts	Turning	B147
Special Order Form for V-Pulley Insert	Multi functional Tools	C73
Special Rotating Brazing Tools Order Form	Brazed Tools	H15
Special T Endmill Order Form	Endmills	F29
Spring	Parts	K07
Square Bits	Brazed Tools	H09
Square Blank	Brazed Tools	H05
Steel, Non-ferrous metal symbol list	Technical Information	L06
Stop Ring	Parts	K07
Stopper	Parts	K07
Stub ACME	Threading	D25
Super Endmill	Endmills	F46

T

Tank Mill	Milling	E299
Taper Bits	Brazed Tools	H13
TBC/FBC Series	Tooling System	I 61
TB-MTB Holder	Multi functional Tools	C53
TCA Tap Adaptor	Tooling System	I 42
T-Cutter	Milling	E343
Technical Information for A+ Endmill	Endmills	F103
Technical Information for Aero Mill	Milling	E132
Technical Information for Aero Mill Mini	Milling	E135
Technical Information for Aero Mill Plus	Milling	E134
Technical Information for Alpha Mill/Alpha Mill Nick	Milling	E147
Technical Information for Alpha Mill-X	Milling	E142
Technical Information for Auto Tools	Turning	B111
Technical Information for Bearing Solution	Turning	B140
Technical Information for Brazed Endmill	Endmills	F116

N Index by items

T

Technical Information for BRE	Milling	E317
Technical Information for BT/HSK Tooling System	Milling	E183
Technical Information for Carbide Drill	Drills	G98
Technical Information for C-Max	Endmills	F40
Technical Information for Composite Router Endmill	Endmills	F51
Technical Information for Couple Mill	Milling	E389
Technical Information for Cube Mill	Milling	E388
Technical Information for D Endmill	Endmills	F30
Technical Information for Drills	Technical Information	L30
Technical Information for Endmills	Technical Information	L27
Technical Information for ESD Plus	Drills	G91
Technical Information for F Endmill	Endmills	F24
Technical Information for Fine Tools	Multi functional Tools	C65
Technical Information for FMR P-positive	Milling	E217
Technical Information for Future Mill	Milling	E207
Technical Information for GBE	Milling	E314
Technical Information for Gear Cutter Tools	Milling	E403
Technical Information for Gun Drill	Drills	G104
Technical Information for H Endmill	Endmills	F09
Technical Information for HAVE	Milling	E329
Technical Information for HFM	Milling	E268
Technical Information for HFMD	Milling	E260
Technical Information for High feed Cutter	Milling	E386
Technical Information for HRMDouble	Milling	E276
Technical Information for HSK	Turning	B217
Technical Information for I+ Endmill	Endmills	F57
Technical Information for Indexable Reamer	Drills	G110
Technical Information for K Notch	Multi functional Tools	C54
Technical Information for KGT	Multi functional Tools	C07
Technical Information for KGT/MGT Cartridge	Multi functional Tools	C38
Technical Information for KHP	Turning	B187
Technical Information for KING DRILL	Drills	G06
Technical Information for KING DRILL (for large diameter drilling)	Drills	G25
Technical Information for Laser Mill	Milling	E309
Technical Information for Mach long Drill Plus	Drills	G82
Technical Information for Mach Solid Drill Plus	Drills	G57
Technical Information for Mach Solid Drill Plus CFRP	Drills	G70
Technical Information for Mach Solid Drill Plus-S	Drills	G64
Technical Information for Mach Solid Flat Drill	Drills	G73
Technical Information for MGT	Multi functional Tools	C25
Technical Information for MGT Aluminum Wheel	Multi functional Tools	C42
Technical Information for Milling	Technical Information	L20
Technical Information for Mill-max Heavy	Milling	E54
Technical Information for Multi Functional Tools Series	Multi functional Tools	C04
Technical Information for Multi Turn	Turning	B137

T

Technical Information for PCD Endmill	Endmills	F114
Technical Information for Power Buster	Milling	E61
Technical Information for Pro-A Mill	Milling	E344
Technical Information for Pro-L Mill	Milling	E348
Technical Information for Pro-V Mill	Milling	E351
Technical Information for Pro-X Mill	Milling	E346
Technical Information for Pro-XL Mill	Milling	E350
Technical Information for R+ Endmill	Endmills	F92
Technical Information for Rich Mill	Milling	E68
Technical Information for S+ Endmill	Endmills	F89
Technical Information for Save Turn	Turning	B104
Technical Information for Saw man	Multi functional Tools	C59
Technical Information for Saw man-X	Multi functional Tools	C62
Technical Information for Shave Mill	Milling	E392
Technical Information for Shave Mill Ultra	Milling	E394
Technical Information for Side Milling Cutters	Milling	E373
Technical Information for Solid Endmill for Aluminum	Endmills	F37
Technical Information for Solid Threading Endmills	Threading	D50
Technical Information for Storm Mill	Milling	E391
Technical Information for Super Endmill	Endmills	F44
Technical Information for T Endmill	Endmills	F27
Technical Information for Tap Series	Threading	D61
Technical Information for Tapers	Technical Information	L24
Technical Information for TB/TB-M	Multi functional Tools	C46
Technical Information for Thread Milling	Threading	D34
Technical Information for Threading	Threading	D03
Technical Information for TP2P	Milling	E300
Technical Information for TPDB Plus	Drills	G34
Technical Information for TPDB-H	Drills	G44
Technical Information for TPDC	Drills	G27
Technical Information for Turning	Technical Information	L10
Technical Information for V Endmill	Endmills	F14
Technical Information for Vulcan Drill	Drills	G88
Technical Information for Wind Mill	Milling	E382
Technical Information for WPDC	Drills	G51
Technical Information for Z Endmill	Endmills	F17
Technical Information for Z+ Endmill	Endmills	F72
Technical Information KM Tooling System	Turning	B217
Technical information of KING DRILL (for through coolant system with a lathe)	Drills	G21
TER Tap Collet	Tooling System	I 43
The Comparison of Grade for Milling	Technical Information	L43
The Comparison of Grade for Turning	Technical Information	L42
The Comparison of Chip Breakers	Technical Information	L36
Thread Milling Holder	Threading	D49
Thread Milling Inserts	Threading	D44



T

Threading Holder Code System	Threading	D02
Threading Insert Code System	Threading	D02
Threading Insert with Chip Breaker	Threading	D09
Threading Tool	Old-Fashioned Product Information	M03
Tooling System Index	Tooling System	I 05
Top Solid Drill	Drills	G102
TP2P	Milling	E303
TPDB Plus	Drills	G38
TPDB-H	Drills	G47
TPDC	Drills	G31
Trapez DIN 103	Threading	D24
Turbo Mill	Milling	E56
Turning grade selections	Grades & Chip Breakers	A04
Turning Insert (Negative)	Turning	B28
Turning Insert (Positive)	Turning	B66
Turning Insert Code System (ISO)	Turning	B26

U

Uncoated carbide grades (Milling)	Grades & Chip Breakers	A37
Uncoated carbide grades (Turning)	Grades & Chip Breakers	A18
UNJ (Unified Constant Thread)	Threading	D26

V

V Endmill	Endmills	F16
Vertical Type Holder	Threading	D33
Vulcan Drill	Drills	G89

W

Washer	Parts	K07
Wedge Clamp System(Holder)	Turning	B167
Wind Mill	Milling	E384
With Worth	Threading	D18
Workpiece material grades	Technical Information	L02
WPDC	Drills	G55
Wrench	Parts	K07
Wrench Bolt	Parts	K04

Z

Z Endmill	Endmills	F20
Z+ Endmill	Endmills	F75

N Index by designation

A

ABUT(American Buttress) Thread Insert	D28
AD(ADM)4000 Mill Max	M03
AD(ADM)5000 Mill Max	M03
ADKA Milling insert	E04
ADKT-ML Milling insert (Alpha Mill-X)	E04
ADKT-MM Milling insert (Alpha Mill-X)	E04
ADLT Milling insert (Tank Mill)	E04
ADN(ADNM)5000 Mill Max	M03
ADN(M)4000 Mill Max	E44
ADN(M)5000+ Mill Max Plus	E45
ADS4000 Turbo Mill	E56
ADS5000 Turbo Mill	E57
AE(M)4000 Mill Max	E46
AE(M)5000 Mill Max	E47
AFE3000 A+ Endmill (Flat type)	F110
AFE3000 A+ Endmill (Long Flat type)	F111~112
AFE3000 A+ Endmill (Short Flat type)	F109
AFO(M)4000 Double Mill	E59
AFO(M)5000 Double Mill	E60
AMC(M)1000S Alpha Mill	E154
AMC(M)1000SE Alpha Mill	E160
AMC(M)1500S Alpha Mill	E155
AMC(M)2000M Alpha Mill	E162
AMC(M)2000S Alpha Mill	E156
AMC(M)2000SE Alpha Mill	E160
AMC(M)3000M Alpha Mill	E163
AMC(M)3000S Alpha Mill	E157
AMC(M)3000SE Alpha Mill	E161
AMC(M)3000S-K Alpha Mill	E158
AMC(M)4000M Alpha Mill	E164
AMC(M)4000S Alpha Mill	E159
AMM1000 Alpha Mill	E180
AMM1500 Alpha Mill	E181
AMM2000 Alpha Mill	E182
AMS1000M Alpha Mill	E175
AMS1000MH Alpha Mill	E178
AMS1000S Alpha Mill	E165
AMS1000SE Alpha Mill	E173
AMS1500M Alpha Mill	E175
AMS1500MH Alpha Mill	E178
AMS1500S Alpha Mill	E166
AMS2000M Alpha Mill	E176
AMS2000MH Alpha Mill	E179
AMS2000S Alpha Mill	E168
AMS2000SE Alpha Mill	E173

A

AMS3000MH(-K) Alpha Mill	E179
AMS3000S Alpha Mill	E169
AMS3000SE Alpha Mill	E174
AMS3000S-K Alpha Mill	E170
AMS4000M Alpha Mill	E177
AMS4000S Alpha Mill	E171
AMXCM Alpha Mill-X	E145
AMXS Alpha Mill-X	E146
APBE2000 A+ Endmill (Ball type)	F108
APD(M)-A Aero Mill	E136
APD(M)-PB Aero Mill-Plus	E137
APFE2000 A+ Endmill (Flat type)	F105
APFE3000 A+ Endmill (Flat type)	F105
API Thread Insert	D29
APIRD(API Round Casing&Tubing) Thread Insert	D30
APKT Milling Insert (Alpha Mill)	E04
APKT-MA Milling Insert (Alpha Mill)	E04
APKT-MA2 Milling Insert (Alpha Mill)	E04
APKT-MA3 Milling Insert (Alpha Mill)	E04
APKT-MF Milling Insert (Alpha Mill)	E04
APKT-MM Milling Insert (Alpha Mill)	E04
APKT-MM1 Milling Insert (Alpha Mill)	E05
APLFE2000 A+ Endmill (Long Flat type)	F107
APLFE3000 A+ Endmill (Long Flat type)	F107
APLT Milling Insert (Tank Mill)	E05
APMFE2000 A+ Endmill (Middle Flat type)	F106
APMFE3000 A+ Endmill (Middle Flat type)	F106
APMT-MA Milling Insert (Alpha Mill)	E05
APMT-MF Milling Insert (Alpha Mill)	E05
APMT-ML Milling Insert (Alpha Mill)	E05
APMT-MM Milling Insert (Alpha Mill)	E05
APMT-MN Milling Insert (Alpha Mill)	E06
APRE3000 A+ Endmill (Roughing type)	F113

B

BAMPR/L-XAF Milling Insert (Aero Mill)	E06
BAMPR/L-XAW Milling Insert (Aero Mill)	E06
BAMPR/L-XAWR Milling Insert (Aero Mill)	E06
BBUT(British Buttress) Thread Insert	D28
BDS Burnishing Drill	G101
BDT Step Burnishing Drill	G101
BF Multi functional insert (Grooving Tools)	C69
BFE BFE	E323
BLK Tooling System (Blank Tool)	I 81



B

BRE	BRE	E327
BT	Brazed Tools (Boring Crown Blank)	H13
BT30	BT Tooling System (Modular)	E205
BT30 AM1000	BT Tooling System (Multi edge)	E194
BT30 AM1000HS	BT Tooling System (Single edge)	E184
BT30 AM1500	BT Tooling System (Multi edge)	E195
BT30 AM2000	BT Tooling System (Multi edge)	E196
BT40	BT Tooling System (Modular)	E205
BT40 AM1000	BT Tooling System (Multi edge)	E194
BT40 AM1500	BT Tooling System (Multi edge)	E195
BT40 AM1500HS	BT Tooling System (Single edge)	E185
BT40 AM2000	BT Tooling System (Multi edge)	E196
BT40 AM2000HS	BT Tooling System (Single edge)	E186
BT50	BT Tooling System (Modular)	E205
BT50 AM3000	BT Tooling System (Multi edge)	E197
BT50 AM3000HS	BT Tooling System (Single edge)	E187
BT50 AM4000	BT Tooling System (Multi edge)	E198
BT50 AM4000HS	BT Tooling System (Single edge)	E188
BT50 HAT4000	BT Tooling System (Multi edge)	E199
BT-FMA	Tooling System (Damping pro)	I 76
BT-FMC	Tooling System (Damping pro)	I 77
BUT(API Buttress Casing)	Thread Insert	D30

C

CBE2000	C-Max (Ball type)	F42
CBNE2000	C-Max (Long Neck Ball type)	F42
CCDR4000	Composite Router Endmill (Flat type)	F52
CCDR6000	Composite Router Endmill (Flat type)	F52
CCET	Turning Insert_Positive (Carbide Shank Boring Bar)	B66
CCET-KF	Auto tools Insert (ISO type)	B119
CCET-KF	Auto tools Insert (ISO type)	B66
CCET-KM	Auto tools Insert (ISO type)	B119
CCET-KM	Auto tools Insert (ISO type)	B66
CCGT-AK	Aluminum Insert_Positive (Screw on System)	B91
CCGT-AR	Aluminum Insert_Positive (Screw on System)	B91
CCGT-KF	Turning Insert_Positive (Screw on System)	B67
CCGT-KM	Turning Insert_Positive (Screw on System)	B68
CCGT-VP1	Auto tools Insert (ISO type)	B119
CCGT-VP1	Turning Insert_Positive (Screw on System)	B67
CCHR4000	Composite Router Endmill (Flat type)	F53
CCHR6000	Composite Router Endmill (Flat type)	F53
CCLNR/L	Insert for Ceramic Holder	B185
CCLR4000	Composite Router Endmill (Flat type)	F55
CCMT	PCD Insert_Positive	B102

C

CCMT-C25	Turning Insert_Positive (Screw on System)	B69
CCMT-HMP	Turning Insert_Positive (Screw on System)	B69
CCMT-MP	Turning Insert_Positive (Screw on System)	B69
CCMT-VF	Turning Insert_Positive (Screw on System)	B68
CCMT-VL	Turning Insert_Positive (Screw on System)	B68
CCMT-VP1	Turning Insert_Positive (Screw on System)	B68
CCMW	cBN Insert_Positive (Regrinding)	B101
CCR2000	Composite Router Endmill (Flat type)	F54
CCRR6000	Composite Router Endmill (Flat type)	F56
CCRR8000	Composite Router Endmill (Flat type)	F56
CCT	Solid Chamfer Tool	E342
CD	Drill Insert (Center Drill)	G54
CDEW-NAF	Milling Insert (Aero Mill)	E06
CDEW-NAW	Milling Insert (Aero Mill)	E07
CDEW-XAF	Milling Insert (Aero Mill)	E07
CDEW-XAW	Milling Insert (Aero Mill)	E07
CDEW-XCF	Milling Insert (Aero Mill)	E07
CDH	Drill Insert (Center Drill)	G54
CE	Cen-mill	M04
CE	Chamfer Tool (Back & Front Chamfer)	E338
CE	Chamfer Tool (Long Chamfer)	E339
CE	Chamfer Tool (Multi-functional)	E340
CET	Solid Chamfer Tool	E341
CFE2000	C-Max (Flat type)	F41
CFNE2000	C-Max (Long Neck Flat type)	F41
CJ	Brazed Tools (Chuck jaws)	H11
CKFNR/L...RW	Bearing Solution	B144
CKGNR...RW	Bearing Solution	B144
CKJNR/L	Holder (Clamp on System)	B169
CKNNR/L	Holder (Clamp on System)	B169
CKUNR/L	Boring Bar (Clamp on System)	B201
CMSNR/L...B	Bearing Solution	B141
CMSNR/L...F	Bearing Solution	B141
CNGG-VP1	Turning Insert_Negative (Multi Lock/Lever Lock System)	B28
CNGG-VP3	Turning Insert_Negative (Multi Lock/Lever Lock System)	B28
CNHQ	Milling Insert (Side milling cutter_Tangential type)	E07
CNMA	cBN Insert_Negative(Regrinding)	B101
CNMA	Turning Insert_Negative (Multi Lock / Lever Lock System)	B28
CNMG-B25	Turning Insert_Negative (Multi Lock/Lever Lock System)	B32
CNMG-GR	Turning Insert_Negative (Multi Lock/Lever Lock System)	B33
CNMG-HA	Turning Insert_Negative (Multi Lock/Lever Lock System)	B29
CNMG-HM	Turning Insert_Negative	B30
CNMG-LP	Turning Insert_Negative (Multi Lock/Lever Lock System)	B29
CNMG-LW	Turning Insert_Negative (Multi Lock/Lever Lock System)	B32
CNMG-MK	Turning Insert_Negative (Multi Lock/Lever Lock System)	B30

N Index by designation

C

CNMG-MM	Turning Insert (SAVE TURN)	B105
CNMG-MM	Turning Insert_Negative (Multi Lock/Lever Lock System)	B31
CNMG-MP	Turning Insert (SAVE TURN)	B105
CNMG-MP	Turning Insert_Negative (Multi Lock/Lever Lock System)	B31
CNMG-RK	Turning Insert_Negative (Multi Lock/Lever Lock System)	B33
CNMG-RM	Turning Insert_Negative (Multi Lock/Lever Lock System)	B33
CNMG-VB	Turning Insert_Negative (Multi Lock/Lever Lock System)	B28
CNMG-VC	Turning Insert_Negative (Multi Lock/Lever Lock System)	B29
CNMG-VF	Turning Insert_Negative (Multi Lock/Lever Lock System)	B28
CNMG-VL	Turning Insert_Negative (Multi Lock/Lever Lock System)	B29
CNMG-VM	Turning Insert_Negative (Multi Lock/Lever Lock System)	B32
CNMG-VP1	Turning Insert_Negative (Multi Lock/Lever Lock System)	B28
CNMG-VP2	Turning Insert_Negative (Multi Lock/Lever Lock System)	B30
CNMG-VP3	Turning Insert_Negative (Multi Lock/Lever Lock System)	B32
CNMG-VP4	Turning Insert_Negative (Multi Lock/Lever Lock System)	B34
CNMG-VQ	Turning Insert (SAVE TURN)	B105
CNMG-VQ	Turning Insert_Negative (Multi Lock/Lever Lock System)	B30
CNMG-VR	Turning Insert_Negative (Multi Lock/Lever Lock System)	B34
CNMG-VW	Turning Insert_Negative (Multi Lock/Lever Lock System)	B29
CNMM	PCD Insert_Negative	B102
CNMM-GH	Turning Insert_Negative (Multi Lock / Lever Lock System)	B35
CNMM-GR	Turning Insert_Negative (Lever Lock System)	B34
CNMM-HA	Turning Insert_Negative (Lever Lock System)	B34
CNMM-VH	Turning Insert_Negative (Lever Lock System)	B35
CNMM-VT	Turning Insert_Negative (Lever Lock System)	B35
CNMX	PCD Insert_Negative	B102
CPGT	Turning Insert_Positive (Screw on System)	B70
CPGT-HMP	Turning Insert_Positive (Screw on System)	B70
CPM	Tooling System (CPM)	I 18
CPMH	Milling Insert (T-Cutter)	E07
CPMT	Milling Insert (T-Cutter)	E07
CPMT	PCD Insert_Positive	B102
CPMT-C25	Turning Insert_Positive (Screw on System)	B70
CPMT-VF	Turning Insert_Positive (Screw on System)	B70
CPMT-VL	Turning Insert_Positive (Screw on System)	B70
CRDNN	Insert for Ceramic Holder	B185
CRE2000	C-Max (Radius type)	F43
CRGNR/L	Insert for Ceramic Holder	B185
CRNE2000	C-Max (Long Neck Radius type)	F43
CSBNR/L...BS	Bearing Solution	B145
CSDNN	Insert for Ceramic Holder	B185
CSDPN	Holder (Clamp on System)	B169
CSGNR/L...RW	Bearing Solution	B144
CSKNR/L	Insert for Ceramic Holder	B186
CSKNR/L...BS	Bearing Solution	B145

C

CSKPR/L	Boring Bar (Clamp on System)	B201
CSKPR/L	Cartridge (Clamp on System)	B232
CSKPR/L	Holder (Clamp on System)	B170
CSKPR/L...B	Bearing Solution	B143
CTFNR/L	Insert for Ceramic Holder	B186
CTFPR/L	Boring Bar (Clamp on System)	B201
CTFPR/L	Cartridge (Clamp on System)	B232
CTFPR/L	Holder (Clamp on System)	B170
CTGNR/L	Insert for Ceramic Holder	B186
CTGNR/L...BS	Bearing Solution	B145
CTGPR/L	Holder (Clamp on System)	B170
CTSPR/L	Cartridge (Clamp on System)	B232
CTTPR/L	Cartridge (Clamp on System)	B233
CTWPR/L	Cartridge (Clamp on System)	B233

D

DB	Multi functional Insert (Grooving Tools)	C68
DBC	Tooling System (DBC)	I 65
DBE2000	D Endmill (Ball type)	F34~35
DBE4000	D Endmill (Ball type)	F36
DBH	Multi functional holder (Grooving Tools)	C68
DC	Multi functional Insert (Grooving Tools)	C68
DC	Tooling System	I 21
DCBNR/L	Holder (Double clamp system)	B154
DCET-KF	Auto tools Insert (ISO type)	B119
DCET-KF	Turning Insert_Positive (Screw on System)	B71
DCET-KM	Auto tools Insert (ISO type)	B119
DCET-KM	Turning Insert_Positive (Screw on System)	B71
DCGT-AK	Aluminum Insert_Positive (Screw on System)	B92
DCGT-AR	Aluminum Insert_Positive (Screw on System)	B92
DCGT-KF	Turning Insert_Positive (Screw on System)	B71
DCGT-KM	Turning Insert_Positive (Screw on System)	B72
DCGT-MS	Auto tools Insert (ISO type)	B119
DCGT-VP1	Auto tools Insert (ISO type)	B119
DCGT-VP1	Turning Insert_Positive (Screw on System)	B72
DCGW	cBN Insert_Positive (Regrinding)	B101
DCKNR/L	Holder (Double clamp system)	B154
DCLNR/L	Boring Bar (Double clamp system)	B195
DCLNR/L	Holder (Double clamp system)	B154
DCLNR/L	HSK Tooling System	B220, 224
DCLNR/L	KM Tooling System	B226
DCMNN	HSK Tooling System	B220
DCMNN	KM Tooling System	B226
DCMT	PCD Insert_Positive	B102



D

DCMT-C25	Turning Insert_Positive (Screw on System)	B73
DCMT-HMP	Turning Insert_Positive (Screw on System)	B73
DCMT-MP	Turning Insert_Positive (Screw on System)	B73
DCMT-VF	Turning Insert_Positive (Screw on System)	B72
DCMT-VL	Turning Insert_Positive (Screw on System)	B73
DCMT-VP1	Turning Insert_Positive (Screw on System)	B73
DCS	Tooling System	I 21
DDJNR/L	Holder (Double clamp system)	B155
DDJNR/L	HSK Tooling System	B220
DDJNR/L	KM Tooling System	B226
DDNNN	HSK Tooling System	B220
DDNNN	KM Tooling System	B227
DDUNR/L	Boring Bar (Double clamp system)	B195
DF	Side Cutter	E381
DFE2000	D Endmill (Flat type)	F32
DFE4000	D Endmill (Flat type)	F33
DHE	DHE Tooling System	I 07~09
DNGG-VP1	Turning Insert_Negative (Multi Lock/Lever Lock, HSK Tooling System)	B36
DNGG-VP3	Turning Insert_Negative (Multi Lock/Lever Lock, HSK Tooling System)	B36
DNMA	cBN Insert_Negative (Regrinding)	B101
DNMA	Turning Insert_Negative (Multi Lock/Lever Lock, HSK Tooling System)	B36
DNMG-B25	Turning Insert_Negative (Multi Lock/Lever Lock, HSK Tooling System)	B41
DNMG-GR	Turning Insert_Negative (Multi Lock/Lever Lock, HSK Tooling System)	B41
DNMG-HA	Turning Insert_Negative (Multi Lock/Lever Lock, HSK Tooling System)	B37
DNMG-HM	Turning Insert_Negative	B39
DNMG-LP	Turning Insert_Negative (Multi Lock/Lever Lock, HSK Tooling System)	B38
DNMG-LW	Turning Insert_Negative (Multi Lock/Lever Lock, HSK Tooling System)	B40
DNMG-MK	Turning Insert_Negative (Multi Lock/Lever Lock, HSK Tooling System)	B39
DNMG-MM	Turning Insert_Negative (Multi Lock/Lever Lock, HSK Tooling System)	B39
DNMG-MM	Turning Insert_SAVE TURN	B105
DNMG-MP	Turning Insert_Negative (Multi Lock/Lever Lock, HSK Tooling System)	B39
DNMG-MP	Turning Insert_SAVE TURN	B105
DNMG-RK	Turning Insert_Negative (Multi Lock/Lever Lock, HSK Tooling System)	B41
DNMG-RM	Turning Insert_Negative (Multi Lock/Lever Lock, HSK Tooling System)	B42
DNMG-VB	Turning Insert_Negative (Multi Lock/Lever Lock, HSK Tooling System)	B36
DNMG-VC	Turning Insert_Negative (Multi Lock/Lever Lock, HSK Tooling System)	B38
DNMG-VF	Turning Insert_Negative (Multi Lock/Lever Lock, HSK Tooling System)	B37
DNMG-VL	Turning Insert_Negative (Multi Lock/Lever Lock, HSK Tooling System)	B37
DNMG-VM	Turning Insert_Negative (Multi Lock/Lever Lock, HSK Tooling System)	B40
DNMG-VP1	Turning Insert_Negative (Multi Lock/Lever Lock, HSK Tooling System)	B37
DNMG-VP2	Turning Insert_Negative (Multi Lock/Lever Lock, HSK Tooling System)	B38
DNMG-VP3	Turning Insert_Negative (Multi Lock/Lever Lock, HSK Tooling System)	B40
DNMG-VP4	Turning Insert_Negative (Multi Lock/Lever Lock, HSK Tooling System)	B42
DNMG-VQ	Turning Insert_Negative (Multi Lock/Lever Lock, HSK Tooling System)	B38
DNMG-VQ	Turning Insert_SAVE TURN	B105

D

DNMG-VR	Turning Insert_Negative (Multi Lock/Lever Lock, HSK Tooling System)	B42
DNMG-VW	Turning Insert_Negative (Multi Lock/Lever Lock, HSK Tooling System)	B37
DNMM	PCD Insert_Negative/Positive	B102
DNMX	PCD Insert_Negative/Positive	B102
DNMX-SH	Turning Insert_Negative (Multi Lock/Lever Lock, HSK Tooling System)	B42
DNMX-SR	Turning Insert_Negative	B42
DSBNR/L	Holder (Double clamp system)	B155
DSC	Tooling System (DSC series)	I 11~16
DSDNN	Holder (Double clamp system)	B156
DSK	Tooling System (BT-DSK)	I 32~33
DSKNR/L	Boring Bar (Double clamp system)	B195
DSKNR/L	Holder (Double clamp system)	B156
DSSNR/L	Holder (Double clamp system)	B156
DST	Tooling System (DST series)	I 38~39
DTFNR/L	Boring Bar (Double clamp system)	B196
DTFNR/L	Holder (Double clamp system)	B157
DTGNR/L	Holder (Double clamp system)	B157
DTN	Tooling System (DTN series)	I 41
DVJNR/L	Holder (Double clamp system)	B157
DVVNN	Holder (Double clamp system)	B158
DWLNRL	Boring Bar (Double clamp system)	B196
DWLNRL	Holder (Double clamp system)	B158

E

EF(M)4000	Mill-max	E48
EH	Multi functional (Parting off Tools)	C71
EL(Extreme Line Casing)	Thread Insert	D30
EN(M)4000	Mill-Max	E49
EP(M)4000	Mill-Max	M03
EP(M)5000	Mill-Max	M03
EPN(M)4000	Mill-Max	E50
EPN(M)5000	Mill-Max	M03
EPN(M)5000+	Mill Max Plus	E51
ER	Tooling System (ER Collet)	I 35
ER(L)	Thread Insert	D10~30
ER(L)H	Thread External Holder (Screw on System)	D31
ER(L)H-C	Thread External Holder (Clamp on System)	D31
ER(M)	Thread Insert	D10~13
ESB	Multi functional Insert (Parting off Tools)	C71
ESDP	ESD Plus	G93~97
EV2525R/L-105-3	HSK Tooling System	B225
EV2525R/L-112	HSK Tooling System	B225
EV2525R/L-115	HSK Tooling System	B225
EXT	Tooling System (Extension Bar)	I 72

N Index by designation

F

FBB	Tooling System (FBB Bite)	I 64
FBC	Tooling System (FBC)	I 63
FBH	Tooling System (FBH series)	I 58~60
FGD	MGT Insert	C27
FGHH	MGT Holder (Face Grooving)	C36
FGM	MGT Insert	C27
FGVH	MGT Holder (Face Grooving)	C37
FMA	Tooling System (FMA series)	I 46
FMAC(M)3000	Future Mill	E222
FMAC(M)3000-A	Future Mill (Aluminum body)	E224
FMAC(M)4000	Future Mill	E223
FMAC(M)4000-A	Future Mill (Aluminum body)	E225
FMAS3000	Future Mill	E226
FMAS4000	Future Mill	E227
FMC	Tooling System (FMC series)	I 47~48
FME4000	F Endmill (Standard)	F26
FMLE4000	F Endmill (Long)	F26
FMM	MGT Insert	C27
FMPC(M)3000	Future Mill	E228
FMPC(M)3000-A	Future Mill (Aluminum body)	E230
FMPC(M)4000	Future Mill	E229
FMPC(M)4000-A	Future Mill (Aluminum body)	E231
FMPS3000	Future Mill	E232
FMPS4000	Future Mill	E233
FMRC(M)3000	Future Mill	E234
FMRC(M)4000	Future Mill	E235
FMRC(M)4000	Future Mill_P-Positive	E249
FMRC(M)5000	Future Mill	E236
FMRC(M)5000	Future Mill_P-Positive	E250
FMRC(M)6000	Future Mill	E237
FMRC(M)6000	Future Mill_P-Positive	E251
FMRCM3000	Future Mill_P-Positive	E248
FMRM1000	Future Mill	E244
FMRM1500	Future Mill	E244
FMRM2000	Future Mill	E245
FMRM2500	Future Mill	E245
FMRM2500	Future Mill_P-Positive	E256
FMRM3000	Future Mill	E246
FMRM3000	Future Mill_P-Positive	E257
FMRM4000	Future Mill	E247
FMRM4000	Future Mill_P-Positive	E258
FMRM5000	Future Mill	E247
FMRM5000	Future Mill_P-Positive	E259
FMRS1000	Future Mill	E238
FMRS1500	Future Mill	E238

F

FMRS2000	Future Mill	E239
FMRS2500	Future Mill	E239
FMRS2500	Future Mill_P-Positive	E252
FMRS3000	Future Mill	E240
FMRS3000	Future Mill_P-Positive	E253
FMRS4000	Future Mill	E241
FMRS4000	Future Mill_P-Positive	E254
FMRS5000	Future Mill	E242
FMRS5000	Future Mill_P-Positive	E255
FMRS6000	Future Mill	E243
FMRS6000	Future Mill_P-Positive	E255

G

GBE	GBE (Single edge type)	E324
GBEM	GBE (Modular type)	E326
GBE-M	GBE (Multi edge type)	E325
GERC	Tooling System (GERC Collet)	I 35
GFIK	Multi functional holder (Grooving Tools)	C70
GFIP	Multi functional holder (Grooving Tools)	C69
GFT	Multi functional holder (Grooving Tools)	C69
GH	Multi functional holder (Grooving Tools)	C70
GO	Multi functional Insert (Grooving Tools)	C70
GR	Multi functional Insert (Grooving Tools)	C70
GS	Multi functional Insert (Grooving Tools)	C70
GSK	Tooling System (GSK series)	I 29~30
GW	Multi functional Insert (Grooving Tools)	C69

H

HAVE	HAVE (Multi Edge)	E331
HAVE	HAVE (Single Edge)	E332
HBRE	Broach Reamer	G121
HC	Tooling System (HC slim collet)	I 35
HDDCM7000	Mill Max Heavy	E55
HDDCM9000	Mill Max Heavy	E55
HE	Cen-Mill	M04
HECN	Milling Insert (High feed Cutter)	E07
HFMDCM-LN06	HFMD cutter	E266
HFMDM-LN06	HFMD modular	E267
HFMDS-LN06	HFMD shank	E264
HFMM	HFM modular	E275
HFMS1000	HFM shank	E273
HPEN	Milling Insert (High feed Cutter)	E07
HPEN-WC	Milling Insert (High feed Cutter)	E07



H

HRAG	Tooling System (Angular Head Series)	I 52
HRMC(M)13	HRM	E292
HRMC(M)15	HRM	E293
HRMDC(M)09	HRMDouble	E281
HRMDC(M)13	HRMDouble	E282
HRMDC(M)16	HRMDouble	E283
HRMDM 06	HRMDouble	E289
HRMDM 09	HRMDouble	E290
HRMDM 13	HRMDouble	E291
HRMDS06	HRMDouble	E284
HRMDS09	HRMDouble	E285
HRMDS13	HRMDouble	E287
HRMM08	HRM	E297
HRMM10	HRM	E298
HRMM13	HRM	E298
HRMS 08	HRM	E294
HRMS 10	HRM	E294
HRMS 13	HRM	E295
HRMS 15	HRM	E296
HSK100A	HSKTooling System (Modular)	E206
HSK100A AM3000	HSKTooling System (Multi edge)	E203
HSK100A AM4000	HSKTooling System (Multi edge)	E204
HSK63A	HSKTooling System (Modular)	E206
HSK63A AM1000	HSKTooling System (Multi edge)	E200
HSK63A AM1000HS	HSKTooling System (Single edge)	E189
HSK63A AM1500	HSKTooling System (Multi edge)	E201
HSK63A AM1500HS	HSKTooling System (Single edge)	E190
HSK63A AM2000	HSKTooling System (Multi edge)	E202
HSK63A AM2000HS	HSKTooling System (Single edge)	E191
HSK63A AM3000HS	HSKTooling System (Single edge)	E192
HSK63A AM4000HS	HSKTooling System (Single edge)	E193
HSK63A/100A PAX5000	Pro-X Mill	E362
HSK-FMA	Tooling System (Damping pro)	I 78
HSK-FMC	Tooling System (Damping pro)	I 79
HSK-XD19	Pro-V Mill	E370
HT	Tooling System (Other)	I 81

I

IG	Multi functional Insert (Grooving Tools)	C68
IGH	Multi functional holder (Grooving Tools)	C68
IPBE2000	I+ Endmill (Ball type)	F64
IPBE4000	I+ Endmill (Ball type)	F66
IPFE2000	I+ Endmill (Flat type)	F60
IPFE4000	I+ Endmill (Flat type)	F62

I

IPLBE2000	I+ Endmill (Long Ball type)	F65
IPLFE2000	I+ Endmill (Long Flat type)	F61
IPLFE4000	I+ Endmill (Long Flat type)	F63
IPLRE2000	I+ Endmill (Long Radius type)	F69
IPLRE4000	I+ Endmill (Long Radius type)	F71
IPRE2000	I+ Endmill (Radius type)	F67~68
IPRE4000	I+ Endmill (Radius type)	F70
IR(L)	Thread Insert	D10~30
IR(L)H	Thread Internal Holder (Screw on System)	D32
IR(L)H-C	Thread Internal Holder (Clamp on System)	D32
IR(M)	Thread Insert	D10~11
IRB	Indexable Reamer (Stuffed hole)	G115
IRT	Indexable Reamer (Throughout hole)	G114

J

JD	Jip drill	M04
-----------	-----------	------------

K

K2D	KING DRILL (for large diameter drilling)-2D	G26
K2D	KING DRILL (for through coolant system with a lathe)-2D	G22
K2D	KING DRILL-2D	G12~13
K3D	KING DRILL (for large diameter drilling)-3D	G26
K3D	KING DRILL (for through coolant system with a lathe)-3D	G23
K3D	KING DRILL-3D	G14~16
K3D*	KING DRILL (for machining a tap foundation hole)-3D	G14~15
K4D	KING DRILL (for large diameter drilling)-4D	G26
K4D	KING DRILL (for through coolant system with a lathe)-4D	G24
K4D	KING DRILL-4D	G17~18
K5D	KING DRILL-5D	G19~20
KAC	Tooling System (Angular Head Series)	I 56
KAG	Tooling System (Angular Head Series)	I 54
KAH	Tooling System (Angular Head Series)	I 55
KCER/L	Multi functional (KGT Cartridge)	C40
KCFR/L	Multi functional (KGT Cartridge)	C40
KCP	Tooling System (Others)	I 82
KCR	Cermet Reamer	G120
KEL-ANN	Milling insert (Storm Mill)	E08
KEL-MF	Milling insert (Gear cutter)	E08
KEL-QNN	Milling insert (Storm Mill)	E08
KGDS	Gun Drill (Single Lip type)	G108
KGDT	Gun Drill (Twin Lip type)	G109
KGEHR/L	Multi functional (KGT Holder)	C14
KGEHR/L-D00A	Multi functional (Auto Tool Holder)	C16

N Index by designation

K

KGEHR/L-D00B	Multi functional (Auto Tool Holder)	C16
KGEHR/L-DOOA	Auto tools (KGT type)	B128
KGEHR/L-DOOB	Auto tools (KGT type)	B128
KGEHR/L-T00	Multi functional (KGT Holder)	C17
KGEUR/L	Multi functional (KGT Holder)	C19
KGEVR/L-T00	Multi functional (KGT Holder)	C18
KGFHR/L	Multi functional (KGT Holder)	C21
KGFVR/L	Multi functional (KGT Holder)	C20
KGGN-A	Multi functional Insert (KGT series)	C13
KGGN-B	Multi functional Insert (KGT series)	C13
KGGN-R	Multi functional Insert (KGT series)	C13
KGIUR/L	Multi functional (KGT Holder)	C22
KGIVR/L	Multi functional (KGT Holder)	C23
KGMI-T	Multi functional Insert (KGT series)	C12
KGML-LP	Auto tools Insert (KGT type)	B129
KGML-LP	Multi functional Insert (KGT series)	C13
KGML-RP	Auto tools Insert (KGT type)	B129
KGML-RP	Multi functional Insert (KGT series)	C13
KGMN-C	Auto tools Insert (KGT type)	B129
KGMN-L	Auto tools Insert (KGT type)	B128
KGMN-L	Multi functional Insert (KGT series)	C12
KGMN-R	Auto tools Insert (KGT type)	B128
KGMN-R	Multi functional Insert (KGT series)	C12
KGMN-T	Auto tools Insert (KGT type)	B128
KGMN-T	Multi functional Insert (KGT series)	C12
KGMR-LP	Auto tools Insert (KGT type)	B128
KGMR-LP	Multi functional Insert (KGT series)	C12
KGMR-RP	Auto tools Insert (KGT type)	B129
KGMR-RP	Multi functional Insert (KGT series)	C12
KGTB	KGT Blade for Parting off	C24
KHU	Tooling System (Angular Head Series)	I 53
KMB	Tooling System (KMB)	I 66
KM-DCLNR/L	KM Tooling System	B229
KNB	Multi functional Insert (K Notch, Metric)	C56
KNG	Multi functional Insert (K Notch, Inch)	C57
KNG	Multi functional Insert (K Notch, Metric)	C56
KNGP	Multi functional Insert (K Notch, Inch)	C57
KNGP	Multi functional Insert (K Notch, Metric)	C56
KNR	Multi functional Insert (K Notch, Inch)	C57
KNRP	Multi functional Insert (K Notch, Inch)	C57
KNSR	Multi functional (K Notch Holder)	C58
KNT	Multi functional Insert (K Notch, Threading)	C56
KNUX-11	Turning Insert_Negative (Clamp on System)	B43
KNUX-12	Turning Insert_Negative (Clamp on System)	B43
KRGN-A	Multi functional Insert (KGT series)	C13

K

KRMI-C	Auto tools Insert (KGT type)	B129
KRMN-C	Multi functional Insert (KGT series)	C12
KRMN-C	Multi functional Insert (KGT series)	C12
KSPB	Multi functional (Saw Man-X, Blade)	C64

L

LBE08/10/12/16/20/25/30/32	Laser Mill (Carbide Shank-Ball, Straight type)	E318
LBE08/10/12/16/20/25/30/32	Laser Mill (Steel Shank-Ball, Taper type)	E319
LBE12/16/20/25/30/32	Laser Mill (Steel Shank-Ball, Straight type)	E319
LBE-MHD	Laser Mill (Modular type)	E322
LBH	Milling Insert (Laser Mill)	E08
LBH-KF	Milling Insert (Laser Mill)	E08
LBH-KH	Milling Insert (Laser Mill)	E08
LBS	Milling Insert (Laser Mill)	E09
LCF	Milling Insert (Laser Mill)	E09
LDET	Milling Insert (Pro-L Mill)	E10
LE(M)	Cen-mill	M04
LFH	Milling Insert (Laser Mill)	E09
LNCS	Milling Insert (Rich Mill)	E10
LNE	Milling Insert (Gear cutter)	E10
LNEX-MA	Milling Insert (Rich Mill)	E11
LNEX-MF	Milling Insert (Rich Mill)	E11
LNEX-MM	Milling Insert (Rich Mill)	E11
LNKT	Milling Insert (TP2P)	E10
LNMX-MF	Milling Insert (HFMD)	E11
LNMX-MF	Milling Insert (Rich Mill)	E11
LNMX-ML	Milling Insert (HFMD)	E11
LNMX-MM	Milling Insert (HFMD)	E11
LNMX-MM	Milling Insert (Rich Mill)	E11
LPD	LPD	M04
LPEW	Milling Insert (HFM)	E11
LPMT-MF	Milling Insert (HFM)	E12
LPMW	Milling Insert (HFM)	E12
LR	Milling Insert (Laser Mill)	E09
LRE10/12	Laser Mill (Steel Shank-Corner R, Taper type)	E321
LRE10/12/16/20/25/30/32	Laser Mill (Carbide Shank-Corner R, Straight type)	E320
LRE12/16/25/30/32	Laser Mill (Steel Shank-Corner R, Straight type)	E321
LRH	Milling Insert (Laser Mill)	E09
LXET-MA	Milling Insert (Pro-L Mill)	E12
LXET-ML	Milling Insert (Pro-L Mill)	E12

M

MAH	Tooling System (Angular Head Series)	I 51
------------	--------------------------------------	-------------



M

MAPD000HR/L-Z0	Aero Mill-Mini	E140
MAPDS000HR/L-Z0	Aero Mill-Mini	E139
MAT	Modular Adaptor (Steel Shank)	E371
MAT-C	Modular Adaptor (Carbide Shank)	E372
MBBR	Auto tools (MSB Tools_Back Boring)	B133
MBCR	Auto tools (MSB Tools_Copying)	B132
MBFR	Auto tools ((MSB Tools_Chamfering)	B133
MBR	Auto tools ((MSB Tools_Boring)	B132
MC	Multi functional Insert (Bearing Solution)	B141
MCER/L	HSK Tooling System (Cartridge)	B223
MCER/L	KM Tooling System (Cartridge)	B229
MCER/L	Multi functional (MGT Cartridge)	C41
MCFR/L	HSK Tooling System (Cartridge)	B224
MCFR/L	Multi functional (MGT Cartridge)	C41
MCHR/L	HSK Tooling System	B223
MCHR/L	KM Tooling System	B228
MCHR/L	Multi functional (MGT Cartridge Holder)	C39
MCKNR/L	Holder (Multi Lock System)	B171
MCLNR/L	Boring Bar (Multi Lock System)	B202
MCLNR/L	Holder (Multi Lock System)	B171
MCMNN	Holder (Multi Lock System)	B171
MCRNR/L	Holder (Multi Lock System)	B172
MCVR/L	Multi functional (MGT Cartridge Holder)	C39
MD	Tooling System (Modular System)	I 70~71
MDJNR/L	Holder (Multi Lock System)	B172
MDNNN	Holder (Multi Lock System)	B172
MDQNR/L	Holder (Multi Lock System)	B173
MDUNR/L	Boring Bar (Multi Lock System)	B202
MFMN	Multi functional Insert (MGT Cartridge, MGT)	C27
MGEHR/L	Auto tools (MGT type)	B129
MGEHR/L	Multi functional (MGT for Aluminum Wheel)	C44
MGEHR/L	Multi functional (MGT Holder)	C30
MGEHR/L-15	Multi functional (MGT for Aluminum Wheel)	C44
MGEUR/L	Multi functional (MGT Holder)	C31
MGEVR/L	Multi functional (MGT Holder)	C32
MGEXR/L	Multi functional (MGT for Aluminum Wheel)	C45
MGFHR/L	Multi functional (MGT Holder)	C35
MGFR	Auto tools (MSB Tools_Face Grooving)	B135
MGFVR/L	Multi functional (MGT Holder)	C35
MGGN-A	Multi functional Insert (MGT Cartridge, MGT)	C28
MGGN-M	Multi functional Insert (MGT Cartridge, MGT)	C27
MGIUR/L	Multi functional (MGT Holder)	C33
MGIUR/L-MR	Multi functional (MGT for Aluminum Wheel)	C44
MGIUR/L-MV	Multi functional (MGT for Aluminum Wheel)	C45
MGIVR/L	Multi functional (MGT Holder)	C34

M

MGIXR/L-MR	Multi functional (MGT for Aluminum Wheel)	C45
MGML-PS	Multi functional Insert (MGT Cartridge, MGT)	C29
MGML-PT	Multi functional Insert (MGT Cartridge, MGT)	C29
MGMN-G	Auto tools Insert (MGT type)	B129
MGMN-G	Multi functional Insert (MGT Cartridge, MGT)	C27
MGMN-L	Multi functional Insert (MGT Cartridge, MGT)	C28
MGMN-M	Auto tools Insert (MGT type)	B129
MGMN-M	Multi functional Insert (MGT Cartridge, MGT)	C27
MGMN-R	Multi functional Insert (MGT Cartridge, MGT)	C28
MGMN-T	Multi functional Insert (MGT Cartridge, MGT)	C28
MGMR/L-PS	Multi functional Insert (MGT Cartridge, MGT)	C29
MGMR/L-PT	Multi functional Insert (MGT Cartridge, MGT)	C29
MGR	Auto tools (MSB Tools_Square Grooving)	B134
MGRR	Auto tools (MSB Tools_Round Grooving)	B135
MLD	Mach long Solid Drill Plus	G84~86
MPMT	Milling Insert	E13
MRGN-A	Multi functional (MGT for Aluminum Wheel)	C43
MRGN-A	Multi functional Insert (MGT Cartridge, MGT)	C29
MRMN-M	Multi functional Insert (MGT Cartridge, MGT)	C29
MSBNR/L	Holder (Multi Lock System)	B173
MSDNN	Holder (Multi Lock System)	B173
MSDP(H)	Mach Solid Drill Plus	G59~63
MSDP-5C	Mach Solid Drill Plus CFRP	G72
MSDPH-S	Mach Solid Drill Plus-S	G66~69
MSFD-2P	Mach Solid flat Drill	G76~78
MSFDH-3P	Mach Solid flat Drill	G79~81
MSKNR/L	Boring Bar (Multi Lock System)	B202
MSKNR/L	Holder (Multi Lock System)	B174
MSRNR/L	Holder (Multi Lock System)	B174
MSSNR/L	Holder (Multi Lock System)	B175
MT	Multi functional (Multi Turn)	B139
MTENN	Holder (Multi Lock System)	B175
MTFNR/L	Boring Bar (Multi Lock System)	B203
MTFNR/L	Holder (Multi Lock System)	B175
MTGNR/L	Holder (Multi Lock System)	B176
MTJNR/L	Holder (Multi Lock System)	B176
MTR	Auto tools (MSB Tools_Threading)	B136
MVGN	Multi functional Insert (MGT for Aluminum Wheel)	C43
MVJNR/L	Holder (Multi Lock System)	B176
MVQNR/L	Holder (Multi Lock System)	B177
MVUNR/L	Boring Bar (Multi Lock System)	B203
MVVNN	Holder (Multi Lock System)	B177
MWLN/L	Boring Bar (Multi Lock System)	B203
MWLN/L	Holder (Multi Lock System)	B177

N Index by designation

N

NFTFR/L	Multi functional Insert (Fine Tools)	C67
NFTGR/L	Multi functional Insert (Fine Tools)	C66
NFTIH	Multi functional (Fine Tools Holder)	C67
NFTTR/L	Multi functional Insert (Fine Tools)	C66
NPD	NPD	M04
NPM	Tooling System (NPM series)	I 20
NU-CCGW	cBN Insert_Positive (Multi-Corner Type)	B99
NU-CNGA	cBN Insert_Negative (Multi-Corner Type)	B98
NU-CNMA	cBN Insert_Negative (Multi-Corner Type)	B98
NU-DCGW	cBN Insert_Positive (Multi-Corner Type)	B99
NU-DNGA	cBN Insert_Negative (Multi-Corner Type)	B98
NU-SNGA	cBN Insert_Negative (Multi-Corner Type)	B98
NU-TCGW	cBN Insert_Positive (Multi-Corner Type)	B99
NU-TNGA	cBN Insert_Negative (Multi-Corner Type)	B98
NU-TPGB	cBN Insert_Positive (Multi-Corner Type)	B100
NU-TPGN	cBN Insert_Positive (Multi-Corner Type)	B100
NU-TPGW	cBN Insert_Positive (Multi-Corner Type)	B100
NU-VBGW	cBN Insert_Positive (Multi-Corner Type)	B100
NU-VCGW	cBN Insert_Positive (Multi-Corner Type)	B100
NU-VNGA	cBN Insert_Negative (Multi-Corner Type)	B98

O

OFCN	Milling Insert (Double Mill)	E13
OFCW	Milling Insert (Double Mill)	E13
OFKR-MA	Milling Insert (Double Mill)	E13
OFKR-MF	Milling Insert (Double Mill)	E13
OFKR-MM	Milling Insert (Double Mill)	E13
OFKT-MA	Milling Insert (Double Mill)	E13
OFKT-MF	Milling Insert (Double Mill)	E13
OFKT-MM	Milling Insert (Double Mill)	E14
ONHX-MA	Milling Insert (Rich Mill)	E14
ONHX-MF	Milling Insert (Rich Mill)	E14
ONHX-ML	Milling Insert (Rich Mill)	E14
ONHX-MM	Milling Insert (Rich Mill)	E14
ONHX-W	Milling Insert (Rich Mill)	E14
ONMX-MF	Milling Insert (Rich Mill)	E14
ONMX-MM	Milling Insert (Rich Mill)	E14
ORC	O-Ring Cutter	E334
ORG	Milling Insert (O-Ring Cutter)	E14

P

PAC(M)2000	Pro-A Mill	E354
PAC(M)4000	Pro-A Mill	E354

P

PALCM	Pro-L Mill	E363
PALS	Pro-L Mill (Multi Edge)	E366
PALS	Pro-L Mill (Single Edge)	E364
PAM2000	Pro-A Mill	E356
PAS2000	Pro-A Mill	E355
PAS4000	Pro-A Mill	E355
PAVCM-XD19	Pro-V Mill	E368
PAVS-XD19	Pro-V Mill	E369
PAXC(M)5000	Pro-X Mill	E357
PAXC(M)6000	Pro-X Mill	E358
PAXM5000	Pro-X Mill	E361
PAXS5000	Pro-X Mill	E359
PAXS6000	Pro-X Mill	E360
PBAC(M)5000	Power Buster	E65
PBE2000	H Endmill (Ball type)	F12
PBPCM6000	Power Buster	E67
PBX100	Brazed Tools (Auto Tools Bits)	H10
PBZC(M)5000	Power Buster	E66
PCBNR/L	Holder (Lever Lock System)	B159
PCBNR/L	Holder (SAVE TURN)	B106
PCKNR/L	Holder (Lever Lock System)	B159
PCLNR	Holder (KHP)	B189
PCLNR/L	Boring Bar (Lever Lock System)	B197
PCLNR/L	Boring Bar (SAVE TURN)	B109
PCLNR/L	Holder (Lever Lock System)	B160
PCLNR/L	Holder (SAVE TURN)	B106
PCLNR/L	HSK Tooling System	B221
PCLNR/L	KM Tooling System	B227
PCMNN	HSK Tooling System	B221
PCMNN	KM Tooling System	B227
PDD	PCD Drill	G103
PDE1000	PCD Endmill (Flat type)	F115
PDE2000	PCD Endmill (Flat type)	F115
PDF	PCD Face Cutter	E141
PDJNR	Holder (KHP)	B189
PDJNR/L	Holder (Lever Lock System)	B160
PDJNR/L	Holder (SAVE TURN)	B106
PDJNR/L	HSK Tooling System	B221
PDJNR/L	KM Tooling System	B228
PDNNN	HSK Tooling System	B221
PDNNN	KM Tooling System	B228
PDNNR/L	Holder (Lever Lock System)	B161
PDNNR/L	Holder (SAVE TURN)	B107
PDQNR/L	Holder (SAVE TURN)	B107
PDR	PCD Reamer	G119



P

PDSNR/L	Boring Bar (Lever Lock System)	B197
PDUNR/L	Boring Bar (Lever Lock System)	B198
PDUNR/L	Boring Bar (SAVE TURN)	B109
PDZNR/L	Boring Bar (SAVE TURN)	B110
PES2000	Turbo Mill	E58
PES3000	Turbo Mill	E58
PES4000	Turbo Mill	E58
PF(M)4000	Mill-Max	E52
PH	Multi functional (Parting off Tools)	C71
PM	Cen-mill	M04
PNEJ	Milling Insert (Side Cutter)	E15
PNEJ-C	Milling Insert (Side Cutter)	E15
PNH4000	High feed Cutter	E395
PNH5000	High feed Cutter	E395
POB	Multi functional Insert (Parting off Tools)	C71
PP(M)4000	Mill-Max	M03
PPH4000	High feed Cutter	E396
PPN(M)4000	Mill-Max	E53
PRDCN	Holder (Lever Lock System)	B162
PRDCN	HSK Tooling System	B222
PRE4000	H Endmill (Radius type)	F13
PRGCR/L	Holder (Lever Lock System)	B162
PRGCR/L	HSK Tooling System	B222
PSBNR/L	Holder (Lever Lock System)	B163
PSBNR/L	Holder (SAVE TURN)	B107
PSDNN	Holder (Lever Lock System)	B163
PSDNN	Holder (SAVE TURN)	B108
PSKNR/L	Boring Bar (Lever Lock System)	B199
PSKNR/L	Boring Bar (SAVE TURN)	B110
PSKNR/L	Holder (Lever Lock System)	B164
PSKNR/L	Holder (SAVE TURN)	B108
PSSNR	Holder (KHP)	B189
PSSNR/L	Holder (Lever Lock System)	B164
PSSNR/L	Holder (SAVE TURN)	B108
PT	Tap Series (Point Tap)	D70
PTFNR/L	Boring Bar (Lever Lock System)	B199
PTFNR/L	Holder (Lever Lock System)	B165
PTGNR/L	Holder (Lever Lock System)	B165
PTTNR/L	Holder (Lever Lock System)	B166
Pull Stud Bolt	Tooling System (Others)	I 83
PWLNR	Holder (KHP)	B190
PWLNR/L	Boring Bar (Lever Lock System)	B200
PWLNR/L	Boring Bar (SAVE TURN)	B110
PWLNR/L	Holder (Lever Lock System)	B166
PWLNR/L	Holder (SAVE TURN)	B109

P

PXL(S)	Pro-XL Mill	E367
---------------	-------------	-------------

Q

QCGT	Multi functional Insert (Multi Turn)	B139
QCMT	Multi functional Insert (Multi Turn)	B139

R

RAFCB	Side Milling Cutter (Radial type-Full side cutter)	E377
RAFCP	Side Milling Cutter (Radial type-Full side cutter)	E377
RAHCB	Side Milling Cutter (Radial type-Half side cutter)	E378
RAHCP	Side Milling Cutter (Radial type-Half side cutter)	E378
RB	Brazed Tools (Square Blank)	H05
RC	Milling Insert (BFE)	E15
RCGT-AK	Aluminum Insert_Positive (Screw on System)	B93
RCGT-AR	Aluminum Insert_Positive (Screw on System)	B93
RCMT-VM	Turning Insert_Positive (Screw on System)	B74
RCMX	Turning Insert_Positive (Screw on System)	B74
RDC	Tooling System (Reducer Bar)	I 73
RDCT-MA	Milling Insert (Future Mill)	E15
RDHW	Milling Insert (Future Mill)	E15
RDKT-MF	Milling Insert (Future Mill)	E15
RDKT-ML	Milling Insert (Future Mill)	E16
RDKT-MM	Milling Insert (Future Mill)	E16
RDKW	Milling Insert (Future Mill)	E16
REKR-MM	Milling Insert (Double Mill)	E16
RI	Drill (Indexable Reamer Insert)	G113
RM16AC(M)6000	Rich Mill	E130
RM16AC(M)8000	Rich Mill	E131
RM3PC(M)3000	Rich Mill	E89
RM3PC(M)4000	Rich Mill	E90
RM3PC(M)5000	Rich Mill	E91
RM3PM3000	Rich Mill	E94
RM3PM4000	Rich Mill	E94
RM3PS3000	Rich Mill	E92
RM3PS4000	Rich Mill	E93
RM4PC(M)3000	Rich Mill	E95
RM4PC(M)4000	Rich Mill	E96
RM4PC(M)5000	Rich Mill	E97
RM4PC(M)6000	Rich Mill	E98
RM4PC(M)8000	Rich Mill	E101
RM4PC(M)9000	Rich Mill	E102
RM4PHCB3000	Rich Mill	E99
RM4PHCB4000	Rich Mill	E100

N Index by designation

R

RM4PHCP3000	Rich Mill	E103
RM4PHCP4000	Rich Mill	E104
RM4PM3000	Rich Mill	E107
RM4PS3000	Rich Mill	E105
RM4PS4000	Rich Mill	E106
RM4ZC(M)3000	Rich Mill	E108
RM4ZC(M)4000	Rich Mill	E108
RM4ZM3000	Rich Mill	E109
RM4ZS3000	Rich Mill	E109
RM6PC(M)-WN08	Rich Mill	E111
RM6PCM-WN04	Rich Mill	E110
RM6PM	Rich Mill	E114
RM6PS-WN04	Rich Mill	E112
RM6PS-WN08	Rich Mill	E113
RM8AC(M)4000	Rich Mill	E115
RM8AC(M)5000	Rich Mill	E117
RM8EC(M)4000	Rich Mill	E119
RM8EC(M)5000	Rich Mill	E121
RM8QC(M)4000	Rich Mill	E123
RMH8AC(M)4000	Rich Mill	E116
RMH8AC(M)5000	Rich Mill	E118
RMH8EC(M)4000	Rich Mill	E120
RMH8EC(M)5000	Rich Mill	E122
RMH8QC(M)4000	Rich Mill	E124
RMT8A(M)4000	Rich Mill	E125
RMT8A(M)5000	Rich Mill	E126
RMT8E(M)4000	Rich Mill	E127
RMT8E(M)5000	Rich Mill	E128
RMT8Q(M)4000	Rich Mill	E129
RNMG-B25	Turning Insert_Negative	B43
RPAE	R+ Endmill (Roughing endmill for wave form of Al)	F97
RPAE3000	R+ Endmill (Wave roughing)	F113
RPCT-MA	Milling Insert (Future Mill P-Positive)	E16
RPE-FF	R+ Endmill (Roughing endmill for fine pitches)	F100
RPE-FP	R+ Endmill (Roughing endmill for fine pitches)	F101
RPE-FP-H	R+ Endmill (Standard roughing endmill for fine pitches)	F97
RPE-FP-L	R+ Endmill (Roughing endmill for fine pitches)	F99
RPE-RG	R+ Endmill (4F roughing endmill)	F100
RPE-RG	R+ Endmill (Roughing endmill)	F102
RPE-RG	R+ Endmill (Standard roughing endmill)	F99
RPET-ML	Milling Insert (Future Mill P-Positive)	E16
RPE-XG	R+ Endmill (Endmill for finishing and roughing)	F98
RPGT	Multi functional Insert (Bearing Solution)	B143
RPLE-FP-H	R+ Endmill (Long type roughing endmill for fine pitches)	F98
RPMT-MF	Milling Insert (Future Mill P-Positive)	E16

R

RPMT-MM	Milling Insert (Future Mill P-Positive)	E16
RPMW	Milling Insert (Future Mill P-Positive)	E16
RT	Brazed Tools (Ring blank)	H07
RT	Tap Series (Roll Tap)	D67, 72

S

SAGE (Metric Buttress)	Thread Insert	D29
SBBR/L	Auto Tools Insert (Blade type)	B122
SBCR/L	Auto Tools Insert (Blade type)	B123
SBGR/L	Auto Tools Insert (Blade type)	B122
SBHR/L	Holder (Auto Tools_Blade type)	B122
SBHR/L-X	Holder (Auto Tools_Blade type)	B122
SBR/L	Auto Tools Insert (Multi functional type)	B125
SBTR/L	Auto Tools Insert (Blade type)	B122
SC	Tooling System (Others)	I 82
SCACR/L	Holder (Auto Tools_ISO type)	B113
SCACR/L	Holder (Screw on System)	B178
SCGT-AK	Aluminum Insert_Positive (Screw on System)	B94
SCGT-AR	Aluminum Insert_Positive (Screw on System)	B94
SCKN	Milling Insert (Mill Max Heavy)	E17
SCLCR/L	Boring Bar (Screw on System)	B204
SCLCR/L	Compact Mini	B214
SCLCR/L	Holder (Auto Tools_ISO type)	B113
SCLCR/L	Holder (Auto Tools_KHP)	B118
SCLCR/L	Holder (Screw on System)	B178
SCLPR/L	Boring Bar (Screw on System)	B205
SCMT	PCD Insert_Positive	B102
SCMT-C25	Turning Insert_Positive (Screw on System)	B75
SCMT-HMP	Turning Insert_Positive (Screw on System)	B75
SCMT-MP	Turning Insert_Positive (Screw on System)	B75
SCMT-VF	Turning Insert_Positive (Screw on System)	B74
SCMT-VL	Turning Insert_Positive (Screw on System)	B75
SCR/L	Auto Tools Insert (Multi functional type)	B125
SCRH	Drill (Chucking Reamer)	G117
SCRS	Drill (Chucking Reamer)	G117
SDACR/L	Holder (Screw on System)	B178
SDC	Tooling System (SDC series)	I 24~28
SDCN	Milling Insert (Mill-max, High feed Cutter)	E17
SDET-MA	Milling Insert (Future Mill)	E17
SDET-MF	Milling Insert (Future Mill)	E17
SDET-MM	Milling Insert (Future Mill)	E17
SDJCR/L	Holder (Auto Tools-ISO Type)	B113
SDJCR/L	Holder (Auto Tools-KHP)	B118
SDJCR/L	Holder (Screw on System)	B179



S

SDKN-CM	Milling Insert	E17
SDKN-MU	Milling Insert (Mill-Max)	E18
SDKN-SU	Milling Insert (Mill-Max, Turbo Mill)	E18
SDKR-MX	Milling Insert (Mill-Max, Turbo Mill)	E18
SDMT-MM	Milling Insert (Tank Mill, GBE)	E18
SDNCN	Holder (Auto Tools-ISO Type)	B114
SDNCN	Holder (Screw on System)	B179
SDQCR/L	Boring Bar (Screw on System)	B206
SDUCR/L	Boring Bar (Screw on System)	B207
SDXT-MA	Milling Insert (Future Mill)	E18
SDXT-MF	Milling Insert (Future Mill)	E18
SDXT-MM	Milling Insert (Future Mill)	E18
SDZCR/L	Boring Bar (Screw on System)	B208
SE	Cen-mill	M04
SECA	Milling Insert	E18
SECN	Milling Insert (Mill-Max)	E19
SEET-MA	Milling Insert (Future Mill)	E19
SEET-MF	Milling Insert (Future Mill)	E19
SEET-MM	Milling Insert (Future Mill)	E19
SEEW	Milling Insert (Future Mill)	E19
SEEW-W	Milling Insert (Future Mill)	E19
SEKN-SU	Milling Insert (Mill-Max)	E19
SEKR-MX	Milling Insert (Mill-Max)	E20
SEMN	Milling Insert	E20
SEXT-MF	Milling Insert (Future Mill)	E20
SEXT-MM	Milling Insert (Future Mill)	E20
SEXT-MR	Milling Insert (Future Mill)	E20
SFCN	Milling Insert (Mill-Max)	E20
SGBR/L	Auto Tools Insert (Multi functional type)	B126
SGR/L	Auto Tools Insert (Multi functional type)	B126
SK-FMC	Tooling System (Damping pro)	I 80
SL	Sleeve	B136
SLA	Tooling System (SLA series)	I 44~45
SMB	Tooling System (SMB)	I 67
SMBB	Multi functional(Saw Man_Block)	C60
SMBB	Multi functional(Saw Man-X_Block)	C64
SMH	Tooling System (SMH)	I 68
SNCF-MF	Milling Insert (Rich Mill)	E20
SNCF-MM	Milling Insert (Rich Mill)	E21
SNCN	Milling Insert (Mill Max)	E21
SNEF	Milling Insert (High feed Cutter)	E21
SNEU-MF	Milling Insert (Shave Mill)	E21
SNEU-TBW	Milling Insert (Shave Mill)	E22
SNEU-WMF	Milling Insert (Shave Mill)	E22
SNEW	Milling Insert (Aero Mill-Mini)	E22

S

SNEW-NAF	Milling Insert (Aero Mill-Mini)	E22
SNEW-XAF	Milling Insert (Aero Mill-Mini)	E22
SNEX	Milling Insert (Cube Mill)	E22
SNEX-CU1	Milling Insert (Cube Mill)	E22
SNEX-MA	Milling Insert (Rich Mill)	E22
SNEX-MF	Milling Insert (Rich Mill)	E23
SNEX-ML	Milling Insert (Rich Mill)	E22
SNEX-MM	Milling Insert (Rich Mill)	E23
SNEX-W	Milling Insert (Rich Mill)	E24
SNGA	Turning Insert_Negative (Multi Lock/Lever Lock System)	B44
SNGG	Turning Insert_Negative (Multi Lock/Lever Lock System)	B44
SNGG-VP3	Turning Insert_Negative (Multi Lock/Lever Lock System)	B44
SNGN	Turning Insert_Negative (Lever Lock System/Ceramic Holder)	B45
SNGX	Turning Insert_Negative (Multi Lock/Lever Lock System)	B45
SNHT-WX	Milling Insert (Wind Mill)	E23
SNKN	Milling Insert (Mill-Max)	E23
SNMA	cBN Insert_Negative(Regrinding)	B101
SNMA	Turning Insert_Negative (Multi Lock/Lever Lock System)	B45
SNMF-MF	Milling Insert (Rich Mill)	E20
SNMF-MM	Milling Insert (Rich Mill)	E21
SNMG-B25	Turning Insert_Negative (Multi Lock/Lever Lock System)	B49
SNMG-GR	Turning Insert_Negative (Multi Lock/Lever Lock System)	B49
SNMG-HA	Turning Insert_Negative (Multi Lock/Lever Lock System)	B46
SNMG-HM	Turning Insert_Negative	B47
SNMG-LP	Turning Insert_Negative (Multi Lock/Lever Lock System)	B46
SNMG-MK	Turning Insert_Negative (Multi Lock/Lever Lock System)	B47
SNMG-MM	Turning Insert (SAVE TURN)	B105
SNMG-MM	Turning Insert_Negative (Multi Lock/Lever Lock System)	B47
SNMG-MP	Turning Insert (SAVE TURN)	B105
SNMG-MP	Turning Insert_Negative (Multi Lock/Lever Lock System)	B48
SNMG-RK	Turning Insert_Negative (Multi Lock/Lever Lock System)	B49
SNMG-RM	Turning Insert_Negative (Multi Lock/Lever Lock System)	B50
SNMG-VB	Turning Insert_Negative (Multi Lock/Lever Lock System)	B46
SNMG-VC	Turning Insert_Negative (Multi Lock/Lever Lock System)	B46
SNMG-VF	Turning Insert_Negative (Multi Lock/Lever Lock System)	B46
SNMG-VL	Turning Insert_Negative (Multi Lock/Lever Lock System)	B46
SNMG-VM	Turning Insert_Negative (Multi Lock/Lever Lock System)	B48
SNMG-VP2	Turning Insert_Negative (Multi Lock/Lever Lock System)	B46
SNMG-VP3	Turning Insert_Negative (Multi Lock/Lever Lock System)	B48
SNMG-VP4	Turning Insert_Negative (Multi Lock/Lever Lock System)	B50
SNMG-VQ	Turning Insert (SAVE TURN)	B105
SNMG-VQ	Turning Insert_Negative (Multi Lock/Lever Lock System)	B47
SNMG-VR	Turning Insert_Negative (Multi Lock/Lever Lock System)	B50
SNMM-GH	Turning Insert_Negative (Multi Lock/Lever Lock System)	B51
SNMM-GR	Turning Insert_Negative (Multi Lock/Lever Lock System)	B50

N Index by designation

S

SNMM-VH	Turning Insert_Negative (Lever Lock System)	B51
SNMM-VT	Turning Insert_Negative (Lever Lock System)	B51
SNMN	Turning Insert_Negative (Ceramic Holder)	B52
SNMX	Turning Insert_Negative (Multi Lock/Lever Lock System)	B52
SNMX-MF	Milling Insert (Rich Mill)	E23
SNMX-MM	Milling Insert (Rich Mill)	E23
SNUN	Turning Insert_Negative (Ceramic Holder)	B52
SP	Multi functional Insert (Bearing Solution)	B146
SP	Multi functional Insert (Saw Man)	C59
SP	Tap series (Spiral Tap)	D66, 71
SPB	Multi functional (Saw Man_Blades)	C60
SPB(M)	Side cutter	E380
SPB-S	Multi functional (Bearing Solution)	B146
SPB-S	Multi functional (Saw Man_Blades)	C60
SPCN	Milling Insert (Mill-Max)	E24
SPD	SPD	M04
SPEN-WC	Milling Insert (High feed Cutter)	E24
SPET-ND	Drill Insert	G04
SPEX	Milling Insert (Mill-Max)	E24
SPFE4000	S+ Endmill (Flat type)	F91
SPFN	Milling Insert(Side cutter)	E25
SPGA	Turning Insert_Positive	B76
SPGH	Multi functional (Bearing Solution)	B143
SPGN	PCD Insert_Positive	B76
SPGN	Turning Insert_Positive	B103
SPGR	Multi functional (Bearing Solution)	B143
SPGR-F	Turning Insert_Positive (Clamp on System)	B76
SPGR-M	Turning Insert_Positive (Clamp on System)	B77
SPGT	Turning Insert_Positive (Screw on System)	B77
SPGW	PCD Insert_Positive	B102
SPH	Multi functional (Saw Man_Holder)	C61
SPH-S	Multi functional (Saw Man_Holder)	C61
SPKN-MU	Milling Insert (Mill-Max)	E25
SPKN-SU	Milling Insert (Mill-Max)	E25
SPKR-MX	Milling Insert (Mill-Max)	E25
SPLFE4000	S+ Endmill (Long flat type)	F91
SPMN	Milling Insert (Chamfer tools)	E25
SPMR-F	Turning Insert_Positive (Clamp on System)	B77
SPMR-M	Turning Insert_Positive (Clamp on System)	B77
SPMT	Milling Insert (Tank Mill, GBE, BT Tooling System)	E25
SPMT-KC	Milling Insert (Chamfer tools)	E25
SPMT-LD	Drill Insert	G04
SPMT-MM	Milling Insert (Tank Mill, GBE)	E25
SPMT-PD	Drill Insert (KING DRILL)	G04
SPMT-VF	Turning Insert_Positive (Clamp on System)	B77

S

SPMT-VL	Turning Insert_Positive	B77
SPP(M)	Side cutter	E379
SPS	Side cutter	E381
SPUN	Turning Insert_Positive	B77
SR	Brazed Tools (Round bars blank)	H07
SR	Tap series (Spiral Roll Tap)	D68, 73
SRCPR/L...B	Bearing Solution	B142
SRDCN	Holder (Screw on System)	B179
SRES4000	Super Endmill (Radius type)	F46~50
SRGCR	Holder (KHP)	B190
SRGCR/L	Holder (Screw on System)	B180
SRGPR/L...E	Bearing Solution	B142
SRGPR/L...F	Bearing Solution	B142
SSBCR/L	Holder (Screw on System)	B180
SSBEA2000	Solid Endmills for Aluminum (Ball type)	F39
SSDCN	Holder (Screw on System)	B180
SSDP	Carbide Drill (SSDP)	G99~100
SSEA2000	Solid Endmills for Aluminum (Flat type)	F38
SSEA3000	Solid Endmills for Aluminum (Flat type)	F38
SSKCR/L	Boring Bar (Screw on System)	B208
SSKCR/L	Cartridge (Screw on System)	B234
SSKCR/L	Holder (Screw on System)	B181
SSKPR/L	Boring Bar (Screw on System)	B208
SSKPR/L...B	Bearing Solution	B143
SSSCR/L	Cartridge (Screw on System)	B234
SSSCR/L	Holder (Screw on System)	B181
ST	Brazed Tools (Helix blank)	H08
ST	Tap series (Straight Tap)	D65, 69
STACR/L	Holder (Auto Tools-ISO Type)	B114
STACR/L	Holder (Screw on System)	B181
STFCR/L	Boring Bar (Screw on System)	B209
STFCR/L	Cartridge (Screw on System)	B234
STFCR/L	Holder (Screw on System)	B182
STFPR/L	Boring Bar (Screw on System)	B210
STGCR/L	Holder (Screw on System)	B182
STLBR/L	Compact Mini	B214
STMD2L	Solid Threading Endmills (ISO Metric / UN)	D59~60
STMD3T	Solid Threading Endmills (ISO Metric / UN)	D57~58
STMHC	Solid Threading Endmills (ISO Metric)	D51~54
STMHCC	Solid Threading Endmills (ISO Metric)	D55
STMHCD	Solid Threading Endmills (ISO Metric)	D56
STMHCR	Solid Threading Endmills (ISO Metric)	D55
STR/L	Auto Tools Insert (FGT type)	B126
STTCR/L	Cartridge (Screw on System)	B235
STTCR/L	Holder (Screw on System)	B182



S

STUBR/L	Compact Mini	B214
STUPR/L	Compact Mini	B215
STWCR/L	Cartridge (Screw on System)	B235
STWPR/L	Boring Bar (Screw on System)	B211
SVABR/L	Holder (Screw on System)	B183
SVACR/L	Holder (Auto Tools-ISO Type)	B114
SVAPR/L	Holder (Auto Tools-ISO Type)	B115
SVHBR/L	Holder (Screw on System)	B183
SVJBR	Holder (KHP)	B190
SVJBR/L	Holder (Auto Tools-ISO Type)	B115
SVJBR/L	Holder (Screw on System)	B183
SVJCR/L	Boring Bar (Screw on System)	B211
SVJCR/L	Holder (Auto Tools-ISO Type)	B115
SVJCR/L	Holder (Auto Tools-KHP)	B118
SVJCR/L	Holder (Screw on System)	B184
SVJPR/L	Holder (Auto Tools-ISO Type)	B116
SVM4000	Shave Mill	E397
SVMM4000	Shave Mill	E397
SVPBR/L	HSK Tooling System	B222
SVQBR/L	Boring Bar (Screw on System)	B211
SVQCR/L	Boring Bar (Screw on System)	B212
SVUBR/L	Boring Bar (Screw on System)	B212
SVUCR/L	Boring Bar (Screw on System)	B212
SVUM6000	Shave Mill Ultra	E398
SVUM6000-B	Shave Mill Ultra	E399
SVVBN	Holder (Screw on System)	B184
SVVBN	HSK Tooling System	B222
SVVCN	Holder (Screw on System)	B184
SVVPN	Holder (Auto Tools-ISO Type)	B116
SWLCR/L	Boring Bar (Screw on System)	B213
SWUBR/L	Compact Mini	B216
SXGNR/L	Holder (Auto Tools-FGT Type)	B125

T

TAFCB	Side Milling Cutter (Tangential type-Full side cutter)	E375
TAFCP	Side Milling Cutter (Tangential type-Full side cutter)	E375
TAHCB	Side Milling Cutter (Tangential type-Half side cutter)	E376
TAHCP	Side Milling Cutter (Tangential type-Half side cutter)	E376
TB	Brazed Tools (Taper bits)	H13
TB	Multi functional Insert (Grooving Tools)	C49~52
TBC	Tooling System (TBC)	I 63
TBGT	Turning Insert_Positive (Compact Mini)	B78
TBGW	PCD Insert_Positive	B103
TBH	Multi functional (Grooving Tools)	C53

T

TB-M	Multi functional Insert (Grooving Tools)	C49~52
TBMT-VL	Turning Insert_Positive (Screw on System)	B78
TC	Tooling System	I 21
TCA	TCA (Tap adaptor)	I 42
TCGT-AK	Aluminum Insert_Positive (Screw on System)	B95
TCGT-AR	Aluminum Insert_Positive (Screw on System)	B95
TCGT-KF	Turning Insert_Positive (Screw on System)	B79
TCGT-VP1	Turning Insert_Positive (Screw on System)	B79
TCMT	PCD Insert_Positive	B103
TCMT-C25	Turning Insert_Positive (Screw on System)	B80
TCMT-HMP	Turning Insert_Positive (Screw on System)	B79
TCMT-MP	Turning Insert_Positive (Screw on System)	B80
TCMT-VF	Turning Insert_Positive (Screw on System)	B79
TCMT-VL	Turning Insert_Positive (Screw on System)	B79
TCMT-VP1	Turning Insert_Positive (Screw on System)	B79
T-CNMA	cBN Insert_Negative(Regrinding)	B101
TCRS	Drill (Chucking Reamer)	G118
T-DCGW	cBN Insert_Positive(Regrinding)	B101
TEC(E)N	Milling Insert (Turbo Mill)	E26
TEEN	Milling Insert (Turbo Mill)	E26
TER	TER (Tap Collet)	I 43
TFCN	Milling Insert (Mill-Max)	E26
TFE	T-Cutter	E343
THE	Tank Mill	E299
TM	Cen-mill	M04
TM	Thread Milling Inserts (ISO Metric)	D44~49
TMRS	Drill (Machine Reamer)	G118
TNGA	Turning Insert_Negative (Lever Lock/Wedge Clamp/Multi Lock System)	B53
TNGG	Turning Insert_Negative (Lever Lock/Wedge Clamp/Multi Lock System)	B53
TNGG-SC	Turning Insert_Negative (Lever Lock/Wedge Clamp/Multi Lock System)	B53
TNGG-VP3	Turning Insert_Negative (Lever Lock/Wedge Clamp/Multi Lock System)	B53
TNGN	Turning Insert_Negative (Ceramic Holder)	B54
TNMA	cBN Insert_Negative(Regrinding)	B101
TNMA	Turning Insert_Negative (Lever Lock/Wedge Clamp/Multi Lock System)	B54
TNMG-B25	Turning Insert_Negative (Lever Lock/Wedge Clamp/Multi Lock System)	B57
TNMG-GR	Turning Insert_Negative (Lever Lock/Wedge Clamp/Multi Lock System)	B58
TNMG-HA	Turning Insert_Negative (Lever Lock/Wedge Clamp/Multi Lock System)	B55
TNMG-HM	Turning Insert_Negative	B56
TNMG-LP	Turning Insert_Negative (Lever Lock/Wedge Clamp/Multi Lock System)	B55
TNMG-LW	Turning Insert_Negative (Lever Lock/Wedge Clamp/Multi Lock System)	B57
TNMG-MK	Turning Insert_Negative (Lever Lock/Wedge Clamp/Multi Lock System)	B56
TNMG-MM	Turning Insert_Negative (Lever Lock/Wedge Clamp/Multi Lock System)	B56
TNMG-MP	Turning Insert_Negative (Lever Lock/Wedge Clamp/Multi Lock System)	B56
TNMG-RK	Turning Insert_Negative (Lever Lock/Wedge Clamp/Multi Lock System)	B58
TNMG-RM	Turning Insert_Negative (Lever Lock/Wedge Clamp/Multi Lock System)	B58



N Index by designation

T

TNMG-VB	Turning Insert_Negative (Lever Lock/Wedge Clamp/Multi Lock System)	B54
TNMG-VC	Turning Insert_Negative (Lever Lock/Wedge Clamp/Multi Lock System)	B55
TNMG-VF	Turning Insert_Negative (Lever Lock/Wedge Clamp/Multi Lock System)	B55
TNMG-VL	Turning Insert_Negative (Lever Lock/Wedge Clamp/Multi Lock System)	B55
TNMG-VM	Turning Insert_Negative (Lever Lock/Wedge Clamp/Multi Lock System)	B57
TNMG-VP2	Turning Insert_Negative (Lever Lock/Wedge Clamp/Multi Lock System)	B55
TNMG-VP3	Turning Insert_Negative (Lever Lock/Wedge Clamp/Multi Lock System)	B57
TNMG-VP4	Turning Insert_Negative (Lever Lock/Wedge Clamp/Multi Lock System)	B58
TNMG-VQ	Turning Insert_Negative (Lever Lock/Wedge Clamp/Multi Lock System)	B56
TNMG-VR	Turning Insert_Negative (Lever Lock/Wedge Clamp/Multi Lock System)	B58
TNMG-VW	Turning Insert_Negative (Lever Lock/Wedge Clamp/Multi Lock System)	B55
TNMM-GH	Turning Insert_Negative (Lever Lock/Wedge Clamp/Multi Lock System)	B59
TNMM-GR	Turning Insert_Negative (Lever Lock/Wedge Clamp/Multi Lock System)	B59
TNMN	Turning Insert_Negative (Ceramic Holder)	B59
TNMX	Milling Insert (Power Buster)	E26
TNMX	PCD Insert_Negative	B102
TNMX	Turning Insert_Negative (Lever Lock/Wedge Clamp/Multi Lock System)	B59
TNMX-SH	Turning Insert_Negative (Lever Lock/Wedge Clamp/Multi Lock System)	B59
TNMX-SR	Turning Insert_Negative	B59
TOEH	Turning Insert_Positive	B80
TP2PCM-LN08	TP2P	E303
TP2PCM-LN14	TP2P	E304
TP2PCM-LN17	TP2P	E305
TP2PS-LN08	TP2P	E306
TP2PS-LN14	TP2P	E307
TP2PS-LN17	TP2P	E308
TPCN	Milling Insert (Mill-max, Side cutter)	E26
TPD	Drill Insert (TPDB Plus)	G38
TPD	Drill Insert (TPDB-H)	G47
TPD	Drill Insert (TPDC)	G31
TPDB(10D)	Drill (TPDB Plus)	G42
TPDB(12D)	Drill (TPDB Plus)	G43
TPDB(3D)	Drill (TPDB-H)	G48
TPDB(4D)	Drill (TPDB-H)	G49
TPDB(5D)	Drill (TPDB Plus)	G40
TPDB(8D)	Drill (TPDB Plus)	G41
TPDB(8D)	Drill (TPDB-H)	G50
TPDBP(3D)	Drill (TPDB Plus)	G39
TPDC(10D)	Drill (TPDC)	G33
TPDC(12D)	Drill (TPDC)	G33
TPDC(3D)	Drill (TPDC)	G32
TPDC(5D)	Drill (TPDC)	G32
TPDC(8D)	Drill (TPDC)	G32~33
TPGB	cBN Insert_Positive (Regrinding)	B101
TPGB	PCD Insert_Positive	B103

T

TPGH	Turning Insert_Positive	B81
TPGN	PCD Insert_Positive	B103
TPGN	Turning Insert_Positive	B81
TPGR-F	Turning Insert_Positive (Clamp on System)	B81
TPGR-M	Turning Insert_Positive (Clamp on System)	B81
TPGT	PCD Insert_Positive	B103
TPGT	Turning Insert_Positive (Screw on System)	B82
TPGW	PCD Insert_Positive	B103
TPGX	PCD Insert_Positive	B82
TPKN-MU	Milling Insert (Mill-Max)	E27
TPKN-SU	Milling Insert (Mill-Max)	E27
TPKR-MX	Milling Insert (Mill-Max)	E27
TPMR-F	Turning Insert_Positive (Clamp on System)	B82
TPMR-M	Turning Insert_Positive (Clamp on System)	B82
TPMT-MP	Turning Insert_Positive (Screw on System)	B83
TPMT-VF	Turning Insert_Positive (Screw on System)	B83
TPMT-VL	Turning Insert_Positive (Screw on System)	B83
TPUN	Turning Insert_Positive	B83
TSDM	Top Solid drill	G102
T-VNMA	cBN Insert_Negative (Regrinding)	B101
TWX-KC	Milling Insert (Multi functional Chamfer Tool)	E27

U

UNJ (Unified Constant Thread) Thread Insert	D26
--	------------

V

VBGT	Aluminum Insert_Positive (Screw on System)	B84
VBGT-AK	Aluminum Insert_Positive (Screw on System)	B96
VBGT-AR	Turning Insert_Positive (Screw on System)	B96
VBGT-KF	Turning Insert_Positive (Screw on System)	B84
VBGT-KM	Turning Insert_Positive (Screw on System)	B84
VBGT-VP1	Turning Insert_Positive (Screw on System)	B84
VBMT	PCD Insert_Positive	B103
VBMT	Turning Insert_Positive (Screw on System)	B85
VBMT-HMP	Turning Insert_Positive (Screw on System)	B85
VBMT-MP	Turning Insert_Positive (Screw on System)	B85
VBMT-VB	Turning Insert_Positive (Screw on System)	B84
VBMT-VF	Turning Insert_Positive (Screw on System)	B84
VBMT-VL	Turning Insert_Positive (Screw on System)	B85
VBMT-VP1	Turning Insert_Positive (Screw on System)	B85
VBMW	cBN Insert_Positive (Regrinding)	B101
VCET-KF	Auto Tools Insert (ISO type)	B86, 120
VCET-KM	Auto Tools Insert (ISO type)	B86, 120



V

VCGT-AK	Aluminum Insert_Positive (Screw on System)	B97
VCGT-AR	Aluminum Insert_Positive (Screw on System)	B97
VCGT-KF	Turning Insert_Positive (Screw on System)	B86
VCGT-KM	Turning Insert_Positive (Screw on System)	B86
VCGT-MS	Auto Tools Insert (ISO type)	B120
VCGT-VP1	Auto Tools Insert (ISO type)	B86, 120
VCGX-VP1	Auto Tools Insert (ISO type)	B87, 120
VCKT-MA	Milling Insert (Pro-A Mill)	E27
VCMT	PCD Insert_Positive	B103
VCMT-HMP	Turning Insert_Positive (Screw on System)	B87
VCMT-MP	Turning Insert_Positive (Screw on System)	B87
VCMT-VF	Turning Insert_Positive (Screw on System)	B87
VCMT-VL	Turning Insert_Positive (Screw on System)	B87
VCMT-VP1	Turning Insert_Positive (Screw on System)	B87
VDKT-MA	Milling Insert (Pro-A Mill)	E27
VETR	Thread Insert (Vertical Type)	D33
VFE4000	V-Endmill (Flat type)	F16
VNGG-HA	Turning Insert_Negative (Multi Lock System)	B60
VNGG-VP3	Turning Insert_Negative (Multi Lock System)	B60
VNMA	cBN Insert_Negative (Regrinding)	B101
VNMG-HA	Turning Insert_Negative (Multi Lock System)	B60
VNMG-HM	Turning Insert_Negative	B61
VNMG-LP	Turning Insert_Negative (Multi Lock System)	B60
VNMG-MK	Turning Insert_Negative (Multi Lock System)	B61
VNMG-MM	Turning Insert_Negative (Multi Lock System)	B61
VNMG-MP	Turning Insert_Negative (Multi Lock System)	B61
VNMG-RM	Turning Insert_Negative (Multi Lock System)	B61
VNMG-VB	Turning Insert_Negative (Multi Lock System)	B60
VNMG-VC	Turning Insert_Negative (Multi Lock System)	B60
VNMG-VF	Turning Insert_Negative (Multi Lock System)	B60
VNMG-VL	Turning Insert_Negative (Multi Lock System)	B60
VNMG-VM	Turning Insert_Negative (Multi Lock System)	B61
VNMG-VP3	Turning Insert_Negative (Multi Lock System)	B61
VNMG-VQ	Turning Insert_Negative (Multi Lock System)	B61
VNMX	PCD Insert_Negative	B102
VPET-KF	Auto Tools Insert (ISO type)	B88, 120
VPET-KM	Auto Tools Insert (ISO type)	B88, 120
VPGT-VP1	Auto Tools Insert (ISO type)	B88, 120
VPGT-VP1	Turning Insert_Positive (Screw on System)	B88
VTH	Vertical Type Holder	D33
VZD-LA, LBA	Vulcan Drill	G90
VZD-MA, MBA	Vulcan Drill	G89

W

WBG	Turning Insert_Positive (Compact Mini)	B89
WCMT-C20N	Drill Insert (WPDC)	G04
WCMT-C21N	Drill Insert (WPDC)	G05
WDKT-MH	Milling Insert (HRM)	E27
WFSB(M)	Wind Mill (Boss type)	E384
WFSP(M)	Wind Mill (Plane type)	E385
WNGG-VP3	Turning Insert_Negative (Lever Lock/Wedge Clamp/Multi Lock System)	B62
WNGX-MA	Milling Insert (RM6)	E28
WNGX-ML	Milling Insert (RM6)	E28
WNGX-MM	Milling Insert (RM6)	E28
WNMA	Turning Insert_Negative (Lever Lock/Wedge Clamp/Multi Lock System)	B62
WNMG-B25	Turning Insert_Negative (Lever Lock/Wedge Clamp/Multi Lock System)	B64
WNMG-GR	Turning Insert_Negative (Lever Lock/Wedge Clamp/Multi Lock System)	B64
WNMG-HA	Turning Insert_Negative (Lever Lock/Wedge Clamp/Multi Lock System)	B62
WNMG-HM	Turning Insert_Negative	B63
WNMG-LP	Turning Insert_Negative (Lever Lock/Wedge Clamp/Multi Lock System)	B63
WNMG-LW	Turning Insert_Negative (Lever Lock/Wedge Clamp/Multi Lock System)	B64
WNMG-MK	Turning Insert_Negative (Lever Lock/Wedge Clamp/Multi Lock System)	B63
WNMG-MM	Turning Insert (SAVE TURN)	B105
WNMG-MM	Turning Insert_Negative (Lever Lock/Wedge Clamp/Multi Lock System)	B63
WNMG-MP	Turning Insert (SAVE TURN)	B105
WNMG-MP	Turning Insert_Negative (Lever Lock/Wedge Clamp/Multi Lock System)	B64
WNMG-RK	Turning Insert_Negative (Lever Lock/Wedge Clamp/Multi Lock System)	B65
WNMG-RM	Turning Insert_Negative (Lever Lock/Wedge Clamp/Multi Lock System)	B65
WNMG-VB	Turning Insert_Negative (Lever Lock/Wedge Clamp/Multi Lock System)	B62
WNMG-VC	Turning Insert_Negative (Lever Lock/Wedge Clamp/Multi Lock System)	B63
WNMG-VF	Turning Insert_Negative (Lever Lock/Wedge Clamp/Multi Lock System)	B62
WNMG-VL	Turning Insert_Negative (Lever Lock/Wedge Clamp/Multi Lock System)	B62
WNMG-VM	Turning Insert_Negative (Lever Lock/Wedge Clamp/Multi Lock System)	B64
WNMG-VP2	Turning Insert_Negative (Lever Lock/Wedge Clamp/Multi Lock System)	B63
WNMG-VP3	Turning Insert_Negative (Lever Lock/Wedge Clamp/Multi Lock System)	B64
WNMG-VP4	Turning Insert_Negative (Lever Lock/Wedge Clamp/Multi Lock System)	B65
WNMG-VQ	Turning Insert (SAVE TURN)	B105
WNMG-VQ	Turning Insert_Negative (Lever Lock/Wedge Clamp/Multi Lock System)	B63
WNMG-VR	Turning Insert_Negative (Lever Lock/Wedge Clamp/Multi Lock System)	B65
WNMG-VW	Turning Insert_Negative (Lever Lock/Wedge Clamp/Multi Lock System)	B62
WNMM-B25	Turning Insert_Negative (Lever Lock/Wedge Clamp/Multi Lock System)	B65
WNMX-MF	Milling Insert (HRMDouble)	E28
WNMX-ML	Milling Insert (HRMDouble)	E28
WNMX-MM	Milling Insert (HRMDouble)	E28
WNMX-SH	Turning Insert_Negative (Lever Lock/Wedge Clamp/Multi Lock System)	B65
WNMX-SR	Turning Insert_Negative	B65
WPDC-5D	Drill (WPDC Dual insert cartridge)	G56
WPDC-5D	Drill (WPDC Single insert cartridge)	G56
WPDC-5D	Drill (WPDC Standard type)	G55

N Index by designation

W

WPDC-6.5D	Drill (WPDC Dual insert cartridge)	G56
WPDC-6.5D	Drill (WPDC Single insert cartridge)	G56
WPDC-6.5D	Drill (WPDC Standard type)	G55
WPDC-8D	Drill (WPDC Dual insert cartridge)	G56
WPDC-8D	Drill (WPDC Single insert cartridge)	G56
WPDC-8D	Drill (WPDC Standard type)	G55
WS	Side cutter	E381
WTENN	Holder (Wedge Clamp System)	B167
WTJNR/L	Holder (Wedge Clamp System)	B167
WTXNR/L	Holder (Wedge Clamp System)	B167
WWLNR/L	Holder (Wedge Clamp System)	B168

X

XCET-KC	Milling Insert (Chamfer Tool)	E29
XDET-MA	Milling Insert (Pro-V Mill)	E29
XEKT-MA	Milling Insert (Pro-X Mill)	E29
XEKT-ML	Milling Insert (Pro-X Mill)	E29
XNCT-MA	Milling Insert (Rich Mill)	E29
XNKT-ML	Milling Insert (Rich Mill)	E30
XNKT-MM	Milling Insert (Rich Mill)	E30
XOET-ND	Drill Insert	G05
XOMT-LD	Drill Insert	G05
XOMT-PD	Drill Insert	G05
XOMT-RD	Drill Insert	G05
XPMT-MM	Milling Insert (HAVE)	E30

Z

ZBE2000	Z Endmill (Ball type)	F23
ZDMT-R-MM	Milling Insert (BRE)	E30
ZFE2000	Z Endmill (Flat type)	F20
ZFE4000	Z Endmill (Flat type)	F21
ZPBE2000	Z+ Endmill (Ball type)	F83
ZPBE4000	Z+ Endmill (Ball type)	F84
ZPET-MM	Milling Insert (GBE)	E31
ZPFE2000	Z+ Endmill (Flat type)	F75
ZPFE3000	Z+ Endmill (Flat type)	F82
ZPFE4000	Z+ Endmill (Flat type)	F78
ZPFE6000	Z+ Endmill (Flat type)	F82
ZPLBE2000	Z+ Endmill (Long Ball type)	F84
ZPLFE2000	Z+ Endmill (Long Flat type)	F76
ZPLFE2000	Z+ Endmill (Long Flute type)	F77
ZPLFE4000	Z+ Endmill (Long Flat type)	F80
ZPLFE4000	Z+ Endmill (Long Flute type)	F81

Z

ZPLRE2000	Z+ Endmill (Long Radius type)	F86
ZPLRE4000	Z+ Endmill (Long Radius type)	F88
ZPMT-MM	Milling Insert (BT Tooling System, Tank Mill)	E31
ZPMT-R-MM	Milling Insert (BRE)	E31
ZPMT-R-MR	Milling Insert (BRE)	E31
ZPRE2000	Z+ Endmill (Radius type)	F85
ZPRE4000	Z+ Endmill (Radius type)	F87
ZPSFE2000	Z+ Endmill (Short Flat type)	F76
ZPSFE4000	Z+ Endmill (Short Flat type)	F79
ZSBE200	Brazed Endmill (Ball type)	F122
ZSE200	Brazed Endmill (Flat type)	F118
ZSE300	Brazed Endmill (Flat type)	F118
ZSE400	Brazed Endmill (Flat type)	F119
ZSE600	Brazed Endmill (Flat type)	F119
ZSEA200	Brazed Endmill (Flat type)	F120
ZSEL200	Brazed Endmill (Long flat type)	F121
ZSEL400	Brazed Endmill (Long flat type)	F121
ZSEXL200	Brazed Endmill (Long flat type)	F121
ZSFE2000	Z Endmill (Short Flat type)	F22
ZSFE4000	Z Endmill (Short Flat type)	F22



KORLOY Global Network

We stand to be the Global Top Manufacturer. Korea's Best. World's Best

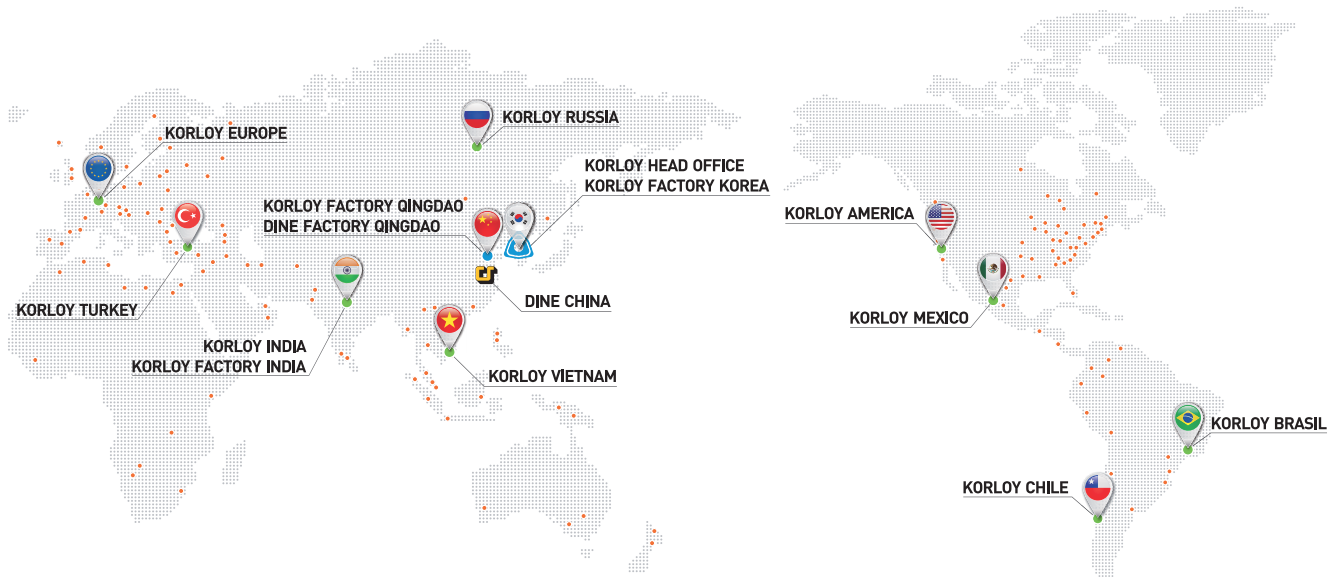

KORLOY

Head Office

Holystar B/D, 1350, Nambusunhwan-ro, Geumcheon-gu, Seoul, 08536, Korea

Tel : +82-2-522-3181 Fax : +82-2-522-3184, +82-2-3474-4744

R&D Institute Cheongju

55, Sandan-ro, Heungdeok-gu, Cheongju-si, Chungcheongbuk-do, 28589, Korea

Tel : +82-43-262-0141 Fax : +82-43-262-0711

Cheongju Factory

55, Sandan-ro, Heungdeok-gu, Cheongju-si, Chungcheongbuk-do, 28589, Korea

Tel : +82-43-262-0141 Fax : +82-43-263-8731

Jincheon Factory

54, Gwanghyewonsandan 2-gil, Gwanghyewon-myeon, Jincheon-gun, Chungcheongbuk-do, 27807, Korea

Tel : +82-43-535-0141 Fax : +82-43-535-0144

KORLOY AMERICA

620 Maple Avenue, Torrance, CA 90503, USA

Tel : +1-310-782-3800 Toll Free : +1-888-711-0001 Fax : +1-310-782-3885

E-mail : sales.kai@korloy.com

KORLOY EUROPE

Gablonzer Str. 25-27, 61440 Oberursel, Germany

Tel : +49-6171-277-83-0 Fax : +49-6171-277-83-59

E-mail : sales.keg@korloy.com

KORLOY INDIA

Plot No. 415, Sector 8, IMT Manesar, Gurgaon 122051, Haryana, India

Tel : +91-124-4391790 Fax : +91-124-4050032

E-mail : sales.kip@korloy.com

KORLOY BRASIL

Av. Aruana 280, conj.12, WLC, Alphaville, Barueri,

CEP06460-010, SP, Brasil

Tel : +55-11-4193-3810 E-mail : sales.kbl@korloy.com

KORLOY TURKEY

Orucreis Mah. Vadi Cad. No: 108 Istanbul Ticaret Sarayi

Kat 5 No: 318 Giyimkent Sitesi-Esenler/Istanbul, Turkey

Tel : +90-212-438-5197 E-mail : sales.ktl@korloy.com

KORLOY CHILE

Av. Providencia 1650, Office 1009, 7500027

Providencia-Santiago, Chile

Tel : +56-229-295-490 E-mail : sales.kcs@korloy.com

KORLOY RUSSIA

KRASIVY DOM office No. 305, Bld. 5, Novovladykinskiy proezd 8,

127106, Moscow, Russia

E-mail : sales.krc@korloy.com

KORLOY MEXICO

Queretaro, Mexico

E-mail : sales.kml@korloy.com

KORLOY FACTORY QINGDAO

Ground Dongjing Road 56(B) District Free Trade Zone. Qingdao, China

Tel : +86-532-86959880 Fax : +86-532-86760651

E-mail : pro.kfq@korloy.com

KORLOY FACTORY INDIA

Plot No. 415, Sector 8, IMT Manesar, Gurgaon 122051, Haryana, India

Tel : +91-124-4391790 Fax : +91-124-4050032

E-mail : pro.kim@korloy.com

www.korloy.com



CA-EM-01 / 20200401